

Canon

EOS IX7

IX Lite

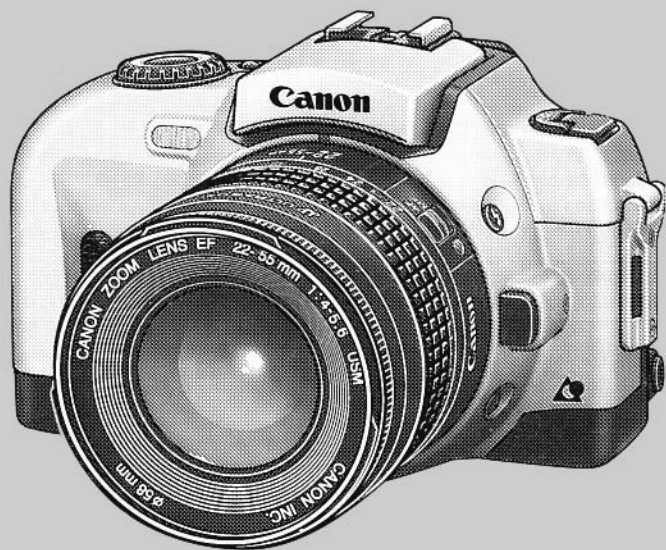

E

English Edition
Instructions

Thank You For Purchasing This Canon Product.

The EOS IX 7/EOS IX Lite is a single-lens reflex camera designed for use with the Advanced Photo System.

This highly compact camera offers a wide range of functions for all uses, from simple fully-automatic shooting to advanced photography.

Before you use your camera, be sure to read these instructions with your camera handy. This will help you better understand and learn how to use its many functions.

Symbols Used in This Manual



This indicates precautions that can help you avoid problems in shooting.



This indicates helpful information you should remember when you use your camera.



This indicates hints that will help you use your camera and shoot pictures more effectively.

The notation (→ ■) refers to additional pages that contain material related to the subject you are reading about.

To prevent mistakes or problems, be sure to read the sections titled "Handling Precautions" on pages 8 and 9.

The instructions in this manual assume that you are using your camera with the EF 22–55mm f/4–5.6 USM lens.

Be sure to keep this manual in a convenient place so you can refer to it easily.

■ Before You Use Your Camera

- Be sure to take some test shots before you go on that important overseas trip or honeymoon, so that you will know your camera is working properly.
- The EOS-series cameras and EF lenses use an exclusive electronic lens mount that lets them adjust the focus and exposure settings automatically. Using lenses made by other manufacturers can cause either the camera or lens to operate improperly.

Also, please note that Canon cannot assume responsibility for failure or other results of using EOS cameras with other manufacturers' products.

Features of the Advanced Photo System

New Film

The new IX240 cartridge film is contained in a compact cartridge with no film leader. This does away with the usual troublesome process of loading/removing film, and instead provides easy drop-in loading that anyone can handle. You no longer need to open the back of the camera, pull out the film leader, and align it with a mark on the camera before winding, as with 135 (35mm) film.

The cartridge has a data disk that records information about the film type, number of shots, and film sensitivity that the camera reads automatically. The cartridge also includes a visual exposure indicator that shows you whether the cartridge is unexposed, partially exposed, exposed, or processed.

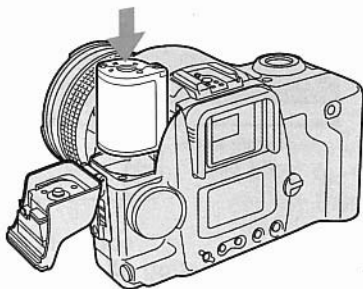

Midroll Film Change

If you put a partially exposed roll of film in your camera, the camera automatically advances it to the first unexposed frame so you can start shooting from there.

- Some cameras do not have this feature, and so will read a partially exposed roll as exposed. Make sure other cameras include this feature before transferring partially exposed rolls of film to them.

Visual exposure indicators



- | | |
|---|-----------|
| ○ | Unexposed |
| D | Partial |
| ⊗ | Exposed |
| □ | Processed |

New Camera Size

The Advanced Photo System makes it possible to reduce the overall size of the cartridge as well as the camera body (in comparison to other Canon models). Your camera's particularly compact size is made possible by Canon's down-sizing technology.

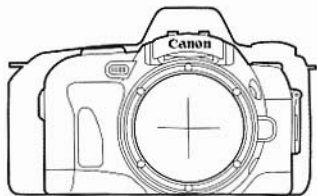

New Film Information (IX: Information Exchange)

Advanced Photo System film contains a magnetic data recording area that records a variety of information about each frame (IX information recording). IX information includes date, time, title, print type, film orientation, flash on/off setting, subject brightness, exposure data, and more. The developers at the photo lab use the IX information to tell what type of print to use, how to improve print quality, and what information to display on the print itself.

- You can select whether to print the date and time on the front and back of the print, or on the back only.
- The type of IX information recorded depends on the particular camera model.
- The size, style, color, and position of printed characters, as well as front/back date printing capabilities, depend on the specific photo lab.

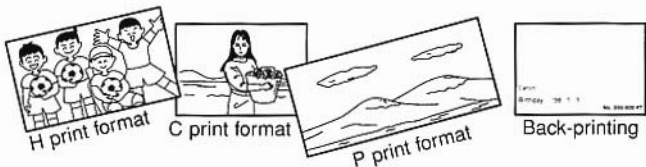

New Print Formats

Three print formats are available: C (Classic, the same print aspect ratio as 135 print format), H (HDTV or wide-angle) format, and P (Panoramic). The print format can be changed at anytime.

C format

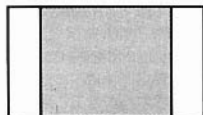

Print aspect ratio
2:3

H format

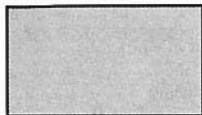

Print aspect ratio
9:16

P format

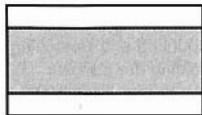

Print aspect ratio
1:3





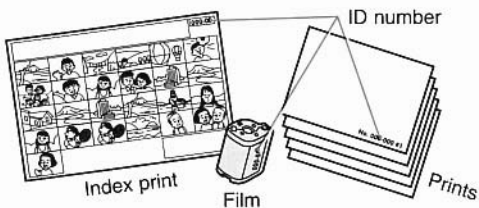



New Photo Developing and Printing Methods

Your exposed film can be developed and printed at any photo lab displaying the authorized Advanced Photo System sign. After developing, you will receive your pictures, an index print that shows all your shots printed on a single page, and the negatives rolled back up in the cartridge. Previous 135 (35mm) film came back with the developed film in a negative sleeve, so that you had to hold negatives up to the light to see which frames you wanted reprinted. But with the Advanced Photo System, you simply match the ID number on the back of the print or on the index print sheet with the ID on the film cartridge, and tell your authorized photo shop which prints you want.



Contents

Features of the Advanced Photo System	3
Handling Precautions	8
Quick Start Guide	10
Nomenclature	12
1. Before You Start [Attaching the Strap]	17
Loading the Batteries and Checking Battery Level	18
Loading the Batteries	18
Checking the Battery Level	19
Mounting and Detaching a Lens	20
Holding the Camera	22
The Shutter Button and Autofocusing	23
Loading the Film	24
Removing the Film	25
Checking Film Information	26
2. Fully Automatic Operation	27
□ Full Auto Mode	28
Changing Print Formats	30
Automatic Flash	31
About the AF-Assist Beam	31
⊙ Using the Red-Eye Reduction Function	32
👤 Portrait Mode	34
🏞 Landscape Mode	35
📷 Close-up Mode	36
🏃 Sports Mode	37
🌃 Night Scene Mode	38
⌚ Using the Self-Timer	39
Using the Eyepiece Cover	40
Continuous Shooting	40
3. Application Mode Operation	41
Focusing Point Selection	42
Focusing on Subjects at the Edge of the Frame	43
Subjects Difficult for Autofocusing	44
Metering Methods	45
P Program AE Mode	46
Tv Shutter Speed-Priority AE Mode	48
Av Aperture-Priority AE Mode	50
M Manual Mode	52
A-DEP Automatic depth of Field AE Mode	54
* Using Partial Metering with AE Lock	55
Exposure Compensation	56

 Auto Exposure Bracketing	57
Bulb Exposure	59
Changing Film Speed	60
 Switching Off the Electronic In-Focus Tone	61
Combinations of Shooting Functions	62
4. Using Flash	63
Using the Built-In Flash	64
E-TTL Automatic Flash with an EX Series Speedlite	66
Normal Flash Operation	67
High-Speed Sync (FP Flash)	68
* FE Lock	69
5. Using Convenient Advanced Photo System Functions	71
Setting the Date and Time	72
 Date Frontprinting	74
 Midroll Film Change (MRC)	75
 Recording Titles	76
 English Title List	80
 Setting the Print Quantity	81
 Changing a Title or Print Quantity Setting	82
 Fixed Time Printing Mode (FTPM)	83
6. Reference	85
Exposure Indicator is Flashing	86
Basic Photography Terms	87
Troubleshooting Guide	89
Major Accessories (sold separately)	91
Principal Specifications	93
Lens Specifications	97
Index	98

Handling Precautions

Camera Care

- (1) This camera is not waterproof, and should not be used in rain or under water. If water gets into your camera, take it quickly to the nearest Canon Service Center. Remove any water droplets from the camera's exterior with a clean, dry cloth. If the camera is exposed to salt air, wring out a clean, damp cloth, and use it to wipe off the camera.
- (2) Be careful not to leave your camera inside an automobile that is standing in direct sunlight. The interiors of automobiles in this situation can become hot enough to damage a camera.
- (3) If your camera gets foreign matter in its lens or cartridge chamber, remove it only with a commercially available blower brush. Do not wipe the camera body or lens with any cleaner containing organic solvents. If your camera is particularly dirty, contact a Canon Service Center.
- (4) If you will not be using your camera for a long period, remove the batteries from its battery compartment and store it in a cool, dry, well ventilated location. While storing it, trigger its shutter release from time to time to make sure it still works.
- (5) Avoid storing your camera in a laboratory or other location where chemicals are used, or the camera may rust or corrode. Also avoid storing the camera in clothes dressers or similar places.
- (6) If you have not used your camera for a long time, inspect it thoroughly before using it again. After long disuse or before important events such as overseas travel, you may want to have your camera inspected by your nearest Canon Service Center, or you may choose to check its functions yourself.

LCD panel

Your camera includes a number of LCD panels. If a panel becomes dim, contact your nearest Canon Service Center to have it replaced (this is a fee service). Note that LCDs respond more slowly in cold conditions, and can turn black at temperatures above 60 °C (140 °F), but will operate normally again when returned to room temperature.

Lithium Batteries

Your camera will not start to function until you insert two CR2 lithium batteries. Be sure to check the batteries' power in the following situations:

- (1) After replacing the batteries
 - (2) When the camera has not been used for a long period
 - (3) If the shutter release does not operate properly
 - (4) When shooting in cold conditions
 - (5) When taking particularly important pictures
- Always wipe the battery contacts free of dirt or fingerprints before inserting the batteries, or you risk poor contact or corrosion.
 - Your camera's batteries have excellent cold-weather characteristics, but their capacity is nevertheless reduced at temperatures near or below 0 °C (32 °F). When using your camera in cold locations, always carry a spare set of batteries, and keep the camera in a warm place such as a pocket.

Low Battery Power

When the low battery indicator  flashes in the LCD panel, the camera will still take pictures at the proper exposure as long as the shutter release operates. However, because battery capacity is reduced, the automatic winding and rewinding functions may not operate. Replace the batteries with a fresh set.

Film Precautions

Avoid exposing the film to the following conditions, which can affect the film or cartridge:

- (1) Near strong magnetic fields, such as motors or transformers
- (2) In hot or humid locations

Quick Start Guide

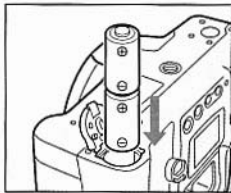

Load the batteries.

Insert two CR2 lithium batteries as shown on the indicator on the battery compartment cover (→ 18).

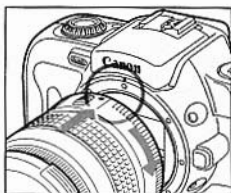

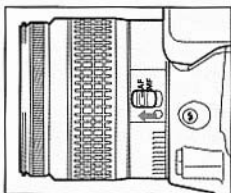

Mount the lens.

Align the lens with the red mark on the camera, and turn it clockwise until you hear it click into place (→ 20).

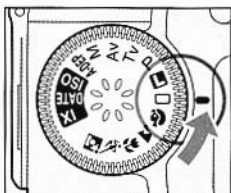

Set the lens focusing mode switch to AF (→ 20).



Set the Mode Dial to  (Full Auto) (→ 28).

5

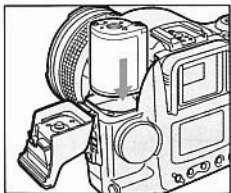

Load the film (→ 24).

6

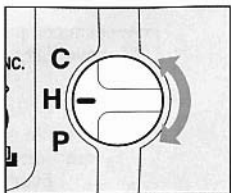

Change the print format using the print format selector lever (→ 30).

7



Focus on the subject.

- Place the AF frame over the subject, then press the shutter button halfway to focus (→ 23).

8

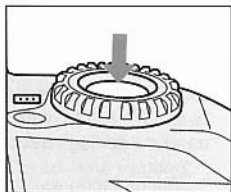

Shoot the picture.

Press the shutter button all the way to shoot the picture.

- In dark or backlit conditions, the flash fire automatically (→ 31).
- Remove the film after shooting the roll, when the film is finished rewinding (→ 25).

Nomenclature

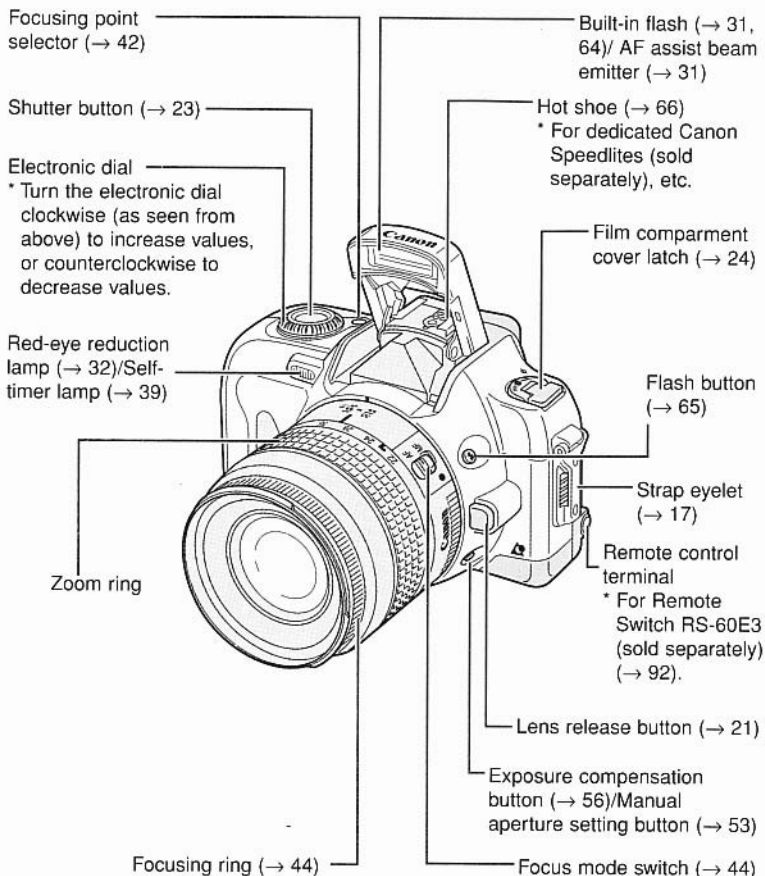

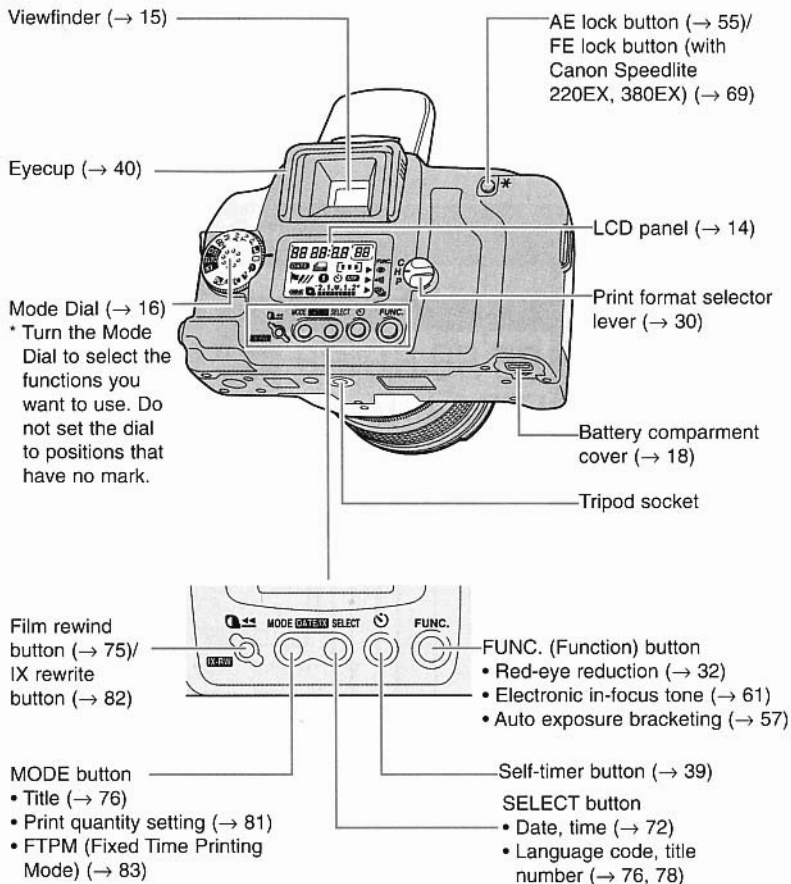

LCD Panel

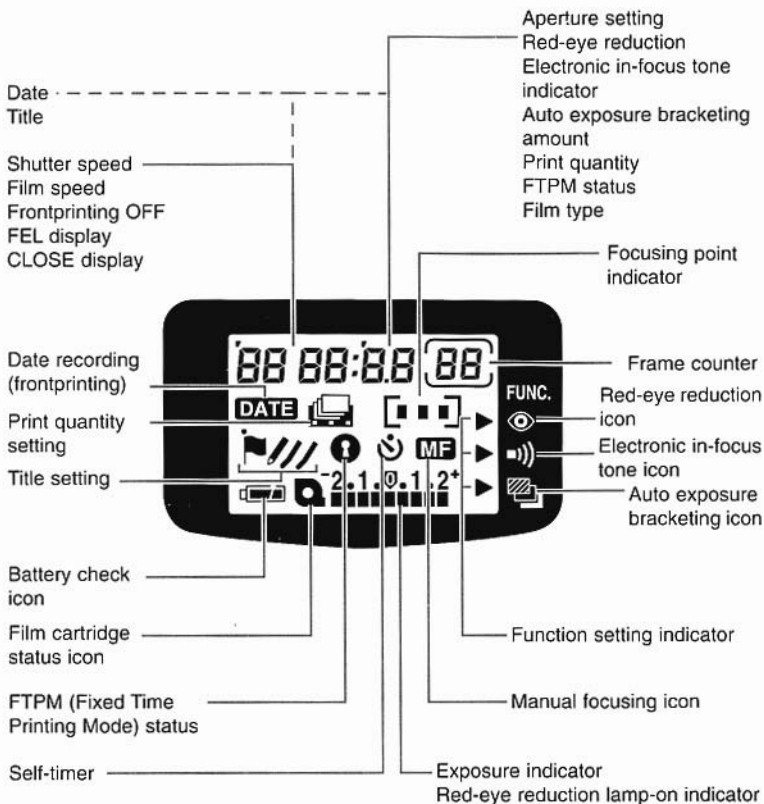

The LCD panel is shown with all indicators displayed, though the actual display shows only the necessary information at any given time.

Viewfinder Information

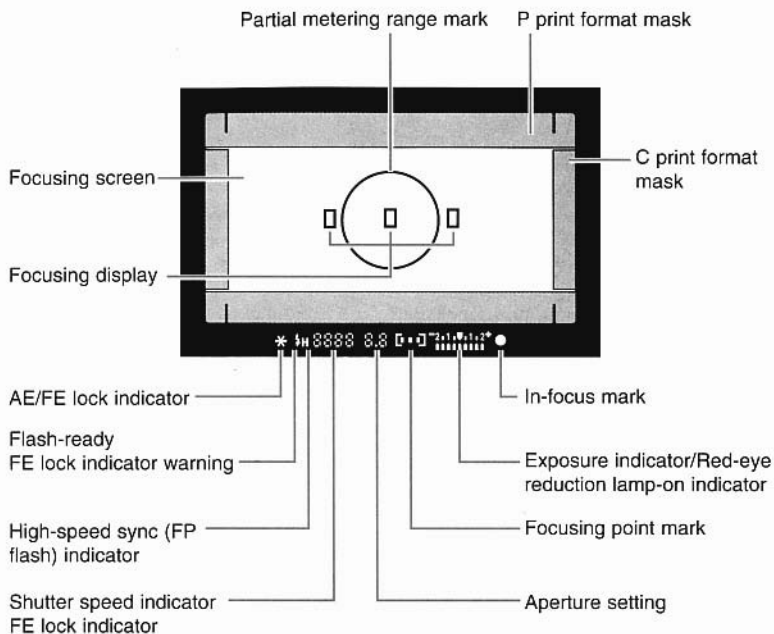

The viewfinder is shown with all indicators displayed, though the actual display shows only the necessary information at any given time.

Mode Dial

The Mode dial is divided into four zones.

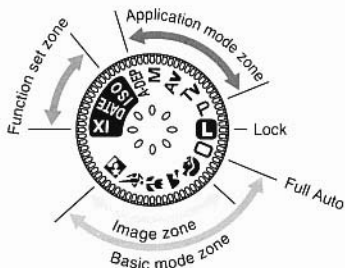

1. : Full Auto (→ 28)
In this mode, the camera takes care of everything.
 - All you do is press the shutter button.
 - This mode overrides all camera buttons and dials, except the shutter button.

Automatic operation suiting the subject type.

- All you do is press the shutter button.
- : Portrait Mode (→ 34)
- : Landscape Mode (→ 35)
- : Close-up Mode (→ 36)
- : Sports Mode (→ 37)
- : Night Scene Mode (→ 38)

2 Application Mode Zone

You take control of the camera for creative effects.

- P : Program AE (→ 46)
- Tv : Shutter speed-priority AE (→ 48)
- Av : Aperture-priority AE (→ 50)
- M : Manual exposure (→ 52)
- A-DEP : Automatic depth of field AE (→ 54)

3 Function Set Zone

- ISO : ISO film speed (→ 60)
Film information check (→ 26)
- DATE : Date and time (→ 72)
- IX : Title recording (→ 76)
Change title, print quantity (→ 82)

4 : Lock (LOCK)



- When not using your camera, set the Mode Dial to to prevent accidental operation. The position locks all camera functions.

1

Before You Start

This section describes how to get your camera ready to take pictures, and how the shutter button works.

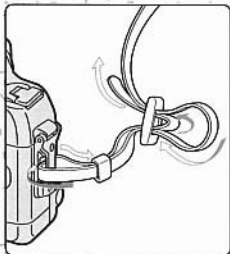

Attaching the Strap

Pass the end of the strap through the strap clasp, and pull the strap tight to make sure the clasp does not come loose. When you carry the camera with the strap over your shoulder, make sure the lens faces downward to protect the lens.

- The eyepiece cover (→ 40) is attached to the strap.

Loading the Batteries and Checking Battery Level

Loading the Batteries

Your camera uses two CR2 lithium batteries.

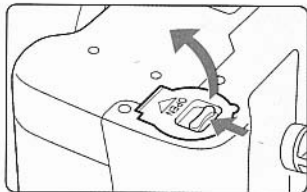

1 Open the battery compartment cover.

- Slide the battery compartment lever in the direction of the arrow.

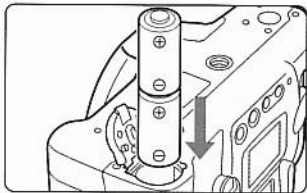

2 Load the batteries.

- Load the batteries with their + and – terminals positioned according to the indicator on the battery compartment cover.
- Do not load old and new batteries together.

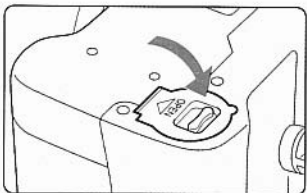

3 Close the battery compartment cover.

- Turn the Mode Dial to any setting other than **L** to turn the power on.



- If the **DATE** indicator in the LCD panel flashes after you turn the power on, the date and time will not be recorded on the picture. Always be sure to set the date each time you replace the batteries (→ 72).



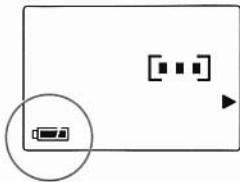
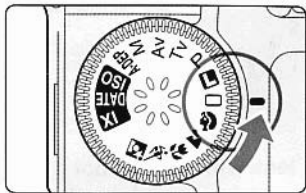

Checking the Battery Level

Check the batteries' capacity after replacing them, and before you start shooting.



Turn the Mode Dial to any position other than **L**.

- The battery check icon appears in the LCD panel.

-  : Battery is in good condition.
-  : Battery is getting low. Have a new battery ready.
-  : Battery will expire soon.
-  : Replace the battery (→ 18). The shutter will not operate in this condition.

Battery Capacity

Temperature	Without flash	With 50% flash	All with flash
Normal (20 °C/68 °F)	60 rolls	24 rolls	12 rolls
Low (-10 °C/-4 °F)	30 rolls	14 rolls	7 rolls

- These specifications taken under Canon testing conditions using fresh batteries, EF 22–55mm f/4-5.6 USM lens, with 25-exposure IX240 film.
- Using the autofocus function when not shooting, or trial shooting with no film loaded, uses battery power and reduces shooting capacity.



- Batteries are hard to obtain in some locations. Be sure to get spare batteries before leaving on an overseas trip, or before taking large numbers of pictures.
- The camera's main battery also functions as the date/time battery.

Mounting and Detaching a Lens

Mounting a Lens

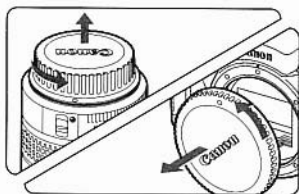

1 Remove the dust cap from the lens, and the body cap from the camera.

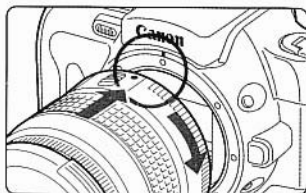

2 Align the lens with the red dot on the camera and press it into place, then turn the lens in the direction of the arrow until you hear it click into place.

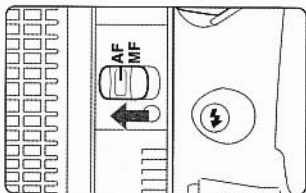

3 Set the lens focusing mode switch to AF.

- If the switch is set to MF (or M), the camera will not focus automatically.
- During autofocus, do not touch the rotating portion of the lens.

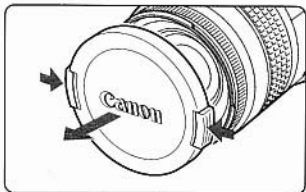

4 Remove the lens cap.

- After you remove the dust cap, body cap, or lens cap, be sure to keep them where they will not get lost.

Detaching a Lens

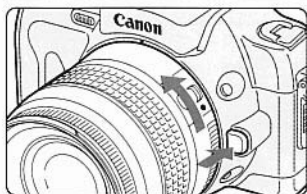

Press the lens release button and turn the lens in the direction of the arrow.

- Turn the lens until it stops, then remove it from the camera.



- To avoid damaging the electrical contacts or lens area, place the lens with the mount side up or cover the lens with the dust cap. Damage to these areas can prevent the lens and camera from functioning together properly.



Holding the Camera

To take clear, sharp pictures, hold the camera so that it does not move as you shoot.

Horizontal position



Vertical position

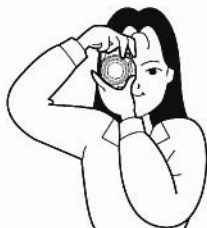

- Hold the camera with the grip firmly in your right hand, and keep your elbow lightly against your body.
- Support the lens from below with the left hand.
- Hold the camera up to your face and look through the viewfinder.
- Stand with one foot slightly ahead of the other, and relax your body.



The Shutter Button and Autofocusing

The EOS camera's shutter button can be pressed halfway or all the way. It operates as described below (with the lens' focus mode switch set to AF).

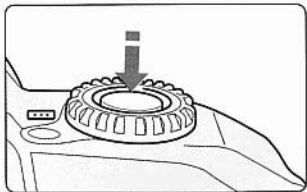

When it is pressed halfway:

- You can set your camera to focus the image automatically when you press the shutter button halfway (this is called autofocus, or AF). When the camera has focused on your subject, it beeps twice, and the green "in-focus" mark appears in the lower right part of the viewfinder frame. The AF frame also appears in the viewfinder to show the frame in which the camera has focused.
- At the same time, the camera determines the exposure setting (a combination of the shutter speed and aperture setting), and displays it in the LCD panel.

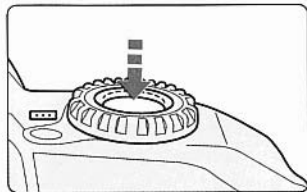

When it is pressed the rest of the way:

- The shutter is released to expose one picture, and the film is advanced one frame.



Camera movement during the moment of exposure can cause blurred pictures.

To prevent this:

- Hold the camera steady.
- Put the center of your fingertip over the shutter button and grip the camera with your entire right hand. Then press the shutter button gently.
- Use a faster shutter speed.

Loading the Film

Your camera uses IX240 cartridge film. Do not use 135 (35mm) film.

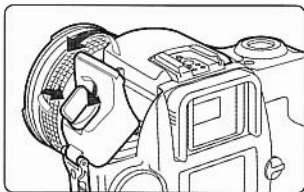

1 Open the film compartment cover.

- Raise the film compartment cover latch and turn it clockwise to open the cover.

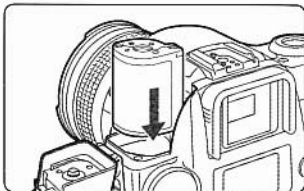

2 Drop in the film cartridge.

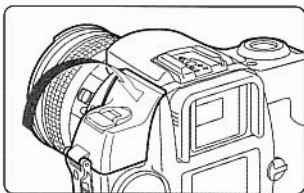

- Drop the cartridge in with its visual exposure indicator facing upward.



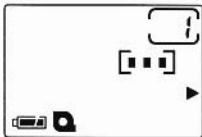

3 Close the film compartment cover.

- Press the cover in the direction of the arrow until you hear it click into place. The latch automatically returns to its position.
- The film then winds automatically.
- The LCD panel shows the film cartridge icon, film sensitivity, and number of frames.
- The frame counter displays a "1" to show that the film is set to the first frame.





- Be sure to load a cartridge with a status mark of  (unexposed) or  (partially exposed). If the film is not loaded properly, the  indicator will flash, and you will need to remove the film and reload it properly.



- If you load a cartridge with an exposed  or processed  status mark, the  indicator will flash.

Removing the Film

When you get to the end of a roll of film, your camera will rewind it automatically. During rewinding, the LCD panel shows the  indicator, and the number in the frame counter counts backwards. When the  indicator flashes and the frame counter shows 0, you can remove the film.

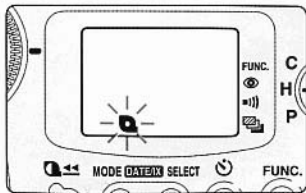

1 Make sure the indicator is flashing in the LCD panel.

- The  indicator flashes for approximately four seconds, then remains lit steadily.

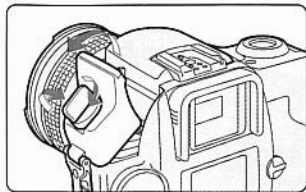

2 Open the film compartment cover.

- Raise the cartridge film compartment cover latch and turn it to the right to open the cover.

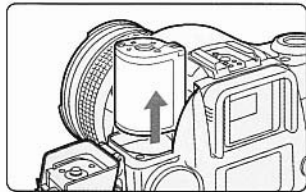

3 Remove the film.



- The  indicator in the LCD panel then goes out.



- Whenever there is film in the camera, the film compartment cover is locked. If you try to open the film compartment cover, the message "CLOSE" appears in the LCD panel, and you will hear a warning tone. Immediately return the film compartment cover latch to its regular position.

- To rewind the film in midroll, press the  (film rewind) button (→ 75).



- If the  indicator and frame counter in the LCD panel flash during rewinding, something has gone wrong with the rewinding operation. Try removing and replacing the battery, then pressing the film rewind button again. If the camera still does not operate, set the main switch to  and take the camera to the nearest Canon Service Center.

Checking Film Information

Here is how to check information about the film in the camera.

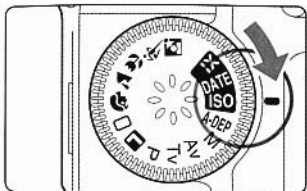

1 Set the Mode Dial to ISO .

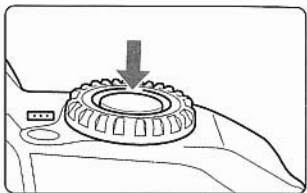

2 Check the film information.

- When you press the shutter button, the LCD panel shows the film sensitivity and type, and the number of shots on the roll.

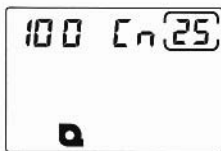

Film Type Indicators:

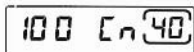

Color negative film

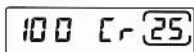

Color reversal film (slide film)

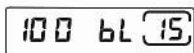

Black and white film









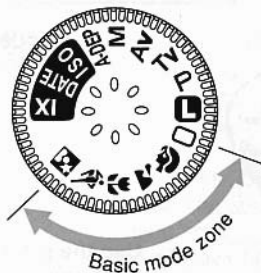



- When the Mode Dial is set to ISO, pressing the shutter button all the way down does not release the shutter.

2

Fully Automatic Operation



This section explains the simplest way to take pictures: by setting the Mode Dial to the , , , , , and  mode settings. In  (Full Auto) mode and the Image Zone modes, all camera functions are automated so that anyone can shoot pictures successfully simply by pressing the shutter button. Only the shutter button and print format selector lever are active, and all other buttons and electronic dials on the front of the camera (other than  ) settings,  and ) are switched off to protect against mistakes.

Full Auto Mode

In (Full Auto) mode, all you need to do is press the shutter button to take pictures of any subject with confidence. The camera can focus on subjects in any of its three autofocusing zones, so that anyone can take beautiful pictures easily.

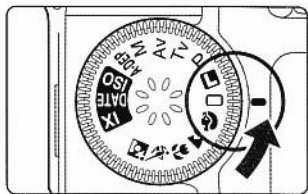

1 Set the Mode Dial to (Full Auto).

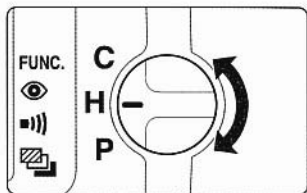

2 Use the print format selector lever to choose the print format.
•The frame in the viewfinder changes to the format you select (→ 30).



3 Position the subject in one of the AF frames.

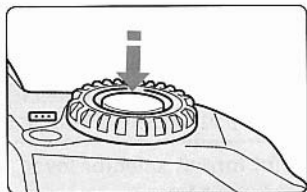

4

Focus on the subject.

- Press the shutter button halfway until you hear a beep.
- When focusing is complete, the camera beeps twice, and the green in-focus mark (●) appears inside the lower right edge of the viewfinder.
- In dark places or when the subject is backlit, the flash pops up automatically (→ 31).



5

Check the LCD panel.

- The shutter speed and aperture setting are determined automatically, and displayed on the LCD panel and inside the viewfinder.



6

Shoot the picture.

- Compose the picture, then press the shutter button the rest of the way to release the shutter.

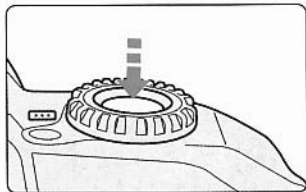

- As soon as autofocusing is complete, the focus and exposure settings are locked (→ 43).
- If the in-focus mark (●) is flashing, the shutter will not operate. Try focusing again.
- The camera is designed to focus automatically on the closest of the subjects in the three autofocus frames.
- Sometimes more than one autofocus frame mark goes on. This means that points in all the indicated frames are in focus.

Changing Print Formats

Your camera can take shots in three different print formats: C (Classic), H (HDTV or wide-angle), and P (Panoramic). You can change the print format for every frame if you want. Choose the print format that best fits the picture you want to take.

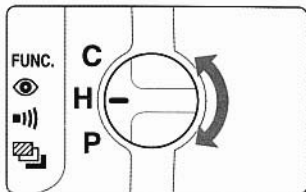

Move the print format selector lever to change the print format.

- The viewfinder frame changes to match your selection.

C print format

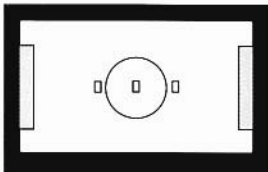

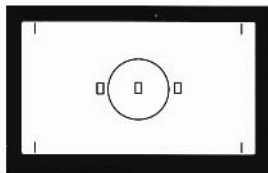

H print format



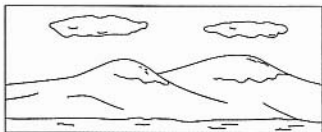
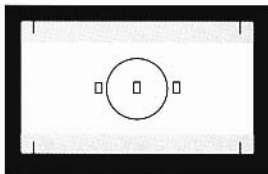

P print format





Automatic Flash

When shooting in □ (Full Auto) mode, or the , , or  Image Zone modes, the flash automatically pops up and fires whenever the subject is too dark or lit from behind.

-  • If something prevents the flash from popping up, the battery mark will flash in the LCD panel ( mark flashing for two seconds). If this happens, press the shutter button halfway, and the camera will return to normal.
-  • In places where flashes are prohibited, or when you want to shoot pictures using indoor lighting, we recommend shooting in **P** mode (Program AE/ → 46).

About the AF-Assist Beam

When taking flash pictures, you may see the flash fire when you press the shutter button halfway. This is to provide extra light (called an “AF-assist beam”) to help the autofocus function get a better focus.

-  • The AF-assist beam does not operate in  or  modes.
- The AF-assist beam from the built-in flash has a focusing range of 1 to 4 m (3 to 13 ft).
- If you are using a separate exclusive EOS flash unit (sold separately), the AF-assist beam fires from that flash instead.

Using the Red-Eye Reduction Function

In flash pictures taken at night or in dark places, peoples' eyes often appear as shiny red lights. This is called "red-eye," and happens when the light of the flash reflects from the retinas of the subjects' eyes. To avoid this problem, the red-eye reduction lamp lights for approximately 1.5 seconds to cause the subjects' pupils to contract, thus reducing the red-eye effects.

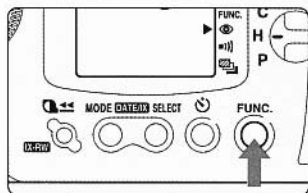
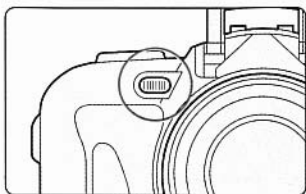

- 1 Press the function button to move the ► indicator to the  icon.

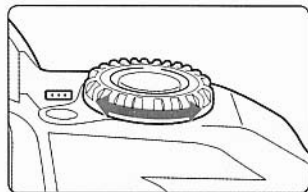

- 2 Set the LCD panel value to "1".
- Turn the electronic dial until "1" appears in the LCD panel. To cancel the red-eye reduction function, turn the dial until "0" appears in the LCD panel.
 - To turn off the setting, do any of the following.
 - Press the shutter button halfway.
 - Turn the Mode Dial
 - Wait approximately six seconds (setting turns off automatically).

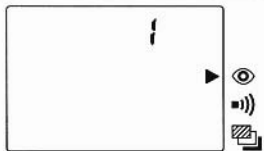



- Press the shutter button halfway. The exposure level indicators in the LCD panel go on, and then go off one at a time to tell you the red-eye reduction lamp is operating.

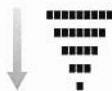

- For effective red-eye reduction, wait until the red-eye reduction lamp goes off before pressing the shutter button the rest of the way down.
- You can press the shutter button all the way down to shoot the picture even while the red-eye reduction lamp is on.
- The red-eye reduction lamp operates even if you are using a separate exclusive EOS external speedlite.
- The effectiveness of red-eye reduction varies with individual subjects.



- This function is effective only if the people you are photographing look at the red-eye reduction lamp. We suggest you tell them to look at the lamp when shooting.
- Stay within 2 m (6.6 ft) of your subject.
- Set the lens to wide-angle.
- Brighter room lighting and closer subjects increase the effectiveness of red-eye reduction.

Portrait Mode

The image was removed due to copyright restrictions

Portrait Mode lets you blur the background so that your subjects stand out.

- When the subject is in focus, the camera beeps twice.
- You can press and hold the shutter button down to take continuous shots.
- The flash automatically pops up and fires whenever the subject is too dark or lit from behind.

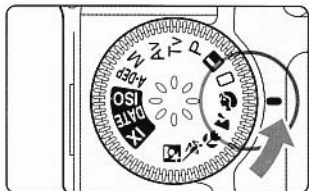

Turn the Mode Dial to  (Portrait).

- Shoot the picture the same way as in Full Auto mode (→ 28).



- You can effectively de-focus the background by positioning the subject so that the upper half of her body more or less fills the frame. It also helps to separate the subject from the background as far as possible.
- You can effectively de-focus the background further by using a telephoto lens. With a zoom lens, move towards the telephoto end (55mm for a 22–55mm lens).





Landscape Mode

The image was removed due to copyright restrictions

Landscape Mode lets you shoot broad landscapes and night scenes.

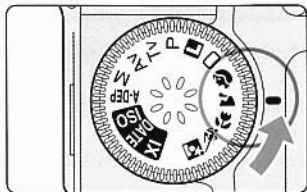
- When the subject is in focus, the camera beeps twice.
- The built-in flash does not fire in this mode.



Turn the Mode Dial to  (Landscape).

- Shoot the picture the same way as in Full Auto mode (→ 28).



- If you have a zoom lens, set it towards the wide-angle end (22mm for a 22–55mm lens). This adds depth from foreground to background, and increases the horizontal range of the shot.
- You can set the print format to P (Panoramic) to take even broader shots (→ 30).



- If the shutter speed display flashes, the shutter speed is slow enough that hand movement can cause blurring. Check the way you are holding the camera or pushing the shutter button, or try shooting from a tripod. (Using a tripod will not stop the shutter speed display from flashing, however.)



Close-up Mode

The image was removed due to copyright restrictions

Close-up mode uses the lens' built-in macro function for close-up photography to let you take large, clear pictures of small subjects, such as flowers or insects.

- When the subject is in focus, the camera beeps twice.
- The flash automatically pops up and fires whenever the subject is too dark or is lit from behind.

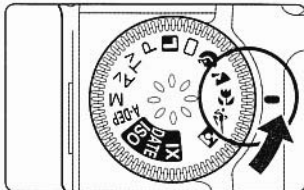

Turn the Mode Dial to  (Close-up).

- Shoot the picture the same way as in Full Auto mode (→ 28).
- Continuous shooting is not available in this mode.



- Hold the camera close to the subject, at the minimum focusing distance for the lens you are using.
- If you have a zoom lens, set it towards the telephoto end to make the subject appear larger (55 mm for a 22-55 mm lens).
- For serious close-up shooting, we recommend the EF 50mm f/2.5 compact macro, EF 100mm f/2.8 macro, or EF 180mm f/3.5L macro USM lens (sold separately).



Sports Mode

The image was removed due to copyright restrictions

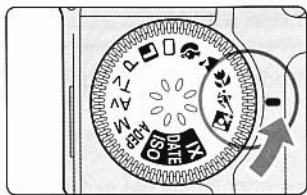

Sports mode lets you take shots that freeze fast-moving subjects.

- Press and hold down the shutter button, and the camera will continue to focus on the subject and shoot continuously.
- The built-in flash does not fire in this mode.



Turn the Mode Dial to  (Sports).

- Shoot the picture the same way as in Full Auto mode (→ 28).

-  • We recommend you use high-sensitivity ISO 400 film in Sports mode.
- If you are using a zoom lens, we recommend using a 200–300mm telephoto setting.
-  • If the shutter speed display flashes, the shutter speed is slow enough that hand movement can cause blurring. Check the way you are holding the camera or pushing the shutter button, or try shooting from a tripod. (Using a tripod will not stop the shutter speed display from flashing, however.)

Night Scene Mode

The image was removed due to copyright restrictions

In Night Scene mode, you can take beautiful pictures of people against sunset or night backgrounds.

This feature uses the flash to capture the human subject, while the slower shutter speed captures the background.

We recommend you use a tripod to reduce the chance of blurring.

- When the subject is in focus, the camera beeps twice.

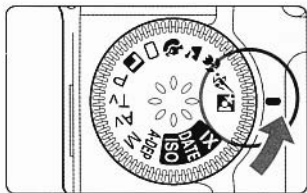

Turn the Mode Dial to  (Night Scene).

- Shoot the picture the same way as in Full Auto mode (→ 28).
- Continuous shooting is not available in this mode.





- The shutter speed is slow in Night Scene mode. Be sure to tell those you are photographing not to move immediately after the flash fires. If you are using the self-timer, the red-eye reduction lamp flashes once to let you know the exposure is finished.
- For pictures of night scenes only, use the  (Landscape Mode) setting.
- You can also use Night Scene mode with an EOS exclusive external flash unit.
- In daylight, this mode works the same as Full Auto mode.

Using the Self-Timer

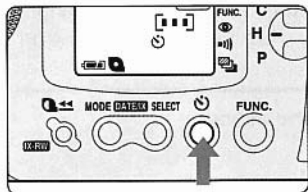
You can use the self-timer to include yourself in your pictures. This feature is available in the Basic Mode Zone as well as in the Application Mode Zone. We recommend you use a tripod when using the self-timer or remote controller.



1 Turn on the indicator.

- Press the self-timer button to turn on the  icon on the LCD panel.
- To cancel the self-timer setting, press the self-timer button again.
- You can also cancel the self-timer by turning the Mode Dial to the  position.

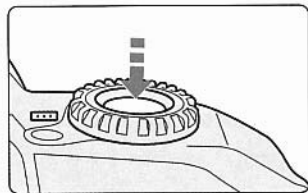

2 Shoot the picture.

- The sequence is the same as for Full Auto mode (→ 28).
- Look through the viewfinder and press the shutter button all the way down.
- Once the shutter button is pressed all the way, the electronic tone beeps as follows, and ten seconds later the shutter releases:
 - Slow tone (two beeps per second) for eight seconds
 - Fast tone (eight beeps per second) for two seconds
- While the self-timer is operating, the LCD panel displays the number of seconds remaining until shutter release.
- For self-timer shots, the red-eye reduction lamp lights for the last two seconds before the shutter is released.



- Do not stand immediately in front of the camera when you press the shutter button, or the camera may not focus properly.
- To take a self-timer shot of yourself, use the focus lock (→ 43) and focus on an object that is about as far from the camera as you will be when you enter the picture.

Using the Eyepiece Cover

The self-timer function and remote control unit (sold separately) are often used to take shots in which you are not looking through the viewfinder. In these situations, light from the viewfinder can affect the exposure setting, so always be sure to place the eyepiece cover (attached to the strap) over the viewfinder to prevent this problem.

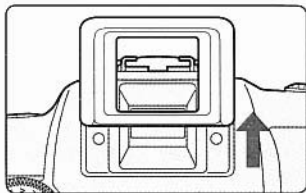

1 Remove the eyepiece.

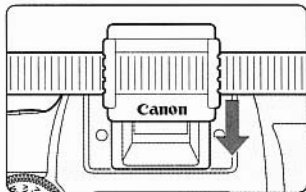

2 Press the eyepiece cover over the eyepiece.

Continuous Shooting

When the shutter button is pressed and held all the way down, the film winding mode (single-shot or continuous shooting) is automatically determined by the shooting mode setting. For details, see the table "Combinations of Shooting Functions" on page 62.

3

Application Mode Operation

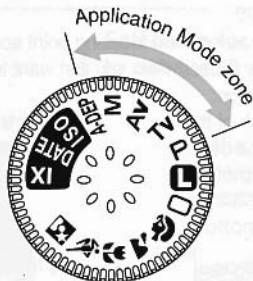

The Application Mode Zone settings let you control the exposure for many different types of shots, by choosing the camera's shutter speed, aperture setting, or AF frame selection. This section tells you how to use the **P**, **Tv**, **Av**, **M**, and **A-DEP** settings effectively, and also describes methods of exposure compensation.

Focusing Point Selection

The focusing point is the frame within which your camera focuses. The focusing point can be selected automatically or manually. In Full Auto mode, any of the Image Zone modes, or **A-DEP** mode, only automatic selection is available. In **P**, **Tv**, **Av**, or **M** mode, you can switch between selecting frames automatically or manually.

Auto Focusing Point selection:

The camera automatically selects the focusing point according to shooting conditions, and focuses the shot. This is best when you just want to take simple snapshots.

Manual Focusing Point selection:

You can also choose which of the three focusing points you want to focus on. This is handy when you want to be sure you are focusing on a particular subject, or when you want to better control the shot's composition while using the speedy focusing function.

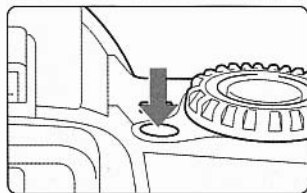

1 Press the focusing point selector.

- The corresponding focusing point appears in the LCD panel.
- The focusing point selection stays on for approximately six seconds, even if you take your finger off the button.

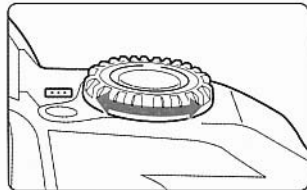

2 Select the focusing point you want to use.

- Watch the LCD panel or the viewfinder display as you turn the electronic dial to select the focusing point you want.

Automatic AF selection: [••]

Left focusing point selected: [◻]

Center focusing point selected: [•]

Right focusing point selected: [◻]

- The setting cycles through the above selections in the order shown.



- You can cancel manual AF frame selection and return the camera to automatic AF frame selection by turning the Mode Dial to Full Auto or any Image Zone position.

3 Press the shutter button halfway.

- The camera returns to ready-to-shoot mode.
- The selection stays on for approximately six seconds, even if you take your finger off the button.

Focusing on Subjects at the Edge of the Frame

Here is how to focus on subjects that appear at the edge of the frame and not at any of the three focusing points. This is called the “focus lock function.”

You can use this technique even in fully automatic shooting.

1 Select the focusing point you want to use (→ 42).

2 Focus on the subject.

- Position the subject at the focusing point you selected, and press the shutter button halfway to focus on the subject.

3 Keep holding the shutter button halfway down, and compose the picture the way you want it.

4 Shoot the picture.

- Press the shutter button the rest of the way down.



The image was removed
due to
copyright restrictions



The image was removed
due to
copyright restrictions

Subjects Difficult for Autofocusing

Your camera has a highly accurate autofocus system that can focus on almost any kind of subject. However, a few kinds of subjects may be difficult to bring into focus (the in-focus mark (●) flashes in these cases).

Hard-to-Focus Subjects

- Extremely low-contrast (light/dark) subjects, such as blue skies or single-color surfaces
- Intensely backlit or highly reflective subjects, such as a very shiny car surface
- Subjects that are not a uniform distance from the camera, such as an animal in a cage

In these cases, it is best to first focus on some object that is at the same distance as your subject and use the focus lock (→ 43), or focus manually as follows.

Manual Focusing

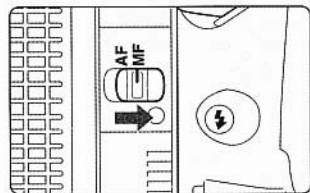

- 1 Set the focus mode switch on the lens to MF (or M).

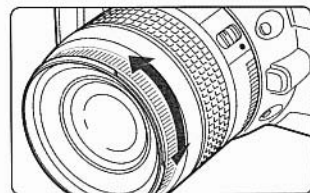

- 2 Turn the focusing ring until the subject is clearly focused.



- When you change from automatic to manual (MF or M) focusing, the camera will show you when the subject is in focus by displaying the focusing point that is in focus, and the in-focus mark (●).

Metering Methods

Your camera has three metering methods: evaluative metering, partial metering, and centerweighted averaging. The camera normally uses evaluation metering, but automatically changes to partial metering when you use the AE lock function, and changes to center-weighted averaging in **M** (manual exposure) mode.

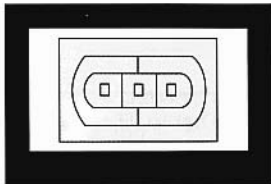

Evaluative Metering

Used for all general situations, including backlighting. The camera provides the proper exposure for the main subject at all times by using the three focusing points to determine the subject's position in the viewfinder, as well as the brightness, background, and front- or backlighting conditions.

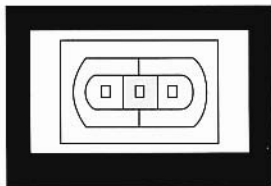

Partial Metering

Measures the brightness in the central area that makes up approximately 6.5% of the viewfinder. This is particularly effective in backlit conditions, when the area around the subject is brightly lit.

- The illustration at left shows the partial metering range.

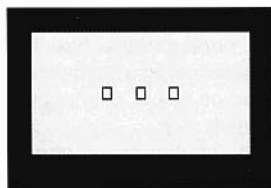

Centerweighted Averaging Metering

Measures the overall average brightness of the image in the viewfinder frame, with emphasis on the center area.



- In one-shot and AI focusing modes (except AI servo mode), when you press the shutter button halfway, the camera automatically applies the AE lock as soon as it has focused on the subject.
- You cannot select or change the metering method.

P Program AE Mode

The image was removed due to copyright restrictions

Program AE mode provides simple, easy shooting, similar to Full Auto mode \square . The camera selects the shutter speed and the aperture setting according to the brightness of the subject. This is called "Program AE."

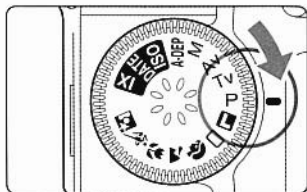

1 Turn the Mode Dial to P .

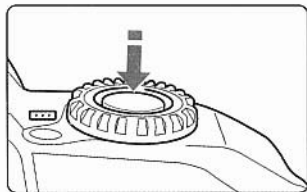

2 Focus on the subject.

- Press the shutter button halfway until you hear a beep.
- When focusing is complete, the camera beeps twice, and the green in-focus lamp (●) appears inside the lower right edge of the viewfinder.

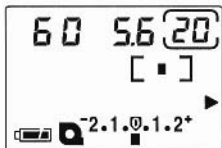

3 Check the LCD panel.

- The shutter speed and aperture setting are determined automatically, and displayed on the LCD panel and inside the viewfinder.
- As long as the shutter speed and aperture setting are not flashing, the exposure is correct.
- If the shutter speed and aperture setting are flashing, check the list of exposure warning indicators on page 86.



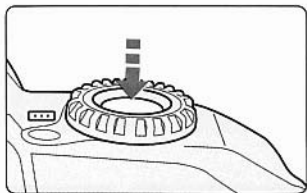

4 Shoot the picture.

- Compose the picture, then press the shutter button the rest of the way down to release the shutter.

Differences between Program AE and Full Auto Mode

Program AE mode **P** and Full Auto mode **□** are alike in that they both automatically determine a combination of shutter speed and aperture setting, but differ as shown in the following table (O: function available, x: function not available).

Function	P	Full Auto
Continuous shooting	O	x
Program shifting	O	x
Exposure compensation	O	x
Auto exposure bracketing (AEB)	O	x
AE lock	O	x
Manual focusing point selection	O	x
Built-in flash forced ON	O	x
High-speed sync with EX-series Speedlite	O	x
FE lock with EX-series Speedlite	O	x

Shifting the Program

In **P** mode, once the combination of shutter speed and aperture (the program) is automatically set, you can change the speed and aperture setting together while maintaining the same overall exposure level. This is called "program shifting."

To use program shifting, hold the shutter button halfway down and turn the electronic dial until the desired shutter speed or aperture setting appears.

- After you shoot the picture, the program shift is automatically canceled and the camera returns to **P** mode.
- Program shifting is not available when you use a flash.

Tv Shutter Speed-Priority AE Mode

When you set the shutter speed, the camera automatically sets the aperture to provide the correct exposure for the subject brightness. This is called "shutter speed-priority AE."

Faster shutter speeds can freeze the motion of fast-moving subjects, while slower shutter speeds can give the subject a more flowing feeling. The shutter speed is set using the electronic dial.

The image was removed due to copyright restrictions

Faster shutter speeds

The image was removed due to copyright restrictions

Slower shutter speeds

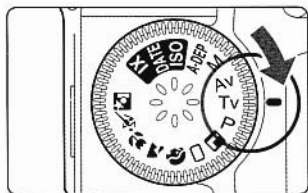

1 Turn the Mode Dial to Tv.

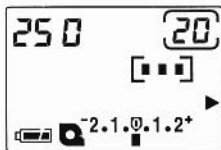

2 Select the shutter speed.
• Look at the LCD panel while you turn the electronic dial to the desired shutter speed.

3 Focus the shot.

4 Check the indicators.

5 Shoot the picture.



- If the lowest aperture setting for your lens (its largest or full-aperture opening) is flashing, the subject is too dim and the picture will be underexposed. Turn the electronic dial to decrease the shutter speed until the flashing stops.
- If the highest aperture setting for your lens (its smallest aperture opening) is flashing, the subject is too bright and the picture will be overexposed. Turn the electronic dial to increase the shutter speed until the flashing stops.



- To take sharp pictures of television images, set the shutter speed to 1/15 second. Be sure to use a tripod so that the camera does not move.



• Shutter speed notation

You can set the shutter speed in 1/2-step increments. The display shows the denominator of the shutter speed, from 2000 to 30". For example, the figure 125 stands for 1/125 second, 0"7 stands for 0.7 seconds, and 15" stands for 15 seconds.

2000	1500	1000	750	500	350	250	180	125	90	60
45	30	20	15	10	8	6	4	3	2	0"7
1"	1.5"	2"	3"	4"	6"	8"	10"	1"5	20"	30"

Av Aperture-Priority AE Mode

When you set the aperture speed, the camera automatically sets the shutter speed to provide the correct exposure for the subject brightness. This is called "aperture-priority AE."

Decreasing the aperture value (opening the aperture) makes the background appear blurred, for more attractive portrait shots. The lower the aperture value, the more the background is blurred. Increasing the aperture (closing the aperture) in a scene with depth brings both nearby and distant objects into sharper focus. The higher the aperture value, the deeper the range of sharp focus. The aperture is set with the electronic dial.

The image was removed due to copyright restrictions

Higher aperture setting

The image was removed due to copyright restrictions

Lower aperture setting

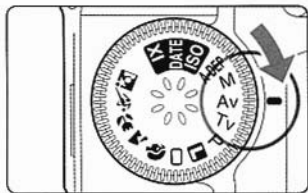

1 Turn the Mode Dial to Av .



2 Select the aperture setting.
• Look at the LCD panel while you turn the electronic dial to the desired shutter speed.

3 Focus the shot.

4 Check the indicators.

5 Shoot the picture.



- If the 30" shutter speed indicator is flashing, the subject is too dim and the picture will be underexposed. Turn the electronic dial to decrease the aperture value until the flashing stops.
- If the 2000 shutter speed indicator is flashing, the subject is too bright and the picture will be overexposed. Turn the electronic dial to increase the aperture value until the flashing stops.



• Aperture notation

You can set the aperture value in 1/2-step increments. The higher the value, the smaller the aperture (the opening in the lens). The available range of aperture values differs depending on the lens you are using.

1.0	1.2	1.4	1.8	2.0	2.5	2.8	3.5	4.0	4.5	5.6
6.7	8.0	9.5	11	13	16	19	22	27	32	38
45	54	64								

If no lens is mounted on the camera, the aperture value indicator will read 00.

M Manual Mode

The image was removed due to copyright restrictions

Instead of leaving it up to the camera, you can use Manual mode to control the appearance of your pictures by selecting the shutter speed and the aperture setting yourself. You can then verify that you have chosen a proper combination of shutter speed and aperture setting by checking the exposure level mark.

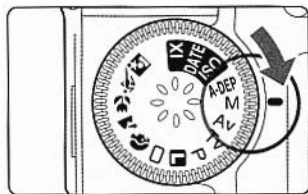

1 Turn the Mode Dial to **M**.



2 **Select the shutter speed.**

- Look at the LCD panel while you turn the electronic dial to the desired shutter speed.

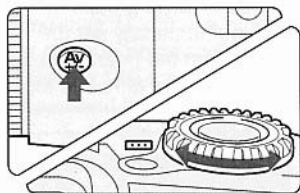

3 Select the aperture setting.

- Hold down the manual aperture setting button and turn the electronic dial to the desired aperture setting.

4 Focus the shot.

5 Check the indicators.



6 Refer to the exposure level marks, and adjust the shutter speed and aperture setting as needed.

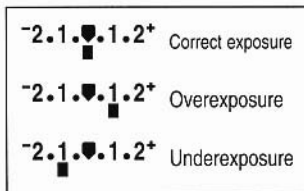

Correct exposure: This is the reference mark for determining the correct exposure.

Overexposure: Increase the shutter speed or the aperture setting.

Underexposure: Decrease the shutter speed or the aperture setting.

7 Shoot the picture.

A-DEP Automatic depth of Field AE Mode

For situations such as taking commemorative pictures of large groups of people, you can use **A-DEP** mode to have the camera automatically set the field of focus so that all subjects are sharply focused, from the nearest to the farthest. In this mode, all subjects in the three focusing points will be in focus.

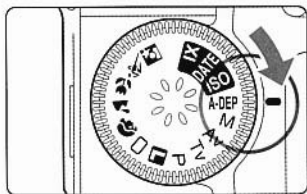

1 Turn the Mode Dial to **A-DEP**.

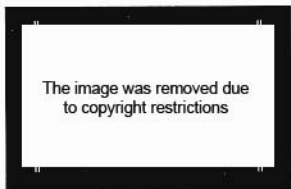

2 Focus the shot.

- Place the three focusing points over subjects in the picture, and press the shutter button halfway down.
- The in-focus range will cover the subjects in the focusing points shown on the LCD panel, and everything in between.



3 Check the indicators.

4 Shoot the picture.



- If the aperture value is flashing, the exposure is correct but the desired depth of field cannot be obtained. Use a wider-angle lens or move away from the subject, and try again.
- **A-DEP** mode does not allow you to select the shutter speed or aperture value yourself. Some settings may result in slow shutter speeds, so you should be sure to hold the camera firmly when shooting, or use a tripod.
- If you use a flash, the result will be the same as shooting in **P** mode with a flash.
- If the focusing mode switch on the lens is set to **MF** (or **M**), **A-DEP** mode is not available.

* Using Partial Metering with AE Lock

The Application Zone modes enable you to set the exposure and focus separately. Use these modes for shots where you have to set the exposure first (auto exposure locking), and then compose the shot. This function is called the “AE lock,” and is useful when there is high contrast between the subject and background, or when the subject is lit from behind.

The image was removed
due to
copyright restrictions

1 Place the subject to be metered in the partial metering zone marks in the center of the viewfinder.

2 Focus on the subject.

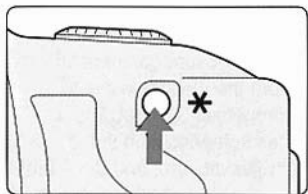

3 Press the AE lock button (*).

- The AE lock indicator (*) appears in the viewfinder, and the exposure level is locked at its current setting (AE lock). The (*) indicator stays on for approximately four seconds after you remove your finger from the AE lock button.

The image was removed
due to
copyright restrictions

4 Re-compose the scene, then shoot the picture.

- Each time you press the AE lock button, a new AE exposure setting is locked.
- The AE lock is released four seconds after the AE lock indicator (*) is displayed, or when the Mode Dial is turned.

-  • Shots taken continuously with the AE lock on (including repeated single-shot exposures) are automatically treated as series scenes (→ 58).

Exposure Compensation

You can intentionally change the standard exposure determined by your camera. This is called exposure compensation, and is generally used when your pictures are turning out too light (overexposed) or too dark (underexposed). The exposure compensation range is from +2.0 stops to -2.0 stops in 1/2-stop increments.

1 Turn the Mode Dial to any of the Application Zone modes other than M mode.

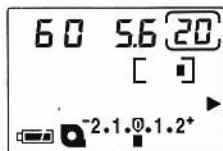

2 Check the exposure indicator.

- Press the shutter button halfway down, and check the indicator on the LCD panel.

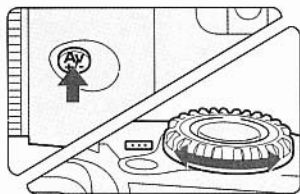

3 Select the compensation level.

- Hold down the exposure compensation button and turn the electronic dial to select the compensation level. The + mark indicates compensation in the direction of overexposure, and the - mark indicates compensation in the direction of underexposure.



Underexposure ← **-2.1.0.1.2+** → Overexposure

- To cancel the exposure compensation setting, set the exposure value to 0. Note that exposure compensation settings are not cancelled when you turn the Mode Dial to **L** to lock the camera.

4 Shoot the picture.



- Exposure compensation settings are canceled automatically when you turn the Mode Dial to any of the Basic Zone modes.



Auto Exposure Bracketing

You can set the camera to automatically expose three frames of film, changing the exposure for the second and third frames by a predetermined exposure compensation value. This is called AEB (Auto Exposure Bracketing). You can set the AEB bracketing increment from 1/2 to two stops above and below the standard exposure level, in 1/2-stop increments. The film advance according to the shooting mode you are using, and the camera takes three shots in this sequence: standard exposure/underexposure/overexposure. This feature is particularly effective for capturing subtle nuances of lighting, and with color reversal (slide) film.

The image was removed due to copyright restrictions

Correct exposure

The image was removed due to copyright restrictions

Underexposure (-0.5)

The image was removed due to copyright restrictions

Overexposure (+0.5)

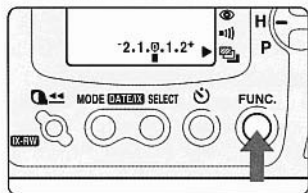

- 1 Press the function button until the ► indicator is opposite the  icon.

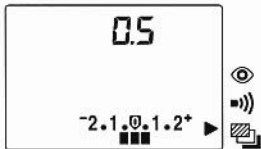

- 2 Select the bracketing increment.

- Turn the electronic dial to select the bracketing increment.
As an example, if you selected 0.5, the exposure would change in this sequence: correct exposure/underexposure (-0.5)/overexposure (+0.5).
- To cancel the AEB setting, reset the bracketing increment to 0.0. Note that the exposure compensation bracketing setting is not canceled by turning the Mode Dial to **L** position.



- AEB settings are canceled automatically when you turn the Mode Dial to any of the Basic Zone modes.

- To turn off the setting, do any of the following.
 - Press the shutter button halfway.
 - Turn the Mode Dial
 - Wait approximately six seconds (setting turns off automatically).

-2.1.0.1.2*	Correct exposure
-2.1.0.1.2*	Underexposure
-2.1.0.1.2*	Overexposure

Shoot the picture.

- The compensation value and exposure sequence appear in the LCD panel and the viewfinder.
- During AEB photography, the ► indicator and dots next to the AEB indicator flash while the exposure level is displayed.



- The AEB exposure compensation setting is not canceled automatically. To cancel, return the exposure compensation value to 0.0.
- Shooting continuous shots by pressing and holding the shutter button exposes three frames in a continuous sequence, but, unlike AEB shooting, the exposure compensation setting is not displayed.
- If you use the self-timer, the camera exposes three frames in a continuous sequence after ten seconds have elapsed.



- AEB and exposure compensation can be used together. If the settings result in an exposure compensation that falls outside the range of the display, the display appears as shown below. However, the auto exposure bracketing and exposure compensation functions still operate normally.

-2.1.0.1.2* AEB set for ± 1 stop.

-2.1.0.1.2* Exposure compensation set for -1 stop.

-2.1.0.1.2* Exposure compensation set for -1.5 stops.

-2.1.0.1.2* Exposure compensation set for -2 stops.



• About Series Scenes

With traditional 135 (35mm) negative film, the photographer can apply exposure compensation when shooting, but printing processes often automatically correct for this intentional compensation and prevent it from appearing in the finished picture.

However, cameras designed for the Advanced Photo System can take shots under the following conditions with the assurance that the IX information automatically recorded on the film will be used to accurately reproduce the exposure conditions at the time of shooting. This function is called a "Series Scene."

(1) Shots taken using auto exposure bracketing (AEB)

(2) Continuous shots taken with AE lock on (including repeated single-shot exposures) (→ 55)

- * Printing conditions may vary with individual photo labs.

Bulb Exposure

In bulb exposure photography, the shutter stays open as long as the shutter button is pressed, and closes when the button is released. This feature is useful for shooting night scenes, fireworks, views of stars, and other scenes that require long exposure times. Always use a tripod for bulb exposures. Using the optional RS-60E3 remote switch makes bulb exposures easier to shoot.

1 Turn the Mode Dial to M .

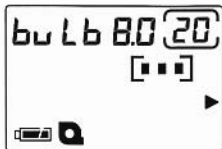

2 Set the shutter speed to buLb .

- Turn the electronic dial to set the shutter speed to **buLb**, which is the setting following 30 seconds.

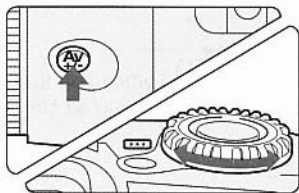

3 Set the aperture value.

- Press the manual aperture button and turn the electronic dial to select the aperture setting.

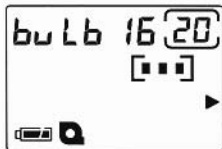

4 Compose the shot, then shoot the picture.

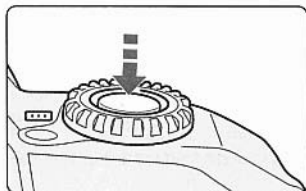

- The shutter stays open as long as you hold the shutter button all the way down.
- During a bulb exposure, the LCD panel flashes the bulb indicator.

Changing Film Speed

You can change the camera's film speed setting (ISO sensitivity) intentionally, as follows.

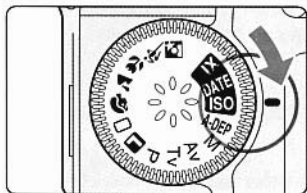

1 Turn the Mode Dial to ISO.

- The LCD panel displays the  cartridge mark and the current film speed setting.

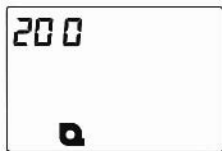
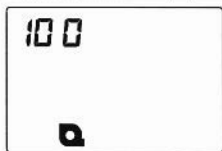

2 Set the film speed.

- Look at the LCD panel while you turn the electronic dial to the desired film speed.

3 Return the Mode Dial to its previous position.



- Use this feature when you want to intentionally overexpose or underexpose all frames on a roll of film.
- The allowable film speed range is ISO 6–8000.



- Change the film speed immediately after loading film in the camera.
- Your film speed setting will be reset automatically when you load the next roll of film.

Switching Off the Electronic In-Focus Tone

In some situations, the electronic in-focus tone might be inconvenient. You can turn off this tone so that it will not function in any mode.

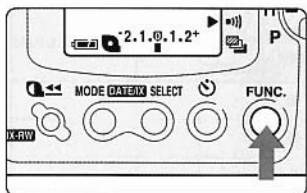

1 Press the function button until the ► indicator is opposite the  icon.

- The figure 1 appears in the frame counter on the LCD panel.

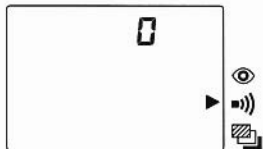
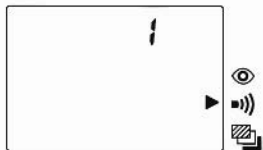

2 Set the frame counter on the LCD panel to 0.

- Turn the electronic dial to set the LCD display to 0.
- To restore the tone, turn the dial back to 1.
- To turn off the setting, do any of the following.
 - Press the shutter button halfway.
 - Turn the Mode Dial.
 - Wait approximately six seconds (setting turns off automatically).

Combinations of Shooting Functions

Mode Dial mark	AF Mode		Focusing point selection		Shooting Mode		Metering method			Built-in flash	
	1-shot	AI focus	Auto	Manual	Single shot	Continuous	Evaluative	Center-weighted averaging	Partial	Auto	Manual
		●	●		●		●			●	
	●		●			●	●			●	
	●		●		●		●				
	●		●		●		●			●	
		●	●			●	●				
	●		●		●		●			●	
P		●	○	○		●	●		(●)*		●
Tv		●	○	○		●	●		(●)*		●
Av		●	○	○		●	●		(●)*		●
M		●	○	○		●		●	(●)*		●
A-DEP	●		●		●		●		(●)*		●

● : Automatic setting ○ : Setting enabled

* Only when the AE lock button is pressed

One-shot: The camera determines the exposure when the subject comes into focus. The shutter will not operate until the subject is in focus.

AI focus: When focusing on a moving subject for one shot, this function detects the subject motion and automatically switches to AI servo autofocus.

AI servo: The camera continuously focuses on a moving subject, and determines the exposure immediately before shutter release.

4

Using Flash

In the Basic Mode zone, all built-in flash operations are fully automatic and controlled by the camera, so you cannot set flash functions yourself.

However, the Application Zone modes enable you to select flash functions to suit your own objectives. The basics are the same as for normal photography, whether you are using the built-in flash or an external EOS-dedicated Speedlite.

This chapter describes various ways to take flash pictures using the built-in flash unit with your own settings (→ 64), or with E-TTL automatic flash exposure control using the separately available EX-series Speedlites (→ 66).

Using the Built-In Flash

In Application Zone modes you can use the built-in flash to take pictures just as you would in normal AE mode, using your choice of aperture value or shutter speed (up to the maximum synchronized shutter speed). The flash exposure is automatically controlled at all times based on the current aperture setting using AF frame-linked, subject-weighted 3-zone TTL flash exposure control.

- **To leave the flash settings up to the camera, select P mode.**

The shutter speed and aperture will be set automatically, just as in Full Auto mode, and the flash level will be weighted towards the main subject.

- **To select the aperture setting yourself, select Av mode.**

This is useful in dark locations, when you want to use automatic slow synchro shooting to get the proper exposure for both the subject and background. The main subject will be exposed using automatic flash exposure compensation based on your aperture selection, while the background will be exposed at a shutter speed determined by the camera using aperture priority AE control.

- Because automatic slow synchro photography uses slow shutter speeds, you should use a tripod.

- **To select the shutter speed yourself, select Tv mode.**

The camera will automatically set the aperture based on your shutter speed selection, and apply automatic flash exposure compensation based on that aperture setting.

- If you select a shutter speed faster than 1/125 second, the camera will automatically reset the shutter to 1/125 second before shooting.

- **To select both the shutter speed and aperture setting yourself, select M mode.**

The background exposure will then be determined by the manual exposure settings. The subject will be exposed using automatic flash exposure compensation based on the aperture setting.

Flash Distance Range (With EF 22–55 mm f/4–5.6 USM lens)

ISO	WIDE		TELE	
	Negative	Positive	Negative	Positive
100	1–3.5 m (3.3–11.5 ft)	1–2.5 m (3.3–8.2 ft)	1–2.5 m (3.3–8.2 ft)	1–1.7 m (3.3–5.6 ft)
200	1–5.0 m (3.3–16.4 ft)	1–3.5 m (3.3–11.5 ft)	1–3.5 m (3.3–11.5 ft)	1–2.5 m (3.3–8.6 ft)
400	1–7.0 m (3.3–23.0 ft)	1–5.0 m (3.3–16.4 ft)	1–5.0 m (3.3–16.4 ft)	1–3.5 m (3.3–11.5 ft)



- Flash shots in A-DEP mode will produce the same result as in P mode.

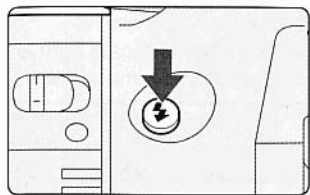

1 Set the Mode Dial to an Application Zone mode.

2 Press the flash button.

- The flash unit pops up.
- To return the flash to its position, press it back down into place.

3 Focus the shot.

4 Check the LCD panel.

5 Shoot the picture.

The image was removed due to copyright restrictions



- For flash settings for longer distance shots, see page 64.
- Shooting with the flash closer than 1 m (3 ft) can cause the flash to be obstructed in part of the picture and make it appear dark. Always take flash shots at least 1 m (3 ft) from the subject.
- Using the built-in flash with the lens hood in place will block the light from the flash. Be sure to remove the lens hood before using the built-in flash.
- You cannot use the built-in flash and an external flash at the same time.
- Light from the built-in flash can be obstructed when used with the following lenses. If you need to use a flash with any of these lenses, we recommend you use an EOS exclusive external flash.

Large-diameter lenses such as the EF 17–35mm f/2.8L USM, EF 28–70mm f/2.8L USL, etc.

Telephoto lenses such as the EF 300mm f/2.8L USM, EF 600mm f/4L USM, etc.

- The built-in flash has an angle of illumination that covers wide-angle shots up to a focal length of 22mm. If you use a lens that has a focal length of less than 22mm, the edges of the resulting picture will appear dark.

E-TTL Automatic Flash with an EX Series Speedlite

The Canon EX Series Speedlites (220EX and 380EX models) are easy-to-operate, EOS exclusive external flash units that can be attached to your camera and used with the same feel and focusing-point-linked E-TTL automatic flash exposure control as the built-in flash. We recommend using an external Speedlite for group pictures where a great deal of light is required, or for portrait photography where lighting effects are important.

E-TTL Automatic Flash System Features

- (1) E-TTL auto flash system (pre-flash and memory-type evaluation compensation) for the focusing point in which the focusing point is located, to provide the optimum flash power for the subject in focus.
- (2) Extremely natural flash shots from daylight slow-synchro to indoor shots, with fully automatic operation that you can leave to the camera.
- (3) Automatic slow synchro photography, selected by using **Av** mode in dark locations. Fully automatic operation provides attractive shots with proper exposure of both subject and background.
- (4) FE (flash exposure) lock shooting that provides proper exposure for any given part of the subject by AE lock shooting using the flash.
- (5) High-speed synchro (FP flash) shooting with exposure compensation for all shutter speeds from 1/2000 second to 30 seconds.
- (6) Application Zone modes let you set the aperture or shutter speed (within the maximum synchronization speed) with the same feel as normal AE shooting.
- (7) Multi-light flash shooting using multiple light accessories and focusing point linked TTL automatic flash exposure compensation, in fully automatic operation.

The image was removed due to copyright restrictions



- In AF shooting, flash exposure is automatically controlled based on the current aperture setting, using focusing-point-linked, subject-weighted E-TTL flash exposure control.
- In Full Auto and Basic Zone modes, the Speedlite always operates with forced flash-on, E-TTL automatic flash exposure control.
- The camera's red-eye reduction function continues to operate when connected to an EOS exclusive external flash device.

Normal Flash Operation

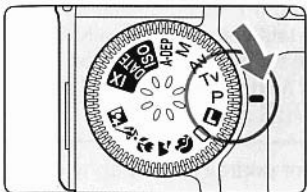

1 **Set the camera's Mode Dial to any mode other than A-DEP.**

- Shooting with the flash in A-DEP mode has the same results as shooting with flash in P mode.

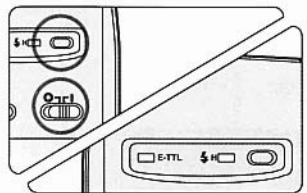

2 **Turn on the Speedlite.**

- Check whether the high-speed synchro (FP flash) lamp on the flash unit is on: if it is, turn it off.

3 **Focus the shot.**



4 **Check the LCD panel.**

5 **Shoot the picture.**

The image was removed due to copyright restrictions

High-Speed Sync (FP Flash)

EX series Speedlites have a high-speed synchro (FP flash) setting for shutter speeds faster than 1/125 second. This lets you automatically take high-speed sync (FP flash) shots synchronized for all shutter speeds. In high-speed sync mode the H icon appears next to the  icon in the viewfinder, when the shutter speed exceeds 1/125 second.

High-speed synchro photography is effective for portrait photography in situations such as these:

- (1) Taking portrait shots using daylight synchro, with the aperture open to defocus the background
- (2) Placing highlights (sparkle) in the eyes
- (3) Adding supplementary light to shadowy areas

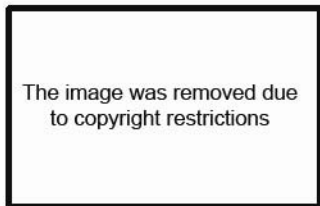

Shooting with normal flash

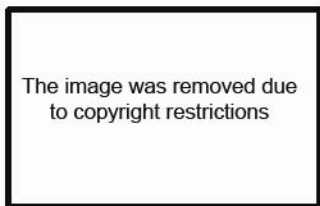

Shooting with FP flash



- High-speed synchro shooting is available only in the Application Zone modes. In the Image Zone modes, the result is the same as for normal flash shooting.
- High-speed synchro shooting reduces the guide number of the flash. Be aware that using high-speed synchro flash with insufficient natural light can cause underexposure.

* FE Lock

The FE (Flash Exposure) lock function optimizes the flash setting for a particular area of the subject.

FE lock shooting functions only in the Application Zone modes. The AE lock button functions as the FE lock button.

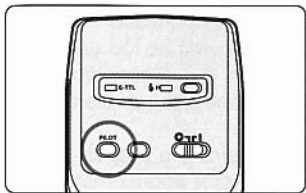

- 1 Turn the Mode Dial to an Application Zone mode.
- 2 Make sure the pilot lamp on the flash unit is on.
 - The FE lock can be used in either normal flash mode or high-speed synchro flash mode.
- 3 Focus the shot, then hold the camera in position and hold the shutter button halfway down.

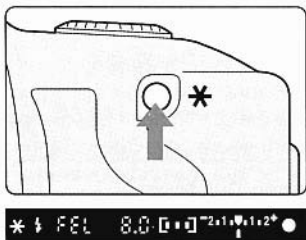

Place the subject in the center of the viewfinder and press the FE lock button.

- The Speedlite pre-flashes to “memorize” the necessary exposure for the subject.
- The shutter speed indicator in the viewfinder briefly changes to “FEL.”
- If the ⚡ icon in the viewfinder is flashing, the subject is outside the flash exposure compensation range, and the exposure will be too dark. Move closer until the ⚡ icon no longer flashes when you press the FE lock button.
- The camera retains the proper exposure setting for approximately 16 seconds after you take your finger off the shutter button.

Shoot the picture.



- If you are using an external flash unit, press the built-in flash back into place before connecting the external flash.
- When you use an external flash with Basic Mode Zone, the settings are the same as in **P** (Program AE) mode, and the flash operates on all shots.
- Other than the EX series exclusive EOS Speedlite, you can use this camera with other exclusive EOS Speedlites (540EZ, 430EZ, 420EZ, 300EZ etc., including multiple-light accessories) for simple, easy flash photography with 3-zone A-TTL/TTL automatic flash exposure control, and the same feel as normal fully automatic shooting.

5

Using Convenient Advanced Photo System Functions

This section tells how to use the convenient Advanced Photo System functions to get the most out of your camera.

Setting the Date and Time

Here is how to set the date and time after replacing the battery or when traveling in a different time zone.

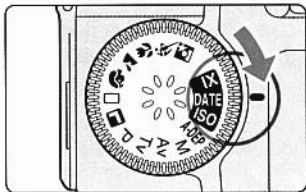

- 1 **Set the Mode Dial to DATE .**
- If no date setting has been made, the **DATE** mark in the LCD panel flashes for four seconds.

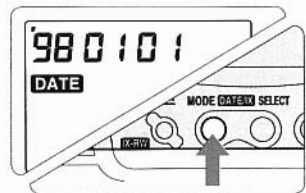

- 2 **Display the date setting.**
- Press the MODE button repeatedly until **DATE** appears in the LCD panel.
 - Press the MODE button repeatedly repeatedly to cycle through the date, time, and OFF positions.

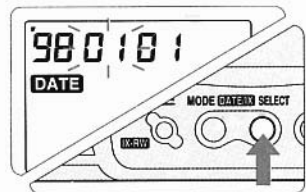

- 3 **Select the digits you want to change.**
- Press the SELECT button repeatedly until the digit you want starts flashing, indicating that it can now be changed.

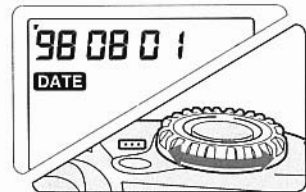

- 4 **Turn the electronic dial to set the digit to its new value.**

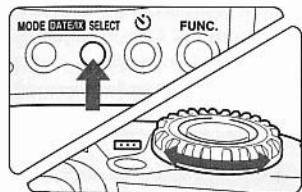

5 Repeat steps 3 and 4 until all digits in the date are set.

- When no more digits are flashing, the date setting is complete.

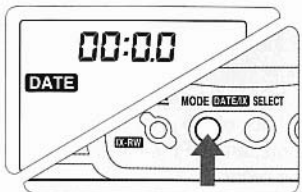

6 Display the Time setting.

- Press the MODE button repeatedly until time appears in the LCD panel.

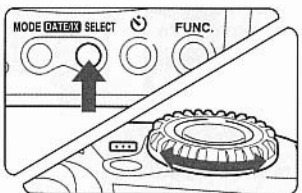

7 Repeat steps 3 and 4 until all digits in the time are set.

- When no more digits are flashing, the time setting is complete.

8 Turn the Mode Dial.



- The **DATE** mark in the LCD panel indicates that front printing is selected (→ 74).
- The settings are retained for approximately three minutes after the batteries are removed.

DATE Date Frontprinting

Your camera includes a perpetual automatic calendar, and records the date and time of every shot on the magnetic recording area of the film. You can then have this information imprinted on the front or back of your prints.

Turn the Mode Dial to **DATE**.

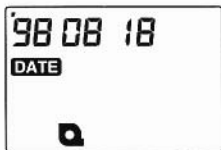

Select the date you want to record.

- Press the MODE button to select the date you want to record.
- The **DATE** indicator appears in the LCD panel to show that frontprinting is selected.
- If you select OFF, the date will be printed only on the back of the print.
- The date, time, and OFF settings appear in the following order.

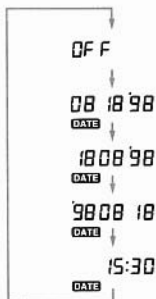

① <Year-month-date> hour, minute (back printing only)

* The date sequence is determined by ② ③ ④.

② AUG 18 1998 (imprint on both sides)

③ 18 AUG 1998 (imprint on both sides)

④ 1998 AUG 18 (imprint on both sides)

⑤ 15:30 (imprint on both sides)

* Hour - Minute display in 24-hour format.



- The ability to print on both sides—as well as character style, size, color, and printing position—varies from one photo shop to another.
- The automatic calendar operates on its own battery.
- The automatic calendar setting remains in memory for approximately three minutes after the main battery is removed.
- After storing the camera for long periods with the battery removed, be sure to set the automatic calendar date and time before using the camera.
- If frontprinting is not selected, the date and time are always printed on the back of the print in year-month-day-hour-minute format. If frontprinting is selected, the format on the back is the same as on the front.
- If the **DATE** icon is flashing, such as after you have changed batteries, the date and time were not recorded. Be sure to set the data and time again (→ 72).

Midroll Film Change (MRC)

If you want to change to a different film speed during shooting or use a different film for a particular scene, you can change the film in midroll. Film cartridges changed in midroll can only be used in cameras that support “midroll cartridge exchange.”

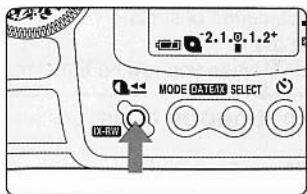

1 Press the film rewind button to rewind the film.

- The film starts rewinding.
- The film direction indicator and frame counter show that the film is rewinding.
- When the  icon is flashing, remove the film from the camera.
- The cartridge status mark is set to D.

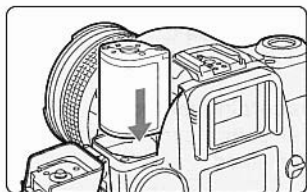

2 Load a partially exposed film (→ 24).

- Make sure the cartridge's visual exposure indicator is set to D.
- The camera then automatically advances the film to the next unexposed frame.

-  In some cases, you may not be able to use partially exposed film with an external flash when the flash is turned on. If this happens, the LCD panel shows a warning indicator [- - - -]. If this warning appears, either remove the partially exposed film or turn off the flash.
- You may not be able to use partially exposed film in areas that are exposed to strong magnetic fields, such as near television broadcast towers. In this case the LCD panel shows a warning indicator [- - - -]. If this warning appears, remove the partially exposed roll of film. Note that that if this happens you can still shoot pictures if you use a fresh roll of film.
- You cannot load partially exposed film into cameras that do not support midroll cartridge exchange (such as the Canon ELPH). Loading partially exposed film in such cameras will change the status indicator to exposed.

Recording Titles

You can imprint titles such as "Birthday" on the back of your prints. Your camera supports titles in 12 languages. The US English titles are listed on page 80, and the titles in other languages are in the separate "Title List." You can record picture titles three ways.

- ① One-Frame Titles: Enters each title for one frame only.
 - ② Continuous Titles: Enters a title for a continuous series of shots.
 - ③ All-Frame Titles: Enters a title for all frames on the roll.
- ① and ② must be selected before shooting, and ③ when you rewind the film.

① Recording one-frame titles or ② continuous titles

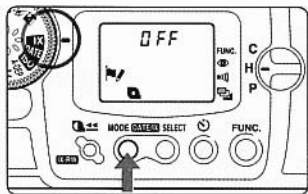

1 Turn the Mode Dial to IX .

2 Show the  or  icon.

- Press the MODE switch to display the icon.

3 Select a recording method.

- Turn the electronic dial to select a recording method.

One-frame titles:  (I)

Continuous titles:  ([)

No title:  (OFF)

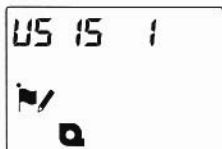

4 Select the language you want.

- Press the SELECT button twice so that the language indicator flashes.
- Turn the electronic dial to select the language you want. The indicator for US English is US.
- Press the SELECT button to complete the setting.

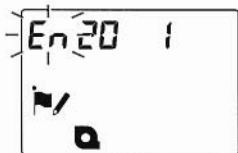
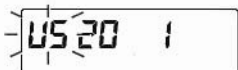

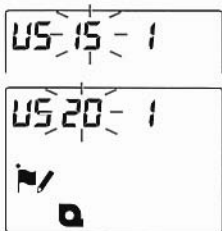

5 Select the title you want.

- Press the SELECT button so that the title indicator flashes.
- Turn the electronic dial to the number of the title you want.
- For a list of titles in US English, see page 80.
- Press the SELECT button twice to complete the setting.

6 Turn the Mode Dial to a shooting mode, and shoot.



- When you select one-frame titles, the title setting is deleted after one shot.
- To cancel a continuous title setting, turn the electronic dial to [OFF].
- The following languages are available.

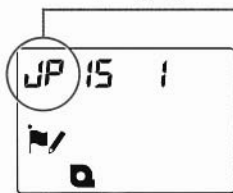

dA : Danish	no : Norwegian
F : Finnish	PO : Portuguese
Fr : French	ES : Spanish
dE : German	S : Swedish
I : Italian	En : English (UK)
JP : Japanese	US : English (US)

- Front/back date printing capabilities—as well as size, style, color, and position of printed characters—depend on the specific photo lab.
- If you select a title number that has no corresponding title, no title will be printed.

③ Recording all-frame titles



- All-frame titles are set after you finish rewinding the film.

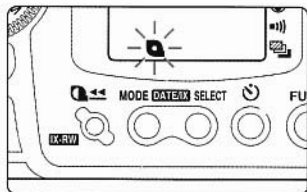

1 Make sure the icon is flashing.

- The  icon flashes for four seconds, then stays on.

2 Turn the Mode Dial to IX.

3 Select a recording method.

- Turn the electronic dial to select a recording method.

All-frame title:  / (R)

No title:  / (Q F F)

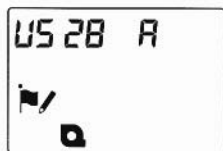

4 Select the language and title you want.

- Follow steps 4 and 5 on pp. 76-77 to select a language and title.

5 Press the IX rewrite button.

- The  icon flashes during rewriting.

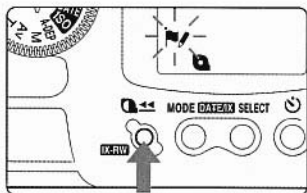

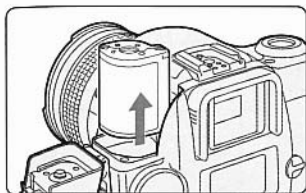

6 Make sure the  icon is on, then remove the film (→ 25).

 • If you open the cartridge chamber cover after rewinding is complete, the all-frame title will not be recorded.

 • To change an all-frame title selection, repeat steps 1 through 5.

 • Front/back date printing capabilities—as well as size, style, color, and position of printed characters—depend on the specific photo lab.

• If you select a title number that has no corresponding title, no title will be printed.

US • English Title List

Your camera provides a selection of up to 90 titles in each of 12 languages. The following list includes all 43 titles available in English. For a complete list of all titles in all languages, see the separately published "Title List".

Title selection	
No.	Title
00	Christmas
01	Birthday
02	Vacation
03	Honeymoon
04	Wedding
05	Hanukkah
06	Graduation
07	Family
08	Party
09	Holiday
10	Anniversary
11	Friends
12	School Event
13	Trip
14	I Love You
15	Thank You
16	Season's Greetings
17	Happy Birthday
18	Congratulations
19	Merry Christmas
20	Festival
21	First day of School
22	Tour
23	New Year's
24	Easter
25	Happy New Year
26	Reunion
27	Father's Day
28	Mother's Day
29	Memories
30	Baptism
31	*
32	*
33	*

Title selection	
No.	Title
34	*
35	*
36	*
37	*
38	*
39	*
40	*
41	*
42	*
43	*
44	*
45	*
46	*
47	*
48	*
49	*
50	Halloween
51	Happy Holiday
52	Independence Day
53	Thanksgiving
54	Rosh Hashanah
55	Yom Kippur
56	Memorial Day
57	Labor Day
58	Valentine's Day
59	Canada Day
60	Victoria Day
61	Remembrance Day
62	*
63	*
64	*
65	*
66	*
67	*

Title selection	
No.	Title
68	*
69	*
70	*
71	*
72	*
73	*
74	*
75	*
76	*
77	*
78	*
79	*
80	*
81	*
82	*
83	*
84	*
85	*
86	*
87	*
88	*
89	*
90	*
91	*
92	*
93	*
94	*
95	*
96	*
97	*
98	*
99	*

* No title for this code selection. If you select a title number that has * next to its code, no title will be printed.



Setting the Print Quantity

Before shooting, you can set the number of prints you want to have made of that shot. This saves the trouble of ordering reprints later, and is handy when you don't want to print shots that did not turn out right.

1 Turn the Mode Dial to IX

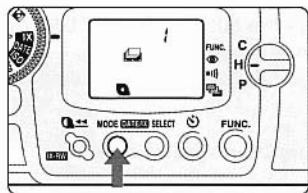

2 Display the icon.

- Press the MODE button until the icon appears.

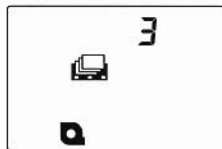

3 Select the number of prints you want.

- Turn the electronic dial to select the number of prints.
- You can select from 0 to 9 prints of any shot.

4 Turn the Mode Dial to a shooting mode, and shoot the picture.

- After the shot, the print quantity setting is canceled.



- If you do not designate a print quantity, the default of 1 will be applied for color negative film, 0 for color reversal (slide) film, or 1 for monochrome film.
- Continuous print quantity settings are not available.
- The print quantity setting may not be effective at some photo labs.

IX-RW Changing a Title or Print Quantity Setting

You can also change the title or print quantity setting for the previous shot.

1 Turn the Mode Dial to IX .

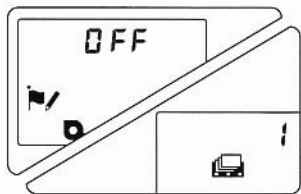

2 Display the title or print quantity setting.

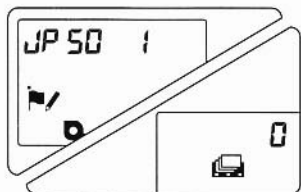

- Press the MODE button to display the title or print quantity.
- To change the title, display the title number and language (→ 76).
- To change the print quantity, display it (→ 81).



3 Change the title or print quantity setting.

- To change the title, select another one (→ 76).
- To change the print quantity, select a new quantity. To print no copies, select 0 (→ 81).

4 Press the IX rewrite button.

- The title or print quantity is then changed.
- While the title is being changed, the  icon flashes.
- While the print quantity is being changed, the  icon flashes.

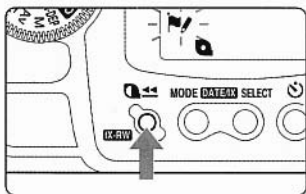

- You cannot change titles or print quantities after shooting the last frame on the film.
- After loading a partially exposed roll of film, you must shoot at least one frame before changing any title or print quantity.
- You cannot change both the title and print quantity at the same time.
- You can change a setting as many times as you like.
- For instructions on selecting an all-frame title, see page 78.

Fixed Time Printing Mode (FTPM)

Your camera includes a function that lets you print all frames on a roll under the same printing conditions. You can specify EOS IX 7/EOS IX Lite for processing results that reflect slight nuances in exposure control, providing the sensitivity of reversal film. This function generally specifies that a roll of film be processed at a single setting without applying automatic corrections for each frame.

1 Turn the Mode Dial to IX .

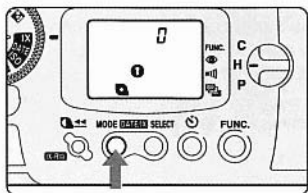

2 Display the  icon.

- Press the MODE button until the  icon appears.

3 Set the LCD panel display to 1.

- Turn the electronic dial until the figure 1 appears in the LCD panel.
- To cancel the setting, turn the electronic dial until the figure 0 appears in the LCD panel.

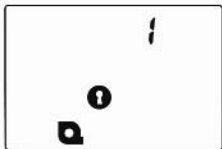

4 Set the MODE dial to a shooting mode, and shoot the picture.

- The IX information that specifies printing the whole roll under the same conditions is automatically recorded during rewinding (including midroll rewinding) when the  icon is displayed.
- The FTPM setting is canceled when the exposed film is removed after rewinding.



- If you specify printing the whole roll under the same conditions at the start of the roll, then decide to cancel the setting after the roll is exposed, be sure to delete the  icon before you rewind the roll.
- You can make this setting during midroll, or just before you finish the last exposure on the film.
- You cannot make FTPM settings to film that is loaded when partially exposed.
- Be sure to tell the photo shop that the film has an FTPM setting when you take the film in for printing.











- If you specify printing the whole roll under the same conditions, and then rewind the film in midroll, the camera will set the cartridge's visual exposure indicator to exposed and you will not be able to continue shooting on that roll.
- Printing conditions may vary according to individual photo labs.

6

Reference

This section explains basic photography terms, tells you what to do if you think your camera may need repair, and provides specifications for the camera.

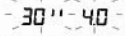
Exposure Indicator is Flashing

Mode Dial mark	Warning indicator (flashing)	Meaning	Solution
P	 The shutter speed is at 30 seconds, and the lens is at its minimum aperture setting for a full-open setting.	The subject is too dark.	Use a flash.
	 The shutter speed is at 1/2000 second, and the lens is at its maximum aperture setting.	The subject is too bright.	Use an ND filter to reduce brightness.
Tv	 The lens is at its minimum aperture setting.	The shot will be underexposed.	Turn the electronic dial to reduce the shutter speed.
	 The lens is at its maximum aperture setting.	The shot will be overexposed.	Turn the electronic dial to increase the shutter speed.
Av	 The shutter speed is at 30 seconds.	The shot will be underexposed.	Turn the electronic dial to reduce the aperture setting.
	 The shutter speed is at 1/2000 seconds.	The shot will be overexposed.	Turn the electronic dial to increase the aperture setting.
A-DEP	 The lens is at its minimum aperture setting.	The desired depth of field is not possible.	1) Move as far away from the subject as possible and try again. 2) If using a zoom lens, move it toward its wide-angle setting.
	 The shutter speed is at 30 seconds, and the lens is at its minimum aperture setting for a full-open setting.	The subject is too dark.	Use a flash (the result will be the same as using a flash in Program AE mode).
	 The shutter speed is at 1/2000 second, and the lens is at its maximum aperture setting.	The subject is too bright.	Use an ND filter to reduce brightness.

Basic Photography Terms

Exposure

Exposure refers to the amount of light that strikes the film when a picture is taken. Applying the right amount of light for the sensitivity of the film is called proper exposure. The proper exposure can be controlled by adjusting the shutter speed and the aperture.

Shutter Speed

The camera's shutter mechanism controls how much light reaches the film by adjusting how long the shutter is open. This time is called the shutter speed.

Your camera shows the shutter speed in the LCD panel and in the viewfinder. The range is from 1/2000 second (2000) to 30 seconds (30"), and includes the bulb setting (B) in which the shutter stays open as long as you hold down the shutter button.

Aperture

The aperture built into the camera lens is an opening that can be made larger or smaller to control how much light strikes the film.

The number that represents the size of this opening is called the aperture setting.

Your camera shows the aperture setting in the LCD panel and in the viewfinder.

Depending on the particular lens you are using with your camera, the range is from 1.0 to 64.



Film Speed (ISO Sensitivity)

The film speed (or "sensitivity") indicates how much light is required to expose the film. The numerical value is determined by the International Standards Organization (ISO). The greater the film speed, the more sensitive the film is to light. Higher ISO values mean that less light is required to shoot pictures, so that shots can be taken in darker locations. Your camera shows the film speed in the LCD panel. The range is from 6 to 8000.

Depth of Field

When you focus on a subject, a certain distance in front and in back of the subject is in focus as well. The length of this distance is called the depth of field, and it can be increased by increasing the aperture setting (closing the aperture). This is called making the depth of field deeper.

Similarly, decreasing the aperture setting (opening the aperture) makes the field of focus shallower. This is called making the depth of field shallower.

Depth of field has the following characteristics:

- (1) The greater the aperture value, the greater the depth of field. (That is, the smaller the aperture opening, the deeper the depth of field.)
- (2) At a given focusing distance, lenses with a shorter focal length produce greater depth of field. Wide-angle lenses have greater depth of field than telephoto lenses.
- (3) At a given aperture setting, the farther away the subject in focus is, the greater the depth of field.
- (4) When the subject is in the center of the field of focus, the field of focus is twice as deep behind the subject as in front of the subject. (See the following diagram.)

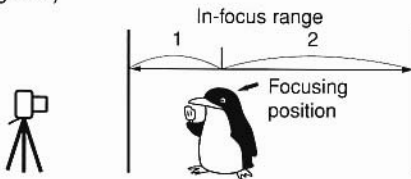

Aperture setting $f/22$





Aperture setting $f/2$

Troubleshooting Guide

Before you take your camera in for service, check this list to see if you can solve the problem.

Problem	Cause	Solution	See page
Cartridge film will not load.	Are you loading exposed or processed film?	Use film with a visual exposure indicator showing that it is unexposed or partially exposed.	3 24
	Is there foreign matter or dust in the cartridge chamber?	Clean the chamber with a blower.	—
Nothing appears in the LCD panel.	Are the batteries low?	Replace the batteries with fresh ones.	18
	Are the batteries installed correctly?	Reinstall the batteries in their proper positions.	18
The shutter does not operate.	Is the main switch on?	Turn the Mode Dial to a shooting mode.	16
	Is the Mode Dial set to a function setting zone?	Turn the Mode Dial to a shooting mode.	16
	Is the film loaded properly? (Is the number of shots shown in the LCD panel?)	Load the film properly.	24
	Has an exposed film been loaded in the camera? (Is the cartridge mark in the LCD panel flashing?)	Replace the film with a fresh roll.	24
	Is the subject in focus? (Is the focus lamp in the viewfinder flashing?)	Refer to the section "Subjects Difficult for Auto Focusing."	44

Problem	Cause	Solution	See page
Pictures look fuzzy or unfocused.	Is the lens focusing mode switch set to MF (or M)?	Set the lens focusing mode switch to AF.	20
	Are your hands moving when you press the shutter?	Press the shutter button gently so that your hands do not move.	23
The camera does not recognize partially exposed film cartridges.	Did you load the film while standing near a television, speaker, or other source of strong magnetic fields?	Load the film away from such devices.	75
	Did you load the film near a television tower, telephone exchange, or other source of magnetic fields?	Load the film away from such locations, or use a new roll.	75
	Are you using an external flash with the main switch on?	Turn the main switch of the flash unit off.	75
The LCD panel shows only the  mark flashing.	Are the batteries low?	Replace the batteries with fresh ones.	18
	The camera may not be functioning properly.	Press the shutter button halfway down. If the battery mark goes on, you can shoot. * If the battery mark does not go on after several attempts, the camera needs service. Contact the nearest Canon Service Center.	23, back cover
The film advance display and frame counter in the LCD panel are flashing, and the camera does not operate.	A problem may have occurred during rewinding.	Try removing and replacing the batteries, then press the film rewind button. If the camera still does not operate, set the Mode Dial to  and take the camera to the nearest Canon Service Center.	18, 75, back cover

Major Accessories (sold separately)

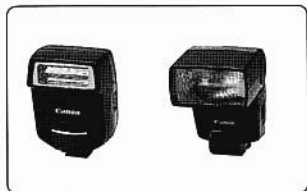

EOS Exclusive EX Series Flash Units

This series of exclusive Canon Speedlites comprises the high-intensity zoom flash 380EX (maximum Guide No. 38/ISO 100m), a clip-on type that mounts on your camera's accessory shoe, and the compact flash 220EX (maximum Guide No. 22/ISO 100m).



Camera Case EH12

An exclusive semi-hard case to protect your camera and lens. Can hold lens sizes EF 22–55 mm f/4–5.6 USM etc.



Diopter Correction Lens Ee (ten types)

If you are nearsighted or farsighted, you can use the camera without eyeglasses by attaching a diopter correction lens with the large eye cup to cover the eyepiece. The interchangeable diopter correction lenses range from -4 dpt to $+3$ dpt, in ten varieties. We recommend actually trying the lenses on your camera before you order them.



Angle Finder Adapter Ed-II

This adapter fits Angle Viewfinder B to make it easier to sight through the viewfinder for applications such as close-ups and photo reproduction.



Remote Switch RS-60E3

This exclusive remote switch prevents camera movement for macro photography or time exposures (bulb exposures) taken with a tripod. It connects to the camera's remote control jack.

Principal Specifications

■ Camera Type

Camera Type	AF/AE IX240 single-lens reflex camera, with vertical-travel focal-plane shutter, built-in motor drive, built-in flash, and built-in magnetic data recording IX functions.
Frame Size	16.7 × 30.2 mm
Compatible Lenses	Canon EF lens series
Lens Mount	Canon EF mount (fully electronic control)

■ Viewfinder

Type	Eye-level SLR pentaprism with roof mirror
Picture Coverage	95% vertically and horizontally (for all C/H/P print mask formats)
Magnification	0.6× (with 40mm lens focused at infinity)
Standard Diopter	-1 dpt (at an eyepoint of 19.7 mm)
Focusing Screen	Fixed, full-screen new laser-matte screen
Viewfinder Information	① In viewfinder screen LCD display for autofocus frame, partial metering position, C/H/P print format mask ② Below viewfinder screen Shutter speed, aperture, * AE lock, $\frac{1}{2}$ flash-ready, H high-speed sync (FP flash), exposure compensation level, ● In-focus indicator, [••] AF frame indicators
Mirror	Quick-return full-screen half-mirror (mirror loss time: none with EF 600mm f/4L USM lens)

■ Exposure Control

Metering System	TTL metering at maximum aperture with six-zone SPC (silicon photocell). ① Evaluative metering (linked to three focusing points) ② Partial metering (automatically set with AE lock: Metering range approximately 6.5% of viewfinder screen) ③ Center-weighted averaging metering (automatically set in manual exposure mode)
Shooting Modes	① Program AE (with program shift) ② Shutter-priority AE ③ Aperture-priority AE ④ Auto depth of field ⑤ Full Auto ⑥ Five Program AE image control modes with image selection ⑦ Flash AE: E-TTL program flash AE for EX series flash, TTL program flash AE for built-in flash, A-TTL or TTL program flash AE for EZ series flash ⑧ Manual
Movement Warning	Operates automatically in Full Auto mode, and in Image Select modes (other than Night Scene mode) when the shutter speed is less than the quantity $[1/(1.25 \times \text{lens focal length})]$. Warning is indicated by the shutter speed indicator flashing at 2 Hz.
Metering Range	EV 1-20 (at normal temperature and humidity with 50mm f/1.4 lens at ISO 100)

Film Speed Range	ISO 6–8000 (set automatically from ISO 25–8000 in 1/3-step increments).
Exposure Compensation.....	<ol style="list-style-type: none"> Auto Exposure bracketing: ± 2 steps in 1/2-step increments, automatically recorded in IX data as series scenes. Exposure sequence: normal/underexpose/ overexpose according to film winding mode, three scenes exposed continuously with self-timer. Manual compensation: ± 2 steps in 1/2-step increments (can be used with autoexposure bracketing).
AE Lock.....	<ol style="list-style-type: none"> Auto AE lock In one-shot AF modes, during auto evaluation, AE locks when the camera focuses. Press the AE lock button to lock AE metering on the center partial metering zone.

■Autofocusing

Autofocus Type	TTL-CT-SiR (through-the-lens cross-type secondary image registration) with multiple BASIS (Base-stored image sensor) type
Focusing Points	Three points (I + I type)
Focusing Brightness Range.....	EV 2–18.5 (ISO 100)
AF Frame Selection	<ol style="list-style-type: none"> Auto: selected automatically by camera. Manual: manual selection of one of three AF frames.
Autofocusing Modes	<ol style="list-style-type: none"> One-shot AF mode: Stops after focusing, enables shutter release. AI-focus AF mode: Measure the movement and switch to AI servo AF automatic tracking when the subject that the one-shot AF mode captured begins moving back and forth. Manual focusing mode: Set the focusing mode switch to MF, and turn the focusing ring manually.
AF Assist Beam	Intermittent flash method. Linked to the three focusing points, and operates automatically when necessary.

■Shutter

Type	Vertical-travel, focal-plane shutter with all speeds electronically controlled
Shutter Speed	1/2000 to 30 seconds (in 1/2-stop settings) plus bulb
Maximum Shutter Speed for Flash	
Synchronization	X = 1/125 second
Release Type	Soft-touch electromagnetic release
Self-Timer.....	Electronically controlled, ten-second limit

■Film Transport

Film Loading	Drop-in loading, automatic film advance to frame 1. Partially exposed rolls automatically advance to the first unexposed frame.
Film Advance	Automatic: <ol style="list-style-type: none"> Single shot Continuous shooting (with a maximum of one frame per second)

Film Rewind	Automatic:
	① Auto rewind from end of film
	② Midroll rewind possible
	Rewind time: approx. 25 seconds (25-shot roll), operating noise level 57 dB

■ Built-In Flash

Type	Retractable TTL automatic pop-up flash (serially controlled)
	① Guide no. 10/33 (ISO 100 - m/ft)
	② Charging time: approx. two seconds
	③ Flash coverage: covers same angle as 22mm lens
	④ Flash conditions: automatic pop-up and flash in Full Auto, Portrait, Close-up, and Night Scene modes in low-light or backlit conditions. Manual pop-up and synchronized flash in Application zone.

Exposure Control Aperture Settings

- ① Full Auto, P modes: TTL program automatically determines exposure control aperture setting.
- ② Av, Manual modes: Set desired aperture manually.
- ③ Tv mode: Aperture set automatically according to selected shutter speed.

Exposure Control Shutter Speed Settings

- ① Full Auto, P modes: Automatically set from 1/60 to 1/125 second.
- ② Av mode: Automatically set according to aperture setting, from 1/200 second to 30 seconds.
- ③ Tv mode: Set manually to any desired speed slower than 1/125 second (in 1/2 steps).

Exposure Control Method	Automatic TTL compensation according to metering of light reflected at film plane (3-zone compensation linked to focusing point)
-------------------------------	--

Exposure Control Range	Negative film: with f/1.4 lens, ISO 100: 1 to 10 m/3.3 to 32.9 ft, ISO 200: 1 to 14 m/3.3 to 46.0 ft, ISO 400: 1 to 20 m/3.3 to 65.6 ft.
------------------------------	--

Red-Eye Reduction Function	In Full Auto, Portrait, Close-up, and Night Scene modes: flash pops up and red-eye reduction lamp lights automatically in low-light conditions, no release lock applied.
----------------------------------	--

■ IX (Information Exchange) Functions and Print Instructions

Print Format Switching	Select C, H, or P print format using the print format selector lever.
------------------------------	---

Printing Functions	(1) Frontprinting
--------------------------	-------------------

Any one of the following selections can be printed on the front:

- ① No data ② M-D-Y ③ D-M-Y ④ Y-M-D ⑤ H-M. (Availability of frontprinting, character style, size, color, and position depends on individual photo lab.)

(2) Backprinting

- ① If no frontprinting selection is made, date and time are always printed on the back in Y-M-D-H-M format. If a frontprinting selection is made, the same format will also be used for backprinting. ② Focal length ③ Open aperture value ④ Shutter speed ⑤ Aperture setting ⑥ Exposure compensation (Printing availability depends on individual photo lab.)

Title Imprinting Function.....	12 languages. 100 titles (including blank selections) available in each language. Three input types: one-frame titles/continuous titles/All-frame titles
Print Quantity Setting Functions	The number of prints can be set from 0 to 9.
Printing Conditions.....	① FTPM printing When selected, recorded with IX data during film rewinding. ② Series scene Recorded with IX data for autoexposure bracketing or continuous shooting with AE lock.

■ Camera Body

Flash Contact.....	Accessory shoe, X-contact, or direct contact.
External Flash System.....	Accepts E-TTL, A-TTL, or TTL automatic flash exposure compensation
Remote Control.....	Uses remote switch RS-60E3, with standard 2.5-mm mini-jack remote connector
Automatic Calendar	Built-in (from 1 Jan. 1998 to infinity, including long and short months and leap years, operating on same batteries as main body)
Power Supply.....	Two CR2 lithium batteries
Shooting Capacity.....	Approx. 24 rolls of 25-shot film at 50% flash, room temperature, approx. 14 rolls at low temperature (-10 °C)
Battery power indicator	Battery power is checked automatically when the main switch is released from the L position, and displayed at all times on the exterior LCD panel (four levels).
Dimensions (W × H × D)	122.8 × 80 × 63.5 mm/4.8 × 3.2 × 2.5 in
Weight.....	360 g/12.7 oz (body only)

* All data measurements are according to Canon testing standards.

* Product specifications and appearance are subject to change and improvement without prior notice.

Lens Specifications

Lens		EF 22–55 mm f/4–5.6 USM	EF 55–200 mm f/4.5–5.6 USM
Field angle	Diagonal	90° – 43°	43° – 12°
	Vertical	57° – 25°	25° – 7°
	Horizontal	79° – 36°	36° – 10°
Lens configuration		9 groups, 9 lenses	13 groups, 13 lenses
Minimum aperture		f/22 – 32	f/22 – 27
Focusing range		0.35 m (13.8 in) to infinity	1.2 m (3.9 ft) to infinity
Maximum magnification (W/T)		0.08/0.2	0.06/0.21
Filter diameter and number of filters usable		58 mm, 1	52 mm, 1
Length, max. diameter		66 × 59.4 mm	70.4 × 97.3 mm
Weight		175 g (6.2 oz)	310 g (11.0 oz)

About the Effective Field Angle of EF Lenses

Because the effective frame of the IX240 camera is smaller than the frame of a 35mm-format camera (see illustration at right), The effective field angle of the EF lenses mounted on the EOS IX 7/EOS IX Lite is equivalent to the indicated focal length distance times approximately 1.25x.

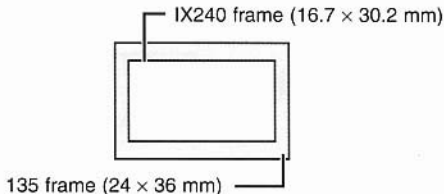

Index

A		F	
Accessories	91	* FE Lock	69
AF Assist Beam	31	Features of the Advanced Photo System	3
AI Focusing	62	Film	
AI Servo	62	Changing Film Speed	60
All-Frame Titles	78	Checking film information	26
Aperture-Priority AE Mode	50	Film Type indicator	26
Aperture Setting	87	Loading film	24
Application Zone Modes	16	Midroll Film Change	75
Auto Exposure Bracketing	57	Sensitivity (ISO value)	87
Autofocus Frame		Flash Range	64
Focusing Point Selection	42	Focus Lock	43
Focusing on Subjects at the Edge of the Frame	43	FTPM printing	83
Automatic depth of Field AE Mode	54	Full Automatic Mode	28
Automatic Flash	31	Function Mode Zones	16
B		H	
Basic Mode Zone	16	High-Speed Sync (FP Flash)	68
Batteries		Holding the Camera	22
Checking Battery Power	19	I	
Loading the Batteries	18	Image Zone Modes	16
Battery Capacity	19	IX Information Recording	4
Bulb Exposure	59	L	
C		Landscape Mode	35
Carrying Strap, Attaching	17	LCD Panel	14
Center-Weighted Averaging Metering	45	Lens	
Changing a Title or Print Quantity Setting ..	82	Detaching a Lens	21
Changing Print Formats	30	Mounting the lens	20
Close-up Mode	36	Specifications	97
Combinations of Shooting Functions	62	M	
Continuous Titles	76	Manual Focusing	44
D		Manual Mode	52
Date and Time Setting	75	Metering Methods	45
Date Frontprinting	74	Midroll Film Change	3, 15
Depth of Field	88	Mode Dial	16
Differences between P and Full Auto Mode ..	47	N	
E		Night Scene Mode	38
EF Lenses and Effective Field Angle	97	Nomenclature	12
E-TTL Automatic Flash		Normal Flash Operation	67
with an EX Series Speedlite	66	O	
System Features	66	One-Frame Titles	76
Exposure	87	One-shot autofocus	62
Exposure Compensation	56		
Exposure Indicator is Flashing	86		
Eye-piece Cover	40		

P	
Partial Metering	45
✳ Using Partial Metering with AE Lock	55
Photo Developing and Printing Methods	5
➔ Portrait Mode	34
P Program AE Mode	46
Program Shifting	47
Q	
Quick Start Guide	10
R	
⊕ Redeye reduction function	32
S	
Series Scenes	58
🖨 Setting the Print Quantity	81
Shutter Speed	87
Tv Shutter Speed-Priority AE Mode	48
Single-shot and Continuous Shooting	40
Specifications	93
🏆 Sports Mode	37

Subjects Difficult for Autofocusing (Manual Focusing)	44
➔ Switching Off the Electronic In-Focus Tone..	61

T	
The Shutter Button and Autofocusing	23
Titles	
📄 Changing recorded titles	82
List of titles	80
Recording titles	76
Troubleshooting Guide	89

U	
Using the Built-In Flash	64
⊕ Using the Self-Timer	39

V	
Viewfinder	15

This device complies with Part 15 of the FCC Rules. Operation is subject to the following two conditions: (1) This device may not cause harmful interference, and (2) this device must accept any interference received, including interference that may cause undesired operation.

Do not make any changes or modifications to the equipment unless otherwise specified in the instructions. If such changes or modifications should be made, you could be required to stop operation of the equipment.

This equipment has been tested and found to comply with the limits for a class B digital device, pursuant to part 15 of the FCC Rules. These limits are designed to provide reasonable protection against harmful interference in a residential installation. This equipment generates, uses and can radiate radio frequency energy and, if not installed and used in accordance with the instructions, may cause harmful interference to radio communications.

However, there is no guarantee that interference will not occur in a particular installation. If this equipment does cause harmful interference to radio or television reception, which can be determined by turning the equipment off and on, the user is encouraged to try to correct the interference by one or more of the following measures:

- Reorient or relocate the receiving antenna.
- Increase the separation between the equipment and receiver.
- Consult the dealer or an experienced radio/TV technician for help.

This digital apparatus does not exceed the Class B limits for radio noise emissions from digital apparatus as set out in the interference-causing equipment standard entitled "Digital Apparatus", ICES-003 of the Industry Canada.

Cet appareil numérique respecte les limites de bruits radioélectriques applicables aux appareils numériques de Classe B prescrites dans la norme sur le matériel brouilleur: "Appareils Numériques", NMB-003 édictée par l'Industrie Canada.



The CE Mark is a Directive conformity mark of the European Community (EC)

Canon

Company information that is no longer current
has been removed. If you have any questions
regarding this model and are calling from the USA.
please call 1 800 OK CANON