

Canon

EOS 30

DIGITAL



Exif Print

DPOF

PictBridge

DIRECT
PRINT

BUBBLE JET
DIRECT

ENGLISH

INSTRUCTION
MANUAL

Thank you for purchasing a Canon product.

The EOS 30D is a high-performance, digital AF SLR camera with a large, fine-detail, 8.20-megapixel CMOS sensor. The camera has nine high-precision AF points, and it is compatible with all Canon EF lenses (including the EF-S lenses). Designed for quick shooting at all times, the camera has many features for all types of shooting from fully automatic snapshotting to creative work.

Before using the camera, try it out while reading this Instruction Manual to familiarize yourself with camera operations.

To prevent accidents and damage, read the Safety Warnings (p.8,9) and Handling Precautions (p.10,11).

Test the Camera Before Using

Before using the camera, take a few test shots and check that the images are properly recorded on the memory card.

If the camera or memory card is faulty and the images cannot be recorded or read by a personal computer, Canon cannot be held liable for any loss or inconvenience caused.

Copyrights

Copyright laws in your country may prohibit the use of your recorded images of people and certain subjects for anything but private enjoyment. Also be aware that certain public performances, exhibitions, etc., may prohibit photography even for private enjoyment.

- Canon and EOS are trademarks of Canon Inc.
- Adobe and Photoshop are trademarks of Adobe Systems Incorporated.
- CompactFlash is a trademark of SanDisk Corporation.
- Windows is a trademark or registered trademark of Microsoft Corporation in the United States and other countries.
- Macintosh is a registered trademark of Apple Corporation in the United States and other countries.
- All other corporate names and trademarks mentioned in this manual are the property of their respective owners.

* This digital camera supports Design rule for Camera File System 2.0 and Exif 2.21 (also called "Exif Print"). Exif Print is a standard that enhances compatibility between digital cameras and printers. By connecting to an Exif Print-compliant printer, the shooting information is incorporated to optimize the print output.

Item Check List

Check that all the following items have been included with your camera. If anything is missing, contact your dealer.

- EOS 30D** / Camera body (with Eyecup, body cap and lithium backup battery for the date and time)
 - EF-S18-55mm f/3.5-5.6 II** / Lens (with lens cap and dust cap) * Lens kit only.
 - Battery Pack BP-511A** (with protective cover)
 - Battery Charger CG-580/CB-5L** * CG-580 or CB-5L is included.
 - Power code for battery charger** * For CB-5L.
 - Interface Cable IFC-400PCU**
 - Video Cable VC-100**
 - Wide Strap EW-100DGR** (with eyepiece cover)
-

- EOS DIGITAL Solution Disk** (CD-ROM)
 - Software Instruction Manual** (CD-ROM, PDF)
-

Pocket Guide

Quick start guide to shooting.

- EOS 30D INSTRUCTION MANUAL** (this booklet)
- Software Guide**

Gives an overview of the bundled software and explains the software installation procedure.

- Warranty card of camera**
 - Warranty card of lens** * Lens Kit only.
-

* Be careful not to lose any of the above items.

* **No CF card (for recording images) is included.** Please purchase it separately.

Contents

Introduction	
Item Check List.....	3
Contents at a Glance.....	6
Handling Precautions.....	10
Quick Start Guide.....	12
Nomenclature.....	14
Conventions Used in this Manual.....	20
1 Getting Started	21
Recharging the Battery.....	22
Installing and Removing the Battery.....	24
Using a Household Power Outlet.....	26
Mounting and Detaching a Lens.....	27
Installing and Removing the CF Card.....	28
Basic Operation.....	30
Menu Operations.....	33
Setting the Language.....	38
Setting the Date and Time.....	39
Replacing the Date/Time Battery.....	40
Cleaning the CMOS sensor.....	41
Set the power-off time/Auto power off.....	43
CF Card Reminder.....	43
Dioptric Adjustment.....	44
Holding the Camera.....	44
2 Fully Automatic Shooting	45
Using Full Auto.....	46
Basic Zone Modes.....	48
Self-timer Operation.....	50
3 Image Settings	51
Setting the Image-recording Quality.....	52
Setting the ISO Speed.....	55
Selecting a Picture Style.....	56
Customizing the Picture Style.....	58
Registering the Picture Style.....	61
Setting the Color Space.....	63
Setting the White Balance.....	64
Custom White Balance.....	65
Setting the Color Temperature.....	66
White Balance Correction.....	67
White Balance Auto Bracketing.....	68
File Numbering Methods.....	70
Checking Camera Settings.....	72
4 Setting the AF, Metering, and Drive Modes	73
Selecting the AF Mode.....	74



Selecting the AF Point.....	77	
Using Focus Lock.....	79	
When Autofocus Fails (Manual Focusing)	80	
Selecting the Metering Mode	81	
Selecting the Drive Mode.....	82	1
5 Advanced Operations	83	
Program AE.....	84	
Shutter-Priority AE	86	2
Aperture-Priority AE	88	
Depth of Field Preview	89	
Manual Exposure	90	3
Automatic Depth-of-Field AE.....	92	
Setting Exposure Compensation.....	93	
Auto Exposure Bracketing (AEB).....	94	
AE Lock.....	96	4
Bulb Exposures.....	97	
Mirror Lockup	98	
LCD Panel Illumination.....	99	5
Using the Eyepiece Cover.....	99	
Silencing the beeper	100	
Connecting the Remote Switch.....	100	
6 Flash Photography	101	6
Using the Built-in Flash	102	
Using EOS-Dedicated, External Speedlites	107	
Using Non-Canon Flash Units.....	108	7
7 Image Playback	109	
Setting the Image Review Time	110	
Auto Image Rotation	111	8
Setting the LCD Brightness.....	112	
Image Playback.....	113	
Single image display, Index Display, Magnified View	113 - 117	9
Jump Display, Auto playback, Rotating an Image	118 - 121	
Displaying the Images on TV	122	
Protecting Images	123	
Erasing Images	124	10
Formatting the CF Card	126	
8 Direct Printing from the Camera	127	
9 DPOF: Digital Print Order Format	149	11
10 Transferring Images to a Personal computer	157	
11 Customizing the Camera	165	12
12 Reference	175	



Contents at a Glance

Image Quality

- **Set picture effects** → p.56 (Selecting a Picture Style)

- **Set custom picture effects** → p.58
(Customizing the Picture Style)

- **Print the image to a large size** → p.52 ( L,  L, RAW)

- **Take many photos** → p.52 ( S,  S)

- **Adjust the color tone** → p.67 (WB correction)

- **Take black-and-white or sepia photos** → p.57 (Monochrome)

Focusing



- **Change the AF point** → p.77 ( Selecting the AF point)

- **Select the AF point quickly** → p.172 (C.Fn-13-1/2)

- **Photograph a still subject** → p.75 (One-Shot AF)

- **Photograph a moving subject** → p.75 (AI Servo AF)

Drive

- **Take continuous shots** → p.82 ( H,  Continuous shooting)

- **Take a picture of myself** → p.50 ( Self-timer)

Shooting and Flash

- **Shoot fully automatically** → p.45-49 (Basic Zone)

-
- **Freeze or blur the action** → p.86 (**Tv** Shutter-priority AE)

 - **Blur or the background or make everything look sharp**
→ p.88 (**Av** Aperture-priority AE)

 - **Adjust the image brightness (exposure)**
→ p.93 (Exposure compensation)

 - **Photograph fireworks** → p.97 (Bulb exposures)

 - **Photograph dark scenes** → p.101 (Flash photography)





 - **Disabling flash** → p.49 ( Flash off)
-

Image Playback and Printing

-
- **View images with the camera** → p.113 ( Playback)

 - **Erase an image** → p.124 ( Erase)

 - **Prevent accidental erasure of an image** → p.123 ( Protect)

 - **View images on TV** → p.122 (Video OUT)

 - **Print images easily** → p.127 (Direct printing)

 - **Adjust the LCD monitor brightness** → p.112 (LCD brightness)
-

Power Source

-
- **Use a household power outlet** → p.26 (AC adapter kit)

 - **Change the auto power off time** → p.43 (Auto power off)
-

Safety Warnings

Follow these safeguards and use the equipment properly to prevent injury, death, and material damage.

Preventing Serious Injury or Death

- To prevent fire, excessive heat, chemical leakage, and explosions, follow the safeguards below:
 - Do not use any batteries, power sources, and accessories not specified in this booklet. Do not use any home-made or modified batteries.
 - Do not short-circuit, disassemble, or modify the battery pack or back-up battery. Do not apply heat or apply solder to the battery pack or back-up battery. Do not expose the battery pack or back-up battery to fire or water. And do not subject the battery pack or back-up battery to strong physical shock.
 - Do not install the battery pack or back-up battery in reversed polarity (+ -). Do not mix new and old or different types of batteries.
 - Do not recharge the battery pack outside the allowable ambient temperature range of 0°C - 40°C (32°F - 104°F). Also, do not exceed the recharging time.
 - Do not insert any foreign metallic objects into the electrical contacts of the camera, accessories, connecting cables, etc.
- Keep the back-up battery away from children. If a child swallows the battery, consult a physician immediately. (Battery chemicals may harm the stomach and intestines.)
- When disposing of a battery pack or back-up battery, insulate the electrical contacts with tape to prevent contact with other metallic objects or batteries. This is to prevent fire or an explosion.
- If excessive heat, smoke, or fumes are emitted during battery pack recharging, immediately unplug the battery charger from the power outlet to stop the recharging and prevent a fire.
- If the battery pack or back-up battery leaks, changes color, deforms, or emits smoke or fumes, remove it immediately. Be careful not to get burned in the process.
- Prevent any battery leakage from contacting your eyes, skin, and clothing. It can cause blindness or skin problems. If the battery leakage contacts your eyes, skin, or clothing, flush the affected area with lots of clean water without rubbing it. See a physician immediately.
- During the recharging, keep the equipment away from the reach of children. The cord can accidentally choke the child or give an electrical shock.
- Do not leave any cords near a heat source. It can deform the cord or melt the insulation and cause a fire or electrical shock.
- Do not fire the flash at someone driving a car. It may cause an accident.
- Do not fire the flash near a person's eyes. It may impair the person's vision. When using flash to photograph an infant, keep at least 1 meter away.
- Before storing the camera or accessory when not in use, remove the battery pack and disconnect the power plug. This is to prevent electrical shock, heat generation, and fire.
- Do not use the equipment where there is flammable gas. This is to prevent an explosion or fire.

-
- If you drop the equipment and the casing breaks open to expose the internal parts, do not touch the internal parts due to the possibility of electrical shock.
 - Do not disassemble or modify the equipment. High-voltage internal parts can cause electrical shock.
 - Do not look at the sun or an extremely bright light source through the camera or lens. Doing so may damage your vision.
 - Keep the camera from the reach of small children. The neck strap can accidentally choke the child.
 - Do not store the equipment in dusty or humid places. This is to prevent fire and electrical shock.
 - Before using the camera inside an airplane or hospital, check if it is allowed. Electromagnetic waves emitted by the camera may interfere with the plane's instruments or the hospital's medical equipment.
 - To prevent fire and electrical shock, follow the safeguards below:
 - Always insert the power plug all the way in.
 - Do not handle a power plug with wet hands.
 - When unplugging a power plug, grasp and pull the plug instead of the cord.
 - Do not scratch, cut, or excessively bend the cord or put a heavy object on the cord. Also do not twist or tie the cords.
 - Do not connect too many power plugs to the same power outlet.
 - Do not use a cord whose insulation has been damaged.
 - Occasionally unplug the power plug and use a dry cloth to clean off the dust around the power outlet. If the surrounding is dusty, humid, or oily, the dust on the power outlet may become moist and short-circuit the outlet to cause a fire.
-

Preventing Injury or Equipment Damage

- Do not leave equipment inside a car under the hot sun or near a heat source. The equipment may become hot and cause skin burns.
 - Do not carry the camera around while it is attached to a tripod. Doing so may cause injury. Also make sure the tripod is sturdy enough to support the camera and lens.
 - Do not leave a lens or lens-attached camera under the sun without the lens cap attached. Otherwise, the lens may concentrate the sun's rays and cause a fire.
 - Do not cover or wrap the battery-recharging apparatus with a cloth. Doing so may trap heat within and cause the casing to deform or catch fire.
 - If you drop the camera in water or if water or metal fragments enter inside the camera, promptly remove the battery pack and back-up battery. This is to prevent fire and electrical shock.
 - Do not use or leave the battery pack or back-up battery in a hot environment. Doing so may cause battery leakage or a shorter battery life. The battery pack or back-up battery can also become hot and cause skin burns.
 - Do not use paint thinner, benzene, or other organic solvents to clean the equipment. Doing so may cause fire or a health hazard.
-

If the product does not work properly or requires repair, contact your dealer or your nearest Canon Service Center.

Handling Precautions

Camera Care

- This camera is a precision instrument. Do not drop it or subject it to physical shock.
- The camera is not waterproof and cannot be used underwater. If you accidentally drop the camera into water, promptly consult your nearest Canon Service Center. Wipe off any water droplets with a dry cloth. If the camera has been exposed to salty air, wipe with a well-wrung wet cloth.
- Never leave the camera near anything having a strong magnetic field such as a magnet or electric motor. Also avoid using or leaving the camera near anything emitting strong radio waves such as a large antenna. Strong magnetic fields can cause camera misoperation or destroy image data.
- Do not leave the camera in excessive heat such as in a car in direct sunlight. High temperatures can cause the camera to malfunction.
- The camera contains precision electronic circuitry. Never attempt to disassemble the camera yourself.
- Use a blower to blow away dust on the lens, viewfinder, mirror, and focusing screen. Do not use cleaners that contain organic solvents to clean the camera body or lens. For stubborn dirt, take the camera to a Canon Service Center.
- Do not touch the camera's electrical contacts with your fingers. This is to prevent the contacts from corroding. Corroded contacts can cause camera misoperation.
- If the camera is suddenly brought in from the cold into a warm room, condensation may form on the camera and internal parts. To prevent condensation, first put the camera in a sealed plastic bag and let it adjust to the warmer temperature before taking it out of the bag.
- If condensation forms on the camera, do not use the camera. This is to avoid damaging the camera. If this occurs, remove the lens, CF card and battery from the camera, and wait until the condensation has evaporated before using the camera.
- If the camera will not be used for an extended period, remove the battery and store the camera in a cool, dry, well-ventilated location. Even while the camera is in storage, press the shutter button a few times once in a while to check that the camera is still working.
- Avoid storing the camera where there are corrosive chemicals such as a darkroom or chemical lab.
- If the camera has not been used for an extended period, test all its functions before using the camera. If you have not used the camera for some time or if there is an important shoot coming up, have the camera checked by your Canon dealer or check the camera yourself and make sure it is working properly.

LCD Panel and LCD Monitor

- Although the LCD monitor is manufactured with very high precision technology with over 99.99% active pixels, there might be a few dead pixels among the remaining 0.01% or less pixels. Dead pixels displaying only black or red, etc., are not a malfunction. They do not affect the images recorded.
- At low temperatures, the liquid-crystal display response may become slower. And at high temperatures, the display may blacken. In either case, the display will return to normal at room temperature.

CF Card

- The CF card is a precision device. Do not drop the memory card or subject it to vibration. Doing so could damage the images recorded on them.
- Do not store or use a memory card near anything having a strong magnetic field such as a TV set, speakers, or magnet. Also avoid places prone to having static electricity. Otherwise, the images recorded on the CF card might be lost.
- Do not leave memory cards in direct sunlight or near a heat source. Doing so can warp the cards and make them unusable.
- Do not spill any liquid onto the CF card.
- Always store your CF cards in a case to protect the data stored on them.
- Do not bend the card or subject it to any excessive force or physical shock.
- Do not store CF cards in hot, dusty, or humid locations.

Lens Electrical Contacts

After detaching the lens from the camera, attach the lens caps or put down the lens with the rear end up to avoid scratching the lens surface and electrical contacts.

Contacts



Quick Start Guide

1

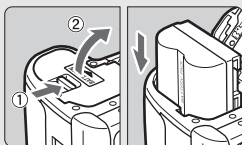

Insert the battery. (p.24)

To recharge the battery, see page 22.

2

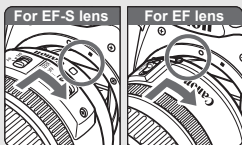

Attach the lens. (p.27)

When attaching an EF-S lens, align it with the white dot on the camera. For other lenses, align it with the red dot.

3

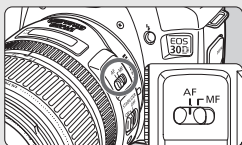

Set the lens focus mode switch to <AF>. (p.27)

4

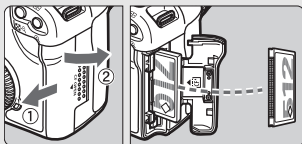

Open the cover and insert a CF card. (p.28)

Face the label side toward you and insert the end with the small holes into the camera.

5

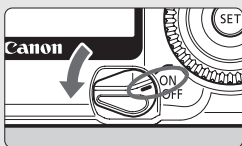

Set the power switch to <ON>. (p.30)

6



Set the Mode Dial to (Full Auto). (p.46)

All the necessary camera settings will be set automatically.

7



Focus the subject. (p.30)

Aim the AF point over the subject and press the shutter button halfway to autofocus.

8

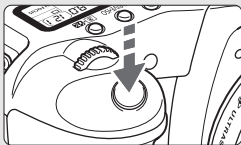

Take the picture. (p.30)

Press the shutter button completely to take the picture.

9

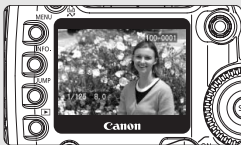

Review the picture on the LCD monitor. (p.110)

The captured image will be displayed for about 2 sec. on the LCD monitor.

- To view images captured so far, see “Image Playback” (p.113).
- To delete an image, see “Erasing Images” (p.124).

Nomenclature

For detailed information, reference page numbers are provided in parentheses (p.**).

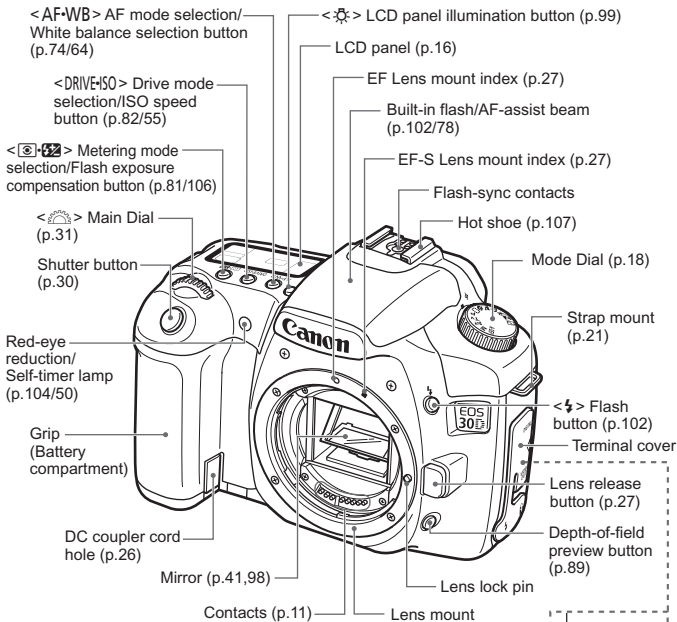

EF-S18-55mm f/3.5-5.6 II lens

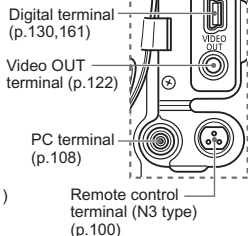
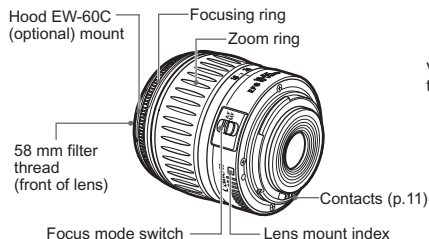

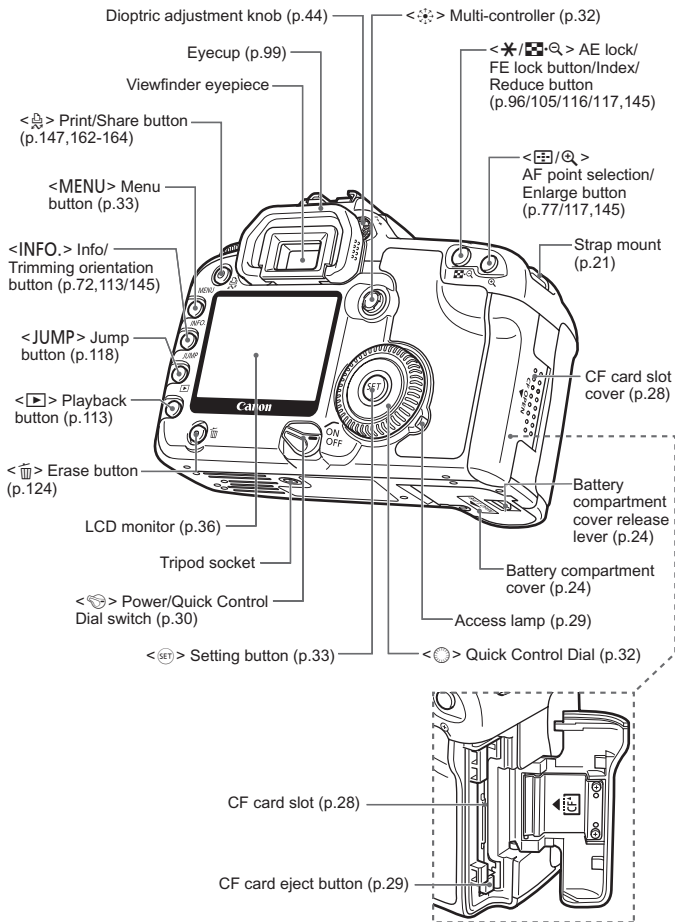

LCD Panel

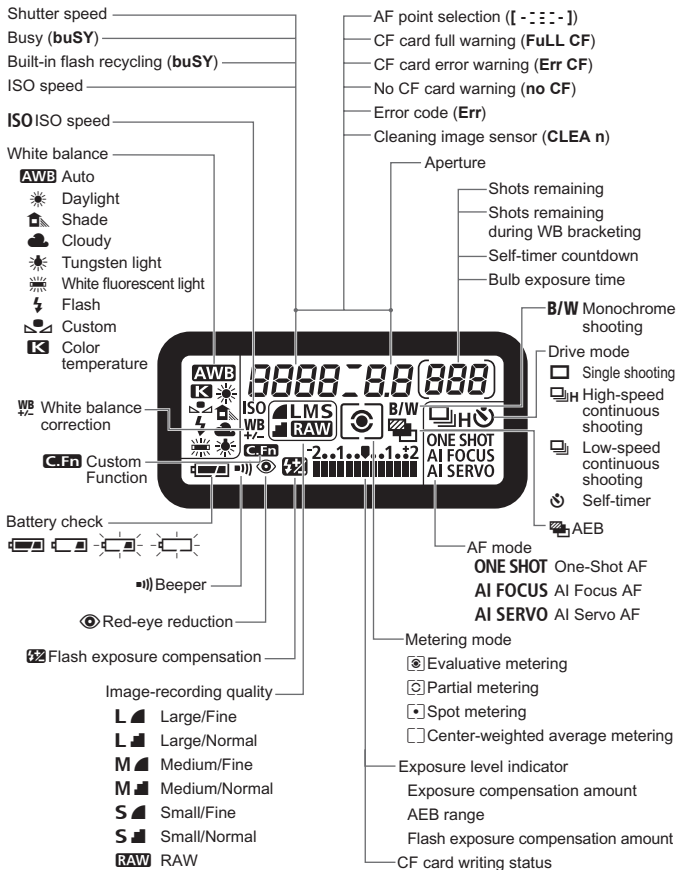

The actual display will show only the applicable items.

Viewfinder Information

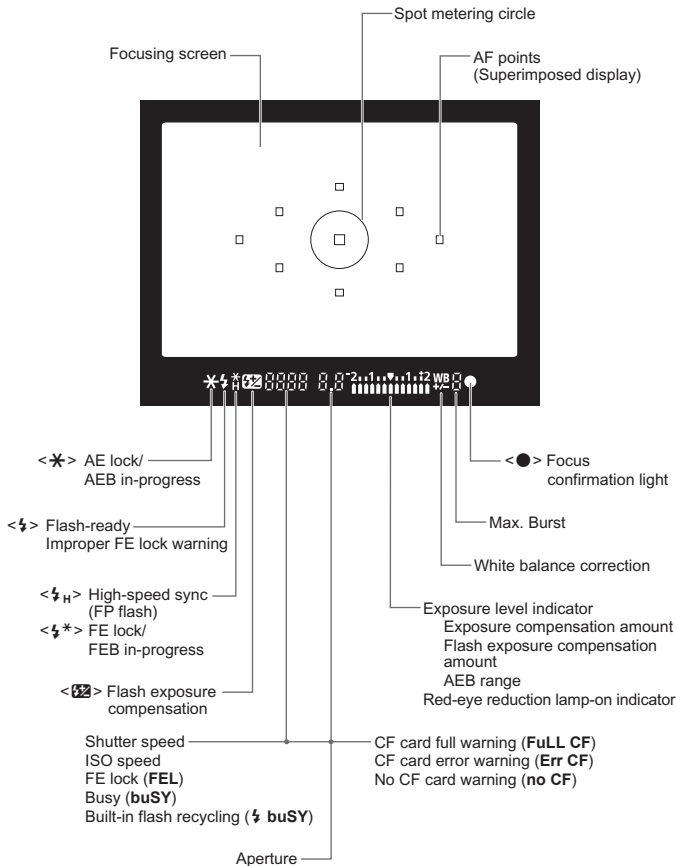

The actual display will show only the applicable items.

Mode Dial

The Mode Dial is divided into two function zones.

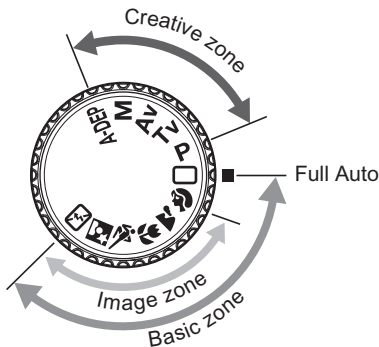

① Basic Zone

All you do is press the shutter button.

 : **Full Auto** (p.46)
For fully automatic shooting.

Image Zone

Fully automatic shooting for specific subjects.

-  : Portrait (p.48)
-  : Landscape (p.48)
-  : Close-up (p.48)
-  : Sports (p.49)
-  : Night Portrait (p.49)
-  : Flash Off (p.49)

② Creative Zone

Set the camera as you wish.

- P** : Program AE (p.84)
- Tv** : Shutter-priority AE (p.86)
- Av** : Aperture-priority AE (p.88)
- M** : Manual exposure (p.90)
- A-DEP** : Automatic Depth-of-field AE (p.92)

Battery Charger CG-580

This is a battery pack charger. (p.22)

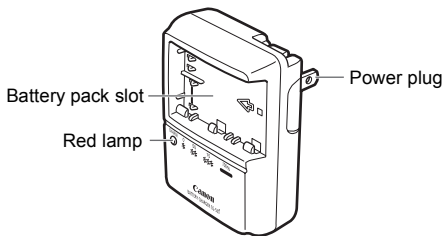
**Battery Charger CB-5L**

This is a battery pack charger. (p.26)

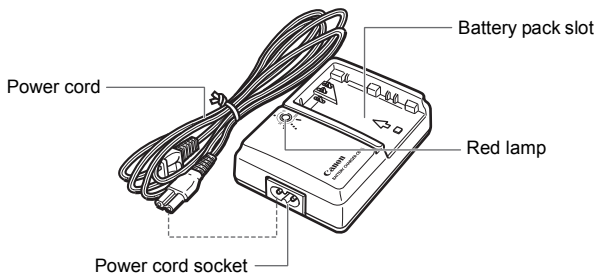

Conventions Used in this Manual



- In the text, the icon indicates the power switch.
- All operations described in this manual assume that the switch is set to <ON> or .

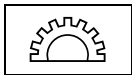

- The icon indicates the Main Dial.

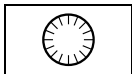

- The icon indicates the Quick Control Dial.
- Operations with the dial assume that the switch is already set to . Be sure it is set to .

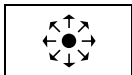



- In the text, the icon indicates the Multi-controller.



- In the text, the icon indicates the SET button. It is used for menu functions and Custom Functions.

- In this manual, the icons and markings indicating the camera's buttons, dials, and settings correspond to the icons and markings on the camera.
- For more information, reference page numbers are provided in parentheses (p.**).
- The asterisk ★ on the right of the page title indicates that the respective feature is available only in Creative Zone modes (**P**, **Tv**, **Av**, **M**, **A-DEP**).
- The Canon EF-S17-85mm f/4-5.6 IS USM lens is used as the sample lens in this Instruction Manual.
- The procedures assume that the menu settings and Custom Functions are set to the default settings.
- The **MENU** icon indicates that the setting can be changed with the menu.
- (⌚4), (⌚6) or (⌚16) indicates that the respective function remains active for 4 sec., 6 sec., or 16 sec. respectively after you let go of the button.
- This manual uses the following alert symbols:

 : The Caution symbol indicates a warning to prevent shooting problems.

 : The Note symbol gives supplemental information.

1

Getting Started

This chapter explains preliminary steps and basic camera operations.

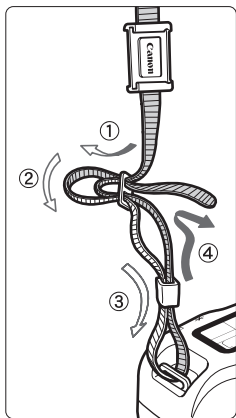

Attaching the Strap

Pass the end of the strap through the camera's strap mount from the bottom. Then pass it through the strap's buckle as shown in the illustration. Pull the strap to take up any slack and make sure the strap will not loosen from the buckle.

- The eyepiece cover is also attached to the strap. (p.99)

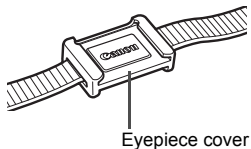

Recharging the Battery

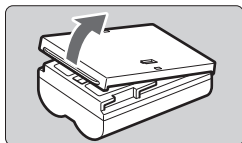

1 Remove the cover.

- When you remove the battery from the camera, be sure to reattach the cover to protect against short circuit.

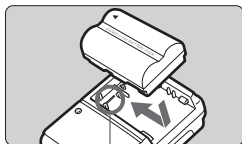

2 Attach the battery.

- Align the battery front edge with the \leftrightarrow mark (battery pack slot index) on the battery charger. While pressing down the battery, slide it in the direction of the arrow.
- To detach the battery, follow the above procedure in reverse.

Battery pack slot index

CG-580

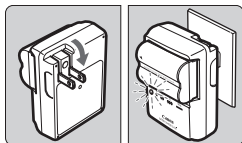

3 For CG-580 Flip out the prongs and recharge the battery.

- As shown by the arrow, flip out the battery charger's prongs.
- Insert the prongs into a power outlet.

CB-5L

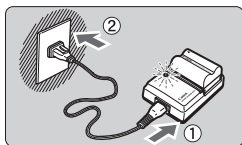

For CB-5L Connect the power cord and recharge the battery.

- Connect the power cord to the charger and insert the plug into the power outlet.
- ▶ Recharging starts automatically and the red lamp starts blinking.
- ▶ **The recharging time for a completely exhausted battery is as follows:**
BP-511A and BP-514: Approx. 100 min.
BP-511 and BP-512: Approx. 90 min.
- The numbers and markings on the battery charger correspond to the table on the left.

Recharge Level	Red lamp
0-50%	Blinks once per second
50-75%	Blinks twice per second
75-90%	Blinks three times per second
90% or higher	Lights on



- Do not recharge any battery pack other than Battery Pack BP-511A, BP-514, BP-511, or BP-512.
- If the battery is left in the camera for a prolonged period without the camera being used, a low electrical current may be discharged excessively and the battery's service life may be affected. When not using the camera, remove the battery and attach the protective cover to prevent shorting. Before using the camera again, be sure to recharge the battery.
- Storing the battery while fully charged may reduce its service life or performance.
- Battery Packs BP-511A, BP-514, BP-511, and BP-512 are dedicated to Canon products. Using them with a non-Canon battery charger or product may result in malfunction or accidents for which Canon cannot be held liable.
- Do not use the battery charger with any power transformer in foreign countries. Doing so can cause malfunction.



- **After the red lamp lights, continue to recharge the battery for an hour to attain a full charge.**
- Even a recharged, unused battery will gradually drain its power. Recharge the battery on the day before or on the day you plan to use it.
- By referring to the marking, you can attach the protective cover to the battery to indicate whether the battery has been recharged or not.
- After recharging the battery, detach it and unplug the power cord from the power outlet.
- The time required to recharge the battery depends on the ambient temperature and battery's recharge level.
- The battery pack can operate in temperatures from 0°C to 40°C (32°F to 104°F). However, for full operating performance, using it between 10°C (50°F) and 30°C (86°F) is recommended. In cold locations such as ski areas, battery performance temporarily decreases and the operating time may be shorter.
- If operating time is sharply reduced even after normal recharging, the battery pack may have reached its service life. Replace it with a new battery.
- Battery Charger CG-580/CB-5L is compatible with a 100 V AC to 240 V AC 50/60 Hz power source. Therefore, it can be used in foreign countries without a separate power transformer. You only need a plug adapter if the country uses a different type of plug.

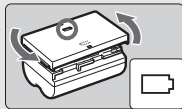

Installing and Removing the Battery

Installing the Battery

Load a fully charged BP-511A battery pack into the camera.

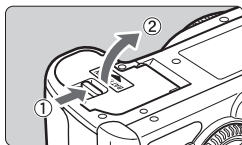

1 Open the battery compartment cover.

- Slide the lever as shown by the arrow and open the cover.

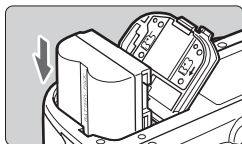

2 Insert the battery.

- Point the battery contacts downward.
- Insert the battery until it locks into place.

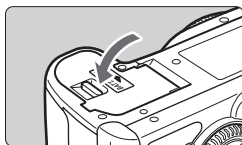



3 Close the cover.

- Press the cover until it snaps shut.

 Battery Pack BP-514, BP-511, or BP-512 can also be used.

Checking the Battery Level

When the  switch is set to <ON> or  (p.30), the battery level will be indicated at one of four levels.

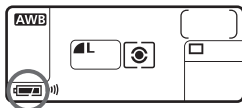

 : Battery level OK.

 : Battery level is low.

 : Battery will be exhausted soon.

 : Battery must be recharged.

Battery Life

[Number of shots · approx.]

Temperature	Shooting Conditions	
	No Flash	50% Flash Use
At 20°C / 68°F	1100	750
At 0°C / 32°F	900	600

- The figures above are based on a fully-charged BP-511A and CIPA (Camera & Imaging Products Association) testing criteria.

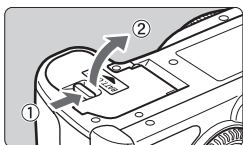

- The actual number of shots may be fewer than indicated above depending on the shooting conditions.
- The number of possible shots will decrease with more frequent use of the LCD monitor.
- Pressing the shutter button halfway for long periods or operating only the autofocus can also reduce the number of possible shots.
- The number of possible shots with the BP-514 is the same as indicated in the table.
- The number of possible shots with the BP-511 or BP-512 will be about 75% of the figures in the table for 20°C/68°F. At 0°C/32°F, the figures will be about the same as in the table.
- The lens operation is powered by the camera's battery. Using certain lenses can reduce the number of possible shots.

Removing the Battery**1 Open the battery compartment cover.**

- Slide the lever as shown by the arrow and open the cover.

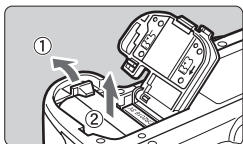
**2 Remove the battery.**

- Slide the battery lock lever as shown by the arrow and remove the battery.
- To prevent shorting, be sure to attach the protective cover to the battery.

Using a Household Power Outlet

With AC Adapter Kit ACK-E2 (optional), you can connect the camera to a household power outlet and not worry about the battery level.

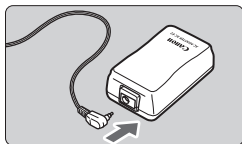

1 Connect the DC Coupler.

- Connect the DC Coupler's plug to the AC adapter's socket.

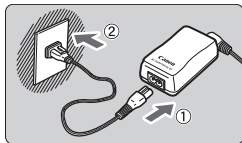

2 Connect the power cord.

- Connect the power cord to the AC adapter.
- Insert the plug into a power outlet.
- When you are finished, disconnect the plug from the power outlet.

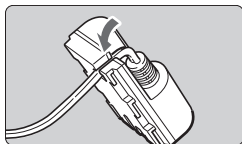

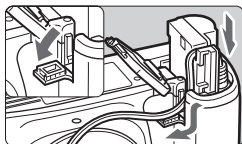

3 Place the cord in the groove.

- Insert the cord carefully without damaging the cord.



4 Insert the DC Coupler.

- Open the battery compartment cover and open the DC Coupler cord notch cover.
- Insert the DC Coupler until the lock position and put the cord through the notch.
- Close the cover.

 Do not connect or disconnect the power cord while the camera's  switch is set to <ON> or < / >.

Mounting and Detaching a Lens

Mounting a Lens

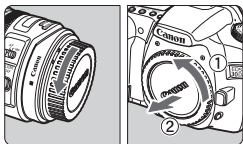

1 Remove the caps.

- Remove the rear lens cap and the body cap by turning them as shown by the arrow.

EF-S Lens mount index

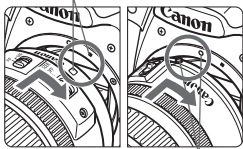

2 Attach the lens.

- Align the EF-S lens with the camera's white EF-S lens mount index and turn the lens as shown by the arrow until it clicks in place.
- When attaching a lens other than an EF-S lens, align the lens with the red EF lens index mark.

EF Lens mount index

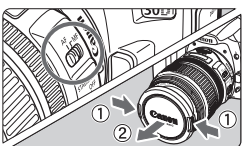

3 On the lens, set the focus mode switch to <AF>.

- If it is set to <MF>, autofocus will not be possible.

4 Remove the front lens cap.

Detaching the Lens

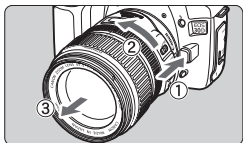

While pressing the lens release button, turn the lens as shown by the arrow.

- Turn the lens until it stops, then detach it.



When attaching or detaching the lens, take care to prevent dust from entering the camera through the lens mount.

Installing and Removing the CF Card

The captured image will be recorded onto the CF card (optional). Although the thickness is different, a Type I or Type II CF card can be inserted into the camera. The camera is also compatible with Microdrive and CF cards with 2 GB or higher capacity.

Installing the Card

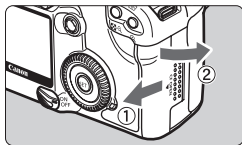

1 Open the cover.

- Slide the cover as shown by the arrow to open it.

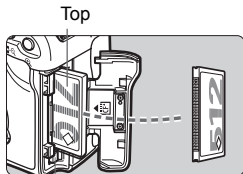

Top

CF card
eject button

2 Insert the CF card.

- If the CF card is inserted in the wrong way, it may damage the camera. As shown in the illustration, face the label side toward you and insert the end with the small holes into the camera.
- ▶ The CF card eject button pops out.

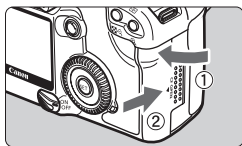

3 Close the cover.

- Close the cover and slide it in the direction shown by the arrow until it snaps shut.
- ▶ When the <ON> switch is set to <ON> or </>, the shots remaining is displayed on the LCD panel.

Shots remaining



The shots remaining depends on the remaining capacity of the CF card or the image recording quality setting, the ISO speed setting, etc.

Removing the CF Card

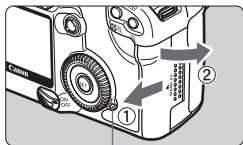

Access lamp

1 Open the cover.

- Turn the <OFF> switch to <OFF>.
- Check that the “buSY” message is not displayed on the LCD panel.
- Make sure the access lamp is off, then open the cover.

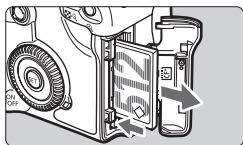

2 Remove the CF card.

- Press the Eject button.
- ▶ The CF card will be ejected.
- Close the cover.



- When the access lamp is lit or blinking, it indicates that the images are being written to or read by the CF card or being erased. While the access lamp is lit or blinking, do not do any of the following. Doing so may damage the image data, CF card, or camera.
 - Shaking or banging the camera around.
 - Open the CF card slot cover.
 - Removing the battery.
- If you use a CF card already containing recorded images, the images recorded thereafter by the camera might be appended with a file number that continues on from the images already recorded on the CF card. If you want to restart the file numbering from 0001, set [**File numbering**] to [**Manual reset**]. (p.71)
- If “Err CF” (Error CF) is displayed on the LCD panel, see page 126.
- If you use a low-capacity CF card, it might not be able to record large images.
- Compared to CF cards, Microdrive cards are more vulnerable to vibration and physical shock. If you use a Microdrive, be careful not to subject the camera to vibration or physical shock especially while recording or displaying images.



On the menu, if you set the [**Shoot w/o card**] to [**Off**], it will prevent shooting without a CF card. (p.43)

Basic Operation



Power Switch



The camera can operate only after the <  > switch is turned on.



<OFF>: The camera is turned off and does not operate.

<ON> : The camera operates.

<  > : The camera and <  > operate. (p.32)

- To save battery power, the camera turns off automatically after 1 minute of non-operation. To turn on the camera again, press the shutter button or other button.
- You can change the auto power-off time with the menu's [**↑ Auto power off**] setting. (p.43)
- If you turn the <  > switch to <OFF> while the captured images are being recorded onto the CF card, the remaining number of captured images to be recorded will be indicated on the top LCD panel with the number of <  >. When all the images are finished recording, the display will turn off and the camera will turn off.

Shutter Button

The shutter button has two steps. You can press the shutter button halfway. Then you can further press the shutter button completely.

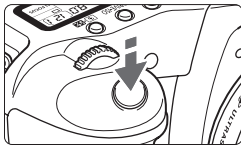

Pressing halfway

This activates autofocus (AF) and automatic exposure (AE) that sets the shutter speed and aperture.

The exposure setting (shutter speed and aperture) is displayed on the top LCD panel and in the viewfinder. ( 4)

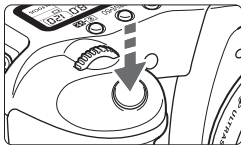

Pressing completely

This releases the shutter and takes the picture.



- If you press the shutter button halfway and (⌚4) elapse, you must press it halfway again and wait a moment before pressing it completely to take a picture. If you press the shutter button completely without pressing it halfway first or if you press the shutter button halfway and then press it completely immediately, the camera will take a moment before it takes the picture.
- Ever during image playback, menu display, or image recording, you can press the shutter button halfway to instantly return to shooting. (This does not work during direct printing or while the direct image transfer screen is displayed.)
- Camera movement during the moment of exposure is called camera shake. Camera shake can cause blurred pictures. To prevent camera shake, note the advice below. Also see “Holding the Camera” (p.44).
 - Hold the camera steady.
 - Put your finger tip on the shutter button, hold the camera with your right hand, then press the shutter button gently.

Operating the < > Main Dial

The <  > dial is mainly used for shooting-related settings.

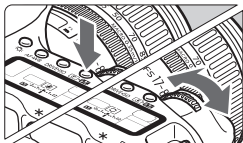

(1) After pressing a button, turn the < > dial.

When you press a button, its function remains on for 6 seconds (⌚6). While turning the <  > dial, look at the setting in the LCD panel. When the timer ends or if you press the shutter button down halfway, the camera will be ready to shoot.

- In this way, you can set the AF mode, drive mode, and metering mode and select the AF point.

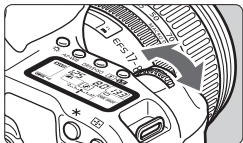

(2) Turn the < > dial only.

While looking at the LCD panel or viewfinder, turn the <  > dial to set the desired setting.

- In this way, you can set the shutter speed, aperture, etc.

Operating the <⦿> Quick Control Dial

The <⦿> dial is mainly used for shooting-related settings and selecting LCD monitor items. When you want to use the <⦿> dial, set the <⦿> switch to <↗> first.

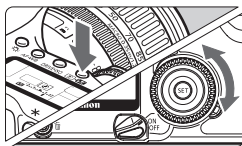

(1) After pressing a button, turn the <⦿> dial.

When the camera is ready to shoot and you press a button, the button's function remains on for 6 seconds (⦿6). While the function remains active, turn the <⦿> dial while looking at the LCD panel or viewfinder. When the function turns off or if you press the shutter button halfway, the camera will be ready to shoot.

- You can select the AF point or set the white balance, ISO speed, and flash exposure compensation.
- When using the LCD monitor, you can select menu operations and select images during playback.

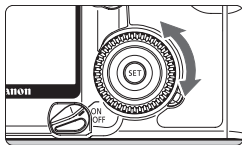

(2) Turn the <⦿> dial only.

While looking at the LCD panel or viewfinder, turn the <⦿> dial to set the desired setting.

- Use this dial to set the exposure compensation amount, the aperture setting for manual exposures, and other settings.

 You can also operate (1) when the <⦿> switch is set to <ON>.

Operating the <⦿> Multi-controller

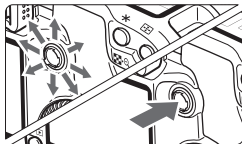

The <⦿> consists of eight direction keys and a button at the center.

- Use it to select an AF point, set white balance correction, scroll around a magnified image display, move the trimming frame for direct printing, etc.

Menu Operations

By setting various optional settings with the menu, you can set the image recording quality, Picture Style, the date/time, Custom Functions, etc. While looking at the LCD monitor, you use the <MENU> button, <SET> button, and <Q.C.D.> dial on the camera back to proceed to the next step.

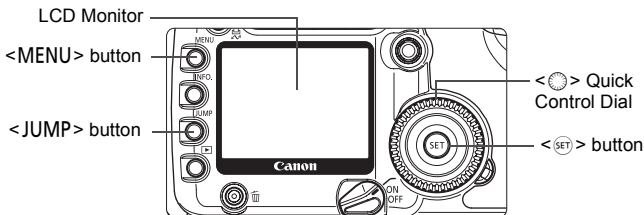

The menu screen is color coded for the three menu categories.

Icon	Color	Category	Description
	Red	Shooting menu	Shooting-related menu
	Blue	Playback menu	Image playback-related menu
	Yellow	Set-up menu	Camera's basic settings

- Press the <JUMP> button to jump to the first item of each menu category.
- You can select the menu item using the <Q.C.D.> dial even when the <ON/OFF> switch is <ON>.
- Even while the menu is displayed, you can instantly go back to shooting by pressing the shutter button halfway.

Menu Setting Procedure

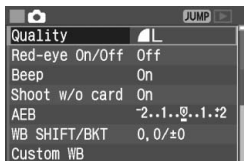

1 Display the menu.

- Press the <MENU> button to display the menu. To turn off the menu, press the button again.

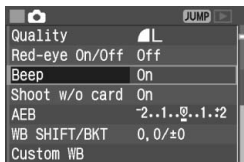

2 Select a menu item.

- Turn the <◉> dial to select the menu item, then press <SET>.
- Press the <JUMP> button to jump to the first item of each menu category.

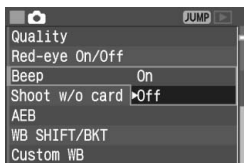

3 Select the menu setting.

- Turn the <◉> dial to select the desired setting.

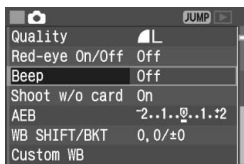

4 Set the desired setting.

- Press <SET> to set it.

5 Exit the menu.

- Press the <MENU> button to exit the menu display.

- When a Basic Zone mode is set, there are menu items which will not be displayed. (p.35, 36)
- You can also use the <◉> dial to select menu items or playback images.
- The explanation of menu functions hereinafter assumes that you pressed the <MENU> button to display the menu screen.
- Menu operation will also work after the picture is taken while the image is being recorded to the CF card (access lamp blinks).

Menu Settings

< > Shooting menu (Red)

Reference
pages

Quality	L / L / M / M / S / S / RAW / RAW+ L / + L / + M / + M / + S / + S	52
Red-eye On/Off	Off / On	104
Beep	On / Off	100
Shoot w/o card	On / Off	43
AEB	1/3-stop increments, ± 2 stops	94
WB SHIFT/BKT	WB correction: B/A/M/G bias, 9 levels each WB-BKT: B/A and M/G bias 1 level, ± 3 levels	67,68
Custom WB	Manual setting of white balance	65
Color temp.	Set to 2800K - 10000K (100K increments)	66
Color space	sRGB / Adobe RGB	63
Picture Style	Standard / Portrait / Landscape / Neutral / Faithful / Monochrome / User Def. 1, 2, 3	56-62

< > Playback menu (Blue)

Protect	Erase-protect image	123
Rotate	Rotate vertical image	121
Print order	Specify images to be printed (DPOF)	149
Transfer order	Select images to be transferred to a personal computer	158
Auto play	Auto playback of images	120
Review time	Off / 2 sec. / 4 sec. / 8 sec. / Hold	110
AF points	Not display / Display	114
Histogram	Brightness / RGB	115



- These shaded menu items are not displayed in Basic Zone modes.
- In Basic Zone modes, the RAW and RAW+JPEG recording quality modes are not displayed.

<M> Set-up menu (Yellow)

Auto power off	1min. / 2 min. / 4 min. / 8 min. / 15 min. / 30 min. / Off	43
Auto rotate	On / On / Off	111
LCD brightness	5 levels	112
Date/Time	Date/Time setting	39
File numbering	Continuous / Auto reset / Manual reset	70
Language	15 languages provided (English, German, French, Dutch, Danish, Finnish, Italian, Norwegian, Swedish, Spanish, Russian, Simplified Chinese, Traditional Chinese, Korean, and Japanese)	38
Video system	NTSC / PAL	122
Communication	Print/PC / LAN(WFT-E1)	129, 160
Format	Initialize and erase data in the CF card	126
Custom Functions (C.Fn)	Customize the camera	166
Clear settings	Clear all camera settings (Reset the camera to the default settings.)	37
	Clear all Custom Functions (Reset all Custom Function settings to the default.)	167
Sensor cleaning	Select to clean the sensor	41
Image transfer (LAN) settings	Displayed when Wireless File Transmitter WFT-E1/E1A is used	–
Firmware Ver.	Select to update the firmware	–



These shaded menu items are not displayed in Basic Zone modes.

About the LCD Monitor

- The LCD monitor cannot be used as a viewfinder for shooting.
- Adjust the LCD monitor's brightness to one of five levels with the [**M** LCD brightness] menu. (p.112)

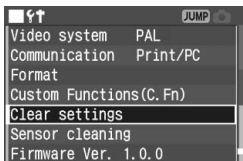
MENU Restoring the Camera's Default Settings ★**1 Select [Clear settings].**

- Turn the <⦿> dial to select [**↑↑** **Clear settings**], then press <SET>.

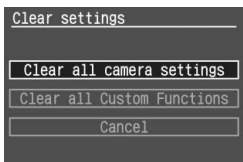
**2 Select [Clear all camera settings].**

- Turn the <⦿> dial to select [**Clear all camera settings**], then press <SET>.

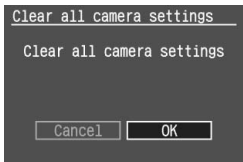
**3 Select [OK].**

- Turn the <⦿> dial to select [**OK**], then press <SET>. The default settings will be restored.
- ▶ The camera's default settings will be as shown below.

Shooting Settings

AF mode	One-Shot AF
AF point selection	Automatic AF point selection
Metering mode	Evaluative metering
Drive mode	Single shooting
Exposure compensation	0 (Zero)
AEB	Off
Flash exposure compensation	0 (Zero)
Custom Functions	Current settings retained

Image-Recording Settings

Quality	L
ISO speed	100
Picture Style	Standard
Color space	sRGB
White balance	AWB
Color temperature	5200K
WB correction	Off
WB bracketing	Off



In Basic Zone modes, the camera settings cannot be reset to the default.

MENU Setting the Language

The LCD monitor's interface language can be set to one of fifteen languages.

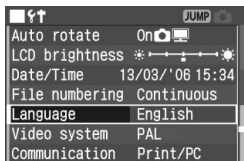

1 Select [Language].

- Turn the <⊙> dial to select [**Language**], then press <SET>.
- ▶ The Language screen will appear.



2 Set the desired language.

- Turn the <⊙> dial to select the language, then press <SET>.
- ▶ The language will change.

English	English
Deutsch	German
Français	French
Nederlands	Dutch
Dansk	Danish
Suomi	Finnish
Italiano	Italian
Norsk	Norwegian
Svenska	Swedish
Español	Spanish
Русский	Russian
简体中文	Simplified Chinese
繁體中文	Traditional Chinese
한국어	Korean
日本語	Japanese

MENU Setting the Date and Time

Set the date and time as shown below.

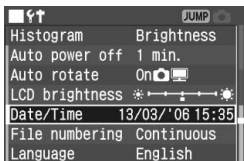

1 Select [Date/Time].

- Turn the <⦿> dial to select [**↑↑ Date/Time**], then press <SET>.
- ▶ The date/time screen will appear.

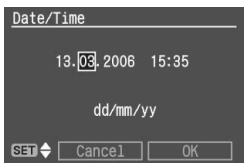

2 Set the date and time.

- Pressing the <SET> button toggles the orange box between and .
- With the box displayed, turn the <⦿> dial to select the date or time to be corrected, then press <SET>.
- With the box displayed, turn the <⦿> dial to select the correct numeral, then press <SET>.



3 Confirm the setting.

- With the box displayed, turn the <⦿> dial to select [**OK**], then press <SET>.
- ▶ The date/time will be set and the menu will reappear. The minute that was set will then start from 0 sec.

Each captured image is recorded with the date and time it was taken. If the date and time are not properly set, the wrong date/time will be recorded. Make sure you set the date and time correctly.

Replacing the Date/Time Battery

The date/time (back-up) battery maintains the camera's date and time and its service life is about 5 years. If the date/time is reset when the battery is replaced, replace the back-up battery with a new CR2016 lithium battery as described below.

The date/time setting will also be reset, so you must set the correct date/time.

1 Turn the  switch to <OFF>.

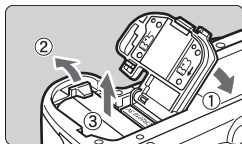

2 Remove the battery.

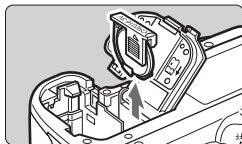

3 Take out the battery holder.

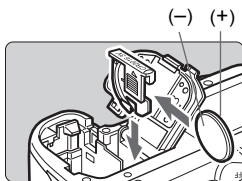

4 Replace the battery.

- Make sure the battery is in the proper + - orientation.

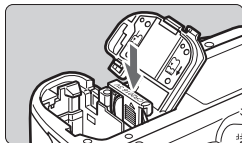

5 Insert the battery holder.

- Then load the battery and close the cover.

 For the date/time battery, be sure to use a CR2016 lithium battery.

MENU Cleaning the CMOS sensor★

The image sensor is like the film in a film camera. If any dust adheres on the image sensor, it may show up as a dark speck on the images. To avoid this, follow the procedure below to clean the image sensor. Using the AC Adapter Kit ACK-E2 (optional, see page 26, 184) is recommended. If you use a battery, make sure the battery level is sufficient. Before cleaning the sensor, detach the lens from the camera.

- 1 **Install the DC Coupler (p.26) or a battery and turn the <☺> switch to <ON>.**

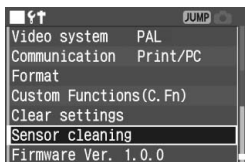

- 2 **Select [Sensor cleaning].**

- Turn the <☺> dial to select [**ft** **Sensor cleaning**], then press <SET>.
- ▶ If you are using a battery with sufficient power, the screen shown in step 3 will appear.
- If the battery is exhausted, a warning message will appear and you will not be able to proceed further. Either recharge the battery or use a DC coupler and start from step 1 again.

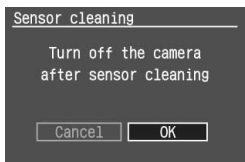

- 3 **Select [OK].**

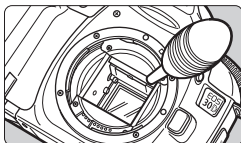

- Turn the <☺> dial to select [**OK**], then press <SET>.
- ▶ In a moment, the mirror will lockup and the shutter will open.
- ▶ “**CLEA n**” will blink on the LCD panel.





4 Clean the image sensor.

- Use a rubber blower to carefully blow away any dust, etc., on the surface of the image sensor.

5 Stop the cleaning.

- Turn the <  > switch to <OFF>.
- ▶ The camera will turn off, the shutter will close, and the mirror will go back down.
- Set the <  > switch to <ON>. The camera will then be ready to shoot.

- **During the sensor cleaning, never do any of the following that would turn off the power. If the power is cut off, the shutter will close and it may damage the shutter curtains and image sensor.**
 - Turn the <  > switch to <OFF>.
 - Open the CF card slot cover.
 - Open the battery compartment cover.
- Do not insert the blower tip inside the camera beyond the lens mount. If the power goes out, the shutter will close and the shutter curtains and image sensor may be damaged.
- Use a blower not attached with a brush. A brush can scratch the sensor.
- Never use canned air or gas to clean the sensor. The blowing force can damage the sensor or the spray gas can freeze on the sensor.
- When the battery is exhausted, the beeper will sound and the <  > icon will blink on the LCD panel. Set the <  > switch to <OFF> and replace the battery. Then start over again.
- You cannot clean the sensor if Battery Grip BG-E2 (optional) is attached to the camera and size-AA batteries supply the power. Use AC Adapter Kit ACK-E2 (optional) or use a battery having sufficient power.

If you cannot remove all of the dust, consult a Canon Service Center.

MENU Set the power-off time/Auto power off

You can set the auto power-off time for the camera to turn off automatically after a set time of idle operation. If you do not want the camera to turn off automatically, set this to [Off]. After the power turns off, you can turn on the camera again by pressing the shutter button or other button.

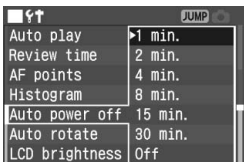

1 Select [Auto power off].

- Turn the <⦿> dial to select [**↑↑ Auto power off**], then press <SET>.

2 Set the desired time.

- Turn the <⦿> dial to select the time, then press <SET>.



When the camera has turned off by auto power off, you can turn on the camera by pressing the shutter button, <MENU> button, or <▶> button. If the shooting mode is one of the Creative Zone modes, you can also press the <★> button to wake up the camera.

MENU CF Card Reminder

This prevents shooting if there is no CF card in the camera. This can be set in all shooting modes.

1 Select [Shoot w/o card].

- Turn the <⦿> dial to select [**📷 Shoot w/o card**], then press <SET>.

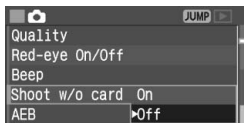

2 Select [Off].

- Turn the <⦿> dial to select [**Off**], then press <SET>.



If [Off] has been set and you press the shutter button while there is no CF card in the camera, "no CF" will be displayed in the viewfinder and LCD panel.

Dioptic Adjustment

By adjusting the diopter to suit your eyesight, you can see a sharp viewfinder image even without eyeglasses. The camera's adjustable dioptic range is -3 to +1 dpt.

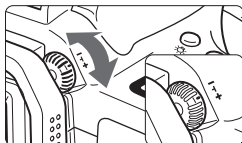

Turn the dioptic adjustment knob.

- Turn the knob left or right so that the AF points in the viewfinder look sharp.
- The illustration shows the knob at the standard setting (-1 dpt).

If the camera's dioptic adjustment still cannot provide a sharp viewfinder image, using Dioptic Adjustment Lens E (10 types, optional) is recommended.

Holding the Camera

To obtain sharp images, hold the camera still to minimize camera shake.

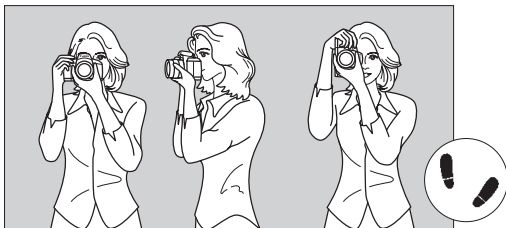

Horizontal shooting

Vertical shooting

- Firmly grasp the camera grip with your right hand, and press your both elbows lightly against your body.
- Hold the lens bottom with your left hand.
- Press the camera against your face and look through the viewfinder.
- To maintain a stable stance, place one foot in front of the other instead of lining up both feet.

2

Fully Automatic Shooting

This chapter explains how to use the Basic Zone modes on the Mode Dial for quick and easy shooting. In each mode <□> <👤> <🏔️> <🌸> <🏃> <📷> <📷>, the AF mode, metering mode, ISO speed, etc., are set automatically to suit the subject. In these modes, all you do is point and shoot. In addition, to help prevent mistakes caused by operating the camera improperly, shooting-related buttons like <AF·WB> <ISO> <📷> <📷> <📷> <📷> buttons and <📷> are disabled in these modes. So you need not worry about accidental errors.

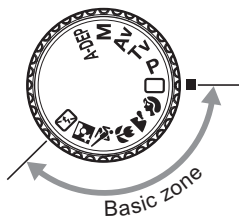

Set the Mode Dial to one of the

following modes: <□> <👤>
<🏔️> <🌸> <🏃> <📷> <📷>

- The shooting procedure is the same as for “□ Using Full Auto” (p.46).
- To see what is set automatically in the Basic Zone modes, see “Function Availability Table” (p.176)

□ Using Full Auto

All you do is point the camera and press the shutter button for quick and easy shooting. With nine AF points to focus the subject, anyone can easily take nice pictures.



1 Set the Mode Dial to <□>.

- ▶ Automatically, the AF mode will be set to <AI FOCUS>, the drive mode will be set to <□>, and the metering mode will be set to <☉>.

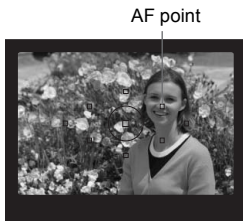

2 Aim any AF point over the subject.

- Out of the nine AF points, the one covering the closest subject is selected automatically to achieve focus.

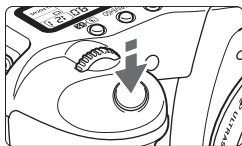

3 Focus the subject.

- Press the shutter button halfway to focus.
- ▶ The AF point which achieves focus flashes in red briefly. At the same time, the beeper will sound and the focus confirmation light <●> in the viewfinder will light.
- ▶ The shutter speed and aperture will be set automatically and displayed in the viewfinder and on the LCD panel. (☉4)
- ▶ If necessary, the built-in flash will pop-up automatically.
- ▶ Under low-light conditions, if the focus cannot be achieved with the AF, AF-assist beam is fired automatically. (p.78)

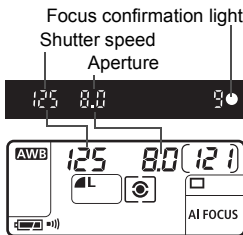

4 Check the display.

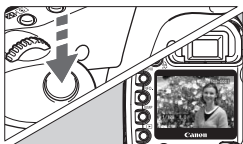

5 Take the picture.

- Compose the shot and press the shutter button completely.
- ▶ The captured image will be displayed for about 2 sec. on the LCD monitor.
- To view the images captured so far, press the <▶> button. (p.113)



- While focusing with <AF>, do not touch the focusing ring at the front of the lens.
- If you want to zoom, do it before focusing. Turning the zoom ring after achieving focus may throw off the focus.
- When the CF card becomes full, the CF Full warning “**FuLL CF**” will appear in the viewfinder and on the LCD panel and shooting will be disabled. Replace the CF card with one that has room.
- Be careful not to obstruct the built-in flash from popping up. If “**Err 05**” is displayed, set the <☞> switch to <OFF> and <ON> again.
- Using a non-Canon lens with an EOS camera may not result in proper camera or lens operation.



- When focus is achieved, the focus and exposure setting will also be locked.
- If the focus confirmation light <●> blinks, the picture cannot be taken. (p.80)
- Multiple AF points may flash simultaneously in red. This indicates that focus has been achieved at all those AF points.
- In the Basic Zone modes (except <📷> <📷> <📷>), the built-in flash will pop up and fire automatically in low-light or backlit conditions. To retract the flash, push it back down.
- In the Basic Zone modes, the Picture Style (p.56) will be set automatically for the respective Basic Zone mode. To find out which Picture Style is set for the Basic Zone mode, see the “Function Availability Table” on page 176.
- You can disable the beeper from sounding when focus is achieved. Set the [📷 Beep] menu item. (p.100)
- The image review time after image capture can be changed with the menu’s [▶ Review time] setting. (p.110)
- If you want to select the AF point to be used for focusing, set the Mode Dial to <P>, then follow “Selecting the AF Point” (p.77) to select the AF point.

Basic Zone Modes

Just select a shooting mode suiting the target subject, and you can easily obtain the best results.



Portrait



This mode blurs the background to make the human subject stand out.

- Holding down the shutter button executes continuous shooting.
- To increase the background blur, use a telephoto lens and fill the frame with the subject from the waist up. Or have the subject stand farther away from the background.
- ▶ The AF mode will be set to **<ONE SHOT>**, the drive mode will be set to **<□>**, and the metering mode will be set to **<☉>** automatically.



Landscape



This is for wide scenic views, night scenes, etc.

- Using a wide-angle lens will further enhance the depth and breadth of the image.
- ▶ The AF mode will be set to **<ONE SHOT>**, the drive mode will be set to **<□>**, and the metering mode will be set to **<☉>** automatically.



Close-up



Use this mode to take close-up shots of flowers, insects, etc.

- Focus the subject at the lens' closest focusing distance as much as possible.
- To obtain a larger magnification, use the telephoto end of a zoom lens.
- For better close-ups, an EOS-dedicated macro lens and Macro Lite (both optional) are recommended.
- ▶ The AF mode will be set to **<ONE SHOT>**, the drive mode will be set to **<□>**, and the metering mode will be set to **<☉>** automatically.



Sports



This is for fast-moving subjects when you want to freeze the action.

- The camera will first track the subject with the center AF point. Focus tracking will then continue with any of the nine AF points covering the subject.
- While you press the shutter button, focusing will continue for continuous shooting.
- Using a telephoto lens is recommended.
- When focus is achieved, the beeper will sound softly.
- ▶ The AF mode will be set to **<AI SERVO>**, the drive mode will be set to **<H>**, and the metering mode will be set to **<☉>** automatically.



Night Portrait



This mode is for shooting people outside at twilight or at night. The flash illuminates the subject and a slow sync speed captures a natural-looking exposure of the background.

- If you want to shoot a night scene without people, use the **<M>** mode instead.
- Tell the subject to keep still even after the flash fires.
- ▶ The AF mode will be set to **<ONE SHOT>**, the drive mode will be set to **<□>**, and the metering mode will be set to **<☉>** automatically.



Flash off



You can disable the flash when you do not want it to fire.

- The built-in flash or any external Speedlite will not fire.
- ▶ The AF mode will be set to **<AI FOCUS>**, the drive mode will be set to **<□>**, and the metering mode will be set to **<☉>** automatically.



In the **<M>** mode, use a tripod to prevent camera shake. In the **<M>** or **<L>** mode, if the shutter speed display blinks, be aware that camera shake may occur.

Self-timer Operation

Use the self-timer when you want to be in the picture. You can use self-timer in any Basic Zone mode or Creative Zone mode.

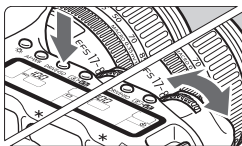

1 Press the <DRIVE+ISO> button. (Ⓞ6)

2 Select <Ⓞ>.

- While looking at the LCD panel, turn the <⚙> dial to select <Ⓞ>.



3 Focus the subject.

- Look in the viewfinder and press the shutter button halfway to check that the focus confirmation light <●> is on and the exposure setting is displayed.

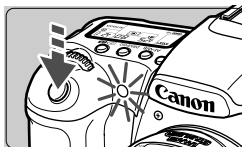

4 Take the picture.

- Look through the viewfinder and press the shutter button completely.
 - ▶ The beeper will sound, the self-timer lamp will blink, and the shot will be taken about 10 sec. later. During the first 8 sec., the beeper beeps slowly and the lamp blinks slowly. Then during the final 2 sec., the beeper beeps faster and the lamp stays lit.
 - ▶ During the self-timer operation, the LCD panel counts down the seconds until the picture is taken.

 Do not stand in front of the camera when you press the shutter button to start the self-timer. Doing so will throw off the focus.

-  Use a tripod when you use the self-timer.
- To cancel the self-timer after it starts, press the <DRIVE+ISO> button.
- When using the self-timer to shoot only yourself, use focus lock (p.79) for an object at about the same distance as where you will be.
- You can also silence the beeper. (p.100)

3

Image Settings

This chapter explains the digital image settings for the image-recording quality, ISO speed, Picture Style, white balance, and color space.

- For Basic Zone modes, only the image-recording quality (except RAW and RAW+JPEG), file numbering, and camera setting check will apply in this chapter.
- The asterisk ★ on the right of the page title indicates that the respective feature is available only in Creative Zone modes (**P**, **Tv**, **Av**, **M**, **A-DEP**).

MENU Setting the Image-recording Quality

The L / L / M / M / S / S modes record the image in the widely-used JPEG. In the **RAW** mode, the captured image will require post-processing with the software provided. The **RAW** + L / L / M / M / S / S (RAW+ JPEG) modes simultaneously record the image in both RAW and JPEG images to the CF card with a single shot. **Note that in the Basic Zone modes, RAW or RAW+JPEG cannot be set.**

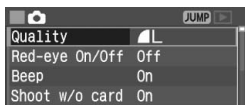

1 Select [Quality].

- Turn the < > dial to select [**Quality**], then press < >.
- The recording quality screen will appear.

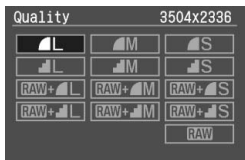

2 Set the desired recording quality.













- Turn the < > dial to select the recording quality, then press < >.
- Set the recording quality in both the Basic Zone and Creative Zone modes respectively.

Image-recording Quality Settings

Image-recording Quality	Image Type (extension)	Pixels	Print Size
L (Large/Fine)	JPEG (.JPG)	3504 x 2336 (Approx. 8.2 million)	A3 or larger
L (Large/Normal)			
M (Medium/Fine)			
M (Medium/Normal)		2544 x 1696 (Approx. 4.3 million)	A5 - A4
S (Small/Fine)		1728 x 1152 (Approx. 2.0 million)	A5 or smaller
S (Small/Normal)			
RAW (RAW)	RAW (.CR2)	3504 x 2336 (Approx. 8.2 million)	A3 or larger

- The (Fine) and (Normal) icons indicate the image's compression rate. For better image quality, select for low compression. To save space so you can record more images, select a higher compression .
- With RAW+JPEG, the RAW and JPEG images will be saved under the same file No. in the same folder.

Image File Size and CF Card Capacity According to Image-Recording Quality

Image-recording Quality	Image File Size (Approx. MB)	Possible Shots
 L	3.6	133
 L	1.8	267
 M	2.2	225
 M	1.1	442
 S	1.2	392
 S	0.6	761
RAW +  L	-	39
RAW +  L		45
RAW +  M		44
RAW +  M		49
RAW +  S		48
RAW +  S		51
RAW		8.7

- The number of possible shots and maximum burst (p.54) apply to a 512MB CF card based on Canon's testing standards.
- The single image size, number of possible shots, and maximum burst during continuous shooting are based on Canon's testing standards (ISO 100, Picture Style: [Standard]). The actual single image size, number of possible shots, and maximum burst will vary depending on the subject, shooting mode, ISO speed, Picture Style, etc.
- In the case of monochrome images (p.57), the file size will be smaller so the number of possible shots will be higher.
- On the top LCD panel, you can check the remaining number of images the CF card can record.

About the RAW











The RAW assumes that the image will undergo post-processing with a personal computer. Special knowledge is required, but you can use the bundled software to obtain the desired effect.

Image processing refers to adjusting the RAW image's white balance, contrast, etc., to create the desired image.

Note that direct printing and print ordering (DPOF) will not work with RAW images.

Maximum Burst During Continuous Shooting

The maximum burst during continuous shooting depends on the image-recording quality and the drive mode (high-speed/low-speed continuous shooting). The approx. maximum burst during continuous shooting is indicated below for each image-recording quality. Note that with high-speed CF cards, the maximum burst may be higher than shown in the table below depending on the shooting conditions.



Image-recording Quality	Maximum Burst	
	 High-speed continuous shooting	 Low-speed continuous shooting
 L	30	37
 L	55	100
 M	50	60
 M	100	165
 S	105	240
 S	220	850*
 RAW	11	11
 RAW+JPEG	9	9

* Continuous shooting is possible until the CF card becomes full.



- The number of shots remaining during the maximum burst is displayed on the lower right of the viewfinder.
- If “9” is displayed, it indicates that the maximum burst is nine or more shots. If “5” is displayed, it is five shots.
- While you are shooting and the number of shots remaining in the maximum burst is fewer than 9, the viewfinder will display “8”, “7”, etc. If you stop the continuous shooting, the maximum burst will increase.

 After all the captured images are processed and written to the CF card, the above table's figures for the maximum burst will apply.

-  With white balance bracketing (p.68), the maximum burst will be lower.
- The maximum burst is displayed even when the drive mode is set to  (Single) or . The maximum burst is displayed even when a CF card is not in the camera. Therefore, before shooting, make sure that a CF card is installed in the camera.

ISO Setting the ISO Speed ★

The ISO speed is a numeric indication of the sensitivity to light. A higher ISO speed number indicates a higher sensitivity to light. Therefore, a high ISO speed is suited for low light and moving subjects. However, the image may look more coarse with noise, etc. On the other hand, a low ISO speed is not suited for low light or action shots, but the image will look cleaner.

The camera can be set between ISO 100 and 1600 in 1/3-stop increments.

ISO Speed in the Basic Zone Modes

The ISO speed is set automatically within ISO 100-400.

ISO Speed in the Creative Zone Modes

ISO 100-1600 can be set in 1/3-stop increments. With C.Fn-08 [ISO expansion] set to [1: On] (p.170), "H" (ISO 3200) can also be set.

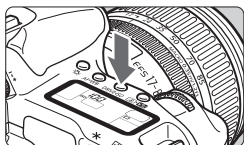

1 Press the <DRIVE·ISO> button. (ⓘ6)

- ▶ The current ISO speed will be displayed on the LCD panel.
- In a Basic Zone mode, "Auto" will be displayed on the LCD panel.

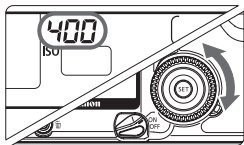

2 Setting the ISO Speed.

- While looking at the LCD panel or viewfinder, turn the <ⓘ> dial.





- At higher ISO speeds and higher ambient temperatures, the image will have more noise.
- High temperatures, high ISO speeds, or long exposures may cause irregular colors in the image.

MENU Selecting a Picture Style ★

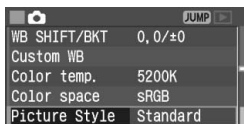
By selecting a Picture Style, you can obtain the desired image effects. You can also adjust the settings of each Picture Style to obtain custom image effects.



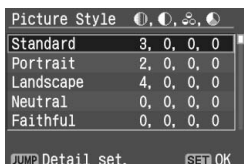

1 Select [Picture Style].

- Turn the <  > dial to select [ **Picture Style**], then press <  >.
- ▶ The Picture Style selection screen will appear.



2 Select the style.

- Turn the <  > dial to select a style, then press <  >.

Picture Style Effects

• Standard

The image looks vivid, sharp, and crisp.

• Portrait

For nice skin tones. The image looks slightly sharp and crisp. By changing the [**Color tone**] (p.57), you can adjust the skin tone.

• Landscape

For vivid blues and greens, and very sharp and crisp images.

• Neutral

For natural colors and subdued images. No sharpness is applied.

• Faithful

When the subject is photographed under a color temperature of 5200K, the color is adjusted colorimetrically to match the subject's color. No sharpness is applied.

 In the Basic Zone modes, the Picture Style will be set automatically. In the Portrait mode, the [**Portrait**] Picture Style is set. In the Landscape mode, the [**Landscape**] Picture Style is set. And in other Basic Zone modes, the [**Standard**] Picture Style is set.

• Monochrome

You can take black-and-white photos.



- To obtain natural-looking, black-and-white images, set a suitable white balance.
- JPEG black-and-white images captured with the **[Monochrome]** setting cannot be converted into color images even with image-editing software.



- RAW images captured with the **[Monochrome]** setting can be converted into color images with the bundled software.
- When **[Monochrome]** is selected, **<B/W>** will appear on the LCD panel.

• User Def. 1-3

You can register your own Picture Style settings (p.61). Any User Defined Picture Style which has not been set will have the same settings as the Standard Picture Style.

About the Picture Style selection screen

The symbols on the upper right of the Picture Style selection screen refer to the sharpness, contrast, color saturation, color tone, filter effect, and color toning.

The numerals indicate the settings for each.

Picture Style	Sharpness	Contrast	Color saturation	Color tone
Standard	3	0	0	0
Portrait	2	0	0	0
Landscape	4	0	0	0
Neutral	0	0	0	0
Faithful	0	0	0	0

Picture Style	Sharpness	Contrast	Color saturation	Color tone
Neutral	0	0	0	0
Faithful	0	0	0	0
Monochrome	3	0	N	N
User Def. 1	Standard			
User Def. 2	Standard			



Symbols

	Sharpness
	Contrast
	Color saturation
	Color tone
	Filter effect (Monochrome)
	Color toning (Monochrome)

MENU Customizing the Picture Style ★

You can customize the Picture Style by changing the individual parameters like [Sharpness] and [Contrast]. To customize [Monochrome], see page 59.

1 Select [Picture Style].

- Turn the <  > dial to select [ **Picture Style**], then press <  >.
- ▶ The Picture Style selection screen will appear.

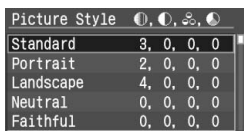

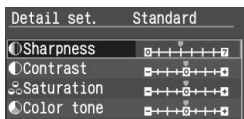

2 Select the style.

- Turn the <  > dial to select a style other than [Monochrome], then press < JUMP >.
- ▶ The setting screen will appear.





3 Select the parameter.





- Turn the <  > dial to select a parameter like [Sharpness], then press <  >.



4 Set the desired setting.

- Turn the <  > dial to set the desired setting, then press <  >.
- Press the < MENU > button to save the setting. The Picture Style selection screen will reappear.
- ▶ Any settings different from the default will be displayed in blue.

Parameters and Their Settings

 Sharpness	[0] : Less sharp outline	[+7] : Sharp outline
 Contrast	[-4] : Low contrast	[+4] : High contrast
 Color saturation	[-4] : Low saturation	[+4] : High saturation
 Color tone	[-4] : Reddish skin tone	[+4] : Yellowish skin tone

Monochrome Adjustment

For Monochrome, you can also set [Filter effect] and [Toning effect] (p.60) in addition to [Sharpness] and [Contrast].

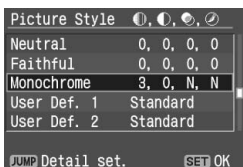

1 Select [Monochrome].

- Follow step 2 on page 56 to select [Monochrome], then press the <JUMP> button.
- ▶ The setting screen will appear.

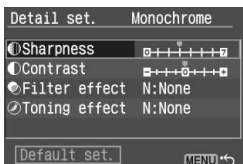

2 Select the parameter.

- Turn the <DIAL> dial to select a parameter like [Sharpness], then press <SET>.

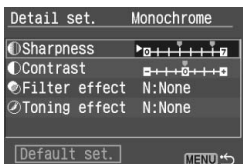

3 Set the desired setting.

- Turn the <DIAL> dial to set the desired setting, then press <SET>.
- To set the [Filter effect] or [Toning effect], see page 60.
- Press the <MENU> button to save the setting. The Picture Style selection screen will reappear.
- ▶ Any settings different from the default will be displayed in blue.



- By selecting [Default set.], you can revert the respective Picture Style to its default parameters.
- To shoot with the Picture Style you modified, follow step 2 on page 56 to select the Picture Style and then shoot.

Filter Effect

The same effect as using filters with black-and-white film can be obtained with digital images. A color can be brightened by using a filter having a similar or same color. At the same time, the complementary colors will be darkened.

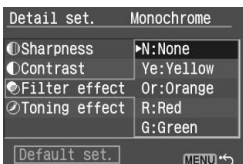

Filter	Sample effect
N: None	Normal black-and-white image with no filter effects.
Ye: Yellow	The blue sky will look more natural, and the white clouds will look clearer.
Or: Orange	The blue sky will look slightly darker. The sunset will look more brilliant.
R: Red	The blue sky will look quite dark. Fall leaves will look crisper and brighter.
G: Green	Skin tones and lips will look fine. Tree leaves will look crisper and brighter.

Setting the **[Contrast]** to the plus side will make the filter effect more pronounced.

Toning Effect

When color toning is set, color toning will be applied to the captured black-and-white image before being recorded to the CF card. It can make the image look more impressive.

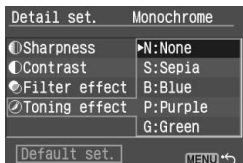



The following can be selected:

**[N:None] [S:Sepia] [B:Blue] [P:Purple]
[G:Green]**

MENU Registering the Picture Style [★]

You can select a base Picture Style such as [Portrait] or [Landscape], adjust its parameters to suit your preferences and register it in User Defined 1 to 3. You can also select a Picture Style already set with the provided software.

1 Select [Picture Style].

- Turn the <  > dial to select [ **Picture Style**], then press <  >.
- ▶ The Picture Style selection screen will appear.

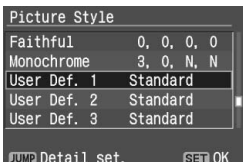

2 Select [User Def.]

- Turn the <  > dial to select [**User Def. 1/2/3**], then press < **JUMP** > button.
- ▶ The setting screen will appear.

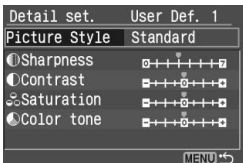



3 Press < >.

- With the [**Picture Style**] selected, press <  >.



4 Select the base Picture Style.

- Turn the <  > dial to select the base Picture Style, then press <  >.
- If you have a Picture Style already set with the provided software, select it here.

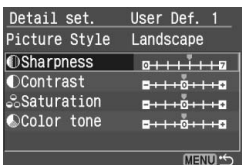

5 Select the parameter.

- Turn the <⦿> dial to select a parameter like **[Sharpness]**, then press <SET>.

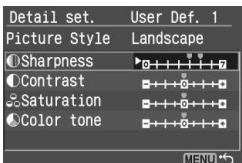

6 Set the desired setting.

- Turn the <⦿> dial to set the desired setting, then press <SET>. For details, see “Customizing the Picture Style” on pages 58-60.



- Press the <MENU> button to register the new Picture Style. The Picture Style selection screen will then reappear.
 - ▶ The base Picture Style will be displayed on the right of **[User Def. 1/2/3]**.
 - ▶ The name of the Picture Style having any modified settings (different from the default) registered in the **[User Def. 1/2/3]** will be displayed in blue.

 To shoot with the registered Picture Style, follow step 2 for selecting **[User Def. 1/2/3]** on page 56.

Changing the Picture Style setting inadvertently



If a User Defined Picture Style is already registered with your own Picture Style, following the procedure on page 61 up to step 3 for that User Defined Picture Style will revert it back to the default setting.

If you do not want to change the User Defined Picture Style, do not repeat this procedure.

MENU Setting the Color Space★



The color space refers to the range of reproducible colors. With this camera, you can set the color space for captured images to sRGB or Adobe RGB. For normal images, sRGB is recommended. In the Basic Zone modes, sRGB will be set automatically.

1 Select [Color space].

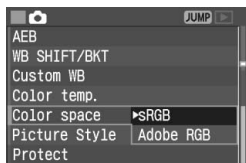
- Turn the <  > dial to select [ **Color space**], then press <  >.



2 Set the desired color space.

- Turn the <  > dial to select [**sRGB**] or [**Adobe RGB**], then press <  >.

About Adobe RGB

This is mainly used for commercial printing and other industrial uses. This setting is not recommended if you do not know about image processing, Adobe RGB, and Design rule for Camera File System 2.0 (Exif 2.21).

Since the image will look very subdued with sRGB personal computer environment and printers not compatible with Design rule for Camera File System 2.0 (Exif 2.21), post-processing of the image with software will be required.



- If the image is captured with the color space set to Adobe RGB, the file name will start with “_MG_” (first character is an underscore).
- The ICC profile is not appended. The ICC profile is explained in the Software Instruction Manual (CD-ROM).

WB Setting the White Balance [★]

Normally, the <AWB> setting will set the optimum white balance automatically. If natural-looking colors cannot be obtained with <AWB>, you can set the white balance manually to suit the respective light source. In the Basic Zone modes, <AWB> will be set automatically.

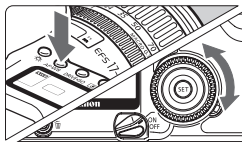

1 Press the <AF-WB> button. (ⓘ6)

2 Select the white balance setting.

- While looking at the top LCD panel, turn the <☉> dial.

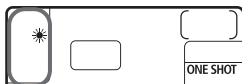

Display	Mode	Color temperature (Approx. K: Kelvin)
AWB	Auto	3000 - 7000
☉	Daylight	5200
🏠	Shade	7000
☁	Cloudy, twilight, sunset	6000
💡	Tungsten	3200
💡	White fluorescent light	4000
⚡	Flash	6000
📷	Custom*	2000 - 10000
K	Color temperature	2800 - 10000

* Set the optimum white balance manually to suit the lighting. (p.65)

About White Balance

The three RGB (red, green, and blue) primary colors exist in the light source in varying proportions depending on the color temperature. When the color temperature is high, there is more blue. And when the color temperature is low, there is more red. To the human eye, a white object looks white regardless of the type of lighting. With a digital camera, the color temperature can be adjusted with software so that the colors in the image look more natural. The subject's white color is used as the criteria for adjusting the other colors. The camera's <AWB> setting uses the CMOS sensor for auto white balance.

MENU Custom White Balance★

With custom white balance, you shoot a white object that will serve as the basis for the white balance setting. By selecting this image, you import its white balance data for the white balance setting.

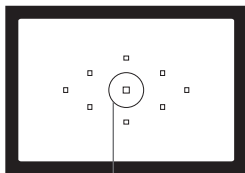

Spot metering

1 Photograph a white object.

- The plain, white object should fill the spot metering circle.
- Set the lens focus mode switch to **<MF>**, then focus manually. (p.80)
- Set any white balance setting. (p.64)
- Shoot the white object so that a standard exposure is obtained.

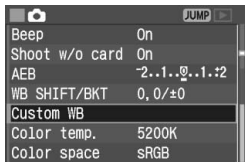

2 Select [Custom WB].

- Turn the **<DISP>** dial to select [**📷 Custom WB**], then press **<SET>**.
▶ The custom white balance screen will appear.

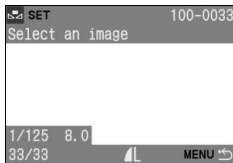

3 Select the image.

- Turn the **<DISP>** dial to select the image captured in step 1, then press **<SET>**.
▶ The image's white balance data will be imported and the menu will reappear.

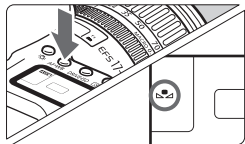

4 Press the **<AF·WB>** button. (🔍6)

- After exiting the menu, press the **<AF·WB>** button.

5 Select the custom white balance.

- While looking at the LCD panel, turn the **<DISP>** dial to select **<📷>**.

- ❗ ● If the exposure obtained in step 1 is underexposed or overexposed, a correct white balance might not be obtained.
- If an image was captured while the Picture Style was set to **[Monochrome]** (p.57), it cannot be selected in step 3.

 Instead of a white object, an 18% gray card (commercially available) can produce a more accurate white balance.

MENU Setting the Color Temperature ★

You can numerically set the white balance's color temperature.

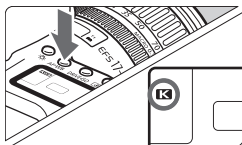

1 Press the **<AF-WB>** button. (📷)

2 Select the color temperature.

- While looking at the LCD panel, turn the **<📷>** dial to select **<K>** (color temperature).



3 On the menu, select **[Color temp.]**.

- Turn the **<📷>** dial to select **[📷 Color temp.]**, then press **<SET>**.

4 Set the color temperature.

- Turn the **<📷>** dial to select the color temperature, then press **<SET>**.
- The color temperature can be set from 2800K to 10000K in 100K increments.

- ❗ ● When setting the color temperature for an artificial light source, set white balance correction (magenta or green bias) as necessary.
- If you want to set **<K>** to the reading taken with a color temperature meter, take test shots and adjust the setting to compensate for the difference between the color temperature meter's reading and the camera's color temperature reading.

MENU White Balance Correction ★

You can correct the standard color temperature for the white balance setting. This adjustment will have the same effect as using a color temperature conversion or color compensating filter. Each color can be corrected to one of nine levels. Users familiar with using color temperature conversion or color compensating filters will find this feature handy.

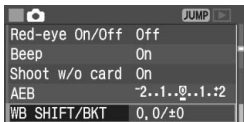

1 Select [WB SHIFT/BKT].

- Turn the <☉> dial to select [WB SHIFT/BKT], then press <SET>.
- ▶ The WB correction/WB bracketing screen will appear.



2 White Balance Correction

- Use <☉> to move the “■” to the desired position on the screen.
- B is blue, A is amber, M is magenta, and G is green. The color in the respective direction will be corrected.
- The upper right of the “SHIFT” screen will show the bias direction and correction amount.
- To cancel the white balance correction, use <☉> to move the “■” to the center so that the “SHIFT” is “0, 0”.
- Press <SET> to exit the setting and return to the menu.

Sample setting : A2, G1

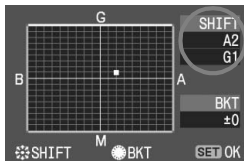

- During the white balance correction, <WB> will be displayed in the viewfinder and on the LCD panel.
- One level of the blue/amber correction is equivalent to 5 mireds of a color temperature conversion filter. (Mired: A measurement unit indicating the density of a color temperature conversion filter.)
- You can also set white balance bracketing and AEB shooting in combination with white balance correction.
- If you turn the <☉> dial in step 2, WB bracketing will be set. (p.68)

MENU White Balance Auto Bracketing★

With just one shot, three images having a different color tone can be recorded simultaneously. Based on the white balance mode's standard color temperature, the image will be bracketed with a blue/amber bias or magenta/green bias. This is called white balance bracketing. It can be set up to ± 3 levels in single-level increments.

1 Set the image-recording quality to any setting except RAW and RAW+JPEG. (p.52)

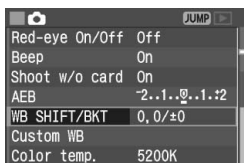

2 Select [WB SHIFT/BKT].

- Turn the $\langle \odot \rangle$ dial to select [WB SHIFT/BKT], then press $\langle \text{SET} \rangle$.
- ▶ The WB correction/WB bracketing screen will appear.

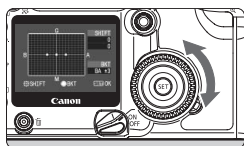

3 Set the bracketing amount.

- Turn the $\langle \odot \rangle$ dial to set the bracketing direction and bracketing level.
- When you turn the $\langle \odot \rangle$ dial, “■” on the screen will change to “■■■” (3 points). Turning the $\langle \odot \rangle$ dial to the right sets the B/A bracketing, and turning it to the left sets the M/G bracketing.
- Set the bracketing level for the B/A or M/G bias up to ± 3 levels in single-level increments. (The bracketing level cannot be set for both the B/A and M/G bias.)
- ▶ On the right side of the screen, “BKT” indicates the bracketing direction and the bracketing level is also displayed.
- Press $\langle \text{SET} \rangle$ to exit the setting and return to the menu.

B/A bias ± 3 levels

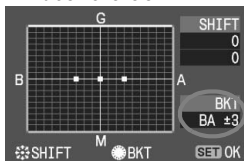

M/G bias ± 3 levels

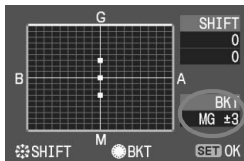

4 Take the picture.

- ▶ When B/A bracketing has been set, the three images will be recorded onto the CF card in the following sequence: Standard WB, B (blue) bias, and A (amber) bias. If M/G bracketing has been set, the sequence will be Standard WB, M (magenta) bias, and G (green) bias.
- The current drive mode (p.82) will be used for the shooting.

Canceling White Balance Auto Bracketing

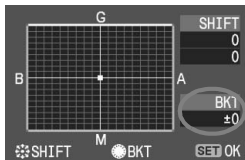

- In step 3, set “BKT” to “±0” (“■■■” to “■” (1 point)).
- White balance bracketing is also canceled automatically if you set the switch to <OFF>, replace the battery, or replace the CF card.



- White balance bracketing will not work if the image-recording quality is set to RAW or RAW+JPEG.
- With white balance bracketing, the maximum burst will be lower.



- When white balance bracketing is set, the white balance icon will blink on the LCD panel and the remaining shots will decrease to about 1/3.
- Since three images are recorded for one shot, the CF card will take longer to record the shot.
- You can also set white balance correction and AEB shooting in combination with white balance bracketing. If you set AEB in combination with white balance bracketing, a total of nine images will be recorded for a single shot.
- “BKT” stands for bracketing.

MENU File Numbering Methods

The file number is like the frame number on a roll of film. It can start counting in one of three different ways: [**Continuous**], [**Auto reset**], and [**Manual reset**]. The images you take are automatically assigned a file number from 0001 to 9999 and saved in a folder that can hold up to 9999 images. The folders will be automatically numbered from 100 to 999.

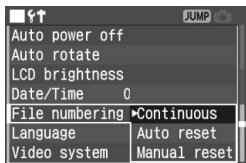

1 Select [File numbering].

- Turn the <◉> dial to select [**File numbering**], then press <SET>.

2 Select the file numbering method.

- Turn the <◉> dial to select [**Continuous**], [**Auto reset**], or [**Manual reset**], then press <SET>.

Continuous

Even after you replace the CF card, the file numbering will continue in sequence from the last image taken. (The folder number is also retained.) Since this prevents having identical file numbers, it is effective for managing images in the same folder with a personal computer.

Note that if the replacement CF card contains images recorded previously, the camera will compare the number of the folder where it saved the last image and the highest numbered folder in the replacement card. It will save new images to the folder having the higher number, and the file number will follow the highest file number in that folder.

File numbering after changing the CF card



Next sequential file number

Auto Reset

When the CF card is replaced with a newly-formatted CF card, the folder numbering and file numbering will restart from the beginning (**100-0001**). It will start from folder number **100** and file number **0001**. This is convenient when you want to organize images according to CF cards. If the replacement CF card contains images recorded previously, the file numbering will follow the highest file number (in the highest numbered folder) in that CF card.

File numbering after changing the CF card

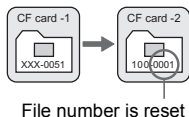

Manual Reset

This creates a new folder automatically numbered with the next higher number, and the file number restarts from **0001**. Images captured thereafter are saved in this new folder.

The file numbering method (Auto reset or Continuous) that was in effect before the manual reset will continue to take effect.

 If folder No. 999 is created, [**Folder number full**] will appear on the LCD monitor. Then if file No. 9999 is created, “**Err CF**” will be displayed on the LCD panel and in the viewfinder. Replace the CF card with a new one.

- 
- If the folder contains file number 9999, a new folder will be created automatically when the next image is captured. The image will then be saved in the new folder as file number 0001.
 - For both JPEG and RAW images, the file name will start with “IMG_”. The extension will be “.JPG” for JPEG images and “.CR2” for RAW images.

INFO. Checking Camera Settings

When the camera is ready to shoot, press the <INFO.> button to view the current camera settings on the LCD monitor.



Display the camera settings.

- Press the <INFO.> button.
- ▶ The current camera settings appear on the LCD monitor.
- To turn off the settings display, press the <INFO.> button again.

Camera Setting Display

Date/Time	13/03/'06 16:02	Date/Time (p.39)
Picture Style	Standard	Picture Style (p.56)
Detail	0, 0, 0, 0	
Color space	sRGB	Color space (p.63)
WB SHIFT/BKT	0, 0/±0	WB correction (p.67)/ WB bracketing (p.68)
1 min.	On	
±0	5200 K	Color temperature setting (p.66)
488 MB available	ISO 100	ISO speed (p.55)

- Auto rotate display (p.111)
- Transfer failed images (with WFT-E1/E1A)
- CF card remaining capacity
- Flash exposure compensation (p.106)
- Auto power off (p.43)

For details on the image info. during playback, see “Shooting Information Display” (p.114).

4

Setting the AF, Metering, and Drive Modes

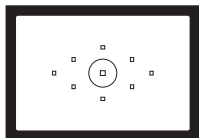

The viewfinder has 9 AF points. By selecting a suitable AF point, you can shoot with autofocus while framing the subject as desired. You can also set the AF mode to suit the subject or obtain the desired effect.

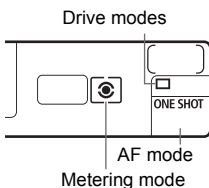

Evaluative, partial, spot, and center-weighted average metering modes are provided. Single, high-speed continuous, low-speed continuous, and self-timer drive modes are provided. Select the metering mode that suits the subject or your photographic intention.

- The asterisk ★ on the right of the page title indicates that the respective feature is available only in Creative Zone modes (**P**, **Tv**, **Av**, **M**, **A-DEP**).
- In the Basic Zone modes, the AF mode, AF point selection, metering mode, and drive mode are set automatically.

AF Selecting the AF Mode [★]

The AF mode is the autofocus operation method. Three AF modes are provided. One-Shot AF is suited for still subjects, while AI Servo AF is for moving subjects. And AI Focus AF switches from One-Shot AF to AI Servo AF automatically if the still subject starts moving. In the Basic Zone modes, the optimum AF mode is set automatically.

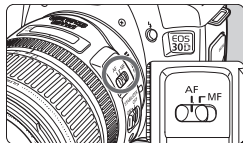

1 On the lens, set the focus mode switch to <AF>.

2 Set the Mode Dial to a Creative Zone mode.

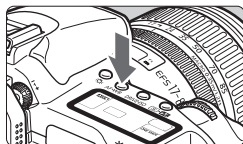

3 Press the <AF·WB> button. (ⓘ6)

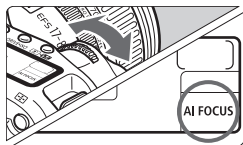

4 Select the AF mode.

- While looking at the LCD panel, turn the <MENU> dial.

ONE SHOT : One-Shot AF

AI FOCUS : AI Focus AF

AI SERVO : AI Servo AF

! If an Extender (optional) is attached and the maximum aperture of the lens is f/5.6 or smaller, AF will not be possible. For details, see the Extender's instruction manual.

! <AF> stands for auto focus. <MF> stands for manual focus.

One-Shot AF for Still Subjects



AF point Focus confirmation light

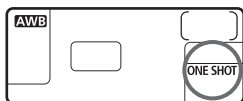

Pressing the shutter button halfway activates the autofocus and achieves focus once.

- ▶ The AF point which achieves focus flashes briefly. At the same time, the focus confirmation light <●> in the viewfinder is displayed.
- ▶ With evaluative metering, the exposure setting (shutter speed and aperture) will be set when focus is achieved. The exposure setting and focus will be locked as long as the shutter button is pressed halfway. (p.79) You can then recompose the shot while retaining the exposure setting and point of focus.



If focus cannot be achieved, the focus confirmation light <●> in the viewfinder will blink. If this occurs, a picture cannot be taken even if the shutter button is pressed completely. Recompose the picture and try to focus again. Or see “When Autofocus Fails (Manual Focusing)” (p.80).

AI Servo AF for Moving Subjects

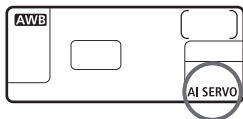

While you press the shutter button halfway, the camera focuses continuously.

- This AF mode is for moving subjects when the focusing distance keeps changing.
- ▶ With predictive AF (p.76), the camera can also focus track a subject which steadily approaches or retreats from the camera.
- ▶ The exposure is set at the moment the picture is taken.



In a Creative Zone mode (except <A-DEP>), the beeper will not sound even when focus is achieved. Also, the focus confirmation light <●> in the viewfinder will not light.

About Predictive AF

If the subject approaches or retreats from the camera at a constant rate, the camera tracks the subject and predicts the focusing distance immediately before the picture is taken. This is for obtaining correct focus at the moment of exposure.

- When the AF point selection is automatic, the camera first uses the center AF point to focus. During autofocusing, if the subject moves away from the center AF point, focus tracking continues as long as the subject is covered by another AF point.
- With a manually selected AF point, the selected AF point will focus track the subject.

AI Focus AF for Automatic Switching of AF Mode

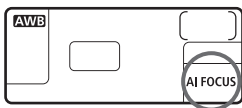

AI Focus AF switches the AF mode from One-Shot AF to AI Servo AF automatically if the still subject starts moving.

After the subject is focused in the One-Shot AF mode, if the subject starts moving, the camera will detect the movement and change the AF mode automatically to AI Servo AF.

 When focus is achieved in the AI Focus AF mode with the Servo mode active, the beeper will sound softly. The focus confirmation light <●> in the viewfinder will not light.

Selecting the AF Point ★

The AF point is used for focusing. The AF point can be selected automatically by the camera or manually by you.

In Basic Zone modes and the **<A-DEP>** mode, the AF point is selected automatically. In the **<P>** **<Tv>** **<Av>** **<M>** modes, you can switch between automatic and manual AF point selection.

Automatic AF point selection

The camera selects the AF point automatically according to the shooting conditions. **All the AF points in the viewfinder will light in red.**

Manual AF Point Selection

You can select any of the nine AF points manually. This is best when you want to focus on a particular subject, or autofocus quickly while composing the shot.

Selecting with the Multi-controller

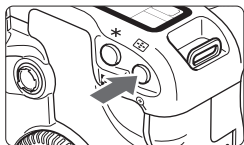



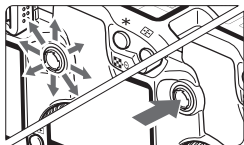

1 Press the button. (6)

- ▶ The selected AF point will be displayed in the viewfinder and on the LCD panel.





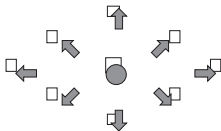

2 Select the AF point.

- While looking at the viewfinder or LCD panel, use .
- The AF point in the direction where you press the  will be selected.
- If you press  straight down, the center AF point will be selected.
- If you push the  in the same direction as the currently-selected AF point, all the AF points will light and automatic AF point selection will be set.

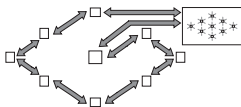

Selecting with the Dial







- Press the  button, then turn the  dial or  dial to select the AF point in the looping sequence shown on the left.

- When looking at the LCD panel to select the AF point, note the following: Automatic selection [- - - - -], center [- -], right [- -], top [- -]
- If focus cannot be achieved with an EOS-dedicated, external Speedlite's AF-assist beam, select the center AF point.

About AF-Assist beam with the Built-in Flash

Under low-light conditions, when you press the shutter button halfway, the built-in flash fires a brief burst of flashes. It illuminates the subject to enable easier autofocusing.

- In the  <  > <  > modes, the AF-assist beam does not light.
- The built-in flash's AF-assist beam is effective up to about 4 meters/13.2 feet.
- In the Creative Zone modes when you pop-up the built-in flash with the  button, the AF-assist beam will be fired when necessary.

Lens' Maximum Aperture and AF Sensitivity

The EOS 30D's AF sensor has nine AF points. The center AF point is a high-precision, cross-type sensor sensitive to both vertical and horizontal lines of the subject. The top and bottom AF points are vertical line-sensitive, and the remaining six AF points are horizontal line-sensitive AF points.

With f/2.8 and faster lenses,* the vertical line-sensitive sensor at the center AF point will also function to attain high-precision focusing.

* Except with the EF28-80mm f/2.8-4L USM and EF50mm f/2.5 Compact Macro lenses.

Using Focus Lock

After achieving focus, you can lock the focus on a subject and recompose the shot. This is called “focus lock.” Focus lock works only in the One-Shot AF mode.

- 1 **Set the Mode Dial to a Creative Zone mode.**
- 2 **Select the desired AF point. (p.77)**





- 3 **Focus the subject.**
 - Move the AF point over the subject and press the shutter button halfway.



- 4 **Keep pressing the shutter button halfway and recompose the picture as desired.**

- 5 **Take the picture.**

 If the AF mode is AI Servo AF (or AI Focus AF set to Servo mode), focus lock will not work.

 Focus lock is also possible in Basic Zone modes (except). In this case, start from step 3.

When Autofocus Fails (Manual Focusing) ■

Autofocus can fail to achieve focus (the focus confirmation light <●> blinks) with certain subjects such as the following:

Subjects difficult to focus

- (a) Low-contrast subjects
Example: Blue sky, solid-color walls, etc.
- (b) Subjects in low light
- (c) Extremely backlit and reflective subjects
Example: Car with a reflective body, etc.
- (d) Overlapping near and far objects
Example: Animal in a cage, etc.
- (e) Repetitive patterns
Example: Skyscraper windows, computer keyboards, etc.

In such cases, do one of the following:

- (1) Focus an object at the same distance as the subject and lock the focus before recomposing.
- (2) Set the lens focus mode switch to <MF> and focus manually.

Manual Focusing

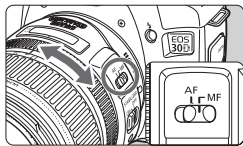

Focusing ring

1 On the lens, set the focus mode switch to <MF>.

2 Focus the subject.

- Focus by turning the lens focusing ring until the subject is in focus in the viewfinder.

 If you press the shutter button halfway during manual focusing, the active AF point and the focus confirmation light <●> in the viewfinder will light when focus is achieved.

Selecting the Metering Mode ★

Four metering modes are provided: Evaluative, partial, spot, and center-weighted average metering. In the Basic Zone modes, evaluative metering will be set automatically.

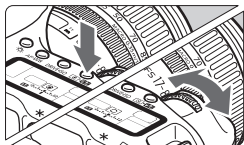

1 Press the   button. (6)

2 Select the metering mode.

- While looking at the LCD panel, turn the  dial.

 : **Evaluative metering**

 : **Partial metering**

 : **Spot metering**

 : **Center-weighted average metering**

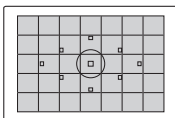
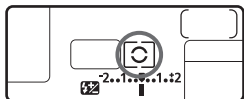

 **Evaluative metering**

This is the camera's standard metering mode suited for most subjects even under backlit conditions. After detecting the main subject's position, brightness, background, front and back lighting, etc., the camera sets the proper exposure.

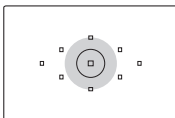

 **Partial metering**

Effective when the background is much brighter than the subject due to backlighting, etc. Partial metering covers about 9% of the viewfinder area at the center. The area covered by partial metering is shown on the left.

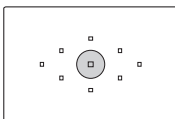

 **Spot metering**

This is for metering a specific part of the subject or scene. The metering is weighted at the center covering about 3.5% of the viewfinder area. The area covered by spot metering is shown on the left.

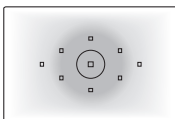

 **Center-weighted average metering**

The metering is weighted at the center and then averaged for the entire scene.

Selecting the Drive Mode ★

Single and continuous drive modes are provided. In the Basic Zone modes, the optimum drive mode is set automatically.

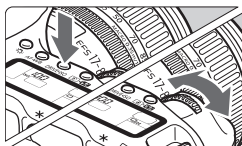

1 Press the <DRIVE•ISO> button. (Ⓞ6)

2 Select the drive mode.

- While looking at the LCD panel, turn the < > dial.





 : **Single shooting**

When you press the shutter button completely, one shot will be taken.

H : **High-speed continuous shooting** (Max. 5 shots per sec.)

 : **Low-speed continuous shooting** (Max. 3 shots per sec.)

In the H and  modes, the camera will shoot continuously while you hold down the shutter button completely.

 : **Self-timer operation** (p.50)

- During continuous shooting, the captured images are first stored in the camera's internal memory and then successively transferred to the CF card. When the internal memory becomes full during continuous shooting, "buSY" will be displayed on the LCD panel and in the viewfinder and the camera cannot take any more shots. As the captured images are transferred to the CF card, you will be able to capture more images. Press the shutter button halfway to check in the viewfinder's bottom right the current remaining shots of the maximum burst.

Maximum Burst
- If "FuLL CF" is displayed in the viewfinder and on the LCD panel, wait until the access lamp stops blinking, then replace the CF card.
- When the battery level is low, the maximum burst will be slightly lower.

5

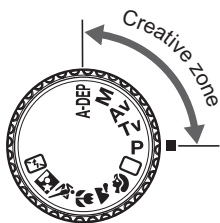
Advanced Operations



With Creative Zone modes, you can set the desired shutter speed or aperture to obtain the result you want. You take control of the camera.

- The asterisk ★ on the right of the page title indicates that the respective feature is available only in Creative Zone modes (**P**, **Tv**, **Av**, **M**, **A-DEP**).
- After you press the shutter button halfway and let go, the timer operation will keep the LCD panel and viewfinder information displayed for about 4 sec. (⌚4).
- To see what can be set in the Creative Zone modes, see “Function Availability Table” (p.176).



First set the switch to .

P Program AE



Like <□> (Full Auto) mode, this is a general-purpose shooting mode. The camera automatically sets the shutter speed and aperture to suit the subject's brightness. This is called Program AE.

* <P> stands for Program

* AE stands for Auto Exposure



1 Set the Mode Dial to <P>.

AF point

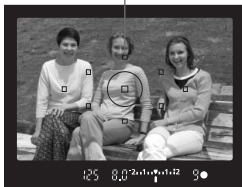

2 Focus the subject.

- Look through the viewfinder and aim any AF point over the subject. Then press the shutter button halfway.

Shutter speed
Aperture

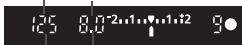

3 Check the display.

- ▶ The shutter speed and aperture will be set automatically and displayed in the viewfinder and on the LCD panel.
- A correct exposure will be obtained as long as the shutter speed and aperture display do not blink.

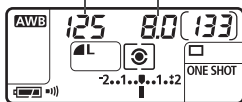

4 Take the picture.

- Compose the shot and press the shutter button completely.

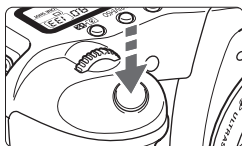

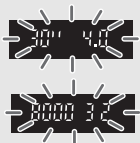

- If “30” and the maximum aperture blink, it indicates underexposure. Increase the ISO speed or use flash.
- If “8000” and the minimum aperture blink, it indicates overexposure. Decrease the ISO speed or use an ND filter (optional) to reduce the amount of light entering the lens.



Differences Between <P> and <□> (Full Auto)

- In both modes, the automatically-set shutter speed and aperture combination are the same.
- In the <P> mode, you can set or use the functions below, but not in the <□> mode.

Shooting Settings

- AF mode selection
- AF point selection
- Drive mode selection
- ISO speed setting
- Metering mode selection
- Program Shift
- Exposure compensation
- AEB
- AE lock with <★> button
- Depth-of-field preview
- Clear all camera settings
- Custom Function (C.Fn)
- Clear all Custom Functions
- Sensor cleaning

Flash Settings (Built-in flash)

- Flash On/Off
- FE lock
- Flash exposure compensation

Flash Settings (EX-series Speedlite)

- Manual/stroboscopic flash
- High-speed sync (FP flash)
- FE lock
- Flash ratio control
- Flash exposure compensation
- FEB
- 2nd-curtain sync
- Modeling flash

Image-Recording Settings

- RAW and RAW+JPEG selection
- Picture Style selection/customize/registration
- Color space selection
- White balance selection
- Custom white balance selection
- White balance correction
- WB bracketing
- Color temperature setting

About Program Shift

- In Program AE mode, you can freely change the shutter speed and aperture combination (program) set by the camera while maintaining the same exposure value. This is called program shift.
- To do this, press the shutter button down halfway, then turn the <☀> dial until the desired shutter speed or aperture is displayed.
- Program shift is canceled automatically after the image is captured.
- If you use a flash, you cannot use program shift.

Tv Shutter-Priority AE

In this mode, you set the shutter speed and the camera automatically sets the aperture to suit the brightness of the subject. This is called shutter-priority AE. A fast shutter speed can freeze the motion of a fast-moving subject and a slow shutter speed can blur the subject to give the impression of motion.

* <Tv> stands for Time value.



Fast shutter speed



Slow shutter speed



1 Set the Mode Dial to <Tv>.

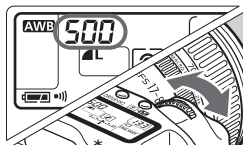

2 Set the desired shutter speed.

- While looking at the LCD panel, turn the <gear> dial.
- It can be set in 1/3-stop increments.

3 Focus the subject.

- Press the shutter button halfway.
- ▶ The aperture is set automatically.

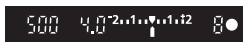

4 Check the viewfinder display and shoot.

- As long as the aperture is not blinking, the exposure will be correct.



- If the maximum aperture blinks, it indicates underexposure. Turn the dial to set a slower shutter speed until the aperture stops blinking or set a higher ISO speed.



- If the minimum aperture blinks, it indicates overexposure. Turn the dial to set a faster shutter speed until the aperture stops blinking or set a lower ISO speed.



Shutter Speed Display

The shutter speeds from “8000” to “4” indicate the denominator of the fractional shutter speed. For example, “125” indicates 1/125 sec. Also, “0”6” indicates 0.6 sec. and “15”” is 15 sec.

8000	6400	5000	4000	3200	2500	2000	1600	1250						
1000	800	640	500	400	320	250	200	160	125	100				
80	60	50	40	30	25	20	15	13	10	8	6	5	4	0'3
0'4	0'5	0'6	0'8	1'	1'3	1'6	2'	2'5	3'2	4'	5'			
6"	8"	10"	13"	15"	20"	25"	30"							

Av Aperture-Priority AE

In this mode, you set the desired aperture and the camera sets the shutter speed automatically to suit the subject brightness. This is called aperture-priority AE. A higher f/number (smaller aperture hole) will make more of the foreground and background fall within acceptable focus. On the other hand, a lower f/number (larger aperture hole) will make less of the foreground and background fall within acceptable focus.

* <Av> stands for Aperture.



With a large aperture opening



With a small aperture opening



1 Set the Mode Dial to <Av>.



2 Set the desired aperture.

- While looking at the LCD panel, turn the <gear> dial.
- It can be set in 1/3-stop increments.

3 Focus the subject.

- Press the shutter button halfway.
- ▶ The shutter speed is set automatically.

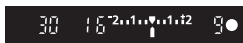

4 Check the viewfinder display and shoot.

- As long as the shutter speed is not blinking, the exposure will be correct.



- If the “30” shutter speed blinks, it indicates underexposure. Turn the  dial to set a larger aperture (smaller f/number) until the blinking stops or set a higher ISO speed.



- If the “8000” shutter speed blinks, it indicates overexposure. Turn the  dial to set a smaller aperture (larger f/number) until the blinking stops or set a lower ISO speed.



Aperture Display

The larger the f/number, the smaller the aperture opening will be. The apertures displayed will differ depending on the lens. If no lens is attached to the camera, “00” will be displayed for the aperture.

1.0	1.1	1.2	1.4	1.6	1.8	2.0	2.2	2.5	2.8	3.2	3.5	4.0
4.5	5.0	5.6	6.3	7.1	8.0	9.0	10	11	13	14	16	18
20	22	25	29	32	36	40	45	51	57	64	72	81
91												

Depth of Field Preview ★

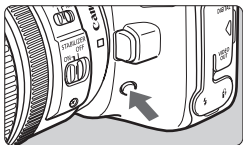

Press the depth-of-field preview button to stop down to the current aperture setting. The diaphragm in the lens will be set to the current aperture so you can check the depth of field (range of acceptable focus) through the viewfinder.



- A higher f/number will make more of the foreground and background fall within acceptable focus. However, the viewfinder will look darker.
- In the <A-DEP> mode, press the shutter button halfway to focus, then press the depth-of-field preview button while still pressing the shutter button halfway.
- The exposure is locked (AE lock) while the Depth-of-Field Preview button is pressed.

M Manual Exposure



In this mode, you set both the shutter speed and aperture as desired. To determine the exposure, refer to the exposure level indicator in the viewfinder or use a handheld exposure meter. This method is called manual exposure.

* <M> stands for Manual.



1 Set the Mode Dial to <M>.

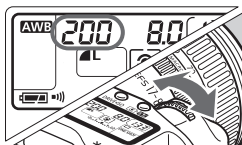

2 Set the desired shutter speed.

- While looking at the LCD panel, turn the <☀> dial.

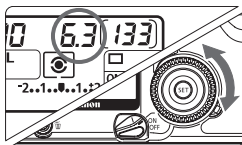

3 Set the desired aperture.

- Set the <☞> switch to <↙>, and while looking at the LCD panel, turn the <⚙> dial.

Standard exposure index

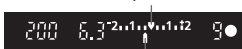

Exposure level mark

4 Focus the subject.

- Press the shutter button halfway.
- ▶ The exposure setting will be displayed in the viewfinder and on the LCD panel.
- The exposure level icon <⬆> lets you see how far you are from the standard exposure level.

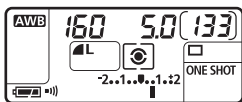

5 Set the exposure.

- Check the exposure level and set the desired shutter speed and aperture.

 : Standard exposure level.

 : To set it to the standard exposure level, set a slower shutter speed or a larger aperture.

 : To set it to the standard exposure level, set a faster shutter speed or a smaller aperture.

6 Take the picture.



If the exposure level mark  blinks at the $<+2>$ or $<-2>$ level, it indicates that the exposure level exceeds the standard exposure by ± 2 stops.

A-DEP Automatic Depth-of-Field AE

This mode is for obtaining a wide depth of field automatically between a near subject and far subject. It is effective for group photos and landscapes. The camera uses the nine AF points to detect the nearest and farthest subjects to be in focus.

* <A-DEP> stands for Auto-depth of field.



1 Set the Mode Dial to <A-DEP>.



2 Focus the subject.

- Move the AF point over the subject and press the shutter button halfway. (ⓘ4)
- All the subjects covered by the AF points flashing in red will be in focus.
- Hold down the shutter button halfway and press the depth-of-field preview button to see the depth of field (range of acceptable focus). (p.89)

3 Take the picture.

- ⓘ The <A-DEP> mode cannot be used if the lens' focus mode switch is set to <MF>. The result will be the same as using the <P> mode.
- If the "30" shutter speed blinks, it indicates that the subject is too dark. Increase the ISO speed.
- If the "8000" shutter speed blinks, it indicates that the subject is too bright. Decrease the ISO speed.

- ⓘ If the aperture blinks, it indicates that the exposure level is correct but the desired depth of field cannot be obtained. Either use a wide-angle lens or move further away from the subjects.
- In this shooting mode, you cannot freely change the shutter speed and aperture. If the camera sets a slow shutter speed, hold the camera steady or use a tripod.
- If you use flash, the result will be the same as using <P> with flash.

Setting Exposure Compensation★

Exposure compensation is used to alter the standard exposure setting set by the camera. You can make the image look lighter (increased exposure) or darker (decreased exposure). You can set the exposure compensation up to ± 2 stops in 1/3-stop increments.

1 Turn the Mode Dial to any Creative Zone mode except <M>.

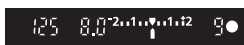

2 Check the exposure level indicator.

- Press the shutter button halfway and check the exposure level indicator.

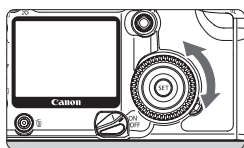

3 Set the exposure compensation amount.

- Set the <Fn> switch to <Fn>, and while looking at the viewfinder or LCD panel, turn the <Exposure Compensation> dial.
- Turn the <Exposure Compensation> dial either while pressing the shutter button halfway or within (4) after pressing the shutter button halfway.
- To cancel the exposure compensation, set the exposure compensation amount back to <0>.

Increased exposure



Decreased exposure



Standard exposure index

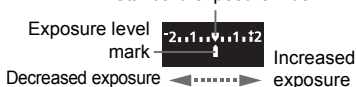

4 Take the picture.



- The exposure compensation amount will remain in effect even after the <Fn> switch is set to <OFF>.
- If the standard exposure setting is 1/125 sec. and f/8.0, setting the exposure compensation amount to plus or minus one stop will be the same as setting the shutter speed or aperture as follows:

	-1 stop ← 0 → +1 stop
Shutter speed	250 ← 125 → 60
Aperture	11 ← 8.0 → 5.6

- Take care not to turn the <Exposure Compensation> dial and change the exposure compensation inadvertently. To prevent this, turn the <Fn> switch to <ON>.

MENU Auto Exposure Bracketing (AEB)★

By changing the shutter speed or aperture automatically, the camera brackets the exposure up to ± 2 stops in 1/3-stop increments for three successive shots. This is called Auto Exposure Bracketing (AEB).



Standard exposure



Decreased exposure



Increased exposure

1 Select [AEB].

- Turn the dial to select [AEB], then press .

2 Set the AEB amount.

- Turn the dial to set the AEB amount, then press .
- ▶ When you exit the menu, and the AEB level will be displayed on the LCD panel.

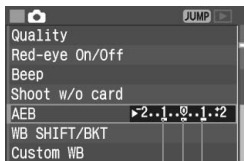

AEB amount

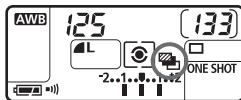

Standard exposure

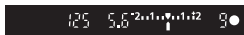

Decreased exposure

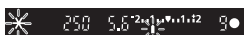

Increased exposure

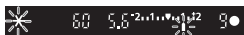

3 Take the picture.

- ▶ The three bracketed shots will be exposed in the following sequence: standard exposure, decreased exposure, and increased exposure.
- ▶ As shown on the left, the respective bracketing amount will be displayed as each bracketed shot is taken.
- ▶ The current drive mode (p.82) will be used for the shooting.

Canceling AEB

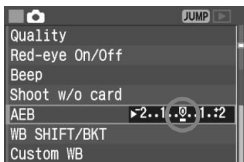

- Follow steps 1 and 2 to set the AEB amount to <▶2.1.0.1.2>.
- It will also be canceled if you set the <☞> switch to <OFF>, replace the battery, replace the CF card, change the lens, or attain flash ready.



Neither flash nor bulb exposures can be used with AEB.



- If the drive mode is set to continuous (☞H/☞), the three bracketed shots will be taken continuously and then the shooting will stop automatically. If the drive mode is set to single image (☐), you must press the shutter button three times.
- If the self-timer has been set, the three bracketed shots will be taken continuously.
- If C.Fn-12 [Mirror lockup] is set to [1:Enabled] (p.172), the drive mode for AEB will be single even if it is set to continuous.
- AEB can be combined with exposure compensation.

✳ AE Lock ✳

AE lock enables you to lock the exposure at a different place from the point of focus. By locking the exposure, you can recompose the shot while maintaining the same exposure setting. This is called AE lock. It is effective for backlit subjects.

1 Focus the subject.

- Press the shutter button halfway.
- ▶ The exposure setting will be displayed.



2 Press the <✳> button. (ⓘ4)

- ▶ <✳> lights in the viewfinder to indicate that the exposure setting is locked (AE lock).
- Each time you press the <✳> button, it locks the current exposure setting.



AE lock indicator

3 Recompose and take the picture.

- If you want to maintain the AE lock while taking more shots, hold down the <✳> button and press the shutter button to take another shot.



- If the AF mode is One-Shot AF or AI Focus AF (when not AI Servo AF) and the metering mode is <☉> (Evaluative), pressing the shutter button halfway will automatically set AE lock at the same time when focus is achieved.
- The AE lock effect will differ depending on the AF point and metering mode. For details, see “AE Lock” (p.178).

Bulb Exposures

When bulb is set, the shutter stays open while you hold down the shutter button completely, and closes when you let go of the shutter button. This is called bulb exposure. Use bulb exposures for night scenes, fireworks, the heavens, and other subjects requiring long exposures.

1 Set the Mode Dial to <M>.

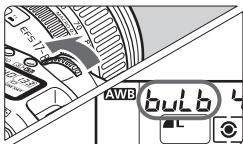

2 Set the shutter speed to "bulb."

- While looking at the LCD panel, turn the <MODE> dial to select "bulb."
- The next setting after "30" is "bulb."

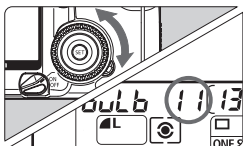

3 Set the desired aperture.

- Set the <A> switch to </>, and while looking at the LCD panel, turn the <A> dial.



4 Take the picture.

- Press the shutter button completely.
 - ▶ The elapsed exposure time will be displayed on the LCD panel. (Displays 1 sec. to 999 sec.)
- The exposure continues as long as you hold down the shutter button.

Elapsed exposure time (sec.)



Since bulb exposures may have more noise than usual, the image will look rough or grainy.



- If C.Fn-02 [Long exp. noise reduction] is set to [1: Auto] or [2: On] (p.168), noise can be reduced.
- For bulb exposures, using Remote Switch RS-80N3 or Timer Remote Controller TC-80N3 (both optional) is recommended.

Mirror Lockup★

Mirror lockup is enabled with C.Fn-12 [Mirror lockup] set to [1: Enable] (p.172). The mirror can be swung up separately from when the exposure is made. This prevents mirror vibrations which may blur the image during close-ups or when a super telephoto lens is used. Set Custom Functions with [Ft Custom Functions (C.Fn)].

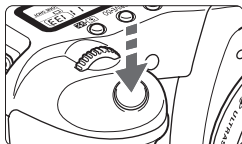

1 Press the shutter button completely.

- ▶ The mirror will swing up.

2 Again press the shutter button completely.

- ▶ The picture is taken and the mirror goes back down.



- In very bright light such as at the beach or ski area on a sunny day, take the picture promptly after mirror lockup.
- During mirror lockup, do not point the camera lens at the sun. The sun's heat can scorch and damage the shutter curtains.
- If you use bulb exposures, the self-timer, and mirror lockup in combination, keep pressing the shutter button completely (2 sec. self-timer + bulb exposure time). During the self-timer countdown, if you let go of the shutter button, there will be a shutter-release sound. This is not the shutter release (no picture is taken).

- During mirror lockup, the drive mode will be single shooting regardless of the current drive mode (single, high-speed continuous, or low-speed continuous).
- If you use the self-timer and mirror lockup, the shot will be taken 2 sec. after the mirror goes up when you press the shutter button completely.
- The mirror locks up, and after 30 seconds, it will go back down automatically. Pressing the shutter button completely again locks up the mirror again.
- For mirror lockup shots, using Remote Switch RS-80N3 or Timer Remote Controller TC-80N3 (both optional) is recommended.

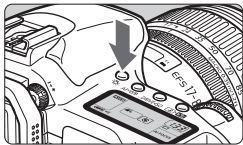
LCD Panel Illumination



The LCD panel is provided with illumination.

Each time you press the  button, the LCD panel illumination will turn on () or off. Use it to read the LCD panel in the dark. The illumination will turn off automatically after the shot is taken.



- Pressing any shooting-related button or turning the Mode Dial while the LCD panel is illuminated prolongs the illumination.
- During a bulb exposure, pressing the shutter button completely will turn off the LCD panel illumination. However, you can turn on the illumination for about 6 sec. by pressing the  button.

Using the Eyepiece Cover

During self-timer or remote switch (optional) operation when your eye does not cover the viewfinder eyepiece, stray light may enter the eyepiece and affect the exposure when the image is captured. To prevent this, use the eyepiece cover (attached to the neck strap) to cover the eyepiece (p.21).

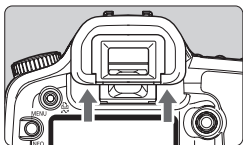

1 Remove the eyecup.

- From the bottom of the eyecup, push it upward.

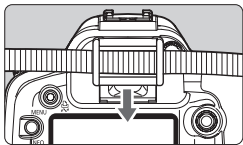



2 Attaching the Eyepiece Cover.

- Slide the eyepiece cover down into the eyepiece groove to attach it.

MENU Silencing the beeper



You can silence the beeper so it does not sound in any shooting mode.

1 Select [Beep].

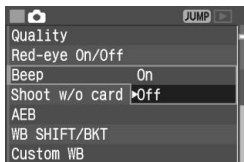
- Turn the <  > dial to select [ **Beep**], then press <  >.



2 Select [Off].

- Turn the <  > dial to select [**Off**], then press <  >.

Connecting the Remote Switch

You can attach to the camera any EOS accessory equipped with an N3 type plug such as the Remote Switch and Timer Remote Controller (both optional). To operate the accessory, refer to its instruction manual.

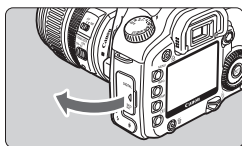

1 Open the terminal cover.

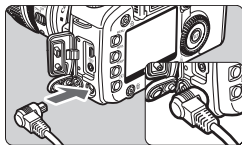

2 Connect the plug to the remote control terminal.

- As shown in the diagram, connect the plug to the camera's remote control terminal.
- To disconnect the plug, grasp the plug's silver part and pull.

6

Flash Photography

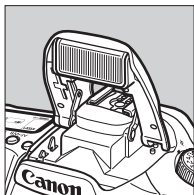

The built-in flash or an EOS-dedicated, EX-series Speedlite enables E-TTL II autofocus (evaluative flash metering with preflash), making flash photography as easy as normal shooting. The result is natural-looking flash photos. In the Basic Zone modes (except), flash photography is fully automatic. In Creative Zone modes, flash can be used whenever necessary.

Using the Built-in Flash

E-TTL II autoflash obtains high-precision and consistent flash shots.

Using the Built-in Flash in the Basic Zone

If necessary, the built-in flash will pop-up automatically in low-light or backlit conditions. (except in modes)

Using the Built-in Flash in the Creative Zone

Regardless of the light level, you can press the button to pop-up and fire the built-in flash whenever desired.

P : For fully automatic flash photography. The shutter speed (1/60 sec. - 1/250 sec.) and aperture are set automatically, just as in (Full Auto) mode.

Tv : Enables you to set the desired shutter speed (30 sec. - 1/250 sec.). The camera then automatically sets the aperture to obtain the proper exposure at the shutter speed you have set.

Av : Enables you to set the desired aperture. The camera then automatically sets the shutter speed (30 sec. - 1/250 sec.) to obtain the proper exposure at the aperture you have set.

Against dark backgrounds such as the night scenes, slow-sync shooting will be set so that both the subject and background are exposed correctly. The main subject is exposed with the flash, and the background is exposed with a slow shutter speed.

- Because automatic slow-sync shooting uses a slow shutter speed, always use a tripod.
- If you do not want a slow shutter speed to be set, set C.Fn-03 [Flash sync. speed in Av mode] to [1: 1/250sec. (fixed)]. (p.168)

M : You can set both the shutter speed (bulb or 30 sec. - 1/250 sec.) and aperture. The main subject is exposed properly by the flash. The background exposure will vary depending on the shutter speed and aperture.

A-DEP : The flash result will be the same as the mode.

Built-in Flash Range

With EF-S18-55mm f/3.5-5.6 II

[m / ft]

ISO speed	Wide angle: 18mm	Telephoto: 55mm
100	Approx. 1 - 3.7 / 3.3 - 12.1	Approx. 1 - 2.3 / 3.3 - 7.5
200	Approx. 1 - 5.3 / 3.3 - 17.4	Approx. 1 - 3.3 / 3.3 - 10.8
400	Approx. 1 - 7.4 / 3.3 - 24.3	Approx. 1 - 4.6 / 3.3 - 15.1
800	Approx. 1 - 10.5 / 3.3 - 34.4	Approx. 1 - 6.6 / 3.3 - 21.7
1600	Approx. 1 - 14.9 / 3.3 - 48.9	Approx. 1 - 9.3 / 3.3 - 30.5
H: 3200	Approx. 1 - 21.0 / 3.3 - 68.9	Approx. 1 - 13.1 / 3.3 - 43.0

With EF-S17-85mm f/4-5.6 IS USM

[m / ft]

ISO speed	Wide angle: 17mm	Telephoto: 85mm
100	Approx. 1 - 3.3 / 3.3 - 10.8	Approx. 1 - 2.3 / 3.3 - 7.5
200	Approx. 1 - 4.6 / 3.3 - 15.1	Approx. 1 - 3.3 / 3.3 - 10.8
400	Approx. 1 - 6.5 / 3.3 - 21.3	Approx. 1 - 4.6 / 3.3 - 15.1
800	Approx. 1 - 9.2 / 3.3 - 30.2	Approx. 1 - 6.6 / 3.3 - 21.7
1600	Approx. 1 - 13.0 / 3.3 - 42.7	Approx. 1 - 9.3 / 3.3 - 30.5
H: 3200	Approx. 1 - 18.4 / 3.3 - 60.4	Approx. 1 - 13.1 / 3.3 - 43.0



- Use the built-in flash at least 1 m/3.3 ft away from the subject. Closer distances will cause the lens barrel to partially obstruct the flash.
- When using the built-in flash, detach any hood attached to the lens. A lens hood will partially obstruct the flash.
- A super telephoto lens or fast, large-aperture lens may partially obstruct the built-in flash coverage. In such a case, using an EX-series Speedlite (optional) is recommended.
- The built-in flash's coverage is effective with lens focal lengths as short as 17mm. If the lens is shorter than 17mm, the periphery of the flash photo will look dark.



- To retract the flash, push it back down.
- In the <Tv> <M> modes, even if you set the shutter speed to one faster than 1/250 sec., it will be set automatically to 1/250 sec.
- If autofocus cannot be achieved, the AF-assist beam (small flashes fired by the built-in flash) will be fired automatically (except in the <▲> <👁> <📷> modes). (p.78)

Using Red-eye Reduction

When flash is used in a low-light environment, the subject's eyes may look red in the image. "Red eye" happens when the light from the flash reflects off the retina of the eyes. The camera's red-eye reduction feature turns on the red-eye reduction lamp to shine a gentle light into the subject's eyes to narrow the pupil diameter or iris. A smaller pupil reduces the chances of red eye from occurring. Red-eye reduction can be set in any shooting mode except .

1 Select [Red-eye On/Off].

- Turn the dial to select [ Red-eye On/Off], then press .

2 Select [On].

- Turn the dial to select [On], then press .
- When you exit the menu, will be displayed on the LCD panel.

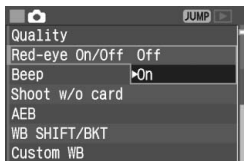

- When you press the shutter button down halfway, the red-eye reduction lamp indicator appears in the viewfinder.
- Red-eye reduction will not be effective unless the subject looks at the red-eye reduction lamp. Tell the subject to look at the lamp.
- To increase the effectiveness of red-eye reduction, press the shutter button down completely after the red-eye reduction lamp (which lights for approximately 1.5 seconds) indicator goes off.
- You can shoot anytime by pressing the shutter button down completely, even while the red-eye reduction lamp is still on.
- The effectiveness of red-eye reduction varies from subject to subject.
- Red-eye reduction is more effective in brighter rooms or when the camera is closer to the subject.

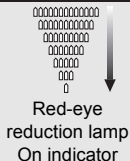
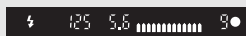

✳ FE Lock ✳

FE (flash exposure) lock obtains and locks the correct flash exposure reading for any part of a subject.

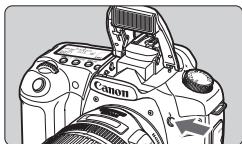

1 Check that the <⚡> icon is lit.

- Press the <⚡> button to pop-up the built-in flash.
- Press the shutter button halfway and look in the viewfinder to check that the <⚡> icon is lit.

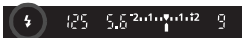

2 Focus the subject.

- Press the shutter button halfway. Keep pressing the shutter button halfway until step 4.

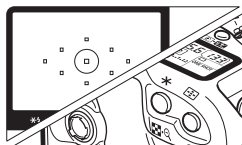

3 Press the <✳> button. (Ⓜ16)

- Aim the viewfinder center over the subject where you want to lock the flash exposure, then press the <✳> button.
 - ▶ The flash will fire a preflash and the required flash output is calculated and retained in memory.
 - ▶ In the viewfinder, "FEL" is displayed for a moment and <⚡✳> will light.
- Each time you press the <✳> button, a preflash is fired and the required flash output is calculated and retained in memory.



4 Take the picture.

- Compose the shot and press the shutter button completely.
 - ▶ The flash is fired to take the picture.



⚠ If the subject is too far away and beyond the effective range of the flash, the <⚡> icon will blink. Get closer to the subject and repeat steps 2 to 4.

Flash Exposure Compensation ★

In the same way as normal exposure compensation, you can set exposure compensation for flash. You can set flash exposure compensation up to ± 2 stops in 1/3-stop increments.

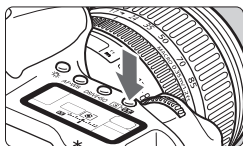

1 Press the  button. (6)

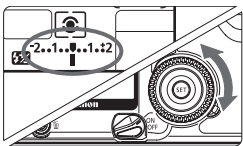



2 Set the exposure compensation amount.

- While looking at the LCD panel or viewfinder, turn the  dial.

Standard exposure index

Exposure level
mark 

Decreased exposure  Increased exposure

- To cancel the flash exposure compensation, set the flash exposure compensation amount back to .
- When you press the shutter button halfway, the  icon will be displayed in the viewfinder and on the LCD panel.

Increased exposure



Decreased exposure



3 Take the picture.

 If you set flash exposure compensation with both the EX-series Speedlite and camera, the Speedlite's flash exposure compensation setting will override the camera's. If you set EX-series Speedlite's flash exposure compensation with the flash, any flash exposure compensation set with the camera will be overridden.

- The exposure compensation amount will remain in effect even after the  switch is set to <OFF>.
- The procedure is the same when using an EX-series Speedlite. The Speedlite's flash exposure compensation can be set with the camera.

Using EOS-Dedicated, External Speedlites

With EX-series Speedlites

An EOS-dedicated, EX-series Speedlite (optional) makes flash photography as easy as normal shooting. You can easily do the flash operations below. For detailed procedures, see the Speedlite's instruction manual.

● E-TTL II Autoflash

E-TTL II is a new autoflash exposure system incorporating improved flash exposure control and lens focusing distance information, making it more precise than the previous E-TTL (evaluative flash metering with preflash) system. The camera can execute E-TTL II autoflash with any EX-series Speedlite.

● High-Speed Sync (FP flash)

With high-speed sync, you can set a sync speed faster than 1/250 sec.

● FE (Flash Exposure) Lock

Press the camera's **<★>** button to lock the flash exposure at the desired part of the subject.

● Flash Exposure Compensation

In the same way as normal exposure compensation, you can set exposure compensation for flash. With a Speedlite, the flash exposure compensation can be set up to ± 3 stops in 1/3-stop increments.

● FEB (Flash Exposure Bracketing)

The flash output is changed automatically for three successive shots (only with FEB-compatible Speedlites). Set flash exposure bracketing up to ± 3 stops in 1/3-stop increments.

During FEB shooting, the **<⚡*>** icon will blink in the viewfinder.



● E-TTL II Wireless Autoflash with Multiple Speedlites

As with wired, multiple Speedlites, wireless E-TTL II autoflash with multiple Speedlites provides all the above features. Since connection cords are unnecessary, flexible and sophisticated lighting setups are possible (only with wireless-compatible Speedlites).

About EZ/E/EG/ML/TL-series Speedlites

The flash cannot be fired with an EZ/E/EG/ML/TL-series Speedlite set in the TTL or A-TTL autoflash mode. Use the Speedlite's manual flash mode instead if provided.

- Before attaching an external Speedlite, retract the built-in flash if it is popped up.
- If the EX-series Speedlite's firing mode is set to TTL autoflash with the Custom Function, the Speedlite will not fire.

- If autofocus cannot be achieved, the external, EOS-dedicated Speedlite's AF-assist beam (if the Speedlite has an AF-assist beam) will be emitted automatically (except in the  >  modes).
- The camera is a Type-A camera that can use all the features of EX-series Speedlites.

Using Non-Canon Flash Units

Sync Speed

The camera can synchronize with compact, non-Canon flash units at 1/250 sec. or slower shutter speeds. With large studio flash, the sync speed is 1/125 sec. or slower. Be sure to test the flash unit beforehand to make sure it synchronizes properly with the camera.

PC Terminal

- The camera's PC terminal is provided for flash units having a sync cord. The PC terminal is threaded to prevent inadvertent disconnection.
- The camera's PC terminal has no polarity so you can connect any sync cord regardless of its polarity.

- If the camera is used with a flash unit or flash accessory dedicated to another camera brand, the camera may not operate properly and malfunction may result.
- Also, do not connect to the camera's PC terminal any flash unit requiring 250 V or more.
- Do not attach a high-voltage flash unit on the camera's hot shoe. It might not work.

- A flash attached to the camera's hot shoe and a flash unit connected to the PC terminal can be used at the same time.

7

Image Playback

This chapter explains image playback operations such as how to view and erase captured images and how to connect the camera to a TV monitor.



For images taken with another camera:

The camera might not be able to properly display images captured with a different camera or edited with a personal computer or whose file name was changed.



MENU Setting the Image Review Time

You can set how long the image is to be displayed on the LCD monitor right after it is captured. To keep the image displayed, set **[Hold]**. To not have the image displayed, set **[Off]**.



1 Select **[Review time]**.

- Turn the <  > dial to select [ **Review time**], then press <  >.

2 Set the desired review time.

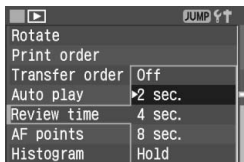
- Turn the <  > dial to select the setting, then press <  >.



- If you press the <  > button during the image review right after shooting, you can change the display format.
- The **[Hold]** setting keeps displaying the image until you press the shutter button halfway. However, if auto power off has been set, the camera will turn off automatically after the auto power off time elapses.
- During the image review for single-shooting, you can delete the displayed image by pressing the <  > button and selecting **[OK]**.
- To view images captured so far, see "Image Playback" (p.113).

MENU Auto Image Rotation

Vertical shots can be rotated automatically so that they are displayed upright during playback.

1 Select [Auto rotate].

- Turn the <⌚> dial to select [**↑↑ Auto rotate**], then press <SET>.

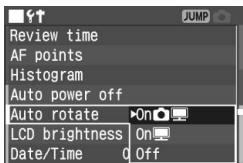

2 Select [On].

- Turn the <⌚> dial to select [**On**], then press <SET>.

3 Take a vertical shot.

- For the image review right after image capture, the image will not be displayed vertically on the LCD monitor.

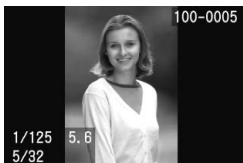

4 Playback the image.

- Press the <▶> button.
- ▶ The vertical shot will be displayed vertically as shown on the left.



- If you had set Auto rotate to [**Off**] and then took the vertical picture, the picture will not be rotated automatically even if you later set [**On**] and playback the image.
- If the vertical image is taken while the camera is pointed up or down, the image might not rotate automatically for playback.



- If you had set [**On**] or [**On**] and took the vertical picture, it will be rotated automatically when you view it with a personal computer installed with the software provided with the camera.
- If you had set [**On**] and took the vertical picture and then set [**On**] and played back the picture, it will be rotated automatically.
- When you change the camera's orientation between horizontal and vertical, the camera orientation sensor will make a small sound. This is normal and not a defect.

MENU Setting the LCD Brightness

You can adjust the brightness of the LCD monitor to one of five levels.

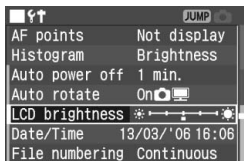

1 Select [LCD brightness].

- Turn the <⊙> dial to select [**↑↑ LCD brightness**], then press <SET>.
- ▶ The brightness adjustment screen will appear.



2 Adjust the brightness.

- While looking at the gray chart on the left, turn the <⊙> dial to adjust.
- Press <SET> to exit the setting and return to the menu.

 To check the image's exposure, look at the histogram (p.115).

Image Playback

You can select any captured image to view. You can view a single image, the shooting information, an index display, or a magnified view.

▶ Single image display



1 Playback the image.

- Press the <▶> button.
- ▶ The last captured image will appear on the LCD monitor.



2 Select the image.

- To playback images starting with the last image, turn the dial counterclockwise. To playback images starting with the first captured image, turn the <◉> dial clockwise.
- Press the <INFO.> button to switch the display format.



Single image display
(with basic info)

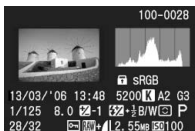

Shooting information



Single image display
(no shooting info)

- To quit the playback, press the <▶> button. The LCD monitor will turn off.



- In image playback modes other than single image, such as Index display and magnified view, you can still press the <INFO.> button to display or turn off the basic information.
- While data is being written to the CF card (access lamp blinking) after continuous shooting, press the <▶> button to display the last image which has been written to the CF card. Turn the <◉> dial to select the image. After all the images have been written to the CF card, they can be displayed in sequence.

Shooting Information Display

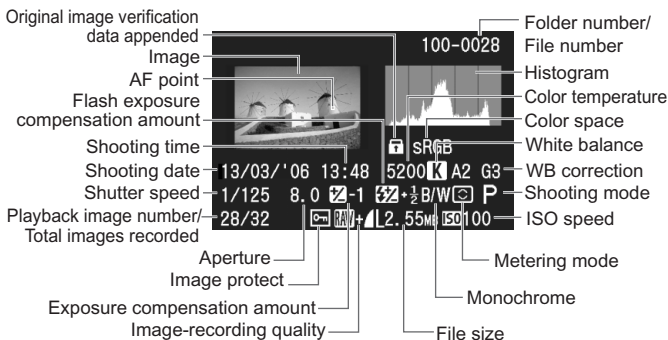

● Highlight Alert

When the shooting information is displayed, any overexposed areas of the image will blink. To obtain more image detail in the overexposed areas, set the exposure compensation to a negative amount and shoot again.

● AF Point Display

On the menu, if [**AF points**] is set to [**Display**] (p.35), the AF point will also be displayed on the shooting information screen.

If the image was taken in the One-Shot AF mode, the AF point which achieved focus will be displayed. If automatic AF point selection was used, you may see multiple AF points which achieved focus.

If the image was captured in the AI Servo AF mode, the AF point which was selected will be displayed. If automatic AF point selection was used, the AF points which achieved focus will be displayed.

● Histogram

On the menu's [**▶ Histogram**] setting, you can select [**Brightness**] or [**RGB**]. (p.35)

[Brightness] Display

This histogram is a graph showing the distribution of the image's brightness level. The horizontal axis indicates the brightness level (darker on the left and brighter on the right), while the vertical axis indicates how many pixels exist for each brightness level.

The more pixels there are toward the left, the darker the image. And the more pixels there are toward the right, the brighter the image.

If there are too many pixels on the left, the shadow detail will be lost. And if there are too many pixels on the right, the highlight detail will be lost. The tones in-between will be reproduced.

By checking the image's brightness histogram, you can see the exposure level bias and the overall tone reproduction condition.

Sample Histograms



Dark image



Normal image

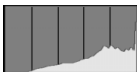

Bright image

[RGB] Display

This histogram is a graph showing the distribution of the image's brightness level of each primary color (RGB or red, blue, and green). The horizontal axis indicates the color's brightness level (darker on the left and brighter on the right), while the vertical axis indicates how many pixels exist for each color brightness level. The more pixels there are toward the left, the darker and less prominent the color. And the more pixels there are toward the right, the brighter and denser the color. If there are too many pixels on the left, the respective color information will be lacking. And if there are too many pixels on the right, the color will be too saturated with no detail.

By checking the image's RGB histogram, you can see the color's saturation and gradation condition and white balance bias.

Index Display



Nine thumbnail images are displayed on one screen.

1 Set the camera for playback.

- Press the <> button.
- ▶ The last captured image will appear on the LCD monitor.



2 Display the index images.

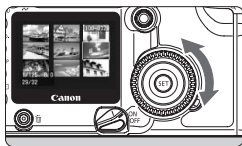

- Press the <-> button.
- ▶ The selected thumbnail will be highlighted with a green frame.





3 Select the image.

- Turn the <> dial to move the green frame.

Switching from the index display to another display format

- To display a single image, press the <> button.
- Pressing the <> button switches to the single image display and pressing it again switches to magnified view.

 While the index is displayed, press the <JUMP> button and turn the <> dial to jump nine images ahead or back. (p.118)

🔍/🔍 Magnified View

You can magnify the image by 1.5x to 10x on the LCD monitor.

1 Display the image.

- Display the image in the single-image or image info. display format.



Magnified area

2 Magnify the image.

- Press the <🔍> button.
- ▶ First, the center of the image will be magnified.
- To increase the magnification, hold down the <🔍> button.
- Press the <🔍> button to reduce the magnification. Hold down the button to continue reducing the magnification until it reaches the size in step 1.

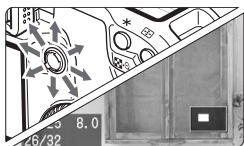

3 Scroll around the image.

- Use <🔍> to scroll around the image in any direction.
- Repeat steps 2 and 3 to magnify other areas of the image.
- To exit the magnified display, press the <▶> button and the single image display will return.



- During the magnified view, you can turn the <🔍> or <🔍> dial to view the next or previous image at the same magnification and scroll position.
- If C.Fn-17 [Magnified view] is set to [1: Image review and playback] (p.173), you can magnify the image during the image review by holding down the <🔍> button and pressing the <🔍> button. You can then press the <🔍>/<🔍> button to magnify or reduce the image.

JUMP Jump Display

During the single image, image with shooting information, index, or magnified view display, you can jump forward or back to images stored on the CF card.

1 Playback the image.

- Display a single image, image with shooting information, index, or magnified view.



Jump bar

2 Go to the jump display.

- Press the <JUMP> button.
- ▶ The jump bar will appear at the bottom of the screen.



3 Jump forward or back.

- Turn the <◀▶> dial.
- To quit the image jump, press the <JUMP> button. The jump bar will disappear.

● Jumping during the single image or image with shooting information display

During the single image and information display, you can use the Jump feature (by 10 or 100 images, by date).



- At step 2 on page 118, press the <JUMP> button, then press <SET>.
- Turn the <DISP> dial to select the jump method, then press <SET>.
- Turn the <DISP> dial to jump according to the selected jump method.

Jump 10 images / Jump 100 images

Turn the <DISP> dial clockwise to jump forward by 10 or 100 images. Or turn it counterclockwise to jump backward by 10 or 100 images.

Jump shot date

You can jump to a picture taken on a specific date. (If there are multiple pictures taken on the same date, the display will jump to the first picture taken on that date.) Turn the <DISP> dial to jump to the previous or next date.

● Jumping in the magnified view

Turn the <DISP> dial counterclockwise to jump ten images backward, or turn it clockwise to jump ten images forward. The magnified position and magnification will be maintained during the image jump.

● Jumping in the index display format

Turn the <DISP> dial counterclockwise to jump to the previous 9 images or turn it clockwise to jump to the next 9 images.



Image jump is also possible during [Protect], [Rotate] and [Custom WB].

MENU Automated Playback of Images (Auto playback)

You can playback the CF card's images in an automatic slide show. Each image will be displayed for about 3 sec.

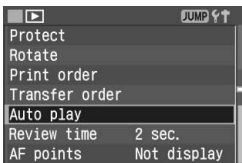

1 Select [Auto play].

- Turn the <◂> dial to select [▶], then press <SET>.
- ▶ The auto play screen will appear.

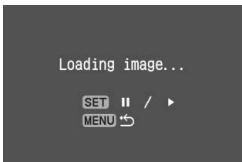

2 Start the auto play.

- ▶ After [Loading image...] is displayed for a few seconds, auto play will start.
- To pause the auto play, press <SET>.
- During pause, [||] will be displayed on the upper left of the image. Press <SET> again to resume the auto play.



3 Stop the auto play.

- To stop the auto play and return to the menu, press the <MENU> button.

- During auto play, auto power off will not work.
- The display time may vary depending on the image.
- During auto play, you can press the <INFO.> button to change the display format.
- During pause, you can turn the <◂> dial to view another image.

MENU Rotating an Image

You can rotate an image by 90° or 270° clockwise. Images will then be displayed in the correct orientation during playback.

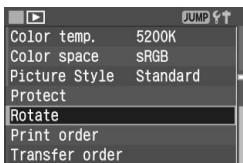

1 Select [Rotate].

- Turn the < [DIAL] > dial to select [[MENU] Rotate], then press < [SET] >.
- ▶ The Rotate screen will appear.



2 Rotate the image.

- Turn the < [DIAL] > dial to select the image to be rotated, then press < [SET] >.
- ▶ Each time you press < [SET] >, the image will rotate clockwise.
- To rotate another image, repeat step 2.
- To stop rotating the image, press the < [MENU] > button. The menu will reappear.



- If you have set [[MENU] Auto rotate] to [[MENU] On] (p.111) before taking the vertical shots, you need not rotate the image as described above.
- You can rotate the image even after you change the display format to shooting info display or index display after step 1.

Displaying the Images on TV

By connecting the camera to a TV set with the video cable (provided), you can view the captured images on a TV set. Always turn off the camera and the television before connecting or disconnecting them.

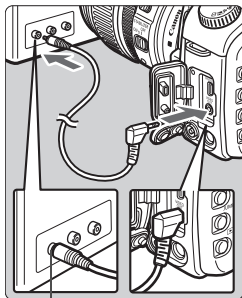

Video IN terminal

1 Connect the camera to the TV.

- Open the camera's terminal cover.
- Use the video cable (provided) to connect the camera's <VIDEO OUT> terminal to the TV monitor's VIDEO IN terminal.
- Insert the cable plug all the way in.

2 Turn on the TV and switch the TV's line input to Video IN.

3 Set the <⏻> switch to <ON> or <↙>.

4 Press the <▶> button.

- ▶ The image will appear on the TV screen. (Nothing will be displayed on the camera's LCD monitor.)
- After you finish, set the <⏻> switch to <OFF>, turn the TV off, then disconnect the video cable.

- If the proper video system format is not set, the image will not be displayed properly. Set the proper video system format with [F1 Video system].
- Do not use any video cable other than the one provided. Images might not be displayed if you use a different video cable.
- Depending on the TV monitor, part of the image might be truncated.

MENU Protecting Images

This prevents the image from being erased accidentally.



1 Select [Protect].

- Turn the <DIAL> dial to select [**Protect**], then press <SET>.
- ▶ The protect setting screen will appear.



Image protect icon

2 Protect the image.

- Turn the <DIAL> dial to select the image to be protected, then press <SET>.
- ▶ When an image is protected, the <ON> icon will appear below the image.
- To cancel the image protection, press <SET> again. The <ON> icon will disappear.
- To protect another image, repeat step 2.

- To exit the image protection, press the <MENU> button. The menu will reappear.



- Once an image is protected, it cannot be erased by the camera's erase function. To erase a protected image, you must first cancel the protection.
- If you erase all the images (p.125), only the protected images will remain. This is convenient when you want to erase unnecessary images all at once.
- You can protect the image even after you change the display format to shooting info display, magnified view, or index display after step 1.

Erasing Images

You can erase images individually or erase all the images at one time in the CF card. Only protected images (p.123) will not be erased.

- ⚠** Once an image is erased, it cannot be recovered. Make sure you no longer need the image before erasing it. To prevent important images from being erased accidentally, protect them.

Erasing a Single Image

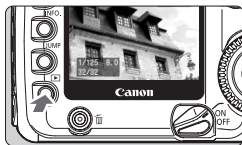

1 Display the image.

- Press the <▶> button.

2 Select the image to be erased.

- Turn the <◉> dial to select the image to be erased.

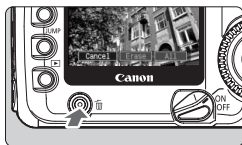

3 Display the erase menu.

- Press the <🗑> button.
- ▶ The erase menu will appear at the bottom of the screen.



4 Erase the image.

- Turn the <◉> dial to select [Erase], then press <SET>.
- ▶ The access lamp will blink and the image will be erased.
- If there are other images you want to erase, repeat steps 2 to 4.

Erasing All Images

1 Display the image.

- Press the $\langle \blacktriangleright \rangle$ button.

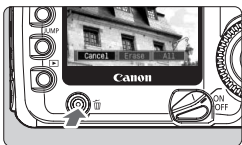

2 Display the erase menu.

- Press the $\langle \text{trash} \rangle$ button.
- ▶ The erase menu will appear at the bottom of the screen.



3 Select [All].

- Turn the $\langle \text{dial} \rangle$ to select [All], then press $\langle \text{SET} \rangle$.
- ▶ The confirmation dialog will appear.

4 Erase the images.

- Turn the $\langle \text{dial} \rangle$ to select [OK], then press $\langle \text{SET} \rangle$.
- ▶ All unprotected images will be erased.
- While the images are being erased, you can cancel the erasure by pressing $\langle \text{SET} \rangle$.

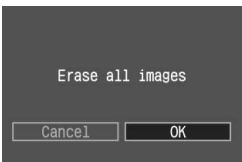

While data is being written to the CF card (access lamp blinking) after continuous shooting, press the $\langle \blacktriangleright \rangle$ button and then press the $\langle \text{trash} \rangle$ button to erase the displayed image or all images. If you select [All] and press the $\langle \text{SET} \rangle$ button, the images captured during continuous shooting (including those not yet processed) and all the images on the CF card will be erased.

MENU Formatting the CF Card

Format the CF card before using it in the camera.

- ⚠ **Formatting a CF card will erase everything in the card. Even protected images will be erased, so make sure there is nothing you need to keep. If necessary, transfer images to a personal computer before formatting the card.**

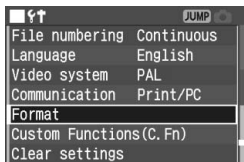

1 Select [Format].

- Turn the <◉> dial to select [**↑**], then press <SET>.
- ▶ The confirmation dialog will appear.

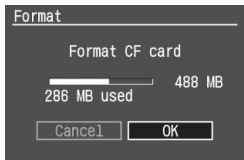

2 Format the CF card.

- Turn the <◉> dial to select [**OK**], then press <SET>.
- ▶ The CF card will be formatted (initialized).
- ▶ When the formatting is completed, the menu will reappear.



- If you use a CF card that has been formatted by a different camera or by a personal computer, it might not work properly. If this happens, format the card with the camera first. Then it might work with the camera.
- The CF card's capacity displayed on the formatting screen may be lower than the capacity indicated on the card.



Handling “Err CF”

If “**Err CF**” (CF error) is displayed on the LCD panel, it indicates that a problem with the CF card is preventing the image data from being recorded or read. Use another CF card instead.

Or, if you have a commercially-available CF card reader that can read the CF card, use it to transfer all the images in the card to a personal computer. After transferring all the images to a personal computer, format the CF card. It may then return to normal.

8

Direct Printing from the Camera

You can connect the camera directly to a printer and print out the images in the CF card.

The camera enables direct printing with printers compatible with “ PictBridge”, Canon “ CP Direct”, and Canon “ Bubble Jet Direct.”

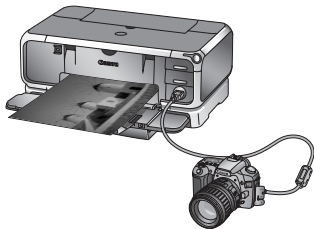

Conventions Used in this Chapter

This chapter includes procedures for various types of printers. After “Preparing to Print” on the next page, follow the instructions applicable to your printer on the pages indicated.

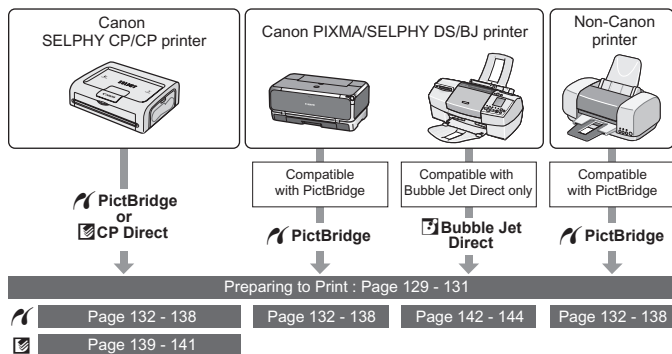

Canon's PictBridge Web Site

The Web site below gives more information about using your Canon camera with various printers such as which paper types to use.

<http://canon.com/pictbridge/>

Preparing to Print

You do the direct printing procedure entirely through your camera's LCD monitor.

Setting the Camera

- 1 Select [Communication].**
 - Turn the <⊙> dial to select [**⏏** **Communication**], then press <SET>.
- 2 Select [Print/PC].**
 - Turn the <⊙> dial to select [**Print/PC**], then press <SET>.

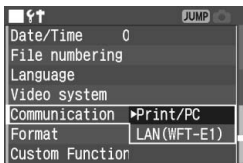





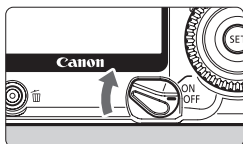

 For direct printing, using AC Adapter Kit ACK-E2 (optional) to power the camera is recommended.

Connect the camera to the printer



- 1 Turn the camera's <⏏> switch to <OFF>.**
- 2 Set up the printer.**
 - For details, refer to the printer's manual.
- 3 Connect the camera to the printer.**
 - See the "Printers and Cables" table on the next page, and use the proper cable.

Printers and Cables

Printer Compatibility		Suitable Cable
	PictBridge only	Interface cable provided with camera The plug at both ends have the <↔> icon.
 	PictBridge and CP Direct	
 	PictBridge and Bubble Jet Direct	
	CP Direct only	Cable provided with printer Only one plug has the <↔> icon.
	Bubble Jet Direct only	

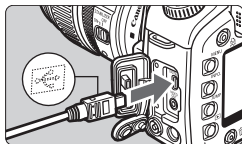

- If the printer has a built-in USB cable, connect the camera to that cable.
- When connecting the cable plug to the camera's <DIGITAL> terminal, the cable plug's <↔> icon must face the front side of the camera.
- To connect to the printer, refer to the printer's instruction manual.

4 Turn on the printer.

5 Turn the camera's <🔌> switch to <ON> or <↗>.

- ▶ Some printers may have a beeping sound.

PictBridge



CP Direct





Bubble Jet Direct



6 Playback the image.

- Press the <▶> button.
- ▶ The image and the printer icon <🖨️>, <🖨️>, or <🖨️> indicating a printer connection will be displayed.
- ▶ The <🖨️> button lamp will light in blue.
- The procedure will be different depending on the icon displayed. See the applicable pages below.

Icon	Reference pages
	132 - 138, 147
	139 - 141, 147
	142 - 144, 147



- RAW images are not compatible with direct printing.
- If you use a battery to power the camera, make sure it is fully charged. During direct printing, keep checking the battery level.
- If there is a long beeping sound in step 5, it indicates a problem with the PictBridge printer. To find out what's wrong, do the following: Press the <▶> button to playback the image and follow the steps below.
 1. Press <SET>.
 2. On the print setting screen, select **[Print]**.
The error message will be displayed on the LCD monitor. See "**Error Messages**" on page 138.
- Before disconnecting the cable, turn off the camera and printer. Pull out the cable while holding the plug, not the cord.
- When connecting the camera to the printer, do not use any cable other than the dedicated interface cable.
- Do not disconnect the cable during direct printing.

Printing with PictBridge

The setting options will differ depending on the printer. Some settings might be disabled. For details, refer to your printer's instruction manual.

Printer connected icon

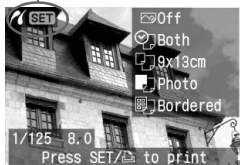

1 Select the image to be printed.

- Check that the <☞> icon is displayed on the upper left of the LCD monitor.
- Turn the <⊙> dial to select the image to be printed.

2 Press <SET>.

- ▶ The print setting screen will appear.

Print setting screen

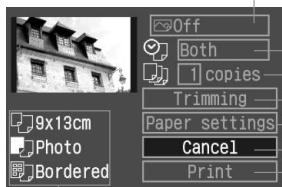

Set the printing effects.

Set the date or file number imprinting to on or off.

Sets the quantity to be printed.

Sets the trimming area.

Sets the paper size, type, and layout.

Returns to the screen in step 1.

Starts the printing.

The paper size, type, and layout you have set will be displayed.

* Depending on the type of printer, the date and file number imprinting, trimming, and other settings might not be available.

3 Select [Paper settings].

- Turn the <⊙> dial to select [Paper settings], then press <SET>.
- ▶ The Paper settings screen will appear.



Setting the Paper Size

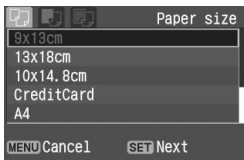

- Turn the <⦿> dial to select the size of the paper loaded in the printer, then press <SET>.
- ▶ The Paper Type screen will appear.

Setting the Paper Type

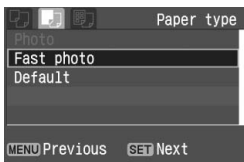

- Turn the <⦿> dial to select the type of paper loaded in the printer, then press <SET>.
- ▶ The Layout screen will appear.

About the Paper Types

If you are using a Canon PIXMA/DS/BJ printer with Canon paper, set the respective paper type as follows:

Photo Paper Plus Glossy	Photo
Photo Paper Pro	Fast Photo
Fine Art Paper	Fine Art
Photo Paper Plus Glossy	Default

If you are using a non-Canon printer, refer to the printer's instruction manual.

Setting the Layout

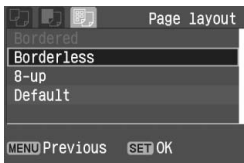

- Turn the <⦿> dial to select the layout, then press <SET>.
- ▶ The Print setting screen will reappear.

About Page Layout

Borderless	The print will have no white borders. If your printer cannot print borderless prints, the print will have borders.
Bordered	The print will have a white border along the edges.
Bordered f	The shooting information* will be imprinted on the border on 9x13cm and larger prints.
xx-up	Option to print 2, 4, 8, 9, 16, or 20 copies of same image on one sheet.
20-up f 35-up □	On A4 / Letter size paper, 20 or 35 thumbnails of the images ordered through DPOF will be printed. [20-up f] will have the shooting information* printed on the side of each thumbnail and the file number and date** printed on the bottom of each thumbnail image. [35-up □] will have the file number and date** printed on the bottom of the thumbnail images.
Default	With a Canon printer, the print will be borderless.

* From the Exif data, the camera name, lens name, shooting mode, shutter speed, aperture, exposure compensation amount, ISO speed, white balance, etc., will be imprinted.

** This depends on the <☺> date/file number imprinting option set in step 5.



4 Set the printing effects.

- Set as desired. If you need not set any printing effects, go to step 5 on page 137.
- Turn the <☉> dial to select the item on the upper right (see left figure), then press <SET>.
- Next, turn the <☉> dial to select the desired printing effect, then press <SET>.

Printing Effects (Depending on the printer, certain items might not be displayed.)

Off	Same as the printing characteristics turned "On". No automatic correction will be performed.
On	The image will be printed according to the printer's standard color. The image's Exif data is used to make automatic corrections.
Vivid	The image will be printed with higher saturation to produce more vivid blues and greens.
B/W B/W	Prints in black-and-white with true blacks.
B/W Cool tone	Prints in black-and-white with cool, bluish blacks.
B/W Warm tone	Prints in black-and-white with warm, yellowish blacks.
Natural	No automatic correction will be performed, and the image's natural color and contrast will be used.
Natural M	The printing characteristics are the same as the "Natural" setting. However, this setting enables fine adjustments for printing.

Adjustment of Printing Effects

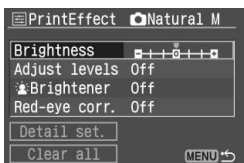
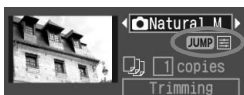

- With step 4, select the item. When **JUMP** is displayed, press the <JUMP> button. You can then set the parameters for fine adjustments. The parameters that can be adjusted for the selected item are shown in the table below.
- Turn the <DIAL> dial to select the item to be adjusted, then press <SET>.

Printing Adjustments (○: Adjustable)

Item		Off / On / Vivid / Natural	Natural M	B/W / Cool tone / Warm tone
Brightness		○	○	○
Adjust levels		–	○	○
Brightener		○	○	○
Red-eye corr.		○	○	○
Detail set.	Contrast	–	○	○
	Saturation		○	–
	Color tone		○	
	Color balance		○	

After making fine adjustments for the printing effect, if you do step 4 again to change the printing effect's setting, the adjustments will all revert to the default.

When [Default] is selected, the printing adjustments can not be adjusted.

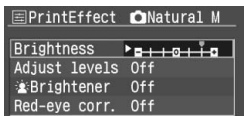

[Brightness]

- Turn the <DIAL> dial to make the adjustment, then press <SET>.

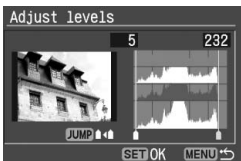
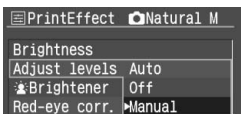

[Adjust levels]

- Turn the <⊙> dial to select the item to be adjusted, then press <SET>.
- Select **[Manual]** and press <SET>. The Adjust levels screen will then appear.
- Turn the <⊙> dial to adjust the shadows (black) within 0 to 127.
- Press the <JUMP> button.
- Turn the <⊙> dial to adjust the highlights (white) within 128 to 255.
- Press <SET> to exit. The previous screen will reappear.

When direct printing with DPOF (p.155) is selected, **[Manual]** can not be selected.

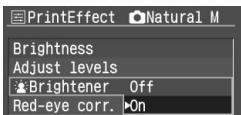

[Brightener] [Red-eye corr.]

- Turn the <⊙> dial, select either **[Off]** or **[On]**, then press <SET>.

Detail Settings of Printing Effects

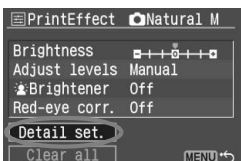

- Select **[Detail set.]**, then press <SET>. The Detail set. screen will then appear.
- Turn the <⊙> dial to select the item to be adjusted, then press <SET>.

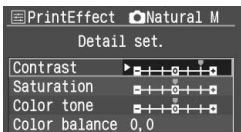

[Contrast] [Saturation] [Color tone]

- Turn the <⊙> dial to adjust the level, then press <SET>.

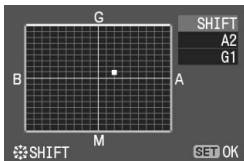
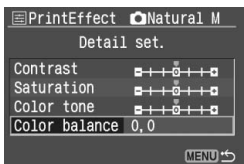

[Color balance]

- Press the <direction> up, down, left or right to move the dot "■" on the screen to the desired position.
- B is for blue, A is amber, M is magenta, and G is green. The color balance will shift in the respective direction.
- On the upper left, "SHIFT" indicates the color balance direction and correction amount.
- Press <SET> to exit. The previous screen will reappear.
- After completing the detail settings of printing effects, press the <MENU> button, then go to step 5.

If you select [Clear all], all the adjustments will revert to the default.



5 Setting the date and file number imprinting.

- Set as necessary.
- Turn the <dial> to select the field next to the <icon>, then press <SET>.
- Turn the <dial> to select the desired setting, then press <SET>.



6 Set the number of copies.

- Set as necessary.
- Turn the <dial> to select the field next to the <icon>, then press <SET>.
- Turn the <dial> to set the number of copies, then press <SET>.

- For details on trimming, see page 145.



7 Start printing.

- Turn the <⊙> dial to select [**Print**], then press <SET>.
- ▶ The printing will start.
- ▶ During the printing, the <⊙> button lamp will blink in blue.
- When the printing ends, the screen will return to step 1.
- To stop the printing, press <SET> while [**Stop**] is displayed, then turn the <⊙> dial to select [**OK**] and press <SET>.



- Depending on the image's file size and recording quality, it may take some time for the printing to start after you select [**Print**].
- The [**Default**] setting for printing effects and other options are the printer's own default settings as set by the printer's manufacturer. See the printer's instruction manual to find out what the [**Default**] settings are.

Handling Printer Errors

If you resolve a printer error (no ink, no paper, etc.) and select [**Continue**] to resume printing but it does not resume, operate the buttons on the printer to resume printing. For details, see the printer's instruction manual.

Error Messages

If a problem occurs during printing, an error message will appear on the camera's LCD monitor. Press <SET> to stop printing. After resolving the problem, resume printing. For details on how to resolve a printing problem, refer to the printer's instruction manual.

Paper Error

Check whether the paper is properly loaded in the printer.

Ink Error

The printer has run out of ink or the waste ink tank is full.

Hardware Error

Check for any printer problems other than paper and ink problems.

File Error

The selected image cannot be printed via PictBridge. Images taken with a different camera or images edited with a computer might not be printable.

Printing with CP Direct

Printer connected icon



1 Select the image to be printed.

- Check that the <SET> icon is displayed on the upper left of the LCD monitor.
- Turn the <DIAL> dial to select the image to be printed.

2 Press <SET>.

- ▶ The print setting screen will appear.

Print setting screen



— Sets the quantity to be printed.

— Sets the trimming area.

— Sets the printing style.

— Returns to step 1.

— Starts the printing.

The printing style settings are displayed.

<DIAL> is the date icon.

3 Select [Style].

- Turn the <DIAL> dial to select [Style], then press <SET>.
- ▶ The Style screen will appear.



[Image]



[Borders]

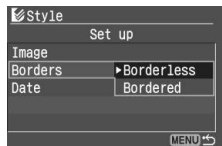

[Date]

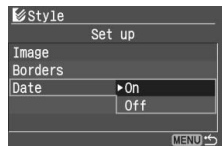

4 Set the options as desired.

- Set the **[Image]**, **[Borders]**, and **[Date]** as desired.
- Turn the <⊙> dial to select the menu item, then press <SET>.
- Turn the <⊙> dial to select the desired setting, then press <SET>.
- **[Image]** is selectable when card-size paper is used. If you select **[Multiple]**, 8 small images of the same picture will be printed on the paper.
- Check the **[Borders]** and **[Date]** settings and set them if necessary.
- When you are done, press the <MENU> button to return to the print setting screen.

5 Set the number of copies.

- Set as necessary.
- Turn the <⊙> dial to select **[copies]**, then press <SET>.
- Turn the <⊙> dial to set the number of copies, then press <SET>.
- Set a number from 1 to 99.

6 Set the trimming.

- Set as necessary.
- For details on trimming, see page 145.



7 Start printing.

- Turn the <⊙> dial to select [**Print**], then press <SET>.
- ▶ The printing will start.
- ▶ During the printing, the <⊙> button lamp will blink in blue.
- When the printing ends, the screen will return to step 1.
- To stop the printing, press <SET> while [**Stop**] is displayed, then turn the <⊙> dial to select [**OK**] and press <SET>.



- The date may look light if it is imprinted on a bright background or border.
- If [**Multiple**] is selected, [**Borders**] and [**Date**] cannot be selected. [**Borderless**] will be set and [**Date**] will be set to [**Off**]. The image will also be cut off along all four edges.



- If [**Date**] is [**On**], the date recorded for the image will appear on the print. The date will appear on the lower right of the image.
- If you select [**Stop**] while printing only one picture, the printing will not stop until it finishes printing the picture. If you are printing multiple pictures, the printing will stop after the current picture is finished printing.
- If a problem occurs during printing, an error message will appear on the camera's LCD monitor. Select [**Stop**] or [**Continue**] (after resolving the problem). If [**Continue**] is not displayed, select [**Stop**].

Printing with Bubble Jet Direct

Printer connected icon



1 Select the image to be printed.

- Check that the <[Printer Icon]> icon is displayed on the upper left of the LCD monitor.
- Turn the <[Dial]> dial to select the image to be printed.

2 Press <[SET]>.

- ▶ The print setting screen will appear.

Print setting screen



- Sets the quantity to be printed.
- Sets the trimming area.
- Sets the printing style.
- Returns to step 1.
- Starts the printing.

The printing style settings are displayed.

<[Clock Icon]> is the date icon.

3 Select [Style].

- Turn the <[Dial]> dial to select [Style], then press <[SET]>.
- ▶ The Style screen will appear.



[Paper]

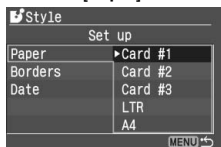

[Borders]



[Date]

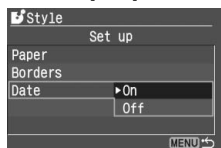

4 Set the options as desired.

- Turn the <⦿> dial to select the menu item, then press <SET>.
- Turn the <⦿> dial to select the desired setting, then press <SET>.
- **[Paper]** is the size of the paper loaded in the printer.
- Check the **[Borders]** and **[Date]** settings and set them if necessary.
- When you are done, press the <MENU> button to return to the print setting screen.

5 Set the number of copies.

- Set as necessary.
- Turn the <⦿> dial to select **[copies]**, then press <SET>.
- Turn the <⦿> dial to set the number of copies, then press <SET>.
- Set a number from 1 to 99.



6 Set the trimming.

- Set as necessary.
- For details on trimming, see page 145.



7 Start printing.

- Turn the <⊙> dial to select [**Print**], then press <SET>.
- ▶ The printing will start.
- ▶ During the printing, the <⊙> button lamp will blink in blue.
- When the printing ends, the screen will return to step 1.
- To stop the printing, press <⊙> while [**Stop**] is displayed, then turn the <⊙> dial to select [**OK**] and press <SET>.

ⓘ If [**Bordered**] is set, the date might be imprinted on the border, depending on the printer.

- If [**Date**] is [**On**], the date recorded for the image will appear on the print. The date will appear on the lower right of the image.
- If you select [**Stop**] during the printing, the picture being printed will stop printing and the paper will be discharged.
- If a problem occurs during printing, an error message will appear on the camera's LCD monitor. Select [**Stop**] or [**Continue**]. If you select [**Continue**] and the printer does not resume printing, it will resume automatically after you resolve the problem.
- If you are using a BJ printer equipped with an operation display panel, the error No. will be displayed if an error occurs. To resolve the respective error, refer to the BJ printer's instruction manual.

Setting the Trimming

You can trim the image and print only the trimmed portion as if the image was recomposed.

Do the trimming right before printing. If you set the trimming and then set the print settings, you may have to set the trimming again.



1 Select [Trimming].

- Turn the <⊙> dial to select [Trimming], then press <SET>.
- ▶ The trimming screen will appear.



2 Trim the image.

- The image area within the trimming frame will be printed.
- The operation guide disappears while you trim the image. It will reappear after 5 sec. of idle time.

Changing the trimming frame size

- When you press the <Q> or <Q-Q> button, the size of the trimming frame will change. The smaller the trimming frame, the larger the image magnification will be.

Moving the trimming frame

- Use <⊙> to scroll around the image in any direction. Move the trimming frame until it shows the desired image area or composition.

Rotating the frame

- The <INFO.> button toggles between the vertical and horizontal orientation of the trimming frame. For example, a horizontal shot can be printed as a vertical shot.



Image area to be printed



3 Exit the menu.

- Press <SET>.
- ▶ The Print setting screen will reappear.
- ▶ On the upper left, you can see the trimmed image area that will be printed.

- ⚠ ● Depending on the printer, the trimmed image area might not be printed as you specified.
- The smaller you make the trimming frame, the grainier the picture will look. If the picture will be too grainy, the trimming frame will turn red.
- While trimming the image, look at the camera's LCD monitor. If you look at the image on a TV screen, the trimming frame might not be displayed accurately.

 The trimming frame shape will be different depending on the **[Paper settings]**, **[Image] / [Paper]**, **[Page layout] / [Borders]** settings.

Easy Printing

When you print directly from your camera to your printer, the printing settings will be saved in your camera. To use the same settings again, follow the steps below.

- 1 Connect the camera to a printer and prepare for printing.**
- 2 Playback the images and select the ones to be printed.**
- 3 Press the  button that lights in blue.**

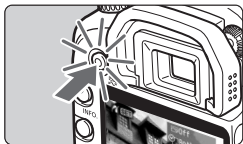

- ▶ The blue lamp will blink and printing will start.



- With Easy Printing, only one print can be printed each time.
- With Easy Printing, any cropping (trimming) will not be applied.



9

DPOF: Digital Print Order Format

With DPOF (Digital Print Order Format), you can use the camera to specify which images in the CF card are to be printed and the quantity. This feature is very convenient when you make prints with a DPOF-compatible printer or photo lab.

About DPOF

DPOF (Digital Print Order Format) is a standard for recording print ordering instructions to the CF card. It is for images taken with a digital camera, and you can specify which photos and the quantity to print. With a DPOF-compatible digital camera, you can do the following:

- By inserting a CF card into a DPOF-compatible printer, you can make prints as specified.
- Printers capable of direct printing from the camera can print the images as specified by DPOF.
- When ordering prints from a photo lab, you do not need to fill in any order form to specify the image selections, quantity, etc.

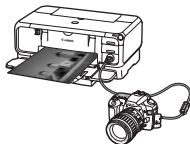

MENU Print Ordering

Print Settings

Set the print type, date imprinting, and file No. imprinting. The print settings will be applied to all print-ordered images. (They cannot be set individually for each image.)

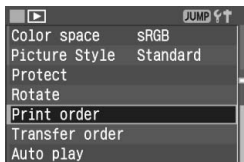

1 Select [Print order].

- Turn the <⦿> dial to select [], then press <SET>.
- ▶ The Print order screen will appear.

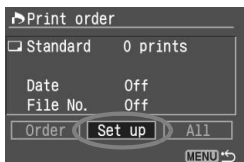

2 Select [Set up].

- Turn the <⦿> dial to select [Set up], then press <SET>.
- ▶ The print setting screen will appear.

3 Set the options as desired.

- Set the [Print type], [Date], and [File No.].
- Turn the <⦿> dial to select the menu item, then press <SET>.
- Turn the <⦿> dial to select the desired setting, then press <SET>.

[Print type]

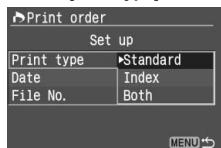

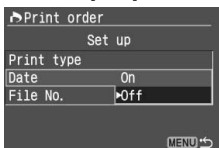

[Date]

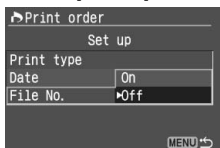

[File No.]



Print type		Standard	Prints one image on one sheet.
		Index	Multiple, thumbnail images are printed on one sheet.
		Both	Prints both the standard and index prints.
Date	On	[On] imprints the recorded date on the print.	
	Off		
File No.	On	[On] imprints the file No. on the print.	
	Off		

4 Exit the menu.

- Press the <MENU> button.
- ▶ The Print order screen will reappear.
- Next, select [**Order**] or [**All**] to select the images to be printed.



- RAW images cannot be selected for printing.
- Even if [**Date**] and [**File No.**] are set to [**On**], the date or file No. might not be imprinted depending on the print type setting and printer type.
- With [**Index**] prints, both the [**Date**] and [**File No.**] cannot be set to [**On**] at the same time.
- When printing with DPOF, you must use the CF card whose Print Order specifications have been set. It will not work if you just extract images from the CF card and try to print them.
- Certain DPOF-compatible printers and photo labs might not be able to print the photos as you specified. If this happens with your printer, refer to the printer's instruction manual. Or check with your photo lab about compatibility when ordering prints.
- Do not insert into the camera a CF card whose print order were set by a different camera and then try to specify a print order. The print order may not work or may be overwritten. Also, depending on the image type, the print order may not be possible.

Selecting Individual Images for Printing

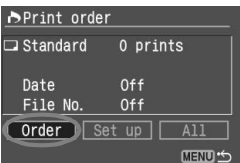

1 Select [Order].

- Turn the <◂> dial to select [Order], then press <SET>.
- ▶ The order screen will appear.



2 Select the image to be printed.

- Turn the <◂> dial to select the image to be printed.
- Press the <◻&Q> button to display the three-image view. To return to the single-image view, press the <Q> button.

Three-image view



3 Order the print.

- The print order will vary depending on the [Print type] (p.150) setting.

For [Standard] and [Both]

- For standard-type prints, you can set the quantity (up to 99) for each image.
- Press <SET>, then turn the <◂> dial to select the print quantity. Then press <SET>.

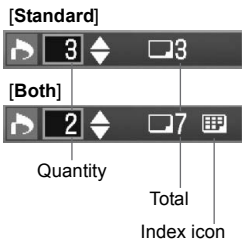

[Index]

Check mark

Index icon

For [Index]

- If you want to include the image in the index print, checkmark the box <✓>. To deselect it, leave the box unchecked.
- Press <SET> to checkmark the box <✓>, or press <SET> again to remove the checkmark.
- To select other images, repeat steps 2 and 3.
- You can select up to 998 images.

4 Exit the menu.

- Press the <MENU> button.
- ▶ The Print order screen will reappear.
- Press the <MENU> button again to save the print order to the CF card. The menu will then reappear.

Selecting All images

The print order can also be set or canceled for all the images in the CF card. For standard-type prints, a quantity of one will be ordered for all the images.

Note that after following the “Selecting Individual Images” procedure, if you do the “Selecting All Images” procedure, the print order will change to “All images.”

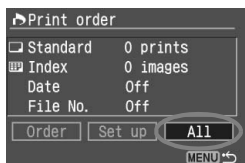

1 Select [All].

- Turn the <⊙> dial to select [All], then press <SET>.
- ▶ The All screen will appear.

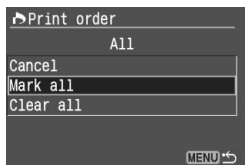

2 Select [Mark all].

- Turn the <⊙> dial to select [Mark all], then press <SET>.
- ▶ One print each will be specified for all the images, then the Print order screen will reappear.
- If you select [Clear all], all the images selected for printing will be deselected.

3 Exit the menu.

- On the Print order screen, press the <MENU> button.
- ▶ The settings will be saved to the CF card, and the menu will reappear.

- Note that RAW images cannot be selected for printing even when you set “Mark all.”
- When printing with PictBridge, print no more than 400 images for one print order. If you specify more than this, all the selected images might not be printed.

MENU Direct Printing with DPOF

With a printer compatible with direct printing, you can easily print images specified with DPOF.

1 Prepare to print.

- See “Setting the Camera” (steps 1 and 2) and “Connect the camera to the printer” (steps 1 to 5) on pages 129 to 130.

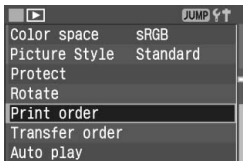

2 Select [Print order].

- Turn the <⦿> dial to select [, then press <SET>.
- ▶ The Print order screen will appear.

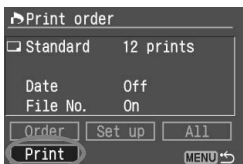

3 Select [Print].

- Turn the <⦿> dial to select [Print], then press <SET>.
- [Print] will be displayed only if the camera is connected to the printer and printing is possible.
- ▶ The print setting screen will appear.

4 Set the printing options.

 PictBridge

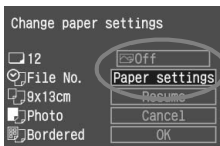

 CP Direct

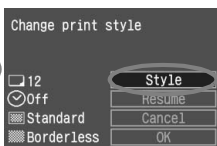

 Bubble Jet Direct

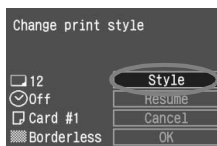





 PictBridge

- Set the [Paper settings] and if necessary, also set the printing effects. (p.132, 134)

 CP Direct /  Bubble Jet Direct

- Set the [Style]. (p.139/142)

5 Start printing.

- Turn the <  > dial to select [OK], then press <  >.
- ▶ The printing will start.
- To stop the printing, press <  > while [Stop] is displayed, then turn the <  > dial to select [OK] and press <  >.

- 
- When printing with PictBridge or Bubble Jet Direct, be sure to set the paper size.
 - With PictBridge, the file No. cannot be imprinted depending on the printer.
 - If [Bordered] is set, the date might be imprinted on the border, depending on the printer.
 - The date might look light if it is imprinted on a bright background or border.

- 
- With CP Direct, if [Print type] is set to [Index], the number of images printed on one index sheet will be as follows:
 - Credit card size: 20 images • 9 x 13 cm size: 42 images
 - 10 x 14.8 cm size: 63 images
 As for the number of index images with Bubble Jet Direct, see the BJ printer's instruction manual.
 - If you stopped the printing and want to resume printing the remaining images, select [Resume]. Note that printing will not resume if you stop the printing and any of the following occurs:
 - Before resuming the printing, you changed the print order settings.
 - Before resuming the printing, you erased an image that was to be printed.
 - In the case of index printing with CP Direct, you changed the paper cassette before resuming the printing.
 - In the case of index printing with PictBridge, you changed the paper settings before resuming the printing.
 - When you stopped the printing, the CF card's remaining capacity was low.
 - If there is a printing problem, see page 138 for PictBridge, page 141 for CP Direct, or page 144 for Bubble Jet Direct.

10

Transferring Images to a Personal computer

You can transfer images in the CF card to a personal computer. When the camera is connected to a personal computer, you can transfer the images directly with the camera. This feature is called direct image transfer.

If the computer software (EOS DIGITAL Solution Disk CD-ROM) provided with the camera has been installed in your personal computer, you can easily transfer the images without operating the personal computer. This is especially convenient for people who are not good at computers.

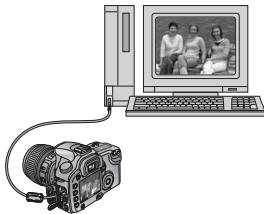

- To install the provided software in the personal computer, see the "Software Guide."
- If you want to operate the personal computer to transfer the images from the camera, see the "Software Instruction Manual" in the CD-ROM.

MENU Selecting the Images to be Transferred

With the camera, you can select the JPEG and RAW images to be transferred to the personal computer.

Selecting Individual Images

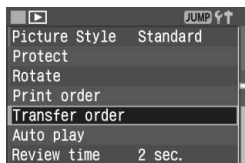

1 Select [Transfer order].

- Turn the <◂> dial to select [**Transfer order**], then press <SET>.
- ▶ The Transfer order screen will appear.

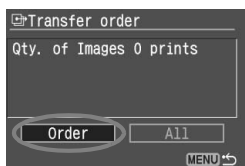

2 Select [Order].

- Turn the <◂> dial to select [**Order**], then press <SET>.
- ▶ The transfer image selection screen will appear.



3 Select the image to be transferred.

- Turn the <◂> dial to select the image.
- Press the <Q/☒> button to display the three-image view. To return to the single-image display, press the <Q> button.



4 Checkmark the image to be transferred.

- Checkmark the upper left box <✓>. To deselect it, leave the box unchecked.
- Press <SET> to checkmark the box <✓>, or press <SET> again to remove the checkmark.
- To select other images, repeat steps 3 and 4.
- You can select up to 998 images to be transferred.

5 Exit the menu.

- Press the <MENU> button.
- ▶ The Transfer order screen will reappear.

- Press the <MENU> button again to save the image selections to the CF card. The menu screen will then reappear.

Selecting All Images

The transfer order can also be set or canceled for all the images in the CF card. Note that after following the “Selecting Individual Images” procedure, if you do the “Selecting All Images” procedure, the transfer order will change to “All images.”

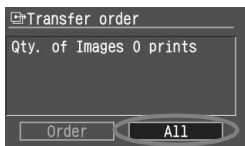

1 Select [All].

- Turn the <DIAL> dial to select [All], then press <SET>.
- When transferring more than 999 images at one time, select [All Images] on page 162.

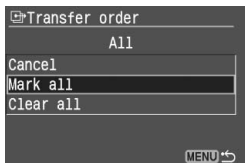

2 Select [Mark all].

- Turn the <DIAL> dial to select [Mark all], then press <SET>.
- ▶ All the images will be selected for the transfer order, and the Transfer order screen will reappear.
- If you select [Clear all], all the images selected for transferring will be deselected.

3 Exit the menu.

- On the Transfer order screen, press the <MENU> button.
- The image selections will be saved to the CF card, and the menu will reappear.

Do not insert into the camera a CF card whose transfer order were set by a different camera and then try to specify a transfer order. The selected images might all be overwritten. Also, depending on the image type, the transfer order may not be possible.

For the transfer order, if you select an image captured in the RAW+JPEG mode, it will be counted as one image. During the direct image transfer, both the RAW and JPEG images will be transferred to the personal computer.

Preparation for Image Transfer

Before connecting the camera to the personal computer, be sure to first install the EOS DIGITAL Solution Disk software (in the CD-ROM provided with the camera) to the personal computer. If you connect the camera to the personal computer before installing the software, the personal computer will not recognize the camera properly and the images cannot be transferred.

Installing the Software



Install the software to the personal computer.

- Refer to the separate Software Guide to install the software to the personal computer.

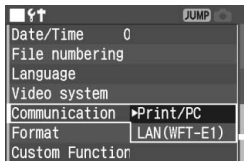

Camera Settings



1 Select [Communication].

- Turn the <  > dial to select [ **Communication**], then press <  >.

2 Select [Print/PC].

- Turn the <  > dial and select [**Print/PC**], then press <  >.

If [**Communication**] is set to [**LAN (WFT-E1)**], the personal computer will not be able to recognize the camera.

Connect the Camera to the Personal Computer

1 Set the camera's  switch to <OFF>.

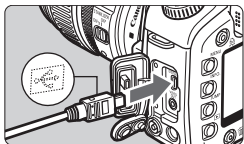

2 Connect the camera to the personal computer.

- Use the interface cable that came with the camera.
- To the camera's <DIGITAL> terminal, connect the cable's plug with the  icon facing toward the front of the camera.
- To the personal computer's USB port, connect the plug on other end of the cable.

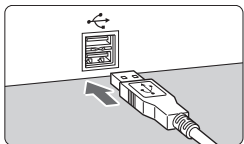

3 Set the camera's  switch to <ON> or <P>.

- On the computer, when the dialog box to select the program appears, select **[EOS Utility]** with the mouse, then click **[OK]**. When the camera model selection screen appears, select **[EOS 30D]**, then click **[OK]**.
 - ▶ The **[EOS Utility]** screen will appear on the computer, and the direct image transfer screen will appear on the camera's LCD monitor.



- While the direct image transfer screen is displayed, pressing the shutter button halfway will not return the camera ready for shooting.
- Before disconnecting the cable, turn off the camera first and pull out the cable by grasping the plug (instead of the cord).



If the **[EOS Utility]** screen does not appear on the computer, see “Connect the Camera and the Computer and then Start EOS Utility” in the Software Instruction Manual in the CD-ROM.



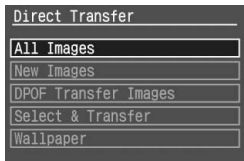

Transferring Images to a Personal Computer

After installing the software (provided with the camera) to a personal computer, connect the camera to the personal computer. You can then transfer images in the CF card to the personal computer by operating the camera.

Transferring DPOF Transfer Images, All Images, or New Images







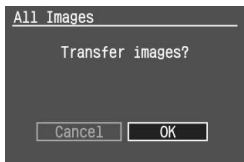

1 Select [DPOF Transfer Images], [All Images], or [New Images].

- Turn the <  > dial to select the desired option, then press <  >.
- Instead of pressing <  >, if you press the <  > button lamp that lights in blue, the image transfer will start immediately.
- If you select [**DPOF Transfer Images**], the images selected in the Transfer order procedure on pages 158, 159 will be transferred to the personal computer.
- If you select [**All Images**], all the images in the CF card will be transferred to the personal computer.
- If you select [**New Images**], all images not yet transferred to the personal computer will be selected automatically by the camera and transferred to the personal computer.



2 Select [OK].

- Turn the <  > dial to select [**OK**], then press <  >.
- ▶ The image transfer will start.
- During the image transfer, the <  > button lamp will blink in blue. When the image transfer is completed, the direct transfer screen will reappear.
- To cancel the image transfer, press <  > while [**Cancel**] is displayed and turn the <  > dial to select [**OK**]. Then press <  >.

Select the Images to be Transferred

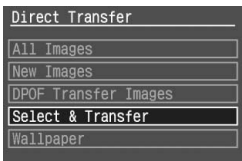

1 Select [Select & Transfer].

- Turn the <◉> dial to select [Select & Transfer], then press <SET> or press the <L> button lamp that lights in blue.
- ▶ The transfer image selection screen will appear.



2 Select the image to be transferred.

- Turn the <◉> dial to select the image.

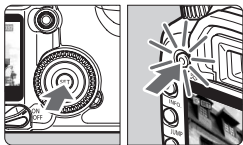

3 Transfer the image.

- Press <SET> or press the <L> button lamp that lights in blue.
- ▶ The selected image will be transferred.
- During the image transfer, the <L> button lamp will blink in blue. When the image transfer is completed, the button will light in blue.
- During the image transfer, you can turn the <◉> dial to select the next image to be transferred.
- Press the <MENU> button to return to the direct transfer screen.



During the image transfer, do not disconnect the cable.



The EOS Utility's default setting will sort the transferred images into folders sorted according to the shooting date. The folders will be saved in the [My Pictures] folder (Windows) or [Pictures] folder (Macintosh).

Transferring Wallpaper Images

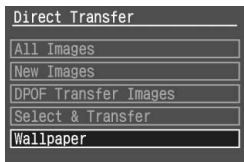

1 Select [Wallpaper].

- Turn the <⊙> dial to select [Wallpaper], then press <SET> or press the <⏏> button lamp that lights in blue.
- The transfer image selection screen will appear.



2 Select the image to be transferred.

- Turn the <⊙> dial to select the image.

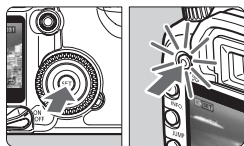

3 Transfer the image.

- Press <SET> or press the <⏏> button lamp that lights in blue.
- ▶ The selected image will be transferred, and the image will appear as wallpaper on the personal computer's desktop screen.
- During the image transfer, the <⏏> button lamp will blink in blue. When the image transfer is completed, the button will light in blue.
- Press the <MENU> button to return to the direct transfer screen.

⚠ RAW images cannot be transferred as wallpaper.

11

Customizing the Camera

Custom Functions enable you to customize various camera features to suit your picture-taking preferences.

- Custom Functions work only in Creative Zone modes.

MENU Setting a Custom Function ★

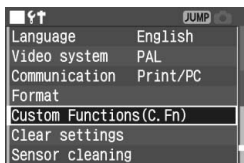

Custom Function No.

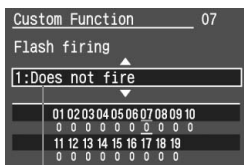
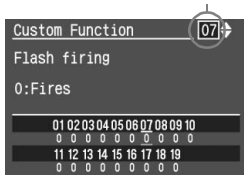

Description

1 Select [Custom Functions (C.Fn)].

- Turn the <◉> dial to select [**↑↑ Custom Functions (C.Fn)**], then press <SET>.
- ▶ The Custom Function screen will appear.

2 Select Custom Function No.

- Turn the <◉> dial to select the setting, then press <SET>.

3 Change the setting.

- Turn the <◉> dial to select the setting, then press <SET>.
- Repeat steps 2 and 3 if you want to set other Custom Functions.
- On the bottom of the screen, you can see the current Custom Function settings.

4 Exit the menu.

- Press the <MENU> button to return to the menu.
- ▶ When you exit the menu, <**C.Fn**> will be displayed on the LCD panel.

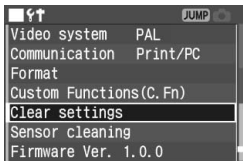
MENU Resetting All Custom Functions ***1** Select [Clear settings].

- Turn the <DIAL> dial to select [Clear settings], then press <SET>.
- ▶ The Clear settings screen will appear.

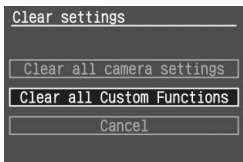
**2** Select [Clear all Custom Functions].

- Turn the <DIAL> dial to select [Clear all Custom Functions], then press <SET>.

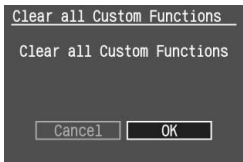
**3** Select [OK].

- Turn the <DIAL> dial to select [OK], then press <SET>. All the Custom Functions will be reset to the default settings.



MENU Custom Function Settings [★]

C.Fn-01 SET function when shooting



You can change the function assigned to <  > when the camera is ready to shoot.

0: Default (no function)

1: Change quality

After pressing <  >, look at the LCD panel and turn the <  > dial to set the recording quality directly.

2: Change Picture Style

Press the <  > button to display the Picture Style selection screen on the LCD monitor. Turn the <  > dial to select a style, then press <  >.

3: Menu display

Gives the same function as the < MENU > button.

4: Image replay

Gives the same function as the <  > button.

C.Fn-02 Long exp. noise reduction

0: Off

1: Auto

For 1 sec. or longer exposures, noise reduction is performed automatically if long exposure noise is detected. Setting this to [Auto] is effective in most cases.

2: On

Noise reduction is performed for all exposures 1 sec. or longer. Setting this may reduce the noise even for exposures which would not have been noise detected/reduced at the [Auto] setting.

 After the picture is taken, the noise reduction process will take the same amount of time as the exposure. You cannot take another picture until the noise reduction process is completed.

C.Fn-03 Flash sync. speed in Av mode

0: Auto

1: 1/250sec. (fixed)

Sets the flash sync speed to 1/250 sec. in the aperture-priority AE (Av) mode. (Against dark backgrounds such as the night sky, the subject's background will look dark.)

C.Fn-04 Shutter/AE lock button

0: AF/AE lock

1: AE lock/AF

Convenient when you want to focus and meter separately. Press the <✳> button to autofocus and press the shutter button halfway to attain AE lock.

2: AF/AF lock, no AE lock

In the AI Servo AF mode, you can press the <✳> button to stop the AF operation momentarily. This prevents the AF from being thrown off by any obstacle passing between the camera and subject. The exposure is set at the moment the picture is taken.

3: AE/AF, no AE lock

This is useful for subjects which keep moving and stopping repeatedly. In the AI Servo AF mode, you can press the <✳> button to start or stop the AI Servo AF operation. The exposure is set at the moment the picture is taken. Thus, the focusing and exposure will always be at the optimum point as you wait for the decisive moment.



C.Fn-04 and C.Fn-18-0, 1, 2 (p.174) both have AF start/stop and AE lock functions. If you have set both these Custom Functions and you execute both Custom Function operations, the latter operation will not work. The only exception will be when AF stop is executed after AF start.

C.Fn-05 AF-assist beam

The AF-assist beam can be emitted by the camera's built-in flash or by the external, EOS-dedicated Speedlite.

0: Emits

1: Does not emit

AF-assist beam not emitted.

2: Only external flash emits

If an external, EOS-dedicated Speedlite is attached, it will emit the AF-assist beam when necessary. The camera's built-in flash will not emit the AF-assist beam.



If the external, EOS-dedicated Speedlite's [AF-assist beam] Custom Function is set to [Does not emit], the Speedlite will not emit the AF-assist beam even if the camera's C.Fn-05-0/2 is set.

C.Fn-06 Exposure level increments

0: 1/3-stop

1: 1/2-stop

Sets 1/2-stop increments for the shutter speed, aperture, exposure compensation, AEB, etc.

 The exposure level will be displayed in the viewfinder and on the LCD panel as shown below.

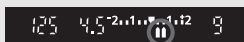

C.Fn-07 Flash firing

You can enable the built-in flash, external Speedlite, and non-Canon flash connected to the PC terminal to fire.

0: Fires

1: Does not fire

This will disable the flash, but the AF-assist beam will still be emitted. Note that whether or not the AF-assist beam is emitted is dependent on the C.Fn-05 setting.

C.Fn-08 ISO expansion

0: Off

1: On

For the ISO speed, "H" (equivalent to ISO 3200) will be selectable.

C.Fn-09 Bracket sequence / Auto cancel

You can change the AEB sequence when the pictures are bracketed with the shutter speed or aperture and the file-saving sequence for white balance bracketing (WB-BKT). When “Auto cancellation” is set, bracketing will be canceled in the following cases:

AEB: You turn the <  > switch to <OFF>, change lenses, have flash-ready, replace the battery, or replace the CF card.

WB-BKT: You turn the <  > switch to <OFF>, replace the battery, or replace the CF card.

0: 0, -, +/Enable

1: 0, -, +/Disable (Auto cancel works only if the flash is ready.)

The first bracketed shot is the standard exposure (or exposed with the standard white balance). This bracketing sequence can be repeated.

2: -, 0, +/Enable

Starts the bracketing sequence with the minus (or bluish or magenta bias) setting.

3: -, 0, +/Disable (Auto cancel works only if the flash is ready.)

Repeats the bracketing sequence starting with the minus (or bluish or magenta bias) setting. This bracketing sequence can be repeated.

AEB	WB bracketing	
	B/A Bias	M/G Bias
0 : Standard exposure	0 : Standard white balance	0 : Standard white balance
- : Decreased exposure	- : More blue	- : More magenta
+ : Increased exposure	+ : More amber	+ : More green

C.Fn-10 Superimposed display

0: On

1: Off

The AF point in the viewfinder will not flash in red. Recommended when it is bothersome to see it light up.

The AF point will still light when you select it.

C.Fn-11 Menu button display position

When you press the <MENU> button, you can set the menu screen setting.

0: Previous (top if power off)

Displays the preceding menu screen that was used. Note that the top menu screen [Quality] will be displayed instead when the < > switch is turned <OFF>.

1: Previous

Displays the preceding menu screen that was used.

2: Top

Always displays the top menu screen [Quality].

C.Fn-12 Mirror lockup



0: Disable

1: Enable



Effective for close-up and telephoto shots to prevent camera shake caused by the mirror's reflex action. See page 98 for the mirror lockup procedure.

C.Fn-13 AF point selection method





0: Normal

Press the < > button and use < > to select the AF point.

1: Multi-controller direct

Without pressing the < > button first, you can just use the < > to select the desired AF point. Pressing the < > button will set it to automatic AF point selection.

2: Quick Control Dial direct

Without pressing the < > button first, you can just use the < > dial to select an AF point directly. By holding down the < > button and turning the < > dial, you can set the exposure compensation.

C.Fn-14 E-TTL II**0: Evaluative**

Fully automatic flash photography for all conditions, from low light to daylight fill-flash.

1: Average

The flash is averaged for the entire area covered by the flash. Since automatic flash exposure compensation will not be executed, you may have to set it yourself depending on the scene. This also applies if you use FE lock.

C.Fn-15 Shutter curtain sync.**0: 1st-curtain sync.****1: 2nd-curtain sync.**

When a slow shutter speed is set, you can capture a light trail following the subject. The built-in flash or external Speedlite fires the flash right before the shutter closes. This Custom Function can be used to obtain 2nd-curtain sync effects even with EX-series Speedlites which do not have this feature. If the EX-series Speedlite has this feature, it will override this Custom Function.



When 2nd-curtain sync is used, a preflash will be fired for flash metering control right after you press the shutter button completely. Remember that the main flash will fire right before the shutter closes.

C.Fn-16 Safety shift in AV or TV**0: Disable****1: Enable**

This works in the shutter-priority AE (Tv) and aperture-priority AE (Av) modes. If the subject's brightness changes suddenly and the current shutter speed or aperture becomes unsuitable, the shutter speed or aperture is shifted automatically to obtain a suitable exposure.

C.Fn-17 Magnified view**0: Image playback only**

Magnified view is possible while the image is displayed after you press the playback button. (p.117)

1: Image review and playback

To magnify the image during the image review, hold down the <MAGNIFY> button and press the <OK> button. You can also magnify the view in the same procedure as C.Fn-17-0.

C.Fn-18 Lens AF stop button function

0: AF stop

1: AF start

AF operates only while the AF stop button is pressed. While the button is pressed, AF operation with the camera is disabled.

2: AE lock

When the button is pressed, AE lock is applied. Convenient when you want to focus and meter separately.

3: AF point: M → Auto / Auto → ctr

In the manual AF point selection mode, the button instantly switches to automatic AF point selection from manual AF point selection only while you hold it down. Convenient when you are no longer able to focus track a moving subject with a manually-selected AF point in the AI Servo AF mode. In the automatic AF point selection mode, the button selects the center AF point only while you hold it down.

4: ONE SHOT ↔ AI SERVO

In the One-Shot AF mode, the button switches to the AI Servo AF mode only while you hold it down. In the AI Servo AF mode, the button switches to the One-Shot AF mode only while you hold it down. Convenient when you need to keep switching between One-Shot AF and AI Servo AF for a subject which keeps moving and stopping.

5: IS start

With the lens' IS switch already ON, the Image Stabilizer operates only while you press the button.



The AF stop button is provided only on super telephoto lenses.

C.Fn-19 Add original decision data

0: Off

1: On

Data for verifying whether the image is original or not is appended to the image. When an image appended with the verification data is played back, the <  > icon will be displayed. (p.114) To verify whether the image is original, the Data Verification Kit DVK-E2 (optional) is required.

12

Reference

This section will help you understand your camera better. It covers information on camera features, system accessories, and other reference information.

Function Availability Table

● : Set automatically ○ : User selectable

Mode Dial		Basic Zone						Creative Zone					
									P	Tv	Av	M	A-DEP
Quality	JPEG	○	○	○	○	○	○	○	○	○	○	○	○
	RAW							○	○	○	○	○	
	RAW + JPEG							○	○	○	○	○	
ISO speed	Auto	●	●	●	●	●	●						
	Manual							○	○	○	○	○	
Picture Style	Standard	●			●	●	●	●	○	○	○	○	○
	Portrait		●						○	○	○	○	○
	Landscape			●					○	○	○	○	○
	Neutral								○	○	○	○	○
	Faithful								○	○	○	○	○
	Monochrome								○	○	○	○	○
	User Defined								○	○	○	○	○
Color space	sRGB	●	●	●	●	●	●	○	○	○	○	○	
	Adobe RGB							○	○	○	○	○	
White balance	Auto WB	●	●	●	●	●	●	○	○	○	○	○	
	Preset WB							○	○	○	○	○	
	Custom WB							○	○	○	○	○	
	Color temperature setting							○	○	○	○	○	
	WB correction							○	○	○	○	○	
	WB bracketing							○	○	○	○	○	
AF	One-Shot		●	●	●		●	○	○	○	○	●	
	AI Servo					●		○	○	○	○	–	
	AI Focus	●						●	○	○	○	–	
	AF point selection	Auto	●	●	●	●	●	●	○	○	○	○	●
		Manual							○	○	○	○	–
AF-assist beam	●	●		●		●		○	○	○	○	○	

●: Set automatically ○: User selectable

Mode Dial		Basic Zone						Creative Zone					
									P	Tv	Av	M	A-DEP
Exposure	Evaluative	●	●	●	●	●	●	●	○	○	○	○	○
	Partial								○	○	○	○	○
	Spot								○	○	○	○	○
	Center-weighted average								○	○	○	○	○
Metering mode	Program shift								○				
	Exposure compensation								○	○	○		○
	AEB								○	○	○	○	○
	AE lock								○	○	○		○
	Depth-of-field preview								○	○	○	○	○
Drive	Single	●		●	●		●	●	○	○	○	○	○
	High-speed continuous					●			○	○	○	○	○
	Low-speed continuous		●						○	○	○	○	○
	Self-timer	○	○	○	○	○	○	○	○	○	○	○	○
Built-in flash	Auto	●	●		●		●						
	Manual								○	○	○	○	○
	Flash off			●		●		●					
	Red-eye reduction	○	○		○		○		○	○	○	○	○
	FE lock								○	○	○	○	○
	Flash exposure compensation								○	○	○	○	○
Custom Functions/Clearing All Custom Functions									○	○	○	○	○
Camera setting reset									○	○	○	○	○
Image sensor cleaning									○	○	○	○	○

AF Modes and Drive Modes

Drive mode	AF mode		
	One-Shot AF	AI Focus AF	AI Servo AF
<input type="checkbox"/> Single shooting	An image cannot be taken unless focus is achieved. When focus is achieved, it is locked. With evaluative metering, the exposure setting is also locked. (The exposure setting is stored in memory before the shot is taken.)	Automatically switches between One-Shot AF and AI Servo AF according to the subject status.	The focus tracks the subject movement. The exposure is set at the moment the picture is taken.
<input checked="" type="checkbox"/> High-speed continuous shooting <input checked="" type="checkbox"/> Low-speed continuous shooting	The above conditions apply during continuous shooting. (<input checked="" type="checkbox"/> : Max. 5 fps (approx.), <input checked="" type="checkbox"/> : Max. 3 fps (approx.) Focusing is not executed during continuous shooting.		The above conditions apply during continuous shooting. (<input checked="" type="checkbox"/> : Max. 5 fps (approx.), <input checked="" type="checkbox"/> : Max. 3 fps (approx.) Focusing is executed even during continuous shooting.

AE Lock

(In Creative Zone modes)

Metering mode	AF point selection	
	Automatic AF point selection	Manual AF point selection
<input checked="" type="checkbox"/> Evaluative Metering*	AE lock is applied at the AF point that achieved focus.	AE lock is applied at the selected AF point.
<input checked="" type="checkbox"/> Partial Metering	AE lock is applied at the center AF point.	
<input checked="" type="checkbox"/> Spot Metering		
<input type="checkbox"/> Center-weighted Average Metering		

* When the lens' focus mode switch is set to <MF>, AE lock is applied at the center AF point.



Image Conversion Factor

Since the image area is smaller than the 35mm film format, it will look like the lens focal length is increased by 1.6x.

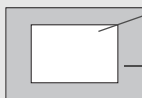

Image size

22.5 x 15.0mm (0.89 x 0.59 in)

35mm image size

36 x 24mm (1.42 x 0.95 in)

Program Line

The following program line applies when the camera is in Program AE <P> mode.

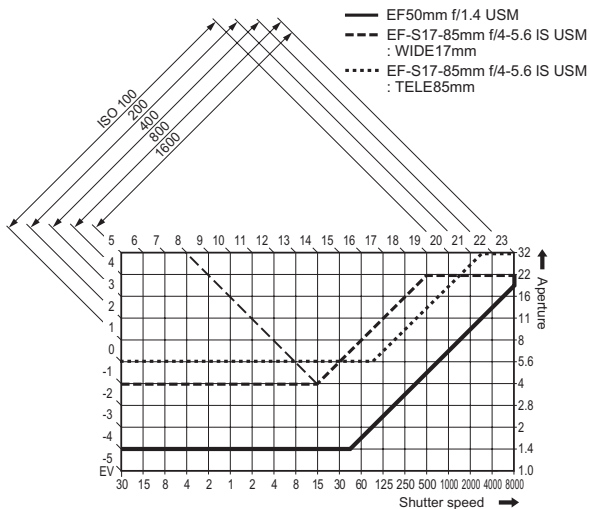

Program Line Description

The lower horizontal axis represents the shutter speed, and the right-hand vertical axis represents the aperture. The combinations of shutter speed and aperture automatically determined by Program AE are shown as lines with respect to the subject brightness (Exposure Value) gradations on the left and top edges of the graph.

Example: Using an EF-S17-85mm f/4-5.6 IS USM lens with a subject brightness of EV8, the point where the diagonal line from EV8 (on the top edge) intersects the Program AE line represents the corresponding shutter speed (1/15 second) and aperture (f/4) that the program sets automatically.

The diagonal arrowed lines at the upper left indicate the metering range for each ISO speeds.

Troubleshooting Guide

If there is a problem, first refer to this Troubleshooting Guide. If this Troubleshooting Guide does not resolve the problem, contact your dealer or nearest Canon Service Center.

Power Source

The battery cannot be recharged.

- **You are using the wrong battery.**
 - ▶ Do not recharge any battery pack other than Battery Pack BP-511A, BP-514, BP-511, or BP-512.
- **The battery is not properly attached to the battery charger.**
 - ▶ Attach the battery properly to the charger. (p.22)

The camera does not operate even when the  switch is set to <ON> or <∩>.

- **The battery is exhausted.**
 - ▶ Recharge the battery. (p.22)
- **The battery is not installed properly.**
 - ▶ Install the battery properly. (p.24)
- **Battery compartment cover is not closed.**
 - ▶ Close the battery compartment cover securely. (p.24)
- **CF card slot cover is not closed.**
 - ▶ Close the CF card slot cover securely. (p.28)

The access lamp remains on even when the  switch is set to <OFF>.

- **If you set the  switch to <OFF> right after shooting, the access lamp will still light for a few seconds while the image is recorded onto the CF card.**
 - ▶ When the camera finishes recording the image to the CF card, the access lamp will turn off and the power will turn off automatically.

The battery becomes exhausted quickly.

- **The battery is not fully charged.**
 - ▶ Recharge the battery fully. (p.22)
- **The battery's service life has expired.**
 - ▶ Replace the battery with a new one.

The camera turns off by itself.

- **Auto power off is in effect.**
 - ▶ Press the shutter button halfway. If you do not want auto power off to take effect, set [**↑ Auto power off**] on the menu to [**Off**].

Only the <☐> icon blinks on the top LCD panel.

- **The battery is almost exhausted.**
 - ▶ Recharge the battery. (p.22)

Shooting**No images can be shot or recorded.**

- **The CF card is not properly inserted.**
 - ▶ Insert the CF card properly. (p.28)
- **The CF card is full.**
 - ▶ Use a new CF card or erase unnecessary images. (p.28, 124)
- **The battery is exhausted.**
 - ▶ Recharge the battery. (p.22)
- **You did not focus well. (The focus confirmation light <●> in the viewfinder blinks.)**
 - ▶ Press the shutter button halfway again and focus the subject. If you still cannot focus properly, focus manually. (p.30, 80)

The LCD monitor does not display a clear image.

- **The LCD monitor screen is dirty.**
 - ▶ Use a soft, lens cloth to clean the screen.
- **The LCD's service life has expired.**
 - ▶ Consult your nearest customer service center or dealer.

The image is out of focus.

- **The lens focus mode switch is set to <MF>.**
 - ▶ Set the lens focus mode switch to <AF>. (p.27)
- **Camera shake occurred when you pressed the shutter button.**
 - ▶ To prevent camera shake, hold the camera still and press the shutter button gently. (p.30, 44)

The CF card cannot be used.

- **[Err **] is displayed on the LCD panel.**
 - ▶ If it is [Err CF], see page 126.
 - ▶ If it is [Err 02], see page 183.

Image Review & Operation

The image cannot be erased.

- **The image is erase-protected.**
 - ▶ Cancel the protection. (p.123)

The wrong shooting date and time is displayed.

- **The correct date and time has not been set.**
 - ▶ Set the correct date and time. (p.39)

No image appears on the TV screen.

- **Video cable plugs are not inserted all the way.**
 - ▶ Insert the video cable plugs firmly all the way. (p.122)
- **The correct video format (NTSC or PAL) has not been set.**
 - ▶ Set the camera to the correct video format to match the TV set. (p.36)
- **You are not using the video cable that came with the camera.**
 - ▶ Use the video cable that came with the camera. (p.122)

Error Codes

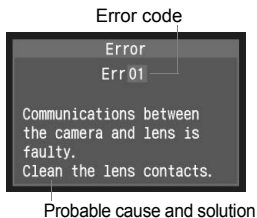

If an error occurs, the camera's LCD monitor will display the error screen, and the LCD panel will display an error code like "Err xx." To resolve the error, follow the instructions on the LCD monitor. If an error keeps occurring, there may be a problem. Write down the error code and consult your nearest Canon Service Center.

To exit the error screen, set the  switch <OFF> and <ON> or remove and reinstall the battery.

Error Code	Countermeasures
Err 01	Communications between the camera and lens is faulty. Clean the lens contacts. (p.11)
Err 02	There is a problem with the CF card. Try any of the following: <ul style="list-style-type: none">• Replace the CF card.• Remove and reinsert the CF card.• Format the CF card.
Err 04	The CF card is full and cannot record further. Erase unnecessary images in the card or replace the CF card.
Err 05	The auto pop-up of the built-in flash has been obstructed.
Err 99	An error other than the above has occurred. This error may occur if you use a non-Canon lens and the camera or lens does not operate properly.



If an error code appears right after shooting, the picture might not have been captured. When the camera is ready to shoot again, press the  button and check if the picture was captured.

Major Accessories (Optional)



Battery Pack BP-511A

High-capacity, lithium-ion, secondary power pack.



AC Adapter Kit ACK-E2

Power source kit (AC adapter, DC coupler, power cord) for supplying power to the camera with a household power outlet. Compatible with 100 - 240 V AC.



Compact Power Adapter CA-PS400

Quick charger for BP-511A. It takes about 110 minutes to recharge one pack. Two packs can be attached to it at one time. DC Coupler DR-400 (optional) can also be connected to the CA-PS400. Compatible with 100 - 240 V AC.



Battery Grip BG-E2

This accommodates two BP-511A packs or six size-AA batteries. It has a vertical-grip shutter button, electronic dial, AE lock/FE lock button, and AF point selection button.



Semi-Hard Case EH17-L

Dedicated case to protect the camera.

It can accommodate the camera attached with the EF-S17-85mm f/4-5.6 IS USM lens (optional).



Shoe-mount Speedlites

An EX-series Speedlite can be attached to the camera's hot shoe. In the same way as normal exposures, you can use E-TTL II autoflash for flash exposures.



Macro Lites

The EX-series Macro Lites (two models) are ideal for close-up flash photography. You can fire only one or both flash tubes and control the flash ratio to easily obtain sophisticated lighting effects with E-TTL II autofocus.



Remote Switch RS-80N3

This is a remote switch to prevent camera shake for super-telephoto shots, macroshooting, and bulb exposures. The cord is 80 cm/2.6 ft. The switch provides the same effect as pressing the shutter button halfway or completely. A shutter-release lock is also provided. The connection plug for the camera has a quick-lock feature.



Timer Remote Controller TC-80N3

Attached with an 80 cm/2.6 ft cord, this remote switch has four built-in functions: 1. Self-timer, 2. Interval timer, 3. Bulb-exposure timer, and 4. Shutter-release count setting. The timer can be set anywhere from 1 sec. to 99 hours, 59 min., 59 sec. in 1-sec. increments. The connection plug for the camera has a quick-lock feature.



Wireless Controller LC-5

Wireless controller effective up to 100 meters/330 ft. It consists of a transmitter and receiver. The receiver's camera connection plug connects to the camera's remote control terminal.



E-series Dioptric Adjustment Lenses

One of ten E-series dioptric adjustment lenses (-4 to +3 diopters) can be attached to the camera's eyepiece to further expand the dioptric adjustment range.

System Map

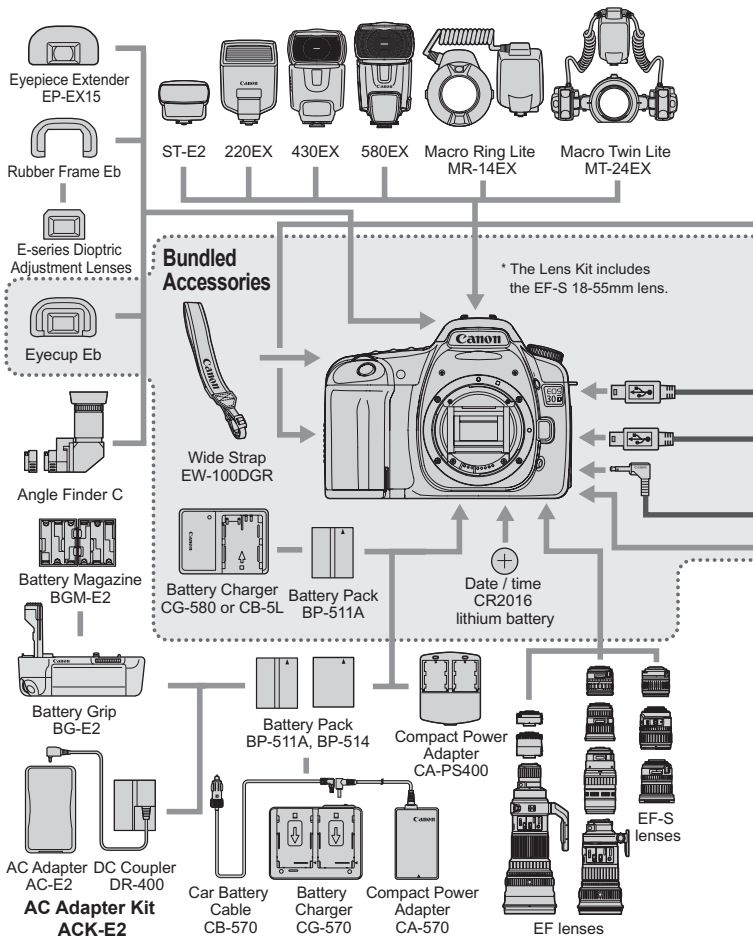

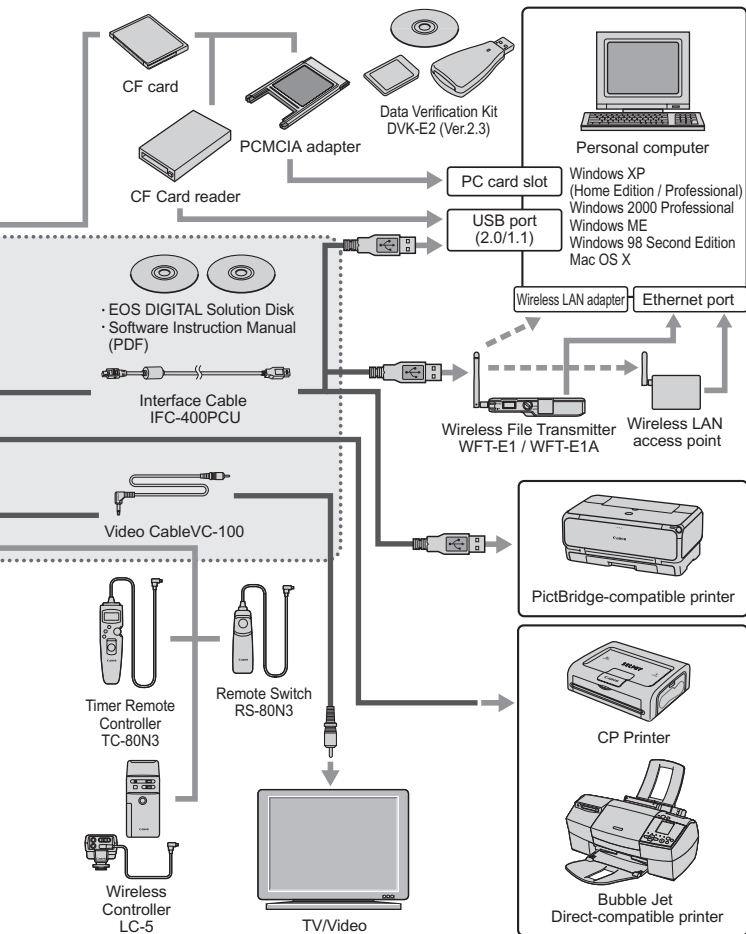

Specifications

• Type

Type:	Digital, single-lens reflex, AF/AE camera with built-in flash
Recording media:	Type I or II CF card * Compatible with Microdrive and 2GB or larger CF cards
Image sensor size:	22.5 x 15.0mm
Compatible lenses:	Canon EF lenses (including EF-S lenses) (35mm-equivalent focal length is equal to approx. 1.6 times the marked focal length)
Lens mount:	Canon EF mount

• Imaging Element

Type:	High-sensitivity, high-resolution, large single-plate CMOS sensor
Pixels:	Effective pixels: Approx. 8.20 megapixels Total pixels: Approx. 8.50 megapixels
Aspect ratio:	3:2
Color filter system:	RGB primary color filter
Low-pass filter:	Located in front of the image sensor, non-removable

• Recording System

Recording format:	Design rule for Camera File System 2.0
Image type:	JPEG, RAW (12bit)
RAW+JPEG	
simultaneous recording:	Possible
File size:	(1) Large/Fine: Approx. 3.6MB (3504 x 2336 pixels) (2) Large/Normal: Approx. 1.8MB (3504 x 2336 pixels) (3) Medium/Fine: Approx. 2.2MB (2544 x 1696 pixels) (4) Medium/Normal: Approx. 1.1MB (2544 x 1696 pixels) (5) Small/Fine: Approx. 1.2MB (1728 x 1152 pixels) (6) Small/Normal: Approx. 0.6MB (1728 x 1152 pixels) (7) RAW: Approx. 8.7MB (3504 x 2336 pixels) * Exact file sizes depend on the subject, ISO speed, Picture Style, etc.
File numbering:	Consecutive numbering, auto reset, manual reset
Color space:	sRGB, Adobe RGB
Picture Style:	Standard, Portrait, Landscape, Neutral, Faithful, Monochrome, User Def. 1 - 3
Interface:	USB port (USB 2.0 Hi-Speed): For connection to a personal computer and direct printing Video OUT terminal (NTSC/PAL)

• White Balance

Type:	Auto, daylight, shade, cloudy, tungsten light, white fluorescent light, flash, custom, color temperature setting
Auto white balance:	Auto white balance with the image sensor
Color temperature compensation:	White balance correction: ±9 stops in full-stop increments White balance bracketing: ±3 stops in full-stop increments * Blue/amber bias or magenta/green bias possible
Color temperature information transmission:	Provided

• Viewfinder

Type:	Eye-level pentaprism
Coverage:	Vertical/Horizontal approx. 95%
Magnification:	Approx. 0.9x (-1 diopter with 50mm lens at infinity)
Eyepoint:	Approx. 20 mm
Built-in dioptic adjustment:	-3.0 - +1.0 diopter
Focusing screen:	Fixed, precision matte
Mirror:	Quick-return half mirror (Transmission:reflection ratio of 40:60, no mirror cut-off with EF600mm f/4L IS USM or shorter lens)
Viewfinder information:	AF information (AF points, focus confirmation light), exposure information (shutter speed, aperture, ISO speed, AE lock, exposure level, spot metering circle, exposure warning), flash information (flash-ready, red-eye reduction lamp-on indicator, high-speed sync, FE lock, flash exposure compensation), white balance correction, maximum burst, CF card information
Depth-of-field preview:	Enabled with depth-of-field preview button

• Autofocus

Type:	TTL secondary image-registration, phase detection
AF points:	9 AF points
Metering range:	EV -0.5 - 18 (at 20°C/68°F, ISO 100)
Focus modes:	One-Shot AF, AI Servo AF, AI Focus AF, Manual focusing (MF)
AF point selection:	Auto, manual
Selected AF point display:	Superimposed in viewfinder and indicated on LCD panel

AF-assist beam: Small series of flashes fired by built-in flash
Effective range: Approx. 4.0m/13.1ft. at center, approx.
3.5m/11.5ft. at periphery

• Exposure Control

Metering modes: 35-zone TTL full aperture metering

- Evaluative metering (linkable to any AF point)
- Partial metering (approx. 9% of viewfinder at center)
- Spot metering (approx. 3.5% of viewfinder at center)
- Center-weighted average metering

Metering range: EV 1-20 (at 20°C/68°F with EF50mm f/1.4 USM lens, ISO 100)

Exposure control: Program AE (Full Auto, Portrait, Landscape, Close-up, Sports, Night Portrait, Flash Off, Program), shutter-priority AE, aperture-priority AE, depth-of-field AE, manual exposure, E-TTL II autoflash

ISO speed: Basic Zone modes: ISO 100 - 400 set automatically
Creative Zone modes: Equivalent to ISO 100 - 1600 (in 1/3-stop increments), ISO speed can be expanded to ISO 3200.

Exposure compensation: Manual: ± 2 stops in 1/3- or 1/2-stop increments (can be combined with AEB)
AEB: ± 2 stops in 1/3- or 1/2-stop increments

AE lock: Auto: Applied in One-Shot AF mode with evaluative metering when focus is achieved.
Manual: By AE lock button in all metering modes.

• Shutter

Type: Electronically-controlled, focal-plane shutter

Shutter speeds: 1/8000 to 30 sec. (1/3- and 1/2-stop increments), bulb X-sync at 1/250 sec.

Shutter release: Soft-touch electromagnetic release

Self-timer: 10-sec. delay

Remote control: Remote control with N3 type terminal

• Built-in Flash

Type: Retractable, auto pop-up flash

Flash metering: E-TTL II autoflash

Guide No.: 13/43 (ISO 100, in meters/feet)

Recycle time: Approx. 3 sec.

Flash-ready indicator: Flash-ready icon lights in viewfinder

Flash coverage:	17mm lens angle of view
FE lock:	Provided
Flash exposure compensation:	±2 stops in 1/3- or 1/2-stop increments

• External Speedlite

EOS-dedicated Speedlite:	E-TTL II autoflash with EX-series Speedlite
PC terminal:	Provided
Zooming to match lens focal length:	Provided

• Drive System

Drive modes:	Single, High-speed continuous, Low-speed continuous, and Self-timer (10 sec.)
Continuous:	High-speed: max. 5 shots per sec., Low-speed: max. 3 shots per sec.
Maximum burst:	JPEG (Large/Fine): Approx. 30, RAW: Approx. 11, RAW+JPEG (Large/Fine): Approx. 9 * Based on Canon's testing conditions with a 512MB CF card for high-speed continuous shooting. * Varies depending on the subject, ISO speed, Picture Style, CF card, etc.

• LCD Monitor

Type:	TFT color liquid-crystal monitor
Monitor size:	2.5 in.
Pixels:	Approx. 230,000
Coverage:	100% with respect to the effective pixels
Brightness adjustment:	Five levels provided
Interface languages:	15

• Image Playback

Display format:	Single image, shooting information, 9-image index, magnified view (Approx. 1.5x - 10x), autoplay, image rotation, and Jump (by 10 or 100 images, by date)
Highlight warning:	In the shooting information mode, any overexposed highlight areas with no image information will blink.
Histogram:	Brightness, RGB
AF point display:	Enabled

• Image Protection and Erase

- Protect: Single images can be erase-protected or not.
 Erase: One image or all images in the CF card can be erased (except protected images).

• Direct Printing

- Compatible printers: PictBridge, CP Direct, and Bubble Jet Direct-compatible printers
 Printable images: JPEG images (DPOF printing possible)
 Easy Printing feature: Provided

• DPOF: Digital Print Order Format

- DPOF: Version 1.1 compatible

• Direct Image Transfer

- Compatible images: JPEG and RAW images
 * Images to be used for wallpaper on the personal computer screen must be JPEG images.

• Customization

- Custom Functions: 19 Custom Functions with 53 settings

• Power Source

- Battery: One Battery Pack BP-511A, BP-514, BP-511, or BP-512.
 * AC power can also be supplied with the DC Coupler.
 * With Battery Grip BG-E2, size-AA batteries can be used.

- Battery life: [Number of shots · approx.]

Temperature	Shooting Conditions	
	No Flash	50% Flash Use
At 20°C / 68°F	1100	750
At 0°C / 32°F	900	600

* The above figures apply when a fully-charged Battery Pack BP-511A is used.

- Battery check: Automatic
 Power saving: Provided. Power turns off after 1, 2, 4, 8, 15, or 30 min.
 Date/Time battery: One CR2016 lithium battery
 Startup time: Approx. 0.15 sec.

• Dimensions and Weight

Dimensions (W x H x D): 144 x 105.5 x 73.5 mm / 5.7 x 4.2 x 2.9 in.

Weight: Approx. 700 g / 24.7 oz. (body only)

• Operation Environment

Working temperature range: 0°C - 40°C / 32°F - 104°F

Working humidity: 85% or less

• Battery Pack BP-511A

Type: Rechargeable lithium ion battery

Rated voltage: 7.4 V DC

Battery capacity: 1390 mAh

Dimensions (W x H x D): 38 x 21 x 55 mm / 1.5 x 0.8 x 2.2 in.

Weight: Approx. 82 g / 2.9 oz

• Battery Charger CG-580

Compatible battery: Battery Pack BP-511A, BP-514, BP-511, or BP-512

Recharging time: BP-511A, BP-514: Approx. 100 min.

BP-511, BP-512: Approx. 90 min.

Rated input: 100 - 240 V AC

Rated output: 8.4 V DC

Working temperature range: 0°C - 40°C / 32°F - 104°F

Working humidity: 85% or less

Dimensions (W x H x D): 91 x 67 x 31 mm / 3.6 x 2.6 x 1.2 in.

Weight: Approx. 115 g / 4.0 oz

• Battery Charger CB-5L

Compatible battery: Battery Pack BP-511A, BP-514, BP-511, or BP-512

Power cord length: Approx. 1.8 m / 5.9 ft.

Recharging time: BP-511A, BP-514: Approx. 100 min.

BP-511, BP-512: Approx. 90 min.

Rated input: 100 - 240 V AC

Rated output: 8.4 V DC

Working temperature range: 0°C - 40°C / 32°F - 104°F

Working humidity: 85% or lower

Dimensions (W x H x D): 91 x 67 x 32.3 mm / 3.6 x 2.6 x 1.3 in.

Weight: Approx. 105 g / 3.7 oz (excluding power cord)

• **EF-S18-55mm f/3.5-5.6 II**

Angle of view:	Diagonal extent: 74°20' - 27°50' Horizontal extent: 64°30' - 23°20' Vertical extent: 45°30' - 15°40'
Lens construction:	11 elements in 9 groups
Minimum aperture:	f/22 - 36
Maximum magnification and field of view:	18mm: 0.10x (161 x 246 mm / 6.3 x 9.7 in.) 55mm: 0.28x (54 x 81 mm / 2.1 x 3.2 in.)
Closest focusing distance:	0.28 m / 0.92 ft.
Filter size:	58mm
Hood:	EW-60C
Diameter x length:	68.5 x 66 mm / 2.7 x 2.6 in.
Weight:	190 g / 6.7 oz.
Case:	LP814

- All the specifications above are based on Canon's testing standards.
- The camera's specifications and physical appearance are subject to change without notice.

Index

A

AC Adapter Kit	26, 184
Access lamp.....	29
Accessories.....	184
Add original decision data.....	174
A-DEP	92
Adjust levels.....	136
Adobe RGB.....	63
AE	84
AE lock.....	96, 178
AEB.....	94
AF mode	74
AF point.....	77
AF point display	114
AF-assist beam.....	78, 169
AI Focus AF	76
AI Servo AF.....	75
Aperture	88
Attaching the Strap.....	21
Auto play	120
Auto playback	120
Auto power off.....	30, 43
Auto reset.....	71
Auto rotate	111
Automatic AF point selection	77
Av.....	88

B

B/W	134
Basic Zone modes	18
Battery.....	22, 24, 184
Battery Charger.....	19
Battery check	24
Beeper	100
Bracket sequence	171

Brightener.....	136
Brightness	135
Brightness display	115
Bubble Jet Direct	142
Built-in Flash.....	102
Bulb exposures.....	97
Bundled Items	3

C

C.Fn.....	168
Camera setting display.....	72
Center-weighted	
Average Metering	81
CF card.....	11, 28, 126
Clear all camera settings.....	37
Clear all Custom Functions	167
Clear settings	36
Close-up	48
Color saturation	58, 136
Color space	63
Color temperature	66
Color tone.....	58, 136
Communication	129, 160
Compression rate.....	52
Continuous	70
Continuous shooting.....	82
Contrast.....	58, 136
Cool tone	134
CP Direct	139
Creative Zone modes	18
Custom Functions	168
Custom WB	65

D

Date and file number imprinting.....	137
--------------------------------------	-----

- DC coupler 26
- Depth-of-field preview 89
- Dioptric Adjustment 44
- Direct printing 127, 155
- DPOF 149
- DPOF Transfer Images 162
- Drive modes 82
- E**
- Easy Printing 147
- EF/EF-S lens 27
- Erase 124
- Erasing a single image 124
- Erasing all images 125
- Error Codes 183
- E-TTL II autoflash 102, 107, 173
- Evaluative metering 81
- Exposure compensation 93
- Exposure level increments 170
- EX-series Speedlite 107
- Extension 52, 71
- External flash 107
- Eyepiece cover 21, 99
- F**
- Faithful 56
- FE lock 105, 107
- FEB 107
- File No. 70
- Filter effects 60
- Firmware 36
- Flash 102, 107, 108
- Flash exposure
compensation 106, 107
- Flash off 49
- Flash sync speed 168
- Focus confirmation light 17
- Focus lock 79
- Focus mode switch 74, 80
- Folder 70
- Format 126
- FP flash 107
- Full Auto 46
- Function Availability Table 176
- H**
- Highlight alert 114, 115
- High-speed continuous 82
- High-speed sync 107
- Histogram 115
- Holding the Camera 44
- I**
- Image Conversion Factor 178
- Image processing 53
- Image review time 110
- Image Transfer 157
- Image Zone 18
- Image-recording Quality 52
- Index 151
- Index display 116
- INFO 72, 114
- Interface cable 130, 161
- ISO expansion 170
- ISO speed 55
- J**
- JPEG 52
- Jump by 10 images/100 images 119
- Jump by date 119
- Jump display 118

L

LAN (WFT-E1)	36
Landscape	48, 56
Language	38
LCD brightness	112
LCD monitor	11, 36
LCD panel	11, 16
LCD panel illumination	99
Lens	11, 27
Low-speed continuous	82

M

M (Manual)	90
Magnified view	117
Main Dial	20, 31
Manual AF point selection	77
Manual Focusing	80
Manual reset	71
Maximum Burst	54
Menus	33, 35, 36
Metering mode	81
MF	80
Mirror Lockup	98
Mode Dial	18
Monochrome	57
Multi-controller	20, 32

N

Natural/M	134
Neutral	56
Night Portrait	49
Noise reduction	168
Nomenclature	14
Non-Canon Flash Units	108
NTSC	36, 122

Number of copies ...	137, 140, 143, 152
----------------------	--------------------

O

One-Shot AF	75
-------------------	----

P

P (Program)	84
PAL	36, 122
Paper settings	132
Partial metering	81
PC terminal	108
PictBridge	132
Picture Style	56 - 62
Playback	113
Playback menu	33, 35
Portrait	48, 56
Possible shots	25, 53
Power outlet	26
Power Switch	20, 30
Pressing completely	30
Pressing halfway	30
Print ordering (DPOF)	149
Print/PC	129, 160
Print/Share button	147, 162 - 164
Printing Effects	134
Program AE	84
Program shift	85
Protect	123
Protection	123

Q

Quick Control Dial	20, 32
--------------------------	--------

R

RAW	53
RAW+JPEG	52

Recharge	22
Red-eye corr.	136
Red-eye Reduction	104
Remote Switch.....	100
Replacing the date/time battery	40
RGB display.....	115
Rotate	111, 121

S

Safety shift.....	173
Selecting all images.....	154, 159
Selecting Individual Images	152, 158
Self-timer	50, 82
Sensor cleaning.....	41
Setting the date/time.....	39
Set-up menu	33, 36
Sharpness.....	58
Shoot w/o card.....	43
Shooting Information.....	114
Shooting menu.....	33, 35
Shooting mode.....	18
Shutter button	30
Shutter curtain synchronization	173
Shutter speed	86
Single image display.....	113
Single shooting	82
Specifications.....	188
Sports.....	49
Spot metering.....	81
sRGB	63
Standard	56, 151
Style.....	139, 142
Superimposed display	171
System Map.....	186

T

Timer	20
Toning effect.....	60
Transfer all images.....	162
Transfer failed images.....	72
Transfer new images.....	162
Transfer order.....	158
Transferring Images to a Personal Computer	162
Trimming	145
Tv	86

U

User Defined	57
--------------------	----

V

Video cable	122
Video OUT	122
Viewfinder	17
Vivid	134

W

Wallpaper	164
Warm tone.....	134
WB-BKT	68
White balance	64
White balance bracketing.....	68
White balance correction.....	67
Wireless, multi-Speedlite system	107



European Union (and EEA) only.

This symbol indicates that this product is not to be disposed of with your household waste, according to the WEEE Directive (2002/96/EC) and your national law. This product should be handed over to a designated collection point, e.g., on an authorized one-for-one basis when you buy a new similar product or to an authorized collection site for recycling waste electrical and electronic equipment (EEE). Improper handling of this type of waste could have a possible negative impact on the environment and human health due to potentially hazardous substances that are generally associated with EEE. At the same time, your cooperation in the correct disposal of this product will contribute to the effective usage of natural resources. For more information about where you can drop off your waste equipment for recycling, please contact your local city office, waste authority, approved WEEE scheme or your household waste disposal service.

For more information regarding return and recycling of WEEE products, please visit www.canon-europe.com/environment. (EEA: Norway, Iceland and Liechtenstein)

Canon

CANON INC.

30-2 Shimomaruko 3-chome, Ohta-ku, Tokyo 146-8501, Japan

Europe, Africa & Middle East

CANON EUROPA N.V.

PO Box 2262, 1180 EG Amstelveen, The Netherlands

CANON (UK) LTD

For technical support, please contact the Canon Help Desk:

P.O. Box 431, Wallington, Surrey, SM6 0XU, UK

Tel: (08705) 143723 (Calls may be recorded)

Fax: (08705) 143340

For sales enquiries, please call on (0121) 666-6262

CANON COMMUNICATION & IMAGE FRANCE S.A.

102 Avenue du Général de Gaulle,

92257 LA GARENNE COLOMBES CEDEX, France

Tel : Hot line 08 25 00 29 23

<http://www.cci.canon.fr>

CANON DEUTSCHLAND GmbH

Postfach 100401, 47704 Krefeld, Germany

Canon Hotline Service: 0180/5006022 (0,12 € / Min.)

www.canon.de

CANON ITALIA S.P.A.

Via Milano 8, I-20097 San Donato Milanese (MI), Italy

Tel: 02/8248.1

Fax: 02/8248.4604

Pronto Canon: 02/8249.2000

E-mail: supporto@canon.it

<http://www.canon.it>

CANON ESPAÑA S.A.

C/Joaquín Costa, 41 – 28002 Madrid, Spain

Tel. Atención al Cliente: 901.301.301

Help Desk: 807.117.255

<http://www.canon.es>

CANON BELGIUM N.V. / S.A.

Bessenveldstraat 7, B – 1831 Diegem, Belgium

Tel.: (02) 722.04.11

Fax: (02) 721.32.74

Helpdesk : 0900-10627

<http://www.canon.be>

CANON LUXEMBOURG S.A.

Rue des Jons 21, L-1818 Howald, Luxembourg

Tel.: (0352) 48 47 961

Fax: (0352) 48 47 96232

Helpdesk : 900-74100

<http://www.canon.lu>

CANON NEDERLAND N.V.

Neptunusstraat 1, 2132 JA Hoofddorp, The Netherlands

Tel.: 023 – 5 670 123

Fax: 023 – 5 670 124

Helpdesk: 023 – 5 681 681

<http://www.canon.nl>

CANON DANMARK A/S

Knud Høigaards Vej 1, DK-2860 Søborg, Denmark

Tlf: 70 15 50 05

Fax: 44 88 22 99

www.canon.dk

CANON NORGE as

Hallagerbakken 110, Postboks 33, Holmlia, 1201 Oslo, Norway

Tlf: 22 62 93 21

Faks: 22 62 06 15

E-mail: helpdesk@canon.no

<http://www.canon.no>

Finland

CANON OY

Kuluttajatuotteet, Huopalahdentie 24, PL1, 00351 Helsinki, Finland

Helpdesk: 020 366 466 (pvm)

Internet: www.canon.fi

CANON SVENSKA AB

Gustav III:s Boulevard 26, S-169 88 Solna, Sweden

Helpdesk: 08-744 8620

Fax 08-744 8527

<http://www.canon.se>

CANON (SCHWEIZ) AG

Industriestrasse 12, 8305 Dietlikon, Switzerland

Consumer Imaging Group

Tel. 01-835-61 61

Hotline 0900 57 55 20 (CHF 2.13/min)

<http://www.canon.ch>

Austria

CANON GES.M.B.H.

Zetschegasse 11, A – 1230 Wien, Austria

Helpdesk Tel.: 01 66 146 412

Fax: 01 66 146 413

<http://www.canon.at>

Portugal

SEQUE – SOC. NAC. EQUIP., S.A.

Pr. Alegria, 58 – 2ºC, 1269-149 Lisboa, Portugal

Tel: +351213242830

Fax: +351213472751

E-mail: info@seque.pt

<http://www.seque.pt>

This Instruction Manual booklet is current as of February 2006. For information on the camera's compatibility with any accessories and lenses introduced after this date, contact any Canon Service Center.