

EOS M5

Camera User Guide

- Make sure you read this guide, including the “Safety Precautions” (📖 15) section, before using the camera.
- Reading this guide will help you learn to use the camera properly.
- Store this guide safely so that you can use it in the future.

- Click the buttons in the lower right to access other pages.
 - ▶: Next page
 - ◀: Previous page
 - 🔄: Page before you clicked a link
- To jump to the beginning of a chapter, click the chapter title at right.

Before Use

Basic Guide

Advanced Guide

Camera Basics

Auto Mode /
Hybrid Auto Mode

Other Shooting Modes

P Mode

Tv, Av, M, C1, and C2 Mode

Playback Mode

Wireless Features

Setting Menu

Accessories

Appendix

Index

ENGLISH



Before Use

Initial Information

Package Contents

Before use, make sure the following items are included in the package. If anything is missing, contact your camera retailer.

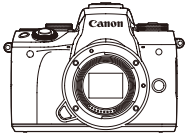

Camera
(with body cap)



Battery Pack
LP-E17
(with terminal cover)



Battery Charger
LC-E17/LC-E17E

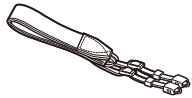

Neck Strap
EM-300DB

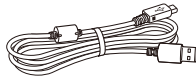

Interface Cable
IFC-600PCU

- Printed matter is also included.
- For details on the lens included in the lens kit, check information on the camera package.
- A memory card is not included.

Compatible Memory Cards

The following memory cards (sold separately) can be used, regardless of capacity.

- SD memory cards*¹
- SDHC memory cards*^{1*2}
- SDXC memory cards*^{1*2}



*1 Cards conforming to SD standards. However, not all memory cards have been verified to work with the camera.

*2 UHS-I memory cards are also supported.

Before Use

Basic Guide

Advanced Guide

Camera Basics

Auto Mode / Hybrid Auto Mode

Other Shooting Modes

P Mode

Tv, Av, M, C1, and C2 Mode

Playback Mode

Wireless Features

Setting Menu

Accessories

Appendix

Index



Preliminary Notes and Legal Information

- Take and review some test shots initially to make sure the images were recorded correctly. Please note that Canon Inc., its subsidiaries and affiliates, and its distributors are not liable for any consequential damages arising from any malfunction of a camera or accessory, including memory cards, that result in the failure of an image to be recorded or to be recorded in a way that is machine readable.
- The user's unauthorized photographing or recording (video and/or sound) of people or copyrighted materials may invade the privacy of such people and/or may violate others' legal rights, including copyright and other intellectual property rights, even when such photographing or recording is intended solely for personal use.
- For information on camera warranty or Canon Customer Support, please refer to the warranty information provided with your camera User Manual Kit.
- Although the screen (monitor) is produced under extremely high-precision manufacturing conditions and more than 99.99% of the pixels meet design specifications, in rare cases some pixels may be defective or may appear as red or black dots. This does not indicate camera damage or affect recorded images.
- When the camera is used over an extended period, it may become warm. This does not indicate damage.

Conventions in This Guide

- In this guide, icons are used to represent the corresponding camera buttons and dials on which they appear or which they resemble.
- The following camera buttons and controls are represented by icons.

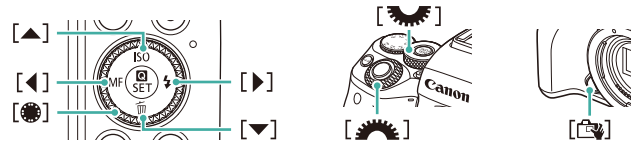

- Shooting modes and on-screen icons and text are indicated in brackets.
- ⓘ: Important information you should know
- 📌: Notes and tips for expert camera use
- ✎: Indicates touch-screen operations
- 📖xx: Pages with related information (in this example, “xx” represents a page number)
- Instructions in this guide apply to the camera under default settings.
- For convenience, all lenses and mount adapters are simply referred to as “lenses” and “mount adapters”, whether they are included or sold separately.
- The illustrations in this guide show the camera with the EF-M15-45mm f/3.5-6.3 IS STM lens attached as an example.
- For convenience, all supported memory cards are simply referred to as the “memory card”.
- The symbols ▶ Still Images” and ▶ Movies” below titles indicate how the function is used—whether for still images or movies.

Before Use

Basic Guide

Advanced Guide

Camera Basics

Auto Mode / Hybrid Auto Mode

Other Shooting Modes

P Mode

Tv, Av, M, C1, and C2 Mode

Playback Mode

Wireless Features

Setting Menu

Accessories

Appendix

Index



Part Names

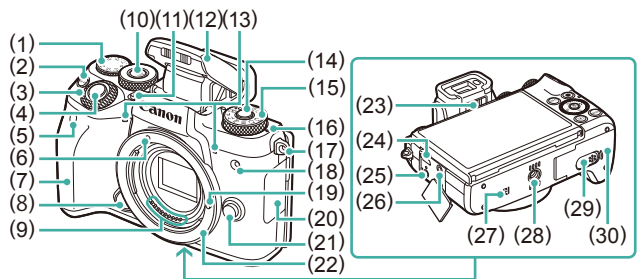

- | | |
|---|--------------------------------------|
| (1) Exposure compensation dial | (15) Mode dial |
| (2) M-Fn (Multi-function) button | (16) Focal plane mark |
| (3) Main dial | (17) Strap mount |
| (4) Shutter button | (18) Lamp |
| (5) Remote control sensor | (19) Lens lock pin |
| (6) EF-M lens mount index | (20) Terminal cover |
| (7) Grip | (21) Lens release button |
| (8) Touch & Drag AF switching button | (22) Lens mount |
| (9) Contacts | (23) Dioptic adjustment knob |
| (10) (Dial Function) button | (24) Digital terminal |
| (11) (Flash pop up) button | (25) Remote switch terminal |
| (12) Flash | (26) External microphone IN terminal |
| (13) Microphone | (27) (N-Mark)*1 |
| (14) Mode dial release button | (28) Tripod socket |
| | (29) DC coupler terminal cover |
| | (30) Memory card/battery cover |

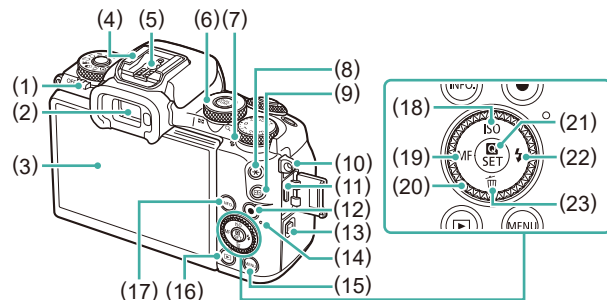

- | | |
|--|---|
| (1) Power switch | (11) HDMI™ terminal |
| (2) Viewfinder | (12) Movie button |
| (3) Screen (monitor)*2 / Touch-screen panel | (13) (Wi-Fi) button |
| (4) Hot shoe | (14) Indicator |
| (5) Flash-sync contacts | (15) MENU button |
| (6) Quick Control Dial Playback: (magnify) / (index) | (16) (Playback) button |
| (7) Speaker | (17) INFO. (Information) button |
| (8) (AE lock) button | (18) ISO / Up button |
| (9) (AF frame selector) button | (19) MF (Manual focus) / Left button |
| (10) Strap mount | (20) Control dial |
| | (21) (Quick Set menu/Set) button |
| | (22) (Flash) / Right button |
| | (23) (Erase) / Down button |

*1 Used with NFC features (130).

*2 Gestures may not be detected as easily if you apply a screen protector. In this case, increase the sensitivity of the touch-screen panel (160).



- You can turn the control dial to perform most of the operations possible with the **[▲][▼][◀][▶]** buttons, such as choosing items and switching images.

Before Use

Basic Guide

Advanced Guide

Camera Basics

Auto Mode / Hybrid Auto Mode

Other Shooting Modes

P Mode

Tv, Av, M, C1, and C2 Mode

Playback Mode

Wireless Features

Setting Menu

Accessories

Appendix

Index



Lens

EF-M Lens

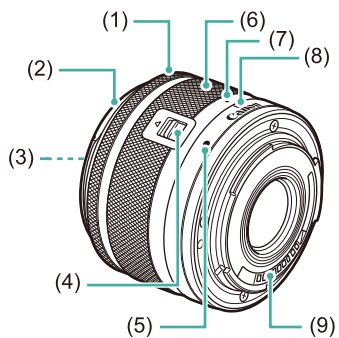

- (1) Focusing ring
- (2) Hood mount
- (3) Filter-mounting thread
- (4) Lens retraction switch
- (5) Lens mount index
- (6) Zoom ring
- (7) Lens retraction index
- (8) Zoom position index
- (9) Contacts

Before Use

Basic Guide

Advanced Guide

Camera Basics

Auto Mode / Hybrid Auto Mode

Other Shooting Modes

P Mode

Tv, Av, M, C1, and C2 Mode

Playback Mode

Wireless Features

Setting Menu

Accessories

Appendix

Index



Table of Contents

Before Use

Initial Information	2
Package Contents	2
Compatible Memory Cards	2
Preliminary Notes and Legal Information	3
Conventions in This Guide	3
Part Names	4
Lens	5
Common Camera Operations	14
Safety Precautions	15

Basic Guide

Basic Operations	18
Initial Preparations	18
Attaching the Strap	18
Removing the Strap	19
Holding the Camera	19
Charging the Battery Pack	19
Inserting the Battery Pack and Memory Card	20
Removing the Battery Pack and Memory Card	21
Setting the Date and Time	21
Changing the Date and Time	22
Display Language	23
Attaching a Lens	23
Detaching a Lens	24
Lens Instruction Manuals	24

Attaching EF and EF-S Lenses	24
Detaching a Lens	25
Using a Tripod	25
Using Lens Image Stabilization	26
Trying the Camera Out	26
Shooting (Scene Intelligent Auto)	26
Viewing	28
Erasing Images	29

Advanced Guide

Camera Basics	30
On/Off	30
Power-Saving Features (Auto Power Down)	31
Shutter Button	31
Viewfinder	32
Shooting Modes	33
Adjusting the Screen Angle	33
Tilting the Screen Downward	33
Tilting the Screen Upward	33
Shooting Display Options	34
Using the Quick Set Menu	34
Using Touch-Screen Operations to Configure Settings	35
Using the Menu Screen	35
Touch-Screen Operations	36
On-Screen Keyboard	37
Indicator Display	38
Auto Mode / Hybrid Auto Mode	39
Shooting with Camera-Determined Settings	39
Shooting (Scene Intelligent Auto)	39

Before Use

Basic Guide

Advanced Guide

Camera Basics

Auto Mode / Hybrid Auto Mode

Other Shooting Modes

P Mode

Tv, Av, M, C1, and C2 Mode

Playback Mode

Wireless Features

Setting Menu

Accessories

Appendix

Index



Shooting in Hybrid Auto Mode	41
Digest Movie Playback	41
Still Images/Movies	42
Still Images	42
Movies	42
Scene Icons	43
On-Screen Frames	44
Common, Convenient Features	44
Using the Self-Timer	44
Using the Self-Timer to Avoid Camera Shake	45
Customizing the Self-Timer	45
Shooting by Touching the Screen (Touch Shutter)	46
Continuous Shooting	46
Image Customization Features	47
Changing Image Quality	47
Capturing in RAW Format	48
Using the Menu	48
Changing the Aspect Ratio	49
Changing Movie Image Quality	49
Helpful Shooting Features	50
Using the Dual Axis Electronic Level	50
Using Auto Level	51
Customizing Camera Operation	51
Preventing the AF-Assist Beam from Firing	51
Deactivating the Red-Eye Reduction Lamp	51
Changing the Image Display Period after Shots	52
Other Shooting Modes	53
Shooting with Your Favorite Settings (Creative Assist)	53
Saving/Loading Settings	54
Saving Settings	54
Loading Settings	55
Using Settings from Images	55

Viewing Settings	55
Creative Zone Settings Corresponding to Creative Assist	
Mode Settings	55
Specific Scenes	56
Shooting Yourself under Optimal Settings (Self Portrait)	57
Enhancing Colors in Shots of Food (Food)	58
Conveying a Sense of Speed by Blurring the Background	
(Panning)	58
Shooting in Backlit Scenes (HDR Backlight Control)	59
Image Effects (Creative Filters)	59
Shooting in Monochrome (Grainy B/W)	60
Shooting with a Soft Focus Effect	60
Shooting with a Fish-Eye Lens Effect (Fish-Eye Effect)	60
Shots Resembling Oil Paintings (Art Bold Effect)	61
Shots Resembling Watercolors (Water Painting Effect)	61
Shooting with a Toy Camera Effect (Toy Camera Effect)	61
Shots Resembling Miniature Models (Miniature Effect)	62
Playback Speed and Estimated Playback Time	
(for One-Minute Clips)	62
Shooting High-Contrast Scenes (High Dynamic Range)	63
Adding Artistic Effects	63
Recording Movies in Movie Mode	64
Locking or Changing Image Brightness before Recording	64
Disabling Auto Slow Shutter	65
Recording Time-Lapse Movies (Time-Lapse Movie)	65
Sound Settings	66
Adjusting the Recording Volume	66
Deactivating the Wind Filter	67
Using the Attenuator	67
P Mode	68
Shooting in Program AE ([P] Mode)	68

Before Use
Basic Guide
Advanced Guide
Camera Basics
Auto Mode / Hybrid Auto Mode
Other Shooting Modes
P Mode
Tv, Av, M, C1, and C2 Mode
Playback Mode
Wireless Features
Setting Menu
Accessories
Appendix
Index



Setting Up Shooting from a Single Screen.....	69
Image Brightness (Exposure).....	69
Adjusting Image Brightness (Exposure Compensation).....	69
Deactivating Exposure Simulation.....	69
Locking Image Brightness / Exposure (AE Lock).....	70
Changing the Metering Method.....	70
Changing the ISO Speed.....	71
Adjusting ISO Auto Settings.....	71
Auto Exposure Bracketing (AEB Shooting).....	71
Auto Correction of Brightness and Contrast (Auto Lighting Optimizer).....	72
Shooting Bright Subjects (Highlight Tone Priority).....	72
Image Colors.....	73
Adjusting White Balance.....	73
Custom White Balance.....	73
Manually Correcting White Balance.....	74
Manually Setting White Balance Color Temperature.....	75
Customizing Colors (Picture Style).....	75
Customizing Picture Styles.....	76
Saving Customized Picture Styles.....	77
Focusing.....	77
Choosing the AF Method.....	77
1-point AF.....	78
AF+Tracking.....	78
Smooth Zone AF.....	78
Choosing Subjects to Focus On (Touch AF).....	79
Shooting with the AF Lock.....	79
Shooting with Servo AF.....	80
Changing the Focus Setting.....	80
Fine-Tuning the Focus.....	81
Shooting in Manual Focus Mode.....	81
Easily Identifying the Focus Area (MF Peaking).....	82

Flash.....	82
Changing the Flash Mode.....	82
Auto.....	83
On.....	83
Slow Synchro.....	83
Off.....	83
Adjusting the Flash Exposure Compensation.....	83
Shooting with the FE Lock.....	84
Changing the Flash Timing.....	84
Changing the Flash Metering Mode.....	84
Resetting Flash Settings.....	85
Other Settings.....	85
Switching to Other Functions to Adjust with the Quick Control Dial.....	85
Changing the IS Mode Settings.....	86
Correcting Camera Shake when Shooting Movies.....	86
Correcting Lens Aberrations.....	87
Lens Correction Data.....	87
Changing the Noise Reduction Level.....	88
Using Multi Shot Noise Reduction.....	88
Reducing Noise at Slow Shutter Speeds.....	89
Tv, Av, M, C1, and C2 Mode.....	90
Specific Shutter Speeds ([Tv] Mode).....	90
Specific Aperture Values ([Av] Mode).....	91
Depth-of-Field Preview.....	91
Specific Shutter Speeds and Aperture Values ([M] Mode).....	92
Shooting Long Exposures (Bulb).....	93
Adjusting the Flash Output.....	93
Recording Movies at Specific Shutter Speeds and Aperture Values.....	94
Customizing Controls and Display.....	95

Before Use

Basic Guide

Advanced Guide

Camera Basics

Auto Mode / Hybrid Auto Mode

Other Shooting Modes

P Mode

Tv, Av, M, C1, and C2 Mode

Playback Mode

Wireless Features

Setting Menu

Accessories

Appendix

Index



Customizing Display Information	95
Customizing the Information Displayed	95
Configuring Touch & Drag AF	95
Changing the Settings of Touch and Drag Operations	96
Restricting the Area of the Screen Available for Touch and Drag Operations	96
Configuring Custom Functions	96
Assigning Functions to Buttons and Dials	97
Assigning Functions to the Quick Control Dial	98
Customizing the Quick Set Menu	99
Choosing Items to Include in the Menu	99
Rearranging Menu Items	100
Saving Shooting Settings	100
Settings That Can Be Saved	100
Saving Commonly Used Shooting Menu Items (My Menu).....	101
Renaming My Menu Tabs	102
Deleting a My Menu Tab	102
Deleting All My Menu Tabs or Items	102
Customizing My Menu Tab Display	102
Playback Mode	103
Viewing	103
Touch-Screen Operations	104
Switching Display Modes	105
Customizing the Shooting Information Displayed	105
Overexposure Warning (for Image Highlights)	105
AF Point Display	105
Grid Display	105
Brightness Histogram	106
RGB Histogram	106
Viewing Short Movies Created When Shooting Still Images (Digest Movies).....	106
Viewing by Date	107

Browsing and Filtering Images	107
Navigating through Images in an Index	107
Touch-Screen Operations	108
Double-Touch Magnification	108
Finding Images Matching Specified Conditions	108
Using the Front Dial to Jump between Images	109
Touch-Screen Operations	110
Image Viewing Options	110
Magnifying Images	110
Touch-Screen Operations	111
Viewing Slideshows	111
Protecting Images	112
Using the Menu	112
Choosing Images Individually	112
Selecting a Range	113
Protecting All Images at Once	113
Clearing All Protection at Once	114
Erasing Images	114
Erasing Multiple Images at Once	115
Choosing a Selection Method	115
Choosing Images Individually	115
Selecting a Range	115
Specifying All Images at Once	116
Rotating Images	116
Using the Menu	116
Deactivating Auto Rotation	117
Rating Images (Rating)	117
Using the Menu	117
Editing Still Images	118
Resizing Images	118
Using the Menu	119
Cropping	119

Before Use

Basic Guide

Advanced Guide

Camera Basics

Auto Mode / Hybrid Auto Mode

Other Shooting Modes

P Mode

Tv, Av, M, C1, and C2 Mode

Playback Mode

Wireless Features

Setting Menu

Accessories

Appendix

Index



Applying Filter Effects.....	120
Correcting Red-Eye.....	121
Processing RAW Images with the Camera.....	122
Using the Menu.....	123
Choosing Images Individually.....	123
Selecting a Range.....	124
Editing Movies.....	124
Reducing File Sizes.....	125
Editing Digest Movies.....	126
Wireless Features.....	127
Available Wireless Features.....	127
Using Wi-Fi Features.....	127
Using Bluetooth® Features.....	127
Transferring Images to a Smartphone.....	128
Transferring Images to a Bluetooth Enabled Smartphone.....	128
Transferring Images to an NFC-Compatible Smartphone.....	130
Connecting via NFC When Camera Is in Shooting Mode... ..	130
Connecting via NFC When Camera Is in Playback Mode... ..	131
Connecting to a Smartphone via the Wi-Fi Menu.....	132
Using Another Access Point.....	134
Confirming Access Point Compatibility.....	134
Using WPS-Compatible Access Points.....	134
Connecting to Listed Access Points.....	135
Previous Access Points.....	136
Sending Images to a Registered Web Service.....	136
Registering Web Services.....	136
Registering CANON iMAGE GATEWAY.....	137
Registering Other Web Services.....	138
Uploading Images to Web Services.....	139
Viewing Images Using a Media Player.....	140
Printing Images Wirelessly from a Connected Printer.....	141

Sending Images to Another Camera.....	143
Image Sending Options.....	144
Sending Multiple Images.....	144
Choosing Images Individually.....	144
Selecting a Range.....	145
Sending Rated Images.....	145
Notes on Sending Images.....	146
Choosing the Number of Recording Pixels (Image Size).....	146
Adding Comments.....	146
Sending Images Automatically (Image Sync).....	147
Initial Preparations.....	147
Preparing the Camera.....	147
Preparing the Computer.....	147
Sending Images.....	148
Viewing Images Sent via Image Sync on a Smartphone.....	148
Using a Smartphone to View Camera Images and Control the Camera.....	149
Geotagging Images on the Camera.....	149
Controlling the Camera Remotely from a Smartphone.....	149
Controlling the Camera via Wi-Fi.....	149
Controlling the Camera via Bluetooth.....	150
Editing or Erasing Wireless Settings.....	151
Editing Connection Information.....	151
Changing a Device Nickname.....	151
Erasing Connection Information.....	152
Specifying Images Viewable from Smartphones.....	152
Changing the Camera Nickname.....	153
Returning the Wireless Settings to Default.....	153
Clearing Information of Devices Paired via Bluetooth.....	154

Before Use
Basic Guide
Advanced Guide
Camera Basics
Auto Mode / Hybrid Auto Mode
Other Shooting Modes
P Mode
Tv, Av, M, C1, and C2 Mode
Playback Mode
Wireless Features
Setting Menu
Accessories
Appendix
Index



Setting Menu	155
Adjusting Basic Camera Functions	155
Date-Based Image Storage	155
File Numbering	155
Formatting Memory Cards.....	156
Low-Level Formatting.....	156
Changing the Video System.....	157
Electronic Level Calibration.....	157
Resetting the Electronic Level.....	157
Using Eco Mode	157
Power-Saving Adjustment	158
Screen Brightness	158
Switching the Color of Screen Information	158
World Clock	159
Date and Time	159
Display Language.....	159
Muting Camera Sounds.....	159
Activating Camera Sounds	160
Hiding Hints and Tips.....	160
Listing Shooting Modes by Icon.....	160
Adjusting the Touch-Screen Panel	160
Cleaning the Image Sensor	161
Disabling Auto Cleaning	161
Activating Sensor Cleaning	161
Cleaning the Sensor Manually	162
Checking Certification Logos.....	162
Setting Copyright Information to Record in Images.....	162
Deleting All Copyright Information	163
Adjusting Other Settings.....	163
Restoring Default Camera Settings.....	163
Restoring All Camera Defaults	163
Restoring Defaults for Individual Functions.....	164

Accessories	165
System Map	166
Optional Accessories.....	167
Lenses.....	167
Power Supplies.....	167
Flash Units.....	168
Microphone.....	168
Other Accessories	168
Printers	169
Photo and Movie Storage.....	169
Using Optional Accessories.....	169
Playback on a TV	169
Powering the Camera with Household Power.....	170
Shooting Remotely	171
Using a Remote Switch (Sold Separately)	171
Using the Hot Shoe	171
Using an External Flash (Sold Separately).....	172
Setting External Flash Functions.....	172
Setting External Flash Custom Functions	174
Restoring External Flash Defaults.....	174
Using External Microphones (Sold Separately).....	174
Using the Software	176
Software	176
Software Instruction Manual.....	176
Checking Your Computer Environment	176
Installing the Software	176
Saving Images to a Computer.....	177
Printing Images	178
Easy Print	178

Before Use

Basic Guide

Advanced Guide

Camera Basics

Auto Mode /
Hybrid Auto Mode

Other Shooting Modes

P Mode

Tv, Av, M, C1, and C2 Mode

Playback Mode

Wireless Features

Setting Menu

Accessories

Appendix

Index



Configuring Print Settings.....	179
Cropping Images before Printing.....	179
Choosing Paper Size and Layout before Printing	180
Available Layout Options.....	180
Printing ID Photos	180
Printing Movie Scenes.....	181
Movie Printing Options	181
Adding Images to the Print List (DPOF).....	181
Configuring Print Settings.....	182
Setting Up Printing for Individual Images	182
Setting Up Printing for a Range of Images.....	183
Setting Up Printing for All Images.....	183
Clearing All Images from the Print List	183
Adding Images to a Photobook	183
Choosing a Selection Method	183
Adding Images Individually.....	184
Adding All Images to a Photobook	184
Removing All Images from a Photobook	184
Appendix.....	185
Troubleshooting.....	185
On-Screen Messages.....	189
On-Screen Information.....	191
When Shooting.....	191
Battery Level	191
During Playback	192
Info Display 1.....	192
Info Display 2.....	192
Info Display 3.....	192
Info Display 4.....	192
Info Display 5.....	193
Info Display 6.....	193
Info Display 7.....	193

Info Display 8.....	193
Summary of Movie Control Panel.....	193
Functions and Menu Tables	194
Functions Available in Each Shooting Mode	194
Quick Set Menu	196
Shooting Tab.....	198
C.Fn Tab	206
INFO. Quick Control	208
Set Up Tab.....	209
My Menu Tab	209
Playback Tab	210
Quick Set Menu in Playback Mode.....	210
Handling Precautions	211
Specifications	212
Type.....	212
Image Sensor	212
Focus Control.....	212
Exposure Control.....	212
White Balance	212
Shutter.....	213
Flash.....	213
Viewfinder/Monitor	213
Shooting	213
Recording.....	214
Playback.....	215
Customizing.....	215
Power	216
Interface	216
Operating Environment	216
Dimensions (CIPA compliant).....	216
Weight (CIPA compliant).....	216
Battery Pack LP-E17	216
Battery Charger LC-E17/ LC-E17E	217

Before Use

Basic Guide

Advanced Guide

Camera Basics

Auto Mode / Hybrid Auto Mode

Other Shooting Modes

P Mode

Tv, Av, M, C1, and C2 Mode

Playback Mode

Wireless Features

Setting Menu

Accessories

Appendix

Index



Index.....	218
Precautions for Wireless Features (Wi-Fi, Bluetooth, or Others).....	220
Radio Wave Interference Precautions.....	220
Security Precautions	220
Third-Party Software	221
Personal Information and Security Precautions	221
Trademarks and Licensing	221
Disclaimer.....	222

Before Use

Basic Guide

Advanced Guide

Camera Basics

Auto Mode / Hybrid Auto Mode

Other Shooting Modes

P Mode

Tv, Av, M, C1, and C2 Mode

Playback Mode

Wireless Features

Setting Menu

Accessories

Appendix

Index



Common Camera Operations

Shoot

- Use camera-determined settings (Auto Mode, Hybrid Auto Mode)
 - [139](#), [141](#)
- Shoot with effects of your choice (Creative Assist)
 - [53](#)
- Blur the background / Keep the background in sharp focus (Av Mode)
 - [91](#)
- Freeze the action / Blur the action (Tv Mode)
 - [90](#)
- Shoot yourself under optimal settings (Self Portrait)
 - [57](#)
- Apply special effects (Creative Filters)
 - [59](#)
- Shoot several shots at once (Continuous)
 - [46](#)
- Without using the flash (Flash Off)
 - [39](#)
- Include yourself in the shot (Self-Timer)
 - [44](#)

View

- View images (Playback Mode)
 - [103](#)
- Automatic playback (Slideshow)
 - [111](#)
- On a TV
 - [169](#)
- On a computer
 - [176](#)

- Browse through images quickly
 - [107](#)
- Erase images
 - [114](#)

Record/View Movies

- Record movies
 - [39](#), [64](#)
- View movies (Playback Mode)
 - [103](#)

Print

- Print pictures
 - [178](#)

Save

- Save images to a computer
 - [177](#)

Use Wireless Features

- Send images to a smartphone
 - [128](#)
- Share images online
 - [136](#)
- Send images to a computer
 - [147](#)

Before Use

Basic Guide

Advanced Guide

Camera Basics

Auto Mode / Hybrid Auto Mode

Other Shooting Modes

P Mode

Tv, Av, M, C1, and C2 Mode

Playback Mode

Wireless Features

Setting Menu

Accessories

Appendix

Index



Safety Precautions

- Before using the product, ensure that you read the safety precautions described below. Always ensure that the product is used correctly.
- The safety precautions noted here are intended to prevent you and other persons from being injured or incurring property damage.
- Be sure to also check the guides included with any separately sold accessories you use.



Warning

Denotes the possibility of serious injury or death.

- Do not fire the flash near the eyes. It may hurt the eyes.

• Store this equipment out of the reach of children and infants. A strap wound around a child's neck may result in asphyxiation. If your product uses a power cord, mistakenly winding the cord around a child's neck may result in asphyxiation. The hot shoe cover is dangerous if swallowed. If this occurs, contact a doctor immediately.

- Use only recommended power sources.
- Do not disassemble, alter, or apply heat to the product.
- Do not peel off the adhesive covering, if the battery pack has it.
- Avoid dropping or subjecting the product to severe impacts.
- Do not touch the interior of the product if it is broken, such as when dropped.
- Stop using the product immediately if it emits smoke or a strange smell, or otherwise behaves abnormally.
- Do not use organic solvents such as alcohol, benzene, or thinner to clean the product.

- Avoid contact with liquid, and do not allow liquid or foreign objects inside.

This could result in electrical shock or fire.

If the product gets wet, or if liquid or foreign objects get inside, remove the battery pack/batteries or unplug immediately.

- If your model has a viewfinder or interchangeable lens, do not look through the viewfinder or lens at bright light sources (such as the sun on a clear day, or a bright artificial light source).

This may damage your eyesight.

- If your model has an interchangeable lens, do not leave the lens (or the camera with the lens attached) in the sun without the lens cap on.

This could result in a fire.

- Do not touch the product during thunderstorms if it is plugged in. This could result in electrical shock or fire. Immediately stop using the product and distance yourself from it.

- Use only the recommended battery pack/batteries.

- Do not place the battery pack/batteries near or in direct flame.

This may cause the battery pack/batteries to explode or leak, resulting in electrical shock, fire, or injuries. If leaking battery electrolyte comes into contact with eyes, mouth, skin, or clothing, immediately flush with water.

- If the product uses a battery charger, note the following precautions.

- Remove the plug periodically and, using a dry cloth, wipe away any dust and dirt that has collected on the plug, the exterior of the power outlet, and the surrounding area.
- Do not insert or remove the plug with wet hands.
- Do not use the equipment in a manner that exceeds the rated capacity of the electrical outlet or wiring accessories. Do not use if the plug is damaged or not fully inserted in the outlet.
- Do not allow dust or metal objects (such as pins or keys) to contact the terminals or plug.
- Do not cut, damage, alter, or place heavy items on the power cord, if your product uses one.

This could result in electrical shock or fire.

Before Use

Basic Guide

Advanced Guide

Camera Basics

Auto Mode / Hybrid Auto Mode

Other Shooting Modes

P Mode

Tv, Av, M, C1, and C2 Mode

Playback Mode

Wireless Features

Setting Menu

Accessories

Appendix

Index



- Turn the camera off in places where camera use is prohibited. The electromagnetic waves emitted by the camera may interfere with the operation of electronic instruments and other devices. Exercise adequate caution when using the product in places where use of electronic devices is restricted, such as inside airplanes and medical facilities.

- Do not allow the camera to maintain contact with skin for extended periods.

Even if the camera does not feel hot, this may cause low-temperature burns, manifested in redness of the skin or blistering. Use a tripod in hot places, or if you have poor circulation or insensitive skin.

 **Caution** Denotes the possibility of injury.

- When carrying the product by the strap, be careful not to bang it, subject it to strong impacts or shocks, or let it get caught on other objects.

- Be careful not to bump or push strongly on the lens. This could lead to injury or damage the camera.

- Be careful not to subject the screen to strong impacts. If the screen cracks, injury may result from the broken fragments.

- When using the flash, be careful not to cover it with your fingers or clothing.

This could result in burns or damage to the flash.

- Avoid using, placing, or storing the product in the following places:
 - Places subject to direct sunlight
 - Places subject to temperatures above 40 °C (104 °F)
 - Humid or dusty places

These could cause leakage, overheating, or an explosion of the battery pack/batteries, resulting in electrical shock, fire, burns, or other injuries. Overheating and damage may result in electrical shock, fire, burns, or other injuries.

- The slideshow transition effects may cause discomfort when viewed for prolonged periods.

- When using optional lenses, lens filters, or filter adapters (if applicable), be sure to attach these accessories firmly. If the lens accessory becomes loose and falls off, it may crack, and the shards of glass may lead to cuts.

- On products that raise and lower the flash automatically, make sure to avoid pinching your fingers with the lowering flash. This could result in injury.

Caution Denotes the possibility of property damage.

- Do not aim the camera at intense light sources, such as the sun on a clear day or an intense artificial light source. Doing so may damage the image sensor or other internal components.

- When using the camera on a sandy beach or at a windy location, be careful not to allow dust or sand to enter the camera.

- On products that raise and lower the flash automatically, do not push the flash down or pry it open. This may cause the product to malfunction.

- Wipe off any dust, grime, or other foreign matter on the flash with a cotton swab or cloth. The heat emitted from the flash may cause foreign matter to smoke or the product to malfunction.

- Remove and store the battery pack/batteries when you are not using the product. Any battery leakage that occurs may cause product damage.

- Before you discard the battery pack/batteries, cover the terminals with tape or other insulators. Contacting other metal materials may lead to fire or explosions.

- Unplug any battery charger used with the product when not in use. Do not cover with a cloth or other objects when in use. Leaving the unit plugged in for a long period of time may cause it to overheat and distort, resulting in fire.

Before Use

Basic Guide

Advanced Guide

Camera Basics

Auto Mode / Hybrid Auto Mode

Other Shooting Modes

P Mode

Tv, Av, M, C1, and C2 Mode

Playback Mode

Wireless Features

Setting Menu

Accessories

Appendix

Index



- Do not leave any dedicated battery packs near pets. Pets biting the battery pack could cause leakage, overheating, or explosion, resulting in product damage or fire.

- If your product uses multiple batteries, do not use batteries that have different levels of charge together, and do not use old and new batteries together. Do not insert the batteries with the + and – terminals reversed. This may cause the product to malfunction.

- Do not sit down with the camera in your pant pocket. Doing so may cause malfunctions or damage the screen.

- When putting the camera in your bag, ensure that hard objects do not come into contact with the screen. Also close the screen (so that it faces the body), if your product's screen closes.

- Do not attach any hard objects to the product. Doing so may cause malfunctions or damage the screen.



Before Use

Basic Guide

Advanced Guide

Camera Basics

Auto Mode / Hybrid Auto Mode

Other Shooting Modes

P Mode

Tv, Av, M, C1, and C2 Mode

Playback Mode

Wireless Features

Setting Menu

Accessories

Appendix

Index



Basic Guide

Basic Operations

Basic information and instructions, from initial preparations to shooting and playback

Initial Preparations

Prepare for shooting as follows.

Attaching the Strap

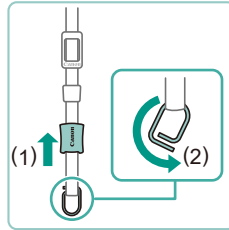

1 Prepare the strap.

- Pull the cap in the direction of (1) while holding the ring.
- Rotate the ring in the direction of (2).

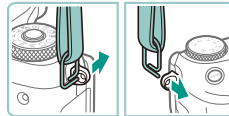

2 Attach the ring.

- Pass the end of the ring through the holder as shown.

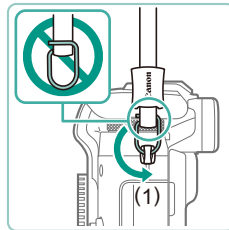

3 Turn the ring around.

- Rotate the ring in the direction of (1).
- When rotating the ring, be careful not to pass the strap through the gap in the ring.

Before Use

Basic Guide

Advanced Guide

Camera Basics

Auto Mode /
Hybrid Auto Mode

Other Shooting Modes

P Mode

Tv, Av, M, C1, and C2 Mode

Playback Mode

Wireless Features

Setting Menu

Accessories

Appendix

Index



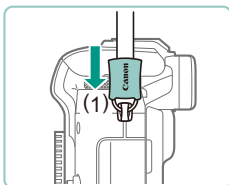

4 Secure the ring.

- To secure the ring, slide the cap in the direction of (1) until it clicks into place.
- On the other side of the camera, secure the ring the same way.



- Always follow these steps to attach the strap correctly. If the strap is not attached correctly, the camera may fall.

Removing the Strap

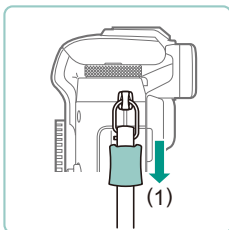

1 Unfasten the cap.

- Pull the cap in the direction of (1) to unfasten it from the ring.

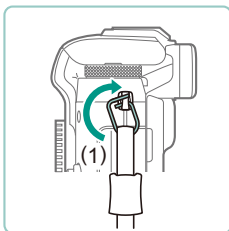

2 Detach the ring.

- Rotate the ring in the direction of (1).
- Pass the end of the ring (by the gap) out of the holder to detach the ring.

Holding the Camera

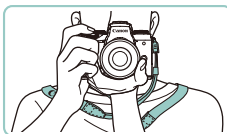

- Place the strap around your neck.
- When shooting, keep your arms close to your body and hold the camera securely to prevent it from moving. If you have raised the flash, do not rest your fingers on it.

Charging the Battery Pack

Before use, charge the battery pack with the included charger. Be sure to charge the battery pack initially, because the camera is not sold with the battery pack charged.

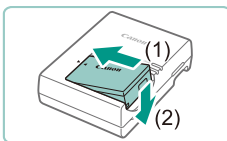

1 Insert the battery pack.

- Remove the cover from the battery pack, align the ▲ marks on the battery pack and charger, and insert the battery pack by pushing it in (1) and down (2).

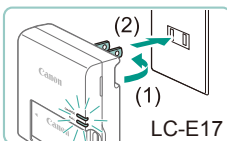

2 Charge the battery pack.

- LC-E17: Flip out the plug (1) and plug the charger into a power outlet (2).
- LC-E17E: Plug the power cord into the charger, then plug the other end into a power outlet.
- The charging lamp turns orange, and charging begins.
- When charging is finished, the lamp turns green.

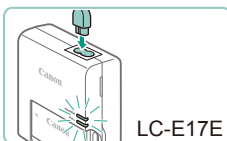

Before Use

Basic Guide

Advanced Guide

Camera Basics

Auto Mode /
Hybrid Auto Mode

Other Shooting Modes

P Mode

Tv, Av, M, C1, and C2 Mode

Playback Mode

Wireless Features

Setting Menu

Accessories

Appendix

Index



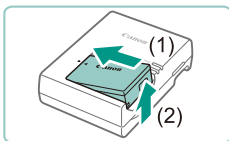

3 Remove the battery pack.

- After unplugging the battery charger, remove the battery pack by pushing it in (1) and up (2).



- To protect the battery pack and keep it in optimal condition, do not charge it continuously for more than 24 hours.
- For battery chargers that use a power cord, do not attach the charger or cord to other objects. Doing so could result in malfunction or damage to the product.
- Battery charger problems may trigger a protective circuit that stops charging and makes the charge lamp blink in orange. If this happens, disconnect the charger's power plug from the power outlet and remove the battery pack. Attach the battery pack to the charger again and wait a while before connecting the charger to a power outlet again.



- For details on charging time, see "Battery Charger LC-E17/LC-E17E" (217), and for the number of shots and recording time possible with a fully charged battery pack, see "Power" (216).
- Charged battery packs gradually lose their charge, even when they are not used. Charge the battery pack on (or immediately before) the day of use.
- As a visual reminder of the charge status, attach the battery cover with ▲ visible on a charged battery pack and concealed on an uncharged one.
- The charger can be used in areas with 100 – 240 V AC power (50/60 Hz). For power outlets in a different format, use a commercially available adapter for the plug. Never use an electrical transformer designed for traveling, which may damage the battery pack.

Inserting the Battery Pack and Memory Card

Insert the included battery pack and a memory card (sold separately). Note that before using a memory card that is new or has been formatted in another device, you should format the memory card with this camera (156).

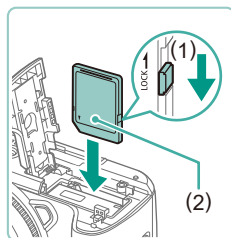
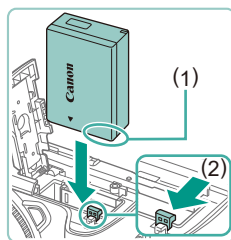
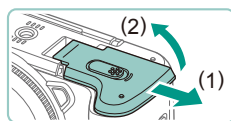

1 Open the cover.

- Slide the cover (1) and open it (2).

2 Insert the battery pack.

- With the battery pack terminals (1) in the position shown, hold the battery lock toward (2) and insert the battery pack until the lock clicks shut.
- If you insert the battery pack facing the wrong way, it cannot be locked into the correct position. Always confirm that the battery pack is facing the right way and locks when inserted.

3 Check your card's write-protect switch and insert the memory card.

- Recording is not possible on memory cards with a write-protect switch when the switch is in the locked position. Move the switch toward (1).
- Insert the memory card with the label (2) facing as shown until it clicks into place.
- Make sure the memory card is facing the right way when you insert it. Inserting memory cards facing the wrong way may damage the camera.

Before Use

Basic Guide

Advanced Guide

Camera Basics

Auto Mode / Hybrid Auto Mode

Other Shooting Modes

P Mode

Tv, Av, M, C1, and C2 Mode

Playback Mode

Wireless Features

Setting Menu

Accessories

Appendix

Index



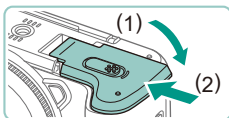

4 Close the cover.

- Lower the cover (1) and hold it down as you slide the switch, until it clicks into the closed position (2).



- You can check the number of shots and recording time per memory card in the information displayed (26).

Removing the Battery Pack and Memory Card

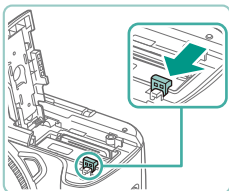

Remove the battery pack.

- Open the cover and press the battery lock in the direction of the arrow.
- The battery pack will pop up.

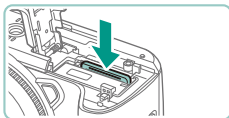

Remove the memory card.

- Push the memory card in until it clicks, and then slowly release it.
- The memory card will pop up.

Setting the Date and Time

Set the current date and time correctly as follows if the [Date/Time] screen is displayed when you turn the camera on. Information you specify this way is recorded in image properties when you shoot, and it is used when you manage images by shooting date or print images showing the date.

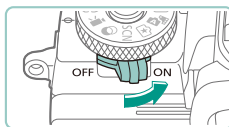

1 Turn the camera on.

- Move the power switch to [ON].
- The [Date/Time] screen is displayed.

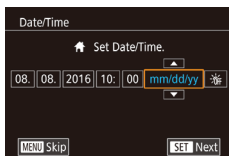

2 Set the date and time.

- Press the [◀][▶] buttons to choose an item.
- Press the [▲][▼] buttons or turn the [DISP] dial to specify the date and time.
- When finished, press the [OK] button.

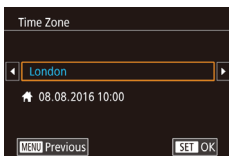

3 Specify your home time zone.

- Press the [◀][▶] buttons to choose your home time zone.

Before Use

Basic Guide

Advanced Guide

Camera Basics

Auto Mode / Hybrid Auto Mode

Other Shooting Modes

P Mode

Tv, Av, M, C1, and C2 Mode

Playback Mode

Wireless Features

Setting Menu

Accessories

Appendix

Index





4 Finish the setup process.

- Press the **[SET]** button when finished. After a confirmation message, the setting screen is no longer displayed.
- To turn off the camera, move the power switch to **[OFF]**.



- Unless you set the date, time, and home time zone, the [Date/Time] screen will be displayed each time you turn the camera on. Specify the correct information.



- To set daylight saving time (1 hour ahead), choose **[Off]** in step 2 and then choose **[On]** by pressing the **[▲]**/**[▼]** buttons or turning the **[DISP]** dial.



- You can also set the date and time by touching the desired item on the screen in step 2 and then touching **[▲]**/**[▼]**, followed by **[SET]**. Similarly, you can also set your home time zone by touching **[◀]**/**[▶]** on the screen in step 3, followed by **[SET]**.

Changing the Date and Time

Adjust the date and time as follows.

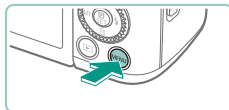

1 Access the menu screen.

- Press the **[MENU]** button.

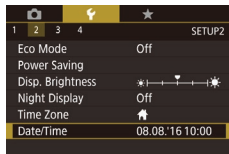

2 Choose [Date/Time].

- Press the **[◀]**/**[▶]** buttons or turn the **[DISP]** dial to choose the **[2]** tab.
- Press the **[▲]**/**[▼]** buttons or turn the **[DISP]** dial to choose **[Date/Time]**, and then press the **[SET]** button.



3 Change the date and time.

- Follow step 2 in "Setting the Date and Time" (21) to adjust the settings.
- Press the **[MENU]** button to close the menu screen.



- Date/time settings can be retained for about 3 weeks by the camera's built-in date/time battery (backup battery) after the battery pack is removed.
- The date/time battery will be charged in about 4 hours, even if the camera is off, once you insert a charged battery pack, or when you insert a DC coupler and connect an AC adapter (both sold separately, 167).
- Once the date/time battery is depleted, the [Date/Time] screen will be displayed when you turn the camera on. Set the correct date and time as described in "Setting the Date and Time" (21).

Before Use

Basic Guide

Advanced Guide

Camera Basics

Auto Mode /
Hybrid Auto Mode

Other Shooting Modes

P Mode

Tv, Av, M, C1, and C2 Mode

Playback Mode

Wireless Features

Setting Menu

Accessories

Appendix

Index



Display Language

Change the display language as needed.

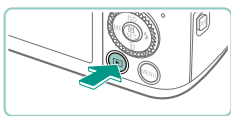

1 Enter Playback mode.

- Press the [▶] button.

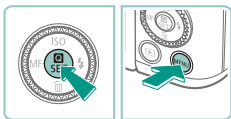

2 Access the setting screen.

- Press and hold the [Ⓜ] button, and then press the [MENU] button.

English	Norsk	Română
Deutsch	Svenska	Türkçe
Français	Español	العربية
Nederlands	Ελληνικά	ភាសាខ្មែរ
Dansk	Русский	简体中文
Português	Polski	繁體中文
Suomi	Čeština	한국어
Italiano	Magyar	日本語
Українська		

3 Set the display language.

- Press the [▲][▼][◀][▶] buttons or turn the [Q] dial to choose a language, and then press the [Ⓜ] button.
- Once the display language has been set, the setting screen is no longer displayed.



- You can also change the display language by pressing the [MENU] button and choosing [Language] on the [F3] tab.



- You can also set the display language by touching a language on the screen in step 3 and then touching it again.

Attaching a Lens

The camera is compatible with EF-M lenses. Additionally, the optional Mount Adapter EF-EOS M can be attached to use EF and EF-S lenses (p.24).

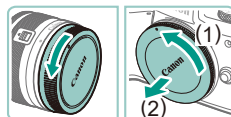

1 Make sure the camera is off.

2 Remove the caps.

- Remove the lens cap and body cap by turning them in the directions shown.

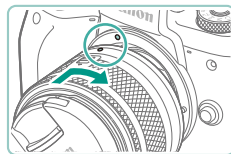

3 Attach the lens.

- Align the mount indexes (the white dots) on the lens and camera, and then turn the lens in the direction shown until it clicks into place.

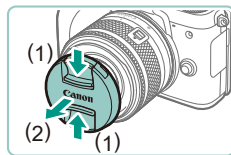

4 Remove the front lens cap.

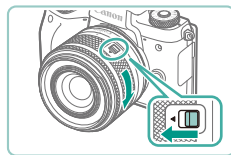

5 Prepare to shoot.

- With the lens retraction index aligned with the zoom position index, hold the lens retraction switch toward [▲] as you turn the zoom ring a little in the direction shown, and then release the switch.
- Continue turning the zoom ring until it clicks, indicating that the lens is ready for shooting.

Before Use

Basic Guide

Advanced Guide

Camera Basics

Auto Mode /
Hybrid Auto Mode

Other Shooting Modes

P Mode

Tv, Av, M, C1, and C2 Mode

Playback Mode

Wireless Features

Setting Menu

Accessories

Appendix

Index





- To retract the lens, hold the lens retraction switch toward **[▲]** as you turn the zoom ring. Align the lens retraction index with the zoom position index, and then release the switch.
- To zoom, turn the zoom ring on the lens with your fingers.
- If you want to zoom, do it before focusing. Turning the zoom ring after achieving focus may throw off the focus slightly.



- To protect the lens, keep the lens cap on when the camera is not in use.



- Some lenses may cause vignetting if the built-in flash is used.

Detaching a Lens

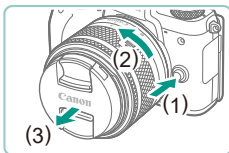

- Make sure the camera is off.
- Hold down the lens release button (1) as you turn the lens in the direction shown (2).
- Turn the lens until it stops, and then remove it in the direction shown (3).
- Attach the lens cap to the lens after removal.



- Minimizing Dust
 - When changing lenses, do it quickly in a place with minimal dust.
 - When storing the camera without a lens attached, be sure to attach the body cap to the camera.
 - Remove dust on the body cap before attaching it.



- Since the image sensor size is smaller than the 35mm film format, it will look like the lens focal length is increased by approx. 1.6x. For example, the focal length of a 15-45mm lens is approximately equivalent to a focal length of 24-72mm on a 35mm camera.

Lens Instruction Manuals

Download lens manuals from the following page.
<http://www.canon.com/icpd/>

Attaching EF and EF-S Lenses

To use EF and EF-S lenses, attach the optional Mount Adapter EF-EOS M.

1 Make sure the camera is off.

2 Remove the caps.

- Follow step 2 in “Attaching a Lens” (📖23) to remove the caps.

Before Use

Basic Guide

Advanced Guide

Camera Basics

Auto Mode /
Hybrid Auto Mode

Other Shooting Modes

P Mode

Tv, Av, M, C1, and C2 Mode

Playback Mode

Wireless Features

Setting Menu

Accessories

Appendix

Index





3 Attach the lens to the adapter.

- To mount an EF lens, align the red dots on the lens and adapter, and then turn the lens in the direction shown until it clicks into place.
- To mount an EF-S lens, align the white squares on the lens and adapter, and then turn the lens in the direction shown until it clicks into place.

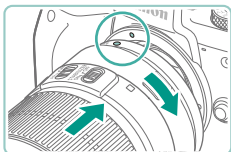
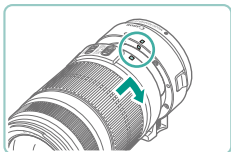

4 Attach the adapter to the camera.

- Align the mount indexes (the white dots) on the adapter and camera, and then turn the lens in the direction shown until it clicks into place.



- When holding or carrying a camera with a lens that is heavier than the camera, support the lens.
- Adapters may extend the minimum focusing distance or affect the maximum magnification or shooting range of the lens.
- If the front part (focusing ring) of the lens rotates during autofocus, do not touch the rotating part.
- The focus preset and power zoom features of some super telephoto lenses are not supported.

Detaching a Lens

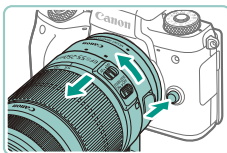

1 Detach the adapter.

- Make sure the camera is off.
- Hold down the lens release button and turn the adapter (with the lens attached) in the direction shown.
- Turn the adapter until it stops, then detach it.

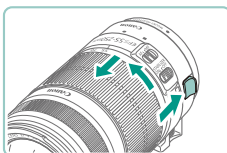

2 Detach the lens.

- Hold down the lens release lever on the adapter and turn the lens counterclockwise.
- Turn the lens until it stops, then detach it.
- Attach the lens cap to the lens after removal.

Using a Tripod

When using a tripod while the adapter is attached to the camera, use the tripod mount included with the adapter. Do not use the camera's tripod socket.

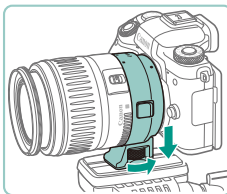

- Attach the tripod mount to the adapter. Turn the tripod mount knob to ensure that it is securely attached.
- Attach the tripod to the tripod mount socket.



- With EF lenses that incorporate a tripod mount (such as super telephoto lenses), attach the tripod to the tripod mount on the lens.

Before Use

Basic Guide

Advanced Guide

Camera Basics

Auto Mode /
Hybrid Auto Mode

Other Shooting Modes

P Mode

Tv, Av, M, C1, and C2 Mode

Playback Mode

Wireless Features

Setting Menu

Accessories

Appendix

Index



Using Lens Image Stabilization

Correct camera shake by using a lens with built-in image stabilization. Lenses with built-in image stabilization are named with "IS".

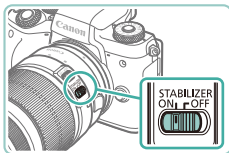

- Slide the image stabilization switch on the lens to [ON].

Trying the Camera Out

► Still Images ► Movies

Follow these instructions to turn the camera on, shoot still images or movies, and then view them.

Shooting (Scene Intelligent Auto)

For fully automatic selection of the optimal settings for specific scenes, simply let the camera determine the subject and shooting conditions.

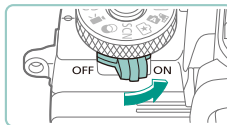

1 Turn the camera on.

- Move the power switch to [ON].

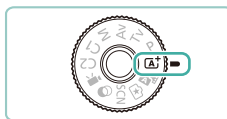

2 Enter [AI+] mode.

- Hold down the mode dial release button and turn the mode dial to [AI+].
- A scene icon (1) is displayed in the upper left of the screen.
- Also shown on the top of the screen are the number of shots (2) and length of movies (3) that the card can hold.
- Frames are displayed around faces and subjects that have been detected, indicating that they are in focus.



3 Compose the shot.

- When using a zoom lens, zoom by turning the zoom ring on the lens with your fingers.

Before Use

Basic Guide

Advanced Guide

Camera Basics

Auto Mode /
Hybrid Auto Mode

Other Shooting Modes

P Mode

Tv, Av, M, C1, and C2 Mode

Playback Mode

Wireless Features

Setting Menu

Accessories

Appendix

Index



4 Shoot.

Shooting Still Images

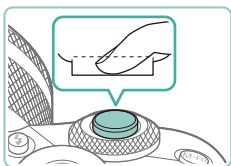
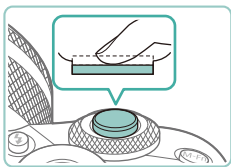

1) Focus.

- Press the shutter button lightly, halfway down. The camera beeps twice after focusing, and AF frames are displayed to indicate image areas in focus.

- If [Raise the flash] is displayed, press the  button to raise the flash. It will fire when shooting. If you prefer not to use the flash, push it down with your finger, into the camera.

2) Shoot.

- Press the shutter button all the way down to shoot. (In low-light conditions, the flash fires automatically when you have raised it.)
- Your shot remains displayed on the screen for about two seconds.
- Even while the shot is displayed, you can take another shot by pressing the shutter button again.



Recording Movies

1) Start recording.

- Press the movie button. Recording begins, and [● Rec] is displayed with the elapsed time.
- Black bars displayed on the top and bottom edges of the screen indicate image areas not recorded.
- Frames displayed around any detected faces indicate that they are in focus.
- Once recording begins, take your finger off the movie button.

2) Finish recording.

- To stop movie recording, press the movie button again.



- If the camera cannot focus on subjects when you press the shutter button lightly, an orange AF frame is displayed with , and no picture is taken if you press the shutter button all the way down.
- Once recording begins, the display area narrows, and subjects are enlarged.

Before Use

Basic Guide

Advanced Guide

Camera Basics

Auto Mode /
Hybrid Auto Mode

Other Shooting Modes

P Mode

Tv, Av, M, C1, and C2 Mode

Playback Mode

Wireless Features

Setting Menu

Accessories

Appendix

Index



Viewing

After shooting images or movies, you can view them on the screen as follows.

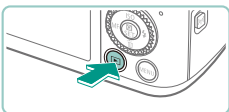

1 Enter Playback mode.

- Press the [▶] button.
- Your last shot is displayed.



2 Choose images.

- To view the previous image, press the [◀] button or turn the [⦿] dial counterclockwise. To view the next image, press the [▶] button or turn the [⦿] dial clockwise.
- Press and hold the [◀][▶] buttons to browse through images quickly.
- To access this screen (Scroll Display mode), turn the [⦿] dial rapidly. In this mode, turn the [⦿] dial to browse through images.
- To return to single-image display, press the [⦿] button.
- Movies are identified by a [SET ▶] icon. To play movies, go to step 3.

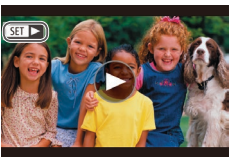
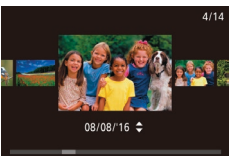

3 Play movies.

- Press the [⦿] button, press the [▲][▼] buttons to choose [▶], and then press the [⦿] button again.
- Playback now begins, and after the movie is finished, [SET ▶] is displayed.
- To adjust the volume, press the [▲][▼] buttons during playback.



- To switch to Shooting mode from Playback mode, press the shutter button halfway (1/31), press the [▶] button or movie button, or turn the mode dial.



- You can also start movie playback by touching [▶]. To adjust the volume, quickly drag up or down across the screen during playback.

Before Use

Basic Guide

Advanced Guide

Camera Basics

Auto Mode /
Hybrid Auto Mode

Other Shooting Modes

P Mode

Tv, Av, M, C1, and C2 Mode

Playback Mode

Wireless Features

Setting Menu

Accessories

Appendix

Index



Erasing Images

You can choose and erase unneeded images one by one. Be careful when erasing images, because they cannot be recovered.

1 Choose an image to erase.

- Press the [◀][▶] buttons or turn the [DISP.] dial to choose an image.



2 Erase the image.

- Press the [▼] button.
- After [Erase?] is displayed, press the [◀][▶] buttons or turn the [DISP.] dial to choose [Erase], and then press the [OK] button.
- The current image is now erased.
- To cancel erasure, press the [◀][▶] buttons or turn the [DISP.] dial to choose [Cancel], and then press the [OK] button.

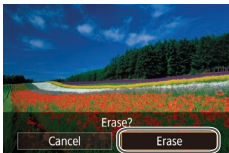

- You can choose multiple images to erase at once (115).



- You can also erase the current image by touching [Erase] on the screen in step 2.

Before Use

Basic Guide

Advanced Guide

Camera Basics

Auto Mode /
Hybrid Auto Mode

Other Shooting Modes

P Mode

Tv, Av, M, C1, and C2 Mode

Playback Mode

Wireless Features

Setting Menu

Accessories

Appendix

Index



Advanced Guide

Camera Basics

Other basic operations and more ways to enjoy your camera, including shooting and playback options

On/Off

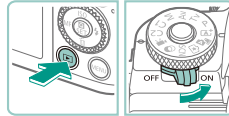
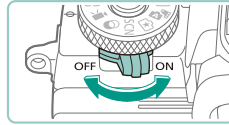

Shooting Mode

- Slide the power switch to [ON] to turn the camera on in Shooting mode.
- To turn off the camera, move the power switch to [OFF].

Playback Mode

- Hold down the [▶] button and slide the power switch to [ON] to turn the camera on in Playback mode.
- To switch to Shooting mode, press the [▶] button again.
- To turn off the camera, move the power switch to [OFF].



- When an EF-M lens is attached to the camera and the power is off, the aperture narrows to reduce the amount of light entering the camera and protect the internal components of the camera. Accordingly, the camera makes a small noise when turned on or off as the aperture is adjusted.
- The sensor is cleaned when the camera is turned on or off, which may also make a small noise. Even when the camera is off, [⬆] is displayed as the sensor is cleaned. However, the [⬆] icon may not be displayed if you switch the camera on and off quickly in succession.
- To switch to Shooting mode from Playback mode, press the shutter button halfway (31), press the [▶] button or movie button, or turn the mode dial.

Before Use

Basic Guide

Advanced Guide

Camera Basics

Auto Mode /
Hybrid Auto Mode

Other Shooting Modes

P Mode

Tv, Av, M, C1, and C2 Mode

Playback Mode

Wireless Features

Setting Menu

Accessories

Appendix

Index



Power-Saving Features (Auto Power Down)

- As a way to conserve battery power, the camera automatically deactivates the screen (Display Off) and then turns itself off after a specific period of inactivity.
- The screen is automatically deactivated after about one minute of inactivity, and the camera turns itself off after about another minute. To activate the screen and prepare for shooting when the screen is off, press the shutter button halfway (📖31).



- If the screen goes off in Playback mode, you can also access the shooting screen by pressing the shutter button halfway.
- You can deactivate Auto Power Down and adjust the timing of Display Off, if you prefer (📖158).
- Power saving is not active while the camera is connected to other devices via Wi-Fi (📖127), or when connected to a computer (📖177).

Shutter Button

To ensure that the subject is in focus, begin by holding the shutter button halfway down, and once the subject is in focus, press the button all the way down to shoot.

In this manual, shutter button operations are described as pressing the button *halfway* or *all the way down*.

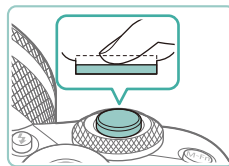

1 Press halfway. (Press lightly to focus.)

- Press the shutter button halfway. The camera beeps twice, and frames are displayed around image areas in focus.

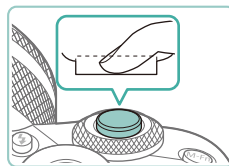

2 Press all the way down. (From the halfway position, press fully to shoot.)

- The camera now shoots.



- Subjects may be out of focus if you shoot without initially pressing the shutter button halfway.

Before Use

Basic Guide

Advanced Guide

Camera Basics

Auto Mode /
Hybrid Auto Mode

Other Shooting Modes

P Mode

Tv, Av, M, C1, and C2 Mode

Playback Mode

Wireless Features

Setting Menu

Accessories

Appendix

Index



Viewfinder

Shooting is easier with a viewfinder, which helps you concentrate on keeping subjects in focus.

1 Switch between using the screen and viewfinder as needed.

- Moving the viewfinder near your eye will activate its display and deactivate the camera screen.
- Moving the viewfinder away from your eye will deactivate its display and activate the camera screen.

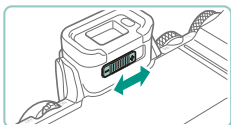

2 Adjust the diopter.

- Move the knob to bring viewfinder images into sharp focus.



- The viewfinder display and camera screen cannot be activated at the same time.



- Although the viewfinder is produced under extremely high-precision manufacturing conditions and more than 99.99% of the pixels meet design specifications, in rare cases some pixels may be defective or may appear as red or black dots. This does not indicate camera damage or affect recorded images.
- Some aspect ratio settings (📐 49) will cause black bars to be displayed on the top and bottom or left and right edges of the screen. These areas will not be recorded.
- The screen will not be activated when you move your eye away from the viewfinder if you have selected MENU (📖 35) > [1] tab > [Display settings] > [Display Control] > [Manual] and then [Manual display] > [Viewfinder].
- Display of shooting information will not be adjusted when you hold the camera vertically if you have selected MENU (📖 35) > [1] tab > [Shooting information display] > [VF vertical display] > [Off].
- You can conserve battery power in [A], [P], [Av], [Tv], or [M] mode by selecting MENU (📖 35) > [2] tab > [Display Mode] > [Display priority] > [Power Saving], but viewfinder and screen display may be choppy.
- Display switches to the camera screen if you access the Wi-Fi menu (📶 127) during viewfinder display.
- You can configure display brightness (📖 158) for the viewfinder and camera screen separately.
- To reduce the shooting screen, choose MENU (📖 35) > [2] tab > [VF display format] > [Display 2].

Before Use

Basic Guide

Advanced Guide

Camera Basics

Auto Mode /
Hybrid Auto Mode

Other Shooting Modes

P Mode

Tv, Av, M, C1, and C2 Mode

Playback Mode

Wireless Features

Setting Menu

Accessories

Appendix

Index



Shooting Modes

Use the mode dial to access each shooting mode. As you turn it, hold down the mode dial release button in the middle of the dial.

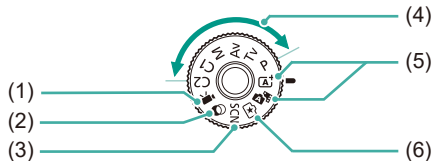

- (1) **Movie Mode**
For shooting movies (📖64, 📖94). You can also shoot movies when the mode dial is not set to Movie mode, simply by pressing the movie button.
- (2) **Creative Filters Mode**
Add a variety of effects to images when shooting (📖59).
- (3) **Special Scene Mode**
Shoot with optimal settings for specific scenes (📖56).
- (4) **P, Tv, Av, M, C1, and C2 Modes**
Take a variety of shots using your preferred settings (📖68, 📖90, 📖91, 📖92, 📖100).
- (5) **Scene Intelligent Auto Mode / Hybrid Auto Mode**
Fully automatic shooting, with camera-determined settings (📖39, 📖41).
- (6) **Creative Assist Mode**
Preview easy-to-understand image adjustments when shooting. Settings can also be saved and applied again later (📖53).



- You can turn the mode dial to switch to Shooting mode from Playback mode.

Adjusting the Screen Angle

You can adjust the screen angle and orientation to suit the scene or how you are shooting.

Tilting the Screen Downward

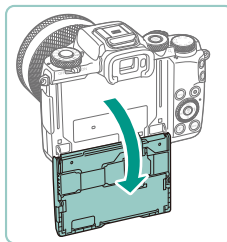

- The screen can be opened to about 180°.
- When including yourself in shots, you can view a mirror image of yourself by rotating the screen around toward the front of the camera.

Tilting the Screen Upward

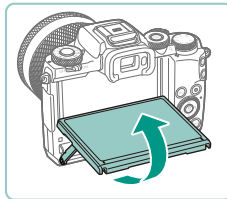

- Lift the bottom of the screen up toward you.
- The screen can be opened to about 85°.



- When the camera is not in use, keep the screen closed.
- Do not force the screen open too far, which may damage the camera.



- To cancel reverse display, choose MENU (📖35) > [📷1] tab > [Reverse Display] > [Off].

Before Use

Basic Guide

Advanced Guide

Camera Basics

Auto Mode /
Hybrid Auto Mode

Other Shooting Modes

P Mode

Tv, Av, M, C1, and C2 Mode

Playback Mode

Wireless Features

Setting Menu

Accessories

Appendix

Index



Shooting Display Options

Press the [INFO.] button to show or hide shooting information, grid lines, or the electronic level.

To configure the on-screen display in greater detail, access [CAM1] tab > [Shooting information display] (📖95).



- Screen brightness is automatically increased by the night view function when you are shooting under low light, making it easier to check how shots are composed. However, on-screen image brightness may not match the brightness of your shots. Note that any on-screen image distortion or jerky subject motion will not affect recorded images.
- For playback display options, see “Switching Display Modes” (📖105).

Using the Quick Set Menu

Configure commonly used functions in the [Q] (Quick Set) menu. Note that menu items and options vary depending on the shooting mode (📖196) or playback mode (📖210).



1 Access the [Q] menu.

- Press the [Q] button.



(1) (2)

2 Choose a menu item.

- Press the [▲][▼] buttons to choose a menu item (1).
- Available options (2) are shown at the bottom of the screen.



3 Choose an option.

- Press the [◀][▶] buttons or turn the [DISP.] or [ZOOM] dial to choose an option.
- Items labeled with a [INFO.] icon can be configured by pressing the [INFO.] button.



4 Confirm your choice and exit.

- Press the [Q] button.
- The screen before you pressed the [Q] button in step 1 is displayed again, showing the option you configured.

Before Use

Basic Guide

Advanced Guide

Camera Basics

Auto Mode /
Hybrid Auto Mode

Other Shooting Modes

P Mode

Tv, Av, M, C1, and C2 Mode

Playback Mode

Wireless Features

Setting Menu

Accessories

Appendix

Index





- You can also choose an option in step 3 by turning the [DISP] dial.
- To undo any accidental setting changes, you can restore the camera's default settings (163).
- You can also exit by choosing [BACK] in the menu items and pressing the [MENU] button.

Using Touch-Screen Operations to Configure Settings



- Touch [Q] in the upper right of the screen to access the Quick Set menu.
- Touch a menu item and then an option to complete the setting.
- To return to the previous screen, touch the [BACK] menu item, or touch the selected option again.
- You can access the screen for options labeled with a [INFO] icon by touching [INFO].

Using the Menu Screen

Configure a variety of camera functions through the menu screen as follows.

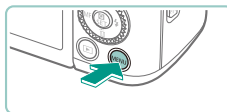

1 Access the menu screen.

- Press the [MENU] button.

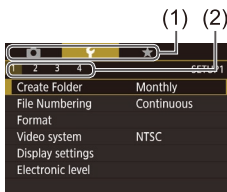

2 Choose a tab.

- Press the [LEFT] [RIGHT] buttons or turn the [DISP] dial to choose a tab.
- Tabs represent functions (1), such as shooting ([CAMERA]), playback ([PLAY]), or settings ([INFO]), or pages within each function (2). Tabs are identified in this manual by combining the function and page, as in [CAMERA]1.



3 Choose a menu item.

- Press the [UP] [DOWN] buttons or turn the [DISP] dial to choose an item, and then press the [MENU] button.
- For menu items with options not shown, first press the [INFO] button to switch screens, and then either press the [UP] [DOWN] buttons or turn the [DISP] dial to select the menu item.
- To return to the previous screen, press the [MENU] button.



Before Use

Basic Guide

Advanced Guide

Camera Basics

Auto Mode / Hybrid Auto Mode

Other Shooting Modes

P Mode

Tv, Av, M, C1, and C2 Mode

Playback Mode

Wireless Features

Setting Menu

Accessories

Appendix

Index



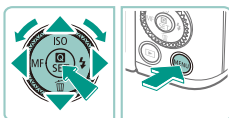
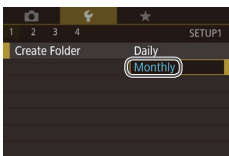

4 Choose an option.

- When options are listed vertically, press the [▲][▼] buttons or turn the [DISP] dial to choose an option.
- When options are listed horizontally, press the [◀][▶] buttons or turn the [DISP] dial to choose an option.

5 Confirm your choice and exit.

- Press the [OK] button to confirm your choice and return to the menu item selection screen.
- Press the [MENU] button to return to the screen displayed before you pressed the [MENU] button in step 1.



- You can also choose function tabs by pressing the [M-Fn] button in step 2.
- You can also choose an item or option in steps 3 and 4 by turning the [DISP] dial.
- To undo any accidental setting changes, you can restore the camera's default settings (📖 163).
- Available menu items vary depending on the selected shooting or playback mode (📖 198 – 📖 210).

Touch-Screen Operations

- To choose tabs, press the [MENU] button to access the menu screen, and then touch the desired function tab and page tab.
- Touch an item to choose it, and then touch it again.
- Touch an option to complete the setting and return to the menu item selection screen.
- To configure menu items for which options are not shown, first touch the menu item to access the setting screen. To return to the previous screen, touch [MENU].
- You can also touch input elements (such as check boxes or text fields) to select them, and you can enter text by touching the on-screen keyboard.
- Touching [INFO], [MENU], or [SET] has the same effect as pressing the [INFO], [MENU], or [OK] buttons, respectively.
- To dismiss the menu, press the [MENU] button again.

Before Use

Basic Guide

Advanced Guide

Camera Basics

Auto Mode /
Hybrid Auto Mode

Other Shooting Modes

P Mode

Tv, Av, M, C1, and C2 Mode

Playback Mode

Wireless Features

Setting Menu

Accessories

Appendix

Index



On-Screen Keyboard

Use the on-screen keyboard to enter wireless settings (127) and other information. Note that the length and type of information you can enter varies depending on the function you are using.

(1) Entering Characters

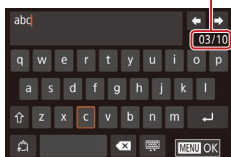

- Touch the characters to enter them.
- The amount of information you can enter (1) varies depending on the function you are using.

Moving the Cursor

- Touch [←][→].

Entering Line Breaks

- Touch [↵].

Switching Input Modes

- To switch to numbers or symbols, touch [123].
- Touch [⇧] to enter capital letters.
- Available input modes vary depending on the function you are using.

Deleting Characters

- Touch [✕] to delete the previous character.
- Touching and holding [✕] will delete five characters at a time.

Confirming Input and Returning to the Previous Screen

- Press the [MENU] button.



- For some functions, [↵] is not displayed and cannot be used.



- Another way to use the keyboard is by pressing the [▲][▼][◀][▶] buttons or turning the [ZOOM] [WHEEL] dials to select characters or icons, and then pressing the [OK] button. You can also move the cursor by turning the [ZOOM] dial. To return to the previous screen, press the [MENU] button.

Before Use

Basic Guide

Advanced Guide

Camera Basics

Auto Mode /
Hybrid Auto Mode

Other Shooting Modes

P Mode

Tv, Av, M, C1, and C2 Mode

Playback Mode

Wireless Features

Setting Menu

Accessories

Appendix

Index



Indicator Display

The indicator on the back of the camera (📖4) blinks in green at these times.

- Connected to a computer (📖177)
- Display off (📖31, 📖157, 📖158)
- Starting up, recording, or reading
- Communicating with other devices
- Shooting long exposures (📖90, 📖92)
- Connecting/transmitting via Wi-Fi



- When the indicator blinks green, never turn the camera off, open the memory card/battery cover, or shake or jolt the camera, which may corrupt images or damage the camera or memory card.

Before Use

Basic Guide

Advanced Guide

Camera Basics

Auto Mode /
Hybrid Auto Mode

Other Shooting Modes

P Mode

Tv, Av, M, C1, and C2 Mode

Playback Mode

Wireless Features

Setting Menu

Accessories

Appendix

Index



Auto Mode / Hybrid Auto Mode

Convenient mode for easy shots with greater control over shooting

Shooting with Camera-Determined Settings

For fully automatic selection of the optimal settings for specific scenes, simply let the camera determine the subject and shooting conditions.

Shooting (Scene Intelligent Auto)

▶ Still Images ▶ Movies

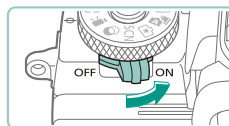

1 Turn the camera on.

- Move the power switch to [ON].



2 Enter [A+] mode.

- Hold down the mode dial release button and turn the mode dial to [A+].
- A scene icon is displayed in the upper left of the screen (📖 43).
- Frames are displayed around faces and subjects that have been detected, indicating that they are in focus.



3 Compose the shot.

- When using a zoom lens, zoom by turning the zoom ring on the lens with your fingers.



Before Use

Basic Guide

Advanced Guide

Camera Basics

Auto Mode / Hybrid Auto Mode

Other Shooting Modes

P Mode

Tv, Av, M, C1, and C2 Mode

Playback Mode

Wireless Features

Setting Menu

Accessories

Appendix

Index





4 Shoot.

Shooting Still Images

1) Focus.

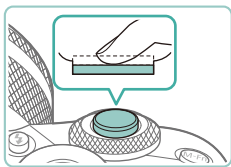
- Press the shutter button halfway. The camera beeps twice after focusing, and AF frames are displayed to indicate image areas in focus.



- If [Raise the flash] is displayed, press the  button to raise the flash. It will fire when shooting. If you prefer not to use the flash, push it down with your finger, into the camera.

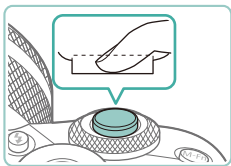

2) Shoot.

- Press the shutter button all the way down to shoot. (In low-light conditions, the flash fires automatically when you have raised it.)
- Your shot remains displayed on the screen for about two seconds.
- Even while the shot is displayed, you can take another shot by pressing the shutter button again.

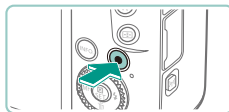

Recording Movies

1) Start recording.

- Press the movie button. Recording begins, and [● Rec] is displayed with the elapsed time.
- Black bars displayed on the top and bottom edges of the screen indicate image areas not recorded.
- Frames displayed around any detected faces indicate that they are in focus.
- Once recording begins, take your finger off the movie button.

2) Resize the subject and recompose the shot as needed.

- To resize the subject, repeat the operations in step 3. However, note that the sound of camera operations will be recorded.
- When you recompose shots, the focus, brightness, and colors will be automatically adjusted.

3) Finish recording.

- To stop movie recording, press the movie button again.
- Recording will stop automatically when the memory card becomes full.

Before Use

Basic Guide

Advanced Guide

Camera Basics

Auto Mode /
Hybrid Auto Mode

Other Shooting Modes

P Mode

Tv, Av, M, C1, and C2 Mode

Playback Mode

Wireless Features

Setting Menu

Accessories

Appendix

Index



Shooting in Hybrid Auto Mode

▶ Still Images ▶ Movies

You can make a short movie of the day just by shooting still images. The camera records 2 – 4-second clips of scenes before each shot, which are later combined in a digest movie.

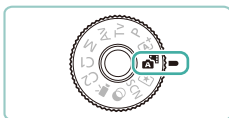

1 Enter [Hybrid Auto] mode.

- Follow step 2 in “Shooting (Scene Intelligent Auto)” (📖39) and choose [Hybrid Auto].



2 Compose the shot.

- Follow steps 3 – 4 in “Shooting (Scene Intelligent Auto)” (📖39) to compose the shot and focus.
- For more impressive digest movies, aim the camera at subjects about four seconds before shooting still images.

3 Shoot.

- Follow step 4 in “Shooting (Scene Intelligent Auto)” (📖39) to shoot a still image.
- The camera records both a still image and movie clip. The clip, which ends with the still image and a shutter sound, forms a single chapter in the digest movie.



- Battery life is shorter in this mode than in [Auto] mode, because digest movies are recorded for each shot.
- A digest movie may not be recorded if you shoot a still image immediately after turning the camera on, choosing [Auto] mode, or operating the camera in other ways.
- Any sounds and vibrations from your camera or lens operations will be recorded in digest movies.



- Digest movie image quality is [Full HD 29.97P] for NTSC or [Full HD 25.00P] for PAL. This varies depending on the video output format (📖157).
- Sounds are not played when you press the shutter button halfway or trigger the self-timer.
- Digest movies are saved as separate movie files in the following cases even if they were recorded on the same day in [Auto] mode.
 - The digest movie file size reaches approximately 4 GB, or the total recording time reaches approximately 16 minutes and 40 seconds.
 - The digest movie is protected (📖112).
 - Daylight saving time (📖21), video system (📖157), time zone (📖159), or copyright information (📖162) settings are changed.
 - A new folder is created (📖155).
- Recorded shutter sounds cannot be modified or erased.
- If you prefer to record digest movies without still images, adjust the setting in advance. Choose MENU (📖35) > [6] tab > [Digest Type] > [No Stills] (📖35).
- Individual chapters can be edited (📖126).

Digest Movie Playback

Display a still image shot in [Auto] mode to play the digest movie created on the same day, or specify the date of the digest movie to play (📖106).

Before Use

Basic Guide

Advanced Guide

Camera Basics

Auto Mode / Hybrid Auto Mode

Other Shooting Modes

P Mode

Tv, Av, M, C1, and C2 Mode

Playback Mode

Wireless Features

Setting Menu

Accessories

Appendix

Index



Still Images/Movies



- If the camera makes no operating sounds, it may have been turned on while holding down the **[INFO]** button. To activate sounds, press the **[MENU]** button, choose **[Beep]** on the **[3]** tab, and then press the **[▲]**/**[▼]** buttons or turn the **[DIAL]** to choose **[On]**.

Still Images



- If the camera cannot focus on subjects when you press the shutter button halfway, an orange AF frame is displayed with **[AF]**, and no picture is taken if you press the shutter button all the way down.
- Focusing may take longer or be incorrect when no people or other subjects are detected, when subjects are dark or lack contrast, or in very bright conditions.
- A blinking **[AF]** icon warns that images are more likely to be blurred by camera shake. In this case, mount the camera on a tripod or take other measures to keep it still.
- If your shots are dark despite the flash firing, move closer to the subject. For details on the flash range, see “Flash” (1213).
- To reduce red-eye and to assist in focusing, the lamp may be lit when shooting in low-light conditions.
- Vignetting or dark image areas may occur with some lenses if the flash fires.
- A blinking **[BATT]** icon displayed when you attempt to shoot indicates that shooting is not possible until the flash has finished recharging. Shooting can resume as soon as the flash is ready, so either press the shutter button all the way down and wait, or release it and press it again.
- Although you can shoot again before the shooting screen is displayed, your previous shot may determine the focus, brightness, and colors used.



- Vignetting appears in previews immediately after your shots, before the final, saved images are displayed.
- You can change how long images are displayed after shots (152).

Movies



- The camera may become warm when recording movies repeatedly over an extended period. This does not indicate damage.
- Keep your fingers away from the microphone (1) while recording movies. Blocking the microphone may prevent audio from being recorded or may cause the recording to sound muffled.

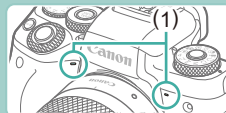

- Avoid touching camera controls other than the movie button and touch-screen panel when recording movies, because sounds made by the camera will be recorded. To adjust settings or perform other operations during recording, use the touch-screen panel if possible.
- Mechanical sounds from the lens and camera are also recorded. These sounds may be less noticeable if you use an optional external microphone (174).
- Once movie recording begins, the image display area changes and subjects are enlarged to allow for correction of significant camera shake. To shoot subjects at the same size shown before shooting, adjust the image stabilization setting (86).

Before Use

Basic Guide

Advanced Guide

Camera Basics

Auto Mode /
Hybrid Auto Mode

Other Shooting Modes

P Mode

Tv, Av, M, C1, and C2 Mode

Playback Mode

Wireless Features

Setting Menu

Accessories

Appendix

Index





- Audio is recorded in stereo.
- During movie recording, lens operating noises from auto focusing may also be recorded. Lens noises may be less noticeable if you use an optional external microphone. If you prefer not to record sound, choose MENU (📖35) > [📷7] tab > [Sound recording] > [Disable].
- To keep the focus fixed during movie recording, choose MENU (📖35) > [📷7] tab > [Movie Servo AF] > [Disable].
- Individual movies that exceed 4 GB are divided into multiple files. To notify you about 30 sec. before the movie reaches 4 GB, the elapsed time on the recording screen will start flashing. If you continue shooting and exceed 4 GB, the camera automatically creates a new movie file and flashing stops. Note that automatic playback of divided movie files one after another is not supported. Play each movie separately.

Scene Icons

▶ Still Images ▶ Movies

In [A+] and [A-] modes, shooting scenes determined by the camera are indicated by the icon displayed, and corresponding settings are automatically selected for optimal focusing, subject brightness, and color.

Background	When Shooting People		Icon Background Color
	People	In Motion	
Bright			Gray
Bright and Backlit			
With Blue Sky			Light Blue
Blue Sky and Backlit			
Spotlights		–	Dark Blue
Dark		–	
Dark, Using Tripod		–	

Background	When Shooting Other Subjects			Icon Background Color
	Other Subjects	In Motion	At Close Range	
Bright				Gray
Bright and Backlit				
With Blue Sky				Light Blue
Blue Sky and Backlit				
Sunsets		–	–	Orange
Spotlights		–		Dark Blue
Dark				
Dark, Using Tripod		–	–	

- “In Motion” icons are not displayed when you shoot with the self-timer (📖44) or in [A-] mode, or when you record a movie.
- “When Shooting People” and “In Motion” icons are not displayed when you have set the lens to [MF] or you are using a non-autofocus lens.



- Try shooting in [P] mode (📖68) if the scene icon does not match actual shooting conditions, or if it is not possible to shoot with your expected effect, color, or brightness.

Before Use

Basic Guide

Advanced Guide

Camera Basics

Auto Mode / Hybrid Auto Mode

Other Shooting Modes

P Mode

Tv, Av, M, C1, and C2 Mode

Playback Mode

Wireless Features

Setting Menu

Accessories

Appendix

Index



On-Screen Frames

▶ Still Images ▶ Movies

A variety of frames are displayed once the camera detects subjects you are aiming the camera at.

- A white frame is displayed around the subject (or person's face) detected as the main subject. Frames follow moving subjects within a certain range as they are tracked to keep them in focus.
- Frames turn green after you press the shutter button halfway and the camera focuses.
- Frames turn blue and focus and brightness are readjusted using Servo AF if you press the shutter button halfway when subject motion is detected in [AF+] mode.
- An orange frame is displayed with [!] if the camera cannot focus on subjects when you press the shutter button halfway.



- Try shooting in [P] mode (468) if no frames are displayed, if frames are not displayed around desired subjects, or if frames are displayed on the background or similar areas.



- To turn off Servo AF, set [AF auto switch] to [Disable] on the [C6] tab. Note that "In Motion" icons (443) will no longer be displayed. [AF auto switch] is automatically set to [Disable] and cannot be changed when the self-timer (444) is set to an option other than [Off].



- To choose subjects to focus on, touch the desired subject on the screen. [Touch AF] is displayed, and the camera enters Touch AF mode.

Common, Convenient Features

Using the Self-Timer

▶ Still Images ▶ Movies

With the self-timer, you can include yourself in group photos or other timed shots. The camera will shoot about 10 seconds after you press the shutter button.



1 Configure the setting.

- Press the [MENU] button, choose [Self-timer] in the menu, and then choose [On] (34).
- Once the setting is complete, [On] is displayed.

2 Shoot.

- For Still Images: Press the shutter button halfway to focus on the subject, and then press it all the way down.
- For Movies: Press the movie button.

Before Use

Basic Guide

Advanced Guide

Camera Basics

Auto Mode / Hybrid Auto Mode

Other Shooting Modes

P Mode

Tv, Av, M, C1, and C2 Mode

Playback Mode

Wireless Features

Setting Menu

Accessories

Appendix

Index



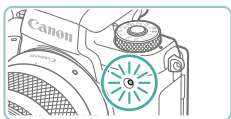

- Once you start the self-timer, the lamp will blink and the camera will play a self-timer sound.
- Two seconds before the shot, the blinking and sound will speed up. (The lamp will remain lit in case the flash fires.)
- To cancel shooting after you have triggered the self-timer, press the **[MENU]** button.
- To restore the original setting, choose **[INFO]** in step 1.

Using the Self-Timer to Avoid Camera Shake

► Still Images ► Movies

This option delays shutter release until about two seconds after you have pressed the shutter button. If the camera is unsteady while you are pressing the shutter button, it will not affect your shot.



- Follow step 1 in “Using the Self-Timer” (44) and choose **[INFO]**.
- Once the setting is complete, **[INFO]** is displayed.
- Follow step 2 in “Using the Self-Timer” (44) to shoot.

Customizing the Self-Timer

► Still Images ► Movies

You can specify the delay (0 – 30 seconds) and number of shots (1 – 10).



1 Choose **[INFO]**.

- Following step 1 in “Using the Self-Timer” (44), choose **[INFO]** and press the **[INFO]** button.

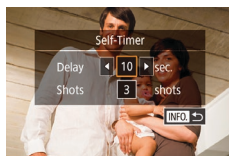

2 Configure the setting.

- Press the **[▲]**/**[▼]** buttons to choose the delay time or number of shots.
- Press the **[◀]**/**[▶]** buttons or turn the **[DISP.]** dial to choose a value, and then press the **[INFO]** button twice.
- Once the setting is complete, **[INFO]** is displayed.
- Follow step 2 in “Using the Self-Timer” (44) to shoot.



- For movies recorded using the self-timer, recording begins after your specified delay time, but specifying the number of shots has no effect.



- When you specify multiple shots, image brightness and white balance are determined by the first shot. More time is required between shots when the flash fires or when you have specified to take many shots. Shooting will stop automatically when the memory card becomes full.
- When a delay longer than two seconds is specified, two seconds before the shot, the lamp blinking and self-timer sound will speed up. (The lamp will remain lit in case the flash fires.)

Before Use

Basic Guide

Advanced Guide

Camera Basics

Auto Mode /
Hybrid Auto Mode

Other Shooting Modes

P Mode

Tv, Av, M, C1, and C2 Mode

Playback Mode

Wireless Features

Setting Menu

Accessories

Appendix

Index



Shooting by Touching the Screen (Touch Shutter)

▶ Still Images ▶ Movies

With this option, instead of pressing the shutter button, you can simply touch the screen and release your finger to shoot. The camera will focus on subjects and adjust image brightness automatically.

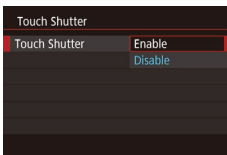
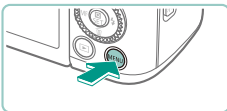

1 Enable the touch-shutter function.

- Press the [MENU] button, choose [Touch Shutter] on the [C2] tab, and then press the [OK] button.
- Choose [Touch Shutter], and then choose [Enable].

2 Shoot.

- Touch the subject on the screen to take the picture.
- To cancel touch shutter, choose [Disable] in step 1.



- An orange AF frame indicates that the camera could not focus on subjects. No shot will be taken.



- Even while the shot is displayed, you can prepare for the next shot by touching [OK].

Continuous Shooting

▶ Still Images ▶ Movies

In [A+] mode, hold the shutter button all the way down to shoot continuously.

For details on the continuous shooting speed, see "Shooting" (213).



1 Configure the setting.

- Press the [MENU] button, choose [] in the menu, and then choose [] or [] (34).
- Once the setting is complete, [] or [] is displayed.

2 Shoot.

- Hold the shutter button all the way down to shoot continuously.

Before Use

Basic Guide

Advanced Guide

Camera Basics

Auto Mode /
Hybrid Auto Mode

Other Shooting Modes

P Mode

Tv, Av, M, C1, and C2 Mode

Playback Mode

Wireless Features

Setting Menu

Accessories

Appendix

Index





- During continuous shooting, focus is locked at the position determined when you pressed the shutter button halfway.
- Cannot be used with the self-timer (📖44).
- Shooting may stop momentarily or continuous shooting may slow down depending on shooting conditions, camera settings, and the zoom position.
- As more shots are taken, shooting may slow down.
- There may be a delay before you can shoot again, depending on shooting conditions, the type of memory card, and how many shots you took continuously.
- Shooting may slow down if the flash fires.
- With Touch Shutter (📖46), the camera shoots continuously while you touch the screen. Focus during continuous shooting remains constant, after it is determined for the first shot.
- Screen display in continuous shooting differs from the images actually captured and may look out of focus. Some lenses may also darken the continuous shooting screen display, but images are captured with standard brightness.



- When nine or fewer shots can be taken continuously, the number available is shown to the right of the total remaining shots on the top of the screen (📖191). It is not shown when 10 or more shots can be taken.
- Fewer continuous shots may be available under some shooting conditions or camera settings.

Image Customization Features

Changing Image Quality

▶ Still Images ▶ Movies

Choose from 7 combinations of size (number of pixels) and compression (image quality). Also specify whether to capture images in RAW format (📖48). For guidelines on how many of each kind of image can fit on a memory card, see “Recording” (📖214).



- Press the [QUAL] button, choose [QUAL] in the menu, and choose the desired option (📖34).
- The option you configured is now displayed.
- To restore the original setting, repeat this process but choose [QUAL].



- [S1] and [S2] indicate different levels of image quality depending on the extent of compression. At the same size (number of pixels), [S1] offers higher image quality. Although [S2] images have slightly lower image quality, more fit on a memory card. Note that [S2]-size images are of [S1] quality.
- Not available in [A+] mode.
- You can also configure this setting by choosing MENU (📖35) > [CAM1] tab > [Image quality].

Before Use

Basic Guide

Advanced Guide

Camera Basics

Auto Mode / Hybrid Auto Mode

Other Shooting Modes

P Mode

Tv, Av, M, C1, and C2 Mode

Playback Mode

Wireless Features

Setting Menu

Accessories

Appendix

Index



When deciding the number of pixels based on print size, use the following table as a guide for images with a 3:2 aspect ratio.

L	A2 (16.5 x 23.4 in.)
M	A3 (11.7 x 16.5 in.)
S1	A4 (8.3 x 11.7 in.)
S2	3.5 x 5 in., 5 x 7 in., Postcard

Capturing in RAW Format

The camera can capture images in JPEG and RAW format.

JPEG Images	Processed in the camera for optimal image quality and compressed to reduce file size. However, the compression process is irreversible, and images cannot be restored to their original, unprocessed state. Image processing may also cause some loss of image quality.
RAW Images	“Raw” (unprocessed) data, recorded with essentially no loss of image quality from the camera’s image processing. The data cannot be used in this state for viewing on a computer or printing. You must first process it on this camera (📖122) or use the Digital Photo Professional application (📖176) to convert images to ordinary JPEG or TIFF files. Images can be adjusted with minimal loss of image quality.



- Press the **[MENU]** button, and then choose **[INFO]** in the menu (📖34).
- To capture in RAW format only, choose the **[RAW]** option.
- To capture images in both JPEG and RAW format simultaneously, choose the JPEG image quality, and then press the **[INFO]** button. A **[✓]** mark is displayed next to **[RAW]**. To undo this setting, follow the same steps and remove the **[✓]** mark next to **[RAW]**.



- When transferring RAW images (or RAW and JPEG images recorded together) to a computer, always use the dedicated software “EOS Utility” (📖176).



- For details on the relationship between the number of recording pixels and the number of shots that will fit on a card, see “Recording” (📖214).
- The file extension for JPEG images is .JPG, and the extension for RAW images is .CR2. File names of JPEG and RAW images captured together have the same image number.
- For details on Digital Photo Professional and EOS Utility applications, see “Software” (📖176). Download software instruction manuals from the Canon website as needed. For downloading instructions, see “Software Instruction Manual” (📖176).

Using the Menu

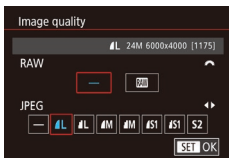

- Press the **[MENU]** button, choose **[Image quality]** on the **[INFO]** tab, and then press the **[INFO]** button (📖35).
- To capture in RAW format at the same time, turn the **[Q]** dial and choose **[RAW]** under **[RAW]**. Note that only JPEG images are captured when **[-]** is selected.
- Press the **[◀]**/**[▶]** buttons or turn the **[Q]** dial to choose **[JPEG]**, and then choose the image size and quality. Note that only RAW images are captured when **[-]** is selected.
- When finished, press the **[MENU]** button to return to the menu screen.



- **[RAW]** and **[JPEG]** cannot both be set to **[-]**.

Before Use

Basic Guide

Advanced Guide

Camera Basics

Auto Mode / Hybrid Auto Mode

Other Shooting Modes

P Mode

Tv, Av, M, C1, and C2 Mode

Playback Mode

Wireless Features

Setting Menu

Accessories

Appendix

Index



Changing the Aspect Ratio

▶ Still Images ▶ Movies

Change the image aspect ratio (ratio of width to height) as follows.



- Press the [ASPECT] button, choose [3:2] in the menu, and choose the desired option (34).
- Once the setting is complete, the screen aspect ratio will be updated.
- To restore the original setting, repeat this process but choose [3:2].

16:9	Used for display on widescreen HDTVs or similar display devices.
3:2	Native aspect ratio of the camera screen, equivalent to 35mm film. Used for printing images at 5 x 7-inch or postcard sizes.
4:3	Used for printing images at 3.5 x 5-inch or A-series sizes.
1:1	Square aspect ratio.



- Not available in [A/S] mode.
- You can also configure this setting by choosing MENU (35) > [1] tab > [Still Image Aspect Ratio].

Changing Movie Image Quality

▶ Still Images ▶ Movies

Adjust movie image quality (image size and frame rate). The frame rate indicates how many frames are recorded per second, which is determined automatically based on the NTSC or PAL setting (157). For guidelines on the total recording time for movies at each level of image quality that will fit on a memory card, see "Recording" (214).



- Press the [MOVIE REC. SIZE] button, choose [Movie rec. size] in the menu, and choose the desired option (34).
- The option you configured is now displayed.

For NTSC Video

Image Quality	Number of Recording Pixels	Frame Rate	Details
[4K] 59.94P	1920 x 1080	59.94 fps	For shooting in Full HD. [4K] 23.98P enables a cinematic frame rate.
[4K] 29.97P	1920 x 1080	29.97 fps	
[4K] 23.98P	1920 x 1080	23.98 fps	
[HD] 59.94P	1280 x 720	59.94 fps	For shooting in HD.
[VGA] 29.97P	640 x 480	29.97 fps	For shooting in standard definition.

Before Use

Basic Guide

Advanced Guide

Camera Basics

Auto Mode / Hybrid Auto Mode

Other Shooting Modes

P Mode

Tv, Av, M, C1, and C2 Mode

Playback Mode

Wireless Features

Setting Menu

Accessories

Appendix

Index



For PAL Video

Image Quality	Number of Recording Pixels	Frame Rate	Details
FHD 50.00P	1920 x 1080	50.00 fps	For shooting in Full HD.
FHD 25.00P	1920 x 1080	25.00 fps	
HD 50.00P	1280 x 720	50.00 fps	For shooting in HD.
VGA 25.00P	640 x 480	25.00 fps	For shooting in standard definition.



- Black bars (displayed on the left and right in VGA 29.97P) and VGA 25.00P) modes and on the top and bottom in FHD 59.94P), FHD 29.97P), FHD 23.98P), FHD 59.94P), FHD 50.00P), FHD 25.00P), and FHD 50.00P) modes) indicate image areas not recorded.
- You can also configure this setting by choosing MENU (📖 35) > [📷] tab > [Movie rec. size].

Helpful Shooting Features

Using the Dual Axis Electronic Level

▶ Still Images ▶ Movies

An electronic level can be displayed as a guideline to ensure the camera is level from front to back and left to right.



(1) (2)

1 Display the electronic level.

- Press the [INFO] button several times to display the electronic level.

2 Straighten the camera.

- (1) indicates the front-back orientation and (2) the left-right orientation.
- If the camera is tilted, move it so that the red line changes to green.



- If the electronic level is not displayed in step 1, check the setting in MENU (📖 35) > [📷] tab > [Shooting information display] (📖 95).
- The electronic level is not displayed in [A] mode or during movie recording.
- If you hold the camera vertically, the orientation of the electronic level will be updated automatically to match the camera orientation.
- Calibrate the electronic level if it seems ineffective in helping you level the camera (📖 157).

Before Use

Basic Guide

Advanced Guide

Camera Basics

Auto Mode / Hybrid Auto Mode

Other Shooting Modes

P Mode

Tv, Av, M, C1, and C2 Mode

Playback Mode

Wireless Features

Setting Menu

Accessories

Appendix

Index



Using Auto Level

▶ Still Images ▶ Movies

Auto leveling keeps movies straight.

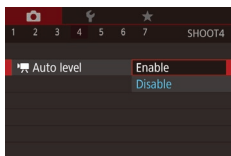

- Press the [MENU] button, choose [Auto level] on the [4] tab, and then press the [SET] button (835).
- Choose [Enable], and press the [SET] button again (835).



- When you set [Digital IS] to [Enable] or [Enhanced] (86), [Auto level] is set to [Disable] and cannot be changed.



- Once recording begins, the display area narrows, and subjects are enlarged (86).

Customizing Camera Operation

Customize shooting functions on the [3] tab of the menu screen as follows.

For instructions on menu functions, see “Using the Menu Screen” (835).

Preventing the AF-Assist Beam from Firing

▶ Still Images ▶ Movies

You can deactivate the lamp that normally lights up to help you focus when you press the shutter button halfway in low-light conditions.

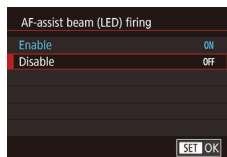

- Press the [MENU] button, choose [AF-assist beam (LED) firing] on the [3] tab, and then choose [Disable].
- To restore the original setting, repeat this process but choose [Enable].

Deactivating the Red-Eye Reduction Lamp

▶ Still Images ▶ Movies

You can deactivate the red-eye reduction lamp that lights up to reduce red-eye when the flash is used in low-light shots.

1 Access the [Flash Control] screen.

- Press the [MENU] button, choose [Flash Control] on the [5] tab, and then press the [SET] button (835).

Before Use

Basic Guide

Advanced Guide

Camera Basics

Auto Mode /
Hybrid Auto Mode

Other Shooting Modes

P Mode

Tv, Av, M, C1, and C2 Mode

Playback Mode

Wireless Features

Setting Menu

Accessories

Appendix

Index



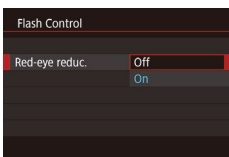

2 Configure the setting.

- Choose [Red-eye reduc.], and then choose [Off] (📖35).
- To restore the original setting, repeat this process but choose [On].

Changing the Image Display Period after Shots

▶ Still Images ▶ Movies

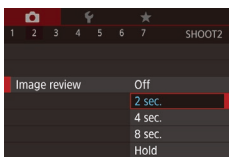

- Press the [MENU] button, choose [Image review] on the [📷2] tab, and then choose the desired option.
- To restore the original setting, repeat this process but choose [2 sec.].

2 sec., 4 sec., 8 sec.	Displays images for the specified time. Even while the shot is displayed, you can take another shot by pressing the shutter button halfway again.
Hold	Displays images until you press the shutter button halfway.
Off	No image display after shots.



- By pressing the [INFO.] button while an image is displayed after shooting, you can switch the display information.

Before Use

Basic Guide

Advanced Guide

Camera Basics

Auto Mode /
Hybrid Auto Mode

Other Shooting Modes

P Mode

Tv, Av, M, C1, and C2 Mode

Playback Mode

Wireless Features

Setting Menu

Accessories

Appendix

Index



Other Shooting Modes

Shoot more effectively in various scenes, and take shots enhanced with unique image effects or captured using special functions

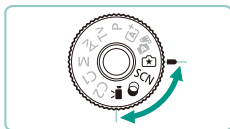

Shooting with Your Favorite Settings (Creative Assist)

Capture shots just as you imagine them, without having to know photography terms. Choose from easy-to-understand options to defocus the background, adjust brightness, or customize shots in other ways as you watch the screen. Once you save the settings you like, it's easy to apply them again later. You can also apply settings from past images captured in [Creative Assist] mode.

This mode makes it easier to learn about Creative Zone shooting modes ([P], [Tv], [Av], and [M]), because you can check the corresponding settings in these modes when viewing images shot in [Creative Assist] mode. Customize shots in these ways.

Background	Adjust the appearance of the background. Choose higher values to make backgrounds sharper, or lower values to make them blurrier.
Brightness	Adjust image brightness. Choose higher values to brighten images.
Contrast	Adjust contrast. Choose higher values to increase the contrast.
Saturation	Adjust the vividness of colors. Choose higher values to make colors more vivid, or lower values to make them subdued.
Color tone	Adjust color tone. Choose higher values to make colors warmer, or lower values to make them cooler.
Monochrome	Choose from five monochrome options: [BW B/W], [S Sepia], [B Blue], [P Purple], or [G Green]. Set to [OFF] to shoot in color. Note that [Saturation] and [Color tone] are not available with options other than [OFF].

Before Use

Basic Guide

Advanced Guide

Camera Basics

Auto Mode /
Hybrid Auto Mode

Other Shooting Modes

P Mode

Tv, Av, M, C1, and C2 Mode

Playback Mode

Wireless Features

Setting Menu

Accessories

Appendix

Index



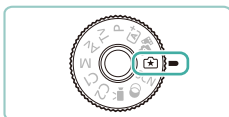

1 Enter [C] mode.

- Hold down the mode dial release button and turn the mode dial to [C].

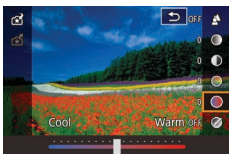

2 Configure the settings.

- Press the [INFO] button, press the [▲][▼] buttons to choose an item, and then adjust the setting, either by pressing the [◀][▶] buttons or turning the [G][H] dials (see 34).
- Once you are finished adjusting each item, press the [MENU] button to return to the shooting screen.

3 Shoot.



- [Background] is not available when the flash is used.



- Setting options labeled with [G] on the shooting screen can be adjusted by turning the [G] dial. By pressing the [▲][▼] buttons, you can also move [G] to switch to another option for adjustment.
- To prevent your settings from being reset when the camera is turned off, set [Keep C] setting] on the [C] tab to [Enable].



- You can also access the setting screen by touching [Q] in the upper right, and you can touch items on the setting screen to adjust them. Touch [S] to return to the shooting screen.

Saving/Loading Settings

Save your favorite settings and use them again as needed.

Saving Settings



- Follow steps 1 – 2 in “Shooting with Your Favorite Settings (Creative Assist)” (see 53) to choose [C] and configure the settings as desired.
- Press the [INFO] button, press the [▲][▼] buttons to choose [C], and then choose a profile to save the settings to, either by pressing the [◀][▶] buttons or turning the [G][H] dials.
- You can save setting in up to six profiles.
- [INFO Compare] is displayed if you have already assigned the selected profile. With this profile selected, you can press the [INFO] button to view the previous settings and compare them to your new settings.
- Press the [INFO] button, press the [◀][▶] buttons or turn the [G] dial to choose [OK] after the confirmation message, and then press the [INFO] button.

Before Use

Basic Guide

Advanced Guide

Camera Basics

Auto Mode / Hybrid Auto Mode

Other Shooting Modes

P Mode

Tv, Av, M, C1, and C2 Mode

Playback Mode

Wireless Features

Setting Menu

Accessories

Appendix

Index



Loading Settings



- Follow step 1 in “Shooting with Your Favorite Settings (Creative Assist)” (p.53) and choose [INFO].
- Press the [INFO] button, press the [▲][▼] buttons to choose [INFO], and then choose a profile to load, either by pressing the [◀][▶] buttons or turning the [INFO] dials.
- Press the [INFO] button to apply the saved settings.
- To return without applying settings, choose [-] and press the [INFO] button.

Using Settings from Images

Load settings from images captured in [INFO] mode to use them when shooting.



- Follow step 1 in “Shooting with Your Favorite Settings (Creative Assist)” (p.53) and choose [INFO].
- Press the [▶] button to enter Playback mode, and then choose an image captured in [INFO] mode to display it.
- Press the [INFO] button, choose [INFO] in the menu, and press the [INFO] button again.
- The settings are applied, and the camera enters Shooting mode.



- Settings cannot be applied when the mode dial is set to a mode other than [INFO]. A message is displayed if this is attempted, and the camera remains in Playback mode. To apply settings, set the mode dial to [INFO].
- [INFO] is not displayed for images shot in modes other than [INFO] mode.

Viewing Settings

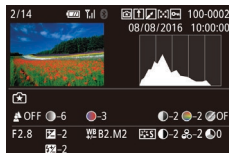

- To check the settings of images you view that were captured in [INFO] mode, press the [INFO] button. The screen at left is displayed.

Creative Zone Settings Corresponding to Creative Assist Mode Settings

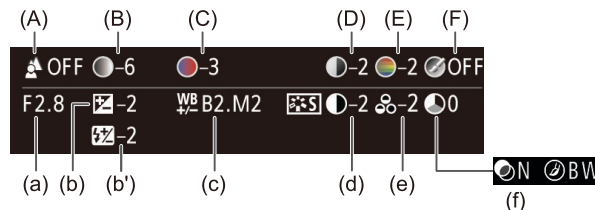

[INFO] Mode Setting	Creative Zone Setting
(A) Background	(a) Aperture value (p.91)
(B) Brightness	(b) Exposure compensation (p.69) However, in flash shots, corresponds to (b'), flash exposure compensation (p.83)
(C) Color tone	(c) White balance correction (p.73)
(D) Contrast	(d) Picture Style contrast (p.76)
(E) Saturation	(e) Picture Style saturation (p.76)
(F) Monochrome	(f) Picture Style filter and toning effect (p.76)

Before Use

Basic Guide

Advanced Guide

Camera Basics

Auto Mode / Hybrid Auto Mode

Other Shooting Modes

P Mode

Tv, Av, M, C1, and C2 Mode

Playback Mode

Wireless Features

Setting Menu

Accessories

Appendix

Index



Specific Scenes

Choose a mode matching the shooting scene, and the camera will automatically configure the settings for optimal shots.



1 Enter [SCN] mode.

- Hold down the mode dial release button and turn the mode dial to [SCN].



2 Choose a shooting mode.

- Press the [Q] button, choose [SCN] in the menu, and then choose a shooting mode (p.34).

3 Shoot.



- You can also choose a shooting mode by touching [SCN] in the upper left after you set the mode dial to [SCN].



👤 Shooting Portraits (Portrait)

▶ Still Images ▶ Movies

- Take shots of people with a softening effect.



🏞 Shooting Landscapes (Landscape)

▶ Still Images ▶ Movies

- Capture wide-open landscapes or similar scenery in sharp focus from near to far, with blue skies and greenery reproduced vividly.



🌸 Shooting Close-ups (Close-up)

▶ Still Images ▶ Movies

- Take close-ups of flowers or other small objects to enlarge them in your shots.
- To make small things appear much larger, use a macro lens (sold separately).
- Check the minimum focusing distance of the attached lens to determine how close to subjects you can shoot. The lens minimum focusing distance is measured from the [-∞] (focal plane) mark on the top of the camera to the subject.



🏊 Moving Subjects (Sports)

▶ Still Images ▶ Movies

- Shoot continuously as the camera keeps the subject in focus.

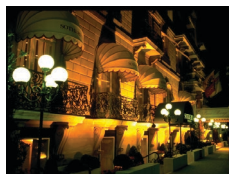

🌃 Shooting Evening Scenes without Using a Tripod (Handheld Night Scene)

▶ Still Images ▶ Movies

- Beautiful shots of evening scenes or portraits with evening scenery in the background, without the need to hold the camera very still (as with a tripod).
- A single image is created by combining consecutive shots, reducing camera shake and image noise.

Before Use

Basic Guide

Advanced Guide

Camera Basics

Auto Mode / Hybrid Auto Mode

Other Shooting Modes

P Mode

Tv, Av, M, C1, and C2 Mode

Playback Mode

Wireless Features

Setting Menu

Accessories

Appendix

Index





- Subjects appear larger in [P] mode compared to other modes.
- In [A+] and [P] mode, shots may look grainy because the ISO speed (p.71) is increased to suit the shooting conditions.
- Because the camera will shoot continuously in [P] mode, hold it steady while shooting.
- In [P] mode, excessive motion blur or certain shooting conditions may prevent you from obtaining the desired results.



- When you use a tripod for evening scenes, shooting in [A+] mode instead of [P] mode will give better results (p.39).

Shooting Yourself under Optimal Settings (Self Portrait)

▶ Still Images ▶ Movies

For self-portraits, customizable image processing includes skin smoothing as well as brightness and background adjustment to make yourself stand out.

1 Choose [P].

- Follow steps 1 – 2 in “Specific Scenes” (p.56) and choose [P].

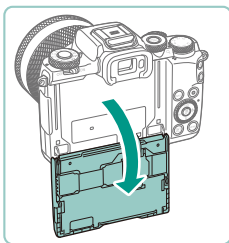

2 Open the screen.

- Open the screen as shown.

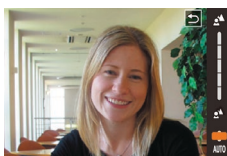

3 Configure the setting.

- On the screen, touch the icon of the setting to configure.

- Choose the desired option.
- To return to the previous screen, touch [↩].

4 Shoot.

Item	Details
	Choose from [AUTO] or one of five levels of background defocusing.
	Choose from five levels of brightness.
	Choose from five levels of skin smoothing. Skin smoothing is optimized for the main subject's face.
	To use touch shutter, choose [ON].



- Areas other than people's skin may be modified, depending on the shooting conditions.
- Try taking some test shots first to make sure you obtain the desired results.



- In [Flash] mode, [Flash] is set to [AUTO] and cannot be changed.
- In [P] mode, the time left before shooting is shown on the top of the screen when you activate the self-timer by selecting [Timer], or by selecting [Self-Timer] and setting the time to 3 seconds or more.

Before Use

Basic Guide

Advanced Guide

Camera Basics

Auto Mode / Hybrid Auto Mode

Other Shooting Modes

P Mode

Tv, Av, M, C1, and C2 Mode

Playback Mode

Wireless Features

Setting Menu

Accessories

Appendix

Index



Enhancing Colors in Shots of Food (Food)

▶ Still Images ▶ Movies

Adjust color tones to make food look fresh and vibrant.

1 Choose [Fn].

- Follow steps 1 – 2 in “Specific Scenes” (p.56) and choose [Fn].



2 Change the color tone.

- Turn the [Fn] dial to adjust the color tone.

3 Shoot.



- These color tones may not look suitable when applied to people.
- In flash shots, color tones are automatically set to the default setting.

Conveying a Sense of Speed by Blurring the Background (Panning)

▶ Still Images ▶ Movies

By panning, you can blur the background to convey a sense of speed. Attaching a lens compatible with [Fn] mode enables detection and correction of subject blurring, which helps keep subjects clear and sharp. For details on lenses compatible with [Fn] mode, visit the Canon website.

1 Choose [Fn].

- Follow steps 1 – 2 in “Specific Scenes” (p.56) and choose [Fn].



2 Shoot.

- Before shooting, press the shutter button halfway as you move the camera so that it follows the subject.
- Keep the moving subject in the frame displayed, and press the shutter button all the way down.
- Even after you have pressed the shutter button fully, continue moving the camera to follow the subject.



- Subject blurring is not reduced unless the lens is compatible with [Fn] mode, but shutter speed is adjusted automatically to match the effect level.
- Try taking some test shots first, to make sure you obtain the desired results.
- In bright scenes, it may not be possible to apply the effect at your specified level.



- To adjust the effect level, turn the [Fn] dial.
- You can move the frame by dragging it or touching the screen.
- For best results, hold the camera securely in both hands, with your elbows close to your body, and rotate your whole body to follow the subject.
- This feature is more effective for subjects moving horizontally, such as cars or trains.

Before Use

Basic Guide

Advanced Guide

Camera Basics

Auto Mode /
Hybrid Auto Mode

Other Shooting Modes

P Mode

Tv, Av, M, C1, and C2 Mode

Playback Mode

Wireless Features

Setting Menu

Accessories

Appendix

Index



Shooting in Backlit Scenes (HDR Backlight Control)

▶ Still Images ▶ Movies

Three consecutive images are captured at different brightness levels each time you shoot, and the camera combines image areas with optimal brightness to create a single image. This mode can reduce the loss of detail in shadows that tends to occur in shots with mixed bright and dark image areas.

1 Choose [📷].

- Follow steps 1 – 2 in “Specific Scenes” (📖 56) and choose [📷].



2 Shoot.

- Hold the camera steady as you shoot. When you press the shutter button all the way down, the camera will take three shots and combine them.



- Subjects are displayed larger than in other modes.
- Excessive motion blur or certain shooting conditions may prevent you from obtaining the desired results.



- If excessive camera shake interferes with shooting, mount the camera on a tripod or take other measures to keep it still. In this case, also disable image stabilization (📖 86).
- Any subject movement will cause images to look blurry.
- There will be a delay before you can shoot again, as the camera processes and combines the images.

Image Effects (Creative Filters)

Add a variety of effects to images when shooting.

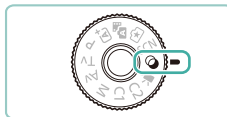

1 Enter [📷] mode.

- Hold down the mode dial release button and turn the mode dial to [📷].



2 Choose a shooting mode.

- Press the [📷] button, choose [📷] in the menu, and then choose a shooting mode (📖 34).

3 Shoot.



- You can also choose a shooting mode by touching [📷] in the upper left after you set the mode dial to [📷].

Before Use

Basic Guide

Advanced Guide

Camera Basics

Auto Mode /
Hybrid Auto Mode

Other Shooting Modes

P Mode

Tv, Av, M, C1, and C2 Mode

Playback Mode

Wireless Features

Setting Menu

Accessories

Appendix

Index



Shooting in Monochrome (Grainy B/W)

▶ Still Images ▶ Movies

Take monochrome pictures with a gritty, rough feeling.

1 Choose [E].

- Follow steps 1 – 2 in “Image Effects (Creative Filters)” (📖59) and choose [E].



2 Choose an effect level.

- Turn the [☀️] dial to choose an effect level.
- A preview is shown of how your shot will look with the effect applied.

3 Shoot.

Shooting with a Soft Focus Effect

▶ Still Images ▶ Movies

This function allows you to shoot images as if a soft focus filter were attached to the camera. You can adjust the effect level as desired.

1 Choose [G].

- Follow steps 1 – 2 in “Image Effects (Creative Filters)” (📖59) and choose [G].



2 Choose an effect level.

- Turn the [☀️] dial to choose an effect level.
- A preview is shown of how your shot will look with the effect applied.

3 Shoot.



- Try taking some test shots first, to make sure you obtain the desired results.

Shooting with a Fish-Eye Lens Effect (Fish-Eye Effect)

▶ Still Images ▶ Movies

Shoot with the distorting effect of a fish-eye lens.

1 Choose [H].

- Follow steps 1 – 2 in “Image Effects (Creative Filters)” (📖59) and choose [H].



2 Choose an effect level.

- Turn the [☀️] dial to choose an effect level.
- A preview is shown of how your shot will look with the effect applied.

3 Shoot.



- Try taking some test shots first, to make sure you obtain the desired results.

Before Use

Basic Guide

Advanced Guide

Camera Basics

Auto Mode / Hybrid Auto Mode

Other Shooting Modes

P Mode

Tv, Av, M, C1, and C2 Mode

Playback Mode

Wireless Features

Setting Menu

Accessories

Appendix

Index



Shots Resembling Oil Paintings (Art Bold Effect)

▶ Still Images ▶ Movies

Make subjects look more substantial, like subjects in oil paintings.

1 Choose [🎨].

- Follow steps 1 – 2 in “Image Effects (Creative Filters)” (📖59) and choose [🎨].



2 Choose an effect level.

- Turn the [🔆] dial to choose an effect level.
- A preview is shown of how your shot will look with the effect applied.

3 Shoot.

Shots Resembling Watercolors (Water Painting Effect)

▶ Still Images ▶ Movies

Soften colors, for photos resembling watercolor paintings.

1 Choose [🎨].

- Follow steps 1 – 2 in “Image Effects (Creative Filters)” (📖59) and choose [🎨].



2 Choose an effect level.

- Turn the [🔆] dial to choose an effect level.
- A preview is shown of how your shot will look with the effect applied.

3 Shoot.

Shooting with a Toy Camera Effect (Toy Camera Effect)

▶ Still Images ▶ Movies

This effect makes images resemble shots from a toy camera by vignetting (darker, blurred image corners) and changing the overall color.

1 Choose [📷].

- Follow steps 1 – 2 in “Image Effects (Creative Filters)” (📖59) and choose [📷].



2 Choose a color tone.

- Turn the [🔆] dial to choose a color tone.
- A preview is shown of how your shot will look with the effect applied.

3 Shoot.

Standard	Shots resemble toy camera images.
Warm	Images have a warmer tone than with [Standard].
Cool	Images have a cooler tone than with [Standard].



- Try taking some test shots first, to make sure you obtain the desired results.

Before Use

Basic Guide

Advanced Guide

Camera Basics

Auto Mode /
Hybrid Auto Mode

Other Shooting Modes

P Mode

Tv, Av, M, C1, and C2 Mode

Playback Mode

Wireless Features

Setting Menu

Accessories

Appendix

Index



Shots Resembling Miniature Models (Miniature Effect)

▶ Still Images ▶ Movies

Creates the effect of a miniature model, by blurring image areas above and below your selected area. You can also make movies that look like scenes in miniature models by choosing the playback speed before the movie is recorded. People and objects in the scene will move quickly during playback. Note that sound is not recorded.

1 Choose [].

- Follow steps 1 – 2 in “Image Effects (Creative Filters)” (📖 59) and choose [].
- A white frame is displayed, indicating the image area that will not be blurred.



2 Choose the area to keep in focus.

- Press the [] button.
- Press the [INFO] button to resize the frame, and press the [][] buttons or turn the [] dial to move it.

3 For movies, choose the movie playback speed.

- Turn the [] dial to choose the speed.

4 Return to the shooting screen and shoot.

- Press the [] button to return to the shooting screen, and then shoot.



Playback Speed and Estimated Playback Time (for One-Minute Clips)

Speed	Playback Time
5x	Approx. 12 sec.
10x	Approx. 6 sec.
20x	Approx. 3 sec.



- Try taking some test shots first, to make sure you obtain the desired results.



- To switch the orientation of the frame to vertical, press the [◀][▶] buttons in step 2. To move the frame, press the [◀][▶] buttons again. To return the frame to horizontal orientation, press the [][] buttons.
- Holding the camera vertically will change the orientation of the frame.
- Movie quality varies depending on the video system (📖 157) and still image aspect ratio (📖 49).
 - With [NTSC], movie quality is [EVCGA 29.97P] for an aspect ratio of [4:3].
 - With [PAL], movie quality is [EVCGA 25.00P] for an aspect ratio of [4:3].



- You can also move the frame by touching or dragging across the screen.

Before Use

Basic Guide

Advanced Guide

Camera Basics

Auto Mode /
Hybrid Auto Mode

Other Shooting Modes

P Mode

Tv, Av, M, C1, and C2 Mode

Playback Mode

Wireless Features

Setting Menu

Accessories

Appendix

Index



Shooting High-Contrast Scenes (High Dynamic Range)

▶ Still Images ▶ Movies

Three consecutive images are captured at different brightness levels each time you shoot, and the camera combines image areas with optimal brightness to create a single image. This mode can reduce the washed-out highlights and loss of detail in shadows that tend to occur in high-contrast shots.

1 Choose [HDR].

- Follow steps 1 – 2 in “Image Effects (Creative Filters)” (📖59) and choose [HDR].



2 Shoot.

- Hold the camera steady as you shoot. When you press the shutter button all the way down, the camera will take three shots and combine them.



- Excessive motion blur or certain shooting conditions may prevent you from obtaining the desired results.



- If excessive camera shake interferes with shooting, mount the camera on a tripod or take other measures to keep it still. In this case, also disable image stabilization (🔧86).
- Any subject movement will cause images to look blurry.
- There will be a delay before you can shoot again, as the camera processes and combines the images.

Adding Artistic Effects



- Follow steps 1 – 2 in “Image Effects (Creative Filters)” (📖59) and choose [HDR].
- Turn the [🔧] dial to choose an effect.
- A preview is shown of how your shot will look with the effect applied.

Natural	Images are natural and organic.
Art Standard	Images resemble paintings, with subdued contrast.
Art Vivid	Images resemble vivid illustrations.
Art Bold	Images resemble oil paintings, with bold edges.
Art Embossed	Images resemble old photos, with bold edges and dark ambiance.

Before Use

Basic Guide

Advanced Guide

Camera Basics

Auto Mode /
Hybrid Auto Mode

Other Shooting Modes

P Mode

Tv, Av, M, C1, and C2 Mode

Playback Mode

Wireless Features

Setting Menu

Accessories

Appendix

Index



Recording Movies in Movie Mode

▶ Still Images ▶ Movies

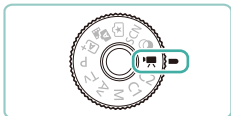

1 Enter [MOVIE] mode.

- Hold down the mode dial release button and turn the mode dial to [MOVIE].
- Black bars displayed on the top and bottom edges of the screen indicate image areas not recorded.
- Press the [MENU] button, choose [MOVIE] in the menu, and then choose [MOVIE] (194).

2 Configure the settings to suit the movie (194).

3 Shoot.

- Press the movie button.
- To stop movie recording, press the movie button again.



- In [MOVIE] mode, the image display area narrows and subjects are enlarged.



- To readjust the focus and exposure while recording a movie, press the shutter button halfway. (The camera will not beep.)



- You can lock the focus during recording by touching [AF]. [MF] is then displayed.
- To switch between recording with auto focus and a fixed focus, touch [SERVO AF] on the screen before or during recording. (Auto focus is indicated by a green [O] in the upper left of the [SERVO AF] icon.) Note that this icon is not displayed when [Movie Servo AF] (142) is set to [Disable] on the [CAMERA] tab of the menu.

Locking or Changing Image Brightness before Recording

▶ Still Images ▶ Movies

You can lock the exposure before or during recording or adjust it in 1/3-stop increments within a range of -3 to +3 stops.



- Press the [X] button to lock the exposure. To unlock the exposure, press the [X] button again.
 - Turn the exposure compensation dial to adjust the exposure, as you watch the screen.
- You can also lock or unlock the exposure by touching [X].
 - During recording, you can also adjust exposure by touching the exposure compensation bar on the bottom of the screen and then touching [—][+].
 - The amount that exposure is adjusted by touching the screen differs from the amount set by using the exposure compensation dial. Check the image displayed.

Before Use

Basic Guide

Advanced Guide

Camera Basics

Auto Mode / Hybrid Auto Mode

Other Shooting Modes

P Mode

Tv, Av, M, C1, and C2 Mode

Playback Mode

Wireless Features

Setting Menu

Accessories

Appendix

Index



Disabling Auto Slow Shutter

▶ Still Images ▶ Movies

Auto slow shutter can be disabled if movement in movies is rough. However, under low light, movies may look dark.



- Press the [MENU] button, choose [Auto slow shutter] on the [8] tab, and then choose [A-SLOW OFF] (📖35).
- To restore the original setting, repeat this process but choose [A-SLOW ON].

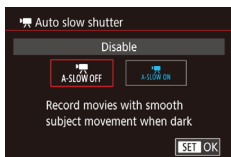

- Auto Slow Shutter is available for [FHD 59.94P], [FHD 59.94P], [FHD 50.00P], and [HD 50.00P] movies.

Recording Time-Lapse Movies (Time-Lapse Movie)

▶ Still Images ▶ Movies

Time-lapse movies combine images that are shot automatically at a specified interval. Any gradual changes of the subject (such as changes in a landscape) are played back in fast motion. You can adjust the shooting interval and number of shots.

1 Choose [📷].

- Hold down the mode dial release button and turn the mode dial to [📷].
- Press the [G] button, choose [📷] in the menu, and then choose [📷] (📖34).
- Black bars displayed on the top and bottom edges of the screen indicate image areas not recorded.

2 Configure movie settings.

- Press the [▲] button.
- Press the [▲][▼] buttons or turn the [G] dial to choose an item. Choose the desired option, and then press the [MENU] button.

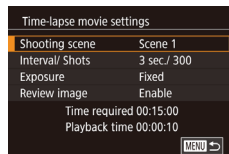

3 Secure the camera.

- Mount the camera on a tripod or take other measures to keep it still.

4 Shoot.

- To start recording, press the movie button.
- Do not disturb the camera while shooting.
- To cancel shooting, press the movie button again.
- The camera operates in Eco mode (📖157) while shooting.

Before Use

Basic Guide

Advanced Guide

Camera Basics

Auto Mode / Hybrid Auto Mode

Other Shooting Modes

P Mode

Tv, Av, M, C1, and C2 Mode

Playback Mode

Wireless Features

Setting Menu

Accessories

Appendix

Index



Item	Details
Shooting scene	Choose from four types of scenes.
Interval/ Shots	Choose the shooting interval (in seconds) and total number of shots.
Exposure	Choose whether exposure is determined by the first shot or adjusted for each shot.
Review image	Display the previous shot for up to 2 seconds.

Item	Details
Time required	Length of the recording session. Varies depending on the shooting interval and number of shots. <ul style="list-style-type: none"> - Scene 1: Up to 1 hour - Scene 2 or 3: Up to 2 hours - Custom: Up to 7.5 hours
Playback time	Playback time of the movie created from captured still images.



- Fast-moving subjects may look distorted in movies.



- When [Exposure] is set to [Fixed], exposure can also be locked by pressing the [✖] button before shooting.
- Sound is not recorded.
- Focus remains constant during shooting, after it is determined for the first shot.
- The movie quality is [FHD] and cannot be changed.
- The time-lapse movie frame rate is automatically set to [FHD 29.97P] for NTSC or [FHD 25.00P] for PAL and cannot be changed (157).
- You can also configure this setting by choosing MENU (35) > [G] tab > [Time-lapse movie settings].

Sound Settings

▶ Still Images ▶ Movies

Adjusting the Recording Volume

Although the recording level (volume) is automatically adjusted, you can set the level manually to suit the shooting scene.



1 Access the [Sound recording] screen.

- Press the [MENU] button, choose [Sound recording] on the [G] tab, and then press the [G] button (35).

2 Configure the setting.

- Choose [Sound recording], press the [G] button, choose [Manual] on the next screen (either press the [▲][▼] buttons or turn the [G] dial), and then press the [G] button.
- Press the [▼] button to choose [Rec. level], and then press the [G] button. On the next screen, press the [◀][▶] buttons or turn the [G] dial to adjust the level, and then press the [G] button.
- To restore the original setting, repeat this process but choose [Auto].

Before Use

Basic Guide

Advanced Guide

Camera Basics

Auto Mode / Hybrid Auto Mode

Other Shooting Modes

P Mode

Tv, Av, M, C1, and C2 Mode

Playback Mode

Wireless Features

Setting Menu

Accessories

Appendix

Index



Deactivating the Wind Filter

Noise caused by strong wind can be reduced. However, the recording may sound unnatural when this option is used when there is no wind. In this case, you can deactivate the wind filter.

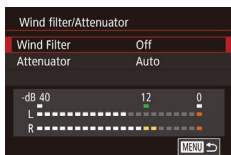

- Access the [Sound recording] screen as described in step 1 of “Adjusting the Recording Volume” (📖66).
- Choose [Wind filter/Attenuator], and then press the [ⓘ] button.
- Choose [Wind Filter], and then choose [Off].

Using the Attenuator

Set to [Auto] to reduce audio distortion by automatically activating and deactivating the attenuator to suit shooting conditions. The attenuator can also be set to [On] or [Off] manually.

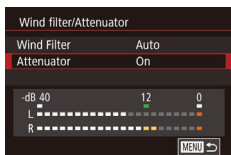

- Access the [Sound recording] screen as described in step 1 of “Adjusting the Recording Volume” (📖66).
- Choose [Wind filter/Attenuator], and then press the [ⓘ] button.
- Choose [Attenuator], and then choose [On] or [Off].

Before Use

Basic Guide

Advanced Guide

Camera Basics

Auto Mode /
Hybrid Auto Mode

Other Shooting Modes

P Mode

Tv, Av, M, C1, and C2 Mode

Playback Mode

Wireless Features

Setting Menu

Accessories

Appendix

Index



P Mode

More discerning shots, in your preferred shooting style

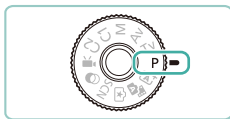

- Instructions in this chapter apply to the camera with the mode dial set to **[P]** mode.
- **[P]**: Program AE; AE: Auto Exposure
- Before using a function introduced in this chapter in modes other than **[P]**, make sure the function is available in that mode (📖194).

Shooting in Program AE ([P] Mode)

▶ Still Images ▶ Movies

You can customize many function settings to suit your preferred shooting style.



1 Enter **[P]** mode.

- Hold down the mode dial release button and turn the mode dial to **[P]**.

2 Customize the settings as desired (📖69 – 📖89), and then shoot.



- Movies can be recorded in **[P]** mode as well, by pressing the movie button. However, some menu settings (📖34, 📖35) may be automatically adjusted for movie recording.

Before Use

Basic Guide

Advanced Guide

Camera Basics

Auto Mode / Hybrid Auto Mode

Other Shooting Modes

P Mode

Tv, Av, M, C1, and C2 Mode

Playback Mode

Wireless Features

Setting Menu

Accessories

Appendix

Index



Setting Up Shooting from a Single Screen

The INFO. Quick Control screen provides convenient, single-screen access to a variety of shooting settings.



1 Access the INFO. Quick Control screen.

- Press the [INFO.] button a few times to display the INFO. Quick Control screen.

2 Choose a setting to configure.

- To view a description, choose an item by pressing the [▲][▼][◀][▶] buttons.
- Turn the [☀][☾] dials to adjust a setting.



- The items that are displayed and configurable vary by shooting mode.



- Some settings are configured on another screen that opens when you select the setting and press the [INFO.] button. Items labeled with [INFO.] on the second screen can be configured by pressing the [INFO.] button. To return to the INFO. Quick Control screen, press the [INFO.] button.



- You can also access setting screens by touching a setting on the INFO. Quick Control screen and then touching the setting again. To return to the INFO. Quick Control screen, touch [INFO].
- To close a setting description, touch [X] in the upper right of the description.

Image Brightness (Exposure)

Adjusting Image Brightness (Exposure Compensation)

▶ Still Images ▶ Movies

The standard exposure set by the camera can be adjusted in 1/3-stop increments, in a range of -3 to +3.



- As you watch the screen, turn the exposure compensation dial to adjust brightness.

Deactivating Exposure Simulation

▶ Still Images ▶ Movies

Images are displayed at a brightness simulating the actual brightness as captured. For this reason, screen brightness is also adjusted in response to changes in exposure compensation. This feature can be disabled to keep the screen at a brightness convenient for shooting, unaffected by exposure compensation.



- Press the [MENU] button, choose [Expo. simulation] on the [1] tab, and then choose [Disable] (35).

Before Use

Basic Guide

Advanced Guide

Camera Basics

Auto Mode / Hybrid Auto Mode

Other Shooting Modes

P Mode

Tv, Av, M, C1, and C2 Mode

Playback Mode

Wireless Features

Setting Menu

Accessories

Appendix

Index



Locking Image Brightness / Exposure (AE Lock)

▶ Still Images ▶ Movies

Before shooting, you can lock the exposure, or you can specify focus and exposure separately.



1 Lock the exposure.

- Aim the camera at the subject to shoot with the exposure locked, and then press the **[*]** button.
- **[*]** is displayed, and the exposure is locked.
- To unlock AE, press the **[*]** button again. **[*]** is no longer displayed.

2 Compose the shot and shoot.



- AE: Auto Exposure
- After the exposure is locked, you can adjust the combination of shutter speed and aperture value by turning the **[S]** dial (Program Shift).





Changing the Metering Method

▶ Still Images ▶ Movies

Adjust the metering method (how brightness is measured) to suit shooting conditions as follows.



- Press the **[M]** button, choose **[M]** in the menu, and choose the desired option (**[M]** 34).
- The option you configured is now displayed.

 Evaluative metering	For typical shooting conditions, including backlit shots. Maintains standard exposure of subjects through automatic adjustments to match the shooting conditions.
 Partial metering	Effective when the background is much brighter than the subject due to backlighting, etc. Metering is restricted to within the circular metering frame in the center of the screen.
 Spot metering	This is for metering a specific spot of the subject or scene. Metering is restricted to within the circular spot metering frame in the center of the screen.
 Center-weighted average	Determines the average brightness of light across the entire image area, calculated by treating brightness in the central area as more important.



- With **[M]**, the exposure is locked at the level determined when you press the shutter button halfway. With **[M]**, **[M]**, or **[M]**, the exposure is not locked then but determined the moment you shoot.
- You can also configure this setting by choosing MENU (**[M]** 35) > **[M]** tab > [Metering mode].

Before Use

Basic Guide

Advanced Guide

Camera Basics

Auto Mode /
Hybrid Auto Mode

Other Shooting Modes

P Mode

Tv, Av, M, C1, and C2 Mode

Playback Mode

Wireless Features

Setting Menu

Accessories

Appendix

Index



Changing the ISO Speed

▶ Still Images ▶ Movies

Set the ISO speed to [AUTO] for automatic adjustment to suit the shooting mode and conditions. Otherwise, set a higher ISO speed for higher sensitivity, or a lower value for lower sensitivity.



- To adjust a setting, turn the [ZOOM] dial.
- The option you configured is now displayed.



- To view the automatically determined ISO speed when you have set the ISO speed to [AUTO], press the shutter button halfway.
- Although choosing a lower ISO speed may reduce image graininess, there may be a greater risk of subject and camera shake in some shooting conditions.
- Choosing a higher ISO speed will increase shutter speed, which may reduce subject and camera shake and increase the flash range. However, shots may look grainy.
- You can also set the ISO speed by accessing MENU (book 35) > [C5] tab > [ISO speed] > [ISO Speed].

Adjusting ISO Auto Settings

▶ Still Images ▶ Movies

You can limit the ISO speed when ISO speed is set to [AUTO].

1 Access the setting screen.

- Press the [MENU] button, choose [ISO speed] on the [C5] tab, and then press the [ZOOM] button (book 35).

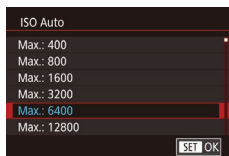

2 Configure the setting.

- Choose [ISO Auto], and then choose an option (book 35).

Auto Exposure Bracketting (AEB Shooting)

▶ Still Images ▶ Movies

Three consecutive images are captured at different exposure levels (standard exposure, underexposure, and then overexposure) each time you shoot. You can adjust the amount of underexposure and overexposure (relative to standard exposure) from -2 to +2 stops in 1/3-stop increments.

1 Access the setting screen.

- Press the [MENU] button, choose [AEB] on the [C4] tab, and then press the [ZOOM] button (book 35).

2 Configure the setting.

- Press the [LEFT] [RIGHT] buttons or turn the [ZOOM] dial to adjust the setting.
- To cancel AEB, follow steps 1 – 2 to set the AEB correction value to 0.

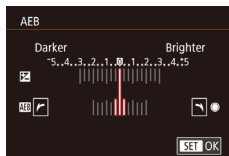

- AEB is not available when the flash setting is other than [Flash On], when Multi Shot Noise Reduction is on (book 88), or during continuous or bulb shooting.



- If exposure compensation is already in use (book 69), the value specified for that function is treated as the standard exposure level for this function. You can also adjust exposure compensation by turning the exposure compensation dial in step 2.

Before Use

Basic Guide

Advanced Guide

Camera Basics

Auto Mode /
Hybrid Auto Mode

Other Shooting Modes

P Mode

Tv, Av, M, C1, and C2 Mode

Playback Mode

Wireless Features

Setting Menu

Accessories

Appendix

Index



Auto Correction of Brightness and Contrast (Auto Lighting Optimizer)

▶ Still Images ▶ Movies

Correct brightness and contrast automatically to avoid images that are too dark or lack contrast.

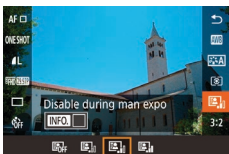

- Press the **[INFO]** button, choose **[D+]** in the menu, and choose the desired option (📖34).



- This feature may increase noise under some shooting conditions.
- When the effect of Auto Lighting Optimizer is too strong and images become too bright, set it to [Low] or [Disable].
- Under settings other than [Disable], images may be bright and AEB-based exposure compensation may have little effect, even if you reduce exposure in exposure compensation or flash exposure compensation settings. For shots at your specified brightness, set this feature to [Disable].



- You can also configure this setting by choosing MENU (📖35) > **[D+]** tab > [Auto Lighting Optimizer].

Shooting Bright Subjects (Highlight Tone Priority)

▶ Still Images ▶ Movies

Improve gradation in bright image areas to avoid loss of detail in subject highlights.

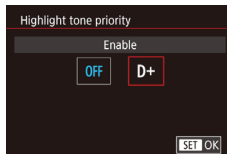

- Press the **[MENU]** button, choose [Highlight tone priority] on the **[D+]** tab, and then choose [D+] (📖35).



- With [D+], ISO speeds lower than 200 are not available. Auto Lighting Optimizer is also disabled, in this case.

Before Use

Basic Guide

Advanced Guide

Camera Basics

Auto Mode /
Hybrid Auto Mode

Other Shooting Modes

P Mode

Tv, Av, M, C1, and C2 Mode

Playback Mode

Wireless Features

Setting Menu

Accessories

Appendix

Index



Image Colors

Adjusting White Balance

▶ Still Images ▶ Movies

By adjusting white balance (WB), you can make image colors look more natural for the scene you are shooting.



- Press the **[WB]** button, choose **[WB]** in the menu, and choose the desired option (834).
- The option you configured is now displayed.

[WB] Auto	Automatically sets the optimal white balance for the shooting conditions.
[Day Light] Day Light	For shooting outdoors in fair weather.
[Shade] Shade	For shooting in the shade.
[Cloudy] Cloudy	For shooting in cloudy weather or at dusk.
[Tungsten light] Tungsten light	For shooting under ordinary incandescent lighting.
[White fluorescent light] White fluorescent light	For shooting under white fluorescent lighting.
[Flash] Flash	For shooting with the flash.
[Custom] Custom	For manually setting a custom white balance.
[K] Color temp.	For manually setting a white balance color temperature.

Custom White Balance

For image colors that look natural under the light in your shot, adjust white balance to suit the light source where you are shooting. Set the white balance under the same light source that will illuminate your shot.

1 Shoot a white object.

- Aim the camera at a sheet of paper or other plain white subject, so that white fills the screen.
- Focus manually and shoot (81).

2 Choose [Custom WB].

- Choose [Custom WB] on the **[CAMERA]** tab, and then press the **[WB]** button.
- The custom white balance selection screen will appear.

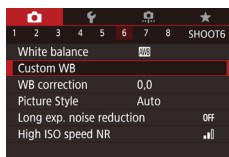

3 Load the white data.

- Select your image from step 1, and then press **[WB]**.
- On the confirmation screen, press the **[OK]** button or turn the **[DIAL]** to choose [OK], and then press the **[WB]** button.
- Press the **[MENU]** button to close the menu.



4 Choose [OK].

- Follow the steps in "Adjusting White Balance" (873) to choose **[OK]**.



Before Use

Basic Guide

Advanced Guide

Camera Basics

Auto Mode /
Hybrid Auto Mode

Other Shooting Modes

P Mode

Tv, Av, M, C1, and C2 Mode

Playback Mode

Wireless Features

Setting Menu

Accessories

Appendix

Index





- Shots in step 1 that are too bright or dark may prevent you from setting the white balance correctly.
- A message is displayed if you specify an image in step 3 that is not suitable for loading white data. Choose [Cancel] to choose a different image. Choose [OK] to use that image for loading white data, but note that it may not produce a suitable white balance.
- If [Unselectable image.] is displayed in step 3, choose [OK] to clear the message and specify another image.
- If [Set WB to “”] is displayed in step 3, press the button to return to the menu screen, and then choose .



- Instead of a white object, a gray chart or 18% gray reflector (commercially available) can produce a more accurate white balance.
- The current white balance and related settings are disregarded when you shoot in step 1.

Manually Correcting White Balance

▶ Still Images ▶ Movies

You can manually correct white balance. This adjustment can match the effect of using a commercially available color temperature conversion filter or color-compensating filter.



1 Configure the setting.

- Follow the steps in “Adjusting White Balance” (73) to choose the white balance option.
- Turn the dial to adjust the correction level for B and A.



2 Configure advanced settings.

- To configure more advanced settings, press the [INFO.] button and turn the or dial to adjust the correction level.
- To reset the correction level, press the button.
- Press the button to complete the setting.



- Any correction level you set is retained even if you change the white balance option in step 1.



- B: blue; A: amber; M: magenta; G: green
- One level of blue/amber correction is equivalent to about 5 mireds on a color temperature conversion filter. (Mired: Color temperature unit representing color temperature conversion filter density)
- You can also configure this setting by choosing MENU (35) > [G] tab > [WB correction].



- You can also choose the correction level by touching or dragging the bar in step 1 or the frame in step 2.
- You can also access the screen in step 2 by touching [INFO.] in step 1.

Before Use

Basic Guide

Advanced Guide

Camera Basics

Auto Mode / Hybrid Auto Mode

Other Shooting Modes

P Mode

Tv, Av, M, C1, and C2 Mode

Playback Mode

Wireless Features

Setting Menu

Accessories

Appendix

Index



Manually Setting White Balance Color Temperature

► Still Images ► Movies

A value can be set representing the white balance color temperature.



- Follow the steps in “Adjusting White Balance” (📖73) to choose [K].
- Press the [WB] button, and then adjust the setting by pressing the [◀][▶] buttons or turning the [WB] dial.



- Color temperature can be set at 100 K increments in a range of 2,500 – 10,000 K.

Customizing Colors (Picture Style)

► Still Images ► Movies

Choose a Picture Style with color settings that express moods or subjects well. Eight Picture Styles are available, and each can be further customized.



- Press the [PS] button, choose [PS-A] in the menu, and choose the desired option (📖34).

Auto	The color tone will be adjusted automatically to suit the scene. The colors will look vivid, especially for blue skies, greenery, and sunsets in nature, outdoor, and sunset scenes.
Standard	The image looks vivid, sharp, and crisp. Suitable for most scenes.

Portrait	For smooth skin tones. The image looks softer. Suited for close-up portraits. To modify skin tones, adjust [Color tone] (📖76).
Landscape	For vivid blues and greens, and very sharp and crisp images. Effective for impressive landscapes.
Fine Detail	For detailed rendering of fine subject contours and subtle textures. Makes images slightly more vivid.
Neutral	For retouching later on a computer. Makes images subdued, with lower contrast and natural color tones.
Faithful	For retouching later on a computer. Faithfully reproduces the actual colors of subjects as measured under ambient light with a color temperature of 5200K. Vivid colors are suppressed for a subdued look.
Monochrome	Creates black and white images.
User Def.	Add a new style based on presets such as [Portrait] or [Landscape] or a Picture Style file, and then adjust it as needed.



- Default [Auto] settings are used for [PS-1], [PS-2], and [PS-3] until you add a Picture Style.
- You can also configure this setting by accessing MENU (📖35) > [CAMERA] tab > [Picture Style].

Before Use

Basic Guide

Advanced Guide

Camera Basics

Auto Mode / Hybrid Auto Mode

Other Shooting Modes

P Mode

Tv, Av, M, C1, and C2 Mode

Playback Mode

Wireless Features

Setting Menu

Accessories

Appendix

Index



Customizing Picture Styles

Customize these Picture Style settings as needed.

Sharpness	Strength	Adjust the level of edge enhancement. Choose lower values to soften (blur) subjects, or higher values to sharpen them.
	Fineness	Indicates the edge thinness that enhancement applies to. Choose lower values for more enhanced details.
	Threshold	Contrast threshold between edges and surrounding image areas, which determines edge enhancement. Choose lower values to enhance edges that do not stand out much from surrounding areas. Note that with lower values, noise may also be emphasized.
Contrast		Adjust the contrast. Choose lower values to decrease the contrast, or higher values to increase it.
Saturation* ¹		Adjust the intensity of colors. Choose lower values to make colors faded, or higher values to make them deeper.
Color tone* ¹		Adjust skin color tone. Choose lower values to produce redder hues, or higher values to produce yellower hues.

Filter effect* ²	Emphasize white clouds in monochrome images, the green of trees, or other colors. N: Normal black-and-white image with no filter effects. Ye: The blue sky will look more natural, and the white clouds will look crisper. Or: The blue sky will look slightly darker. The sunset will look more brilliant. R: The blue sky will look quite dark. Fall leaves will look crisper and brighter. G: Skin tones and lips will appear muted. Green tree leaves will look crisper and brighter.
Toning effect* ²	Choose from the following monochrome hues: [N:None], [S:Sepia], [B:Blue], [P:Purple], or [G:Green].

*¹ Not available with .

*² Only available with .



- In [Sharpness], [Fineness] and [Threshold] settings are not applied to movies.

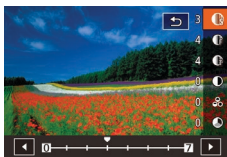

1 Access the setting screen.

- Choose a Picture Style as described in “Customizing Colors (Picture Style)” (p.75).
- Press the **[INFO]** button.

2 Configure the setting.

- Press the **[▲]**/**[▼]** buttons to choose an item, and then choose an option by pressing the **[◀]**/**[▶]** buttons or turning the **[Globe]**/**[Sun]** dials.
- To undo any changes, press the **[INFO]** button.
- When finished, press the **[OK]** button.

Before Use

Basic Guide

Advanced Guide

Camera Basics

Auto Mode /
Hybrid Auto Mode

Other Shooting Modes

P Mode

Tv, Av, M, C1, and C2 Mode

Playback Mode

Wireless Features

Setting Menu

Accessories

Appendix

Index





- [Filter effect] results are more noticeable with higher [Contrast] values.

Saving Customized Picture Styles

Save presets (such as [P] or [L]) that you have customized as new styles. You can create several Picture Styles with different settings for parameters such as sharpness or contrast.



1 Select a user-defined style number.

- Choose [P1], [P2], or [P3] as described in “Customizing Colors (Picture Style)” (p.75).

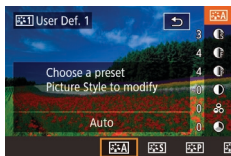

2 Select a style to modify.

- Press the [INFO] button.
- Press the [Left][Right] buttons or turn the [Left][Right] dials to choose the Picture Style that serves as the basis.

3 Customize the style.

- Press the [Up][Down] buttons to choose an item to modify, and then customize it, either by pressing the [Left][Right] buttons or turning the [Left][Right] dials.
- When finished, press the [OK] button.



- You can also choose styles in step 2 that you have added to the camera using EOS Utility (p.176).
- Download software instruction manuals from the Canon website as needed. For downloading instructions, see “Software Instruction Manual” (p.176).

Focusing

Choosing the AF Method

▶ Still Images ▶ Movies

Choose a method of auto focusing (AF) for the subject and scene you are shooting.



- Press the [OK] button, choose [AF-C] in the menu, and choose the desired option (p.34).



- Focusing may take longer or be incorrect when subjects are dark or lack contrast, in very bright conditions, or with some EF or EF-S lenses. For lens details, visit the Canon website.



- You can also configure this setting by accessing MENU (p.35) > [CAMERA] tab > [AF method].

Before Use

Basic Guide

Advanced Guide

Camera Basics

Auto Mode / Hybrid Auto Mode

Other Shooting Modes

P Mode

Tv, Av, M, C1, and C2 Mode

Playback Mode

Wireless Features

Setting Menu

Accessories

Appendix

Index



1-point AF

- The camera focuses using a single AF frame. Effective for reliable focusing.
- Frames turn green after you press the shutter button halfway and the camera focuses.



- Move the frame as needed (📖79). To compose shots with subjects on the edge or in a corner without moving the frame, first aim the camera to bring the subject into an AF frame, and then hold the shutter button halfway down. Keep the shutter button halfway down as you recompose the shot, and then press the shutter button all the way down (Focus Lock).
- To magnify the position of the AF frame, follow steps 2 – 4 in “Shooting in Manual Focus Mode” (📖81). Note that Touch Shutter is not available at this time.
- To reduce the frame size, choose MENU (📖35) > [📷3] tab > [AF Frame Size] > [Small]. Note that Servo AF (📖80) and Continuous AF (📖80) are not available at this time.

👤+Tracking

- After you aim the camera at the subject, a white frame is displayed around the face of the main subject as determined by the camera. You can also choose subjects yourself (📖79).
- When the camera detects movement, frames will follow moving subjects, within a certain range.
- Frames turn green after you press the shutter button halfway and the camera focuses.
- When no faces are detected, pressing the shutter button halfway displays green frames around other areas in focus.



- Examples of faces that cannot be detected:
 - Subjects that are distant or extremely close
 - Subjects that are dark or light
 - Faces in profile, at an angle, or partly hidden
- The camera may misinterpret non-human subjects as faces.
- An orange frame is displayed with [👤] if the camera cannot focus on subjects when you press the shutter button halfway.
- Focusing is not possible on faces detected at the edge of the screen (which are displayed with gray frames), even when you press the shutter button halfway.

Smooth Zone AF

- The camera focuses within your designated area. Effective when the subject is hard to capture with 👤+ Tracking or 1-point AF, because you can specify where to focus. The camera will focus within the white frame displayed. You can move the white frame by dragging it or touching the screen.
- When you press the shutter button halfway, up to nine green frames are displayed around positions in focus within the white frame.



- An orange frame is displayed with [👤] if the camera cannot focus on subjects when you press the shutter button halfway.



- The frame size varies depending on IS Mode and Auto Level settings.
- Blue frames are displayed around positions in focus when you select MENU (📖35) > [📷3] tab > [AF operation] > [Servo AF].

Before Use

Basic Guide

Advanced Guide

Camera Basics

Auto Mode / Hybrid Auto Mode

Other Shooting Modes

P Mode

Tv, Av, M, C1, and C2 Mode

Playback Mode

Wireless Features

Setting Menu

Accessories

Appendix

Index



Choosing Subjects to Focus On (Touch AF)

► Still Images ► Movies

You can shoot after the camera focuses on your selected subject, person's face, or location shown on the screen.



1 Choose a subject, a person's face, or a location to focus on.

- Touch the subject or person on the screen.
- When the AF method is set to [AF], an AF frame is displayed where you touched.
- When the AF method is set to [AF-L], [AF-L] is displayed once a face is detected, and focus is maintained even if the subject moves. To cancel Touch AF, touch [L].



2 Shoot.

- Press the shutter button halfway. After the camera focuses, [L] is displayed in green.
- Press the shutter button all the way down to shoot.



- If the camera shoots when you touch the screen, choose MENU (M) > [2] tab > [Touch Shutter], and then set [Touch Shutter] to [Disable].
- Tracking may not be possible when subjects are too small or move too rapidly, or when there is inadequate contrast between subjects and the background.



- You can also switch faces and move the AF frame, by pressing the [AF] button.
 - To move the frame when AF method is set to [AF], after pressing the [AF] button, press the [▲][▼][◀][▶] buttons. Press the [L] button to return to the shooting screen. To center the frame again, on the shooting screen or frame adjustment screen, hold down the [AF] button for at least two seconds.
 - When the AF method is set to [AF-L], press the [AF] button to display [Face Select : On]. A face frame [] is displayed around the face detected as the main subject. Press the [AF] button again to switch the face frame [] to another detected face. Once you cycle through all detected faces, [Face Select : Off] is displayed and Face Select is canceled.
- To keep the frame in the same position (where you touched) after shooting when [Touch Shutter] is set to [Enable] (M46), choose MENU (M35) > [2] tab > [Touch Shutter] > [AF frame pos'n] > [Touch point].

Shooting with the AF Lock

► Still Images ► Movies

The focus can be locked. After you lock the focus, the focal position will not change even when you release your finger from the shutter button.

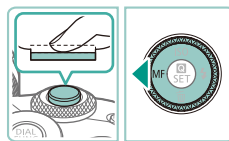

1 Lock the focus.

- With the shutter button pressed halfway, press the [L] button.
- The focus is now locked, and [MF] is displayed.
- To unlock the focus, release the shutter button and press the [L] button again. In this case, [MF] is no longer displayed.

2 Compose the shot and shoot.

Before Use

Basic Guide

Advanced Guide

Camera Basics

Auto Mode / Hybrid Auto Mode

Other Shooting Modes

P Mode

Tv, Av, M, C1, and C2 Mode

Playback Mode

Wireless Features

Setting Menu

Accessories

Appendix

Index



Shooting with Servo AF

▶ Still Images ▶ Movies

This mode helps avoid missing shots of subjects in motion, because the camera continues to focus on the subject and adjust the exposure as long as you press the shutter button halfway.

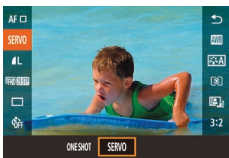

1 Configure the setting.

- Press the **[MENU]** button, choose [ONE SHOT] in the menu, and then choose [SERVO] (📖34).



2 Focus.

- The focus and exposure are maintained where the blue AF frame is displayed while you are pressing the shutter button halfway.



- The camera may not be able to shoot while focusing, even if you press the shutter button all the way down. Keep holding down the shutter button as you follow the subject.
- An orange AF frame is displayed when the camera cannot focus on subjects.
- Using the self-timer (📖44) will restrict the AF mode to [ONE SHOT].
- Choosing MENU (📖35) > **[CAMERA]** tab > [AF Frame Size] > [Small] will restrict the mode to [ONE SHOT].



- Exposure is not locked in Servo AF mode when you press the shutter button halfway but is determined the moment you shoot, regardless of the metering mode (📖70) setting.
- Continuous shooting (📖46) with auto focus is possible by specifying Servo AF. Note that continuous shooting is slower at this time. Also note that focus may be lost if you zoom in or out during continuous shooting.
- Depending on the lens used, the distance to the subject and the subject's speed, the camera may not be able to achieve correct focus.
- You can also configure this setting by accessing MENU (📖35) > **[CAMERA]** tab > [AF operation].

Changing the Focus Setting

▶ Still Images ▶ Movies

You can change default camera operation of constantly focusing on subjects it is aimed at, even when the shutter button is not pressed. Instead, you can limit camera focusing to the moment you press the shutter button halfway.

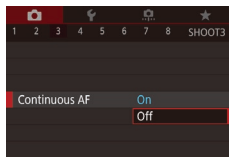

- Press the **[MENU]** button, choose [Continuous AF] on the **[CAMERA]** tab, and then choose [Off] (📖35).

On	Helps avoid missing sudden photo opportunities, because the camera constantly focuses on subjects until you press the shutter button halfway.
Off	Conserves battery power, because the camera does not focus constantly. However, this may delay focusing.



- Choosing MENU (📖35) > **[CAMERA]** tab > [AF Frame Size] > [Small] will restrict the mode to [Off].

Before Use

Basic Guide

Advanced Guide

Camera Basics

Auto Mode /
Hybrid Auto Mode

Other Shooting Modes

P Mode

Tv, Av, M, C1, and C2 Mode

Playback Mode

Wireless Features

Setting Menu

Accessories

Appendix

Index



Fine-Tuning the Focus

▶ Still Images ▶ Movies

Fine-tune autofocusing with an EF-M lens attached by turning the focusing ring.

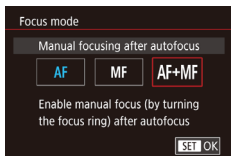

1 Configure the setting.

- Press the [MENU] button, choose [Focus mode] on the [3] tab, and then choose [AF+MF] (80).

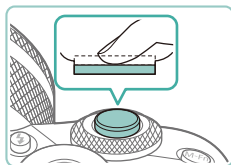

2 Focus.

- Press the shutter button halfway to focus on the subject, and continue holding the button halfway down.

3 Fine-tune the focus.

- Turn the focusing ring on the lens to adjust the focus.
- [MF] blinks on the screen.
- To cancel focusing, release the shutter button.

4 Shoot.

- Press the shutter button all the way down to shoot.



- Cannot be used with Servo AF (80).
- Not available with lenses other than EF-M lenses.

Shooting in Manual Focus Mode

▶ Still Images ▶ Movies

When focusing is not possible in AF mode, use manual focus. To make focusing easier, magnify the display.

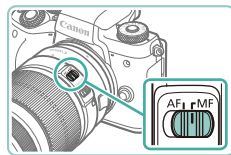

1 Choose [MF].

- EF-M lenses: Press the [◀] button.
- Other lenses: Turn off the camera, set the lens switch to [MF], and then turn the camera on again.
- [MF] is displayed.

2 Display the magnifying frame.

- Press the [M+] button.
- The magnifying frame is displayed, centered on the screen.

3 Select the area to magnify.

- Press the [▲][▼][◀][▶] buttons to move the frame to an area to magnify.
- To center the frame again, press the [INFO] button.



4 Activate magnification.

- Turn the [M] dial to switch the magnification between 1x (no magnification), 5x, and 10x.

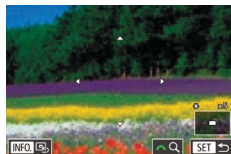

Before Use

Basic Guide

Advanced Guide

Camera Basics

Auto Mode / Hybrid Auto Mode

Other Shooting Modes

P Mode

Tv, Av, M, C1, and C2 Mode

Playback Mode

Wireless Features

Setting Menu

Accessories

Appendix

Index



5 Focus.

- While looking at the magnified image, turn the lens focusing ring to focus.

6 Shoot.



- You can also move the magnifying frame in step 3 by dragging it.
- By touching [Q] in the lower right, you can also adjust the magnification ratio and drag to move the area magnified.

Easily Identifying the Focus Area (MF Peaking)

▶ Still Images ▶ Movies

Edges of subjects in focus are displayed in color to make manual focusing easier. You can adjust the colors and the sensitivity (level) of edge detection as needed.

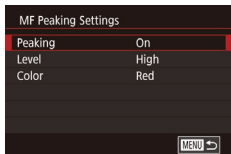

1 Access the setting screen.

- Press the [MENU] button, choose [MF Peaking Settings] on the [Q4] tab, and then set [Peaking] to [On] (📖35).

2 Configure the setting.

- Choose a menu item to configure, and then choose the desired option (📖35).



- Colors displayed for MF peaking are not recorded in your shots.

Flash

Changing the Flash Mode

▶ Still Images ▶ Movies

You can change the flash mode to match the shooting scene. For details on the flash range, see “Flash” (📖213).

1 Raise the flash.

- Press the [L] button.

2 Configure the setting.

- Press the [▶] button, choose a flash mode (either press the [◀][▶] buttons or turn the [DIAL] dial), and then press the [OK] button.
- The option you configured is now displayed.

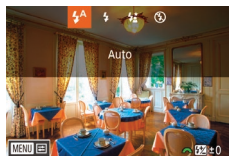

- The setting screen cannot be accessed by pressing the [▶] button when the flash is lowered. Press the [L] button to raise the flash, then configure the setting.
- If the flash fires, vignetting may occur. Vignetting or dark image areas may also occur, if the flash fires, depending on the lens.



- When there is a risk of overexposure, the camera automatically adjusts the shutter speed or ISO speed for flash shots to reduce washed-out highlights and shoot at optimal exposure. Thus, shutter speeds and ISO speeds displayed when you press the shutter button halfway may not match the settings in flash shots.
- You can also configure this setting by choosing MENU (📖35) > [Q5] tab > [Flash Control] > [Flash firing].

Before Use

Basic Guide

Advanced Guide

Camera Basics

Auto Mode /
Hybrid Auto Mode

Other Shooting Modes

P Mode

Tv, Av, M, C1, and C2 Mode

Playback Mode

Wireless Features

Setting Menu

Accessories

Appendix

Index



Auto

Fires automatically in low-light conditions.

On

Fires for each shot.

Slow Synchro

Fires to illuminate the main subject (such as people) while shooting at a slower shutter speed to illuminate backgrounds out of flash range.



- In [A] mode, mount the camera on a tripod or take other measures to keep it still and prevent camera shake. In this case, also disable image stabilization (86).
- In [A] mode, even after the flash fires, ensure that the main subject does not move until the shutter sound is finished playing.

Off

For shooting without the flash.

Adjusting the Flash Exposure Compensation

▶ Still Images ▶ Movies

Just as with regular exposure compensation (69), you can adjust the flash exposure from -2 to +2 stops, in 1/3-stop increments.

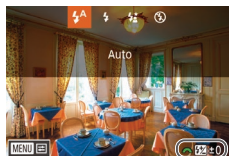

- Raise the flash, press the [▶] button and immediately turn the [] dial to choose the compensation level, and then press the [] button.
- The correction level you specified is now displayed.



- When there is a risk of overexposure, the camera automatically adjusts the shutter speed or aperture value for flash shots to reduce washed-out highlights and shoot at optimal exposure. However, you can deactivate automatic adjustment of the shutter speed and aperture value by accessing MENU (35) and choosing [5] tab > [Flash Control] > [Safety FE] > [Disable].
- You can also configure the flash exposure compensation by accessing MENU (35) and choosing [5] tab > [Flash Control] > [Built-in flash settings] > [exp. comp.].
- You can also access the [Flash Control] screen (35) as follows.
 - Press and hold the [▶] button for at least one second.
 - When the flash is up, press the [▶] button and immediately press the [MENU] button.



- You can also access the [Flash Control] screen (35) by pressing the [▶] button and touching [MENU].

Before Use

Basic Guide

Advanced Guide

Camera Basics

Auto Mode /
Hybrid Auto Mode

Other Shooting Modes

P Mode

Tv, Av, M, C1, and C2 Mode

Playback Mode

Wireless Features

Setting Menu

Accessories

Appendix

Index



Shooting with the FE Lock

► Still Images ► Movies

Just as with the AE lock (📖70), you can lock the exposure for flash shots.

1 Raise the flash and set it to [📷] (📖82).

2 Lock the flash exposure.

- Aim the camera at the subject to shoot with the exposure locked, and then press the [✖] button.
- The flash fires, and when [📷] is displayed, the flash output level is retained.
- To unlock FE, press the [✖] button again. [📷] is no longer displayed.

3 Compose the shot and shoot.



- FE: Flash Exposure
- The metering range is shown by a circle in the center of the screen when FE is locked.
- [📷] blinks when standard exposure is not possible (even if the flash fires in step 2). Follow step 2 when subjects are within range for flash shots.

Changing the Flash Timing

► Still Images ► Movies

Change the timing of the flash and shutter release as follows.

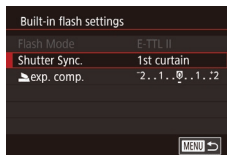

1st curtain	The flash fires immediately after the shutter opens.
2nd curtain	The flash fires immediately before the shutter closes.

- Press the [MENU] button, choose [Flash Control] on the [📷5] tab, and then choose [Built-in flash settings].
- Choose [Shutter Sync.], and then choose the desired option (📖35).



- [1st curtain] is used whenever the shutter speed is 1/100 or faster, even if you select [2nd curtain].

Changing the Flash Metering Mode

► Still Images ► Movies

[Evaluative] flash metering, which enables standard flash exposure, can be changed to average flash metering across the metering area, as when using an externally metered flash.

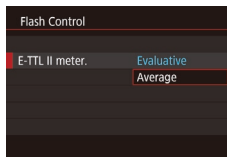

- Press the [MENU] button and choose [Flash Control] on the [📷5] tab. Choose [E-TTL II meter.] and then [Average].



- When using [Average], adjust flash exposure compensation to suit the shooting conditions.

Before Use

Basic Guide

Advanced Guide

Camera Basics

Auto Mode /
Hybrid Auto Mode

Other Shooting Modes

P Mode

Tv, Av, M, C1, and C2 Mode

Playback Mode

Wireless Features

Setting Menu

Accessories

Appendix

Index



Resetting Flash Settings

▶ Still Images ▶ Movies

Reset [Built-in flash settings] to the default values.

- Press the [MENU] button, choose [Flash Control] on the [5] tab, and then choose [Clear settings].
- Choose [Clear built-in flash set.], press the [OK] button, choose [OK] on the next screen (either press the [◀][▶] buttons or turn the [Q] dial), and then press the [OK] button.

Other Settings

Switching to Other Functions to Adjust with the Quick Control Dial

▶ Still Images ▶ Movies

You can switch between functions that can be adjusted with the [Q] dial by pressing the [Q] button repeatedly.

1 Choose a function.

- Press the [Q] button.
- The icon (1) of the function adjustable with the [Q] dial is displayed.



(1)



2 Set the desired item.

- Turn the [Q] dial to set the desired item while the function icon is displayed.
- After you set the desired item, the camera will revert to the default function adjusted with the Quick Control Dial.



- The camera will revert to the default function adjusted with the [Q] button after some time, even if no items are set.

Before Use

Basic Guide

Advanced Guide

Camera Basics

Auto Mode /
Hybrid Auto Mode

Other Shooting Modes

P Mode

Tv, Av, M, C1, and C2 Mode

Playback Mode

Wireless Features

Setting Menu

Accessories

Appendix

Index





- Functions you can switch to by pressing the button can be modified as described in “Assigning Functions to the Quick Control Dial” (p.98).
- This function is not available in or modes.
- Functions available while shooting movies in mode are **[Av]**, **[Tv]**, and **[ISO]**.

Changing the IS Mode Settings

▶ Still Images ▶ Movies

Configure image stabilization via the camera menu when using an EF-M lens with image stabilization.

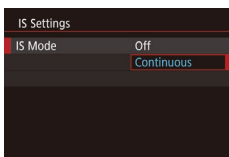

1 Access the setting screen.

- Press the **[MENU]** button, choose [IS Settings] on the tab, and then press the button (p.35).

2 Configure the setting.

- Choose [IS Mode], and then choose the desired option (p.35).

Continuous	Corrects camera movement or camera shake using built-in image stabilization performed by the lens.
Off	Deactivates image stabilization.



- If image stabilization cannot prevent camera shake, mount the camera on a tripod or take other measures to hold it still. In this case, set [IS Mode] to [Off].
- [IS Mode] is not displayed for lenses other than EF-M lenses. Use the image stabilization switch on the lens instead (p.26).



- Lenses with built-in image stabilization are named with “IS”. IS stands for Image Stabilizer.

Correcting Camera Shake when Shooting Movies

▶ Still Images ▶ Movies

In-camera image stabilization corrects camera shake when you shoot movies. Camera shake can be corrected even without a lens that is equipped with image stabilization.

Even more effective correction is possible by using a lens that supports Combination IS, which combines lens image stabilization with in-camera Digital IS.

For details on lenses compatible with Combination IS, visit the Canon website.

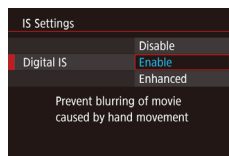

- Follow step 1 in “Changing the IS Mode Settings” (p.86) to access the [IS Settings] screen.
- Choose [Digital IS], and then choose the desired option (p.35).

Enable	(When using lens supporting Combination IS)	Corrects camera shake when shooting movies. The image display area narrows and subjects are slightly enlarged.
Enhanced	(When using lens supporting Combination IS)	Corrects strong camera shake when shooting movies. Subjects are further enlarged.
Disable	OFF	—



- Try taking some test shots first to check the effect with the lens you are using.
- [Enhanced] is only available in and modes.
- When you set [Digital IS] to [Enable] or [Enhanced], [Auto level] is set to [Disable] and cannot be changed.

Before Use

Basic Guide

Advanced Guide

Camera Basics

Auto Mode / Hybrid Auto Mode

Other Shooting Modes

P Mode

Tv, Av, M, C1, and C2 Mode

Playback Mode

Wireless Features

Setting Menu

Accessories

Appendix

Index



Correcting Lens Aberrations

▶ Still Images ▶ Movies

Correct vignetting and subject color fringing due to lens characteristics, or lack of image sharpness due to aperture.

Note that when [Correction data not available] is displayed on the setting screen, correction data has not been added to the camera. See “Lens Correction Data” (📖87) for details on adding correction data.

1 Choose [Lens aberration correction].

- Press the [MENU] button, choose [Lens aberration correction] on the [📷4] tab, and then choose an item (📖35).

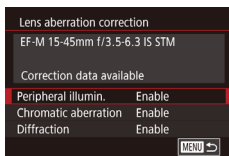

2 Confirm that correction data is available.

- Make sure [Correction data available] is displayed under the lens name.

3 Apply correction.

- Choose an item and press the [📷] button to apply the setting (📖35).



- Noise may occur around the edges of images shot under some conditions if you set [Peripheral illumin.] to [Enable].
- When setting [Diffraction] to [Enable], keep the following points in mind.
 - When correcting lens aberration, this feature may also make noise more noticeable, under some shooting conditions.
 - The higher the ISO speed, the lower the amount of correction will be.
 - Correction is not applied to movies.



- The effect of peripheral illumination correction is slightly less than that of maximum correction in Digital Photo Professional.
- The higher the ISO speed, the lower the amount of peripheral illumination correction will be.
- [Diffraction] corrects loss of sharpness not only from diffraction but also from the low-pass filter and other factors. Thus, correction is also effective for exposures with the aperture wide open.
- Download software instruction manuals from the Canon website as needed. For downloading instructions, see “Software Instruction Manual” (📖176).

Lens Correction Data

Lens correction data for lenses compatible with this feature is registered (stored) on the camera. Set [Peripheral illumin.] and [Chromatic aberration] to [Enable] for automatic correction.

Using EOS Utility, you can check which lenses have correction data registered on the camera. You can also register correction data for lenses that have not been registered yet. For details, refer to the EOS Utility instruction manual (📖176).

* Note that there is no need to register information for EF-M lenses, or for EF lenses that incorporate their own correction data.



- Existing JPEG images cannot be corrected.
- Effects of peripheral illumination correction and chromatic aberration correction are not displayed when shooting with a magnified view. Similarly, the effect of diffraction correction is not displayed at the time of shooting.
- The amount of correction (except diffraction correction) is less for lenses that do not provide distance information.

Before Use

Basic Guide

Advanced Guide

Camera Basics

Auto Mode /
Hybrid Auto Mode

Other Shooting Modes

P Mode

Tv, Av, M, C1, and C2 Mode

Playback Mode

Wireless Features

Setting Menu

Accessories

Appendix

Index





- Effects of lens aberration correction vary by lens and shooting conditions. With some lenses and under some shooting conditions, effects may be less noticeable.
- If effects of correction are hard to see, magnify the image and check again.
- Results of shooting without registering correction data for the lens on the camera are the same as shooting with [Peripheral illumin.] and [Chromatic aberration] set to [Disable].

Changing the Noise Reduction Level

▶ Still Images ▶ Movies

You can choose from 3 levels of noise reduction: [Standard], [High], [Low]. This function is especially effective when shooting at high ISO speeds.

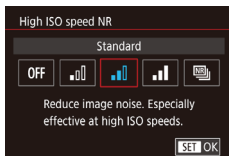

- Press the [MENU] button, choose [High ISO speed NR] on the [CAMERA] tab, and then choose the desired option (📖35).

Using Multi Shot Noise Reduction

Automatically combine four images captured at once for noise reduction superior to the [High] option in [High ISO speed NR].

1 Choose [NR].

- Follow the steps in “Changing the Noise Reduction Level” (📖88) to choose [NR].

2 Shoot.

- Hold the camera steady as you shoot. When you press the shutter button all the way down, the camera will take four shots and combine them.



- Unexpected results may occur if images are quite misaligned (from camera shake, for example). Mount the camera on a tripod or take other measures to keep it still, if possible.
- If you shoot a moving subject, the subject’s movement may leave afterimages or the surrounding area of the subject may become dark.
- Depending on shooting conditions, noise may appear on the image periphery.
- Not available with AEB or [Long exp. noise reduction], or when shooting RAW images or bulb exposures. Setting up these features will prevent you from using [Multi Shot Noise Reduction].
- Flash shooting is not possible.
- Recording the image to the card will take longer than with normal shooting. You cannot take another shot until processing is finished.

Before Use

Basic Guide

Advanced Guide

Camera Basics

Auto Mode / Hybrid Auto Mode

Other Shooting Modes

P Mode

Tv, Av, M, C1, and C2 Mode

Playback Mode

Wireless Features

Setting Menu

Accessories

Appendix

Index



Reducing Noise at Slow Shutter Speeds

▶ Still Images ▶ Movies

Reduce noise from long exposures at shutter speeds of one second or slower.

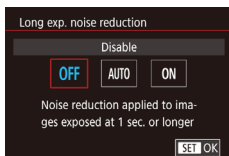

- Press the [MENU] button, choose [Long exp. noise reduction] on the [CAMERA] tab, and then choose an option (see page 35).

OFF	Disables noise reduction for long exposures.
AUTO	Applies noise reduction if the noise that tends to occur in long exposures at shutter speeds of one second or slower is detected.
ON	Always applies noise reduction at shutter speeds of one second or slower.



- There may be a delay before you can shoot again, as the camera reduces noise in images.
- Images shot at speeds of ISO 1600 or higher may be grainier with this option set to [ON] than at [OFF] or [AUTO].

Before Use

Basic Guide

Advanced Guide

Camera Basics

Auto Mode /
Hybrid Auto Mode

Other Shooting Modes

P Mode

Tv, Av, M, C1, and C2 Mode

Playback Mode

Wireless Features

Setting Menu

Accessories

Appendix

Index



Tv, Av, M, C1, and C2 Mode

Take smarter, more sophisticated shots, and customize the camera for your shooting style



- Instructions in this chapter apply to the camera as set to the respective mode.

Specific Shutter Speeds ([Tv] Mode)

► Still Images ► Movies

Set your preferred shutter speed before shooting as follows. The camera automatically adjusts the aperture value to suit your shutter speed. For details on available shutter speeds, see “Shutter” (📖213).



1 Enter [Tv] mode.

- Hold down the mode dial release button and turn the mode dial to [Tv].

2 Set the shutter speed.

- Turn the  dial to set the shutter speed.



- There may be a delay before you can shoot again when [Long exp. noise reduction] is set to [ON] or [AUTO] and the shutter speed is 1 second or slower, because images are processed to remove noise.
- We recommend deactivating image stabilization when shooting at slow shutter speeds on a tripod (📖86).
- Maximum shutter speed with the flash is 1/200 second. If you specify a faster speed, the camera will automatically reset the speed to 1/200 second before shooting.
- Orange display of the aperture value when you press the shutter button halfway indicates that the standard exposure has not been obtained. Adjust the shutter speed until the aperture value is displayed in white, or use safety shift (📖96).



- [Tv]: Time value

Before Use

Basic Guide

Advanced Guide

Camera Basics

Auto Mode / Hybrid Auto Mode

Other Shooting Modes

P Mode

Tv, Av, M, C1, and C2 Mode

Playback Mode

Wireless Features

Setting Menu

Accessories

Appendix

Index



Specific Aperture Values ([Av] Mode)

▶ Still Images ▶ Movies

Set your preferred aperture value before shooting as follows. The camera automatically adjusts the shutter speed to suit your aperture value. Available aperture values vary by lens.



1 Enter [Av] mode.

- Hold down the mode dial release button and turn the mode dial to [Av].

2 Set the aperture value.

- Turn the [Aperture] dial to set the aperture value.



- Orange display of the shutter speed when you press the shutter button halfway indicates that the standard exposure has not been obtained. Adjust the aperture value until the shutter speed is displayed in white, or use safety shift ([96]).
- Maximum shutter speed with the flash is 1/200 second. To avoid exceeding 1/200 second in flash shots, the camera may adjust the aperture value.



- [Av]: Aperture value (size of the opening made by the diaphragm in the lens)

Depth-of-Field Preview

The aperture changes only at the moment you shoot, and it remains open at other times. For this reason, the depth of field shown on the screen looks narrow, or shallow. To check the area in focus, assign [Depth-of-field preview] to a button ([97]) and press it.

Before Use

Basic Guide

Advanced Guide

Camera Basics

Auto Mode /
Hybrid Auto Mode

Other Shooting Modes

P Mode

Tv, Av, M, C1, and C2 Mode

Playback Mode

Wireless Features

Setting Menu

Accessories

Appendix

Index



Specific Shutter Speeds and Aperture Values ([M] Mode)

▶ Still Images ▶ Movies

Set the shutter speed and aperture value to obtain your desired exposure. For details on available shutter speeds, see “Shutter” (📖213). Available aperture values vary by lens.

1 Enter [M] mode.

- Hold down the mode dial release button and turn the mode dial to [M].

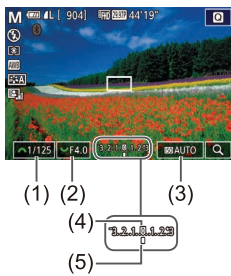

2 Configure the setting.

- Turn the [S] dial to set the shutter speed (1).
- Turn the [A] dial to set the aperture value (2).
- Press the [L] button and turn the [ISO] dial to set the ISO speed (3).
- When the ISO speed is fixed, an exposure level mark (5) based on your specified values is shown on the exposure level indicator for comparison to the standard exposure level (4). The exposure level mark is shown as [◀] or [▶] when the difference from standard exposure exceeds 3 stops.
- The ISO speed is determined and screen brightness changes when you press the shutter button halfway after setting the ISO speed to [AUTO]. If standard exposure cannot be obtained with your specified shutter speed and aperture value, the ISO speed is displayed in orange.



- After you set the shutter speed and aperture value, the exposure level may change if you adjust the zoom or recompose the shot.
- When the ISO speed is fixed, screen brightness may change depending on your specified shutter speed and aperture value. However, screen brightness remains the same when the flash is up and the mode is set to [M].
- Exposure may not be as expected when the ISO speed is set to [AUTO], because the ISO speed is adjusted to ensure standard exposure relative to your specified shutter speed and aperture value.
- Image brightness may be affected by the Auto Lighting Optimizer (📖72). To keep the Auto Lighting Optimizer disabled in [M] mode, press the [INFO] button on the Auto Lighting Optimizer setting screen to add a [✓] mark to [Disable during man expo].



- [M]: Manual
- Calculation of standard exposure is based on the specified metering method (📖70).
- You can customize camera operation so that turning the [ISO] dial adjusts the shutter speed and turning the [A] dial adjusts the aperture value (📖98).
- The following operations are available when ISO speed is set to [AUTO].
 - Adjust exposure by turning the exposure compensation dial.
 - Press the [L] button to lock the ISO speed. Screen brightness changes accordingly.



- You can also adjust the setting items on the bottom of the screen by touching an item to select it and then either touching/dragging the bar or touching [◀] [▶].

Before Use

Basic Guide

Advanced Guide

Camera Basics

Auto Mode / Hybrid Auto Mode

Other Shooting Modes

P Mode

Tv, Av, M, C1, and C2 Mode

Playback Mode

Wireless Features

Setting Menu

Accessories

Appendix

Index



Shooting Long Exposures (Bulb)

With bulb exposures, shots are exposed for as long as you hold down the shutter button.

1 Specify bulb exposure.

- Set the shutter speed to [BULB], following steps 1 – 2 in “Specific Shutter Speeds and Aperture Values ([M] Mode)” (p.92).

2 Shoot.

- Shots are exposed for as long as you hold the shutter button all the way down. The elapsed exposure time is displayed during exposure.



- Mount the camera on a tripod or take other measures to keep it still and prevent camera shake. In this case, also disable image stabilization (p.86).
- Images from bulb exposures may have more noise and look grainy. Noise can be reduced by setting [Long exp. noise reduction] to [AUTO] or [ON] (p.89).



- You can also use a Remote Controller (sold separately) for bulb exposures (p.171).



- When [Touch Shutter] is set to [Enable], shooting is started by touching the screen once and stopped by touching it again. Be careful not to move the camera when touching the screen.

Adjusting the Flash Output

▶ Still Images ▶ Movies

Choose from the three flash levels in [Tv][Av][M] modes.

1 Set the flash mode to [Manual flash].

- Press the [MENU] button and choose [Flash Control] on the [5] tab. In [Built-in flash settings], set [Flash Mode] to [Manual flash] (p.35).

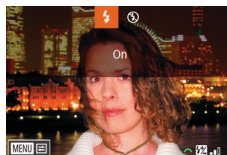

2 Configure the setting.

- Raise the flash, press the [▶] button and immediately turn the [Flash Level] dial to choose the flash level, and then press the [OK] button.
- Once the setting is complete, the flash output level is displayed.
[1/2]: Minimum, [1/2]: Medium, [1/2]: Maximum



- You can also set the flash level by accessing MENU (p.35) and choosing [5] tab > [Flash Control] > [Built-in flash settings] > [Flash output].
- You can also access the [Flash Control] screen (p.35) as follows.
 - Press and hold the [▶] button for at least one second.
 - When the flash is up, press the [▶] button and immediately press the [MENU] button.



- You can also access the [Flash Control] screen (p.35) by pressing the [▶] button and touching [MENU].

Before Use

Basic Guide

Advanced Guide

Camera Basics

Auto Mode / Hybrid Auto Mode

Other Shooting Modes

P Mode

Tv, Av, M, C1, and C2 Mode

Playback Mode

Wireless Features

Setting Menu

Accessories

Appendix

Index



Recording Movies at Specific Shutter Speeds and Aperture Values

▶ Still Images ▶ Movies

Set your preferred shutter speed, aperture value, and ISO speed. For details on available shutter speeds, see “Shutter” (📖213). Available aperture values vary by lens.

1 Enter [M] mode.

- Hold down the mode dial release button and turn the mode dial to [M].
- Press the [Q] button, choose [M] in the menu, and then choose [M] (📖34).



2 Configure the settings.

- Turn the [S] dial to set the shutter speed.
- Turn the [A] dial to set the aperture value.
- Press the [L] button and turn the [ISO] dial to set the ISO speed.



- Some shutter speeds may cause flickering on the screen when recording under fluorescent or LED lighting, which may be recorded.
- Large aperture values may delay or prevent accurate focusing.



- When the ISO speed is fixed, an exposure level mark based on your specified value is shown on the exposure level indicator for comparison to the standard exposure level. The exposure level mark is shown as [◀] or [▶] when the difference from standard exposure exceeds 3 stops.
- You can check the ISO speed in [AUTO] mode by pressing the shutter button halfway. If standard exposure cannot be obtained with your specified shutter speed and aperture value, the exposure level mark moves, indicating the difference from standard exposure. The exposure level mark is shown as [◀] or [▶] when the difference from standard exposure exceeds 3 stops.



- You can also adjust the setting items on the bottom of the screen by touching an item to select it and then either touching/dragging the bar or touching [◀] [▶].
- Focus can be locked during recording by touching [AF]. [MF] is then displayed.

Before Use

Basic Guide

Advanced Guide

Camera Basics

Auto Mode / Hybrid Auto Mode

Other Shooting Modes

P Mode

Tv, Av, M, C1, and C2 Mode

Playback Mode

Wireless Features

Setting Menu

Accessories

Appendix

Index



Customizing Controls and Display

Customizing Display Information

Customize what screen is displayed when you press the [INFO] button on the shooting screen. You can also customize what information is displayed.

1 Access the setting screen.

- On the [CAMERA] tab, choose [Screen info/ toggle settings] or [VF info/ toggle settings] in [Shooting information display], and then press the [INFO] button (p.35).

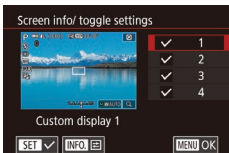

2 Configure the setting.

- Press the [▲][▼] buttons or turn the [DISP.] dial to choose any screen you prefer not to display, and then press the [INFO] button to remove the [✓] mark. Pressing the [INFO] button again will add the [✓] mark, which indicates that it is selected for display.
- To return to the menu screen, press the [MENU] button.



- An example of display with the options selected in step 2 is shown at left for reference.
- Display cannot be configured with all [✓] marks cleared, or with only [INFO. Quick Control] selected.

Customizing the Information Displayed

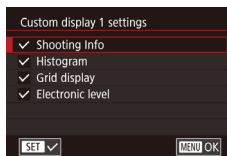

- Follow steps 1 – 2 in “Customizing Display Information” (p.95) to choose [Custom display 1] or [Custom display 2], and then press the [INFO] button.
- Press the [▲][▼] buttons or turn the [DISP.] dial to choose information to display, and then press the [INFO] button to add a [✓] mark.
- To see an example of display, press the [MENU] button to return to the [Screen info/ toggle settings] or [VF info/ toggle settings] screen.



- For a smaller grid pattern, access [CAMERA] tab > [Shooting information display] > [Grid display].
- The following settings are available by choosing [CAMERA] tab > [Shooting information display] > [Histogram].
 - Switch from a brightness histogram to an RGB histogram.
 - Reduce the size of the histogram displayed.

Configuring Touch & Drag AF

► Still Images ► Movies

With Touch & Drag AF, you can move the AF frame by touching or dragging the screen while looking through the viewfinder.

1 Access the setting screen.

- Choose [Touch & drag AF settings] on the [CAMERA] tab, and then press the [INFO] button (p.35).

Before Use

Basic Guide

Advanced Guide

Camera Basics

Auto Mode / Hybrid Auto Mode

Other Shooting Modes

P Mode

Tv, Av, M, C1, and C2 Mode

Playback Mode

Wireless Features

Setting Menu

Accessories

Appendix

Index



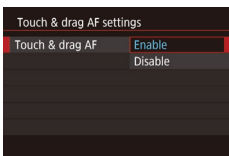

2 Configure the setting.

- Choose [Touch & drag AF], select [Enable], and then press the **[SET]** button.



- This function is not available in the following cases.
 - When the screen is open 180°
 - When MENU (book icon 35) > [F3] tab > [Touch Operation] is set to [Disable]
- AF frames may not be displayed correctly if you switch to viewfinder display while touching the screen. In this case, lift your finger and touch the screen again.



- You can also change Touch and Drag AF settings by pressing the **[Touch & drag AF]** button.

Changing the Settings of Touch and Drag Operations

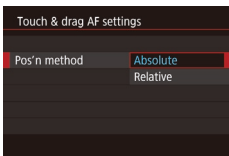

- Choose [Pos'n method] in step 1 of "Configuring Touch & Drag AF" (book icon 95) and choose the desired option.

Absolute	The AF frame moves to the touched or dragged position on the screen.
Relative	The AF frame moves in the direction you drag, by an amount corresponding to the amount you drag, no matter where you touch the screen.

Restricting the Area of the Screen Available for Touch and Drag Operations

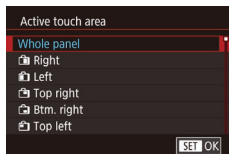

- Choose [Active touch area] in step 1 of "Configuring Touch & Drag AF" (book icon 95).
- Choose the area that will be available for this feature.

Configuring Custom Functions

Configure custom functions on the **[C.Fn]** tab of the menu (book icon 35) to customize how the camera works to suit your shooting preferences. You can also assign commonly used functions to dials and buttons.

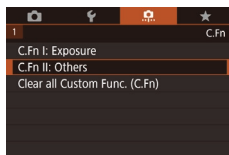

1 Choose the type of function to customize.

- Press the **[MENU]** button and choose the **[C.Fn]** tab (book icon 35).
- Press the **[▲]**/**[▼]** buttons or turn the **[DISP]** dial to choose a type of function ([Exposure] or [Others]), and then press the **[SET]** button.

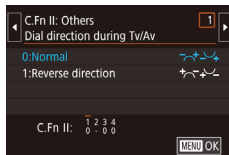

2 Choose the function.

- Press the **[◀]**/**[▶]** buttons or turn the **[DISP]**/**[DISP]** dials to choose a function, and then press the **[SET]** button.

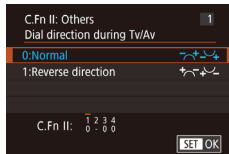

3 Choose an option.

- Press the **[▲]**/**[▼]** buttons or turn the **[DISP]** dial to choose an option.
- When finished, press the **[SET]** button to return to the previous screen.

Before Use

Basic Guide

Advanced Guide

Camera Basics

Auto Mode / Hybrid Auto Mode

Other Shooting Modes

P Mode

Tv, Av, M, C1, and C2 Mode

Playback Mode

Wireless Features

Setting Menu

Accessories

Appendix

Index



Type of Function	Function	Description
Exposure	ISO expansion	Set to [1:Enable] for the option of setting the ISO speed to [H] in [P] mode. [H] corresponds to ISO 12800.
	Safety shift	Set to [1:Enable] for automatic adjustment of the shutter speed and aperture value to bring the exposure level closer to standard exposure if standard exposure would not be available otherwise under your specified shutter speed or aperture value in [Tv] or [Av] mode.
Others	Dial direction during Tv/Av	Set to [1:Reverse direction] to reverse the direction of setting the shutter speed or aperture value in [Tv], [Av], or [P] mode with the [Dial], [Dial], or [Dial] dial.
	Custom Controls	Assign commonly used functions to dials and buttons (97).
	Release shutter w/o lens	Set to [1:Enable] to enable shooting without a lens attached, either by pressing the shutter button or movie button.
	Retract lens on power off	Specify whether the lens should be retracted automatically when you turn the camera off.



- To cancel all changes on the [1] tab and restore defaults, choose [Clear all Custom Func. (C.Fn)] on the screen in step 1, choose [OK] (either press the [OK] buttons or turn the [Dial], and press the [Dial] button.
- [H] is not available when [Highlight tone priority] is set to [D+] (72), even with [ISO expansion] set to [1:Enable].
- Safety shift is disabled when the flash fires.
- Automatic lens retraction when powered off is available for lenses that support this feature.

Assigning Functions to Buttons and Dials

Reassign functions of the shutter button, [X] button, or [Dial], [Dial], or [Dial] dials, or assign common functions to the [M-Fn] button, movie button, or other buttons.

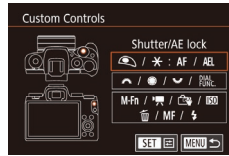

1 Access the screen for assigning functions.

- Follow steps 1 – 2 in “Configuring Custom Functions” (96) and choose [Custom Controls] in [Others].

2 Assign the function.

- Press the [▲][▼] buttons or turn the [Dial][Dial] dials to choose the dial or button to assign, and then press the [Dial] button.
- When assigning the shutter button or [X] button, press the [▲][▼] buttons or turn the [Dial] dial to choose a function.
- When assigning the [Dial][Dial] dials, choose [Dials], and then choose a function.
- For details on assigning the [Dial] dial, see “Assigning Functions to the Quick Control Dial” (98).
- When assigning the [M-Fn], movie, Touch & Drag AF switching, [ISO], [MF], or [Dial] button, press the [▲][▼][◀][▶] buttons or turn the [Dial][Dial] dials to choose a function.
- When finished, press the [Dial] button to return to the previous screen.

Before Use

Basic Guide

Advanced Guide

Camera Basics

Auto Mode / Hybrid Auto Mode

Other Shooting Modes

P Mode

Tv, Av, M, C1, and C2 Mode

Playback Mode

Wireless Features

Setting Menu

Accessories

Appendix

Index



Shutter button or [⌘] button	[AF/AE lock]	Enable exposure lock by pressing the [⌘] button, after focusing by pressing the shutter button halfway.
	[AE lock/AF]	Enable exposure lock by pressing the shutter button halfway, and focusing by pressing the [⌘] button.
	[AF/AF lock, no AE lock]	Enable focus lock by pressing the [⌘] button.
	[AE/AF, no AE lock]	Enable exposure compensation by pressing the shutter button halfway, and focusing by pressing the [⌘] button.
[☀️][⦿] dials	By assigning [Av/Tv], in [M] mode you can set aperture value with the [☀️] dial and shutter speed with the [⦿] dial.	
[☀️] ([⦿] button)	Customize the available functions and their order by pressing the [⦿] button in [Tv], [Av], [P], [M], or [⌘] modes.	
[M-Fn] button	Press the button to activate the assigned function.	
Movie button		
Touch & Drag AF switching button		
[▲] ([ISO] button)		
[▼] ([⏏] button)		
[◀] ([MF] button)		
[▶] ([⚡] button)		



- To restore the default functions to the [M-Fn], movie, Touch & Drag AF switching, [ISO], [⏏], [MF], and [⚡] buttons, choose [OFF], [⌘], [⦿], [ISO], [OFF], [MF], and [⚡].
- If you prefer not to assign any functions to the button, choose [OFF].
- Icons labeled with [⦿] when buttons are assigned indicate that the function is not available under current function conditions.
- To specify whether to capture images in both JPEG and RAW format simultaneously each time a button is pressed, assign [⦿].
- To preview the depth of field with your specified aperture value as you hold down a button, assign [⦿].
- To deactivate screen display when a button is pressed, assign [⦿].

Assigning Functions to the Quick Control Dial

Add or change the order of [☀️] dial functions that can be adjusted by pressing the [⦿] button.

1 Access the screen for assigning functions.

- Follow steps 1 – 2 in “Assigning Functions to Buttons and Dials” (p.97) and choose [Set ☀️ Func.].

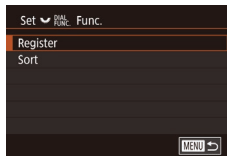

2 Assign the function.

- Choose [Register], and then press the [⦿] button.
- Press the [◀][▶] buttons to choose a shooting mode.
- Press the [▲][▼] buttons or turn the [⦿] dial to choose a function to add, and then press the [⦿] button.
- [✓] is displayed.
- To cancel saving, press the [⦿] button. [✓] is no longer displayed.
- Press the [MENU] button.

Before Use

Basic Guide

Advanced Guide

Camera Basics

Auto Mode / Hybrid Auto Mode

Other Shooting Modes

P Mode

Tv, Av, M, C1, and C2 Mode

Playback Mode

Wireless Features

Setting Menu

Accessories

Appendix

Index





3 Rearrange functions, as needed.

- Choose [Sort] and press the button.
- Press the buttons to choose a shooting mode.
- Choose a function to move (either press the buttons or turn the dial, and then press the button.
- Press the buttons or turn the dial to change the order, and then press the button.
- Default shooting settings are used for functions labeled [Normal].
- Press the **[MENU]** button.



- On the [Register] screen for saving or clearing items, you can also touch items to select them.
- On the [Sort] screen, you can also drag items to change the display order.



2 Choose icons to include in the menu.

- Press the buttons or turn the dial to choose an icon, and then press the button to label icons you want to display in the Quick Set menu with .
- Selected items (labeled with a) will be included in display.
- Items without a can be configured on the tab of the menu screen.

3 Configure the setting.

- Press the **[MENU]** button, choose [OK] (either press the buttons or turn the dial), and then press the button.



- Up to 11 items can be displayed in the menu.
- The screen in step 2 can also be accessed by holding down the button when the Quick Set menu is displayed.



- You can also choose icons on the screen in step 2 by touching them.

Customizing the Quick Set Menu

▶ Still Images ▶ Movies

The display of Quick Set menu items can be customized.

Choosing Items to Include in the Menu

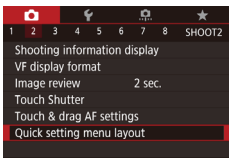

1 Access the setting screen.

- Press the **[MENU]** button, choose [Quick setting menu layout] on the tab, and then press the button (35).

Before Use

Basic Guide

Advanced Guide

Camera Basics

Auto Mode /
Hybrid Auto Mode

Other Shooting Modes

P Mode

Tv, Av, M, C1, and C2 Mode

Playback Mode

Wireless Features

Setting Menu

Accessories

Appendix

Index



Rearranging Menu Items



1 Access the setting screen.

- On the screen in step 2 of “Choosing Items to Include in the Menu” (109), press the [INFO] button.
- Press the [▲][▼] buttons or turn the [DISP.] dial to choose an icon to move, and then press the [OK] button.
- Press the [▲][▼] buttons or turn the [DISP.] dial to choose the new position, and then press the [OK] button.

2 Configure the setting.

- Press the [MENU] button, choose [OK] (either press the [◀][▶] buttons or turn the [DISP.] dial), and then press the [OK] button.



- You can also rearrange icons by dragging them.

Saving Shooting Settings

▶ Still Images ▶ Movies

Save commonly used shooting modes and your configured function settings for reuse. To access saved settings later, simply turn the mode dial to [C1] or [C2]. Even settings that are usually cleared when you switch shooting modes or turn the camera off (such as self-timer settings) can be retained this way.

Settings That Can Be Saved

- Shooting modes ([P], [Tv], [Av], and [M])
- Items set in [P], [Tv], [Av], and [M] modes (169 – 192)
- Shooting menu settings
- My Menu settings (101)

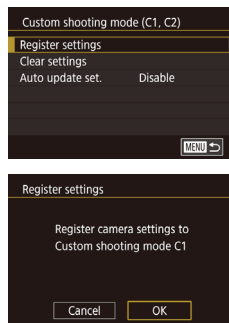

1 Enter a shooting mode with settings you want to save, and change the settings as desired.

2 Access the screen for assigning functions.

- Press the [MENU] button, choose [Custom shooting mode (C1, C2)] on the [4] tab, and then press the [OK] button.

3 Save the settings.

- Press the [▲][▼] buttons or turn the [DISP.] dial to choose [Register settings], and then press the [OK] button.
- Press the [▲][▼] buttons or turn the [DISP.] dial to choose a custom shooting mode to assign, and then press the [OK] button.
- Press the [◀][▶] buttons or turn the [DISP.] dial to choose [OK] after the confirmation message, and then press the [OK] button.



- To edit saved settings (except their shooting mode), choose [C1] or [C2], change the settings, and then repeat steps 2 – 3. These setting details are not applied in other shooting modes.



- To reset saved settings to their defaults, choose [Clear settings] on the screen in step 3, press the [OK] button, and then choose the custom shooting mode. On the confirmation screen displayed next, choose [OK] and press the [OK] button.
- To automatically update your saved settings with any changes to settings that you make while shooting in [C1] or [C2] mode, set [Auto update set.] to [Enable] on the screen in step 3.

Before Use

Basic Guide

Advanced Guide

Camera Basics

Auto Mode / Hybrid Auto Mode

Other Shooting Modes

P Mode

Tv, Av, M, C1, and C2 Mode

Playback Mode

Wireless Features

Setting Menu

Accessories

Appendix

Index



Saving Commonly Used Shooting Menu Items (My Menu)

▶ Still Images ▶ Movies

You can save up to six commonly used shooting menu items on the [★1] tab. By customizing the [★1] tab, you can access these items quickly from a single screen.

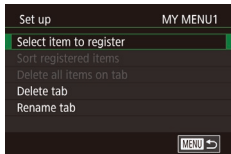
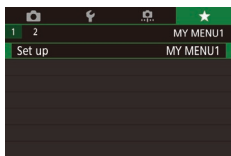
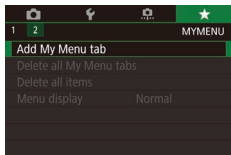

1 Access the setting screen.

- Press the [MENU] button, choose [Add My Menu tab] on the [★1] tab, and then press the [OK] button (p.35).
- Press the [◀][▶] buttons or turn the [DISP] dial to choose [OK], and then press the [OK] button.
- Choose [Set up MY MENU1] on the [★1] tab, and then press the [OK] button.

2 Configure the setting.

- Press the [▲][▼] buttons or turn the [DISP] dial to choose [Select item to register], and then press the [OK] button.
- Press the [▲][▼] buttons or turn the [DISP] dial to choose a menu item to save (max. six items) and then press the [OK] button to save it.
 - [✓] is displayed.
 - To cancel saving, press the [OK] button. [✓] is no longer displayed.
- Press the [MENU] button.

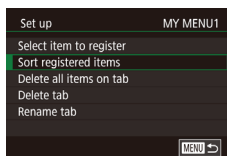

3 Rearrange menu items, as needed.

- Press the [▲][▼] buttons or turn the [DISP] dial to choose [Sort registered items], and then press the [OK] button.
- Choose a menu item to move (either press the [▲][▼] buttons or turn the [DISP] dial), and then press the [OK] button.
- Press the [▲][▼] buttons or turn the [DISP] dial to change the order, and then press the [OK] button.
- Press the [MENU] button.



- Grayed-out items in step 2 can also be specified, but they may not be available in some shooting modes.



- You can add up to [★5] by repeating this process from step 1.
- Choosing [Delete all items on tab] on the screen in step 2 will delete all items added to the tab.



- On the [Select item to register] screen for saving or clearing items, you can also touch items to select them.
- On the [Sort registered items] screen, you can also drag items to change the display order.

Before Use

Basic Guide

Advanced Guide

Camera Basics

Auto Mode / Hybrid Auto Mode

Other Shooting Modes

P Mode

Tv, Av, M, C1, and C2 Mode

Playback Mode

Wireless Features

Setting Menu

Accessories

Appendix

Index



Renaming My Menu Tabs

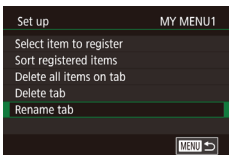

1 Choose [Rename tab].

- Following step 2 in “Saving Commonly Used Shooting Menu Items (My Menu)” (101), choose [Rename tab] and press the [MENU] button.

2 Change the tab name.

- Use the keyboard displayed to enter the new tab name (37).
- Press the [Left][Right] buttons or turn the [Dial] dial to choose [Yes], and then press the [MENU] button.

Deleting a My Menu Tab

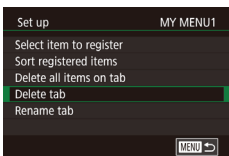

1 Choose [Delete tab].

- Following step 2 in “Saving Commonly Used Shooting Menu Items (My Menu)” (101), choose [Delete tab] and press the [MENU] button.

2 Delete the item.

- Press the [Left][Right] buttons or turn the [Dial] dial to choose [OK], and then press the [MENU] button.

Deleting All My Menu Tabs or Items

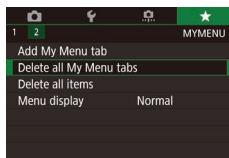

1 Choose an item.

- Choose [Delete all My Menu tabs] or [Delete all items] on the screen in step 1 of “Saving Commonly Used Shooting Menu Items (My Menu)” (101).

2 Delete the item.

- Choosing [Delete all My Menu tabs] will delete all My Menu tabs and restore the default [★] tab.
- Choosing [Delete all items] will delete all items added to tabs [★1] to [★5].

Customizing My Menu Tab Display

Specify which screen is displayed when the [MENU] button is pressed in Shooting mode.

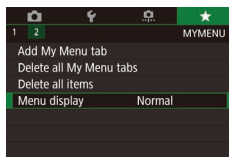

- On the screen in step 1 of “Saving Commonly Used Shooting Menu Items (My Menu)” (101), choose [Menu display], and then choose an item as desired.

Normal display	Display the most recent menu, as shown for your previous operation.
Display from My Menu tab	Start display from [★] tab screens.
Display only My Menu tab	Restrict display to [★] tab screens.

Before Use

Basic Guide

Advanced Guide

Camera Basics

Auto Mode /
Hybrid Auto Mode

Other Shooting Modes

P Mode

Tv, Av, M, C1, and C2 Mode

Playback Mode

Wireless Features

Setting Menu

Accessories

Appendix

Index



Playback Mode

Have fun reviewing your shots, and browse or edit them in many ways

- To prepare the camera for these operations, press the [▶] button to enter Playback mode.



- It may not be possible to play back or edit images that were renamed or already edited on a computer, or images from other cameras.

Viewing

▶ Still Images ▶ Movies

After shooting images or movies, you can view them on the screen as follows.

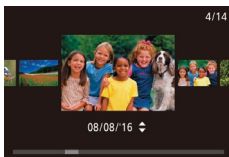
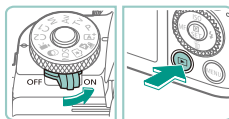

1 Enter Playback mode.

- Move the power switch to [ON].
- Press the [▶] button.
- Your last shot is displayed.

2 Choose images.

- To view the previous image, press the [◀] button or turn the [⦿] dial counterclockwise. To view the next image, press the [▶] button or turn the [⦿] dial clockwise.
- Press and hold the [◀][▶] buttons to browse through images quickly.
- To access this screen (Scroll Display mode), turn the [⦿] dial rapidly. In this mode, press the [◀][▶] buttons or turn the [⦿] dial to browse through images.
- To return to single-image display, press the [⦿] button.
- To browse images grouped by shooting date, press the [▲][▼] buttons in Scroll Display mode.
- Movies are identified by a [SET ▶] icon. To play movies, go to step 3.

Before Use

Basic Guide

Advanced Guide

Camera Basics

Auto Mode / Hybrid Auto Mode

Other Shooting Modes

P Mode

Tv, Av, M, C1, and C2 Mode

Playback Mode

Wireless Features

Setting Menu

Accessories

Appendix

Index





3 Play movies.

- To start playback, press the **[Q]** button, press the **[▲][▼]** buttons to choose **[▶]**, and then press the **[Q]** button again.



(1)

4 Adjust the volume.

- Press the **[▲][▼]** buttons to adjust the volume.
- To adjust the volume when the volume indicator (1) is no longer displayed, press the **[▲][▼]** buttons.

5 Pause playback.

- To pause or resume playback, press the **[Q]** button.
- After the movie is finished, **[SET ▶]** is displayed.



- To switch to Shooting mode from Playback mode, press the shutter button halfway.
- White lines indicating the aspect ratio are displayed when you view RAW images. These lines are shown on the top and bottom of images shot at an aspect ratio of **[16:9]** and on the left and right of images shot at an aspect ratio of **[4:3]** or **[1:1]**.
- To deactivate Scroll Display, choose **MENU (M/35) > [▶4] tab > [Scroll Display] > [Off]**.
- To have the most recent shot displayed when you enter Playback mode, choose **MENU (M/35) > [▶5] tab > [Resume] > [Last shot]**.
- To change the transition shown between images, access **MENU (M/35)** and choose your desired effect on the **[▶4] tab > [Transition Effect]**.

Touch-Screen Operations

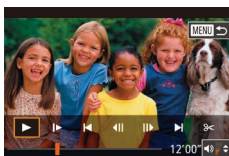
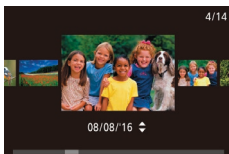

- To view the next image, drag left across the screen, and to view the previous image, drag right.

- To access Scroll Display mode, quickly drag left or right repeatedly.
- You can also browse through images in Scroll Display mode by dragging left or right.
- Touching the central image will restore single-image display.
- To browse images grouped by shooting date in Scroll Display mode, quickly drag up or down.
- To start movie playback, touch **[▶]** in step 3 of "Viewing" (M/103).
- To adjust the volume during movie playback, quickly drag up or down across the screen.
- To stop movie playback, touch the screen. The screen shown here is displayed, and the camera is ready for your next operation.

- Touch **[🔊]** to display the volume panel, and then touch **[▲][▼]** to adjust the volume.
- To switch frames, touch the scrollbar or drag left or right.
- To resume playback, touch **[▶]**.
- Touch **[↶]** to return to the screen in step 2 of "Viewing" (M/103).

Before Use

Basic Guide

Advanced Guide

Camera Basics

Auto Mode / Hybrid Auto Mode

Other Shooting Modes

P Mode

Tv, Av, M, C1, and C2 Mode

Playback Mode

Wireless Features

Setting Menu

Accessories

Appendix

Index



Switching Display Modes

Press the **[INFO]** button in Playback mode to switch from “no info display” to “info display 1” (basic info) to “info display 2” (details).



- Switching display modes is not possible while the camera is connected via Wi-Fi to devices other than printers.

Customizing the Shooting Information Displayed

Customize the information shown on each screen. For details on the information available, see “During Playback” (192).

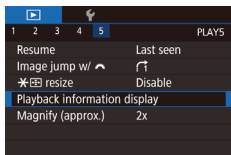

1 Access the setting screen.

- Press the **[MENU]** button, choose **[Playback information display]** on the **[▶5]** tab, and then press the **[ⓘ]** button.



2 Choose information to display.

- Press the **[▲]**/**[▼]** buttons or turn the **[DISP.]** dial to choose information to display, and then press the **[ⓘ]** button to add a **[✓]** mark.
- To return to the menu screen, press the **[MENU]** button.



- An example of display with the options selected in step 2 is shown at left for reference.
- To display **[INFO]** mode setting details, add a **[✓]** mark to **[Info display 2]**. This setting information, followed by **[Info display 2]**, will be displayed when you press the **[INFO]** button.

Overexposure Warning (for Image Highlights)

▶ Still Images ▶ Movies

Show overexposed highlights in images as blinking areas.

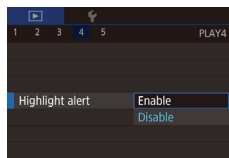

- Press the **[MENU]** button, choose **[Highlight alert]** on the **[▶4]** tab, and then choose **[Enable]**.

AF Point Display

▶ Still Images ▶ Movies

Check the AF frame that was in focus for a shot by displaying it outlined in red.

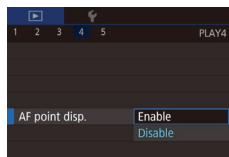

- Press the **[MENU]** button, choose **[AF point disp.]** on the **[▶4]** tab, and then choose **[Enable]**.

Grid Display

▶ Still Images ▶ Movies

Display a grid.

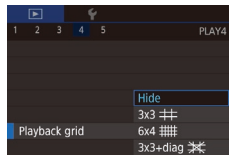

- Press the **[MENU]** button, choose **[Playback grid]** on the **[▶4]** tab, and then choose the desired option.

Before Use

Basic Guide

Advanced Guide

Camera Basics

Auto Mode /
Hybrid Auto Mode

Other Shooting Modes

P Mode

Tv, Av, M, C1, and C2 Mode

Playback Mode

Wireless Features

Setting Menu

Accessories

Appendix

Index



Brightness Histogram

▶ Still Images ▶ Movies

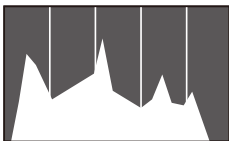

- Information displays 2 – 8 include a graph on the top called a brightness histogram, which shows the distribution of brightness in images. The horizontal axis represents the degree of brightness, and the vertical axis, how much of the image is at each level of brightness. Viewing the histogram is a way to check exposure.

RGB Histogram

▶ Still Images ▶ Movies

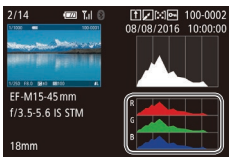

- Information display 3 includes an RGB histogram, showing the distribution of reds, greens, and blues in images. The horizontal axis represents R, G, or B brightness, and the vertical axis, how much of the image is at that level of brightness. Viewing this histogram enables you to check image color characteristics.



- An RGB histogram can also be shown at the top of information displays 2 – 8. Choose one of the information display options from 2 to 8 in [Playback information display] on tab [D5], press the [INFO] button, choose [RGB] (either press the [▲] [▼] buttons or turn the [DISP] dial), and then press the [OK] button. Note that information display 3 will show a brightness histogram on the bottom of the screen.
- The histogram can also be accessed while shooting (191).

Viewing Short Movies Created When Shooting Still Images (Digest Movies)

▶ Still Images ▶ Movies

View digest movies recorded automatically in [A] mode (41) on a day of still image shooting as follows.

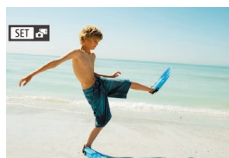

1 Choose an image.

- Still images shot in [A] mode are labeled with [SET] icon.
- Choose a still image labeled with [SET] and press the [OK] button.



2 Play the movie.

- Press the [OK] button, and then choose [M] in the menu (34).
- The movie recorded automatically on the day of still image shooting is played back, from the beginning.



- After a moment, [SET] will no longer be displayed when you are using the camera with information display deactivated (105).



- You can also play digest movies by touching [SET] on the screen in step 1 and touching [SET] on the screen in step 2.

Before Use

Basic Guide

Advanced Guide

Camera Basics

Auto Mode / Hybrid Auto Mode

Other Shooting Modes

P Mode

Tv, Av, M, C1, and C2 Mode

Playback Mode

Wireless Features

Setting Menu

Accessories

Appendix

Index



Viewing by Date

Digest movies can be viewed by date.

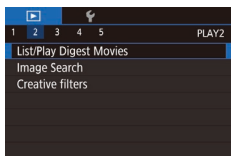

1 Choose a movie.

- Press the [MENU] button, choose [List/Play Digest Movies] on the [▶2] tab, and then choose a date (📖35).

2 Play the movie.

- Press the [▶] button to start playback.

Browsing and Filtering Images

Navigating through Images in an Index

▶ Still Images ▶ Movies

By displaying multiple images in an index, you can quickly find the images you are looking for.

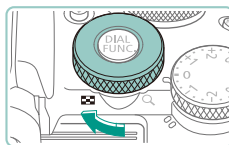

1 Display images in an index.

- Turn the [DIAL FUNC.] dial clockwise to display images in an index. To view more images at once, turn the dial again.
- To view fewer images at once, turn the [DIAL FUNC.] dial counterclockwise. Fewer images are shown each time you turn the dial.

2 Choose an image.

- Turn the [DIAL FUNC.] dial to scroll through the images.
- Press the [▲][▼][◀][▶] buttons to choose an image.
- An orange frame is displayed around the selected image.
- Press the [▶] button to view the selected image in single-image display.



- To use the [X] and [RESIZE] buttons just as you would use the [DIAL FUNC.] dial in step 1, choose MENU (📖35) > [▶5] tab > [X][RESIZE] resize > [Enable].
- To deactivate the 3D display effect (shown if you hold down the [▲][▼] buttons or turn the [DIAL FUNC.] dial rapidly), choose MENU (📖35) > [▶4] tab > [Index Effect] > [Off].

Before Use

Basic Guide

Advanced Guide

Camera Basics

Auto Mode /
Hybrid Auto Mode

Other Shooting Modes

P Mode

Tv, Av, M, C1, and C2 Mode

Playback Mode

Wireless Features

Setting Menu

Accessories

Appendix

Index



Touch-Screen Operations



- Pinch in to switch from single-image display to index display.
- To view more thumbnails per screen, pinch in again.
- Drag up or down on the screen to scroll through displayed images.
- To view fewer thumbnails per screen, spread your fingers apart.
- Touch an image to choose it, and touch it again to view it in single-image display.



Double-Touch Magnification



- Quickly touch the screen twice to magnify the image about 3x.
- To return to single-image display from magnified display, quickly touch the screen twice.

Finding Images Matching Specified Conditions

► Still Images ► Movies

Find desired images quickly on a memory card full of images by filtering image display according to your specified conditions. You can also protect (🔒112) or delete (🗑114) these images all at once.

★ Rating	Displays images you have rated (🔖117).
📅 Shot Date	Displays the images shot on a specific date.
👤 People	Displays images with detected faces.
📷 Still image/Movie	Displays still images, movies, or movies shot in [📷] mode (🔖41).



1 Choose the first condition.

- Press the [🔖] button, choose [👤] in the menu, and then press the [🔖] button. Press the [▲][▼] buttons to choose a condition.
- When [👤] is selected, you can view only images matching this condition by pressing the [◀][▶] buttons or turning the [🔖] dial. To perform an action for all of these images together, press the [🔖] button and go to step 3.

2 Choose the second condition and view the filtered images.

- When you have selected [★], [📅], or [📷] as the first condition, choose the second by pressing the [◀][▶] buttons, and then turn the [🔖] dial to view only matching images.
- To switch to filtered image display, press the [🔖] button and go to step 3.

Before Use

Basic Guide

Advanced Guide

Camera Basics

Auto Mode / Hybrid Auto Mode

Other Shooting Modes

P Mode

Tv, Av, M, C1, and C2 Mode

Playback Mode

Wireless Features

Setting Menu

Accessories

Appendix

Index





3 View the filtered images.

- Images matching your conditions are displayed in yellow frames. To view only these images, press the [◀][▶] buttons, or turn the [DISP.] dial.
- To cancel filtered display, press the [MENU] button, choose [OK] in the menu, and then press the [DISP.] button.



- When the camera has found no corresponding images for some conditions, those conditions will not be available.



- Options for viewing the images found (in step 3) include "Navigating through Images in an Index" (p. 107), "Magnifying Images" (p. 110), and "Viewing Slideshows" (p. 111). You can also apply image operations to all images found, by choosing [Protect All Images in Search] in "Protecting Images" (p. 112) or [Select All Images in Search] in "Erasing Multiple Images at Once" (p. 115), "Adding Images to the Print List (DPOF)" (p. 181), or "Adding Images to a Photobook" (p. 183).
- If you edit images and save them as new images (p. 118 – p. 121), a message is displayed, and the images that were found are no longer shown.
- The same operations are available by pressing the [MENU] button and choosing [▶2] tab > [Image Search].



- You can also choose conditions by touching the screens in steps 1 and 2.

Using the Front Dial to Jump between Images

Use the main dial to find and jump between desired images quickly by filtering image display according to your specified conditions.

	Displays images you have rated (p. 117).
	Jumps to the first image in each group of images that were shot on the same date.
	Jumps by 10 images at a time.
	Jumps by 100 images at a time.



1 Choose a condition.

- Choose a condition (or jump method) in single-image display by turning the [DISP.] dial and then pressing the [▲][▼] buttons.

2 View images matching your specified condition, or jump by the specified amount.

- Turn the [DISP.] dial to view only images matching the condition or jump by the specified number of images forward or back.



- Use [DISP.] to jump between images with any rating.
- Turning the [DISP.] dial when browsing images in index display will jump to the previous or next image according to the jump method chosen in single-image display.
- You can also set the condition (or jump method) by choosing MENU (p. 35) > [▶5] tab > [Image jump w/].

Before Use

Basic Guide

Advanced Guide

Camera Basics

Auto Mode /
Hybrid Auto Mode

Other Shooting Modes

P Mode

Tv, Av, M, C1, and C2 Mode

Playback Mode

Wireless Features

Setting Menu

Accessories

Appendix

Index



Touch-Screen Operations



- You can also jump to the previous or next image according to your jump method chosen in step 1 of “Using the Front Dial to Jump between Images” (p. 109) by dragging left or right with two fingers.

Image Viewing Options

Magnifying Images

► Still Images ► Movies

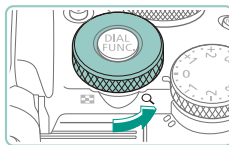

(1)

1 Magnify an image.

- Each time you turn the [DIAL FUNC.] dial counterclockwise, images are magnified, up to about 10x.
- The approximate position of the displayed area (1) is shown for reference.
- To reduce image display, turn the [DIAL FUNC.] dial clockwise.

2 Move the display position and switch images as needed.

- To move the display position, press the [▲][▼][◀][▶] buttons. Press the [Ⓜ] button to move to the AF frame that was in focus at the time of shooting.
- To switch to other images while zoomed, turn the [DIAL FUNC.] dial.

Before Use

Basic Guide

Advanced Guide

Camera Basics

Auto Mode /
Hybrid Auto Mode

Other Shooting Modes

P Mode

Tv, Av, M, C1, and C2 Mode

Playback Mode

Wireless Features

Setting Menu

Accessories

Appendix

Index





- You can return to single-image display from magnified display by pressing the **[MENU]** button.
- In [Magnify (approx.)] on tab **[▶5]**, you can set the magnification in single-image display when the **[⚙️]** dial is turned counterclockwise. Set to [Reuse last magnification] to enlarge to the magnification used last time, before you pressed the **[MENU]** button. Set to [Actual size (from selected pt)] for display with image pixels shown approximately full size, centered on the AF frame in focus.
- To use the **[✂️]** and **[📐]** buttons just as you would use the **[⚙️]** dial in step 1, choose MENU (📖35) > **[▶5]** tab > **[✂️📐]** [resize] > [Enable].

Touch-Screen Operations



- Spread your fingers apart (pinch out) to zoom in.
- You can magnify images up to about 10x by repeating this action.
- To move the display position, drag across the screen.
- Pinch in to zoom out.
- Touch **[MENU]** to restore single-image display.



Viewing Slideshows

▶ Still Images ▶ Movies

Automatically play back images from a memory card as follows.

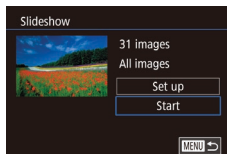

- Press the **[MENU]** button, and then choose [Slideshow] on the **[▶1]** tab (📖35).
- Press the **[▲][▼]** buttons or turn the **[⚙️]** dial to choose [Start], and then press the **[⏪]** button.
- The slideshow will start after [Loading image] is displayed for a few seconds.
- Press the **[MENU]** button to stop the slideshow.



- The camera's power-saving functions (📖31) are deactivated during slideshows.



- To pause or resume slideshows, press the **[⏪]** button.
- You can switch to other images during playback by pressing the **[◀][▶]** buttons or turning the **[⚙️]** dial. For fast-forward or fast-rewind, hold the **[◀][▶]** buttons down.
- You can configure slideshow repetition, display time per image, and the transition between images on the screen accessed by choosing [Set up] and pressing the **[⏪]** button (📖35).



- You can also stop slideshows by touching the screen.

Before Use

Basic Guide

Advanced Guide

Camera Basics

Auto Mode / Hybrid Auto Mode

Other Shooting Modes

P Mode

Tv, Av, M, C1, and C2 Mode

Playback Mode

Wireless Features

Setting Menu

Accessories

Appendix

Index



Protecting Images

► Still Images ► Movies

Protect important images to prevent accidental erasure (📖 114).



- Press the **[MENU]** button, choose **[Protect]** in the menu, and then choose **[Protect]** (either press the **[Left]**/**[Right]** buttons or turn the **[Dial]**). **[Protect]** is displayed.
- To cancel protection, choose **[OFF]**. **[Protect]** is no longer displayed.



- Protected images on a memory card will be erased if you format the card (📖 156).



- Protected images cannot be erased using the camera's erasure function. To erase them this way, first cancel protection.

Using the Menu

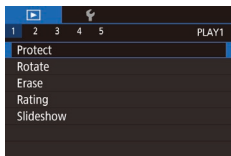

1 Access the setting screen.

- Press the **[MENU]** button and choose **[Protect]** on the **[PLAY1]** tab (📖 35).

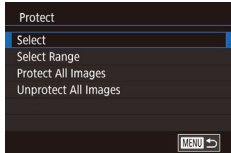

2 Choose a selection method.

- Choose an option as desired (📖 35).
- To return to the menu screen, press the **[MENU]** button.

Choosing Images Individually

1 Choose **[Select]**.

- Following step 2 in "Using the Menu" (📖 112), choose **[Select]** and press the **[MENU]** button.



2 Choose an image.

- Press the **[Left]**/**[Right]** buttons or turn the **[Dial]** to choose an image, and then press the **[MENU]** button. **[Protect]** is displayed.
- To cancel selection, press the **[MENU]** button again. **[Protect]** is no longer displayed.
- Repeat this process to specify other images.

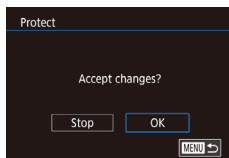

3 Protect the image.

- Press the **[MENU]** button. A confirmation message is displayed.
- Press the **[Left]**/**[Right]** buttons or turn the **[Dial]** to choose **[OK]**, and then press the **[MENU]** button.



- Images will not be protected if you switch to Shooting mode or turn the camera off before finishing the setup process in step 3.



- You can also select or clear images by touching the screen in step 2, and you can access the confirmation screen by touching **[MENU]**.
- You can also protect images by touching **[OK]** on the screen in step 3.

Before Use

Basic Guide

Advanced Guide

Camera Basics

Auto Mode /
Hybrid Auto Mode

Other Shooting Modes

P Mode

Tv, Av, M, C1, and C2 Mode

Playback Mode

Wireless Features

Setting Menu

Accessories

Appendix

Index



Selecting a Range

1 Choose [Select Range].

- Following step 2 in “Using the Menu” (112), choose [Select Range] and press the [OK] button.

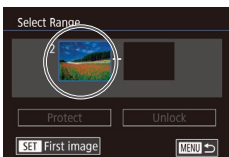

2 Choose a starting image.

- Press the [OK] button.

- Press the [Left][Right] buttons or turn the [Dial] dial to choose an image, and then press the [OK] button.

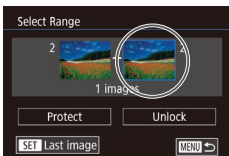

3 Choose an ending image.

- Press the [Right] button to choose [Last image], and then press the [OK] button.

- Press the [Left][Right] buttons or turn the [Dial] dial to choose an image, and then press the [OK] button.
- Images before the first image cannot be selected as the last image.

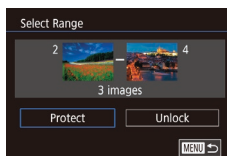

4 Protect the images.

- Press the [Down] button to choose [Protect], and then press the [OK] button.



- You can also choose the first or last image by turning the [Dial] dial when the top screen in steps 2 and 3 is displayed.
- To cancel protection for groups of images, choose [Unlock] in step 4.



- You can also display the screen for choosing the first or last image by touching an image on the top screen in steps 2 or 3.
- You can also protect images by touching [Protect] on the screen in step 4.

Protecting All Images at Once

1 Choose [Protect All Images].

- Following step 2 in “Using the Menu” (112), choose [Protect All Images] and press the [OK] button.

2 Protect the images.

- Press the [Left][Right] buttons or turn the [Dial] dial to choose [OK], and then press the [OK] button.

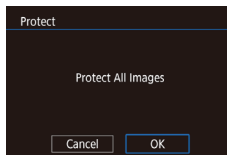

Before Use

Basic Guide

Advanced Guide

Camera Basics

Auto Mode /
Hybrid Auto Mode

Other Shooting Modes

P Mode

Tv, Av, M, C1, and C2 Mode

Playback Mode

Wireless Features

Setting Menu

Accessories

Appendix

Index



Clearing All Protection at Once

You can clear protection from all images at once.

To clear protection, choose [Unprotect All Images] in step 1 of “Protecting All Images at Once” (📖 113), and then complete step 2.

Erasing Images

▶ Still Images ▶ Movies

You can choose and erase unneeded images one by one. Be careful when erasing images, because they cannot be recovered. However, protected images (📖 112) cannot be erased.

1 Choose an image to erase.

- Press the [◀][▶] buttons or turn the [🔍] dial to choose an image.

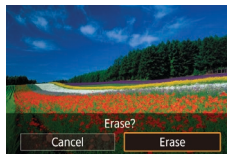

2 Erase the image.

- Press the [▼] button.
- After [Erase?] is displayed, press the [◀][▶] buttons or turn the [🔍] dial to choose [Erase], and then press the [🔍] button.
- The current image is now erased.
- To cancel erasure, press the [◀][▶] buttons or turn the [🔍] dial to choose [Cancel], and then press the [🔍] button.



- For images captured in both RAW and JPEG format, pressing the [▼] button while the image is displayed gives you the option of choosing [Erase RAW], [Erase JPEG], or [Erase RAW+JPEG].



- You can also erase the current image by touching [Erase] on the screen in step 2.

Before Use

Basic Guide

Advanced Guide

Camera Basics

Auto Mode /
Hybrid Auto Mode

Other Shooting Modes

P Mode

Tv, Av, M, C1, and C2 Mode

Playback Mode

Wireless Features

Setting Menu

Accessories

Appendix

Index



Erasing Multiple Images at Once

You can choose multiple images to erase at once. Be careful when erasing images, because they cannot be recovered. However, protected images (📖 112) cannot be erased.

Choosing a Selection Method

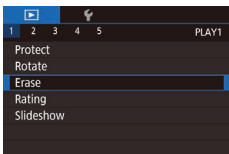

1 Access the setting screen.

- Press the [MENU] button, and then choose [Erase] on the [▶] tab (📖 35).

2 Choose a selection method.

- Press the [▲][▼] buttons or turn the [🌀] dial to choose a selection method, and then press the [📷] button.
- To return to the menu screen, press the [MENU] button.

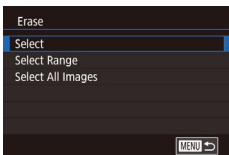

Choosing Images Individually

1 Choose [Select].

- Following step 2 in “Choosing a Selection Method” (📖 115), choose [Select] and press the [📷] button.



2 Choose an image.

- Once you choose an image following step 2 in “Choosing Images Individually” (📖 112), [✓] is displayed.
- To cancel selection, press the [📷] button again. [✓] is no longer displayed.
- Repeat this process to specify other images.

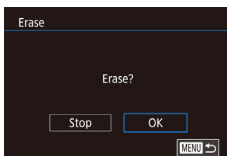

3 Erase the images.

- Press the [MENU] button. A confirmation message is displayed.
- Press the [◀][▶] buttons or turn the [🌀] dial to choose [OK], and then press the [📷] button.



- Choosing an image captured in both RAW and JPEG format will erase both versions.

Selecting a Range

1 Choose [Select Range].

- Following step 2 in “Choosing a Selection Method” (📖 115), choose [Select Range] and press the [📷] button.

2 Choose images.

- Follow steps 2 – 3 in “Selecting a Range” (📖 113) to specify images.

Before Use

Basic Guide

Advanced Guide

Camera Basics

Auto Mode /
Hybrid Auto Mode

Other Shooting Modes

P Mode

Tv, Av, M, C1, and C2 Mode

Playback Mode

Wireless Features

Setting Menu

Accessories

Appendix

Index



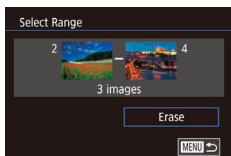

3 Erase the images.

- Press the [▼] button to choose [Erase], and then press the [E] button.

Specifying All Images at Once

1 Choose [Select All Images].

- Following step 2 in “Choosing a Selection Method” (📖 115), choose [Select All Images] and press the [E] button.

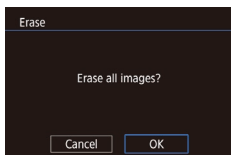

2 Erase the images.

- Press the [◀][▶] buttons or turn the [DIAL] dial to choose [OK], and then press the [E] button.

Rotating Images

▶ Still Images ▶ Movies

Change the orientation of images and save them as follows.



1 Choose [E].

- Press the [E] button, and then choose [E] in the menu (📖 34).

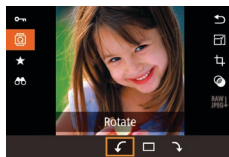

2 Rotate the image.

- Press the [◀][▶] buttons or turn the [DIAL] dial to choose [↻] or [↺], which rotates the image 90° in the specified direction. Press the [E] button to complete the setting.



- Rotation is not possible when [Auto Rotate] is set to [Off] (📖 117).

Using the Menu

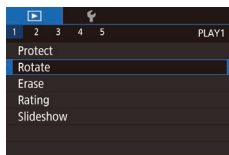

1 Choose [Rotate].

- Press the [MENU] button and choose [Rotate] on the [1] tab (📖 35).

Before Use

Basic Guide

Advanced Guide

Camera Basics

Auto Mode / Hybrid Auto Mode

Other Shooting Modes

P Mode

Tv, Av, M, C1, and C2 Mode

Playback Mode

Wireless Features

Setting Menu

Accessories

Appendix

Index



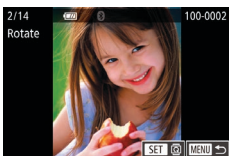

2 Rotate the image.

- Press the [◀][▶] buttons or turn the [🌀] dial to choose an image.
- Press the [🌀] button to rotate the image 90° clockwise. Press it again to rotate it 90° counterclockwise, and press it a third time to restore the original orientation.
- To return to the menu screen, press the [MENU] button.



- On the screen in step 2, you can also touch [SET] to rotate images or touch [MENU] to return to the menu screen.

Deactivating Auto Rotation

Follow these steps to deactivate automatic image rotation, which rotates images based on the current camera orientation.

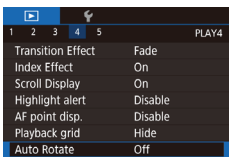

- Press the [MENU] button, choose [Auto Rotate] on the [▶]4 tab, and then choose [Off] (📖35).



- Images cannot be rotated (📖116) when you set [Auto Rotate] to [Off]. Additionally, images already rotated will be displayed in the original orientation.

Rating Images (Rating)

▶ Still Images ▶ Movies

Organize images by rating them on a scale of 1 – 5 ([OFF], [★], [★★], [★★★], [★★★★], or [★★★★★]). By viewing only images with a specified rating, you can restrict the following operations to all images with that rating.

- “Viewing” (📖103), “Viewing Slideshows” (📖111), “Protecting Images” (📖112), “Erasing Images” (📖114), “Adding Images to the Print List (DPOF)” (📖181), “Adding Images to a Photobook” (📖183)
- Press the [🌀] button, choose [★] in the menu, and then rate the image (📖34).
- To remove ratings, repeat this process but choose [OFF], and then press the [🌀] button.



Using the Menu

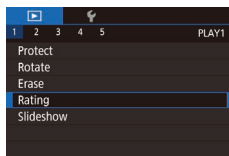

1 Choose [Rating].

- Press the [MENU] button and choose [Rating] on the [▶]1 tab (📖35).

2 Choose an image and rate it.

- Choose an image (either press the [◀][▶] buttons or turn the [🌀] dial), and then press the [▲][▼] buttons to choose a rating.

Before Use

Basic Guide

Advanced Guide

Camera Basics

Auto Mode /
Hybrid Auto Mode

Other Shooting Modes

P Mode

Tv, Av, M, C1, and C2 Mode

Playback Mode

Wireless Features

Setting Menu

Accessories

Appendix

Index



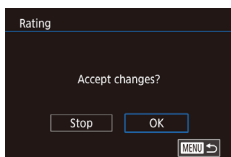

3 Configure the setting.

- Press the [MENU] button. A confirmation message is displayed.
- Press the [◀][▶] buttons or turn the [DISP.] dial to choose [OK], and then press the [DISP.] button.



- Ratings are not applied if you switch to Shooting mode or turn the camera off before finishing the setup process in step 3.



- You can also rate images by touching [▲][▼] on the bottom of the screen in step 2.

Editing Still Images



- Image editing (118 – 121) is only available when the memory card has sufficient free space.



- When [SET] is shown on the screen, you can touch [SET] instead of pressing the [DISP.] button, if you prefer.
- When [MENU] is shown on the screen, you can touch [MENU] instead of pressing the [MENU] button, if you prefer.

Resizing Images

▶ Still Images ▶ Movies

Save a copy of images at a lower number of recording pixels.



1 Choose an image size.

- Press the [DISP.] button, choose [F1] in the menu, and choose an image size (34).
- Press the [DISP.] button.



2 Save the new image.

- After [Save new image?] is displayed, press the [◀][▶] buttons or turn the [DISP.] dial to choose [OK], and then press the [DISP.] button.

Before Use

Basic Guide

Advanced Guide

Camera Basics

Auto Mode / Hybrid Auto Mode

Other Shooting Modes

P Mode

Tv, Av, M, C1, and C2 Mode

Playback Mode

Wireless Features

Setting Menu

Accessories

Appendix

Index



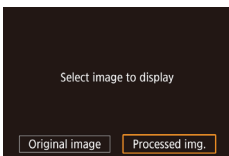

3 Review the new image.

- Press the [◀][▶] buttons or turn the [DISP] dial to choose [Processed img.], and then press the [DISP] button.
- The saved image is now displayed.



- Editing is not possible for images shot at a recording pixel setting of [S2] (118).
- RAW images cannot be edited.



- Images cannot be resized to a higher number of recording pixels.
- Choosing [Original image] in step 3 will display the original image.

Using the Menu

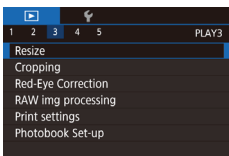

1 Choose [Resize].

- Press the [MENU] button and choose [Resize] on the [PLAY3] tab (135).

2 Choose an image.

- Press the [◀][▶] buttons or turn the [DISP] dial to choose an image, and then press the [DISP] button.

3 Choose an image size.

- Press the [◀][▶] buttons or turn the [DISP] dial to choose the size, and then press the [DISP] button.

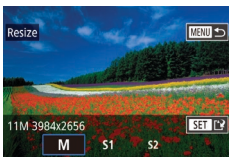

4 Save as a new image and review.

- Follow step 2 in “Resizing Images” (118).
- Press the [MENU] button and follow step 3 in “Resizing Images” (118).

Cropping

▶ Still Images ▶ Movies

You can specify a portion of an image to save as a separate image file.



1 Access the setting screen.

- Press the [DISP] button, choose [C] in the menu, and then press the [DISP] button (34).

2 Resize, move, and adjust the aspect ratio of the cropping frame.

- To resize the frame, turn the [DISP] dial.
- To move the frame, press the [▲][▼][◀][▶] buttons.
- To change the frame orientation, turn the [DISP] dial to choose [L], and then press the [DISP] button.
- To change the frame aspect ratio, turn the [DISP] dial to choose [4:3]. To switch between aspect ratios ([3:2], [16:9], [4:3], and [1:1]), press the [DISP] button repeatedly.

3 Preview the cropped image.

- Turn the [DISP] dial to choose [C].
- To switch display between the cropped image and the cropping frame, press the [DISP] button repeatedly.

Before Use

Basic Guide

Advanced Guide

Camera Basics

Auto Mode / Hybrid Auto Mode

Other Shooting Modes

P Mode

Tv, Av, M, C1, and C2 Mode

Playback Mode

Wireless Features

Setting Menu

Accessories

Appendix

Index



4 Save as a new image and review.

- Turn the [●] dial to choose [📷], and then press the [📷] button.
- Follow steps 2 – 3 in “Resizing Images” (📖118).



- RAW images cannot be edited.
- Cropped images cannot be cropped again.
- Cropped images cannot be resized or have Creative filters applied.



- Cropped images will have a lower number of recording pixels than uncropped images.
- While previewing the cropped image in step 3, you can resize, move, and adjust the aspect ratio of the cropping frame.
- Operations in step 2 are also possible by pressing the [MENU] button, choosing [▶3] tab > [Cropping], pressing the [📷] button, choosing an image, and pressing the [📷] button again.



- You can also move the cropping frame in step 2 by dragging it. You can also resize frames by pinching in or out (📖111) on the screen.
- Operations are also possible by touching [📷], [📷], [📷], and [📷] on the top of the screen in step 2.

Applying Filter Effects

Apply effects equivalent to shooting in [📷], [📷], [📷], [📷], [📷], [📷], and [📷] modes to images and save them as separate images.

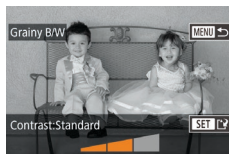
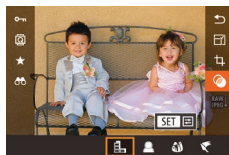

1 Choose an effect.

- Press the [📷] button, choose [📷] in the menu, and then choose the effect (📖34).
- Press the [📷] button.

2 Adjust the effect as needed.

- [📷]: Press the [◀][▶] buttons or turn the [●] dial to adjust contrast.
- [📷]: Press the [◀][▶] buttons or turn the [●] dial to adjust defocusing.
- [📷] or [📷]: Press the [◀][▶] buttons or turn the [●] dial to adjust the level of the effect.
- [📷]: Press the [◀][▶] buttons or turn the [●] dial to adjust color saturation.
- [📷]: Press the [◀][▶] buttons or turn the [●] dial to adjust color tone.
- [📷]: Press the [INFO] button to resize the frame, and press the [▲][▼] buttons to move it.

3 Save as a new image and review.

- Press the [📷] button.
- Follow steps 2 – 3 in “Resizing Images” (📖118).

Before Use

Basic Guide

Advanced Guide

Camera Basics

Auto Mode /
Hybrid Auto Mode

Other Shooting Modes

P Mode

Tv, Av, M, C1, and C2 Mode

Playback Mode

Wireless Features

Setting Menu

Accessories

Appendix

Index





- [🖱️]: To switch the orientation of the frame to vertical, press the [◀][▶] buttons on the screen in step 2. To move the frame, press the [◀][▶] buttons again. To return the frame to horizontal orientation, press the [▲][▼] buttons.
- The same operations are available by pressing the [MENU] button and choosing [📷] tab > [Creative filters], choosing an image, and pressing the [🖱️] button.



- You can also adjust the effect by touching or dragging the bar on the bottom of the screen in step 2. For [🖱️], you can also move the frame by touching or dragging across the screen.

Correcting Red-Eye

▶ Still Images ▶ Movies

Automatically corrects images affected by red-eye. You can save the corrected image as a separate file.

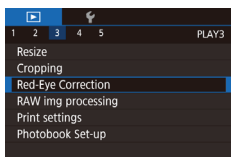

1 Choose [Red-Eye Correction].

- Press the [MENU] button, and then choose [Red-Eye Correction] on the [📷] tab (📖35).

2 Choose an image.

- Press the [◀][▶] buttons or turn the [🔘] dial to choose an image.

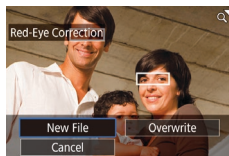

3 Correct the image.

- Press the [🔘] button.
- Red-eye detected by the camera is now corrected, and frames are displayed around corrected image areas.
- Enlarge or reduce images as needed. Follow the steps in "Magnifying Images" (📖110).

4 Save as a new image and review.

- Press the [▲][▼][◀][▶] buttons or turn the [🔘] dial to choose [New File], and then press the [🖱️] button.
- The image is now saved as a new file.
- Press the [MENU] button and follow step 3 in "Resizing Images" (📖118).



- Some images may not be corrected accurately.
- To overwrite the original image with the corrected image, choose [Overwrite] in step 4. In this case, the original image will be erased.
- Protected images cannot be overwritten.
- RAW images cannot be edited this way.
- Red-eye correction can be applied to JPEG images also captured in RAW format, but the original image cannot be overwritten.



- You can also save images by touching [New File] or [Overwrite] on the screen in step 4.

Before Use

Basic Guide

Advanced Guide

Camera Basics

Auto Mode / Hybrid Auto Mode

Other Shooting Modes

P Mode

Tv, Av, M, C1, and C2 Mode

Playback Mode

Wireless Features

Setting Menu

Accessories

Appendix

Index



Processing RAW Images with the Camera

▶ Still Images ▶ Movies

Process images captured in RAW format on the camera. The original RAW image is retained, and a copy is saved as a JPEG.

1 Choose a RAW image.

- Press the [◀][▶] buttons or turn the [DISP] dial to choose a RAW image.



2 Access the setting screen.

- Press the [MENU] button, and choose [RAW] in the menu. Choose the desired option (either press the [◀][▶] buttons or turn the [DISP] dial).
- When choosing [RAW], go to step 3.



3 Set the processing conditions.

- If you have chosen [RAW], press the [MENU] button, press the [▲][▼][◀][▶] buttons to choose an option, and then press the [MENU] button.

4 Configure advanced settings.

- Choose an effect (either press the [◀][▶] buttons or turn the [DISP] dial), and then press the [MENU] button to return to the screen in step 3.

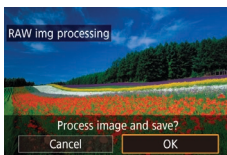

5 Save the image.

- If you have chosen [RAW], press the [▲][▼][◀][▶] buttons to choose [RAW]. Press the [MENU] button, choose [OK] (either press the [◀][▶] buttons or turn the [DISP] dial), and then press the [MENU] button again.
- If you have chosen [RAW], press the [◀][▶] buttons or turn the [DISP] dial to choose [OK], and then press the [MENU] button.

Brightness adjustment	Adjust brightness.
White balance	Choose a white balance.
Picture Style	Choose a Picture Style.
Auto Lighting Optimizer	Set Auto Lighting Optimizer details.
High ISO speed NR	Set noise reduction details.
Image quality	Set the image quality level of the resulting JPEG image.
Peripheral illum corr	Correct vignetting from lens characteristics.
Chromatic aberr corr	Correct chromatic aberration from lens characteristics.
Diffraction correction	Correct loss of sharpness from diffraction.

Before Use

Basic Guide

Advanced Guide

Camera Basics

Auto Mode / Hybrid Auto Mode

Other Shooting Modes

P Mode

Tv, Av, M, C1, and C2 Mode

Playback Mode

Wireless Features

Setting Menu

Accessories

Appendix

Index





- You can also choose an effect for a selected processing condition on the screen in step 3 by turning the [INFO] dial.
- For magnified display on the screen in step 3, turn the [INFO] dial counterclockwise.
- You can compare the current image to the original image by pressing the [INFO] button and turning the [INFO] dial on the screen in step 3. To return to the setting screen, press the [MENU] button.
- To restore the original settings, on the screen in step 3, press the [INFO] button, choose [OK] (either press the [INFO] buttons or turn the [INFO] dial), and then press the [INFO] button.
- You can configure advanced settings for functions labeled with [INFO] on the screen in step 4 by pressing the [INFO] button.

Using the Menu

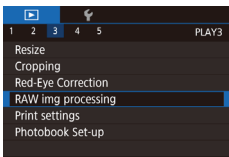

1 Access the setting screen.

- Press the [MENU] button and choose [RAW img processing] on the [INFO] tab (35).

2 Choose a selection method.

- Choose an option as desired (35).
- To return to the menu screen, press the [MENU] button.

Choosing Images Individually



1 Choose [Select].

- Following the procedure in “Using the Menu” (123), choose [Select] and press the [INFO] button.

2 Choose an image.

- Once you choose an image following step 2 in “Choosing Images Individually” (112), [✓] is displayed.
- To cancel selection, press the [INFO] button again. [✓] is no longer displayed.
- Repeat this process to specify other images.
- Press the [MENU] button to go to the next screen.

3 Process the image.

- Follow steps 2 – 5 in “Processing RAW Images with the Camera” (122) to process the image.

Before Use

Basic Guide

Advanced Guide

Camera Basics

Auto Mode /
Hybrid Auto Mode

Other Shooting Modes

P Mode

Tv, Av, M, C1, and C2 Mode

Playback Mode

Wireless Features

Setting Menu

Accessories

Appendix

Index



Selecting a Range

1 Choose [Select Range].

- Following the procedure in “Using the Menu” (📖 119), choose [Select Range] and press the [MENU] button.

2 Choose images.

- Follow steps 2 – 3 in “Selecting a Range” (📖 113) to specify images.

3 Process the image.

- Follow steps 2 – 5 in “Processing RAW Images with the Camera” (📖 122) to process the image.



- Images produced by in-camera processing will not match those processed with Digital Photo Professional exactly.



- Up to 500 images can be selected at one time.
- When processing images from the menu, use the [▲][▼] buttons to choose a desired item.

Editing Movies

▶ Still Images ▶ Movies

You can remove unneeded portions from the beginning and end of movies (excluding digest movies, 📖 41).

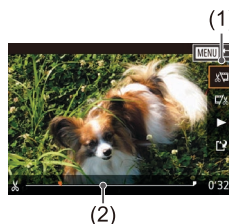
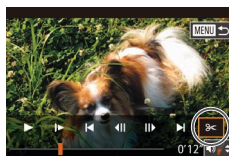

1 Choose [C].

- Following steps 1 – 5 in “Viewing” (📖 103), choose [C] and press the [MENU] button.
- The movie editing panel and editing bar are now displayed.

2 Specify portions to cut.

- (1) is the movie editing panel, and (2) is the editing bar.
- Press the [▲][▼] buttons to choose [L] or [R].
- To specify a portion to cut (indicated by [L]), press the [◀][▶] buttons or turn the [DISC] dial to move the orange [L] or [R] icon. Cut the beginning of the movie (from [L]) by choosing [L], and cut the end of the movie by choosing [R].
- If you move [L] or [R] to a position other than a [L] mark, in [L] the portion before the nearest [L] mark on the left will be cut, while in [R] the portion after the nearest [L] mark on the right will be cut.

Before Use

Basic Guide

Advanced Guide

Camera Basics

Auto Mode / Hybrid Auto Mode

Other Shooting Modes

P Mode

Tv, Av, M, C1, and C2 Mode

Playback Mode

Wireless Features

Setting Menu

Accessories

Appendix

Index



3 Review the edited movie.

- Press the [▲][▼] buttons to choose [▶], and then press the [Ⓜ] button. The edited movie is now played.
- To edit the movie again, repeat step 2.
- To cancel editing, press the [MENU] button, choose [OK] (either press the [◀][▶] buttons or turn the [Ⓜ] dial), and then press the [Ⓜ] button.

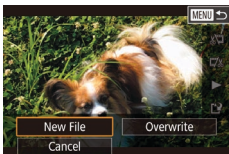

4 Save the edited movie.

- Press the [▲][▼] buttons to choose [▶], and then press the [Ⓜ] button.
- Press the [▲][▼][◀][▶] buttons or turn the [Ⓜ] dial to choose [New File], and then press the [Ⓜ] button.
- Choose [Save w/o Comp.], and then press the [Ⓜ] button.
- The movie is now saved as a new file.

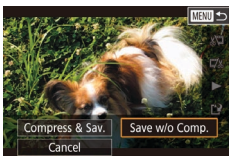

- To overwrite the original movie with the cut one, choose [Overwrite] in step 4. In this case, the original movie will be erased.
- If the memory card lacks sufficient space, only [Overwrite] will be available.
- Movies may not be saved if the battery pack runs out while saving is in progress.
- When editing movies, if possible, use a fully charged battery pack, or insert a DC coupler and connect an AC adapter (both sold separately, 167).

Reducing File Sizes

Movie file sizes can be reduced by compressing movies as follows.

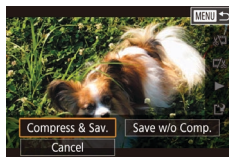

- On the screen in step 4 of “Editing Movies” (124), choose [▶]. Choose [New File], and then press the [Ⓜ] button.
- Choose [Compress & Sav.], and then press the [Ⓜ] button.

The image quality after compression is as follows.

Before Compression	After Compression
FHD 59.94P	HD 29.97P
FHD 50.00P	HD 25.00P
FHD 29.97P	HD 29.97P
FHD 23.98P	HD 23.98P
HD 59.94P	HD 29.97P
FHD 25.00P	HD 25.00P
HD 50.00P	HD 25.00P



- [VGA 29.97P] and [VGA 25.00P] movies cannot be compressed.
- Edited movies cannot be saved in compressed format when you choose [Overwrite].

Before Use

Basic Guide

Advanced Guide

Camera Basics

Auto Mode /
Hybrid Auto Mode

Other Shooting Modes

P Mode

Tv, Av, M, C1, and C2 Mode

Playback Mode

Wireless Features

Setting Menu

Accessories

Appendix

Index



Editing Digest Movies

▶ Still Images ▶ Movies

Individual chapters (clips) (📖41) recorded in [📹] mode can be erased, as needed. Be careful when erasing clips, because they cannot be recovered.

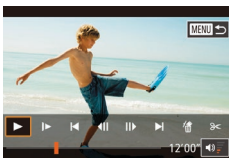

1 Select the clip to erase.

- Play a movie recorded in [📹] mode as described in steps 1 – 2 in “Viewing Short Movies Created When Shooting Still Images (Digest Movies)” (📖106), and then press the [📹] button to access the movie control panel.
- Press the [◀][▶] buttons or turn the [🔍] dial to choose [◀] or [▶], and then press the [📹] button.

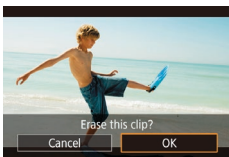

2 Choose [🗑️].

- Press the [◀][▶] buttons or turn the [🔍] dial to choose [🗑️], and then press the [📹] button.
- The selected clip is played back repeatedly.

3 Confirm erasure.

- Press the [◀][▶] buttons or turn the [🔍] dial to choose [OK], and then press the [📹] button.
- The clip is erased, and the short movie is overwritten.



- [🗑️] is not displayed if you select a clip when the camera is connected to a printer.

Before Use

Basic Guide

Advanced Guide

Camera Basics

Auto Mode /
Hybrid Auto Mode

Other Shooting Modes

P Mode

Tv, Av, M, C1, and C2 Mode

Playback Mode

Wireless Features

Setting Menu

Accessories

Appendix

Index



Wireless Features

Send images wirelessly from the camera to a variety of compatible devices, and use the camera with Web services



- Before using wireless features, be sure to read “Precautions for Wireless Features (Wi-Fi, Bluetooth, or Others)” (P.220).

Available Wireless Features

Using Wi-Fi Features

You can send and receive images and control the camera remotely by connecting it to these devices and services via Wi-Fi.

- **Smartphones and Tablets**
Send images to smartphones and tablet computers that have Wi-Fi functions. You can also shoot as you view a shooting screen on your smartphone or tablet. For convenience in this guide, smartphones, tablets, and other compatible devices are collectively referred to as “smartphones”.
- **Web Services**
Add your account information to the camera for CANON iMAGE GATEWAY online photography service or other Web services to send camera images to the services. Unsent images on the camera can also be sent to a computer or Web service via CANON iMAGE GATEWAY.
- **Media Player**
View images on DLNA*-compatible TVs or other devices.
* Digital Living Network Alliance
- **Printers**
Send images wirelessly to a PictBridge-compatible printer (supporting DPS over IP) to print them.
- **Another Camera**
Send images wirelessly between Wi-Fi-compatible Canon cameras.

Using Bluetooth® Features

You can easily pair the camera with a smartphone featuring Bluetooth low energy technology*. You can also shoot or view images by using your smartphone as a remote control.

* Hereafter referred to as “Bluetooth”.

Before Use

Basic Guide

Advanced Guide

Camera Basics

Auto Mode /
Hybrid Auto Mode

Other Shooting Modes

P Mode

Tv, Av, M, C1, and C2 Mode

Playback Mode

Wireless Features

Setting Menu

Accessories

Appendix

Index



Transferring Images to a Smartphone

Transfer images to a smartphone as follows.

- Connect via Bluetooth (📖128)
You can easily connect the camera to a Bluetooth enabled smartphone by pairing them. This simplifies transferring images to a smartphone.
- Connect via NFC (📖130)
Simply touch an NFC-compatible Android smartphone against the camera to connect the devices.
- Connect via the Wi-Fi menu (📖132)
You can connect the camera to a smartphone as you would connect it to a computer or other device. Multiple smartphones can be added.

Before connecting to the camera, you must install the free dedicated Camera Connect app on the smartphone. For details on this application (supported smartphones and included functions), refer to the Canon website.



- Canon Wi-Fi-compatible camera owners who use EOS Remote to connect their camera via Wi-Fi to a smartphone should consider switching to the Camera Connect mobile app.

Transferring Images to a Bluetooth Enabled Smartphone

Once you have paired with a smartphone via Bluetooth, simply operate your smartphone to view and save camera images.



1 Install Camera Connect.

- For Android smartphones, find Camera Connect in Google Play and download and install the app.
- For an iPhone or iPad, find Camera Connect in the App Store and download and install the app.

2 Register a nickname.

- Turn on the camera.
- Press the [MENU] button, choose [Wireless settings] on the [Y4] tab, and then choose [Nickname].
- Press the [Q] button to access the keyboard (📖37), and then enter a nickname.
- To return to [Wireless settings] after pressing the [MENU] button, press the [MENU] button again.

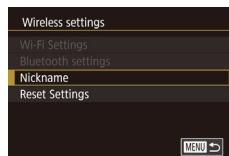

Before Use

Basic Guide

Advanced Guide

Camera Basics

Auto Mode /
Hybrid Auto Mode

Other Shooting Modes

P Mode

Tv, Av, M, C1, and C2 Mode

Playback Mode

Wireless Features

Setting Menu

Accessories

Appendix

Index



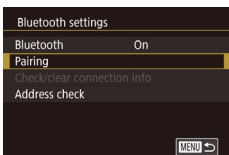

3 Prepare for pairing.

- Choose [Bluetooth settings], press the [▲][▼] buttons or turn the [DISP] dial to choose [Pairing], and then press the [DISP] button.

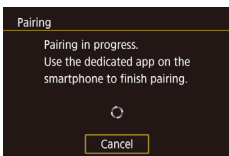

- A screen is displayed indicating that the camera is waiting to connect.



4 Start Camera Connect.

- Activate Bluetooth on the smartphone, and then start Camera Connect on the smartphone.
- After the camera is recognized, a camera selection screen is displayed.

5 Select the camera to connect to.

- Choose the camera nickname.
- Complete the pairing process for the smartphone.

6 Complete pairing.

- Press the [◀][▶] buttons or turn the [DISP] dial to choose [OK] after the confirmation message on the camera, and then press the [DISP] button.

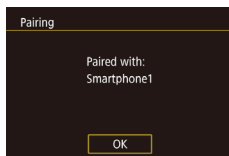
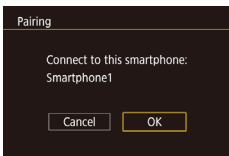

- Press the [DISP] button when the screen at left is displayed.

7 Transfer images.

- The camera will automatically switch to Wi-Fi if you choose [Images on camera] in Camera Connect.
- On an iPhone or iPad, in the device's Wi-Fi setting menu, choose the SSID (network name) displayed on the camera to establish a connection.
- Use the smartphone to transfer images from the camera to the smartphone.
- To switch to Bluetooth, disable the Wi-Fi connection on the smartphone.



- Battery life may be shorter when you use the camera after pairing, because power is consumed even when power saving is active.



- Bluetooth connection status is indicated by one of the following icons.
 - [DISP]: Connected, [DISP]: Disconnected
- You can also use the camera to disable Wi-Fi connection described in step 7.
- To disable Bluetooth communication, choose MENU (M35) > [W4] tab > [Wireless settings] > [Bluetooth settings] and set [Bluetooth] to [Off].
- To check the information of the smartphone connected via Bluetooth in [Check/clear connection info], choose MENU (M35) > [W4] tab > [Wireless settings] > [Bluetooth settings]. Choose [Address check] to check the camera's Bluetooth address.

Before Use

Basic Guide

Advanced Guide

Camera Basics

Auto Mode / Hybrid Auto Mode

Other Shooting Modes

P Mode

Tv, Av, M, C1, and C2 Mode

Playback Mode

Wireless Features

Setting Menu

Accessories

Appendix

Index



Transferring Images to an NFC-Compatible Smartphone

Use an Android smartphone's NFC to simplify the process of installing Camera Connect and connecting to the camera. Operation when devices are initially connected via NFC varies depending on the camera mode when the devices are touched together.

- If the camera is in Shooting mode when the devices are touched together, you can choose and send images on the image selection screen. Once the devices are connected, you can also shoot remotely while viewing a shooting screen on the smartphone, or geotag your shots (📖 149). It's easy to reconnect to recent devices, which are listed in the Wi-Fi menu.
- If the camera is in Playback mode when the devices are touched together, you can choose and send images from the index display shown for image selection.

Connecting via NFC When Camera Is in Shooting Mode

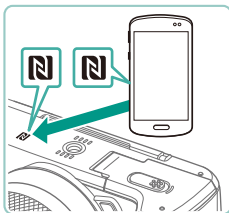

1 Install Camera Connect.

- Move the power switch to [ON].
- Refer to the smartphone user manual to check where the N-Mark (N) is located.
- Activate NFC on the smartphone and touch the devices' N-Marks (N) together to start Google Play on the smartphone automatically. Once the Camera Connect download page is displayed, download and install the app.

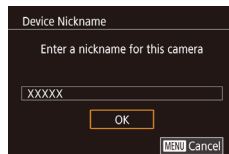

2 Establish the connection.

- Touch the N-Mark (N) on the smartphone with Camera Connect installed against the camera's N-Mark.
- The camera screen automatically changes.
- If the [Device Nickname] screen is displayed, press the [▲][▼] buttons or turn the [🌀] dial to choose [OK], and then press the [📷] button.
- Camera Connect starts up on the smartphone, and the devices are connected automatically.

3 Adjust the privacy setting.

- When this screen is displayed, press the [▲][▼] buttons or turn the [🌀] dial to choose [All images], and then press the [📷] button.
- You can now use the smartphone for remote live view shooting, or to browse, transfer, or geotag images on the camera.

Before Use

Basic Guide

Advanced Guide

Camera Basics

Auto Mode /
Hybrid Auto Mode

Other Shooting Modes

P Mode

Tv, Av, M, C1, and C2 Mode

Playback Mode

Wireless Features

Setting Menu

Accessories

Appendix

Index



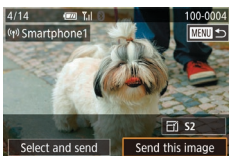

4 Send an image.

- Turn the [DISP] dial to choose an image to send, press the [◀][▶] buttons to choose [Send this image], and then press the [DISP] button.
- [Transfer completed] is displayed after the image is sent, and the image transfer screen is displayed again.
- To end the connection, press the [MENU] button, choose [OK] on the confirmation screen (either press the [◀][▶] buttons or turn the [DISP] dial), and then press the [DISP] button. You can also use the smartphone to end the connection.



- When using NFC, keep the following points in mind.
 - Avoid strong impact between the camera and smartphone. This may damage the devices.
 - Depending on the smartphone, the devices may not recognize each other immediately. In this case, try holding the devices together in slightly different positions. If connection is not established, keep the devices together until the camera screen is updated.
 - Do not place other objects between the camera and smartphone. Also, note that camera or smartphone covers or similar accessories may block communication.
- For remote live view shooting, choose [All images] in step 3.
- All images in the camera can be viewed from the connected smartphone when you choose [All images] in step 3. To restrict camera images that can be viewed from the smartphone, choose a different option in step 3 (152). Once you have registered a smartphone, you can change privacy settings for it on the camera (152).



- Connections require that a memory card be in the camera.
- You can also change the camera nickname on the screen in step 2 (153).
- To disable NFC connections, choose MENU (35) > [4] tab > [Wireless settings] > [Wi-Fi Settings] > [NFC] > [Off].

Connecting via NFC When Camera Is in Playback Mode



- Move the power switch to [ON].
- Press the [▶] button.
- Touch the smartphone with Camera Connect installed (130) against the camera's N-Mark (N).
- Press the [▲][▼][◀][▶] buttons to choose an image to send, and then press the [DISP] button. [✓] is displayed.
- To cancel selection, press the [DISP] button again. [✓] is no longer displayed.
- Repeat this process to choose additional images.
- After you finish choosing images, press the [MENU] button.
- Press the [◀][▶] buttons or turn the [DISP] dial to choose [OK], and then press the [DISP] button.
- Press the [◀][▶] buttons or turn the [DISP] dial to choose [Send], and then press the [DISP] button.
- The images are now sent.
- To end the connection, clear [✓] from all images, press the [MENU] button, and then press the [◀][▶] buttons or turn the [DISP] dial to choose [OK].

Before Use

Basic Guide

Advanced Guide

Camera Basics

Auto Mode / Hybrid Auto Mode

Other Shooting Modes

P Mode

Tv, Av, M, C1, and C2 Mode

Playback Mode

Wireless Features

Setting Menu

Accessories

Appendix

Index





- If during connection a message on the camera or smartphone requests you to enter the nickname, follow step 2 in "Connecting via NFC When Camera Is in Shooting Mode" (130) to enter it.
- The camera does not keep a record of smartphones you connect to via NFC in Playback mode.

Connecting to a Smartphone via the Wi-Fi Menu

These steps show how to use the camera as an access point, but you can also use an existing access point (134).



1 Install Camera Connect.

- For Android smartphones, find Camera Connect in Google Play and download and install the app.
- For an iPhone or iPad, find Camera Connect in the App Store and download and install the app.



2 Access the Wi-Fi menu.

- Move the power switch to [ON].
- Press the [(Wi-Fi)] button.
- If the [Device Nickname] screen is displayed, press the [▲][▼] buttons or turn the [DIAL] dial to choose [OK], and then press the [(Wi-Fi)] button.

3 Choose [Wi-Fi].

- Press the [▲][▼][◀][▶] buttons or turn the [DIAL] dial to choose [Wi-Fi], and then press the [(Wi-Fi)] button.

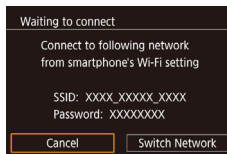

4 Choose [Add a Device].

- Press the [▲][▼] buttons or turn the [DIAL] dial to choose [Add a Device], and then press the [(Wi-Fi)] button.

- The camera SSID and password are displayed.

5 Connect the smartphone to the network.

- In the smartphone's Wi-Fi setting menu, choose the SSID (network name) displayed on the camera to establish a connection.
- In the password field, enter the password displayed on the camera.

6 Start Camera Connect.

- Start Camera Connect on the smartphone.

7 Choose the camera to connect to.

- On the camera selection screen displayed on the smartphone, choose the camera to begin pairing.

Before Use

Basic Guide

Advanced Guide

Camera Basics

Auto Mode / Hybrid Auto Mode

Other Shooting Modes

P Mode

Tv, Av, M, C1, and C2 Mode

Playback Mode

Wireless Features

Setting Menu

Accessories

Appendix

Index



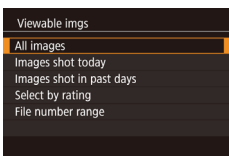

8 Adjust the privacy setting.

- When this screen is displayed, press the [▲][▼] buttons or turn the [●] dial to choose [All images], and then press the [●] button.
- You can now use the smartphone for remote live view shooting, or to browse, import, or geotag images on the camera.

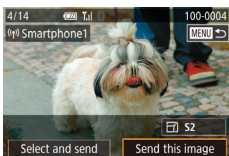

9 Send an image.

- Turn the [●] dial to choose an image to send, press the [◀][▶] buttons to choose [Send this image], and then press the [●] button.
- [Transfer completed] is displayed after the image is sent, and the image transfer screen is displayed again.
- To end the connection, press the [MENU] button, choose [OK] on the confirmation screen (either press the [◀][▶] buttons or turn the [●] dial), and then press the [●] button. You can also use the smartphone to end the connection.



- For remote live view shooting, choose [All images] in step 8.
- All images in the camera can be viewed from the connected smartphone when you choose [All images] in step 8. To restrict camera images that can be viewed from the smartphone, choose a different option in step 8 (152). Once you have registered a smartphone, you can change privacy settings for it on the camera (152).



- Connections require that a memory card be in the camera.
- You can also change the camera nickname on the screen in step 2 (153).
- You can also access the screen in step 3 by choosing MENU (35) > [4] tab > [Wi-Fi connect'n].
- To connect without entering a password in step 5, choose MENU (35) > [4] tab > [Wireless settings] > [Wi-Fi Settings] > [Password] > [Off]. [Password] is no longer displayed on the SSID screen (in step 4).
- Once you have connected to devices, recent destinations will be listed first when you access the Wi-Fi menu. You can easily connect again by pressing the [▲][▼] buttons to choose the device and then pressing the [●] button. To add a new device, display the device selection screen by pressing the [◀][▶] buttons, and then configure the setting.
- If you prefer not to display recent target devices, choose MENU (35) > [4] tab > [Wireless settings] > [Wi-Fi Settings] > [Target History] > [Off].

Before Use

Basic Guide

Advanced Guide

Camera Basics

Auto Mode /
Hybrid Auto Mode

Other Shooting Modes

P Mode

Tv, Av, M, C1, and C2 Mode

Playback Mode

Wireless Features

Setting Menu

Accessories

Appendix

Index



Using Another Access Point

When connecting the camera to a smartphone through the Wi-Fi menu, you can also use an existing access point. Also refer to the access point user manual.

Confirming Access Point Compatibility

Confirm that the Wi-Fi router or base station conforms to the Wi-Fi standards in “Interface” (📖216).

Connection methods vary depending on whether the access point supports Wi-Fi Protected Setup (WPS, 📖134) or not (📖135).

For non-WPS access points, check the following information.

- Network name (SSID/ESSID)
The SSID or ESSID for the access point you use. Also called the “access point name” or “network name”.
- Network authentication / data encryption (encryption method / encryption mode)
The method for encrypting data during wireless transmission. Check which security setting is used: WPA2-PSK (AES), WPA2-PSK (TKIP), WPA-PSK (AES), WPA-PSK (TKIP), WEP (open system authentication), or no security.
- Password (encryption key / network key)
The key used when encrypting data during wireless transmission. Also called the “encryption key” or “network key”.
- Key index (transmit key)
The key set when WEP is used for network authentication / data encryption. Use “1” as the setting.



- If system administrator status is needed to adjust network settings, contact the system administrator for details.
- These settings are very important for network security. Exercise adequate caution when changing these settings.



- For information on WPS compatibility and for instructions on checking settings, refer to the access point user manual.
- A router is a device that creates a network (LAN) structure for connecting multiple computers. A router that contains an internal Wi-Fi function is called a “Wi-Fi router”.
- This guide refers to all Wi-Fi routers and base stations as “access points”.
- If you use MAC address filtering on your Wi-Fi network, be sure to add the camera’s MAC address to your access point. You can check your camera’s MAC address by choosing MENU (📖35) > [🔑4] tab > [Wireless settings] > [Wi-Fi Settings] > [Check MAC Address].

Using WPS-Compatible Access Points

WPS makes it easy to complete settings when connecting devices over Wi-Fi. You can use either Push Button Configuration Method or PIN Method for settings on a WPS supported device.



1 Connect the smartphone to the access point.

2 Prepare for the connection.

- Access the [Waiting to connect] screen by following steps 1 – 4 in “Connecting to a Smartphone via the Wi-Fi Menu” (📖132).

3 Choose [Switch Network].

- Press the [◀][▶] buttons or turn the [🌀] dial to choose [Switch Network], and then press the [🔑] button.
- A list of detected access points will be displayed.

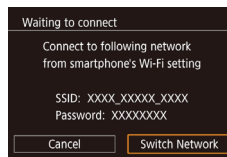

Before Use

Basic Guide

Advanced Guide

Camera Basics

Auto Mode / Hybrid Auto Mode

Other Shooting Modes

P Mode

Tv, Av, M, C1, and C2 Mode

Playback Mode

Wireless Features

Setting Menu

Accessories

Appendix

Index



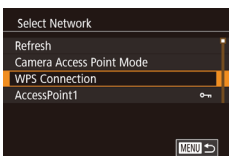

4 Choose [WPS Connection].

- Press the [▲][▼] buttons or turn the [📶] dial to choose [WPS Connection], and then press the [📶] button.

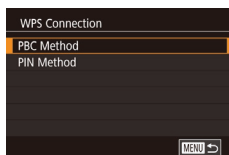

5 Choose [PBC Method].

- Press the [▲][▼] buttons or turn the [📶] dial to choose [PBC Method], and then press the [📶] button.

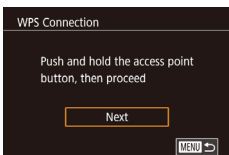

6 Establish the connection.

- On the access point, hold down the WPS connection button for a few seconds.
- On the camera, press the [📶] button to go to the next step.

7 Send the images.

- Follow steps 6 – 9 in “Connecting to a Smartphone via the Wi-Fi Menu” (📖132) to choose the smartphone, adjust the privacy setting, and send the images.



- If you chose [PIN Method] in step 5, a PIN code will be displayed on the screen. Be sure to set this code in the access point. Choose a device in the [Select a Device] screen. For further details, refer to the user manual included with your access point.

Connecting to Listed Access Points

1 View the listed access points.

- View the listed networks (access points) as described in steps 1 – 3 of “Using WPS-Compatible Access Points” (📖134).

2 Choose an access point.

- Press the [▲][▼] buttons or turn the [📶] dial to choose a network (access point), and then press the [📶] button.

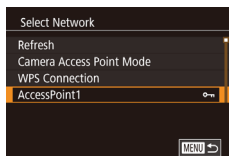

3 Enter the access point password.

- Press the [📶] button to access the keyboard, and then enter the password (📖37).
- Press the [▲][▼] buttons or turn the [📶] dial to choose [Next], and then press the [📶] button.

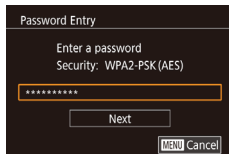

4 Choose [Auto].

- Press the [▲][▼] buttons or turn the [📶] dial to choose [Auto], and then press the [📶] button.

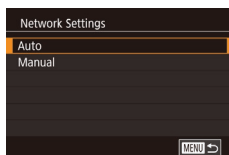

5 Send the images.

- Follow steps 6 – 9 in “Connecting to a Smartphone via the Wi-Fi Menu” (📖132) to choose the smartphone, adjust the privacy setting, and send the images.

Before Use

Basic Guide

Advanced Guide

Camera Basics

Auto Mode / Hybrid Auto Mode

Other Shooting Modes

P Mode

Tv, Av, M, C1, and C2 Mode

Playback Mode

Wireless Features

Setting Menu

Accessories

Appendix

Index





- To determine the access point password, check on the access point itself or refer to the user manual.
- If no access points are detected even after you choose [Refresh] in step 2 to update the list, choose [Manual Settings] in step 2 to complete access point settings manually. Follow on-screen instructions and enter an SSID, security settings, and a password.
- Passwords of access points you have already connected to are displayed as [*] in step 3. To use the same password, choose [Next] (either press the [▲][▼] buttons or turn the [DIAL] and press the [OK] button).

Previous Access Points

You can reconnect to any previous access points automatically by following step 4 in “Connecting to a Smartphone via the Wi-Fi Menu” (132).

- To use the camera as an access point, choose [Switch Network] on the screen displayed when you establish a connection, and then choose [Camera Access Point Mode].
- To switch access points, choose [Switch Network] on the screen displayed when you establish a connection, and then either follow the procedure in “Using WPS-Compatible Access Points” (134) from step 4 or the procedure in “Connecting to Listed Access Points” (135) from step 2.

Sending Images to a Registered Web Service

Registering Web Services

Use a smartphone or computer to add to the camera Web services that you want to use.

- A smartphone or computer with a browser and Internet connection is required to complete camera settings for CANON iMAGE GATEWAY and other Web services.
- Check the CANON iMAGE GATEWAY website for details on browser (Microsoft Internet Explorer, etc.) requirements, including settings and version information.
- For information on countries and regions where CANON iMAGE GATEWAY is available, visit the Canon website (<http://www.canon.com/cig/>).
- For CANON iMAGE GATEWAY instructions and setting details, refer to the help information for CANON iMAGE GATEWAY.
- You must have an account with Web services other than CANON iMAGE GATEWAY if you desire to use them. For further details, check the websites for each Web service you want to register.
- Separate ISP connection and access point fees may be applicable.



- CANON iMAGE GATEWAY also provides user guides for downloading.

Before Use

Basic Guide

Advanced Guide

Camera Basics

Auto Mode /
Hybrid Auto Mode

Other Shooting Modes

P Mode

Tv, Av, M, C1, and C2 Mode

Playback Mode

Wireless Features

Setting Menu

Accessories

Appendix

Index



Registering CANON IMAGE GATEWAY

Link the camera and CANON IMAGE GATEWAY by adding CANON IMAGE GATEWAY as a destination Web service on the camera. Note that you will need to enter an email address used on your computer or smartphone to receive a notification message for completing linkage settings.



1 Access the Wi-Fi menu.

- Move the power switch to [ON].
- Press the [Wi-Fi] button.
- If the [Device Nickname] screen is displayed, press the [▲][▼] buttons or turn the [DISP.] dial to choose [OK], and then press the [MENU] button.

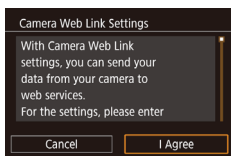
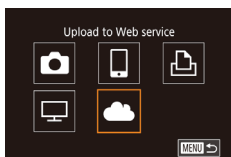
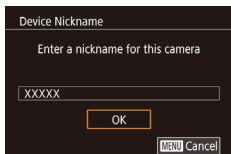

2 Choose [Cloud].

- Press the [▲][▼][◀][▶] buttons or turn the [DISP.] dial to choose [Cloud], and then press the [MENU] button.

3 Accept the agreement to enter an email address.

- Read the agreement displayed, press the [◀][▶] buttons or turn the [DISP.] dial to choose [I Agree], and then press the [MENU] button.

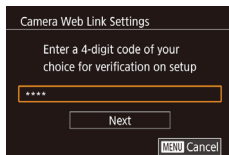
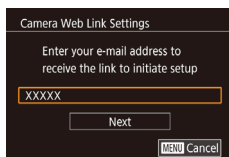
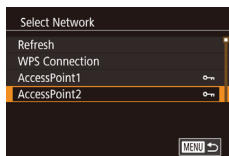

4 Establish a connection with an access point.

- Connect to the access point as described in steps 4 – 6 in “Using WPS-Compatible Access Points” (📖134) or in steps 2 – 4 in “Connecting to Listed Access Points” (📖135).

5 Enter your email address.

- Once the camera is connected to CANON IMAGE GATEWAY via the access point, a screen is displayed for entering an email address.
- Enter your email address, press the [▲][▼] buttons or turn the [DISP.] dial to choose [Next], and then press the [MENU] button.

6 Enter a four-digit number.

- Enter a four-digit number of your choice, press the [▲][▼] buttons or turn the [DISP.] dial to choose [Next], and then press the [MENU] button.
- You will need this four-digit number later when setting up linkage with CANON IMAGE GATEWAY in step 8.

Before Use

Basic Guide

Advanced Guide

Camera Basics

Auto Mode / Hybrid Auto Mode

Other Shooting Modes

P Mode

Tv, Av, M, C1, and C2 Mode

Playback Mode

Wireless Features

Setting Menu

Accessories

Appendix

Index



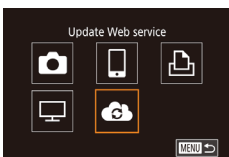
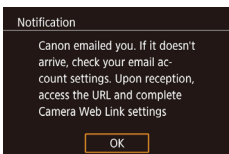

7 Check for the notification message.

- Once information has been sent to CANON iMAGE GATEWAY, you will receive a notification message at the email address entered in step 5.
- Press the [OK] button on the next screen, which indicates that notification has been sent.
- [Cloud] now changes to [Cloud with camera icon].

8 Access the page in the notification message and complete camera link settings.

- From a computer or smartphone, access the page linked in the notification message.
- Follow the instructions to complete the settings on the camera link settings page.

9 Complete CANON iMAGE GATEWAY settings on the camera.

- Press the [▲][▼][◀][▶] buttons or turn the [DIAL] dial to choose [Cloud with camera icon], and then press the [OK] button.
- [Camera icon] (147) and CANON iMAGE GATEWAY are now added as destinations.
- You can add other Web services, as needed. In this case, follow the instructions from step 2 in "Registering Other Web Services" (138).



- Make sure initially that your computer or smartphone mail application is not configured to block email from relevant domains, which may prevent you from receiving the notification message.



- You can also change the camera nickname on the screen in step 1 (153).
- Once you have connected to devices via the Wi-Fi menu, recent destinations will be listed first when you access the menu. Press the [◀][▶] buttons to access the device selection screen and then configure the setting.

Registering Other Web Services

You can also add Web services besides CANON iMAGE GATEWAY to the camera.



1 Log in to CANON iMAGE GATEWAY and access the camera link settings page.

- From a computer or smartphone, access <http://www.canon.com/cig/> to visit CANON iMAGE GATEWAY.



2 Configure the Web service you want to use.

- Follow the instructions displayed on the smartphone or computer to set up the Web service.

Before Use

Basic Guide

Advanced Guide

Camera Basics

Auto Mode /
Hybrid Auto Mode

Other Shooting Modes

P Mode

Tv, Av, M, C1, and C2 Mode

Playback Mode

Wireless Features

Setting Menu

Accessories

Appendix

Index



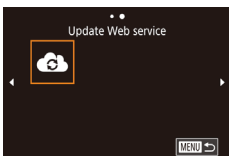

3 Choose [Wi-Fi].

- Press the [Wi-Fi] button.
- Press the [▲][▼][◀][▶] buttons or turn the [Q] dial to choose [Wi-Fi], and then press the [Q] button.
- The Web service settings are now updated.



- If any configured settings change, follow these steps again to update the camera settings.

Uploading Images to Web Services



1 Access the Wi-Fi menu.

- Move the power switch to [ON].
- Press the [Wi-Fi] button.



2 Choose the destination.

- Choose the icon of the Web service to connect to (either press the [▲][▼][◀][▶] buttons or turn the [Q] dial), and then press the [Q] button.
- If multiple recipients or sharing options are used with a Web service, choose the desired item on the [Select Recipient] screen (either press the [▲][▼] buttons or turn the [Q] dial), and then press the [Q] button.

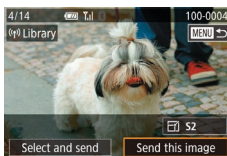

3 Send an image.

- Turn the [Q] dial to choose an image to send, press the [◀][▶] buttons to choose [Send this image], and then press the [Q] button.
- When uploading to YouTube, read the terms of service, choose [I Agree], and press the [Q] button.
- Press the [Q] button to return to the playback screen once [OK] is displayed after the image is sent.



- Connections require that a memory card with saved images be in the camera.
- You can also send multiple images at once, resize images, and add comments before sending (144).
- To view images uploaded to CANON iMAGE GATEWAY on a smartphone, try the dedicated Canon Online Photo Album app. Download and install the Canon Online Photo Album app for iPhones or iPads from the App Store or for Android devices from Google Play.

Before Use

Basic Guide

Advanced Guide

Camera Basics

Auto Mode /
Hybrid Auto Mode

Other Shooting Modes

P Mode

Tv, Av, M, C1, and C2 Mode

Playback Mode

Wireless Features

Setting Menu

Accessories

Appendix

Index



Viewing Images Using a Media Player

View images on the camera's memory card on a TV or other device. This feature requires a DLNA-compatible TV set or other media player, such as a game system or smartphone. In this manual, the term "media player" is used to refer to any such device. Follow these instructions only after the media player is connected to an access point. For relevant instructions, refer to the device's user manual.



1 Access the Wi-Fi menu.

- Move the power switch to [ON].
- Press the [Wi-Fi] button.



2 Choose [Media Player].

- Press the [Up][Down][Left][Right] buttons or turn the [Dial] dial to choose [Media Player], and then press the [OK] button.

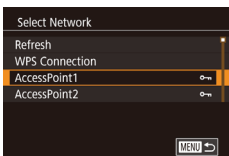

3 Establish a connection with an access point.

- Connect to the access point as described in steps 4 – 6 in "Using WPS-Compatible Access Points" (134) or in steps 2 – 4 in "Connecting to Listed Access Points" (135).

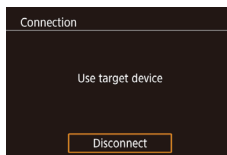

- Once the camera is ready for the media player connection, this screen is displayed. The screen will be dimmed after a while.
- After the devices are connected, use the media player to view images. For details, refer to the media player's user manual.

4 Display the media player settings screen on your TV set.

- On the media player, display [Canon EOS M5].
- A different icon may be displayed depending on the media player. Find an icon labeled [Canon EOS M5].

5 Display images.

- Choose [Canon EOS M5] > memory card (SD or other card) > folder > images.
- Select an image to display it on the media player. For details, refer to the media player's user manual.
- When finished, press the [OK] button on the camera to end the connection. If the screen is dimmed, press any button. Once the second screen in step 3 is displayed, press the [OK] button.

Before Use

Basic Guide

Advanced Guide

Camera Basics

Auto Mode / Hybrid Auto Mode

Other Shooting Modes

P Mode

Tv, Av, M, C1, and C2 Mode

Playback Mode

Wireless Features

Setting Menu

Accessories

Appendix

Index





- Connections require that a memory card with saved images be in the camera.
- Once you have connected to devices via the Wi-Fi menu, recent destinations will be listed first when you access the Wi-Fi menu. You can easily connect again by pressing the [▲][▼] buttons to choose the device and then pressing the [OK] button. To add a new device, display the device selection screen by pressing the [◀][▶] buttons, and then configure the setting.
- Past media player connections are listed as "MediaServ."
- RAW images and movies are not displayed.
- Information overlay and details displayed on the TV set vary depending on the media player. Some media players may not display image information, or may display vertical images horizontally.
- Icons labeled with a range of numbers such as "1-100" contain images grouped by file number in the selected folder.
- Dates shown for cards or folders may be the date on the camera when last viewed.

Printing Images Wirelessly from a Connected Printer

Connect the camera to a printer via Wi-Fi to print as follows. These steps show how to use the camera as an access point, but you can also use an existing access point (134).

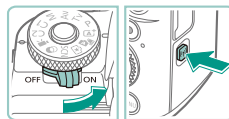

1 Access the Wi-Fi menu.

- Move the power switch to [ON].
- Press the [Wi-Fi] button.



2 Choose [Print].

- Press the [▲][▼][◀][▶] buttons or turn the [DISP] dial to choose [Print], and then press the [OK] button.



3 Choose [Add a Device].

- Press the [▲][▼] buttons or turn the [DISP] dial to choose [Add a Device], and then press the [OK] button.
- The camera SSID and password are displayed.

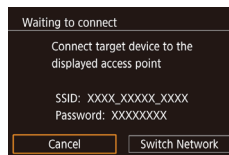

Before Use

Basic Guide

Advanced Guide

Camera Basics

Auto Mode / Hybrid Auto Mode

Other Shooting Modes

P Mode

Tv, Av, M, C1, and C2 Mode

Playback Mode

Wireless Features

Setting Menu

Accessories

Appendix

Index



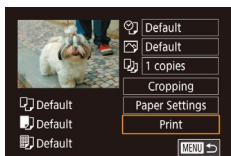

4 Connect the printer to the network.

- In the printer's Wi-Fi setting menu, choose the SSID (network name) displayed on the camera to establish a connection.

5 Choose the printer.

- Choose the printer name (either press the [▲][▼] buttons or turn the [●] dial), and then press the [●] button.

6 Choose an image to print.

- Press the [◀][▶] buttons or turn the [●] dial to choose an image.
- Press the [●] button, choose [Print], and press the [●] button again.
- Press the [▲][▼] buttons or turn the [●] dial to choose [Print], and then press the [●] button.
- For detailed printing instructions, see “Printing Images” (178).
- To end the connection, press the [▲] button, choose [OK] on the confirmation screen (either press the [◀][▶] buttons or turn the [●] dial), and then press the [●] button.



- Connections require that a memory card with saved images be in the camera.
- Once you have connected to devices via the Wi-Fi menu, recent destinations will be listed first when you access the Wi-Fi menu. You can easily connect again by pressing the [▲][▼] buttons to choose the device and then pressing the [●] button. To add a new device, display the device selection screen by pressing the [◀][▶] buttons, and then configure the setting.
- If you prefer not to display recent target devices, choose MENU (35) > [4] tab > [Wireless settings] > [Wi-Fi Settings] > [Target History] > [Off].
- When using another access point, see “Using Another Access Point” (134).

Before Use

Basic Guide

Advanced Guide

Camera Basics

Auto Mode / Hybrid Auto Mode

Other Shooting Modes

P Mode

Tv, Av, M, C1, and C2 Mode

Playback Mode

Wireless Features

Setting Menu

Accessories

Appendix

Index



Sending Images to Another Camera

Connect two cameras via Wi-Fi and send images between them as follows.

- Only Wi-Fi compatible Canon cameras can be connected via Wi-Fi. You cannot connect to a Canon camera unless it is Wi-Fi compatible, even if it supports FlashAir/Eye-Fi cards.

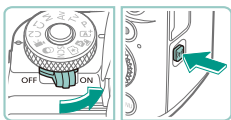

1 Access the Wi-Fi menu.

- Move the power switch to [ON].
- Press the [Wi-Fi] button.

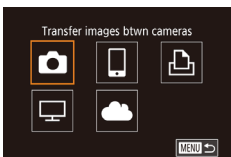

2 Choose [Camera].

- Press the [Up][Down][Left][Right] buttons or turn the [Mode] dial to choose [Camera], and then press the [OK] button.



3 Choose [Add a Device].

- Press the [Up][Down] buttons or turn the [Mode] dial to choose [Add a Device], and then press the [OK] button.
- Follow steps 1 – 3 on the target camera too.
- Camera connection information will be added when [Start connection on target camera] is displayed on both camera screens.

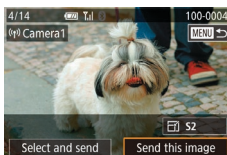

4 Send an image.

- Turn the [Mode] dial to choose an image to send, press the [Left][Right] buttons to choose [Send this image], and then press the [OK] button.
- [Transfer completed] is displayed after the image is sent, and the image transfer screen is displayed again.
- To end the connection, press the [MENU] button, choose [OK] on the confirmation screen (either press the [Left][Right] buttons or turn the [Mode] dial), and then press the [OK] button.



- Connections require that a memory card be in the camera.
- Once you have connected to devices via the Wi-Fi menu, recent destinations will be listed first when you access the Wi-Fi menu. You can easily connect again by pressing the [Up][Down] buttons to choose the device and then pressing the [OK] button. To add a new device, display the device selection screen by pressing the [Left][Right] buttons, and then configure the setting.
- If you prefer not to display recent target devices, choose MENU (35) > [4] tab > [Wireless settings] > [Wi-Fi Settings] > [Target History] > [Off].
- You can also send multiple images at once and change the image size before sending (144).

Before Use

Basic Guide

Advanced Guide

Camera Basics

Auto Mode / Hybrid Auto Mode

Other Shooting Modes

P Mode

Tv, Av, M, C1, and C2 Mode

Playback Mode

Wireless Features

Setting Menu

Accessories

Appendix

Index



Image Sending Options

You can choose multiple images to send at once and change the image recording pixel setting (size) before sending. Some Web services also enable you to annotate the images you send.

Sending Multiple Images

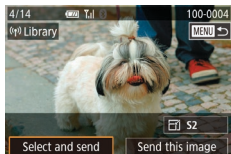

1 Choose [Select and send].

- On the image transfer screen, press the [◀][▶] buttons to choose [Select and send], and then press the [OK] button.

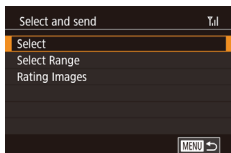

2 Choose a selection method.

- Press the [▲][▼] buttons or turn the [DISP] dial to choose a selection method.

Choosing Images Individually

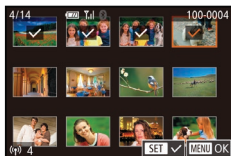

1 Choose [Select].

- Following step 2 in “Sending Multiple Images” (p. 144), choose [Select] and press the [OK] button.

2 Choose an image.

- Press the [▲][▼][◀][▶] buttons to choose an image to send, and then press the [OK] button. [✓] is displayed.
- To cancel selection, press the [DISP] button again. [✓] is no longer displayed.
- Repeat this process to choose additional images.
- After you finish choosing images, press the [MENU] button.
- Press the [◀][▶] buttons or turn the [DISP] dial to choose [OK], and then press the [OK] button.

3 Send the images.

- Press the [◀][▶] buttons or turn the [DISP] dial to choose [Send], and then press the [OK] button.



- You can also choose images in step 2 by turning the [DISP] dial counterclockwise to access single-image display and then pressing the [◀][▶] buttons or turning the [DISP] dial.

Before Use

Basic Guide

Advanced Guide

Camera Basics

Auto Mode /
Hybrid Auto Mode

Other Shooting Modes

P Mode

Tv, Av, M, C1, and C2 Mode

Playback Mode

Wireless Features

Setting Menu

Accessories

Appendix

Index



Selecting a Range

1 Choose [Select Range].

- Following step 2 in “Sending Multiple Images” (📖 144), choose [Select Range] and press the [OK] button.

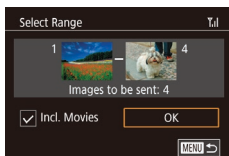

2 Choose images.

- Follow steps 2 – 3 in “Selecting a Range” (📖 113) to specify images.
- To include movies, press the [▲][▼][◀][▶] buttons to choose [Incl. Movies], and then press the [OK] button to mark the option as selected (✓).
- Press the [▲][▼][◀][▶] buttons to choose [OK], and then press the [OK] button.

3 Send the images.

- Press the [◀][▶] buttons or turn the [DISP] dial to choose [Send], and then press the [OK] button.

Sending Rated Images

Send multiple images with the same rating (📖 117).

1 Choose [Rating Images].

- Following step 2 in “Sending Multiple Images” (📖 144), choose [Rating Images] and press the [OK] button.
- Press the [▲][▼] buttons or turn the [DISP] dial to choose a rating, and then press the [OK] button. An image selection screen is displayed that includes only images with that rating.
- You can also remove images from the group to send, by choosing an image and pressing the [OK] button to clear the [✓] mark.
- After you finish choosing images, press the [MENU] button.
- Press the [◀][▶] buttons or turn the [DISP] dial to choose [OK], and then press the [OK] button.

2 Send the images.

- Press the [◀][▶] buttons or turn the [DISP] dial to choose [Send], and then press the [OK] button.

Before Use

Basic Guide

Advanced Guide

Camera Basics

Auto Mode /
Hybrid Auto Mode

Other Shooting Modes

P Mode

Tv, Av, M, C1, and C2 Mode

Playback Mode

Wireless Features

Setting Menu

Accessories

Appendix

Index



Notes on Sending Images

- Depending on the condition of the network you are using, it may take a long time to send movies. Be sure to keep an eye on the camera battery level.
- Web services may limit the number of images or length of movies you can send.
- When sending movies to smartphones, note that the supported image quality varies depending on the smartphone. For details, refer to the smartphone user manual.
- On the screen, wireless signal strength is indicated by the following icons.
[Y] high, [Y] medium, [Y] low, [Y] weak
- Sending images to Web services will take less time when resending images you have already sent that are still on the CANON iIMAGE GATEWAY server.

Choosing the Number of Recording Pixels (Image Size)

On the image transfer screen, choose [F] by pressing the [▲][▼] buttons, and then press the [G] button. On the screen displayed, choose the recording pixel setting (image size) (either press the [▲][▼] buttons or turn the [D] dial) and press the [G] button.

- To send images at original size, select [No] as the resizing option.
- Choosing [S2] will resize images that are larger than the selected size before sending.
- Movies cannot be resized.

Adding Comments

Using the camera, you can add comments to images that you send to e-mail addresses, social networking services, etc. The number of characters and symbols that can be entered may differ depending on the Web service.

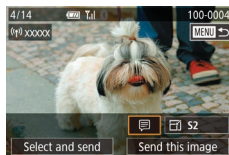

1 Access the screen for adding comments.

- On the image transfer screen, choose [F] by pressing the [▲][▼][◀][▶] buttons, and then press the [G] button.

2 Add a comment (37).

3 Send the image.



- When a comment is not entered, the comment set in CANON iIMAGE GATEWAY is automatically sent.
- You can also annotate multiple images before sending them. The same comment is added to all images sent together.

Before Use

Basic Guide

Advanced Guide

Camera Basics

Auto Mode / Hybrid Auto Mode

Other Shooting Modes

P Mode

Tv, Av, M, C1, and C2 Mode

Playback Mode

Wireless Features

Setting Menu

Accessories

Appendix

Index



Sending Images Automatically (Image Sync)

Images on the memory card that have not been transferred already can be sent to a computer or Web services via CANON IMAGE GATEWAY. Note that images cannot be sent only to Web services.

Initial Preparations

Preparing the Camera

Register [📷] as the destination. On the destination computer, you will install and configure Image Transfer Utility, free software compatible with Image Sync.



1 Add [📷] as a destination.

- Add [📷] as a destination, as described in “Registering CANON IMAGE GATEWAY” (📖137).
- To include a Web service as the destination, log in to CANON IMAGE GATEWAY (📖136), select your camera model, access the Web service settings screen, and choose the destination Web service in Image Sync settings. For details, refer to CANON IMAGE GATEWAY Help.

Preparing the Computer

Install and configure the software on the destination computer.



1 Install Image Transfer Utility.

- Install Image Transfer Utility on a computer connected to the Internet (📖176).
- Image Transfer Utility can also be downloaded from the Image Sync settings page of CANON IMAGE GATEWAY (📖147).

2 Register the camera.

- Windows: In the taskbar, right-click [📷], and then click [Add new camera].
- Mac OS: In the menu bar, click [📷], and then click [Add new camera].
- A list of cameras linked to CANON IMAGE GATEWAY is displayed. Choose the camera from which images are to be sent.
- Once the camera is registered and the computer is ready to receive images, the icon changes to [📷].

2 Choose the type of images to send (only when sending movies with images).

- Press the [MENU] button, choose [Wireless settings] on the [📷] tab, and then choose [Wi-Fi Settings] (📖35).
- Press the [▲][▼] buttons to choose [Image Sync], and then choose [Stills/Movies] (📖35).

Before Use

Basic Guide

Advanced Guide

Camera Basics

Auto Mode /
Hybrid Auto Mode

Other Shooting Modes

P Mode

Tv, Av, M, C1, and C2 Mode

Playback Mode

Wireless Features

Setting Menu

Accessories

Appendix

Index



Sending Images

Images sent from the camera are automatically saved to the computer. If the computer that you intend to send images to is turned off, the images will be stored temporarily on the CANON iIMAGE GATEWAY server. Stored images are regularly erased, so make sure to turn on the computer and save the images.

1 Send images.

- Follow steps 1 – 2 in “Uploading Images to Web Services” (📖139) and choose [📧].
- Sent images are labeled with a [📧] icon.

2 Save the images to the computer.

- Images are automatically saved to the computer when you turn it on.
- Images are automatically sent to Web services from the CANON iIMAGE GATEWAY server, even if the computer is off.



- When sending images, you should use a fully charged battery pack or an AC adapter kit (sold separately, 📖167).



- Even if images were imported to the computer through a different method, any images not sent to the computer via CANON iIMAGE GATEWAY will be sent to the computer.
- Sending is faster when the destination is a computer on the same network as the camera, because images are sent via the access point instead of CANON iIMAGE GATEWAY. Note that images stored on the computer are sent to CANON iIMAGE GATEWAY, so the computer must be connected to the Internet.

Viewing Images Sent via Image Sync on a Smartphone

By installing the Canon Online Photo Album (Canon OPA) app, you can use your smartphone to view and download images sent via Image Sync while they are stored temporarily on the CANON iIMAGE GATEWAY server.

In preparation, enable smartphone access as follows.

- Make sure you have completed the settings described in “Preparing the Computer” (📖147).
- Download and install the Canon Online Photo Album app for iPhones or iPads from the App Store or for Android devices from Google Play.
- Log in to CANON iIMAGE GATEWAY (📖136), select your camera model, access the Web service settings screen, and enable viewing and downloading from a smartphone in the Image Sync settings. For details, refer to CANON iIMAGE GATEWAY Help.



- Once images stored temporarily on the CANON iIMAGE GATEWAY server have been deleted, they can no longer be viewed.
- Images you sent before enabling smartphone viewing and downloading in Image Sync settings cannot be accessed this way.



- For Canon Online Photo Album instructions, refer to Canon Online Photo Album Help.

Before Use

Basic Guide

Advanced Guide

Camera Basics

Auto Mode /
Hybrid Auto Mode

Other Shooting Modes

P Mode

Tv, Av, M, C1, and C2 Mode

Playback Mode

Wireless Features

Setting Menu

Accessories

Appendix

Index



Using a Smartphone to View Camera Images and Control the Camera

You can do the following with the dedicated smartphone app Camera Connect.

- Browse images on the camera and save them to the smartphone
- Geotag images on the camera (📖149)
- Control the camera remotely from a smartphone (📖149)



- In camera settings, the smartphone must be allowed to view camera images (📖132, 📖151).

Geotagging Images on the Camera

GPS data recorded on a smartphone using the dedicated Camera Connect application can be added to images on the camera. Images are tagged with information including the latitude, longitude, and elevation.



- Before shooting, make sure the date and time and your home time zone are set correctly, as described in “Setting the Date and Time” (📖21). Also follow the steps in “World Clock” (📖159) to specify any shooting destinations in other time zones.
- Others may be able to locate or identify you by using location data in your geotagged still images or movies. Be careful when sharing these images with others, as when posting images online where many others can view them.

Controlling the Camera Remotely from a Smartphone

Controlling the Camera via Wi-Fi

You can shoot as you view a shooting screen on your smartphone.



- Privacy settings must be configured in advance to allow viewing of all images from the smartphone (📖152).

1 Secure the camera.

- Keep the camera still by mounting it on a tripod or taking other measures.

2 Connect the camera and smartphone (📖132).

- In the privacy settings, choose [All images].

3 Choose remote live view shooting.

- In Camera Connect on the smartphone, choose [Remote live view shooting].
- Once the camera is ready for remote live view shooting, a live image from the camera is displayed on the smartphone.
- At this time, a message is displayed on the camera, and all camera operations except using the power switch are disabled.

4 Shoot.

- Use the smartphone to shoot.

Before Use

Basic Guide

Advanced Guide

Camera Basics

Auto Mode /
Hybrid Auto Mode

Other Shooting Modes

P Mode

Tv, Av, M, C1, and C2 Mode

Playback Mode

Wireless Features

Setting Menu

Accessories

Appendix

Index





- Movie shooting is not available.
- Focusing may take longer.
- Image display or shutter release may be delayed, depending on the connection status.



- Any rough subject motion shown on the smartphone due to the connection environment will not affect recorded images.
- Captured images are not transferred to the smartphone. Use the smartphone to browse and transfer images from the camera.

Controlling the Camera via Bluetooth

You can use a Bluetooth enabled smartphone for remote shooting and switching of image display. This is convenient if you want to connect quickly while shooting, or if you will control playback while connected to a TV.

1 Prepare the camera.

- Set the shooting mode and the shooting functions on the camera.
- Keep the camera still by mounting it on a tripod or taking other measures when shooting.

2 Connect the camera and smartphone (📖 128).

- Make sure that the Bluetooth connection has been established.

3 Choose Bluetooth remote controller.

- In Camera Connect on the smartphone, choose [Bluetooth remote controller].
- The smartphone screen changes to a screen for remote control via Bluetooth.

4 Shoot and switch images.

- Use the smartphone to shoot in Shooting mode and switch images in Playback mode.



- [Bluetooth remote controller] is not available when connected via Wi-Fi.



- You can check the Bluetooth connection status by referring to the icon on the screen (📖 192).

Before Use

Basic Guide

Advanced Guide

Camera Basics

Auto Mode /
Hybrid Auto Mode

Other Shooting Modes

P Mode

Tv, Av, M, C1, and C2 Mode

Playback Mode

Wireless Features

Setting Menu

Accessories

Appendix

Index



Editing or Erasing Wireless Settings

Edit or erase wireless settings as follows.

Editing Connection Information



1 Access the Wi-Fi menu and choose a device to edit.

- Move the power switch to [ON].
- Press the [Wi-Fi] button.
- Press the [Left][Right] buttons to access the device selection screen, choose the icon of a device to edit (press the [Up][Down][Left][Right] buttons or turn the [Dial], and then press the [OK] button.



2 Choose [Edit a Device].

- Press the [Up][Down] buttons or turn the [Dial] to choose [Edit a Device], and then press the [OK] button.

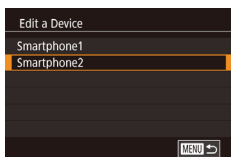

3 Choose the device to edit.

- Press the [Up][Down] buttons or turn the [Dial] to choose the device to edit, and then press the [OK] button.

4 Choose the item to edit.

- Press the [Up][Down] buttons or turn the [Dial] to choose the item to edit, and then press the [OK] button.
- The items you can change depend on the device or service.

Configurable Items	Connection				
					Web Services
Change Device Nickname (📖151)	<input type="radio"/>	<input type="radio"/>	<input type="radio"/>	–	–
View Settings (📖152)	–	<input type="radio"/>	–	–	–
Erase Connection Info (📖152)	<input type="radio"/>	<input type="radio"/>	<input type="radio"/>	–	–

O : Configurable – : Not configurable

Changing a Device Nickname

You can change the device nickname (display name) that is displayed on the camera.



- Following step 4 in “Editing Connection Information” (📖151), choose [Change Device Nickname] and press the [OK] button.
- Select the input field and press the [OK] button. Use the keyboard displayed to enter a new nickname (📖37).

Before Use

Basic Guide

Advanced Guide

Camera Basics

Auto Mode / Hybrid Auto Mode

Other Shooting Modes

P Mode

Tv, Av, M, C1, and C2 Mode

Playback Mode

Wireless Features

Setting Menu

Accessories

Appendix

Index



Erasing Connection Information

Erase connection information (information about devices that you have connected to) as follows.

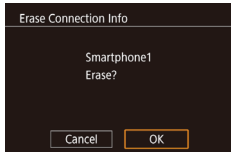

- Following step 4 in “Editing Connection Information” (📖151), choose [Erase Connection Info] and press the [🔍] button.
- After [Erase?] is displayed, press the [◀][▶] buttons to choose [OK], and then press the [🔍] button.
- The connection information will be erased.

Specifying Images Viewable from Smartphones

Specify which images on the camera’s memory card can be viewed from smartphones connected to the camera.

Setting Option	Images Viewable from Smartphones
All images	All images on the memory card
Images shot today	Images shot that day
Images shot in past days	Images shot within the specified number of days
Select by rating	Image with the specified rating (📖117)
File number range	Images in the specified range of file numbers

The same instructions can be followed when the screen in step 2 is displayed after you establish a connection with a smartphone.

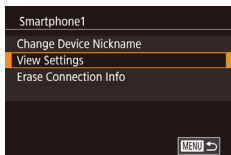

1 Access the setting screen.

- Following step 4 in “Editing Connection Information” (📖151), choose [View Settings] and press the [🔍] button.



2 Choose and set an option.

- Press the [▲][▼] buttons or turn the [🔍] dial to choose an option.
- After choosing [All images] or [Images shot today]: Press the [🔍] button.
- After choosing [Images shot in past days]: Press the [🔍] button, press the [▲][▼] buttons on the next screen to specify the number of days, and then press the [🔍] button.
- After choosing [Select by rating]: Press the [🔍] button, press the [▲][▼] buttons on the next screen to choose the rating, and then press the [🔍] button.
- After choosing [File number range]: Press the [🔍] button, specify the first and last number on the next screen, choose [OK], and then press the [🔍] button. For instructions on specifying the range, see steps 2 – 3 in “Selecting a Range” (📖113).



- For remote live view shooting, choose [All images].

Before Use

Basic Guide

Advanced Guide

Camera Basics

Auto Mode / Hybrid Auto Mode

Other Shooting Modes

P Mode

Tv, Av, M, C1, and C2 Mode

Playback Mode

Wireless Features

Setting Menu

Accessories

Appendix

Index



Changing the Camera Nickname

Change the camera nickname (displayed on connected devices) as desired.

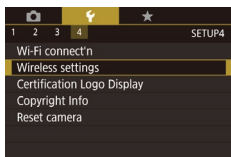

1 Choose [Wireless settings].

- Press the [MENU] button and choose [Wireless settings] on the [4] tab (📖35).

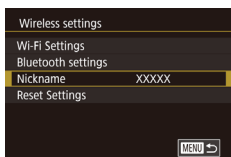

2 Choose [Nickname].

- Press the [▲][▼] buttons or turn the [DIAL] dial to choose [Nickname], and then press the [OK] button.

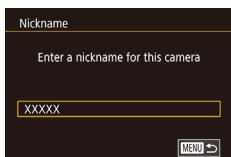

3 Change the nickname.

- Press the [OK] button to access the keyboard (📖37), and then enter a nickname.



- A message is displayed if the nickname you enter begins with a symbol or space. Press the [OK] button and enter a different nickname.
- You can also change the nickname from the [Device Nickname] screen displayed when you first use Wi-Fi. In this case, select the text box, press the [OK] button to access the keyboard, and then enter a new nickname.

Returning the Wireless Settings to Default

Return the wireless settings to default if you transfer ownership of the camera to another person, or dispose of it. Resetting the wireless settings will also clear all Web service settings. Be sure that you want to reset all Wi-Fi settings before using this option.

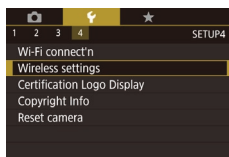

1 Choose [Wireless settings].

- Press the [MENU] button and choose [Wireless settings] on the [4] tab (📖35).

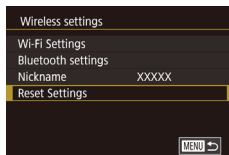

2 Choose [Reset Settings].

- Press the [▲][▼] buttons or turn the [DIAL] dial to choose [Reset Settings], and then press the [OK] button.

3 Restore the default settings.

- Press the [◀][▶] buttons or turn the [DIAL] dial to choose [OK], and then press the [OK] button.
- The wireless settings are now reset.



- To reset settings other than wireless settings to defaults, choose [Reset camera] on the [4] tab (📖163).

Before Use

Basic Guide

Advanced Guide

Camera Basics

Auto Mode /
Hybrid Auto Mode

Other Shooting Modes

P Mode

Tv, Av, M, C1, and C2 Mode

Playback Mode

Wireless Features

Setting Menu

Accessories

Appendix

Index



Clearing Information of Devices Paired via Bluetooth

Before pairing with a different smartphone, clear the information about any connected smartphones.

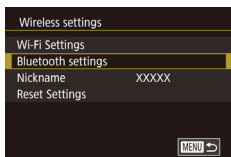

1 Choose [Bluetooth settings].

- Press the [MENU] button and choose [F4] tab > [Wireless settings] > [Bluetooth settings].

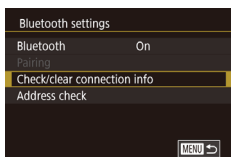

2 Choose [Check/clear connection info].

- Press the [▲][▼] buttons or turn the [DISP] dial to choose [Check/clear connection info], and then press the [DISP] button.

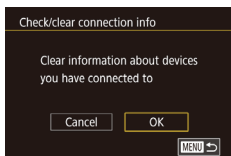

3 Clear the information.

- On the [Check/clear connection info] screen, press the [DISP] button.
- After [Clear information about devices you have connected to] is displayed, press the [◀][▶] buttons or turn the [DISP] dial to choose [OK], and then press the [DISP] button.



4 Clear the camera information.

- In the Bluetooth setting menu on the smartphone, clear the camera information registered on the smartphone.

Before Use

Basic Guide

Advanced Guide

Camera Basics

Auto Mode /
Hybrid Auto Mode

Other Shooting Modes

P Mode

Tv, Av, M, C1, and C2 Mode

Playback Mode

Wireless Features

Setting Menu

Accessories

Appendix

Index



Setting Menu

Customize or adjust basic camera functions for greater convenience

Adjusting Basic Camera Functions

MENU (📖35) settings on the [F1], [F2], [F3], and [F4] tabs can be configured. Customize commonly used functions as desired, for greater convenience.

Date-Based Image Storage

Instead of saving images in folders created each month, you can have the camera create folders each day you shoot to store shots taken that day.

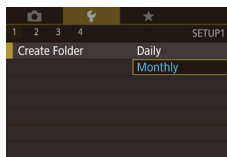

- Choose [Create Folder] on the [F1] tab, and then choose [Daily].
- Images will now be saved in folders created on the shooting date.

File Numbering

Your shots are automatically numbered in sequential order (0001 – 9999) and saved in folders that store up to 2,000 images each. You can change how the camera assigns file numbers.

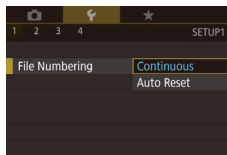

- Choose [File Numbering] on the [F1] tab, and then choose an option.

Continuous	Images are numbered consecutively (until the 9999th shot is taken/saved) even if you switch memory cards.
Auto Reset	Image numbering is reset to 0001 if you switch memory cards, or when a new folder is created.

Before Use

Basic Guide

Advanced Guide

Camera Basics

Auto Mode /
Hybrid Auto Mode

Other Shooting Modes

P Mode

Tv, Av, M, C1, and C2 Mode

Playback Mode

Wireless Features

Setting Menu

Accessories

Appendix

Index





- Regardless of the option selected in this setting, shots may be numbered consecutively after the last number of existing images on newly inserted memory cards. To start saving shots from 0001, use an empty (or formatted, 156) memory card.

Formatting Memory Cards

Before using a new memory card or a card formatted in another device, you should format the card with this camera.

Formatting erases all data on a memory card. Before formatting, copy images on the memory card to a computer, or take other steps to back them up.

1 Access the [Format] screen.

- Choose [Format] on the [1] tab, and then press the [INFO] button.

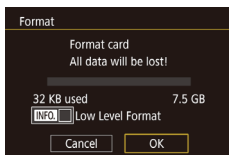

2 Choose [OK].

- Press the [Left] [Right] buttons or turn the [Dial] dial to choose [OK], and then press the [INFO] button.

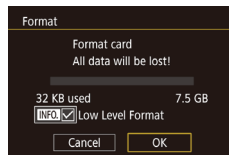

3 Format the memory card.

- To begin the formatting process, press the [Up] [Down] buttons or turn the [Dial] dial to choose [OK], and then press the [INFO] button.
- When formatting is finished, [Memory card formatting complete] is displayed. Press the [INFO] button.



- Formatting or erasing data on a memory card only changes file management information on the card and does not erase the data completely. When transferring or disposing of memory cards, take steps to protect personal information if necessary, as by physically destroying cards.



- The total card capacity indicated on the formatting screen may be less than the advertised capacity.

Low-Level Formatting

Perform low-level formatting in the following cases: [Memory card error] is displayed, the camera is not working correctly, card image reading/writing is slower, continuous shooting is slower, or movie recording suddenly stops. Low-level formatting erases all data on a memory card. Before low-level formatting, copy images on the memory card to a computer, or take other steps to back them up.

- On the screen in step 2 of “Formatting Memory Cards” (156), press the [INFO] button to choose [Low Level Format]. A [Checkmark] icon is displayed.
- Follow step 2 in “Formatting Memory Cards” (156) to continue with the formatting process.



- Low-level formatting takes longer than “Formatting Memory Cards” (156), because data is erased from all storage regions of the memory card.
- You can cancel low-level formatting in progress by choosing [Cancel]. In this case, all data will be erased, but the memory card can be used normally.

Before Use

Basic Guide

Advanced Guide

Camera Basics

Auto Mode / Hybrid Auto Mode

Other Shooting Modes

P Mode

Tv, Av, M, C1, and C2 Mode

Playback Mode

Wireless Features

Setting Menu

Accessories

Appendix

Index



Changing the Video System

Set the video system of any television used for display. This setting determines the image quality (frame rate) available for movies.

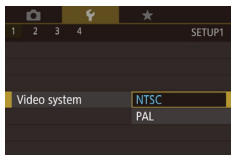

- Choose [Video system] on the [F1] tab, and then choose an option.

Electronic Level Calibration

Calibrate the electronic level if it seems ineffective in helping you level the camera.

For greater calibration accuracy, display grid lines (📖95) to help you level the camera in advance.

1 Make sure the camera is level.

- Place the camera on a flat surface, such as a table.

2 Calibrate the electronic level.

- Choose [Electronic level] on the [F1] tab, and then press the [OK] button.
- To adjust left/right tilt, choose [Horizontal Roll Calibration], and to adjust forward/backward tilt, choose [Vertical Pitch Calibration], followed by the [OK] button. A confirmation message is displayed.
- Choose [OK], and then press the [OK] button.

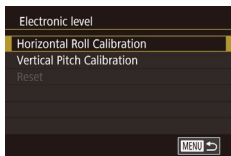

Resetting the Electronic Level

Restore the electronic level to its original state as follows. Note that this is not possible unless you have calibrated the electronic level.

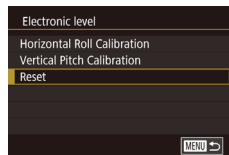

- Choose [Electronic level] on the [F1] tab, and then press the [OK] button.
- Choose [Reset], and then press the [OK] button.
- Choose [OK], and then press the [OK] button.

Using Eco Mode

This function allows you to conserve battery power in Shooting mode. When the camera is not in use, the screen quickly darkens to reduce battery consumption.

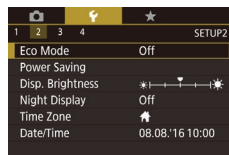

1 Configure the setting.

- Choose [Eco Mode] on the [F2] tab, and then choose [On].
- [ECO] is now shown on the shooting screen (📖191).
- The screen darkens when the camera is not used for approximately two seconds; approximately ten seconds after darkening, the screen turns off. The camera turns off after approximately three minutes of inactivity.

2 Shoot.

- To activate the screen and prepare for shooting when the screen is off and the indicator is blinking, press the shutter button halfway.

Before Use

Basic Guide

Advanced Guide

Camera Basics

Auto Mode /
Hybrid Auto Mode

Other Shooting Modes

P Mode

Tv, Av, M, C1, and C2 Mode

Playback Mode

Wireless Features

Setting Menu

Accessories

Appendix

Index



Power-Saving Adjustment

Adjust the timing of automatic camera and screen deactivation (Auto Power Down and Display Off, respectively) as needed (📖31).



- Choose [Power Saving] on the [F2] tab, and then press the [OK] button.
- Choose an item and press the [OK] button. Press the [▲][▼] buttons or turn the [DISP.] dial to adjust the setting, and then press the [OK] button again.



- To conserve battery power, you should normally choose [1 min.] for [Auto Power Down] and [1 min.] or less for [Display Off].



- The [Display Off] setting is applied even if you set [Auto Power Down] to [Off].
- These power-saving functions are not available when you have set Eco mode (📖157) to [On].

Screen Brightness

Screen and viewfinder brightness can be set separately. Before adjustment, make sure the display to adjust is activated.

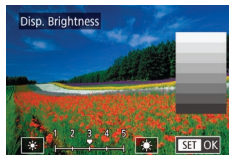

- Choose [F2] tab > [Disp. Brightness], press the [OK] button, and then press the [◀][▶] buttons or turn the [DISP.] dial to adjust the brightness.



- For maximum brightness, press and hold the [INFO.] button for at least one second. (This will override the [Disp. Brightness] setting on the [F2] tab.) To restore the original brightness, press and hold the [INFO.] button again for at least one second or restart the camera.

Switching the Color of Screen Information

Information displayed on the screen and menus can be changed to a color suitable for shooting under low-light conditions.

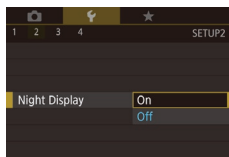

- Choose [Night Display] on the [F2] tab, and then choose [On].
- To restore the original display, choose [Off].



- You can also return the setting to [Off] by holding down the [INFO.] button for at least one second.

Before Use

Basic Guide

Advanced Guide

Camera Basics

Auto Mode /
Hybrid Auto Mode

Other Shooting Modes

P Mode

Tv, Av, M, C1, and C2 Mode

Playback Mode

Wireless Features

Setting Menu

Accessories

Appendix

Index



World Clock

To ensure that your shots will have the correct local date and time when you travel abroad, simply register the destination in advance and switch to that time zone. This convenient feature eliminates the need to change the Date/Time setting manually.

Before using the world clock, be sure to set the date and time and your home time zone, as described in “Setting the Date and Time” (191).

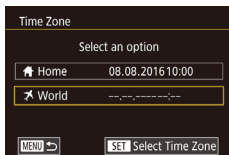

1 Specify your destination.

- Choose [Time Zone] on the [F2] tab, and then press the [Globe] button.
- Press the [▲][▼] buttons or turn the [Dial] dial to choose [✈ World], and then press the [Globe] button.
- Press the [◀][▶] buttons to choose the destination.
- To set daylight saving time (1 hour ahead), choose [☀] by pressing the [▲][▼] buttons, and then choose [☀] by pressing the [◀][▶] buttons.
- Press the [Globe] button.

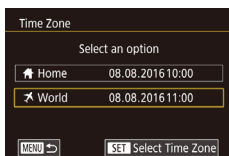

2 Switch to the destination time zone.

- Press the [▲][▼] buttons or turn the [Dial] dial to choose [✈ World], and then press the [MENU] button.
- [✈] is now shown on the shooting screen (191).



- Adjusting the date or time while in [✈] mode (191) will automatically update your [Home] time and date.

Date and Time

Adjust the date and time as follows.

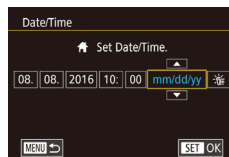

- Choose [Date/Time] on the [F2] tab, and then press the [Globe] button.
- Press the [◀][▶] buttons to choose an option, and then adjust the setting, either by pressing the [▲][▼] buttons or turning the [Dial] dial.

Display Language

Change the display language as needed.



- Choose [Language] on the [F3] tab, and then press the [Globe] button.
- Press the [▲][▼][◀][▶] buttons or turn the [Dial] dial to choose a language, and then press the [Globe] button.



- You can also access the [Language] screen in Playback mode by pressing and holding the [Globe] button and then pressing the [MENU] button.

Muting Camera Sounds

Prevent the camera from playing sounds when you press the shutter button halfway or activate the self-timer.

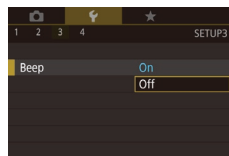

- Choose [Beep] on the [F3] tab, and then choose [Off].

Before Use

Basic Guide

Advanced Guide

Camera Basics

Auto Mode / Hybrid Auto Mode

Other Shooting Modes

P Mode

Tv, Av, M, C1, and C2 Mode

Playback Mode

Wireless Features

Setting Menu

Accessories

Appendix

Index



Activating Camera Sounds

Sounds can be played as feedback after camera operations, such as pressing buttons or touching the screen.

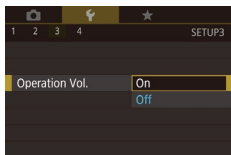

- Choose [Operation Vol.] on the [F3] tab, and then choose [On].

Hiding Hints and Tips

Guidance is normally shown when you choose items in the Quick Set menu (34) or on the shooting screen (69). If you prefer, you can deactivate this information.

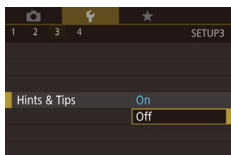

- Choose [Hints & Tips] on the [F3] tab, and then choose [Off].

Listing Shooting Modes by Icon

List shooting modes on the selection screen by icon only, without mode names, for faster selection.

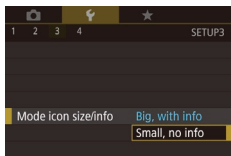

- Choose [Mode icon size/info] on the [F3] tab, and then choose [Small, no info].

Adjusting the Touch-Screen Panel

Sensitivity of the touch-screen panel can be increased to respond to a lighter touch, or you can disable touch control.

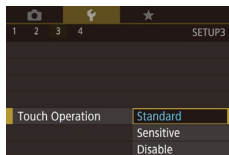

- Choose [F3] tab > [Touch Operation], and then choose the desired option.
- To increase touch-screen panel sensitivity, choose [Sensitive], and to disable touch control, choose [Disable].



- Take the following precautions when using the touch-screen panel.
 - The screen is not pressure sensitive. Do not use sharp objects such as fingernails or ballpoint pens for touch operations.
 - Do not perform touch-screen operations when your fingers are wet.
 - If you perform touch-screen operations when the screen or your fingers are wet, the camera may not respond, or it may malfunction. In this case, turn the camera off and wipe the screen with a cloth.
 - Do not apply screen protectors or adhesive film purchased separately. This may reduce the responsiveness of touch operations.
- The camera may be less responsive if you perform touch operations quickly when the setting is set to [Sensitive].

Before Use

Basic Guide

Advanced Guide

Camera Basics

Auto Mode /
Hybrid Auto Mode

Other Shooting Modes

P Mode

Tv, Av, M, C1, and C2 Mode

Playback Mode

Wireless Features

Setting Menu

Accessories

Appendix

Index



Cleaning the Image Sensor

The image sensor is automatically cleaned to remove dust whenever you turn the camera on or off, or when the camera shuts off in Power Saving mode. You can disable automatic cleaning or activate cleaning as needed.

Disabling Auto Cleaning

1 Access the setting screen.

- Turn the camera on in Shooting mode, choose [Sensor cleaning] on the [F3] tab, and press the [MENU] button.
- Press the [▲][▼] buttons or turn the [DISP] dial to choose [Auto cleaning], and then press the [MENU] button.

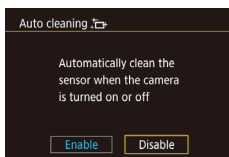

2 Configure the setting.

- Press the [◀][▶] buttons or turn the [DISP] dial to choose [Disable], and then press the [MENU] button.

Activating Sensor Cleaning

1 Access the setting screen.

- Turn the camera on in Shooting mode, choose [Sensor cleaning] on the [F3] tab, and press the [MENU] button.
- Press the [▲][▼] buttons or turn the [DISP] dial to choose [Clean now], and then press the [MENU] button.

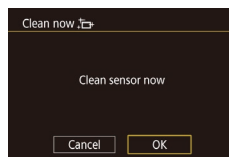

2 Start cleaning.

- Press the [◀][▶] buttons or turn the [DISP] dial to choose [OK], and then press the [MENU] button.
- A message is displayed indicating that cleaning is in progress. Although there will be a shutter sound, a picture is not taken.



- The sensor cleaning also works while no lens is attached. If no lens is attached, do not insert your finger or a blower tip past the lens mount, which may damage the shutter curtains.



- For best results, clean with the camera placed upright on a desk or other surface.
- Repeated cleaning will not produce notably better results. Note that [Clean now] may not be available immediately after cleaning.
- Contact a Canon Customer Support Help Desk regarding dust or other material that cannot be removed by sensor cleaning.

Before Use

Basic Guide

Advanced Guide

Camera Basics

Auto Mode / Hybrid Auto Mode

Other Shooting Modes

P Mode

Tv, Av, M, C1, and C2 Mode

Playback Mode

Wireless Features

Setting Menu

Accessories

Appendix

Index



Cleaning the Sensor Manually

Any dust that remains after automatic cleaning can also be removed by using an optional blower or other specialized tool. The surface of the image sensor is extremely delicate. If the sensor must be cleaned manually, we recommend requesting service from a Canon Customer Support Help Desk.

- 1 Make sure the camera is off.
- 2 Detach the lens.
- 3 Clean the sensor.



- The image sensor is extremely delicate. Clean the sensor with care.
- Use a blower without a brush attached. A brush can scratch the sensor.
- Do not insert the blower tip inside the camera beyond the lens mount. It can damage the shutter curtains.
- Never use canned air or gas to clean the sensor. The blowing force can damage the sensor or the spray gas can freeze on the sensor.
- If a smudge that cannot be removed with a blower remains, having the sensor cleaned by a Canon Customer Support Help Desk is recommended.

Checking Certification Logos

Some logos for certification requirements met by the camera can be viewed on the screen. Other certification logos are printed in this guide, on the camera packaging, or on the camera body.

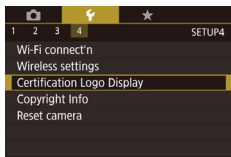

- Choose [Certification Logo Display] on the [4] tab, and then press the [OK] button.

Setting Copyright Information to Record in Images

To record the author's name and copyright details in images, set this information beforehand as follows.

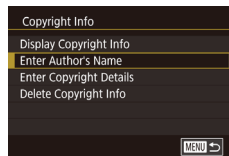

- Choose [Copyright Info] on the [4] tab, and then press the [OK] button.
- Press the [▲][▼] buttons or turn the [DISP] dial to choose [Enter Author's Name] or [Enter Copyright Details]. Press the [OK] button to access the keyboard, and enter the name (p. 37).
- Press the [MENU] button. When [Accept changes?] is displayed, choose [Yes] (either press the [◀][▶] buttons or turn the [DISP] dial), and then press the [OK] button.
- The information set here will now be recorded in images.



- To check the information entered, choose [Display Copyright Info] on the screen above, and then press the [OK] button.
- You can also use EOS Utility (p. 176) to enter, change, or delete copyright information on the camera. Some characters entered with the software may not display on the camera, but will be correctly recorded in images.
- You can check copyright information recorded in images by using the software, once you save the images to a computer.
- Download the EOS Utility instruction manual from the Canon website as needed. For downloading instructions, see "Software Instruction Manual" (p. 176).

Before Use

Basic Guide

Advanced Guide

Camera Basics

Auto Mode / Hybrid Auto Mode

Other Shooting Modes

P Mode

Tv, Av, M, C1, and C2 Mode

Playback Mode

Wireless Features

Setting Menu

Accessories

Appendix

Index



Deleting All Copyright Information

You can delete both the author's name and copyright details at the same time as follows.

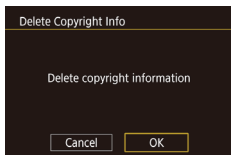

- Follow the steps in “Setting Copyright Information to Record in Images” (📖162) and choose [Delete Copyright Info].
- Press the [◀][▶] buttons or turn the [🌀] dial to choose [OK], and then press the [📷] button.



- The copyright info already recorded in images will not be deleted.

Adjusting Other Settings

The following settings can also be adjusted.

- [Wireless settings] ([🔗] tab) (📖127)
- [Custom shooting mode (C1, C2)] ([🔗] tab) (📖100)
- [📷 firmware ver.] ([🔗] tab) (used for firmware updates)



- During firmware updates, the touch-screen panel will be disabled to prevent accidental operations.

Restoring Default Camera Settings

If you accidentally change a setting, you can restore default camera settings.

Restoring All Camera Defaults

1 Access the [Basic settings] screen.

- Choose [Reset camera] on the [🔗] tab, and then press the [📷] button.
- Press the [▲][▼] buttons or turn the [🌀] dial to choose [Basic settings], and then press the [📷] button.

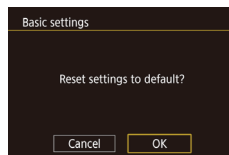

2 Restore default settings.

- Press the [◀][▶] buttons or turn the [🌀] dial to choose [OK], and then press the [📷] button.
- All camera defaults are now restored.



- The following functions are not restored to default settings.
 - [🔗] tab setting [Video system] (📖157)
 - [🔗] tab settings [Time Zone] (📖159), [Date/Time] (📖159), and [Language] (📖159)
 - [📷] tab settings [External flash func. setting] and [External flash C.Fn setting] in [Flash Control]
 - [🔗] Tab
 - Exposure compensation (📖69) setting
 - Shooting mode (📖56)
 - Wireless settings (📖127)
 - Calibrated value for the electronic level (📖157)
 - Copyright information (📖163)

Before Use

Basic Guide

Advanced Guide

Camera Basics

Auto Mode / Hybrid Auto Mode

Other Shooting Modes

P Mode

Tv, Av, M, C1, and C2 Mode

Playback Mode

Wireless Features

Setting Menu

Accessories

Appendix

Index



Restoring Defaults for Individual Functions

Settings for the following functions can be restored to defaults individually.

- User settings for custom shooting modes
- [Fn5] tab settings [Built-in flash settings], [External flash func. setting], and [External flash C.Fn setting] in [Flash Control]
- [Fn1] Tab
- Wireless settings
- Calibrated value for the electronic level
- Copyright information

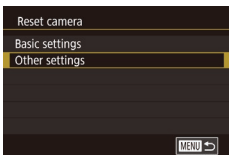

1 Access the [Other settings] screen.

- Choose [Reset camera] on the [Fn4] tab, and then press the [Fn] button.
- Press the [▲][▼] buttons or turn the [DIAL] dial to choose [Other settings], and then press the [Fn] button.

2 Choose the function to reset.

- Press the [▲][▼] buttons or turn the [DIAL] dial to choose the function to reset, and then press the [Fn] button.

3 Restore default settings.

- Press the [◀][▶] buttons or turn the [DIAL] dial to choose [OK], and then press the [Fn] button.
- Default function settings are now restored.

Before Use

Basic Guide

Advanced Guide

Camera Basics

Auto Mode /
Hybrid Auto Mode

Other Shooting Modes

P Mode

Tv, Av, M, C1, and C2 Mode

Playback Mode

Wireless Features

Setting Menu

Accessories

Appendix

Index



Accessories

Enjoy the camera in more ways with optional Canon accessories and other compatible accessories sold separately

Use of genuine Canon accessories is recommended.

This product is designed to achieve excellent performance when used with genuine Canon accessories. Canon shall not be liable for any damage to this product and/or accidents such as fire, etc., caused by the malfunction of non-genuine Canon accessories (e.g., a leakage and/or explosion of a battery pack). Please note that any repairs your Canon product may require as a result of such malfunction are not covered under warranty and will incur a fee.

Before Use

Basic Guide

Advanced Guide

Camera Basics

Auto Mode /
Hybrid Auto Mode

Other Shooting Modes

P Mode

Tv, Av, M, C1, and C2 Mode

Playback Mode

Wireless Features

Setting Menu

Accessories

Appendix

Index



System Map

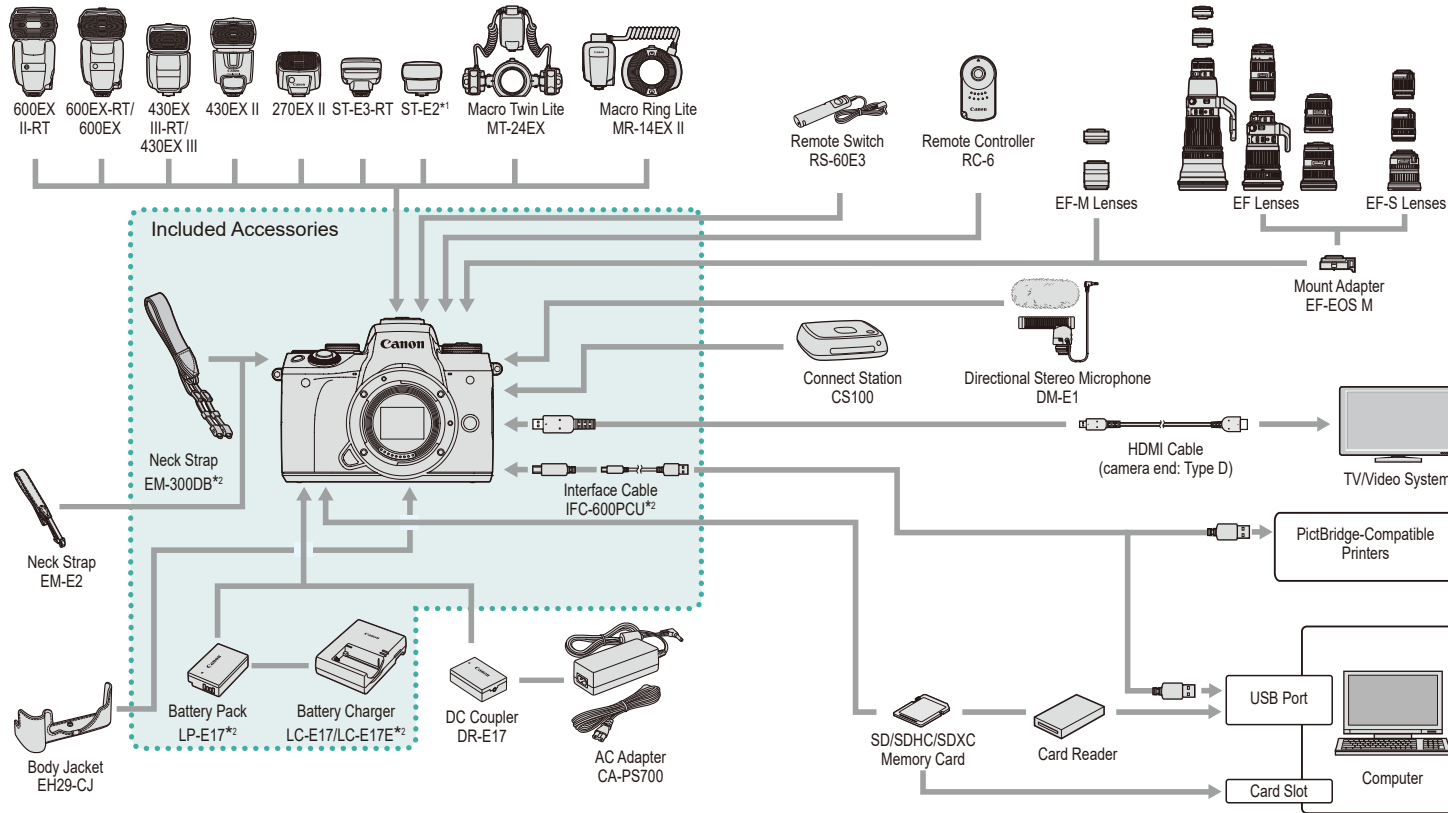

*1 With some lenses, Off-Camera Shoe Cord OC-E3 may be required.
 *2 Also available for purchase separately.

Before Use

Basic Guide

Advanced Guide

Camera Basics

Auto Mode / Hybrid Auto Mode

Other Shooting Modes

P Mode

Tv, Av, M, C1, and C2 Mode

Playback Mode

Wireless Features

Setting Menu

Accessories

Appendix

Index



Optional Accessories

The following camera accessories are sold separately. Note that availability varies by area, and some accessories may no longer be available.

Lenses

EF-M, EF, and EF-S Lenses

- Switch lenses to suit the subject or your preferred shooting style. Note that EF and EF-S lenses require Mount Adapter EF-EOS M.

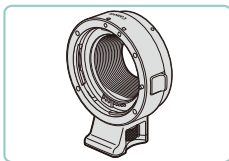

Mount Adapter EF-EOS M

- Use this mount adapter when attaching EF or EF-S lenses.

Power Supplies

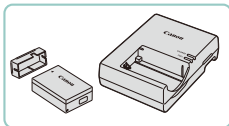

Battery Pack LP-E17

- Rechargeable lithium-ion battery

Battery Charger LC-E17/LC-E17E

- Charger for Battery Pack LP-E17



- The message [Battery communication error] is displayed if you use a non-genuine Canon battery pack, and user response is required. Note that Canon shall not be liable for any damages resulting from accidents, such as malfunction or fire, that occur due to use of non-genuine Canon battery packs.



- The battery pack includes a convenient cover which you can attach to know the charge status at a glance. Attach the cover so that ▲ is visible on a charged battery pack, and attach it so that ▲ is not visible on an uncharged battery pack.

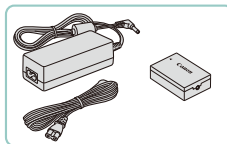

AC Adapter CA-PS700

- For powering the camera using household power. Recommended when using the camera over extended periods, or when connecting the camera to a printer or computer. Cannot be used to charge the battery pack in the camera.

DC Coupler DR-E17

- Used with an AC adapter.



- The battery charger and AC adapter can be used in areas with 100 – 240 V AC power (50/60 Hz).
- For power outlets in a different format, use a commercially available adapter for the plug. Never use an electrical transformer designed for traveling, which may damage the battery pack.

Before Use

Basic Guide

Advanced Guide

Camera Basics

Auto Mode /
Hybrid Auto Mode

Other Shooting Modes

P Mode

Tv, Av, M, C1, and C2 Mode

Playback Mode

Wireless Features

Setting Menu

Accessories

Appendix

Index



Flash Units



Speedlite 600EX II-RT/600EX-RT/600EX/430EX III-RT/430EX III/430EX II/270EX II

- Shoe-mounted flash unit that enables many styles of flash photography. Speedlite 580EX II, 580EX, 550EX, 430EX, 420EX, 380EX, 320EX, 270EX, 220EX, and 90EX are also supported.



Speedlite Transmitter ST-E3-RT/ST-E2

- Enables wireless control of slave Speedlite flash units (except Speedlite 220EX/270EX).
- Off-Camera Shoe Cord OC-E3 may be required when using ST-E2 with certain lenses.

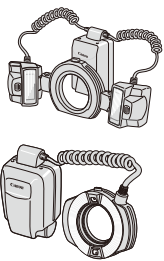

Macro Twin Lite MT-24EX Macro Ring Lite MR-14EX II

- External macro flash unit that enables many styles of macro flash photography. MR-14EX is also supported.

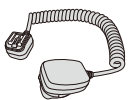

Off-Camera Shoe Cord OC-E3

- Connection cord for using a Speedlite without mounting it on the camera.

Microphone

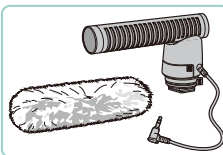

Directional Stereo Microphone DM-E1

- When movies are recorded, any sounds of lens and camera operations that are picked up by the microphone will be quieter.

Other Accessories

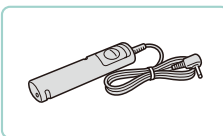

Remote Switch RS-60E3

- Enables remote shutter button operation (pressing the button halfway or all the way down).



Remote Controller RC-6

- Enables remote shooting on a camera you have set up.

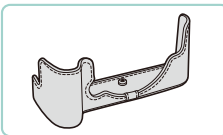

Body Jacket EH29-CJ

- Protects the camera from dust and scratches.

Before Use

Basic Guide

Advanced Guide

Camera Basics

Auto Mode /
Hybrid Auto Mode

Other Shooting Modes

P Mode

Tv, Av, M, C1, and C2 Mode

Playback Mode

Wireless Features

Setting Menu

Accessories

Appendix

Index





Neck Strap EM-E2

- Strap made of the same material as Body Jacket EH29-CJ.

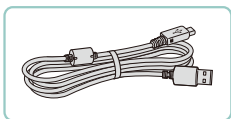

Interface Cable IFC-600PCU

- For connecting the camera to a computer or printer.



- Rings and caps included with Neck Strap EM-300DB are required when attaching Neck Strap EM-E2.

Printers



Canon-Brand PictBridge-Compatible Printers

- Even without using a computer, you can print images by connecting the camera directly to a printer. For details, visit your nearest Canon retailer.

Photo and Movie Storage

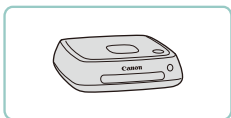

Connect Station CS100

- A media hub for storing camera images, viewing on a connected TV, printing wirelessly on a Wi-Fi-compatible printer, sharing over the Internet, and more.

Using Optional Accessories

▶ Still Images ▶ Movies

Playback on a TV

▶ Still Images ▶ Movies

You can view your shots on a TV by connecting the camera to an HDTV with a commercially available HDMI cable (not exceeding 2.5 m / 8.2 ft., with a Type D terminal on the camera end). Movies shot at an image quality of [FHD 59.94P], [FHD 29.97P], [FHD 23.98P], [FHD 59.94P], [FHD 50.00P], [FHD 25.00P], or [FHD 50.00P] can be viewed in high definition.

For details on connection or how to switch inputs, refer to the TV manual.

1 Make sure the camera and TV are off.

2 Connect the camera to the TV.

- On the TV, insert the cable plug fully into the HDMI input as shown.

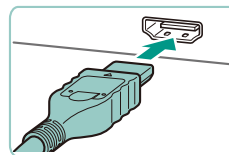

- On the camera, open the terminal cover and insert the cable plug fully into the camera terminal.

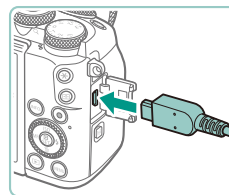

Before Use

Basic Guide

Advanced Guide

Camera Basics

Auto Mode / Hybrid Auto Mode

Other Shooting Modes

P Mode

Tv, Av, M, C1, and C2 Mode

Playback Mode

Wireless Features

Setting Menu

Accessories

Appendix

Index



3 Turn the TV on and switch to external input.

- Switch the TV input to the external input you connected the cable to in step 2.

4 Turn the camera on.

- Move the power switch to [ON].
- Press the [▶] button.
- Images from the camera are now displayed on the TV. (Nothing is displayed on the camera screen.)
- When finished, turn off the camera and TV before disconnecting the cable.



- Touch-screen operations are not supported while the camera is connected to a television.



- When the camera and TV are connected, you can also shoot while previewing shots on the larger screen of the TV. To shoot, follow the same steps as when using the camera screen. However, display cannot be magnified (110) and Night Display (158) is not available.

Powering the Camera with Household Power

▶ Still Images ▶ Movies

Powering the camera with both AC Adapter CA-PS700 and DC Coupler DR-E17 (both sold separately) eliminates the need to monitor the remaining battery level.

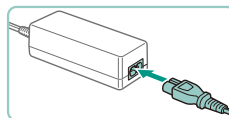
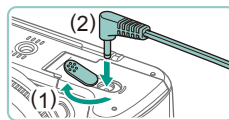
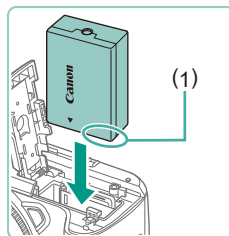

1 Make sure the camera is off.

2 Insert the coupler.

- Follow step 1 in “Inserting the Battery Pack and Memory Card” (20) to open the cover.
- Holding the coupler with the terminals (1) facing as shown, insert the coupler just as you would a battery pack (following step 2 in “Inserting the Battery Pack and Memory Card” (20)).
- Follow step 4 in “Inserting the Battery Pack and Memory Card” (20) to close the cover.

3 Connect the adapter to the coupler.

- Open the cover and insert the adapter plug fully into the coupler.

4 Connect the power cord.

- Insert one end of the power cord into the compact power adapter, and then plug the other end into a power outlet.
- Turn the camera on and use it as desired.
- When finished, turn the camera off and unplug the power cord from the outlet.

Before Use

Basic Guide

Advanced Guide

Camera Basics

Auto Mode /
Hybrid Auto Mode

Other Shooting Modes

P Mode

Tv, Av, M, C1, and C2 Mode

Playback Mode

Wireless Features

Setting Menu

Accessories

Appendix

Index





- Do not disconnect the adapter or unplug the power cord while the camera is still on. This may erase your shots or damage the camera.
- Do not attach the adapter or adapter cord to other objects. Doing so could result in malfunction or damage to the product.

Shooting Remotely

Use Remote Controller RC-6 (sold separately) to shoot from up to approx. 5 meters (16.4 ft.) in front of the camera.

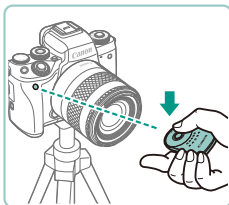

- Follow step 1 in “Using the Self-Timer” (p.44) and choose [1].
- Aim the Remote Controller at the camera’s remote control sensor and press the transmit button to shoot.



- The camera does not shoot unless subjects are in focus.
- Shutter release may be triggered accidentally by any fluorescent or LED lighting nearby. Use the camera as far away from these light sources as possible.
- Operating a TV remote control or similar device aimed at the camera may trigger accidental shutter release.

Using a Remote Switch (Sold Separately)

An optional Remote Switch RS-60E3 can be used to avoid camera shake that may otherwise occur when pressing the shutter button directly. This optional accessory is convenient when shooting at slow shutter speeds.

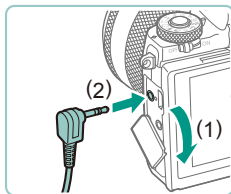

1 Connect the remote switch.

- Make sure the camera is off.
- Open the terminal cover and insert the remote switch plug.

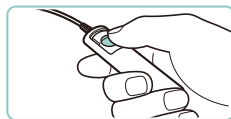

2 Shoot.

- Turn the camera on.
- To shoot, press the release button on the remote switch.

Using the Hot Shoe

Use the hot shoe to attach an optional external flash or microphone.

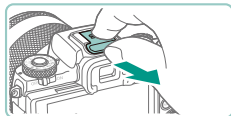

1 Remove the hot shoe cap.

- Pull off the cap as shown.
- To avoid losing the cap, place it in the case for your external flash or microphone.

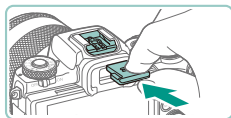

2 Attach the hot shoe cap.

- After removing the external flash or microphone, reattach the cap to protect the hot shoe.
- Insert the cap as shown.

Before Use

Basic Guide

Advanced Guide

Camera Basics

Auto Mode /
Hybrid Auto Mode

Other Shooting Modes

P Mode

Tv, Av, M, C1, and C2 Mode

Playback Mode

Wireless Features

Setting Menu

Accessories

Appendix

Index



Using an External Flash (Sold Separately)

▶ Still Images ▶ Movies

More sophisticated flash photography is possible with an optional Speedlite EX series flash.



- Non-EX series Canon flash units may not fire correctly or may not fire at all, in some cases.
- Use of non-Canon flash units (especially high-voltage flash units) or flash accessories may prevent normal camera operation and may damage the camera.



- Also refer to the Speedlite EX series manual for additional information. This camera is a Type-A camera that supports all features of EX-series Speedlites.

1 Attach the flash.

- Make sure the camera is off, and then attach the flash unit.

2 Turn the flash on, and then turn the camera on.

- An orange icon is now displayed.
- The flash pilot lamp will light up when the flash is ready.

3 Choose shooting mode [P], [Tv], [Av], or [M].

- Flash settings can only be configured in these modes. In other modes, the flash is adjusted and fired automatically, as needed.

4 Configure the external flash (172).



- Keep cords (from the macro ring lite or macro twin lite, as well as the off-camera shoe cord) away from flash heads.
- When using a tripod, adjust the position of the legs to prevent the flash heads from coming into contact with the legs.



- Settings for the built-in flash cannot be configured while a Speedlite EX series flash is attached, because that setting screen is no longer accessible.
- You can also access the setting screen by pressing the button for at least one second.
- The AF-assist beam on the external flash will not fire.

Setting External Flash Functions

When an external flash is attached, configure the following settings in MENU (35) > [5] tab > [Flash Control].

- Flash firing (82)
- E-TTL II metering (84)
- Red-eye reduction (51)
- Safety FE (83)
- External flash function settings (172)
- External flash Custom Function settings (174)
- Clear settings (174)

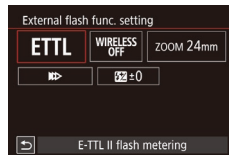

- Choose [External flash func. setting] and press the button to access the screen at left.
- Press the buttons or turn the dial to choose an item, and then press the button. On the screen displayed, choose an option (either press the buttons or turn the dial), and then press the button.

Before Use

Basic Guide

Advanced Guide

Camera Basics

Auto Mode / Hybrid Auto Mode

Other Shooting Modes

P Mode

Tv, Av, M, C1, and C2 Mode

Playback Mode

Wireless Features



Setting Menu

Accessories

Appendix

Index



Setting Option	Description
Flash Mode	<p>Choose a flash mode to suit your desired flash shooting.</p> <ul style="list-style-type: none"> • [E-TTL II flash metering] is the standard mode of EX-series Speedlites that can fire automatically. • Use [Manual flash] mode if you will decide the [Flash output level] of the flash unit yourself. • For details on other flash modes, refer to the instruction manual of a flash compatible with those modes.
Wireless Func.	<p>Enables wireless flash shooting with multiple flash units. When shooting with multiple flashes, you can also configure the radio channel, optical channel, and master flash firing. For details, refer to the instruction manual of flash units compatible with wireless flash shooting.</p>
Flash zoom (flash coverage)	<p>With flash units that have a zooming flash head, you can set the flash coverage. Normally, choose [AUTO] to have the camera automatically set the flash coverage to match the lens focal length.</p>
Shutter synchronization	<p>Change the timing of the flash and shutter release as follows.</p> <ul style="list-style-type: none"> • : The flash fires immediately after the shutter opens. • : The flash fires immediately before the second curtain closes. If the shutter speed is 1/100 sec. or faster, first-curtain synchronization is used automatically even if [Second-curtain synchronization] is set. • : The flash can be used at all shutter speeds. Especially effective when shooting portraits using fill flash, to give priority to the aperture setting.

Setting Option	Description
Flash exposure compensation	<p>Enables adjustment of exposure compensation at the moment the flash fires. For details, refer to the instruction manual of the flash unit. If flash exposure compensation is set on the flash, it cannot be set on the camera. If it is set on both the camera and flash, the flash setting takes precedence.</p>
Flash output level	<p>Configure the flash output level. For details, refer to the instruction manual of the flash unit. If it is set on both the camera and flash, the flash setting takes precedence.</p>
Flash exposure bracketing	<p>Activates FEB (Flash Exposure Bracketing), which takes three shots while automatically changing the flash output. For details, refer to the instruction manual of flash units compatible with flash exposure bracketing.</p>
Flash count/Flash frequency	<p>Set the flash count and frequency when [Flash Mode] is set to [MULTI].</p>
Ratio control	<p>Set the relative flash output level in wireless (multi-flash) flash shooting or with the MR-14EX II.</p>



- [Built-in flash settings] is not available when an external flash is attached.
- Information displayed and available setting items vary depending on the type of flash unit, current flash mode, flash Custom Function settings, and other factors. For details on the functions available with your flash unit, refer to the instruction manual of the flash unit.
- With an EX-series Speedlite not compatible with flash function settings, only [Flash Exp. Comp] can be adjusted. ([Shutter synchronization] can also be set for some EX-series Speedlites.)

Before Use

Basic Guide

Advanced Guide

Camera Basics

Auto Mode / Hybrid Auto Mode

Other Shooting Modes

P Mode

Tv, Av, M, C1, and C2 Mode

Playback Mode

Wireless Features

Setting Menu

Accessories

Appendix

Index



Setting External Flash Custom Functions

For details on Custom Functions for flash units, refer to the instruction manual of the flash (sold separately).

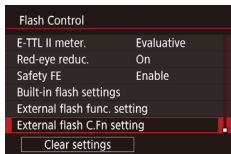

- Press the [MENU] button, choose [Flash Control] on the [CAMERA] tab, choose [External flash C.Fn setting] and then press the [OK] button.
- Press the [◀][▶] buttons or turn the [DISP] dial to choose an item, and then press the [OK] button. On the screen displayed, choose an option (either press the [▲][▼] buttons or turn the [DISP] dial), and then press the [OK] button.



- For full flash firing when you shoot, set [Flash metering mode] to [1:TTL] (automatic flash metering) in [External flash C.Fn setting].

Restoring External Flash Defaults

Restore default [External flash func. setting] and [External flash C.Fn setting] settings.

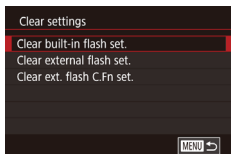

- Press the [MENU] button, choose [CAMERA] tab > [Flash Control] > [Clear settings], and then press the [OK] button.
- Press the [▲][▼] buttons or turn the [DISP] dial to choose an item, and then press the [OK] button. On the next screen, choose [OK] (either press the [◀][▶] buttons or turn the [DISP] dial), and then press the [OK] button.



- [Clear built-in flash set.] is not available when an external flash is attached.

Using External Microphones (Sold Separately)

▶ Still Images ▶ Movies

Using Directional Stereo Microphone DM-E1 (sold separately) can reduce the sound of lens and camera operations that may be recorded in movies. Note that the built-in microphone is not used for recording when an external microphone is connected.



- Also refer to the DM-E1 instruction manual.

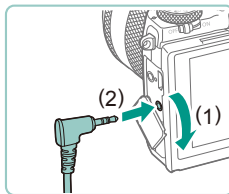
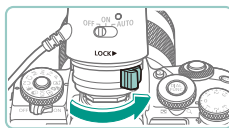
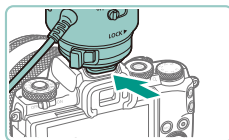

1 Make sure the camera is off.

2 Attach the external microphone to the hot shoe.

- Insert the directional stereo microphone into the hot shoe (📖4) as shown.
- Move the lever to the [LOCK] side.

3 Connect the microphone output plug.

- Connect the microphone output plug to the external microphone IN terminal (📖4) as shown.

Before Use

Basic Guide

Advanced Guide

Camera Basics

Auto Mode / Hybrid Auto Mode

Other Shooting Modes

P Mode

Tv, Av, M, C1, and C2 Mode

Playback Mode

Wireless Features

Setting Menu

Accessories

Appendix

Index



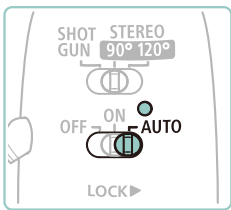

4 Turn on the camera, and then the external microphone.

- Slide the power switch of the external microphone from [OFF] to [AUTO]. When set to [AUTO], the microphone will be automatically turned on and off in sync with the camera power switch and Auto Power Down feature.



5 Adjust microphone directivity to match the subject.

- Use the microphone directivity switch to set the directivity.

6 Remove when finished.

- After turning off the microphone, unplug the output plug and remove it by following the attachment instructions in reverse.



- The external microphone requires a battery for power. Replace the battery when the power check lamp is no longer lit.
- When testing microphone operation, check by speaking instead of tapping the microphone or breathing on it.
- When recording, do not touch the microphone, cable, or wind screen. These sounds will be recorded.
- Noise may be recorded as a result of radio or high-voltage interference from nearby radio towers, high-voltage power lines, mobile phones, or other sources of strong electromagnetic waves.
- Noise may be recorded when wireless camera features are used. For best results, avoid using wireless features when recording.
- Using the microphone where it is cold may cause recordings to be distorted.



- Any attenuator settings you have configured are also applied to recording with the external microphone (67).
- Connecting an external microphone will deactivate [Wind Filter] (67).
- Recording is also possible by connecting a commercially available microphone with a mini plug (3.5 mm diameter) to the external microphone IN terminal.

Before Use

Basic Guide

Advanced Guide

Camera Basics

Auto Mode /
Hybrid Auto Mode

Other Shooting Modes

P Mode

Tv, Av, M, C1, and C2 Mode

Playback Mode

Wireless Features

Setting Menu

Accessories

Appendix

Index



Using the Software

The software available for download from the Canon website is introduced below, with instructions for installation and saving images to a computer.

Software

After installing the software, you can do the following things on your computer.

- EOS Utility
 - Import images and change camera settings
- Digital Photo Professional
 - Browse, process, and edit photos, including RAW images
- Picture Style Editor
 - Edit Picture Styles and create and save Picture Style files
- Image Transfer Utility
 - Set up Image Sync (📖147) and receive images
- Map Utility
 - Use a map to view GPS information that has been added to images



- To view and edit movies on a computer, use preinstalled or commonly available software compatible with movies recorded by the camera.



- Image Transfer Utility can also be downloaded from the Image Sync settings page of CANON IMAGE GATEWAY.

Software Instruction Manual

Download software instruction manuals from the Canon website as needed.



- With a computer connected to the Internet, access <http://www.canon.com/icpd/>.
- Access the site for your country or region.

Checking Your Computer Environment

For detailed software system requirements and compatibility information (including support in new operating systems), visit the Canon website.

Installing the Software

1 Download the software.

- With a computer connected to the Internet, access <http://www.canon.com/icpd/>.
- Access the site for your country or region.
- Download the software.

2 Follow the instructions displayed.

- Double-click the downloaded file to install it.

Before Use

Basic Guide

Advanced Guide

Camera Basics

Auto Mode /
Hybrid Auto Mode

Other Shooting Modes

P Mode

Tv, Av, M, C1, and C2 Mode

Playback Mode

Wireless Features

Setting Menu

Accessories

Appendix

Index



Saving Images to a Computer

Use an interface cable (📖2) to connect the camera and save images to the computer.

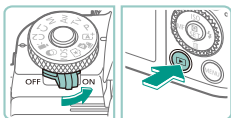
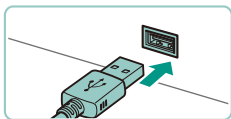
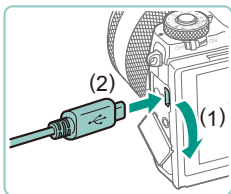

1 Connect the camera to the computer.

- With the camera turned off, open the cover (1). With the smaller plug of the cable in the orientation shown, insert the plug fully into the camera terminal (2).
- Insert the larger plug of the cable in the computer's USB port. For details about USB connections on the computer, refer to the computer user manual.

2 Turn on the camera and display EOS Utility.

- Move the power switch to [ON].
- Press the [] button.
- Windows: Double-click the EOS Utility icon on the desktop.
- Mac OS: Click the EOS Utility icon in the Dock.
- From now on, EOS Utility will start up automatically when you connect the camera to the computer and turn on the camera.

3 Save the images to the computer.

- Click [Download images to computer] > [Start automatic download].
- Once images are saved to the Pictures folder on the computer (in separate folders named by date), Digital Photo Professional starts up automatically and displays the imported images.
- After images are saved, close EOS Utility, slide the camera power switch to [OFF] to turn it off, and disconnect the cable.
- Use Digital Photo Professional to view images you save to a computer. To view movies, use preinstalled or commonly available software compatible with movies recorded by the camera.



- The first time you connect the camera to the computer, drivers will be installed, so it may take a few minutes until camera images are accessible.
- Although you can save images to a computer simply by connecting your camera to the computer without using the software, the following limitations apply.
 - It may take a few minutes after you connect the camera to the computer until camera images are accessible.
 - Images shot in vertical orientation may be saved in horizontal orientation.
 - RAW images (or JPEG images recorded with RAW images) may not be saved.
 - Image protection settings may be cleared from images saved to a computer.
 - Some problems may occur when saving images or image information, depending on the operating system version, the software in use, or image file sizes.

Before Use

Basic Guide

Advanced Guide

Camera Basics

Auto Mode /
Hybrid Auto Mode

Other Shooting Modes

P Mode

Tv, Av, M, C1, and C2 Mode

Playback Mode

Wireless Features

Setting Menu

Accessories

Appendix

Index



Printing Images

▶ Still Images ▶ Movies

Your shots can easily be printed by connecting the camera to a printer. On the camera, you can specify images to set up batch printing, prepare orders for photo development services, and prepare orders or print images for photobooks.

A Canon SELPHY CP series compact photo printer is used here for the sake of illustration. Screens displayed and available functions vary by printer. Also refer to the printer manual for additional information.

Easy Print

▶ Still Images ▶ Movies

Easily print your shots by connecting the camera to a PictBridge-compatible printer (sold separately) with an interface cable (📖2).

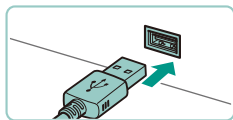
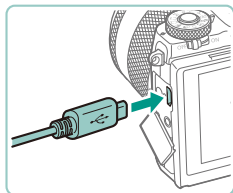

1 Make sure the camera and printer are off.

2 Connect the camera to the printer.

- Open the terminal cover. Holding the smaller cable plug in the orientation shown, insert the plug fully into the camera terminal.
- Connect the larger cable plug to the printer. For other connection details, refer to the printer manual.

3 Turn the printer on.

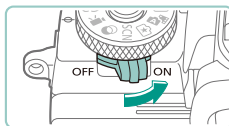

4 Turn the camera on.

- Move the power switch to [ON].



5 Choose an image.

- Press the [◀][▶] buttons or turn the [🔍] dial to choose an image.

6 Access the printing screen.

- Press the [🔍] button, choose [🖨️], and press the [🔍] button again.

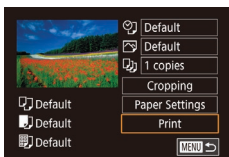

7 Print the image.

- Press the [▲][▼] buttons or turn the [🔍] dial to choose [Print], and then press the [🔍] button.
- Printing now begins.
- To print other images, repeat the above procedures starting from step 5 after printing is finished.
- When you are finished printing, turn the camera and printer off and disconnect the cable.



- For Canon-brand PictBridge-compatible printers (sold separately), see "Printers" (📖169).

Before Use

Basic Guide

Advanced Guide

Camera Basics

Auto Mode /
Hybrid Auto Mode

Other Shooting Modes

P Mode

Tv, Av, M, C1, and C2 Mode

Playback Mode

Wireless Features

Setting Menu

Accessories

Appendix

Index



Configuring Print Settings

▶ Still Images ▶ Movies

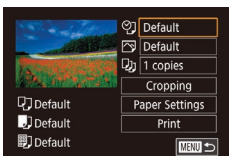

1 Access the printing screen.

- Follow steps 1 – 6 in “Easy Print” (📖178) to access this screen.

2 Configure the settings.

- Press the [▲][▼] buttons or turn the [DISP.] dial to choose an item, and then press the [INFO] button. On the next screen, choose an option (either press the [▲][▼] buttons or turn the [DISP.] dial), and then press the [INFO] button to return to the printing screen.

📄	Default	Matches current printer settings.
	Date	Prints images with the date added.
	File No.	Prints images with the file number added.
	Both	Prints images with both the date and file number added.
📄	Off	–
	Default	Matches current printer settings.
	Off	–
📄	On	Uses information from the time of shooting to print under optimal settings.
	Red-Eye 1	Corrects red-eye.
📄	No. of Copies	Choose the number of copies to print.
Cropping	–	Specify a desired image area to print (📖179).
Paper Settings	–	Specify the paper size, layout, and other details (📖180).

Cropping Images before Printing

▶ Still Images ▶ Movies

By cropping images before printing, you can print a desired image area instead of the entire image.

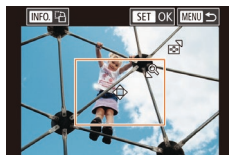
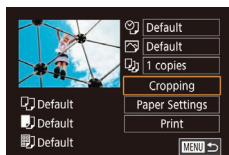

1 Choose [Cropping].

- After following step 1 in “Configuring Print Settings” (📖179) to access the printing screen, choose [Cropping] and press the [INFO] button.
- A cropping frame is now displayed, indicating the image area to print.

2 Adjust the cropping frame as needed.

- To resize the frame, turn the [ZOOM] dials.
- To move the frame, press the [▲][▼][◀][▶] buttons.
- To rotate the frame, press the [INFO] button.
- When finished, press the [INFO] button.

3 Print the image.

- Follow step 7 in “Easy Print” (📖178) to print.



- Cropping may not be possible at small image sizes, or at some aspect ratios.

Before Use

Basic Guide

Advanced Guide

Camera Basics

Auto Mode / Hybrid Auto Mode

Other Shooting Modes

P Mode

Tv, Av, M, C1, and C2 Mode

Playback Mode

Wireless Features

Setting Menu

Accessories

Appendix

Index



Choosing Paper Size and Layout before Printing

▶ Still Images ▶ Movies

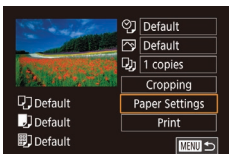

1 Choose [Paper Settings].

- After following step 1 in “Configuring Print Settings” (179) to access the printing screen, choose [Paper Settings] and press the [OK] button.

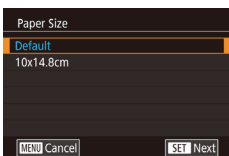

2 Choose a paper size.

- Press the [▲][▼] buttons or turn the [DISP] dial to choose an option, and then press the [OK] button.

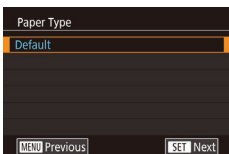

3 Choose a type of paper.

- Press the [▲][▼] buttons or turn the [DISP] dial to choose an option, and then press the [OK] button.

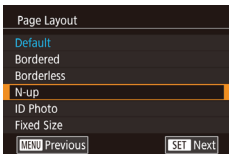

4 Choose a layout.

- Press the [▲][▼] buttons or turn the [DISP] dial to choose an option, and then press the [OK] button.
- When choosing [N-up], press the [OK] button. On the next screen, choose the number of images per sheet (either press the [▲][▼] buttons or turn the [DISP] dial), and then press the [OK] button.

5 Print the image.

Available Layout Options

Default	Matches current printer settings.
Bordered	Prints with blank space around the image.
Borderless	Borderless, edge-to-edge printing.
N-up	Choose how many images to print per sheet.
ID Photo	Prints images for identification purposes. Only available for images with a recording pixel setting of L and an aspect ratio of 3:2.
Fixed Size	Choose the print size. Choose from 3.5 x 5 in., postcard, or wide-format prints.

Printing ID Photos

▶ Still Images ▶ Movies

1 Choose [ID Photo].

- Following steps 1 – 4 in “Choosing Paper Size and Layout before Printing” (180), choose [ID Photo] and press the [OK] button.

2 Choose the long and short side length.

- Press the [▲][▼] buttons or turn the [DISP] dial to choose an item, and then press the [OK] button. On the next screen, choose the length (either press the [▲][▼] buttons or turn the [DISP] dial), and then press the [OK] button.



Before Use

Basic Guide

Advanced Guide

Camera Basics

Auto Mode / Hybrid Auto Mode

Other Shooting Modes

P Mode

Tv, Av, M, C1, and C2 Mode

Playback Mode

Wireless Features

Setting Menu

Accessories

Appendix

Index



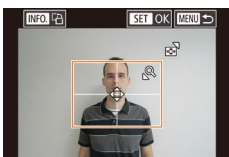

3 Choose the printing area.

- On the screen in step 2, press the [▲][▼] buttons or turn the [DISP] dial to choose [Cropping].
- Follow step 2 in “Cropping Images before Printing” (179) to choose the printing area.

4 Print the image.

Printing Movie Scenes

▶ Still Images ▶ Movies

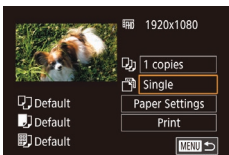

1 Access the printing screen.

- Follow steps 1 – 6 in “Easy Print” (178) to choose a movie. This screen is displayed.

2 Choose a printing method.

- Press the [▲][▼] buttons to choose [Print], and then press the [DISP] button. On the next screen, choose an option (either press the [▲][▼] buttons or turn the [DISP] dial), and then press the [DISP] button to return to the printing screen.

3 Print the image.

Movie Printing Options

Single	Prints the current scene as a still image.
Sequence	Prints a series of scenes, a certain interval apart, on a single sheet of paper. You can also print the folder number, file number, and elapsed time for the frame by setting [Caption] to [On].



- To cancel printing in progress, press the [DISP] button, choose [OK], and then press the [DISP] button again.
- After displaying a scene to print as described in steps 2 – 5 of “Viewing” (103), you can also access the screen in step 1 here by pressing the [◀][▶] buttons or turning the [DISP] dial to choose [Print] in the movie control panel and then pressing the [DISP] button.

Adding Images to the Print List (DPOF)

▶ Still Images ▶ Movies

Batch printing (184) and ordering prints from a photo development service can be set up on the camera. Choose up to 998 images on a memory card and configure relevant settings, such as the number of copies, as follows. The printing information you prepare this way will conform to DPOF (Digital Print Order Format) standards.



- RAW images cannot be included in print list.

Before Use

Basic Guide

Advanced Guide

Camera Basics

Auto Mode / Hybrid Auto Mode

Other Shooting Modes

P Mode

Tv, Av, M, C1, and C2 Mode

Playback Mode

Wireless Features

Setting Menu

Accessories

Appendix

Index



Configuring Print Settings

▶ Still Images ▶ Movies

Specify the printing format, whether to add the date or file number, and other settings as follows. These settings apply to all images in the print list.

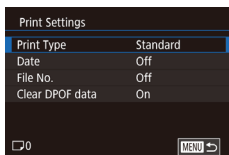

- Press the [MENU] button, choose [Print settings] on the [P] tab, and then press the [OK] button.
- Press the [▲][▼] buttons or turn the [DISP] dial to choose [Print Settings], and then press the [OK] button. On the next screen, choose and configure items as needed ([P]35).

Print Type	Standard	One image is printed per sheet.
	Index	Smaller versions of multiple images are printed per sheet.
	Both	Both standard and index formats are printed.
Date	On	Images are printed with the shooting date.
	Off	–
File No.	On	Images are printed with the file number.
	Off	–
Clear DPOF data	On	All image print list settings are cleared after printing.
	Off	–



- Not all of your DPOF settings may be applied in printing by the printer or photo development service, in some cases.
- [!] may be displayed on the camera to warn you that the memory card has print settings that were configured on another camera. Changing the print settings using this camera may overwrite all previous settings.
- Setting [Date] to [On] may cause some printers to print the date twice.



- Specifying [Index] will prevent you from choosing [On] for both [Date] and [File No.] at the same time.
- Index printing is not available on some Canon-brand PictBridge-compatible printers (sold separately).
- The date is printed in a format matching setting details in MENU ([P]35) > [P]2 tab > [Date/Time] ([P]21).

Setting Up Printing for Individual Images

▶ Still Images ▶ Movies

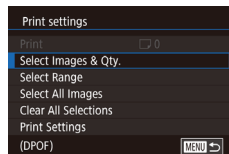

1 Choose [Select Images & Qty.].

- Press the [MENU] button, choose [Print settings] on the [P] tab, and then press the [OK] button.
- Press the [▲][▼] buttons or turn the [DISP] dial to choose [Select Images & Qty.], and then press the [OK] button ([P]35).

2 Choose an image.

- Press the [◀][▶] buttons or turn the [DISP] dial to choose an image, and then press the [OK] button.
- You can now specify the number of copies.
- If you specify index printing for the image, it is labeled with a [✓] icon. To cancel index printing for the image, press the [OK] button again. [✓] is no longer displayed.

Before Use

Basic Guide

Advanced Guide

Camera Basics

Auto Mode / Hybrid Auto Mode

Other Shooting Modes

P Mode

Tv, Av, M, C1, and C2 Mode

Playback Mode

Wireless Features

Setting Menu

Accessories

Appendix

Index





3 Specify the number of prints.

- Press the [▲][▼] buttons or turn the [DISP] dial to specify the number of prints (up to 99).
- To set up printing for other images and specify the number of prints, repeat steps 2 – 3.
- Printing quantity cannot be specified for index prints. You can only choose which images to print, by following step 2.
- When finished, press the [MENU] button to return to the menu screen.

Setting Up Printing for a Range of Images

▶ Still Images ▶ Movies

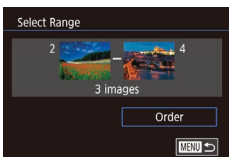

- Following step 1 in “Setting Up Printing for Individual Images” (182), choose [Select Range] and press the [DISP] button.
- Follow steps 2 – 3 in “Selecting a Range” (113) to specify images.
- Press the [▲][▼] buttons to choose [Order], and then press the [DISP] button.

Setting Up Printing for All Images

▶ Still Images ▶ Movies

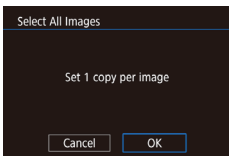

- Following step 1 in “Setting Up Printing for Individual Images” (182), choose [Select All Images] and press the [DISP] button.
- Press the [◀][▶] buttons or turn the [DISP] dial to choose [OK], and then press the [DISP] button.

Clearing All Images from the Print List

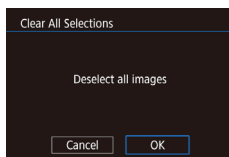

- Following step 1 in “Setting Up Printing for Individual Images” (182), choose [Clear All Selections] and press the [DISP] button.
- Press the [◀][▶] buttons or turn the [DISP] dial to choose [OK], and then press the [DISP] button.

Adding Images to a Photobook

▶ Still Images ▶ Movies

Photobooks can be set up on the camera by choosing up to 998 images on a memory card and transferring them into the software on your computer, where they are stored in their own folder. This is convenient when ordering printed photobooks online or printing photobooks with your own printer.

Choosing a Selection Method

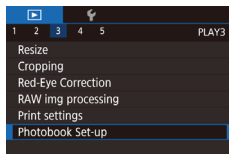

- Press the [MENU] button, choose [Photobook Set-up] on the [▶]3 tab, and then choose how you will select images.



- [!] may be displayed on the camera to warn you that the memory card has print settings that were configured on another camera. Changing the print settings using this camera may overwrite all previous settings.

Before Use

Basic Guide

Advanced Guide

Camera Basics

Auto Mode /
Hybrid Auto Mode

Other Shooting Modes

P Mode

Tv, Av, M, C1, and C2 Mode

Playback Mode

Wireless Features

Setting Menu

Accessories

Appendix

Index



Adding Images Individually

▶ Still Images ▶ Movies

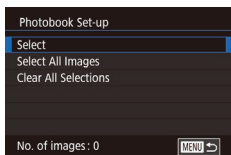

1 Choose [Select].

- Following the procedure in “Choosing a Selection Method” (183), choose [Select] and press the button.



2 Choose an image.

- Press the buttons or turn the dial to choose an image, and then press the button.
- is displayed.
- To remove the image from the photobook, press the button again. is no longer displayed.
- Repeat this process to specify other images.
- When finished, press the **[MENU]** button to return to the menu screen.

Adding All Images to a Photobook

▶ Still Images ▶ Movies

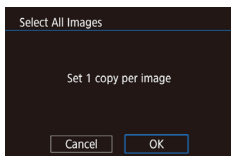

- Following the procedure in “Choosing a Selection Method” (183), choose [Select All Images] and press the button.
- Press the buttons or turn the dial to choose [OK], and then press the button.

Removing All Images from a Photobook

▶ Still Images ▶ Movies

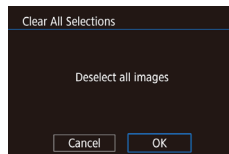

- Following the procedure in “Choosing a Selection Method” (183), choose [Clear All Selections] and press the button.
- Press the buttons or turn the dial to choose [OK], and then press the button.

Before Use

Basic Guide

Advanced Guide

Camera Basics

Auto Mode /
Hybrid Auto Mode

Other Shooting Modes

P Mode

Tv, Av, M, C1, and C2 Mode

Playback Mode

Wireless Features

Setting Menu

Accessories

Appendix

Index



Appendix

Helpful information when using the camera

Troubleshooting

If you think there is a problem with the camera, first check the following. If the items below do not solve your problem, contact a Canon Customer Support Help Desk.

Power

Nothing happens when the power switch is set to [ON].

- Confirm that the battery pack is charged (19).
- Confirm that the battery pack is inserted facing the correct way (20).
- Confirm that the memory card/battery cover is fully closed (20).
- Dirty battery terminals reduce battery performance. Try cleaning the terminals with a cotton swab and reinserting the battery pack a few times.

The battery pack runs out of power quickly.

- Battery performance decreases at low temperatures. Try warming the battery pack a little by putting it in your pocket, for example, ensuring that the terminals do not touch any metal objects.
- Dirty battery terminals reduce battery performance. Try cleaning the terminals with a cotton swab and reinserting the battery pack a few times.
- If these measures do not help and the battery pack still runs out of power soon after charging, it has reached the end of its life. Purchase a new battery pack.

The battery pack is swollen.

- Battery swelling is normal and does not pose any safety concerns. However, if battery swelling prevents the battery pack from fitting in the camera, contact a Canon Customer Support Help Desk.

The camera makes a noise when turned on or off with an EF-M lens attached.

- When you turn off the camera, the aperture narrows to prevent light from entering the camera. This protects internal components.

Before Use

Basic Guide

Advanced Guide

Camera Basics

Auto Mode /
Hybrid Auto Mode

Other Shooting Modes

P Mode

Tv, Av, M, C1, and C2 Mode

Playback Mode

Wireless Features

Setting Menu

Accessories

Appendix

Index



Shooting

Cannot shoot.

- The camera cannot shoot unless subjects are in focus. Wait until the frame turns green, as you press the shutter button halfway and allow the camera to focus, before attempting to shoot.
- In Playback mode (📖103), press the shutter button halfway (📖31).

Strange display on the screen under low light (📖34).

Strange display on the screen when shooting.

- Note that the following display problems are not recorded in still images but are recorded in movies.
 - The screen may flicker and horizontal banding may appear under fluorescent or LED lighting.

⚡ flashes on the screen when the shutter button is pressed, and shooting is not possible (📖42).

📷 is displayed when the shutter button is pressed halfway (📖42).

- Shoot with image stabilization (📖86).
- Raise the flash and set the flash mode to ⚡ (📖82).
- Increase the ISO speed (📖71).
- Mount the camera on a tripod or take other measures to keep it still. In this case, also disable image stabilization (📖86).

Shots are out of focus.

- Shoot with auto focus (AF).
- Press the shutter button halfway to focus on subjects before pressing it all the way down to shoot (📖31).
- Focusing is not possible if you are closer to the subject than the minimum focusing distance of the lens. To determine the minimum focusing distance, check the lens. The lens minimum focusing distance is measured from the [∞] (focal plane) mark on the top of the camera to the subject.
- Set [AF-assist beam (LED) firing] to [Enable] (📖51).
- Confirm that you have deactivated any features you do not wish to use, such as manual focus.
- Try shooting with focus lock or AF lock (📖78, 📖79).

Shots are blurry.

- Blurring may occur more often when Touch Shutter is used to shoot, depending on shooting conditions. Hold the camera still when shooting.

AF frames are orange and subjects remain out of focus when I press the shutter button halfway.

- Before you press the shutter button halfway, try centering higher-contrast portions of subjects. Otherwise, try pressing the shutter button halfway repeatedly. These approaches may help the camera focus, which is indicated by a green AF frame.

Subjects in shots look too dark.

- Raise the flash and set the flash mode to ⚡ (📖82).
- Adjust brightness by using exposure compensation (📖69).
- Adjust brightness by using the Auto Lighting Optimizer (📖72).
- Use AE lock or partial metering (📖70).

Subjects look too bright, highlights are washed-out.

- Lower the flash and set the flash mode to ☀️ (📖39).
- Adjust brightness by using exposure compensation (📖69).
- Use AE lock or partial metering (📖70).
- Reduce the lighting on subjects.

Shots look too dark despite the flash firing (📖42).

- Shoot within flash range (📖213).
- Adjust brightness by using flash exposure compensation or changing the flash output level (📖83, 📖93).
- Increase the ISO speed (📖71).

Subjects in flash shots look too bright, highlights are washed-out.

- Shoot within flash range (📖213).
- Lower the flash and set the flash mode to ☀️ (📖39).
- Adjust brightness by using flash exposure compensation or changing the flash output level (📖83, 📖93).

White spots appear in flash shots.

- This is caused by light from the flash reflecting off dust or airborne particles.

Shots look grainy.

- Lower the ISO speed (📖71).
- High ISO speeds in some shooting modes may cause grainy images (📖56).

Before Use

Basic Guide

Advanced Guide

Camera Basics

Auto Mode /
Hybrid Auto Mode

Other Shooting Modes

P Mode

Tv, Av, M, C1, and C2 Mode

Playback Mode

Wireless Features

Setting Menu

Accessories

Appendix

Index



Shots are affected by linear noise or moiré.

- Some subjects make shots more susceptible to linear noise or moiré. This is more likely to happen under the following conditions.
 - Subjects have fine horizontal stripes or checkered patterns.
 - The sun, lights, or other sources of bright light are visible on the shooting screen, or are nearby.

In this case, taking the following steps may reduce noise or moiré.

- Resize the subject by changing the focusing distance or zooming in or out.
 - Recompose the shot to keep sources of bright light off the shooting screen.
 - Attach a lens hood to prevent bright light from shining into the lens.
- Images may also be affected by linear noise or moiré if you shift or tilt a TS-E lens.

Subjects are affected by red-eye.

- Set [Red-eye reduc.] to [On] (📖51). The red-eye reduction lamp (📖4) will light up for flash shots. For best results, have subjects look at the red-eye reduction lamp. Also try increasing the lighting in indoor scenes and shooting at closer range.
- Edit images using red-eye correction (📖121).

Recording to the memory card takes too long, or continuous shooting is slower.

- Use the camera to perform low-level formatting of the memory card (📖156).

Continuous shooting suddenly stops.

- Continuous shooting stops automatically to protect the camera after about 1,000 shots are taken at one time. Release the shutter button a moment before you resume shooting.

Shooting settings or Quick Set menu settings are not available.

- Available setting items vary by shooting mode. Refer to "Functions Available in Each Shooting Mode", "Quick Set Menu", "Shooting Tab", "C.Fn Tab", "INFO. Quick Control", and "Set Up Tab" (📖194 – 📖209).

Touch AF or Touch Shutter does not work.

- Touch AF or Touch Shutter will not work if you touch the edges of the screen. Touch closer to the center of the screen.

Shooting Movies

The elapsed time shown is incorrect, or recording is interrupted.

- Use the camera to format the memory card, or switch to a card that supports high-speed recording. Note that even if the elapsed time display is incorrect, the length of movies on the memory card corresponds to the actual recording time.

[!] is displayed and shooting stops automatically.

- The camera's internal memory buffer filled up as the camera could not record to the memory card quickly enough. Try one of the following measures.
 - Use the camera to perform low-level formatting of the memory card (📖156).
 - Lower the image quality (📖49).
 - Switch to a memory card that supports high-speed recording.

Subjects look distorted.

- Subjects that pass in front of the camera quickly may look distorted. This is not a malfunction.

The movie has still moments.

- With some lenses, movies may seem to be missing frames at moments when the brightness changes significantly.

Playback

Playback is not possible.

- Image or movie playback may not be possible if a computer is used to rename files or alter the folder structure.

Playback stops, or audio skips.

- Switch to a memory card that you have performed low-level formatting on with the camera (📖156).
- There may be brief interruptions when playing movies copied to memory cards that have slow read speeds.
- When movies are played on a computer, frames may be dropped and audio may skip if computer performance is inadequate.

Sound is not played during movies.

- Adjust the volume (📖103) if the sound in the movie is faint.
- No sound is played for movies shot in [📷] (📖62) or [📹] (📖65) mode because audio is not recorded in these modes.

Before Use

Basic Guide

Advanced Guide

Camera Basics

Auto Mode /
Hybrid Auto Mode

Other Shooting Modes

P Mode

Tv, Av, M, C1, and C2 Mode

Playback Mode

Wireless Features

Setting Menu

Accessories

Appendix

Index



Computer

Cannot transfer images to a computer.

- When attempting to transfer images to the computer via a cable, try reducing the transfer speed as follows.
 - Press the [▶] button to enter Playback mode. Hold the [MENU] button down as you press the [▲] and [Ⓜ] buttons at the same time. On the next screen, press the [◀] [▶] buttons or turn the [Ⓜ] dial to choose [B], and then press the [Ⓜ] button.

Wi-Fi

Cannot access the Wi-Fi menu by pressing the [Wi-Fi] button.

- The Wi-Fi menu cannot be accessed while the camera is connected to a printer via a cable. Disconnect the cable.

Cannot add a device/destination.

- A total of 20 items of connection information can be added to the camera. Erase unneeded connection information from the camera first, and then add new devices/destinations (📖151).
- Use a computer or smartphone to register Web services (📖136).
- To add a smartphone, first install the dedicated application Camera Connect on your smartphone (📖128).
- Do not use the camera near sources of Wi-Fi signal interference such as microwave ovens or other equipment operating on the 2.4 GHz band.
- Bring the camera closer to the other device you are trying to connect to (such as the access point), and make sure there are no objects between the devices.

Cannot connect to the access point.

- Confirm that the access point channel is set to a channel supported by the camera (📖216). Note that instead of auto channel assignment, it is advisable to specify a supported channel manually.

Cannot send images.

- The destination device has insufficient storage space. Increase the storage space on the destination device and resend the images.
- The write-protect switch of the memory card in the destination camera is set to the locked position. Slide the write-protect switch to the unlocked position.
- RAW images cannot be sent to the camera or displayed on TV sets. RAW images selected for importing to a smartphone are imported as JPEG images. Note that Image Sync can also send RAW images.
- Images are not sent to CANON iIMAGE GATEWAY or other Web services if you move or rename image files or folders on the computer that received images sent using Image Sync via an access point (📖147). Before moving or renaming these image files or folders on the computer, make sure the images have already been sent to CANON iIMAGE GATEWAY or other Web services.

Cannot resize images for sending.

- Images cannot be resized to be bigger than the recording pixel setting of their original size.
- Movies cannot be resized.

Images take a long time to send./The wireless connection is disrupted.

- Multiple images may take a long time to send. Try resizing the image to reduce sending time (📖146).
- Movies may take a long time to send.
- Do not use the camera near sources of Wi-Fi signal interference such as microwave ovens or other equipment operating on the 2.4 GHz band. Note that images may take a long time to send even when [Wi-Fi] is displayed.
- Bring the camera closer to the other device you are trying to connect to (such as the access point), and make sure there are no objects between the devices.

No notification message is received on a computer or smartphone after adding CANON iIMAGE GATEWAY to the camera.

- Make sure the email address you entered is correct, and try adding the destination again.
- Check the email settings on the computer or smartphone. If they are configured to block email from certain domains, you may not be able to receive the notification message.

Want to erase Wi-Fi connection information before disposing of the camera or giving it to someone else.

- Reset the Wi-Fi settings (📖153).

Before Use

Basic Guide

Advanced Guide

Camera Basics

Auto Mode / Hybrid Auto Mode

Other Shooting Modes

P Mode

Tv, Av, M, C1, and C2 Mode

Playback Mode

Wireless Features

Setting Menu

Accessories

Appendix

Index



On-Screen Messages

If an error message is displayed, respond as follows.

Shooting or Playback

No memory card

- The memory card may be inserted facing the wrong way. Reinsert the memory card facing the correct way (📖20).

Memory card locked

- The write-protect switch of the memory card is set to the locked position. Switch the write-protect switch to the unlocked position (📖20).

Cannot record!

- Shooting was attempted without a memory card in the camera. To shoot, insert a memory card facing the correct way (📖20).

Memory card error (📖156)

- If the same error message is displayed even after you have formatted a supported memory card (📖2) and have inserted it facing the correct way (📖20), contact a Canon Customer Support Help Desk.

Insufficient space on card

- There is not enough free space on the memory card to shoot (📖39, 📖53, 📖68) or edit images (📖118). Either erase unneeded images (📖114) or insert a memory card with enough free space (📖20).

Touch AF unavailable

- Touch AF is not available in the current shooting mode (📖194).

Touch AF canceled

- The subject selected for Touch AF can no longer be detected (📖79).

Charge the battery (📖19)

No Image.

- The memory card does not contain any images that can be displayed.

Protected! (📖112)

Unidentified Image/Incompatible JPEG/Image too large./Cannot play back MOV/Cannot play back MP4

- Unsupported or corrupt images cannot be displayed.
- It may not be possible to display images that were edited or renamed on a computer, or images shot with another camera.

Cannot magnify!/Cannot rotate/Cannot modify image/Cannot modify/Unselectable image.

- The following functions may be unavailable for images that were renamed or already edited on a computer, or images shot with another camera. Note that starred (*) functions are not available for movies. Magnify* (📖110), Rotate* (📖116), Rating (📖117), Edit* (📖118), Print List* (📖181), and Photobook Set-up* (📖183).

Invalid selection range

- When specifying a range for image selection (📖113, 📖115, 📖183), you attempted to choose an initial image that was after the final image, or vice-versa.

Exceeded selection limit

- More than 998 images were selected for Print List (📖181) or Photobook Set-up (📖183). Choose 998 images or less.
- Print List (📖181) or Photobook Set-up (📖183) settings could not be saved correctly. Reduce the number of selected images and try again.
- You attempted to choose more than 500 images in Protect (📖112), Erase (📖114), Rating (📖117), Print List (📖181), or Photobook Set-up (📖183).

Naming error!

- The folder could not be created or images could not be recorded, because the highest supported folder number (999) for storing images on the card has been reached and the highest supported image number (9999) for images in folders has been reached. On the [👉1] tab of the menu (📖35), change [File Numbering] to [Auto Reset] (📖155), or format the memory card (📖156).

Lens Error

- There is a communication problem between the camera and lens. Clean the lens contacts and mount the lens correctly on the camera.
- Frequent display of this error message may indicate camera damage. In this case, contact a Canon Customer Support Help Desk.

Before Use

Basic Guide

Advanced Guide

Camera Basics

Auto Mode /
Hybrid Auto Mode

Other Shooting Modes

P Mode

Tv, Av, M, C1, and C2 Mode

Playback Mode

Wireless Features

Setting Menu

Accessories

Appendix

Index



A camera error was detected (*error number*)

- If this error message is displayed immediately after a shot, the image may not have been saved. Switch to Playback mode to check for the image.
- Frequent display of this error message may indicate camera damage. In this case, write down the error number (*Exx*) and contact a Canon Customer Support Help Desk.

File Error

- Correct printing (📖178) may not be possible for photos from other cameras or images that have been altered using computer software, even if the camera is connected to the printer.

Print error

- Check the paper size setting (📖180). If this error message is displayed when the setting is correct, restart the printer and complete the setting on the camera again.

Ink absorber full

- Contact a Canon Customer Support Help Desk to request assistance with ink absorber replacement.

Wi-Fi

Connection failed

- No access points were recognized. Check the access point settings (📖134).
- A device could not be found. Turn the camera off and on again, and retry the connection.
- Check the device you want to connect to and make sure it is ready for connection.

Cannot determine access point

- The WPS buttons on numerous access points were pressed simultaneously. Try reconnecting again.

No access points found

- Check to make sure that the access point is turned on.
- When connecting to an access point manually, make sure that you entered the correct SSID.

Incorrect password/Incorrect Wi-Fi security settings

- Check the access point security settings (📖134).

IP address conflict

- Reset the IP address so that it does not conflict with another.

Disconnected/Receiving failed/Sending failed

- You may be in an environment where Wi-Fi signals are obstructed.
- Avoid using the camera's Wi-Fi function around microwave ovens, Bluetooth devices, and other devices that operate on the 2.4 GHz band.
- Bring the camera closer to the other device you are trying to connect to (such as the access point), and make sure there are no objects between the devices.
- Check the connected device to make sure it is not experiencing errors.

Sending failed

Memory card error

- If the same error message is displayed even when you have inserted a formatted memory card facing the correct way, contact a Canon Customer Support Help Desk.

Receiving failed

Insufficient space on card

- There is not enough free space on the memory card in the target camera to receive images. Erase images to create space on the memory card, or insert a memory card with sufficient space.

Receiving failed

Memory card locked

- The write-protect switch of the memory card in the camera to receive the images is set to the locked position. Slide the write-protect switch to the unlocked position.

Receiving failed

Naming error!

- When the highest folder number (999), and the highest image number (9999) have been reached on the receiving camera, images cannot be received.

Insufficient space on server

- Delete unnecessary images uploaded to CANON iMAGE GATEWAY to create space.
- Save the images sent via Image Sync (📖147) to your computer.

Check network settings

- Check to make sure your computer can connect to the Internet with the current network settings.

Before Use

Basic Guide

Advanced Guide

Camera Basics

Auto Mode /
Hybrid Auto Mode

Other Shooting Modes

P Mode

Tv, Av, M, C1, and C2 Mode

Playback Mode

Wireless Features

Setting Menu

Accessories

Appendix

Index



On-Screen Information

When Shooting

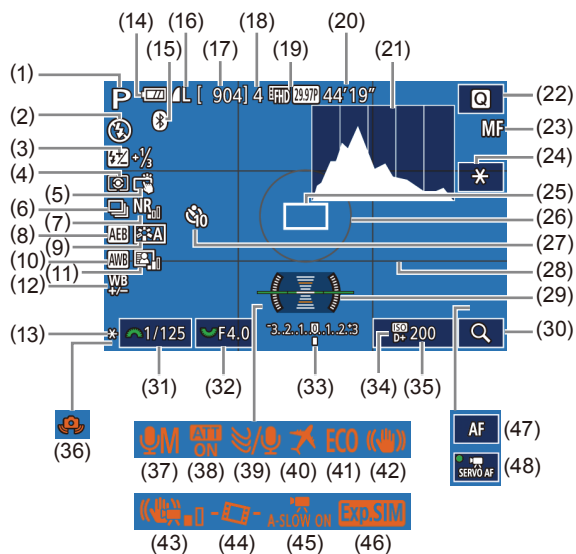

- (1) Shooting mode (📖194), Scene icon (📖43)
- (2) Flash mode (📖82)
- (3) Flash exposure compensation / Flash output level (📖83, 📖93)
- (4) Metering mode (📖70)
- (5) Touch Shutter (📖46)
- (6) Continuous shooting (📖46)
- (7) High ISO speed noise reduction (📖88)
- (8) AEB (📖71)
- (9) Picture Style (📖75)
- (10) White balance (📖73)

- (11) Auto Lighting Optimizer (📖72)
- (12) White balance correction (📖74)
- (13) AE lock (📖70)
- (14) Battery level (📖191)
- (15) Bluetooth connection status (📖128)
- (16) Still image quality (compression, recording pixel setting) (📖47)
- (17) Recordable shots
- (18) Maximum continuous shots
- (19) Movie quality (recording pixel, frame rate) (📖49)
- (20) Remaining time
- (21) Histogram (📖106)
- (22) Quick Set menu (📖34)
- (23) Manual focus (📖81)
- (24) Movie AE lock (📖64)
- (25) AF frame (📖77)
- (26) Metering frame (📖70)
- (27) Self-timer (📖44)
- (28) Grid lines (📖34)
- (29) Electronic level (📖50)
- (30) Magnify (📖81)
- (31) Shutter speed (📖90)
- (32) Aperture value (📖91)
- (33) Exposure compensation (📖69)
- (34) Highlight tone priority (📖72)
- (35) ISO speed (📖71)
- (36) Camera shake warning (📖42)
- (37) Audio recording mode (📖66)
- (38) Attenuator (📖67)
- (39) Wind filter (📖67)
- (40) Time zone (📖159)
- (41) Eco mode (📖157)
- (42) Image stabilization (📖86)
- (43) Digital IS (📖86)
- (44) Auto level (📖51)
- (45) Auto slow shutter (📖65)
- (46) Exposure simulation (📖69)
- (47) AF/MF indicator (📖64)
- (48) Movie Servo AF (📖64)

Battery Level

An on-screen icon or message indicates the battery charge level.

Display	Details
	Sufficient charge
	Slightly depleted, but sufficient
(Blinking red)	Nearly depleted—charge the battery pack soon
[Charge the battery]	Depleted—charge the battery pack immediately

Before Use

Basic Guide

Advanced Guide

Camera Basics

Auto Mode / Hybrid Auto Mode

Other Shooting Modes

P Mode

Tv, Av, M, C1, and C2 Mode

Playback Mode

Wireless Features

Setting Menu

Accessories

Appendix

Index



During Playback

Info Display 1

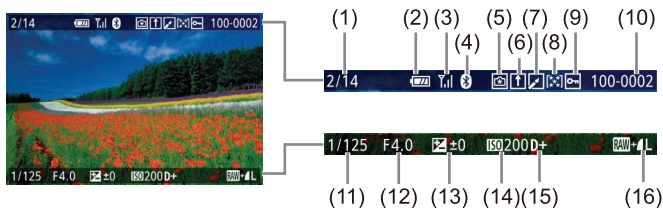

- | | |
|---|----------------------------------|
| (1) Current image / Total images | (9) Protection |
| (2) Battery level | (10) Folder number – File number |
| (3) Wi-Fi signal strength | (11) Shutter speed |
| (4) Bluetooth connection status | (12) Aperture value |
| (5) Settings can be applied to [★] mode | (13) Exposure compensation level |
| (6) Image Sync complete | (14) ISO speed |
| (7) Edited*1 | (15) Highlight tone priority |
| (8) Rating | (16) Image quality*2 |

*1 Displayed for images with a creative filter, resizing, cropping, or red-eye correction applied.

*2 Cropped images are labeled with [□].

Info Display 2

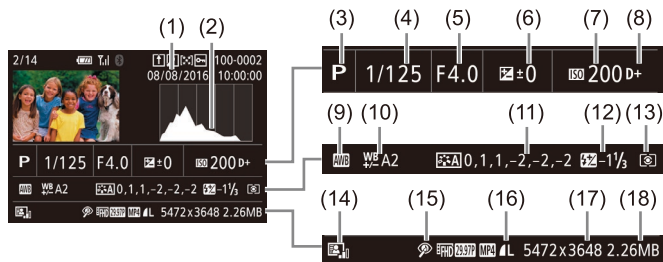

- | | |
|---------------------------------|------------------------------------|
| (1) Shooting date/time | (10) White balance correction |
| (2) Histogram | (11) Picture Style setting details |
| (3) Shooting mode | (12) Flash exposure compensation |
| (4) Shutter speed | (13) Metering mode |
| (5) Aperture value | (14) Auto Lighting Optimizer |
| (6) Exposure compensation level | (15) Red-eye correction |
| (7) ISO speed | (16) Image quality* |
| (8) Highlight tone priority | (17) Recording pixel setting |
| (9) White balance | (18) Image size |

* Cropped images are labeled with [□].

Info Display 3

Shows the lens name, focal length, and an RGB histogram. Note that long lens names may not be fully displayed. Information on the top of the screen is the same as for Info Display 2.

Info Display 4

Shows white balance information. Information on the top of the screen is the same as for Info Display 2.

Before Use

Basic Guide

Advanced Guide

Camera Basics

Auto Mode /
Hybrid Auto Mode

Other Shooting Modes

P Mode

Tv, Av, M, C1, and C2 Mode

Playback Mode

Wireless Features

Setting Menu

Accessories

Appendix

Index



Info Display 5

Shows Picture Style information. Information on the top of the screen is the same as for Info Display 2.

Info Display 6

Shows noise-reduction settings for long exposures and high ISO speeds. Information on the top of the screen is the same as for Info Display 2.

Info Display 7









Shows lens correction data and information about correction of peripheral illumination, chromatic aberration, and diffraction. Information on the top of the screen is the same as for Info Display 2.

Info Display 8

Shows GPS information. Information on the top of the screen is the same as for Info Display 2.

Summary of Movie Control Panel

The following operations are available on the movie control panel, accessed as described in “Viewing” (103).

	Shown when the camera is connected to a PictBridge-compatible printer (178).
	Play
	Slow Motion (To adjust the playback speed, press the [◀][▶] buttons or turn the [⦿] dial. No sound is played.)
	Skip Backward* or Previous Clip (126) (To continue skipping backward, keep holding down the [⏮] button.)
	Previous Frame (For fast-rewind, keep holding down the [⏪] button.)
	Next Frame (For fast-forward, keep holding down the [⏩] button.)
	Skip Forward* or Next Clip (126) (To continue skipping forward, keep holding down the [⏭] button.)
	Erase Clip (displayed when a digest movie is selected, 126)
	Edit (124)

* Displays the frame approx. 4 sec. before or after the current frame.



- During movie playback, you can skip back or forward (or to the previous or next clip) by pressing the [◀][▶] buttons.
- To switch frames, touch the scrollbar or drag left or right.

Before Use

Basic Guide

Advanced Guide

Camera Basics

Auto Mode /
Hybrid Auto Mode

Other Shooting Modes

P Mode

Tv, Av, M, C1, and C2 Mode

Playback Mode

Wireless Features

Setting Menu

Accessories

Appendix

Index



Functions and Menu Tables

Functions Available in Each Shooting Mode

Function	Shooting Mode	Shooting Mode																								
		C1 / C2	M	Av	Tv	P	A+	A-	A	Handheld	Self-timer	Macro	Flower	Portrait	Background	Low-key	HDR	Color	Color	Color	Color	Color	Color	Color	Color	
Exposure Compensation (📖69)		*1	○	○	○	○	-	-	*2	○	*2	○	○	○	○	○	○	○	○	○	○	○	○	○	○	○
ISO Speed (📖71)	AUTO	*1	○	○	○	○	○	○	○	○	○	○	○	○	○	○	○	○	○	○	○	○	○	○	○	○
	100 – 6400	*1	○	○	○	○	-	-	-	-	-	-	-	-	-	-	-	-	-	-	-	-	-	-	○	-
	8000 – 25600	*1	○	○	○	○	-	-	-	-	-	-	-	-	-	-	-	-	-	-	-	-	-	-	-	-
Flash (📖82)	Auto	*1	-	-	-	○	○	○	○	-	-	○	-	○	-	○	-	○	○	○	○	○	○	○	-	-
	On	*1	○	○	○	○	-	-	○	-	○	○	-	○	○	-	○	○	○	○	○	○	○	○	-	-
	Slow Synchro	*1	-	○	-	○	*3	*3	○	-	-	-	-	-	-	-	*3	-	-	-	-	-	-	-	-	-
	Off	*1	○	○	○	○	○	○	○	○	○	○	○	○	○	○	○	○	○	○	○	○	○	○	○	○
External Flash Firing (📖172)		○	○	○	○	○	○	○	-	○	○	-	○	○	-	○	-	○	○	○	○	○	○	○	-	-
Flash Exposure Compensation (📖83)		*1	○	○	○	○	-	-	*4	-	*4	-	-	-	-	-	-	-	-	-	-	-	-	-	-	-
Flash Output Level (📖93)		*1	○	○	○	-	-	-	-	-	-	-	-	-	-	-	-	-	-	-	-	-	-	-	-	-
Aperture Value (📖91)		*1	○	○	-	-	-	-	-	-	-	-	-	-	-	-	-	-	-	-	-	-	-	-	○	-
Shutter Speed (📖90)		*1	○	-	○	-	-	-	-	-	-	-	-	-	-	-	-	-	-	-	-	-	-	-	○	-
Bulb Exposure (📖93)		*1	○	-	-	-	-	-	-	-	-	-	-	-	-	-	-	-	-	-	-	-	-	-	-	-
Program Shift (📖70)		*1	-	-	-	○	-	-	-	-	-	-	-	-	-	-	-	-	-	-	-	-	-	-	-	○
AE Lock (📖64, 📖70) FE Lock (📖84)		○	○	○	○	○	-	-	-	-	-	-	-	-	-	-	-	-	-	-	-	-	-	-	○	○
AE Lock (during recording), Exposure Compensation (📖64)		○	○	○	○	○	-	-	-	○	-	○	○	○	○	○	○	○	○	○	○	○	○	○	○	-

Before Use

Basic Guide

Advanced Guide

Camera Basics

Auto Mode / Hybrid Auto Mode

Other Shooting Modes

P Mode

Tv, Av, M, C1, and C2 Mode

Playback Mode

Wireless Features

Setting Menu

Accessories

Appendix

Index



Function	Shooting Mode	C1	M	Av	Tv	P																					
		C2																									
Manual Focus (81)*5		*1	○	○	○	○	–	–	○	–	–	○	○	○	○	○	○	○	○	○	○	○	○	○	○	○	○
Manual Focus Switching When Recording Movies (64)		○	○	○	○	○	–	–	○	–	–	○	○	○	○	○	○	○	○	○	○	○	○	○	○	○	○
Move AF Frame (79)	Center	*1	○	○	○	○	–	–	○	○	–	○	○	○	○	○	○	○	○	○	○	○	○	○	○	○	○
	Periphery	*1	○	○	○	○	–	–	○	○	–	○	○	○	○	○	○	○	○	○	○	○	○	○	○	○	○
Touch AF (79)		○	○	○	○	○	○	○	○	○	○	○	○	○	○	○	○	○	○	○	○	○	○	○	○	○	○
Face Select (79)		○	○	○	○	○	○	○	○	○	○	○	○	○	○	○	○	○	○	○	○	○	○	○	○	○	○
Magnified Display (81)		*1	○	○	○	○	–	–	○	○	–	○	○	○	○	○	○	○	○	○	○	○	○	○	○	○	○
Touch Shutter (46)		○	○	○	○	○	○	○	○	○	○	○	○	○	○	○	○	○	○	○	○	○	○	○	○	○	○
Change Display (34, 69)	Info Display 1/ Info Display 2/ No Information Display	○	○	○	○	○	○	○	○	○	○	○	○	○	○	○	○	○	○	○	○	○	○	○	○	○	○
	INFO. Quick Control	*1	○	○	○	○	–	–	–	–	–	–	–	–	–	–	–	–	–	–	–	–	○	○	○	○	

*1 Options vary depending on the assigned shooting mode.

*2 Set in [Brightness].

*3 Not available, but switches to in some cases.

*4 Adjusted to suit the [Brightness] setting.

*5 Manual focus when set to MF using the switch on EF or EF-S lenses.

*6 Only available for shooting. Subject designation not available.

○ Available or set automatically. – Not available.

Before Use

Basic Guide

Advanced Guide

Camera Basics

Auto Mode /
Hybrid Auto Mode

Other Shooting Modes

P Mode

Tv, Av, M, C1, and C2 Mode

Playback Mode

Wireless Features

Setting Menu

Accessories

Appendix

Index



Quick Set Menu

Function		Shooting Mode		C1	M	Av	Tv	P																																	
		C2																																							
AF method (📖77)	AF	*1	○	○	○	○	○	○	○	○	*2	○	○	○	○	○	○	○	○	○	○	○	○	○	○	○	○	○	○	○	○	○	○	○	○	○	○	○	○		
	AF ()	*1	○	○	○	○	○	-	-	*2	○	-	○	○	○	○	○	○	○	○	○	○	○	○	○	○	○	○	○	○	○	○	○	○	○	○	○	○	○	○	
	AF □	*1	○	○	○	○	○	-	-	*2	○	-	○	○	○	○	○	○	○	○	○	○	○	○	○	○	○	○	○	○	○	○	○	○	○	○	○	○	○	○	○
AF operation (📖80)	ONESHOT	*1	○	○	○	○	○	○	○	*2	-	○	○	○	○	○	○	○	○	○	○	○	○	○	○	○	○	○	○	○	○	○	○	○	○	○	○	○	○	○	
	SERVO	*1	○	○	○	○	○	-	-	*2	○	-	-	-	-	-	○	-	○	○	-	○	○	-	○	○	-	○	-	○	-	○	-	○	-	○	-	○	-		
Image quality (📖47)		For details, see "Shooting Tab" (📖198).																																							
Movie rec. size (📖49)	When Set to NTSC		*1	○	○	○	○	○	○	○	○	○	○	○	○	○	○	○	○	○	○	○	○	○	○	○	○	○	○	○	○	○	○	○	○	○	○	○	○		
			*1	○	○	○	○	○	○	○	○	○	○	○	○	○	○	○	○	○	○	○	○	○	○	○	○	○	○	○	○	○	○	○	○	○	*3	○	○	○	○
			*1	○	○	○	○	○	○	○	○	○	○	○	○	○	○	○	○	○	○	○	○	○	○	○	○	○	○	○	○	○	○	○	○	○	○	○	○	○	○
	When Set to PAL		*1	○	○	○	○	○	○	○	○	○	○	○	○	○	○	○	○	○	○	○	○	○	○	○	○	○	○	○	○	○	○	○	○	*3	○	○	○	○	○
			*1	○	○	○	○	○	○	○	○	○	○	○	○	○	○	○	○	○	○	○	○	○	○	○	○	○	○	○	○	○	○	○	○	○	○	○	○	○	○
			*1	○	○	○	○	○	○	○	○	○	○	○	○	○	○	○	○	○	○	○	○	○	○	○	○	○	○	○	○	○	○	○	○	○	*3	○	○	○	○
Drive mode (📖46)		*1	○	○	○	○	○	○	○	○	○	○	○	○	○	○	○	○	○	○	○	○	○	○	○	○	○	○	○	○	○	○	○	○	○	○	○	○	○		
		*1	○	○	○	○	○	○	-	-	○	-	○	○	○	○	○	○	○	○	○	○	○	○	○	○	○	○	○	○	○	○	○	○	○	○	○	○	○	○	
		*1	○	○	○	○	○	○	-	-	○	-	○	○	○	○	○	○	○	○	○	○	○	○	○	○	○	○	○	○	○	○	○	○	○	○	○	○	○	○	
Self-timer/Remote ctrl (📖44)		*1	○	○	○	○	○	○	○	○	○	○	○	○	○	○	○	○	○	○	○	○	○	○	○	○	○	○	○	○	○	○	○	○	○	○	○	○	○	○	
		*1	○	○	○	○	○	○	○	-	○	○	○	○	○	○	○	○	○	○	○	○	○	○	○	○	○	○	○	○	○	○	○	○	○	○	○	○	○	○	
		*1	○	○	○	○	○	○	○	-	○	-	○	○	○	○	○	○	○	○	○	○	○	○	○	○	○	○	○	○	○	○	○	○	○	○	○	○	○	○	○
Self-Timer Settings	Custom Timer	Delay	*1	○	○	○	○	○	○	○	-	○	○	○	○	○	○	○	○	○	○	○	○	○	○	○	○	○	○	○	○	○	○	○	○	○	○	○	○	○	
		Shots	*1	○	○	○	○	○	○	-	○	-	○	○	○	○	○	○	○	○	○	○	○	○	○	○	○	○	○	○	○	○	○	○	○	○	○	○	○	○	

Before Use

Basic Guide

Advanced Guide

Camera Basics

Auto Mode / Hybrid Auto Mode

Other Shooting Modes

P Mode

Tv, Av, M, C1, and C2 Mode

Playback Mode

Wireless Features

Setting Menu

Accessories

Appendix

Index



Function		Shooting Mode		Icons representing various camera functions																															
		C1	C2	M	Av	Tv	P	A+	[A]	[S]	[M]	[L]	[P]	[N]	[F]	[M]	[1]	[2]	[3]	[A]	[S]	[M]	[L]	[P]	[N]	[F]	[M]	[1]	[2]	[3]					
White balance (73)	[AWB]	*1		O	O	O	O	O	O	O	O	O	O	O	O	O	O	O	O	O	O	O	O	O	O	O	O	O	O	O	O	O	O		
	[Sun]/[Home]/[Cloud]/[Lightning]	*1		O	O	O	O	-	-	-	-	-	-	-	-	-	-	-	-	-	-	-	-	-	-	-	-	-	-	-	-	-			
	[Lightning]	*1		O	O	O	O	-	-	-	-	-	-	-	-	-	-	-	-	-	-	-	-	-	-	-	-	-	-	-	-	-			
	[K]	*1		O	O	O	O	-	-	-	-	-	-	-	-	-	-	-	-	-	-	-	-	-	-	-	-	-	-	-	-	-			
Picture Style (75)	[A]	*1		O	O	O	O	O	O	-	O	-	O	O	O	O	O	O	O	-	O	-	-	-	-	-	-	-	-	-	-	O	O	O	
	[S]	*1		O	O	O	O	-	-	O	-	O	-	-	-	-	-	-	-	O	-	O	O	O	O	O	O	O	O	O	O	O	O		
	[P]/[L]/[F]/[M]/[N]/[F]/[M]/[1]/[2]/[3]	*1		O	O	O	O	-	-	-	-	-	-	-	-	-	-	-	-	-	-	-	-	-	-	-	-	-	-	-	-	O	O	O	
Metering mode (70)	[C]	*1		O	O	O	O	O	O	O	O	O	O	O	O	O	O	O	O	O	O	O	O	O	O	O	O	O	O	O	O	O	O		
	[C]/[P]/[A]	*1		O	O	O	O	-	-	-	-	-	-	-	-	-	-	-	-	-	-	-	-	-	-	-	-	-	-	-	-	-	-	-	
Auto Lighting Optimizer (72)	[Off]	*1		O	O	O	O	-	-	O	-	O	-	-	-	-	-	-	-	-	-	-	-	-	-	-	-	-	-	-	-	O	O	-	
	[On]	*1		O	O	O	O	-	-	-	-	-	-	-	-	-	-	-	-	-	-	-	-	-	-	-	-	-	-	-	-	O	O	-	
	[On]	*1		O	O	O	O	O	O	-	O	-	O	O	O	O	O	O	O	O	O	O	-	-	-	-	-	-	-	-	-	-	O	O	-
Still Image Aspect Ratio (49)	16:9	*1		O	O	O	O	O	-	*4	O	-	O	O	O	O	O	O	O	O	O	O	O	O	O	O	O	O	O	O	O	O	*5	*5	O
	3:2	*1		O	O	O	O	O	O	*4	O	O	O	O	O	O	O	O	O	O	O	O	O	O	O	O	O	O	O	O	O	-	-	-	-
	4:3	*1		O	O	O	O	O	O	-	*4	O	-	O	O	O	O	O	O	O	O	O	O	O	O	O	O	O	O	O	O	O	*5	*5	-
	1:1	*1		O	O	O	O	O	O	-	*4	O	O	O	O	O	O	O	O	O	O	O	O	O	O	O	O	O	O	O	O	-	-	-	-

*1 Options vary depending on the assigned shooting mode.

*2 Functions can be configured on the [C3] tab.

*3 Synchronizes with the aspect ratio setting and is automatically set (62).

*4 Functions can be configured on the [C1] tab.

*5 Set automatically to suit the aspect ratio of the movie recording size.

O Available or set automatically. - Not available.

Before Use

Basic Guide

Advanced Guide

Camera Basics

Auto Mode / Hybrid Auto Mode

Other Shooting Modes

P Mode

Tv, Av, M, C1, and C2 Mode

Playback Mode

Wireless Features

Setting Menu







Accessories

Appendix

Index



Shooting Tab

Function			Shooting Mode	C1 / C2	M	A	V	Tv	P	A+	AI	A+	A+	A+	A+	A+	A+	A+	A+	A+	A+	A+	A+	A+	A+	A+	A+	A+	A+	A+	A+	A+	A+	A+	A+	A+	A+	A+	A+	
Image quality (147)	JPEG	-	*1	O	O	O	O	O	O	-	-	-	-	-	-	-	-	-	-	-	-	-	-	-	-	-	-	-	-	-	-	-	-	-	-	-	-	-	-	
			*1	O	O	O	O	O	O	O	O	O	O	O	O	O	O	O	O	O	O	O	O	O	O	O	O	O	O	O	O	O	O	O	O	O	O	O	O	O
	RAW	-	*1	O	O	O	O	O	O	O	O	O	O	O	O	O	O	O	O	O	O	O	O	O	O	O	O	O	O	O	O	O	O	O	O	O	O	O	O	O
			*1	O	O	O	O	O	O	O	-	-	O	-	O	-	-	-	-	-	-	-	-	-	-	-	-	-	-	-	-	-	-	-	-	-	-	-	-	-
Still Image Aspect Ratio (149)			See "Quick Set Menu" (196).																																					
	Shooting information display (195)	Screen info/ toggle settings	Custom display 1/ Custom display 2/ No info display/ INFO. Quick Control	O	O	O	O	O	O	O	O	O	O	O	O	O	O	O	O	O	O	O	O	O	O	O	O	O	O	O	O	O	O	O	O	O	O	O	O	
		VF info/ toggle settings	No info display/ Custom display 1/ Custom display 2	O	O	O	O	O	O	O	O	-	O	O	O	O	O	O	O	O	O	O	O	O	O	O	O	O	O	O	O	O	O	O	O	O	O	O	O	
	VF vertical display	On	*1	O	O	O	O	O	O	O	-	O	O	O	O	O	O	O	O	O	O	O	O	O	O	O	O	O	O	O	O	O	O	O	O	O	O	-	-	-
		Off	*1	O	O	O	O	O	O	O	-	O	O	O	O	O	O	O	O	O	O	O	O	O	O	O	O	O	O	O	O	O	O	O	O	O	O	O	O	O
	Grid display	3x3  /6x4  3x3+diag 	*1	O	O	O	O	O	O	O	O	O	O	O	O	O	O	O	O	O	O	O	O	O	O	O	O	O	O	O	O	O	O	O	O	O	O	O	O	O
Histogram	Brightness/ RGB	Brightness/ RGB	*1	O	O	O	O	O	O	O	O	O	O	O	O	O	O	O	O	O	O	O	O	O	O	O	O	O	O	O	O	O	O	O	O	O	O	O	O	
	Display size	Large/ Small	*1	O	O	O	O	O	O	O	O	O	O	O	O	O	O	O	O	O	O	O	O	O	O	O	O	O	O	O	O	O	O	O	O	O	O	O	O	
Expo. simulation (69)	Enable		*1	O	O	O	O	O	O	O	O	O	O	O	O	O	O	O	O	O	O	O	O	O	O	O	O	O	O	O	O	O	O	O	O	O	O	O	O	
	Disable		*1	O	O	O	O	-	-	-	-	-	-	-	-	-	-	-	-	-	-	-	-	-	-	-	-	-	-	-	-	-	-	-	-	-	-	-		
Reverse Display (33)	On		*1	O	O	O	O	O	O	O	O	O	O	O	O	O	O	O	O	O	O	O	O	O	O	O	O	O	O	O	O	O	O	O	O	O	O	O	O	
	Off		*1	O	O	O	O	O	O	O	-	O	O	O	O	O	O	O	O	O	O	O	O	O	O	O	O	O	O	O	O	O	O	O	O	O	O	O	O	

Before Use

Basic Guide

Advanced Guide

Camera Basics

Auto Mode / Hybrid Auto Mode

Other Shooting Modes

P Mode

Tv, Av, M, C1, and C2 Mode

Playback Mode

Wireless Features

Setting Menu

Accessories

Appendix

Index



Function		Shooting Mode	C1 / C2	M	Av	Tv	P													HDR																																		
	Display Mode (32)	Display priority	Power Saving	*1	○	○	○	○	○	○	○	○	○	○	○	○	○	○	○	○	○	○	○	○	○	○	○	○	○	○	○	○	○	○	○	○	○	○	○	○	○	○	○	○	○	○	○	○	○	○				
			Smooth	*1	○	○	○	○	○	○	○	-	-	-	-	-	-	-	-	-	-	-	-	-	-	-	-	-	-	-	-	-	-	-	-	-	-	-	-	-	-	-	-	-	-	-	-	-	-	-				
	VF display format (32)	Display 1/Display 2	*1	○	○	○	○	○	○	○	○	○	○	○	○	○	○	○	○	○	○	○	○	○	○	○	○	○	○	○	○	○	○	○	○	○	○	○	○	○	○	○	○	○	○	○	○	○	○	○				
	Image review (52)*2	Off/2 sec./4 sec./8 sec./Hold	*1	○	○	○	○	○	○	○	○	○	○	○	○	○	○	○	○	○	○	○	○	○	○	○	○	○	○	○	○	○	○	○	○	○	○	○	○	○	○	○	○	○	○	○	○	○	○	○	○	○		
	Touch Shutter (46)	Touch Shutter	Enable	*1	○	○	○	○	○	○	○	○	○	○	○	○	○	○	○	○	○	○	○	○	○	○	○	○	○	○	○	○	○	○	○	○	○	○	○	○	○	○	○	○	○	○	○	○	○	○	○	○		
			Disable	*1	○	○	○	○	○	○	○	○	○	○	○	○	○	○	○	○	○	○	○	○	○	○	○	○	○	○	○	○	○	○	○	○	○	○	○	○	○	○	○	○	○	○	○	○	○	○	○	○	○	
		AF frame pos'n	Center/Touch point	*1	○	○	○	○	-	-	○	○	-	○	○	○	○	○	○	○	○	○	○	○	○	○	○	○	○	○	○	○	○	○	○	○	○	○	○	○	○	○	○	○	○	○	○	○	○	○	○	○	○	
		Touch & drag AF	Enable/Disable	*1	○	○	○	○	○	○	○	○	-	○	○	○	○	○	○	○	○	○	○	○	○	○	○	○	○	○	○	○	○	○	○	○	○	○	○	○	○	○	○	○	○	○	○	○	○	○	○	○	○	○
Touch & drag AF settings (95)	Pos'n method	Absolute/Relative	*1	○	○	○	○	○	○	○	○	○	-	○	○	○	○	○	○	○	○	○	○	○	○	○	○	○	○	○	○	○	○	○	○	○	○	○	○	○	○	○	○	○	○	○	○	○	○	○	○	○		
	Active touch area	Whole panel/ Right/Left/ Top right/ Btm. right/ Top left/ Btm. left	*1	○	○	○	○	○	○	○	○	○	-	○	○	○	○	○	○	○	○	○	○	○	○	○	○	○	○	○	○	○	○	○	○	○	○	○	○	○	○	○	○	○	○	○	○	○	○	○	○	○	○	
Quick setting menu layout (99)				○	○	○	○	○	○	○	○	-	○	○	○	○	○	○	○	○	○	○	○	○	○	○	○	○	○	○	○	○	○	○	○	○	○	○	○	○	○	○	○	○	○	○	○	○	○	○	○	○	○	○

Before Use

Basic Guide

Advanced Guide

Camera Basics

Auto Mode /
Hybrid Auto Mode

Other Shooting Modes

P Mode

Tv, Av, M, C1, and C2 Mode

Playback Mode

Wireless Features

Setting Menu

Accessories

Appendix

Index



Function		Shooting Mode		C1	M	Av	Tv	P													HDR												
		C2																															
	AF operation (📖80)		See "Quick Set Menu" (📖196).																														
	AF method (📖77)		See "Quick Set Menu" (📖196).																														
	AF Frame Size*3 (📖78)	Normal	*1	○	○	○	○	○	○	○	○	○	○	○	○	○	○	○	○	○	○	○	○	○	○	○	○	○	○	○	○	○	○
		Small	*1	○	○	○	○	○	○	○	○	○	○	○	○	○	○	○	○	○	○	○	○	○	○	○	○	○	○	○	○	○	○
	Continuous AF (📖80)	On	*1	○	○	○	○	○	○	○	○	○	○	○	○	○	○	○	○	○	○	○	○	○	○	○	○	○	○	○	○	○	○
		Off	*1	○	○	○	○	○	○	○	○	○	○	○	○	○	○	○	○	○	○	○	○	○	○	○	○	○	○	○	○	○	○
	Focus mode (📖81)	AF	*1	○	○	○	○	○	○	○	○	○	○	○	○	○	○	○	○	○	○	○	○	○	○	○	○	○	○	○	○	○	○
		MF/AF+MF	*1	○	○	○	○	○	○	○	○	○	○	○	○	○	○	○	○	○	○	○	○	○	○	○	○	○	○	○	○	○	○
AF-assist beam (LED) firing (📖51)	Enable	*1	○	○	○	○	○	○	○	○	○	○	○	○	○	○	○	○	○	○	○	○	○	○	○	○	○	○	○	○	○	○	
	Disable	*1	○	○	○	○	○	○	○	○	○	○	○	○	○	○	○	○	○	○	○	○	○	○	○	○	○	○	○	○	○	○	

Before Use

Basic Guide

Advanced Guide

Camera Basics

Auto Mode / Hybrid Auto Mode

Other Shooting Modes

P Mode

Tv, Av, M, C1, and C2 Mode

Playback Mode

Wireless Features

Setting Menu

Accessories

Appendix

Index



Function		Shooting Mode		C1	M	Av	Tv	P												HDR																				
		C2																																						
	MF Peaking Settings (82)	Peaking	On	*1	O	O	O	O	-	-	O	-	-	O	O	O	O	O	O	O	O	O	O	O	O	O	O	O	O	O	O	O	O	O	O	O	O			
			Off	*1	O	O	O	O	O	O	O	O	O	O	O	O	O	O	O	O	O	O	O	O	O	O	O	O	O	O	O	O	O	O	O	O	O	O	O	
		Level	Low/High	*1	O	O	O	O	-	-	O	-	-	O	O	O	O	O	O	O	O	O	O	O	O	O	O	O	O	O	O	O	O	O	O	O	O	O	O	
	IS Settings (86)	IS Mode*4	Off	*1	O	O	O	O	-	O	O	O	O	O	O	O	O	O	O	O	O	O	O	O	O	O	O	O	O	O	O	O	O	O	O	O	O	O		
			Continuous	*1	O	O	O	O	O	O	O	O	O	O	O	O	O	O	O	O	O	O	O	O	O	O	O	O	O	O	O	O	O	O	O	O	O	O	-	
		Digital IS	Disable	*1	O	O	O	O	O	O	O	O	O	O	O	O	O	O	O	O	O	O	O	O	O	O	O	O	O	O	O	O	O	O	O	O	O	O	O	
			Enable	*1	O	O	O	O	O	O	O	O	O	O	O	O	O	O	O	O	O	O	O	O	O	O	O	O	O	O	O	O	O	O	O	O	O	O	-	
			Enhanced	-	-	-	-	-	-	-	-	-	-	-	-	-	-	-	-	-	-	-	-	-	-	-	-	-	-	-	-	-	-	-	-	-	O	O	-	
	Auto level (51)	Enable	*1	O	O	O	O	O	O	O	O	O	O	O	O	O	O	O	O	O	O	O	O	O	O	O	O	O	O	O	O	O	O	O	O	O	O	O	-	
		Disable	*1	O	O	O	O	O	O	O	O	O	O	O	O	O	O	O	O	O	O	O	O	O	O	O	O	O	O	O	O	O	O	O	O	O	O	O	O	
	Lens aberration correction (87)	Peripheral illumin.	Enable/Disable	*1	O	O	O	O	O	O	O	O	O	O	O	O	O	O	O	O	O	O	O	O	O	O	O	O	O	O	O	O	O	O	O	O	O	O	O	
			Chromatic aberration	Enable/Disable	*1	O	O	O	O	O	O	O	O	O	O	O	O	O	O	O	O	O	O	O	O	O	O	O	O	O	O	O	O	O	O	O	O	O	O	
		Diffraction	Enable	*1	O	O	O	O	O	-	O	O	O	O	O	O	O	O	O	O	O	O	O	O	O	O	O	O	O	O	O	O	O	O	O	O	O	-	-	-
			Disable	*1	O	O	O	O	O	O	O	O	O	O	O	O	O	O	O	O	O	O	O	O	O	O	O	O	O	O	O	O	O	O	O	O	O	O	O	
	AEB (71)			*1	O	O	O	O	-	-	-	-	-	-	-	-	-	-	-	-	-	-	-	-	-	-	-	-	-	-	-	-	-	-	-	-	-			

Before Use

Basic Guide

Advanced Guide

Camera Basics

Auto Mode / Hybrid Auto Mode

Other Shooting Modes

P Mode

Tv, Av, M, C1, and C2 Mode

Playback Mode

Wireless Features

Setting Menu

Accessories

Appendix

Index



		Shooting Mode	C1	M	Av	Tv	P	A+	A-	A	Ar	Ar	Ar	Ar	Ar	Ar	Ar	Ar	HDR	Ar	Ar	Ar	Ar	Ar	Ar	Ar	Ar	Ar	Ar	Ar	Ar	Ar
Function			C2																													
ISO speed (71)	ISO Speed	See “Functions Available in Each Shooting Mode” (194) .																														
	ISO Auto	*1	O	O	O	O	O	-	-	-	-	-	-	-	-	-	-	-	-	-	-	-	-	-	-	-	-	-	-	O	-	
Highlight tone priority (72)	Disable	*1	O	O	O	O	O	O	O	O	O	O	O	O	O	O	O	O	O	O	O	O	O	O	O	O	O	O	O	O	O	O
	Enable	*1	O	O	O	O	-	-	-	-	-	-	-	-	-	-	-	-	-	-	-	-	-	-	-	-	-	-	-	O	O	-
Auto Lighting Optimizer (72)		See “Quick Set Menu” (196) .																														
Metering mode (70)		See “Quick Set Menu” (196) .																														
Flash Control	Flash firing (82)		See “Functions Available in Each Shooting Mode” (194) .																													
	E-TTL II meter. (84)	Evaluative	*1	O	O	O	O	O	O	-	O	O	-	O	O	-	O	-	-	O	O	O	O	O	O	O	O	O	O	-	-	-
		Average	*1	O	O	O	O	-	-	-	-	-	-	-	-	-	-	-	-	-	-	-	-	-	-	-	-	-	-	-	-	-
	Red-eye reduc. (51)	On/Off	*1	O	O	O	O	O	-	O	O	-	O	O	-	O	-	-	O	O	O	O	O	O	O	O	O	O	-	-	-	
	Safety FE (83)	Enable	*1	O	O	O	O	O	O	-	O	O	-	O	O	-	O	-	-	O	O	O	O	O	O	O	O	O	-	-	-	
		Disable	*1	O	O	O	O	-	O	-	-	-	-	-	-	-	-	-	-	-	-	-	-	-	-	-	-	-	-	-	-	
	Built-in flash settings	Flash Mode (93)	E-TTL II	*1	O	O	O	O	O	O	-	O	O	-	O	O	-	O	-	-	O	O	O	O	O	O	O	O	-	-	-	
			Manual flash	*1	O	O	O	-	-	-	-	-	-	-	-	-	-	-	-	-	-	-	-	-	-	-	-	-	-	-	-	
		Shutter Sync. (84)	1st curtain	*1	O	O	O	O	O	O	-	O	O	-	O	O	-	O	-	-	O	O	O	O	O	O	O	O	-	-	-	
			2nd curtain	*1	O	O	O	O	-	-	O	-	-	-	-	-	-	-	-	-	-	-	-	-	-	-	-	-	-	-	-	
exp. comp.		See “Functions Available in Each Shooting Mode” (194) .																														
flash output		See “Functions Available in Each Shooting Mode” (194) .																														
External flash func. setting (172)		O O O O O -																														
External flash C.Fn setting (174)		O O O O O -																														
Clear settings (85) , (174)	Clear built-in flash set.	O O O O O -																														
	Clear external flash set./ Clear ext. flash C.Fn set.	O O O O O -																														



Function		Shooting Mode		C1	M	Av	Tv	P													HDR																
		C2																																			
6*6	White balance (📖73)	See "Quick Set Menu" (📖196).																																			
	Custom WB (📖73)	O	O	O	O	O	O	-	-	-	-	-	-	-	-	-	-	-	-	-	-	-	-	-	-	-	-	-	-	-	-	-	-	O	O	O	
	WB correction (📖74)	See "Quick Set Menu" (📖196).																																			
	Picture Style (📖75)	See "Quick Set Menu" (📖196).																																			
	Long exp. noise reduction (📖89)	Disable	*1	O	O	O	O	O	O	O	O	O	O	O	O	O	O	O	O	O	O	O	O	O	O	O	O	O	O	O	O	O	O	O	O	O	O
		Auto/Enable	*1	O	O	O	O	-	-	-	-	-	-	-	-	-	-	-	-	-	-	-	-	-	-	-	-	-	-	-	-	-	-	-	-	-	-
High ISO speed NR (📖88)	Standard	*1	O	O	O	O	O	O	O	O	O	O	O	O	O	O	O	O	O	O	O	O	O	O	O	O	O	O	O	O	O	O	O	O	O		
	Disable/Low/High/Multi Shot Noise Reduction	*1	O	O	O	O	-	-	-	-	-	-	-	-	-	-	-	-	-	-	-	-	-	-	-	-	-	-	-	-	-	-	-	-	-		

Before Use

Basic Guide

Advanced Guide

Camera Basics

Auto Mode / Hybrid Auto Mode

Other Shooting Modes

P Mode

Tv, Av, M, C1, and C2 Mode

Playback Mode

Wireless Features

Setting Menu

Accessories

Appendix

Index



Function			Shooting Mode		C1	M	Av	Tv	P													HDR											
			C2																														
	Drive mode (📖46)		See "Quick Set Menu" (📖196).																														
	Self-timer/Remote ctrl (📖44)		See "Quick Set Menu" (📖196).																														
	Digest Type (📖41)	Include Stills/No Stills		-	-	-	-	-	-	○	-	-	-	-	-	-	-	-	-	-	-	-	-	-	-	-	-	-	-	-	-	-	
	AF auto switch (📖44)	Enable		-	-	-	-	-	-	○	-	-	-	-	-	-	-	-	-	-	-	-	-	-	-	-	-	-	-	-	-	-	
		Disable		○	○	○	○	○	○	○	○	○	○	○	○	○	○	○	○	○	○	○	○	○	○	○	○	○	○	○	○	○	○
	Keep setting (📖53)	Disable/Enable		-	-	-	-	-	-	-	○	-	-	-	-	-	-	-	-	-	-	-	-	-	-	-	-	-	-	-	-	-	
	Time-lapse movie settings (📖65)	Shooting scene	Scene 1/Scene 2/Scene 3/Custom		-	-	-	-	-	-	-	-	-	-	-	-	-	-	-	-	-	-	-	-	-	-	-	-	-	-	-	○	
			Interval/ Shots	2-4 sec./ 30-900 (Scene 1)		-	-	-	-	-	-	-	-	-	-	-	-	-	-	-	-	-	-	-	-	-	-	-	-	-	-	-	-
		5-10 sec./ 30-720 (Scene 2)		-	-	-	-	-	-	-	-	-	-	-	-	-	-	-	-	-	-	-	-	-	-	-	-	-	-	-	-	-	
		11-30 sec./ 30-240 (Scene 3) 2-30 sec./ 30-900 (Custom)		-	-	-	-	-	-	-	-	-	-	-	-	-	-	-	-	-	-	-	-	-	-	-	-	-	-	-	-	-	○
		Exposure	Fixed/For each shot		-	-	-	-	-	-	-	-	-	-	-	-	-	-	-	-	-	-	-	-	-	-	-	-	-	-	-	○	
		Review image	Enable/Disable		-	-	-	-	-	-	-	-	-	-	-	-	-	-	-	-	-	-	-	-	-	-	-	-	-	-	-	○	

Before Use

Basic Guide

Advanced Guide

Camera Basics

Auto Mode / Hybrid Auto Mode

Other Shooting Modes

P Mode

Tv, Av, M, C1, and C2 Mode

Playback Mode

Wireless Features

Setting Menu

Accessories

Appendix

Index



C.Fn Tab

Function		Shooting Mode	C1 / C2	M	Av	Tv	P																								
																														C1	C2
C.Fn I: Exposure (📖96)	ISO expansion	Disable	*	○	○	○	○	○	○	○	○	○	○	○	○	○	○	○	○	○	○	○	○	○	○	○	○	○	○	○	
		Enable	*	-	-	-	-	-	-	-	-	-	-	-	-	-	-	-	-	-	-	-	-	-	-	-	-	-	-	○	-
	Safety shift	Disable	*	○	○	○	○	○	○	○	○	○	○	○	○	○	○	○	○	○	○	○	○	○	○	○	○	○	○	○	○
		Enable	*	-	○	○	-	-	-	-	-	-	-	-	-	-	-	-	-	-	-	-	-	-	-	-	-	-	-	-	-
C.Fn II: Others (📖96)	Dial direction during Tv/Av	Normal	*	○	○	○	○	-	-	-	-	-	-	-	-	-	-	-	-	-	-	-	-	-	-	-	-	○	○	○	
		Reverse direction	*	○	○	○	○	-	-	-	-	-	-	-	-	-	-	-	-	-	-	-	-	-	-	-	-	-	○	○	○
	Custom Controls	Shutter/ AE lock	AF/AE lock	*	○	○	○	○	-	-	-	-	-	-	-	-	-	-	-	-	-	-	-	-	-	-	-	-	○	○	-
			AE lock/AF	*	○	○	○	○	-	-	-	-	-	-	-	-	-	-	-	-	-	-	-	-	-	-	-	-	○	○	-
			AF/AF lock, no AE lock	*	○	○	○	○	-	-	-	-	-	-	-	-	-	-	-	-	-	-	-	-	-	-	-	-	○	○	-
			AE/AF, no AE lock	*	○	○	○	○	-	-	-	-	-	-	-	-	-	-	-	-	-	-	-	-	-	-	-	-	○	○	-
	Dials	Set func. for M mode	Set func. for M mode	○	○	○	○	○	-	-	-	-	-	-	-	-	-	-	-	-	-	-	-	-	-	-	-	○	○	○	
			Set Func.	○	○	○	○	○	-	-	-	-	-	-	-	-	-	-	-	-	-	-	-	-	-	-	-	○	○	○	

Before Use

Basic Guide

Advanced Guide

Camera Basics

Auto Mode / Hybrid Auto Mode

Other Shooting Modes

P Mode

Tv, Av, M, C1, and C2 Mode

Playback Mode

Wireless Features

Setting Menu

Accessories

Appendix

Index



Function			Shooting Mode	C1	C2	M	Av	Tv	P											HDR															
C.Fn II: Others (📖96)	Custom Controls	Other buttons	M-Fn button	○	○	○	○	○	○	-	-	-	-	-	-	-	-	-	-	-	-	-	-	-	-	-	-	-	-	-	○	○	○		
			button	○	○	○	○	○	-	-	-	-	-	-	-	-	-	-	-	-	-	-	-	-	-	-	-	-	-	-	-	-	-	-	
			button	○	○	○	○	○	-	-	-	-	-	-	-	-	-	-	-	-	-	-	-	-	-	-	-	-	-	-	-	-	○	○	○
			ISO button	○	○	○	○	○	-	-	-	-	-	-	-	-	-	-	-	-	-	-	-	-	-	-	-	-	-	-	-	○	○	-	
			button	○	○	○	○	○	-	-	-	-	-	-	-	-	-	-	-	-	-	-	-	-	-	-	-	-	-	-	-	○	○	○	
			MF button	○	○	○	○	○	-	-	-	-	-	-	-	-	-	-	-	-	-	-	-	-	-	-	-	-	-	-	-	○	○	○	
			button	○	○	○	○	○	-	-	-	-	-	-	-	-	-	-	-	-	-	-	-	-	-	-	-	-	-	-	○	○	○		
	Release shutter w/o lens	Disable	*	○	○	○	○	○	○	○	○	○	○	○	○	○	○	○	○	○	○	○	○	○	○	○	○	○	○	○	○	○	○		
		Enable	*	○	○	○	○	-	-	-	-	-	-	-	-	-	-	-	-	-	-	-	-	-	-	-	-	-	-	-	○	○	○		
	Retract lens on power off	Enable	*	○	○	○	○	○	○	○	○	○	○	○	○	○	○	○	○	○	○	○	○	○	○	○	○	○	○	○	○	○	○		
		Disable	*	○	○	○	○	-	-	-	-	-	-	-	-	-	-	-	-	-	-	-	-	-	-	-	-	-	-	○	○	○			
	Clear all Custom Func. (C.Fn) (📖96)				-	○	○	○	○	○	-	-	-	-	-	-	-	-	-	-	-	-	-	-	-	-	-	-	-	○	○	○			

* Options vary depending on the assigned shooting mode.

○ Available or set automatically. – Not available.

Before Use

Basic Guide

Advanced Guide

Camera Basics

Auto Mode /
Hybrid Auto Mode

Other Shooting Modes

P Mode

Tv, Av, M, C1, and C2 Mode

Playback Mode

Wireless Features

Setting Menu

Accessories

Appendix

Index



Set Up Tab

Tab	Item	Reference Page
f1	Create Folder	155
	File Numbering	155
	Format	156
	Video system	157
	Display settings	32
	Electronic level	50
	Eco Mode	157
f2	Power Saving	31
	Disp. Brightness	158
	Night Display	158
	Time Zone	159
	Date/Time	159
	Language 	159
f3	Beep	159
	Operation Vol.	160
	Hints & Tips	160
	Mode icon size/info	160
	Touch Operation	160
	Sensor cleaning	161

f4	Wi-Fi connect'n	127
	Wireless settings	127
	Certification Logo Display	162
	Custom shooting mode (C1, C2)*1	100
	Copyright Info	162
	Reset camera*2	163
 firmware ver.: *.*.* *3	163	

*1 Only available in these modes: [C1], [C2], [M], [Av], [Tv], and [P].

*2 Only [Other settings] is available in [C1] or [C2] mode.

*3 Only available in these modes: [C1], [C2], [M], [Av], [Tv], [P], [A], and [S].

My Menu Tab

Tab	Item	Reference Page
★1	My Menu settings	101

Before Use

Basic Guide

Advanced Guide

Camera Basics

Auto Mode /
Hybrid Auto Mode

Other Shooting Modes

P Mode

Tv, Av, M, C1, and C2 Mode

Playback Mode

Wireless Features

Setting Menu



Accessories

Appendix

Index



Playback Tab

Tab	Item	Reference Page
▶1	Protect	📖 112
	Rotate	📖 116
	Erase	📖 114
	Rating	📖 117
	Slideshow	📖 111
▶2	List/Play Digest Movies	📖 106
	Image Search	📖 108
	Creative filters	📖 120
▶3	Resize	📖 118
	Cropping	📖 119
	Red-Eye Correction	📖 121
	RAW img processing	📖 122
	Print settings	📖 181
	Photobook Set-up	📖 183
▶4	Transition Effect	📖 103
	Index Effect	📖 107
	Scroll Display	📖 103
	Highlight alert	📖 105
	AF point disp.	📖 105
	Playback grid	📖 105
	Auto Rotate	📖 117
▶5	Resume	📖 103
	Image jump w/ 	📖 109
	 resize	📖 107, 📖 110
	Playback information display	📖 105
	Magnify (approx.)	📖 111

Quick Set Menu in Playback Mode

Item	Reference Page
Protect	📖 112
Rotate	📖 116
Rating	📖 117
Image Search	📖 108
Play Movie	📖 104
Play Linked Digest Movie	📖 106
Print	📖 178
Resize	📖 118
Cropping	📖 119
Creative filters	📖 120
RAW img processing	📖 122
Apply  settings	📖 55

Before Use

Basic Guide

Advanced Guide

Camera Basics

Auto Mode /
Hybrid Auto Mode

Other Shooting Modes

P Mode

Tv, Av, M, C1, and C2 Mode

Playback Mode

Wireless Features

Setting Menu

Accessories

Appendix

Index



Handling Precautions

- The camera is a high-precision electronic device. Avoid dropping it or subjecting it to strong impact.
- Never bring the camera near magnets, motors, or other devices that generate strong electromagnetic fields, which may cause malfunction or erase image data.
- If water droplets or dirt adheres to the camera or screen, wipe with a dry soft cloth, such as an eyeglass cloth. Do not rub hard or apply force.
- Never use cleaners containing organic solvents to clean the camera or screen.
- Use a blower brush to remove dust from the lens. If cleaning is difficult, contact a Canon Customer Support Help Desk.
- To prevent condensation from forming on the camera after sudden temperature changes (when the camera is transferred from cold to warm environments), put the camera in an airtight, resealable plastic bag and let it gradually adjust to the temperature before removing it from the bag.
- Store unused battery packs in a plastic bag or other container. To maintain battery performance if you will not use the battery pack for some time, about once a year charge it and then use the camera until it runs out of power before storing the battery pack.
- If condensation does form on the camera, stop using it immediately. Continuing to use the camera in this state may damage it. Remove the lens, battery pack, and memory card, and wait until the moisture has evaporated before resuming use.
- Do not touch the camera or lens contacts. This may cause the camera to malfunction.
- To avoid damaging the image sensor, do not touch it when it is exposed after a lens is removed.
- Do not block the shutter operation with your finger, etc. Doing so may cause a malfunction.

- After detaching the lens from the camera, put down the lens with the rear end up and attach the lens caps to avoid scratching the lens surface and electrical contacts.
- Besides dust entering the camera from outside, in rare cases lubricant from the camera's internal parts may adhere to the front of the sensor. If spots are still visible on images after automatic sensor cleaning, contact a Canon Customer Support Help Desk to request sensor cleaning.
- Periodically cleaning the camera's body and lens mount with a soft lens cleaning cloth is recommended.

Before Use

Basic Guide

Advanced Guide

Camera Basics

Auto Mode /
Hybrid Auto Mode

Other Shooting Modes

P Mode

Tv, Av, M, C1, and C2 Mode

Playback Mode

Wireless Features

Setting Menu

Accessories

Appendix

Index



Specifications

Type

Category DSLR non-reflex AF AE cameras

Image Sensor

Sensor size

Image sensor size Approx. 22.3 x 14.9 mm

Number of pixels

Camera effective pixels (Pixels may decrease due to image processing) Approx. 24.2 megapixels

Total pixels Approx. 25.8 megapixels

Aspect ratio 3:2

Dust removal feature (Auto/Manual) Provided

Focus Control

AF method Face+Tracking AF, 1-point AF

AF points (max.) 49 points

Focusing brightness range

(room temperature, ISO 100, when using EF-M22mm F2 STM)

EV value -1 – 18

Focus operation

TTL autofocus One-Shot AF, Servo AF

AF-assist beam Built-in LED lamp

Exposure Control

Metering mode Real-time metering using the image sensor, Evaluative, Partial metering, Center Weighted Avg., Spot

Brightness metering range
(room temperature, ISO 100)

EV value 1 – 20

Exposure control Program AE, Shutter priority AE, Aperture priority AE, Manual exposure

Exposure compensation

Manual ± 3 stops in 1/3-stop increments

AE bracketing ± 2 stops in 1/3-stop increments
(Can be used together with manual compensation)

ISO speed (recommended exposure index)

ISO Auto range (AUTO mode)

Min. speed ISO 100

Max. speed ISO 6400

Max. ISO speed (P mode) ISO 25600

AE lock (Manual/Auto) Provided

White Balance

WB settings Auto, Day Light, Shade, Cloudy, Tungsten light, White fluorescent light, Flash, Color temperature, Custom

White balance correction Provided

Before Use

Basic Guide

Advanced Guide

Camera Basics

Auto Mode /
Hybrid Auto Mode

Other Shooting Modes

P Mode

Tv, Av, M, C1, and C2 Mode

Playback Mode

Wireless Features

Setting Menu

Accessories

Appendix

Index



Shutter

Method.....Focal-plane

Shutter speed

Range in all shooting modes

Max. Tv.....30 sec.

Min. Tv.....1/4000 sec.

Fastest synchronized shutter speed with flash.....1/200 sec.

Flash

Built-in flash

Type.....Manual pop-up flash

Specification

Guide number (ISO 100/m).....Approx. 5

Flash range (indication for reference) (approx. range in m)

ISO Speed	EF-M15-45mm F3.5-6.3 IS STM	
	Wide-angle: f/3.5	Telephoto: f/6.3
100	0.5 – 1.4	0.5 – 0.9
200	0.5 – 2.0	0.5 – 1.3
400	0.5 – 2.9	0.5 – 1.8
800	0.7 – 4.0	0.5 – 2.5
1600	1.0 – 5.7	0.5 – 3.6
3200	1.5 – 8.1	0.8 – 5.1
6400	2.1 – 11.4	1.2 – 7.1
12800	2.9 – 16.2	1.6 – 10.1
25600 equivalent	4.1 – 22.9	2.4 – 14.3

External flash.....E-TTL II autofocus, Flash functions settable with the camera

FE lock.....Provided

Viewfinder/Monitor

Electronic color viewfinder

Screen size.....0.39 type

Pixels.....Approx. 2,360,000 dots

Monitor

Type.....TFT color liquid crystal

Screen size.....8.0 cm (3.2 in.)

Effective pixels.....Approx. 1,620,000 dots

Depth-of-field preview.....Provided

Displayed languages.....English, German, French, Dutch, Danish, Portuguese, Finnish, Italian, Norwegian, Swedish, Spanish, Greek, Russian, Polish, Czech, Hungarian, Romanian, Ukrainian, Turkish, Arabic, Thai, Simplified Chinese, Traditional Chinese, Korean, Japanese

Shooting

Image processing

Noise reduction

Long exposure shots.....At exposure of one second and above and at bulb exposure

High ISO speed shots.....At any ISO speed

Image correction

Auto Lighting Optimizer.....Provided

Highlight tone priority.....Provided

Lens correction (EF-M lens has in-lens correction data).....Peripheral illumination correction, Chromatic aberration correction, Diffraction correction

Picture Style.....Auto, Standard, Portrait, Landscape, Fine Detail, Neutral, Faithful, Monochrome, User Def.1, User Def.2, User Def.3

Before Use

Basic Guide

Advanced Guide

Camera Basics

Auto Mode / Hybrid Auto Mode

Other Shooting Modes

P Mode

Tv, Av, M, C1, and C2 Mode

Playback Mode

Wireless Features

Setting Menu

Accessories

Appendix

Index



Continuous shooting

Drive mode Single shooting, Continuous shooting
(Max.: approx. 9.0 shots/sec.)

Maximum number of shots at burst

	Approx. 26 shots
	Approx. 25 shots
	Approx. 24 shots
	Approx. 23 shots
	Approx. 24 shots
	Approx. 17 shots
RAW + JPEG ()	Approx. 16 shots

Recording

File format DCF-compliant DPOF compatible
(Version1.1)

Data type

Still images

Recording format Exif 2.3 (DCF 2.0)

Images (RAW images shot
continuously are processed

using 12-bit AD conversion)..... JPEG/RAW (CR2 a Canon 14-bit
RAW format)

Movies

Recording format MP4

Video MPEG-4 AVC/H.264

Audio MPEG-4 AAC-LC (stereo)

Rec. level adjustment Provided

Wind filter Provided

Attenuator Provided

Number of shots

Still image

Using a 16 GB UHS-I memory card

Image Quality	Number of Shots (indication for reference)
	1833 shots
	2760 shots
	3114 shots
	4671 shots
	4717 shots
	6656 shots
	8098 shots
	450 shots
RAW + JPEG ()	361 shots

Before Use

Basic Guide

Advanced Guide

Camera Basics

Auto Mode /
Hybrid Auto Mode

Other Shooting Modes

P Mode

Tv, Av, M, C1, and C2 Mode

Playback Mode

Wireless Features

Setting Menu





Accessories

Appendix

Index



Movie
Using a 16 GB UHS-I memory card

Image Quality	Recording File Size (indication for reference)	Recordable Time Per a Memory Card (indication for reference)
	4288 KB/sec.	59 min. 30 sec.
	2945 KB/sec.	1 hr. 26 min. 5 sec.
	2945 KB/sec.	1 hr. 26 min. 5 sec.
	1969 KB/sec.	2 hr. 8 min. 27 sec.
	382 KB/sec.	10 hr. 22 min. 35 sec.

- Continuous recording is possible until the memory card becomes full or the recording time reaches approx. 29 minutes and 59 seconds.

Recording media.....SD/SDHC/SDXC memory cards

Folder setting.....Monthly/Daily

File numbering.....Continuous, Auto Reset

Playback

Zoom magnification display	
Zoom magnification	Min.: approx. 2.0 x Max.: approx. 10.0 x
Highlight alert.....	Provided
Rating	Provided
Image protect.....	Provided
Image browsing methods.....	Single image, Jump 10 images, Jump 100 images, Image search (Rating, Date, People, Still images, Movies, Digest movies), Scroll Display
Slideshow	All images, slideshow of images after selection from the search list
Post-processing of images (Possible only with images taken with same model).....	Creative filters (Grainy B/W, Soft focus, Fish-eye effect, Art bold effect, Water painting effect, Toy camera effect, Miniature effect), Resize, Red-Eye Correction

Customizing

Registration of Custom Functions.....	Shutter button, Main dial, Quick control dial, Cross button (up, down, left, right), Control dial, M-Fn button, Movie button, Touch & Drag AF switching button
---------------------------------------	--

Copyright Info Provided

Before Use

Basic Guide

Advanced Guide

Camera Basics

Auto Mode / Hybrid Auto Mode

Other Shooting Modes

P Mode

Tv, Av, M, C1, and C2 Mode

Playback Mode

Wireless Features

Setting Menu

Accessories

Appendix

Index



Power

Battery pack	LP-E17
Number of still image shots (CIPA compliant)	
Monitor On	Approx. 295 shots
Electronic color viewfinder On	Approx. 295 shots
Number of still image shots (Eco Mode On)	
Monitor On	Approx. 420 shots
Movie recording time (CIPA compliant)	
Monitor On	Approx. 85 min.
Electronic color viewfinder On	Approx. 90 min.

Interface

Wired	Digital terminal (Hi-Speed USB compliant), HDMI OUT terminal
Wireless	
NFC	NFC Forum Type3/4 Tag compliant (Dynamic)
Bluetooth	
Compliance standards	Bluetooth Specification Version 4.1 (Bluetooth low energy technology)
Transmission scheme	GFSK modulation scheme
Wi-Fi	
Compliance standards	IEEE 802.11b/g/n
Transmission frequency	
Frequency	2.4 GHz
Channels	1 – 11 ch
Security	
Infrastructure mode	WPA2-PSK (AES/TKIP), WPA-PSK (AES/TKIP), WEP * Wi-Fi Protected Setup compliant
Camera access point mode	WPA2-PSK (AES)
Ad hoc mode	WPA2-PSK (AES)

Operating Environment

Temperature	Min.: 0 °C (32 °F), Max.: 40 °C (104 °F)
Humidity	85 % or less

Dimensions (CIPA compliant)

W	115.6 mm (4.6 in.)
H	89.2 mm (3.5 in.)
D	60.6 mm (2.4 in.)

Weight (CIPA compliant)

Camera body only	Approx. 380 g (13.4 oz.)
Including battery pack, memory card	Approx. 427 g (15.1 oz.)

Battery Pack LP-E17

Type	Rechargeable lithium-ion battery
Rated voltage	7.2 V DC
Battery capacity	1040 mAh
Working temperature range	Charging: 5 °C – 40 °C (41 °F – 104 °F) Shooting: 0 °C – 40 °C (32 °F – 104 °F)
Working humidity	85% or less
Dimensions (W x H x D)	Approx. 33.0 x 14.0 x 49.4 mm (1.30 x 0.55 x 1.94 in.)
Weight	Approx. 45 g (1.59 oz.) (excluding protective cover)

Before Use

Basic Guide

Advanced Guide

Camera Basics

Auto Mode /
Hybrid Auto Mode

Other Shooting Modes

P Mode

Tv, Av, M, C1, and C2 Mode

Playback Mode

Wireless Features

Setting Menu

Accessories

Appendix

Index



Battery Charger LC-E17/ LC-E17E

Compatible battery.....	Battery Pack LP-E17
Recharging time.....	Approx. 2 hours (at room temperature)
Rated input	100 – 240 V AC (50/60 Hz)
Rated output	8.4 V DC / 700mA
Working temperature range	5 °C – 40 °C (41 °F – 104 °F)
Working humidity	85% or less
Dimensions (W x H x D).....	Approx. 67.3 x 27.7 x 92.2 mm (2.65 x 1.09 x 3.63 in.)
Weight.....	LC-E17: Approx. 85 g (3.00 oz.) LC-E17E: Approx. 80 g (2.82 oz.) (excluding power cord)

- All the data above is based on Canon's testing standards and CIPA (Camera & Imaging Products Association) testing standards and guidelines.
- Dimensions, maximum diameter, length and weight listed above are based on CIPA Guidelines (except weight for camera body only).
- Product specifications and the exterior are subject to change without notice.
- If a problem occurs with a non-Canon lens attached to the camera, consult the respective lens manufacturer.

Before Use

Basic Guide

Advanced Guide

Camera Basics

Auto Mode /
Hybrid Auto Mode

Other Shooting Modes

P Mode

Tv, Av, M, C1, and C2 Mode

Playback Mode

Wireless Features

Setting Menu

Accessories

Appendix

Index



Index

Numbers

1-point (AF frame mode) 78

A

AC adapter 167, 170
Accessories 167
AEB shooting 71
AE lock 70
AF frames 77
AF lock 79
AF-point zoom 81
Art bold effect (shooting mode) 61
Aspect ratio 49
Auto Lighting Optimizer 72
Auto mode (shooting mode) 26, 39
Auto rotate 117
Av (shooting mode) 91

B

Batteries → Date/time
(date/time battery)
 Power saving 31
Battery charger 2, 167
Battery pack
 Charging 19
 Eco mode 157
 Level 191
 Power saving 31
Black and white images 60
Bulb exposure 93
B/W (monochrome) 75

C

Camera
 Reset all 163
Camera access point mode 136
Camera Connect 130
CANON IMAGE GATEWAY 136
Charging 19
Chromatic aberration correction 87
Cleaning (image sensor) 161
Close-up (shooting mode) 56
Color temperature 74
Color (white balance) 73
Compression 47
Contrast 76
Creative Assist (shooting mode) 53
Creative filters (shooting mode) 59
Cropping 119, 179
C (shooting mode) 100
Custom Functions 96
Custom WB 73
Custom white balance 73

D

Date/time
 Changing 22
 Date/time battery 22
 Settings 21
 World clock 159
DC coupler 167, 170
Deactivating flash 83
Defaults → Reset all
Display language 23
Display period 52
DLNA 127
DPOF 181

E

Eco mode 157
Editing
 Cropping 119
 Red-eye correction 121
 Resizing images 118
Editing or erasing connection
 information 151
Erasing 114
Erasing all 116
Error messages 189
Exposure
 AE lock 70
 Compensation 69
 FE lock 84

F

Face+Tracking 78
Faithful 75
Favorites 117
FEB 173
FE lock 84
File numbering 155
Filter effect 76
Firmware 163
First-curtain synchronization 173
Fish-eye effect (shooting mode) 60
Flash
 Deactivating flash 83
 Flash exposure compensation 83
 On 83
 Slow synchro 83
Flash exposure compensation 83
Flash mode 173

Focusing

AF frames 77
AF lock 79
MF peaking 82
Servo AF 80
Touch AF 79
Focus lock 78
Focus range
 Manual focus 81
Food (shooting mode) 58
Front dial 4

G

Grainy B/W (shooting mode) 60
Grid lines 34

H

Handheld night scene
(shooting mode) 56
HDMI cable 169
High dynamic range
(shooting mode) 63
High ISO speed noise reduction 88
Household power 170
Hybrid Auto (shooting mode) 41

I

Icons 191, 192
Image dust prevention 161
Image quality → Compression
Images
 Display period 52
 Erasing 114
 Playback → Viewing
 Protecting 112
Image stabilization 86
Image Sync 147
Index display 107
Indicator 38, 51

Before Use

Basic Guide

Advanced Guide

Camera Basics

Auto Mode / Hybrid Auto Mode

Other Shooting Modes

P Mode

Tv, Av, M, C1, and C2 Mode

Playback Mode

Wireless Features

Setting Menu

Accessories

Appendix

Index



Installation 176
ISO speed 71

J

Jump display 109

L

Landscape 75
Landscape (shooting mode) 56
Lens 23
 Lock release 24
Level 191
Long exposure 93
Long exposure noise reduction 89

M

M (shooting mode) 92
Macro photography 56
Magnified display 110
Manual focus 81
Memory cards 2
Menu
 Basic operations 35
 Table 194
Metering method 70
MF (Manual focusing) 81
MF peaking 82
Miniature effect (shooting mode) 62
Movies
 Editing 124
 Image quality (recording pixels/
 frame rate) 49
Multi-function button 97
Multi Shot Noise Reduction 87, 88

N

Neck strap → Strap
Neutral 75

Noise reduction
 High ISO speed 88
 Long exposure 89

O

On 83

P

P (shooting mode) 68
Package contents 2
Panning (shooting mode) 58
Part names 4
Peripheral illumination correction 87
Photobook set-up 183
PictBridge 169, 178
Picture Style 75
Playback → Viewing
Portrait (shooting mode) 56
Power 167 → AC adapter,
 → Battery charger, → Battery pack
Power saving 31
Printing 178
Program AE 68
Protecting 112

Q

Q menu → Quick Set menu
Quick Set menu
 Basic operations 34
 Table 196

R

Rating 117
RAW 48
RAW image processing 122
Recording pixels (image size) 47
Red-eye correction 121
Remote live view shooting 149
Reset all 163

Resizing images 118
Rotating 116

S

Saturation 76
Saving images to
 a computer 148, 177
Screen
 Display language 23
 Icons 191, 192
 Menu → Quick Set menu
SD/SDHC/SDXC memory cards
 → Memory cards
Searching 108
Second-curtain synchronization 173
Self portrait (shooting mode) 57
Self-timer 44
 2-second self-timer 45
 Customizing the self-timer 45
Sending images 136
Sending images to
 another camera 143
Sending images to a smartphone 128
Sending images to Web services 139
Sensor cleaning 161
Servo AF 80
Sharpness 76
Shooting
 Shooting information 191
Single-image display 28
Slideshow 111
Slow synchro 83
Soft focus (shooting mode) 60
Software
 Installation 176
 Saving images to
 a computer 177
 User manual 176
Sounds 159

Sports (shooting mode) 56
Strap 18

T

Terminal 169, 170, 178
Time-lapse movie (shooting mode) 65
Tone priority 72
Toning effect 76
Touch AF 79
Touch-screen panel 4
Touch Shutter 46
Traveling with the camera 159
Tripod socket 4
Troubleshooting 185
TV display 169
Tv (shooting mode) 90

V

Viewing 28
 Image search 108
 Index display 107
 Jump display 109
 Magnified display 110
 Single-image display 28
 Slideshow 111
 TV display 169

W

Water painting effect
 (shooting mode) 61
White balance (color) 73
Wireless features 127
Wireless flash shooting 173
World clock 159

Z

Zoom 26

Before Use

Basic Guide

Advanced Guide

Camera Basics

Auto Mode /
Hybrid Auto Mode

Other Shooting Modes

P Mode

Tv, Av, M, C1, and C2 Mode

Playback Mode

Wireless Features

Setting Menu

Accessories

Appendix

Index



Precautions for Wireless Features (Wi-Fi, Bluetooth, or Others)

- Countries and Regions Permitting Wireless Function Use
 - Use of wireless functions is restricted in some countries and regions, and illegal use may be punishable under national or local regulations. To avoid violating wireless regulations, visit the Canon website to check where use is allowed.
Note that Canon cannot be held liable for any problems arising from wireless function use in other countries and regions.
- Doing any of the following may incur legal penalties:
 - Altering or modifying the product
 - Removing the certification labels from the product
- Before goods or technologies in the camera regulated by the Foreign Exchange and Foreign Trade Act are exported (which includes bringing them outside Japan or showing them to non-residents in Japan), export or service transaction permission may be required from the Japanese government.
- Because this product includes American encryption items, it falls under U.S. Export Administration Regulations, and cannot be exported to or brought into a country under U.S. trade embargo.
- Be sure to make notes of the Wi-Fi settings you use.
The wireless settings saved to this product may change or be erased due to incorrect operation of the product, the effects of radio waves or static electricity, or accident or malfunction.
Please note that Canon accepts no responsibility for direct or indirect damages or loss of earnings resulting from a degradation or disappearance of content.
- When transferring ownership, disposing of the product, or sending it for repair, restore the default wireless settings by erasing any settings you have entered.
- Canon will not make compensation for damages resulting from loss or theft of the product.
Canon accepts no responsibility for damages or loss resulting from unauthorized access or use of target devices registered on this product due to loss or theft of the product.

- Be sure to use the product as directed in this guide.
Be sure to use the wireless function of this product within the guidelines noted in this guide. Canon accepts no responsibility for damages or loss if the function and product are used in ways other than as described in this guide.
- Do not use the wireless function of this product near medical equipment or other electronic equipment.
Use of the wireless function near medical equipment or other electronic equipment may affect operation of those devices.

Radio Wave Interference Precautions

- This product may receive interference from other devices that emit radio waves. To avoid interference, be sure to use this product as far away as possible from such devices, or avoid using the devices at the same time as this product.

Security Precautions

Because Wi-Fi uses radio waves to transmit signals, security precautions more stringent than when using a LAN cable are required. Keep the following points in mind when using Wi-Fi.

- Only use networks you are authorized to use.
This product searches for Wi-Fi networks in the vicinity and displays the results on the screen. Networks you are not authorized to use (unknown networks) may also be displayed. However, attempting to connect to or using such networks could be regarded as unauthorized access. Be sure to use only networks you are authorized to use, and do not attempt to connect to other unknown networks.

If security settings have not been properly set, the following problems may occur.

- Transmission monitoring
Third parties with malicious intent may monitor Wi-Fi transmissions and attempt to acquire the data you are sending.

Before Use

Basic Guide

Advanced Guide

Camera Basics

Auto Mode /
Hybrid Auto Mode

Other Shooting Modes

P Mode

Tv, Av, M, C1, and C2 Mode

Playback Mode

Wireless Features

Setting Menu

Accessories

Appendix

Index



- **Unauthorized network access**
Third parties with malicious intent may gain unauthorized access to the network you are using to steal, modify, or destroy information. Additionally, you could fall victim to other types of unauthorized access such as impersonation (where someone assumes an identity to gain access to unauthorized information) or springboard attacks (where someone gains unauthorized access to your network as a springboard to cover their tracks when infiltrating other systems).

To prevent these types of problems from occurring, be sure to thoroughly secure your Wi-Fi network. Only use this camera's Wi-Fi function with a proper understanding of Wi-Fi security, and balance risk and convenience when adjusting security settings.

Third-Party Software

- **expat.h**
Copyright (c) 1998, 1999, 2000 Thai Open Source Software Center Ltd

Permission is hereby granted, free of charge, to any person obtaining a copy of this software and associated documentation files (the "Software"), to deal in the Software without restriction, including without limitation the rights to use, copy, modify, merge, publish, distribute, sublicense, and/or sell copies of the Software, and to permit persons to whom the Software is furnished to do so, subject to the following conditions:

The above copyright notice and this permission notice shall be included in all copies or substantial portions of the Software.

THE SOFTWARE IS PROVIDED "AS IS", WITHOUT WARRANTY OF ANY KIND, EXPRESS OR IMPLIED, INCLUDING BUT NOT LIMITED TO THE WARRANTIES OF MERCHANTABILITY, FITNESS FOR A PARTICULAR PURPOSE AND NONINFRINGEMENT. IN NO EVENT SHALL THE AUTHORS OR COPYRIGHT HOLDERS BE LIABLE FOR ANY CLAIM, DAMAGES OR OTHER LIABILITY, WHETHER IN AN ACTION OF CONTRACT, TORT OR OTHERWISE, ARISING FROM, OUT OF OR IN CONNECTION WITH THE SOFTWARE OR THE USE OR OTHER DEALINGS IN THE SOFTWARE.

Personal Information and Security Precautions

If personal information and/or Wi-Fi security settings, such as passwords, etc., are saved on the camera, please be aware that such information and settings may still remain in the camera.

When transferring the camera to another person, disposing of it, or sending it for repair, be sure to take the following measures to prevent the leakage of such information and settings.

- Erase registered Wi-Fi security information by choosing [Reset Settings] in the Wi-Fi settings.

Trademarks and Licensing

- Microsoft and Windows are trademarks or registered trademarks of Microsoft Corporation in the United States and/or other countries.
- Macintosh and Mac OS are trademarks of Apple Inc., registered in the U.S. and other countries.
- App Store, iPhone, and iPad are trademarks of Apple Inc.
- The SDXC logo is a trademark of SD-3C, LLC.
- HDMI, the HDMI logo and High-Definition Multimedia Interface are trademarks or registered trademarks of HDMI Licensing, LLC.
- Wi-Fi®, Wi-Fi Alliance®, WPA™, WPA2™ and Wi-Fi Protected Setup™ are trademarks or registered trademarks of the Wi-Fi Alliance.
- The Bluetooth® word mark and logos are registered trademarks owned by Bluetooth SIG, Inc. and any use of such marks by Canon Inc. is under license. Other trademarks and trade names are those of their respective owners.
- The N-Mark is a trademark or registered trademark of NFC Forum, Inc. in the United States and in other countries.
- All other trademarks are the property of their respective owners.
- This device incorporates exFAT technology licensed from Microsoft.

- Before Use
- Basic Guide
- Advanced Guide
 - Camera Basics
 - Auto Mode / Hybrid Auto Mode
 - Other Shooting Modes
 - P Mode
 - Tv, Av, M, C1, and C2 Mode
 - Playback Mode
 - Wireless Features
 - Setting Menu
 - Accessories
 - Appendix
- Index



- This product is licensed under AT&T patents for the MPEG-4 standard and may be used for encoding MPEG-4 compliant video and/or decoding MPEG-4 compliant video that was encoded only (1) for a personal and non-commercial purpose or (2) by a video provider licensed under the AT&T patents to provide MPEG-4 compliant video. No license is granted or implied for any other use for MPEG-4 standard.

Disclaimer

- Unauthorized reproduction of this guide is prohibited.
- All measurements based on Canon testing standards.
- Information subject to change without notice, as are product specifications and appearance.
- Illustrations and screenshots in this guide may differ slightly from the actual equipment.
- The above items notwithstanding, Canon cannot be held liable for any loss arising from the use of this product.

Before Use

Basic Guide

Advanced Guide

Camera Basics

Auto Mode /
Hybrid Auto Mode

Other Shooting Modes

P Mode

Tv, Av, M, C1, and C2 Mode

Playback Mode

Wireless Features

Setting Menu

Accessories

Appendix

Index

