

Canon

EOS M200

ENGLISH

Advanced User Guide

Introduction

Before Starting to Shoot, Be Sure to Read the Following

To avoid shooting problems and accidents, first read the “Safety Instructions” (📖 30) and “Handling Precautions” (📖 33). Also, read this manual carefully to ensure that you use the camera correctly.

Refer to This Manual while Using the Camera to Further Familiarize Yourself with the Camera

While reading this manual, take a few test shots and see how they come out. You can then better understand the camera. Be sure to store this manual safely, too, so that you can refer to it again when necessary.

Testing the Camera Before Use and Liability

After shooting, play images back and check whether they have been properly recorded. If the camera or memory card is faulty and the images cannot be recorded or downloaded to a computer, Canon cannot be held liable for any loss or inconvenience caused.

Copyrights

Copyright laws in some countries prohibit the unauthorized use of images recorded with the camera (or music/images with music transferred to the memory card) for purposes other than personal enjoyment. Also be aware that certain public performances, exhibitions, etc. may prohibit photography even for private enjoyment.

Item Check List

Before starting, check that all the following items are included with your camera. If anything is missing, contact your dealer.

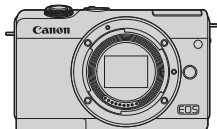

Camera
(with body cap)



Battery Pack LP-E12
(with protective cover)



Battery Charger
LC-E12E*

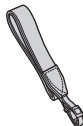

Strap

* Battery Charger LC-E12E comes with a power cord.

- The camera does not come with a memory card (📖 11), interface cable, or HDMI cable.
- For details on the Advanced User Guide and Instruction Manuals, see “Instruction Manuals” (📖 4).
- If you purchased a Lens Kit, check that the lenses are included.
- Be careful not to lose any of the above items.



- When you need Lens Instruction Manuals, download them from the Canon website (📖 4).
- The Lens Instruction Manuals (PDF files) are for lenses sold individually. Note that when purchasing the Lens Kit, some of the accessories included with the lens may not match those listed in the Lens Instruction Manual.

Instruction Manuals



The Instruction Manual included with the camera provides basic instructions for the camera and Wi-Fi functions. The *Advanced User Guide* (this PDF file), which provides complete instructions, can be downloaded from the Canon website to a computer or other device.

Downloading the Advanced User Guide/Instruction Manuals

The Advanced User Guide and Instruction Manuals for lenses and software (PDF files) can be downloaded from the Canon website to a computer or other device.

Download site

- **Advanced User Guide/Supplemental Information**
www.canon.com/icpd
- **Lens Instruction Manual**
www.canon.com/icpd
- **Software Instruction Manual**
www.canon.com/icpd



- To view the PDF files, an Adobe PDF viewing software such as Adobe Acrobat Reader DC (most recent version recommended) is required.
- Adobe Acrobat Reader DC can be downloaded for free from the Internet.
- Double-click the downloaded PDF file to open it.
- To learn how to use PDF viewing software, refer to the software's Help section or the like.

Downloading the Advanced User Guide/Instruction Manuals Using QR Code

The Advanced User Guide and Instruction Manuals for lenses and software (PDF files) can be downloaded to a smartphone or tablet using the QR code.

www.canon.com/icpd



- A software app is required to read the QR code.
- Select your country or region of residence, then download the Advanced User Guide/Instruction Manuals.
- Select [**📄: Manual/software URL**] to display the QR code on the camera screen.

Quick Start Guide

1

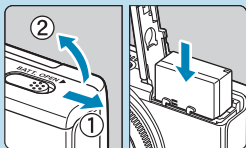

Insert the battery (📖 44).

- Upon purchase, charge the battery to start using (📖 42).

2

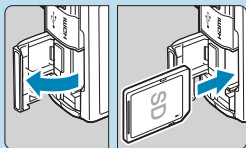

Insert the card (📖 46).

- With the card's label facing toward the back of the camera, insert it into the card slot.

3

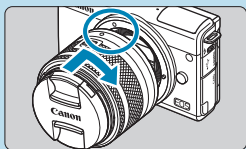

Attach the lens (📖 52).

- Align the white mount index on the lens with the white mount index on the camera to attach the lens.
- Remove the lens cap.

4

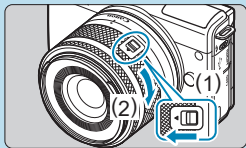

Prepare to shoot.

- Press (1) as you turn (2) slightly, and then release (1).
- Turn (2) a little more until it clicks.

5

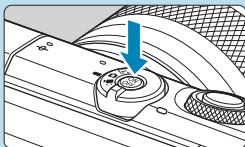

Turn the camera on (📖 50).

6

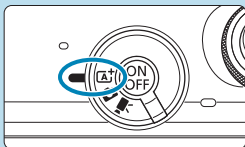

Set the shooting mode switch to $\langle A^+ \rangle$ (📖 72).

- All the necessary camera settings will be set automatically.

7



Focus on the subject (📖 57).

- $[\text{AF}]$ (an AF point) appears over any face detected.
- Press the shutter button halfway, and the camera will focus on the subject.

8

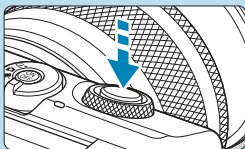

Take the picture (📖 57).

- Press the shutter button completely to take the picture.

9

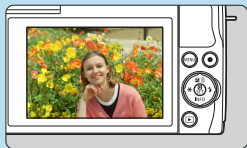





Review the picture.

- The image just captured will be displayed for approx. 2 sec. on the screen.
- To display the image again, press the <▶> button (📖 256).







- To view the images captured so far, see “Image Playback” (📖 256).
- To delete images, see “Erase Images” (📖 277).

About This Manual

Icons in this Manual

-  : Indicates the dial.
-  : Indicates the corresponding direction on the  cross keys.
-  <SET> : Indicates the Quick Control/Setting button.
- * : Indicates the duration (in * seconds) of the operation for the button you pressed, as timed after you release the button.

• In addition to the above, the icons and symbols used on the camera's buttons and displayed on the screen are also used in this manual when discussing relevant operations and functionality.

-  : A  icon to the right of a page title indicates that the function is available only in advanced shooting modes ([**P**], [**Tv**], [**Av**], or [**M**]) or [**M**] movie modes ([**M**] or [**M**]).
- *** : Reference page numbers for more information.
-  : Warning to prevent shooting problems.
-  : Supplemental information.
-  : Tips or advice for better shooting.
-  : Troubleshooting advice.

Basic Assumptions for Operational Instructions and Sample Photos

- Instructions apply to the camera with the power on (📖 50).
- It is assumed that all the menu settings and Custom Functions are set to their defaults.
- Screens in instructions show the state with **[Menu display]** in **[🔍: Display level settings]** set to **[Guided]**.
- The illustrations in this manual show the camera attached with the EF-M15-45mm f/3.5-6.3 IS STM lens as an example.
- The sample photos displayed on the camera and used in this manual are for instructional purposes only.
- In references to using EF or EF-S lenses, it is assumed that a mount adapter is used.

Compatible Cards

The following cards can be used with the camera regardless of capacity. **If the card is new or was previously formatted (initialized) by another camera or computer, format the card with this camera** (📖 433).

- **SD/SDHC/SDXC memory cards**

UHS-I cards supported.

Cards that Can Record Movies

When recording movies, use a high-capacity card with ample performance (fast enough writing and reading speeds) for the movie recording size. For details, see 📖 498.



In this manual, “card” refers to SD memory cards, SDHC memory cards, and SDXC memory cards.

*** The camera does not come with a card for recording photos/movies.** Please purchase it separately.

Chapters

Introduction	2
<hr/>	
Preparation and Basic Operations	41
<hr/>	
Basic Shooting Modes	71
<hr/>	
Advanced Shooting Modes	103
<hr/>	
Shooting Settings	115
<hr/>	
Flash Photography	243
<hr/>	
Playback Settings	253
<hr/>	
Wireless Settings	317
<hr/>	
Function Settings	423
<hr/>	
Custom Functions (C.Fn)	457
<hr/>	
My Menu	463
<hr/>	
Reference	471
<hr/>	

Contents

Introduction 2

Item Check List	3
Instruction Manuals	4
Quick Start Guide	6
About This Manual	9
Compatible Cards	11
Chapters	12
Contents	13
Contents by Purpose	23
Index to Features	26
Safety Instructions	30
Handling Precautions	33
Part Names	36

Preparation and Basic Operations 41

Charging the Battery	42
Inserting/Removing the Battery	44
Inserting/Removing the Card	46
Using the Screen	49
Turning on the Power	50
Attaching/Detaching a Lens	52
Attaching/Detaching EF/EF-S Lenses	54
Basic Operations	56
Setting the Screen Display Level	60
Menu Operations and Settings	63

Touch-Screen Operation	68
Quick Control	69

Basic Shooting Modes **71**

Scene Intelligent Auto/Hybrid Auto (Fully Automatic).....	72
Special Scene Mode	80
Self Portrait Mode	82
Portrait Mode.....	83
Smooth Skin Mode.....	84
Landscape Mode	85
Sports Mode.....	86
Close-up Mode.....	87
Food Mode	88
Night Portrait Mode	89
Handheld Night Scene Mode	90
HDR Backlight Control Mode	91
Silent Mode	92
Special Scene Mode Precautions	93
Creative Filters Mode	96

Advanced Shooting Modes **103**

Program AE Mode (P).....	104
Shutter-priority AE Mode (Tv).....	106
Aperture-priority AE Mode (Av)	108
Manual Exposure Mode (M).....	110

Shooting Settings 115

Still Photo Shooting 116

Tab Menus: Still Photo Shooting	117
Image Quality	122
Still Image Aspect Ratio	125
Image Review Time.....	127
Lens Aberration Correction	128
Drive Mode.....	133
Self-Timer.....	135
Exposure Compensation.....	137
ISO Speed Settings	138
Auto Lighting Optimizer.....	141
Highlight Tone Priority	142
Metering Mode	143
Metering Timer	145
Exposure Simulation	146
White Balance.....	147
White Balance Correction	152
Color Space	153
Picture Style Selection	154
Picture Style Customization	157
Picture Style Registration.....	160
Long Exposure Noise Reduction	162
High ISO Speed Noise Reduction.....	163
Touch Shutter	165

AF Operation.....	167
AF Method.....	170
Eye Detection AF	180
Continuous AF	181
Focus Mode	182
Manually Focusing with a Lens after AF	183
AF-Assist Beam Firing	184
Manual Focus.....	185
Setting MF Peaking.....	187
Image Stabilization.....	188
Exposure Lock (AE Lock)	189
Type of Digest Movie	190
Remote Control Shooting.....	191
General Still Photo Shooting Cautions.....	192

Movie Recording 195

Tab Menu: Movie Recording	196
Movie Mode.....	198
Movie Recording Quality	205
Movie Self-Timer	212
Sound Recording	213
Time-lapse Movies	215
Video Snapshots.....	224
Miniature Effect Movie.....	229
Movie Servo AF.....	231
Movie Digital IS	233

Other Menu Functions	235
General Movie Recording Cautions	240

Flash Photography **243**

Flash Photography	244
Flash Exposure Compensation	246
FE Lock	247
Flash Control	248

Playback Settings **253**

Tab Menus: Playback Settings	254
Image Playback	256
Magnified Image Display	259
Index Display (Multiple-Image Display)	260
Movie Playback	261
Editing a Movie's First and Last Scenes	264
Frame Extraction	266
Digest Movie Editing	268
Playback on a TV Set	270
Protect Images	272
Rotate Still Photos	275
Change Movie Orientation Information	276
Erase Images	277
Prepare to Print	281
Print Images	283

Print Ordering.....	284
Photobook Set-up	288
Creative Filters.....	291
Creative Assist	294
Red-Eye Correction.....	296
Create Album	297
Cropping.....	300
Resizing	302
Rating.....	303
Slide Shows	306
Set Image Search Conditions	308
Image Jump by Swiping.....	310
Playback Information Display.....	312
AF Point Display.....	314
View from Last Seen.....	315

Wireless Settings

317

Tab Menus: Wireless Settings.....	318
Selection of Wi-Fi/Bluetooth Connection	319
Connecting to a Smartphone	321
Connecting to a Computer via Wi-Fi	349
Connecting to a Printer via Wi-Fi	357
Sending Images to a Web Service.....	367
Wi-Fi Connection via Access Points	382
Connecting to a Wireless Remote Control.....	387
Reconnecting via Wi-Fi	390

Registering Multiple Connection Settings	392
Wi-Fi Settings.....	393
Bluetooth Settings	394
Changing the Nickname.....	395
Geotagging Images with GPS Information from Other Devices.....	396
Changing or Deleting Connection Settings	399
Airplane Mode.....	401
Clearing Wireless Communication Settings to Default	402
View Info Screen	403
Virtual Keyboard Operations	404
Responding to Error Messages	405
Wireless Communication Function Notes	416
Security	418
Checking Network Settings.....	419
Wireless Communication Status	420

Function Settings **423**

Tab Menus: Function Settings.....	424
Select Folder	426
File Numbering.....	428
Auto Rotate	431
Adding Orientation Information to Movies.....	432
Format Card.....	433
Eco Mode.....	435
Power Saving.....	436
Display Brightness	437

Date/Time/Zone	438
Language	441
Shutter Button Function for Movies	442
Video System	443
Touch Control	444
Screen Autolock Settings	445
Beeping	446
HDMI Resolution	447
HDMI HDR Output	448
Shooting Information Display	449
Reverse Display	451
Display Performance	452
Reset Camera	453
Copyright Information	454
Manual/Software URL	456
Certification Logo Display	456
Firmware	456

Custom Functions (C.Fn) 457

Setting Custom Functions	458
Custom Function Setting Items	459

My Menu 463

Tab Menus: My Menu.....	464
Registering My Menu.....	465

Reference 471

Software.....	472
Importing Images to a Computer.....	474
Household Power Outlet Accessory.....	476
Troubleshooting Guide.....	477
Error Codes.....	493
Performance Data.....	494
Information Display.....	501
Index.....	512



Contents by Purpose

Shooting

































-
- Shoot automatically →  71– 101 (Basic shooting modes)
-
- Shoot continuously →  133 ( Continuous shooting)
-
- Take a picture of yourself in a group →  135 ( Self-timer)
-
- Freeze the action →  106 (**Tv** Shutter-priority AE)
 - Blur the action
-
- Shoot with effects of your choice →  78 (Creative Assist)
-
- Blur the background →  108 (**Av** Aperture-priority AE)
 - Keep the background in sharp focus
-
- Adjust the image brightness (exposure) →  137 (Exposure compensation)
-
- Shoot in low light →  244 ( Flash photography)
 -  138 (ISO speed settings)
-
- Shoot without flash →  249 ( Flash off)
-
- Shoot fireworks at night →  112 (Bulb exposure)
-
- Shoot with creative effects →  96 (Creative filters)
-
- Take a Self Portrait →  82 ( Self Portrait)
-
- Record movies →  195 ( Movie recording)















Image Quality

- Shoot with image effects matching the subject →  154 (Picture Style selection)
- Make a large-size print of the picture →  122 (, , **RAW**, **CRAW**)
- Take a lot of pictures →  122 (, , **S2**)





AF (Focusing)

- Change the point of focus →  172 (AF method)
- Shoot a moving subject →  168 (Servo AF)
→  86 ( Sports)

Playback

- View photos or movies on the camera →  256 ( Playback)
- Find photos or movies quickly →  260 (Index display)
 310 (Image jump with )
 308 (Set image search conditions)
- Rate images →  303 (Rating)
- Protect important photos or movies from accidental erasure →  272 ( Protect images)
- Erase unneeded photos or movies →  277 ( Erase images)
- Auto play back photos and movies →  306 (Slide shows)
- View photos and movies on a TV set →  270 (Playback on a TV set)
- Adjust the screen brightness →  437 (Screen brightness)
- Apply special effect to images →  291 (Creative filters)

Wireless Features

- Send images to a smartphone →  321 (Connecting to a smartphone)
- Automatically send images to a computer →  349 (Connecting to a computer via Wi-Fi)
- Print photos →  357 (Connecting to a printer via Wi-Fi)
- Share images online →  367 (Sending images to a web service)

Index to Features

Power

- Charging the battery (📖 42)
- Battery level (📖 51)
- Eco mode (📖 435)
- Power saving (📖 436)

Cards

- Formatting (📖 433)
- Cards compatible with movie recording (📖 497)

Lens

- Attaching (📖 52, 📖 54)
- Detaching (📖 53, 📖 55)
- Release shutter without lens (📖 461)

Basic Settings

- Date/Time/Zone (📖 438)
- Language (📖 441)
- Video system (📖 443)
- Beeper (📖 446)
- Clearing all camera settings (📖 453)
- Copyright information (📖 454)

Screen

- Tilting (📖 49)
- Touch control (📖 68)
- Brightness (📖 437)
- Screen autolock settings (📖 445)
- Display performance (📖 452)

AF

- AF operation (📖 167)
- AF method (📖 170)
- AF point selection (📖 175)
- Eye Detection AF (📖 180)
- Continuous AF (📖 181)
- Electronic manual focus (📖 183)
- AF-assist beam (📖 184)
- Manual focusing (📖 185)
- MF peaking settings (📖 187)

Metering

- Metering mode (📖 143)

Drive

- Maximum burst (📖 124)
- Drive mode (📖 133)
- Self-timer (📖 135)

Image Recording Settings

- Creating/Selecting a folder (📖 426)
- File numbering (📖 428)

Image Quality

- Image quality (📖 122)
- Still image aspect ratio (📖 125)
- Lens aberration correction (📖 128)
- ISO speed (still photos) (📖 138)
- Auto Lighting Optimizer (📖 141)
- Highlight tone priority (📖 142)
- White balance (📖 147)
- Color space (📖 153)
- Picture Style (📖 154)
- Noise reduction for long exposures (📖 162)
- Noise reduction for high ISO speeds (📖 163)

Shooting

- Shooting mode (📖 38)
- Quick Control (📖 69)
- Creative Assist (📖 78)
- Creative filters (📖 96)
- Depth-of-field preview (📖 109)
- Touch shutter (📖 165)
- Magnified view (📖 177)
- Remote control (📖 191)
- Shooting information display (📖 449)
- Grid display (📖 449)
- Reverse display (📖 451)
- Error codes (📖 493)

Exposure

- Exposure compensation with M+ISO Auto (📖 111)
- Exposure compensation (📖 137)
- Exposure simulation (📖 146)
- AE lock (📖 189)
- Safety shift (📖 459)

Flash

- Flash (📖 244)
- Flash exposure compensation (📖 246)
- FE lock (📖 247)
- Built-in flash function settings (📖 251)

Movie Recording

- Autoexposure recording (📖 198)
- Manual exposure recording (📖 200)
- Movie recording size (📖 205)
- Sound recording (📖 213)
- Wind filter (📖 213)
- Attenuator (📖 214)
- Time-lapse movie (📖 215)
- Video snapshot (📖 224)
- Movie Servo AF (📖 231)
- Remote control shooting (📖 235)
- ISO speed (movie) (📖 236)
- HDMI output (📖 238)
- Auto slow shutter (📖 239)
- Adding rotation information (📖 432)
- Shutter button function for movies (📖 442)

Playback

- Image review time (📖 127)
- Single-image display (📖 256)
- Touch playback (📖 258)
- Magnified view (📖 259)
- Index display (📖 260)
- Movie playback (📖 261)
- Editing a movie's first and last scenes (📖 264)
- Frame Grab (4K) (📖 266)
- Viewing images on a television (📖 270)
- Protect (📖 272)
- Image rotation (📖 275)
- Erasing (📖 277)
- Rating (📖 303)
- Slide show (📖 306)
- Setting image search conditions (📖 308)
- Image browsing (Jump display) (📖 310)
- Playback information display (📖 312)
- AF point display (📖 314)
- Auto rotate (📖 431)
- HDMI resolution (📖 447)
- HDR output (📖 448)
- Shooting information display (📖 506)

Image Editing

- Creative filters (📖 291)
- Red-eye correction (📖 296)
- Video snapshot album (📖 297)
- Cropping JPEGs (📖 300)
- Resizing JPEGs (📖 302)

Print Ordering

- Print order (DPOF) (📖 284)
- Photobook Set-up (📖 288)

Customization

- Display level settings (📖 60)
- Custom Functions (C.Fn) (📖 458)
- My Menu (📖 465)

Software

- Downloading and Installing (📖 472)
- Software Instruction Manuals (📖 473)

Wireless Features

- Connect to smartphones (📖 321)
- Auto send images to smartphones (📖 335)
- Remote control (EOS Utility) (📖 349)
- Auto send images to computers (📖 354)
- Print from Wi-Fi printers (📖 357)
- Upload to Web service (📖 367)
- Connect to a wireless remote control (📖 387)
- Geotagging Images (📖 396)
- Clear wireless settings (📖 402)

Safety Instructions

Be sure to read these instructions in order to operate the product safely. Follow these instructions to prevent injury or harm to the operator of the product or others.



WARNING: Denotes the risk of serious injury or death.

- Keep the product out of the reach of young children.

A strap wrapped around a person's neck may result in strangulation.

The parts or provided items of cameras or accessories are dangerous if swallowed. If swallowed, seek immediate medical assistance.

The battery is dangerous if swallowed. If swallowed, seek immediate medical assistance.

- Use only power sources specified in this instruction manual for use with the product.
- Do not disassemble or modify the product.
- Do not expose the product to strong shocks or vibration.
- Do not touch any exposed internal parts.
- Stop using the product in any case of unusual circumstances such as the presence of smoke or a strange smell.
- Do not use organic solvents such as alcohol, benzine or paint thinner to clean the product.
- Do not get the product wet. Do not insert foreign objects or liquids into the product.
- Do not use the product where flammable gases may be present.

This may cause electric shock, explosion or fire.

- Do not leave a lens or a camera/camcorder with a lens attached, exposed without the lens cap attached.

The lens may concentrate the light and cause fire.

- Do not touch the product connected to a power outlet during lightning storms.

This may cause electric shock.

- Observe the following instructions when using commercially available batteries or provided battery packs.
 - Use batteries/battery packs only with their specified product.
 - Do not heat batteries/battery packs or expose them to fire.
 - Do not charge batteries/battery packs using non-authorized battery chargers.
 - Do not expose the terminals to dirt or let them come into contact with metallic pins or other metal objects.
 - Do not use leaking batteries/battery packs.
 - When disposing of batteries/battery packs, insulate the terminals with tape or other means.

This may cause electric shock, explosion or fire.

If a battery/battery pack leaks and the material contacts your skin or clothing, flush the exposed area thoroughly with running water. In case of eye contact, flush thoroughly with copious amounts of clean running water and seek immediate medical assistance.

- Observe the following instructions when using a battery charger or AC adapter.
 - Periodically remove any dust buildup from the power plug and power outlet using a dry cloth.
 - Do not plug in or unplug the product with wet hands.
 - Do not use the product if the power plug is not fully inserted into the power outlet.
 - Do not expose the power plug and terminals to dirt or let them come into contact with metallic pins or other metal objects.
- Do not touch the battery charger or AC adapter connected to a power outlet during lightning storms.
- Do not place heavy objects on the power cord. Do not damage, break or modify the power cord.
- Do not wrap the product in cloth or other materials when in use or shortly after use when the product is still warm in temperature.
- Do not unplug the product by pulling the power cord.
- Do not leave the product connected to a power source for long periods of time.
- Do not charge batteries/battery packs at temperatures outside the range of 5 - 40 °C (41 - 104 °F).

This may cause electric shock, explosion or fire.

- Do not allow the product to maintain contact with the same area of skin for extended periods of time during use.

This may result in low-temperature contact burns, including skin redness and blistering, even if the product does not feel hot. The use of a tripod or similar equipment is recommended when using the product in hot places and for people with circulation problems or less sensitive skin.

- Follow any indications to turn off the product in places where its use is forbidden.

Not doing so may cause other equipment to malfunction due to the effect of electromagnetic waves and even result in accidents.



CAUTION: Denotes the risk of injury.

- Do not fire the flash near the eyes.

It may hurt the eyes.

- Do not look at the screen or through the viewfinder for prolonged periods of time.

This may induce symptoms similar to motion sickness. In such a case, stop using the product immediately and rest for a while before resuming use.

- Flash emits high temperatures when fired. Keep fingers, any other part of your body, and objects away from the flash unit while taking pictures.

This may cause burns or malfunction of the flash.

- Do not leave the product in places exposed to extremely high or low temperatures.

The product may become extremely hot/cold and cause burns or injury when touched.

- Strap is intended for use on the body only. Hanging the strap with any product attached on a hook or other object may damage the product. Also, do not shake the product or expose the product to strong impacts.

- Do not apply strong pressure on the lens or allow an object to hit it.

This may cause injury or damage to the product.

- Only mount the product on a tripod that is sufficiently sturdy.
- Do not carry the product when it is mounted on a tripod.

This may cause injury or may result in an accident.

- Do not touch any parts inside the product.

This may cause injury.

- If any abnormal skin reaction or irritation occurs during or following the use of this product, refrain from further use and get medical advice/attention.

Handling Precautions

Camera Care

- This camera is a precision instrument. Do not drop it or subject it to physical shock.
- The camera is not waterproof and cannot be used underwater. If the camera gets wet, contact a Canon Service Center immediately. Wipe off any water droplets with a clean, dry cloth, and if the camera is exposed to salty air, wipe it off with a clean, well-wrung wet cloth.
- Using the camera in a location with large amounts of dirt or dust may cause a malfunction.
- Cleaning the camera after use is recommended. Allowing dirt, dust, water, or salt to remain on the camera may cause a malfunction.
- Never leave the camera near anything having a strong magnetic field such as a magnet or electric motor. Also, avoid using or leaving the camera near anything emitting strong radio waves, such as a large antenna. Strong magnetic fields can cause camera malfunction or destroy image data.
- Do not leave the camera in excessive heat, such as in a car in direct sunlight. High temperatures can cause the camera to malfunction.
- The camera contains precision electronic circuitry. Never attempt to disassemble the camera yourself.
- Do not block the built-in flash or shutter curtain operations with your finger or other objects. Doing so may cause a malfunction.
- Use a commercially available blower brush to remove dust from the lens or other parts. Do not use cleaners that contain organic solvents to clean the camera body or lens. For stubborn dirt, take the camera to the nearest Canon Service Center.
- Do not touch the camera's electrical contacts with your fingers. This is to prevent the contacts from corroding. Corroded contacts can cause camera malfunction.
- If the camera is suddenly brought in from the cold into a warm room, condensation may form on the camera and internal parts. To prevent condensation, first put the camera in a sealed plastic bag and let it adjust to the warmer temperature before taking it out of the bag.

- If condensation forms on the camera, to avoid damage, do not use the camera or remove the lens, card, or battery. Turn the camera off and wait until the moisture has fully evaporated before resuming use. Even after the camera is completely dry, if it is still internally cold, do not remove the lens, card, or battery until the camera has adjusted to the ambient temperature.
- If the camera will not be used for an extended period, remove the battery and store the camera in a cool, dry, well-ventilated location. Even while the camera is in storage, press the shutter button a few times once in a while to check that the camera is still working.
- Avoid storing the camera where there are chemicals that result in rust and corrosion such as in a chemical lab.
- If the camera has not been used for an extended period, test all its functions before using it. If you have not used the camera for some time or if there is an important shoot such as a foreign trip coming up, have the camera checked by your nearest Canon Service Center or check the camera yourself and make sure it is working properly.
- The camera may become hot after repeated continuous shooting or still photo/movie shooting over an extended period. This is not a malfunction.
- If there is a bright light source inside or outside the image area, ghosting may occur.

Screen

- Although the screen is manufactured with very high precision technology with over 99.99% effective pixels, 0.01% or fewer of the pixels may be dead, and there may also be spots of black, red, or other colors. This is not a malfunction. They do not affect the images recorded.
- If the screen is left on for a prolonged period, screen burn-in may occur where you see remnants of what was displayed. However, this is only temporary and will disappear when the camera is left unused for a few days.
- The screen display may seem slightly slow in low temperatures or may look black in high temperatures. It will return to normal at room temperature.

Cards

To protect the card and its recorded data, note the following:

- Do not drop, bend, or wet the card. Do not subject it to excessive force, physical shock, or vibration.
- Do not touch the card's electronic contacts with your fingers or anything metallic.
- Do not affix any stickers, etc. on the card.
- Do not store or use the card near anything that has a strong magnetic field, such as a television, speakers, or magnets. Also avoid places prone to having static electricity.
- Do not leave the card in direct sunlight or near a heat source.
- Store the card in a case.
- Do not store the card in hot, dusty, or humid locations.

Smudges on the Image Sensor

- Besides dust entering the camera from outside, in rare cases, lubricant from the camera's internal parts may adhere to the front of the sensor. If smudges are visible on images, have the sensor cleaned by a Canon Service Center.

Lens

- After detaching the lens from the camera, put down the lens with the rear end up and attach the rear lens cap to avoid scratching the lens surface and electrical contacts (1).



Part Names

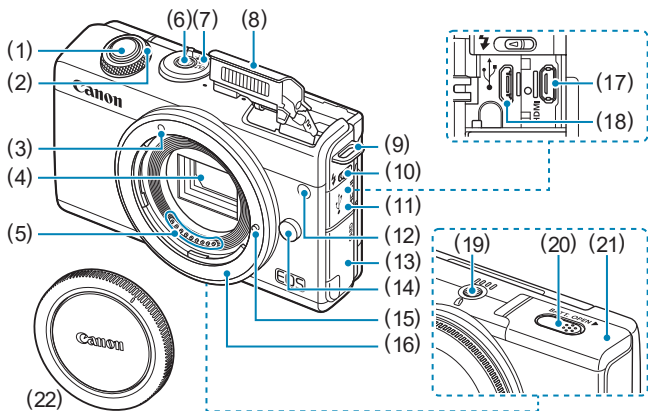

- (1) Shutter button
- (2) Dial
- (3) EF-M lens mount index
- (4) Image sensor
- (5) Contacts
- (6) Power button
- (7) Shooting mode switch
- (8) Flash
- (9) Strap mount
- (10) Flash up lever
- (11) Terminal cover
- (12) AF-assist beam/Red-eye reduction/Self-timer/Remote control lamp

- (13) Card slot cover
- (14) Lens release button
- (15) Lens lock pin
- (16) Lens mount
- (17) HDMI OUT terminal
- (18) Digital terminal
- (19) Tripod socket
- (20) DC coupler cord hole
- (21) Battery compartment cover
- (22) Body cap

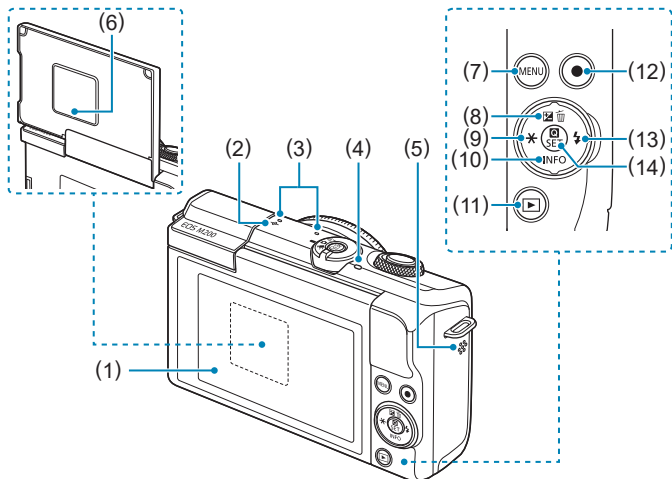

-
- (1) Screen
-
- (2) <⊖> Focal plane mark
-
- (3) Microphone
-
- (4) Access lamp
-
- (5) Speaker
-
- (6) Serial number (body number)
-
- (7) <MENU> Menu button
-
- (8) <▲/⊲/⊳> Up/Exposure compensation/Eraser button
-

-
- (9) <◀/✳> Left/AE lock/FE lock button
-
- (10) <▼/INFO> Down/Info button
-
- (11) <▶> Playback button
-
- (12) Movie shooting button
-
- (13) <▶/⚡> Right/Flash button
-
- (14) <Q/SET> Quick Control/Setting button
-

Shooting Mode Switch/Shooting Modes

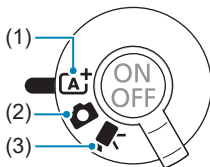

(1) **A⁺**: Scene Intelligent Auto Mode (📖 72)

All you do is press the shutter button. Fully automatic shooting, with settings determined by the camera.

(2) **📷**: Still Photo Mode











For still photo shooting. You can let the camera determine settings for the subject or scene, or you can take more control over shooting. To select a shooting mode, you can tap a shooting mode icon in the upper left of the shooting screen. Press the <◀> <▶> keys to select a shooting mode, then press <SET>.

Advanced Shooting Modes











P	Program AE (📖 104)
Tv	Shutter-priority AE (📖 106)
Av	Aperture-priority AE (📖 108)
M	Manual exposure (📖 110)

A⁺: Hybrid Auto Mode (📖 72)

Special Scene Mode

	Self Portrait (📖 82)		Food (📖 88)
	Portrait (📖 83)		Night Portrait (📖 89)
	Smooth skin (📖 84)		Handheld Night Scene (📖 90)
	Landscape (📖 85)		HDR Backlight Control (📖 91)
	Sports (📖 86)		Silent Mode (📖 92)
	Close-up (📖 87)		

Creative Filters Mode (📖 96)

	Grainy B/W (📖 98)		Miniature effect (📖 99)
	Soft focus (📖 98)		HDR art standard (📖 99)
	Fish-eye effect (📖 98)		HDR art vivid (📖 99)
	Water painting effect (📖 98)		HDR art bold (📖 99)
	Toy camera effect (📖 98)		HDR art embossed (📖 99)

(3) 🎬: Movie Mode

For movie recording. To select a shooting mode, you can tap a shooting mode icon in the upper left of the shooting screen. Press the <◀> <▶> keys to select a shooting mode, then press <SET>.

	Movie auto exposure (📖 198)
	Movie manual exposure (📖 200)

Battery Charger LC-E12E

Charger for Battery Pack LP-E12 (📖 42).

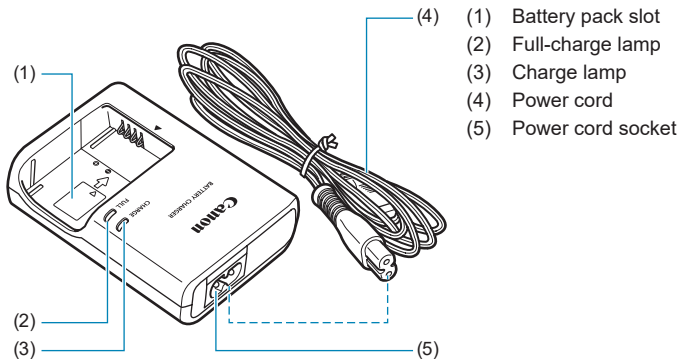

Attaching the Strap

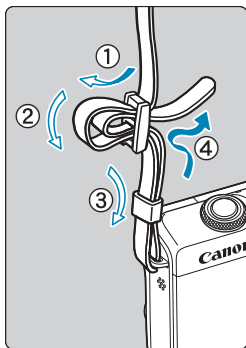

Pass the end of the strap through the camera's strap mount eyelet from the bottom. Then pass it through the strap's buckle as shown in the illustration. Pull the strap to take up any slack and make sure the strap will not loosen from the buckle.

Preparation and Basic Operations

This chapter describes preparatory steps before you start shooting and the basic camera operations.

Charging the Battery

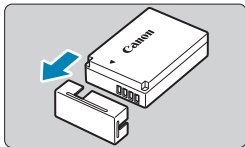

- 1** Detach the protective cover provided with the battery.

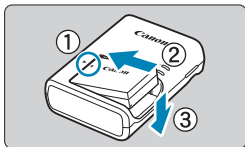

- 2** Fully insert the battery into the charger.

- Do the opposite to remove the battery.

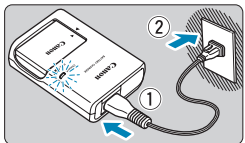

- 3** Recharge the battery.

- Connect the power cord to the charger and insert the plug into a power outlet.
- Recharging starts automatically and the charge lamp lights up in orange.
- When the battery is fully recharged, the full-charge lamp will light up in green.
- **It takes approx. 2 hr. to fully charge a completely exhausted battery at room temperature (23°C/73°F).** The time required to charge the battery will vary greatly depending on the ambient temperature and the battery's remaining capacity.
- For safety reasons, charging in low temperatures (5–10°C/41–50°F) will take longer (up to approx. 4 hr.).

- **Upon purchase, the battery is not fully charged.**

Charge the battery before use.

- **Recharge the battery on the day before or on the day it is to be used.**

Even during storage, a charged battery will gradually drain and lose its capacity.

- **After charging the battery, remove it and disconnect the charger from the power outlet.**

- **When not using the camera, remove the battery.**

If the battery is left in the camera for a prolonged period, a small amount of power current will keep being released, resulting in excess discharge and shorter battery life. Store the battery with the protective cover attached. Storing the battery when it is fully charged may lower the battery performance.

- **The battery charger can also be used in foreign countries.**

The battery charger is compatible with a 100 V AC to 240 V AC 50/60 Hz power source. If necessary, attach a commercially available plug adapter for the respective country or region. Do not attach any portable voltage transformer to the battery charger. Doing so may damage the battery charger.

- **If the battery becomes exhausted quickly even after having been fully charged, the battery has reached the end of its service life.**

Purchase a new battery.



- After disconnecting the charger's power plug, do not touch the prongs for approx. 5 sec.
- The provided charger cannot charge any battery other than Battery Pack LP-E12.

Inserting/Removing the Battery

Insert a fully charged Battery Pack LP-E12 into the camera.

Insertion

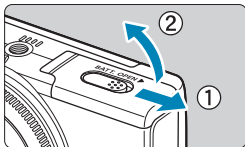

- 1 Slide the battery compartment cover to open it.**

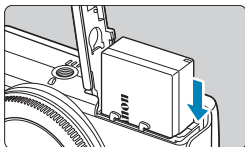

- 2 Insert the battery.**
 - Insert the end with the electrical contacts.
 - Insert the battery until it locks in place.

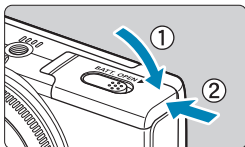

- 3 Close the cover.**
 - Slide the cover until it snaps shut.

- You cannot use batteries other than the Battery Pack LP-E12.
- After opening the battery compartment cover, be careful not to swing it back any further. Otherwise, the hinge may break.

Removal

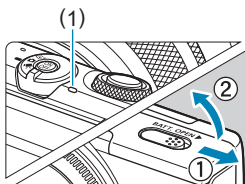

1 Open the battery compartment cover.

- Turn the camera off.
- Check that the access lamp (1) is off, then open the cover.

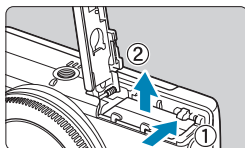

2 Remove the battery.

- Press the battery lock lever as shown by the arrow and remove the battery.
- To prevent short-circuits, always attach the included protective cover (📖 42) to the battery.

Inserting/Removing the Card

The captured images are recorded onto the card.

- Make sure the card's write-protect switch (1) is set upward to enable writing and erasing.

Insertion

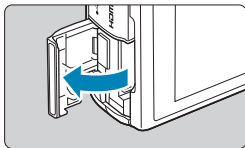

- 1 Open the card slot cover.

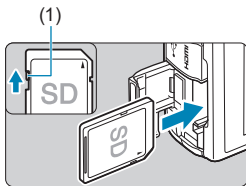

- 2 Insert the card.
 - Insert the card with the label facing the back of the camera until it clicks in place.

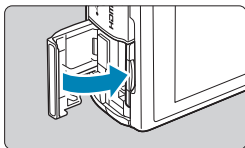

- 3 Close the cover.

Removal

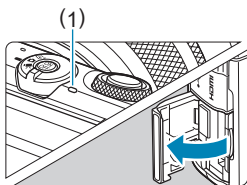

1 Open the cover.

- Turn the camera off.
- Check that the access lamp (1) is off, then open the cover.
- If [Saving...] is displayed on the screen, close the cover.

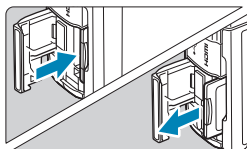

2 Remove the card.

- Gently push in the card, then let it go to eject.
- Pull the card straight out, then close the cover.

Formatting the Card

If the card is new or was previously formatted (initialized) by another camera or computer, format the card with this camera (📖 433).



- The number of possible shots varies depending on the remaining capacity of the card, the settings of image quality, ISO speed, etc.

- 
- **When the access lamp is lit or blinking, it indicates that images are being written to, read from, or erased from the card, or data is being transferred. Do not open the card slot cover or remove the battery at this time. Also, never do any of the following while the access lamp is lit or blinking. Otherwise, it can damage the image data, card, or camera.**
 - **Removing the card.**
 - **Removing the battery.**
 - **Shaking or striking the camera.**
 - **Unplugging and connecting a power cord** (when household power outlet accessories (sold separately) are used).
 - If the card already contains recorded images, the image number may not start from 0001 (📖 428).
 - If a card-related error message is displayed on the screen, remove and reinsert the card. If the error persists, use a different card.
If you can transfer images on the card to a computer, transfer all the images and then format the card with the camera (📖 433). The card may then return to normal.
 - Do not touch the card's contacts with your fingers or metal objects. Do not expose the contacts to dust or water. If smudges adhere to the contacts, contact failure may result.
 - Multimedia cards (MMC) cannot be used. (Card error will be displayed.)

Using the Screen

You can change the direction and angle of the screen.

Tilting the Screen Upward

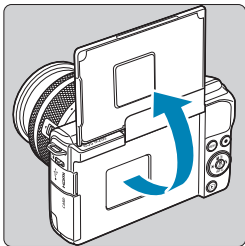

- The screen lifts upward and opens to about 180°.
- When including yourself in shots, you can view a mirror image of yourself by rotating the screen around toward the front of the camera.



- When the camera is not in use, keep the screen closed.
- Do not force the screen open too far, which may damage the camera.

Turning on the Power

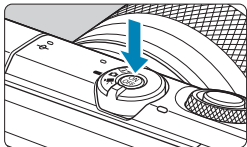

To turn the camera on, press the power button. Press it again to turn the camera off.

Setting the Date, Time, and Time Zone

If you turn on the power and the date/time/zone setting screen appears, see  438 to set the date/time/zone.

Changing the Interface Language

To change the interface language, see  441.



- **[Saving...]** is displayed if you turn off the camera during image recording to the card, and the camera will turn off after recording is finished.

Battery Level Indicator



- : Battery level is sufficient.
- : Battery level is low, but the camera can still be used.
- : Battery will be exhausted soon.
(Blinks)
- : Charge the battery.



- Doing any of the following will exhaust the battery faster:
 - Pressing the shutter button halfway for a prolonged period.
 - Activating the AF frequently without taking a picture.
 - Using the lens's Image Stabilizer.
 - Using the Wi-Fi function or Bluetooth function.
- The number of possible shots may decrease depending on the actual shooting conditions.
- The lens operation is powered by the camera's battery. Certain lenses may exhaust the battery faster than others.
- In low ambient temperatures, shooting may not be possible even with a sufficient battery level.

Attaching/Detaching a Lens

The camera is compatible with EF-M lenses.

Attaching a Lens

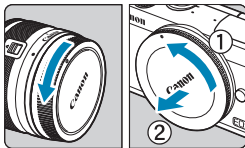

1 Remove the caps.

- Remove the rear lens cap and the body cap by turning them as shown by the arrows.

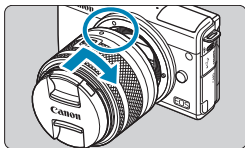

2 Attach the lens.

- Align the white mount index on the lens with the white mount index on the camera and turn the lens as shown by the arrow until it clicks in place.

3 Remove the front lens cap.

Detaching the Lens

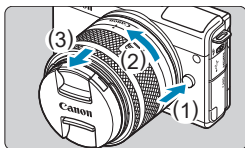

While pressing the lens release button, turn the lens as shown by the arrow.

- Turn the lens until it stops, then detach it.
- Attach the rear lens cap to the detached lens.



- Do not look at the sun directly through any lens. Doing so may cause loss of vision.
- Turn off the camera before attaching or detaching lenses.
- If the front part (focusing ring) of the lens rotates during autofocus, do not touch the rotating part.



● Shooting angle of view

- Because the image area is smaller than 35mm film format, the effective angle of view corresponds to approx. 1.6 times the lens's indicated focal length.

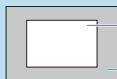

Image area (approx.) (22.3×14.9 mm/0.88×0.59 in.)

35mm film format (36×24 mm/1.42×0.94 in.)

- For instructions on how to use the lens, refer to the Lens Instruction Manual (4).

Tips for Avoiding Smudges and Dust

When changing lenses, do it quickly in a place with minimal dust.

When storing the camera without a lens attached, be sure to attach the body cap to the camera.

Remove dust on the body cap before attaching it.

Attaching/Detaching EF/EF-S Lenses

EF and EF-S lenses can be used by attaching the optional Mount Adapter EF-EOS M.

Attaching a Lens

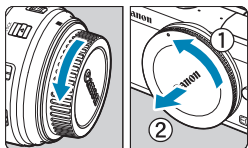

1 Remove the caps.

- Remove the caps on the lens, adapter, and body.

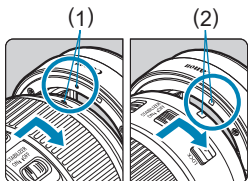

2 Attach the lens to the adapter.

- Align the red or white mount index on the lens with the corresponding mount index on the adapter and turn the lens as shown by the arrow until it clicks into place.

- (1) Red index
- (2) White index

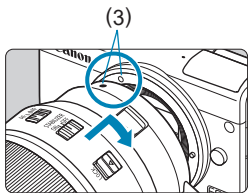

3 Attach the adapter to the camera.

- Align the white mount indexes (3) on the adapter and camera and turn the lens as shown by the arrow until it clicks into place.

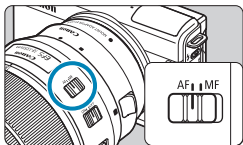

4 Set the lens's focus mode switch to <AF>.

- <AF> stands for autofocus.
- <MF> stands for manual focus. Autofocus will not operate.

5 Remove the front lens cap.

Detaching the Lens

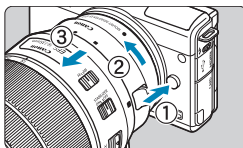

1 While pressing the lens release button, turn the adapter as shown by the arrow.

- Turn the adapter until it stops, then detach it.

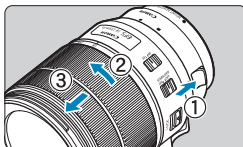

2 Detach the lens from the adapter.

- Hold down the lens release lever on the adapter and turn the lens counterclockwise.
- Turn the lens until it stops, then detach it.
- Attach the rear lens cap to the detached lens.



- For lens precautions, see [53](#).
- When using a lens that is heavier than the camera, hold the camera by the lens when you shoot or carry it.
- With EF lenses that incorporate a tripod mount (such as super telephoto lenses), attach the tripod to the tripod mount on the lens. When using lenses without a tripod mount, attach the tripod to the tripod mount on the mount adapter.

Basic Operations

Holding the Camera

As you shoot, you can tilt the screen to adjust it. For details, see  49.



Normal angle



Low angle

Shutter Button

The shutter button has two steps. You can press the shutter button halfway. Then you can further press the shutter button completely.

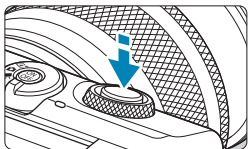

Pressing Halfway

This activates autofocus and the automatic exposure system that sets the shutter speed and aperture.

The exposure setting (shutter speed and aperture value) is displayed for approx. 8 sec. or as set for the metering timer.*

* By default, the metering timer is set to 8 sec.

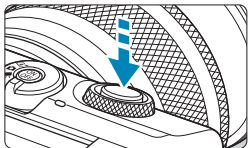

Pressing Completely

This action shoots.

● Preventing Camera Shake

Hand-held camera movement during the moment of exposure is called camera shake. It can cause blurred pictures. To prevent camera shake, note the following:

- Hold the camera steady.
- Press the shutter button halfway to autofocus, then slowly press the shutter button completely.



- If you press the shutter button completely without pressing it halfway first, or if you press the shutter button halfway and then press it completely immediately, the camera will take a moment before it takes the picture.
- Even during menu display or image playback, you can go back to shooting-ready state by pressing the shutter button halfway.

<  > Dial

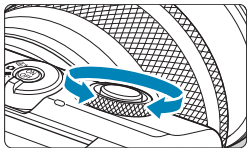

While looking at the screen, turn the <  > dial.

Use this dial to set the shutter speed, aperture value, etc.

INFO Button

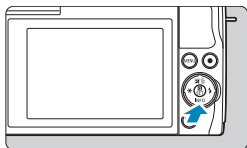

Each press of the <INFO> button changes the information shown.

The following sample screens are for still photos.



Setting the Screen Display Level

You can set how information is displayed on the screen according to your preference. Change the settings as necessary.

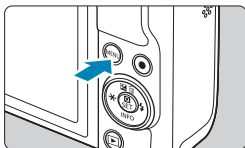

1 Display the main tabs.

- Press the <MENU> button to display the main tabs.

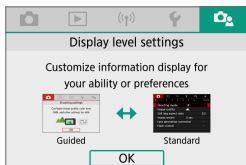

2 Select the [Guided] tab.

- Press the <◀> <▶> keys of the cross keys to select the [Guided] tab.

Menu Display

You can select the display type from **[Guided]** or **[Standard]**. If you set **[Guided]**, main tab descriptions are provided when you press the <MENU> button. If you set **[Standard]**, the menu screen is displayed immediately after you press the <MENU> button. By default, it is set to **[Guided]**.

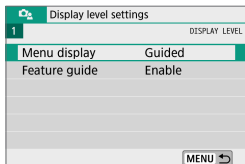

1 Select [Menu display].

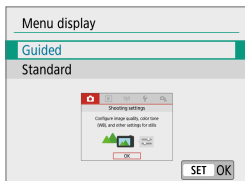

2 Select the display type.

(1)

(1) Main tabs

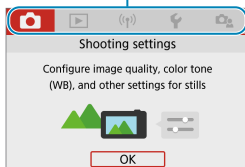

- When **[Guided]** is set, the **[★ (My Menu)]** tab does not appear. To set My Menu (465), change the menu display level to **[Standard]**.

Feature Guide

A brief description of functions and items can be displayed when you use Quick Control or menu settings. By default, it is set to **[Enable]**.

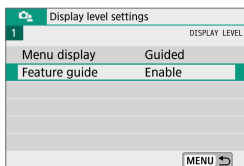

1 Select **[Feature guide]**.

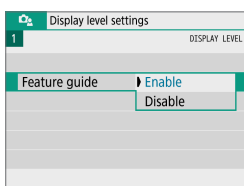

2 Select **[Enable]**.

Sample screens

Quick Control screen

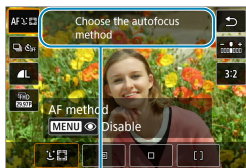

(1)

Menu screen

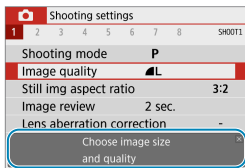

(1)

(1) Feature guide



- To clear a description, either tap it or continue performing operations.

Menu Operations and Settings

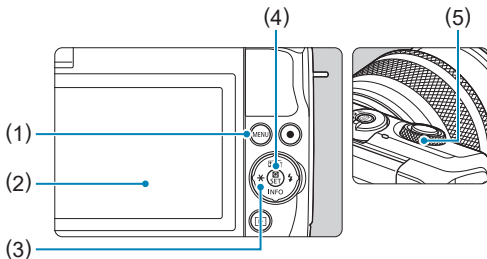

(1) <MENU> button

(2) Screen

(3) <⬆> Cross keys

(4) <SET> button

(5) Dial

Menu Screen

<A+> mode



Shooting settings	
1	2 3 4 5 SHOOT1
Shooting mode	[A+]
Image quality	▲L
Still img aspect ratio	3:2
Image review	2 sec.
Flash control	-
Drive mode	□&fr
MENU >	

Movie mode



Shooting settings	
1	2 3 4 5 6 SHOOT1
Shooting mode	MOVIE
Movie rec quality	FinD 60FPS IPB
Movie self-timer	Off
Sound recording	Auto
Lens aberration correction	-
MENU >	

Still photo mode (in advanced shooting modes)

Shooting settings	
1	2 3 4 5 6 7 8 SHOOT1
Shooting mode	P
Image quality	▲L
Still img aspect ratio	3:2
Image review	2 sec.
Lens aberration correction	-
Flash control	-
MENU >	



- The menu tabs and items displayed vary depending on the shooting mode.

Menu Setting Procedure

- With [: Menu display] set to [Guided]

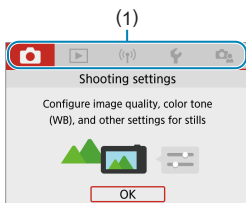

1 Display the main tabs.

- When you press the <MENU> button, the main tabs (1) and a description of the selected tab will appear.

2 Select a main tab.

- Each time you press the <<> <>> keys of the cross keys, the main tab (group of functions) will switch.
- You can also select by turning the < > dial.

3 Display the menu screen.

- Press <SET> to display the menu screen.
- To return to the main tab screen, press the <MENU> button.

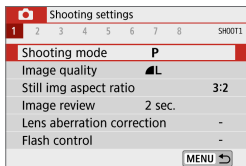

4 Select a secondary tab.

- Press the <<> <>> keys of the cross keys to select a secondary tab.
- You can also select by turning the < > dial.

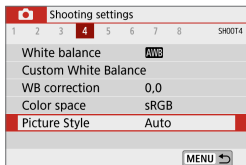

5 Select a setting item.

- Press the <▲> <▼> keys of the cross keys to select the item, then press <SET>.

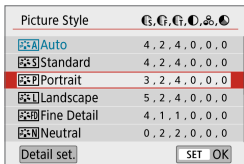

6 Select an option.

- Press the <▲> <▼> or <◀> <▶> keys of the cross keys to select the desired option. (Some options are selected with the <▲> and <▼> keys, and others are selected with the <◀> and <▶> keys.)
- The current setting is indicated in blue.

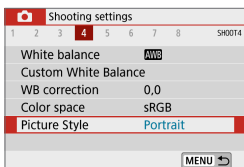

7 Set an option.

- Press <SET> to set it.
- If you change the setting from the default, it will be indicated in blue (available only for the menu items under the [📷] tab).

8 Exit the setting.

- Press the <MENU> button twice to exit the menu and return to shooting-ready state.



- In steps 2 to 8, you can also tap on the screen to perform the operation (📖 68).
- The description of menu functions hereafter assumes that the menu screen is displayed.
- To cancel the operation, press the <MENU> button.

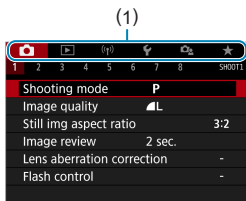

- With [: Menu display] set to [Standard]



1 Display the menu screen.

- Press the <MENU> button to display the menu screen.

2 Select a tab.

- Press the << >> <>> keys to select the main tab (1) and secondary tab.
- You can also select by turning the < > dial.
- After this, operations are the same as when [: Menu display] is set to [Guided]. See “Menu Setting Procedure” ( 64), starting with step 5.
- To exit the setting, press the <MENU> button.

Dimmed Menu Items

Example: Highlight tone priority

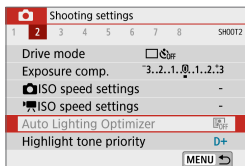

Dimmed menu items cannot be set. The menu item is dimmed if another function setting is overriding it.

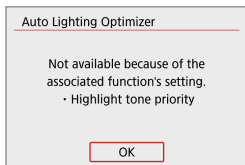

You can see the overriding function by selecting the dimmed menu item and pressing <SET>.

If you cancel the overriding function's setting, the dimmed menu item will become settable.



- You may not be able to see the overriding function for certain dimmed menu items.



- [Basic settings]** in **[F: Reset camera]** enables you to restore menu functions to default settings (453).

Touch-Screen Operation

You can operate the camera by tapping or dragging on the screen (touch-screen panel) with your finger.

Tap

Sample screen (Quick Control)



- Use your finger to tap on (touch briefly and then remove your finger from) the screen.
- For example, when you tap on **[Q]**, the Quick Control screen appears. By tapping on **[↶]**, you can return to the preceding screen.

Drag

Sample screen (Menu screen)

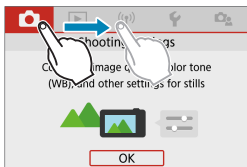

- Slide your finger while touching the screen.

- If **[🔔: Beep]** is set to **[Touch 🔔]**, the beep will not sound for touch operations (📖 446).
- Touch control responsiveness can be adjusted (📖 444).

Quick Control

You can directly select and set the settings displayed on the screen. This is called Quick Control (except in [A+] mode).

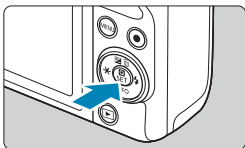

1 Press the <Q> button (ⓘ10).

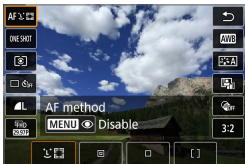

2 Select a setting item.

- Press the <▲> <▼> keys for selection.

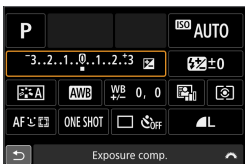

- When the screen at left is displayed, press the <▲> <▼> <◀> <▶> keys for selection.

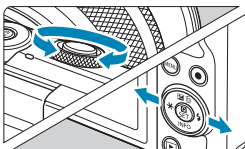

3 Select an option.

- Turn the <⦿> dial, or press the <◀> <▶> keys to change the setting. Some items are set by pressing a button after this.
- Press <SET> to finalize the setting and return to the previous screen.



- You can also tap on the screen for Quick Control settings (📖68).



Basic Shooting Modes

This chapter describes effective shooting techniques in [A+], [A], Special scene (📖 80), and Creative filters (📖 96) modes. Simply compose your shot and press the shutter button, and all settings are set automatically.

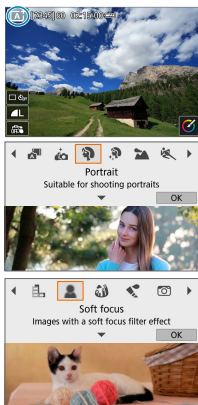

Scene Intelligent Auto/Hybrid Auto (Fully Automatic)

[**A+**] [**A**] is a fully automatic mode. The camera analyzes the scene and sets the optimum settings automatically. It can adjust focus automatically on either the still or moving subject by detecting the motion of the subject.

With [**A**], you can make a short movie of the day just by shooting still photos. The camera records 2–4-second clips of scenes before each shot, which are later combined in a digest movie (📖 190, 📖 268).



1 Set the shooting mode switch to <A+>.

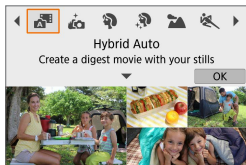

- To use [**A**] mode, after setting the shooting mode switch to <📷>, tap the upper left of the screen and press the <◀> <▶> keys to select [**A**] mode, then press <SET>.

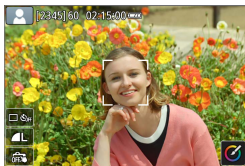

2 Aim the camera at what you will shoot (the subject).

- A frame may be displayed around the subject, under some shooting conditions.
- AF points are displayed over any faces detected.

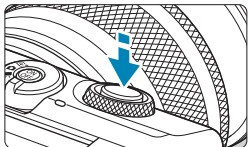

3 Focus on the subject.

- Press the shutter button halfway to focus.
- If [⚡] blinks, use the <⚡> lever to raise the flash.
- You can also focus by tapping a person's face or another subject on the screen (Touch AF).
- Under low light, the AF-assist beam (📖 184) is automatically activated if needed.
- For stationary subjects, the AF point is displayed in green when the subject is in focus. The camera beeps at this time (<A+> mode only). (One-Shot AF)
- For moving subjects, the AF point is displayed in blue (<A+> mode only) and tracks subject movement. The camera does not beep. (Servo AF)

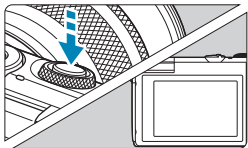

4 Take the picture.

- Press the shutter button completely to take the picture.
- The image just captured will be displayed for approx. 2 sec. on the screen.
- To retract the flash, push it down with your fingers.





- Subject movement (whether subjects are still or moving) may not be detected correctly for some subject or shooting conditions.



- AF operation (One-Shot AF or Servo AF) is set automatically when you press the shutter button halfway. Even when automatically set to One-Shot AF, the camera will switch to Servo AF if subject motion is detected while you are pressing the shutter button halfway (<A+> mode only).
- The [A+] mode makes the colors look more impressive in nature, outdoor, and sunset scenes. If you prefer other colors, switch to an advanced shooting mode (138) and select a Picture Style other than [P-A], then shoot again (154).

Hybrid Auto

- For more impressive digest movies, aim the camera at subjects about four seconds before shooting still images.
- Battery life is shorter in this mode than in <A+> mode, because digest movies are recorded for each shot.
- A digest movie may not be recorded if you shoot a still photo immediately after turning the camera on, choosing <A+> mode, or operating the camera in other ways.
- Any sounds and vibrations from your camera or lens operations will be recorded in digest movies.
- Digest movie image quality is  for NTSC or  for PAL. This varies depending on the video system setting.
- Sounds are not played when you press the shutter button halfway or trigger the self-timer.
- Digest movies are saved as separate movie files in the following cases even if they were recorded on the same day in <A+> mode.
 - The digest movie recording time reaches approx. 29 minutes and 59 seconds. (May also be saved as separate files if the size exceeds approx. 4 GB.)
 - The digest movie is protected.
 - Daylight saving time, video system, or time zone settings are changed.
- Recorded shutter sounds cannot be modified or erased.

 **Minimizing Blurred Photos**

- Use a sturdy tripod that can bear the weight of the shooting equipment. Mount the camera securely on the tripod.
- Using a wireless remote control (sold separately,  191) is recommended.

 **FAQ**

- **Focusing is not possible (indicated by an orange AF point).**
Aim the camera at an area with good contrast, then press the shutter button halfway ( 57). If you are too close to the subject, move away and shoot again.
- **Multiple AF points are displayed simultaneously.**
If multiple AF points are displayed simultaneously, all of these positions are in focus. As long as one AF point is displayed on the subject, you can take the picture.
- **Pressing the shutter button halfway does not focus the subject.**
If the focus mode switch on the lens is set to <MF>, set it to <AF>.
- **The shutter speed display is blinking.**
Since it is too dark, taking the picture may result in a blurred subject due to camera shake. Using a tripod is recommended.

Recomposing the Shot

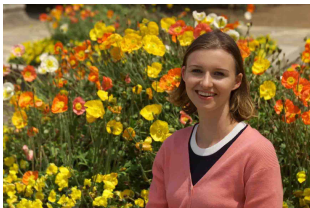

Depending on the scene, positioning the subject toward the left or right to include a balanced background will result in a picture with better perspective.

Pressing the shutter button halfway to focus on a still subject will lock the focus on that subject. Recompose the shot while keeping the shutter button pressed halfway, and then press the shutter button completely to take the picture. This is called “focus lock”.

Shooting a Moving Subject (<A+> mode only)



After you press the shutter button halfway and a blue AF point appears, the camera detects subject movement and focuses using Servo AF. Keep the subject on the screen as you hold down the shutter button halfway, and at the decisive moment, press the shutter button completely.

Scene Icons



The camera detects the scene type and sets everything automatically to suit the scene. The detected scene type is indicated on the upper left of the screen. For icon details, see [📖 505](#).

Adjusting Settings by Touching the Screen



By tapping icons on the screen, you can adjust settings.

Shooting with Effects Applied (Creative Assist)

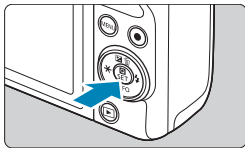

- 1 Press the **<Q>** button.
 - Read the message and select **[OK]**.

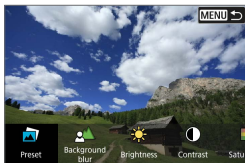

- 2 Select an effect.
 - Use the **<◀>** **<▶>** keys to select an effect, then press **<SET>**.



- 3 Select the effect level and other details.
 - Use the **<◀>** **<▶>** keys to set it, then press **<SET>**.
 - To reset the setting, press the **<✱>** button, then select **[OK]**.

Creative Assist Effects

- **[🖼️] Preset**
Select one of the preset effects.
Note that **[Saturation]**, **[Color tone 1]**, and **[Color tone 2]** are not available with **[B&W]**.
- **[🌄] Background blur**
Adjust background blur. Choose higher values to make backgrounds sharper, or lower values to make them blurrier. **[Auto]** adjusts background blurring to match the brightness. Depending on lens brightness (f/number), some positions may not be available.

-  **Brightness**

Adjust image brightness.

-  **Contrast**

Adjust contrast.

-  **Saturation**

Adjust the vividness of colors.

-  **Color tone 1**

Adjust amber/blue color tone.

-  **Color tone 2**

Adjust green/magenta color tone.

-  **Monochrome**

Set the toning effect for monochrome shooting. Set to **[Off]** to shoot in color. **[Saturation]**, **[Color tone 1]**, and **[Color tone 2]** are not available with options other than **[Off]**.



- **[Background blur]** is not available when the flash is used.
- These settings are reset when you switch modes or turn the camera off.
To save the settings, set **[📷: Retain Creative Assist data]** to **[Enable]**.

Saving Effects

To save the current setting to the camera, tap **[Register]** on the Creative Assist setting screen. Up to three presets can be saved as **[USER*]**. After three have been saved, an existing **[USER*]** preset must be overwritten to save a new one.

Special Scene Mode

The camera will automatically choose the appropriate settings when you select a shooting mode for your subject or scene.



1 Set the shooting mode switch to .

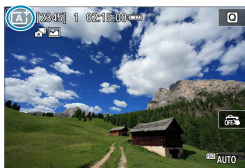



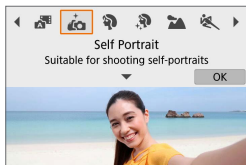

2 Tap the shooting mode icon.



3 Select a shooting mode.













- Choose from [- Press the <◀> <▶> keys to select a shooting mode, then press <SET>.
- You can also select by turning the dial.











 ● Cautions on each shooting mode are listed together ( 93). Read the cautions before shooting.

 ● You can also set the shooting mode in [ : Shooting mode].

● Take some test shots first to make sure you obtain the desired results.

Special Scene Mode

Shooting Mode		Page
	Self Portrait	 82
	Portrait	 83
	Smooth skin	 84
	Landscape	 85
	Sports	 86
	Close-up	 87

Shooting Mode		Page
	Food	 88
	Night Portrait	 89
	Handheld Night Scene	 90
	HDR Backlight Control	 91
	Silent Mode	 92

Self Portrait Mode

To take shots of yourself, use **[Self Portrait]** mode. Rotate the screen around toward the lens. Customizable image processing includes skin smoothing as well as brightness and background adjustment to make yourself stand out.

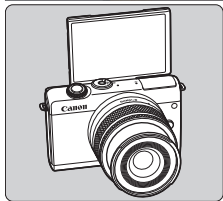
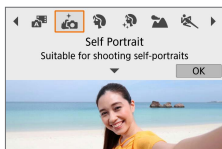

Shooting Tips

- **Set the brightness and smooth skin effect.**

[Brightness] and **[Smooth skin effect]** can be set in a range of five levels. In **[Background]**, you can adjust the level of background blurring.

- **Tap on the screen to shoot.**

Besides pressing the shutter button completely to shoot, you can also shoot by tapping the screen, once you enable Touch Shutter by tapping **[Touch Shutter]** to change it to **[Touch Shutter]**.



- You can also take shots of yourself in shooting modes other than **[Self Portrait]** (except **[Self Portrait]** mode) by rotating the screen toward the front and tapping **[Self Portrait]** in the lower left.

Portrait Mode

The [👤] (Portrait) mode blurs the background to make the human subject stand out. It also makes skin tones and hair look softer.

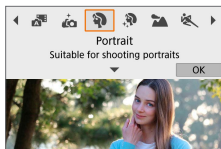

Shooting Tips

- **Select the location where the distance between the subject and the background is the farthest.**

The further the distance between the subject and background, the more blurred the background will look. The subject will also stand out better against an uncluttered dark background.

- **Use a telephoto lens.**

If you have a zoom lens, use the telephoto end to fill the frame with the subject from the waist up.

- **Focus on the face.**

As you focus, make sure the AF point on the face is lit in green before you shoot. When shooting close-ups of the face, you can set [📷: Eye Detection AF] to [Enable] to shoot with the subject's eyes in focus.

- **Shoot continuously.**

The default setting is [📷] (Continuous shooting). If you keep holding down the shutter button, you can shoot continuously to capture changes in the subject's facial expression and pose.

Smooth Skin Mode

Use [👤] (Smooth skin) mode to make skin look more attractive. Image processing makes skin look smoother.

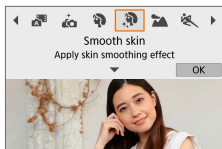

Shooting Tips

- **Enable the camera to detect faces.**

Frames are displayed around any main subjects detected for skin smoothing. For more effective skin smoothing, you can move closer to or farther from the subject so that the frame is displayed on the subject's face.

- **Focus on the face.**

As you focus, make sure the AF point on the face is lit in green before you shoot. When shooting close-ups of the face, you can set [📷: Eye Detection AF] to [Enable] to shoot with the subject's eyes in focus.

Landscape Mode

Use the [🏔️] (Landscape) mode for expansive scenery or to have everything in focus from near to far. For vivid blues and greens, and very sharp and crisp images.

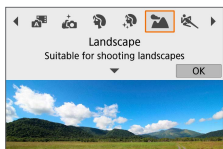

Shooting Tips

- **With a zoom lens, use the wide-angle end.**
When using a zoom lens, set the lens to the wide-angle end to make the objects near and far in focus. It also adds breadth to landscapes.
- **Keep the camera steady when shooting night scenes.**
Shooting with [🏔️] while handholding the camera may cause camera shake. Using a tripod is recommended.

Sports Mode

Use the [🏃] (Sports) mode to shoot a moving subject, such as a running person or a moving vehicle.

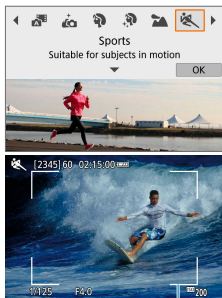

(1)



Shooting Tips

- **Use a telephoto lens.**

Use of a telephoto lens is recommended to enable shooting from a distance.

- **Track the subject with the Area AF frame.**

By default, [📷: AF method] is set to [👁️ +Tracking]. An Area AF frame (1) appears when you press the shutter button halfway. Once the subject is in focus, the AF point turns blue.

- **Shoot continuously.**

The default setting is [📷] (Continuous shooting). At the decisive moment, press the shutter button completely to take the shot. To track the subject and capture changes as it moves, keep holding down the shutter button to shoot continuously.

Close-up Mode

When you want to shoot flowers or small things up close, use the [🌸] (Close-up) mode. To make small things appear much larger, use a macro lens (sold separately).

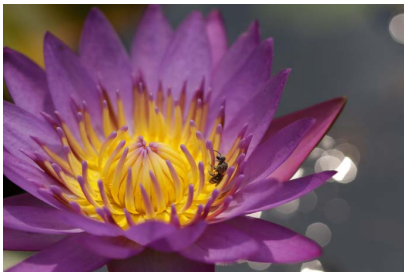
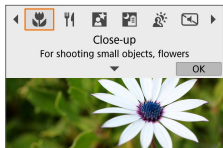

Shooting Tips

- **Use a simple background.**

A simple background makes small objects such as flowers stand out better.

- **Move in as close as possible to the subject.**

Check the lens for its minimum focusing distance. The lens minimum focusing distance is measured from the ∞ (focal plane) mark on the top of the camera to the subject. Focusing is not possible if you are too close.

- **With a zoom lens, use the telephoto end.**

If you have a zoom lens, using the telephoto end will make the subject look larger.

Food Mode

When you want to take pictures of food, use **[🍴]** (Food). The photo will look bright and appetizing. Also, depending on the light source, the reddish tinge will be suppressed in the pictures taken under tungsten lights, etc.



Shooting Tips

- **Change the color tone.**

You can change **[Color tone]**. To increase the food's reddish tinge, set it toward **[Warm]**. Set it toward **[Cool]** if it looks too red.

Night Portrait Mode

When you want to photograph people at night and obtain a natural-looking night scene in the background, use the **[Ni]** (Night Portrait) mode. Note **that a flash is required for shooting**. Using a tripod is recommended.

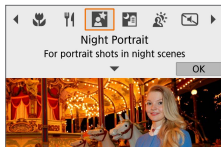

Shooting Tips

- **Use a wide-angle lens and a tripod.**

When using a zoom lens, use the wide-angle end to obtain a wide night view. Also, since camera shake is prone to occur with handheld shooting, use a tripod.

- **Check the image brightness.**

It is recommended to play back the captured image on location to check the image brightness. If the subject looks dark, move nearer and shoot again.

- **Also shoot in other shooting modes.**

Since camera shake is prone to occur with night shots, shooting also with **[A+]** is recommended.



- If you use the self-timer together with a flash, the self-timer lamp will light up briefly after the picture is taken.

Handheld Night Scene Mode

The **[P]** (Handheld Night Scene) mode enables you to shoot night scenes even while handholding the camera. In this shooting mode, four shots are taken consecutively for each picture, and the resulting image with reduced camera shake is recorded.

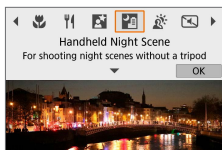

Shooting Tips

- **Hold the camera firmly.**

During shooting, hold the camera firmly and steadily. In this mode, four shots are aligned and merged into a single image. However, if there is significant misalignment in any of the four shots due to camera shake, they may not align properly in the final image.

HDR Backlight Control Mode

When shooting a scene having both the bright and dark areas, use the [🌞] (HDR Backlight Control) mode. When you take one picture in this mode, three consecutive shots are taken at different exposures. This results in one image, with a wide tonal range, that has minimized the clipped shadows caused by backlighting.

* HDR stands for High Dynamic Range.

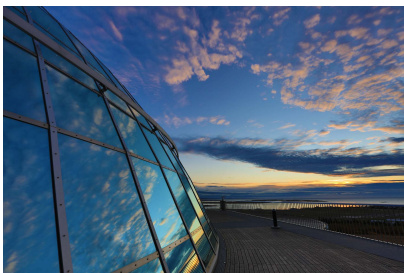
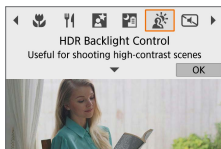

Shooting Tips

● Hold the camera firmly.

During shooting, hold the camera firmly and steadily. In this mode, three shots are aligned and merged into a single image. However, if there is significant misalignment in any of the three shots due to camera shake, they may not align properly in the final image.

Silent Mode

Where silence is needed, you can shoot without beeps or shutter release sounds. As you shoot, a white frame is momentarily displayed around the screen.

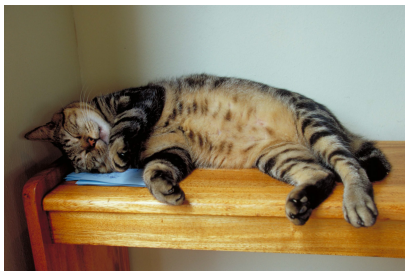
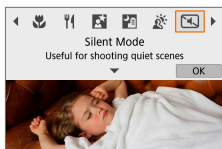

Shooting Tips



- **Take some test shots.**

Consider taking some test shots in advance, because lens aperture and focusing adjustment may be audible under some shooting conditions.

Special Scene Mode Precautions





Self Portrait

- Areas other than people's skin may be modified, depending on the shooting conditions.
- **[Smooth skin effect]** settings specified in  mode are not applied in  mode.
- **[Background]** is set to **[Auto]** and cannot be changed in  flash mode when you have raised the flash.



Smooth skin

- Areas other than people's skin may be modified, depending on the shooting conditions.
- Setting details in  mode are not applied in  mode.



Landscape

- Flash photography is not possible.



Sports

- Under low light where camera shake tends to occur, the shutter speed value in the lower left will blink. Hold the camera steady and shoot.
- Flash photography is not possible.



Food

- The warm color cast of subjects may fade.
- When multiple light sources are included in the scene, the warm color cast of the picture may not be reduced.
- If you use a flash, **[Color tone]** will be set to Standard.
- If there are people in the picture, the skin tone may not be reproduced properly.



Night Portrait

- Tell subjects to remain still for a moment after the flash fires.
- Focusing may be difficult when subject faces look dark. In this case, focus manually by setting **[Focus mode]** to **[MF]** or setting the lens's focus mode switch to **<MF>** (📖 55, 📖 182).
- Autofocusing at night or in dark scenes may be difficult when points of light lie within the AF point. In this case, focus manually by setting **[Focus mode]** to **[MF]** or setting the lens's focus mode switch to **<MF>** (📖 55, 📖 182).
- Shots will look slightly different from the image as displayed on the screen.



: Night Portrait (continued)

- When there is a risk of overexposure in flash photography, shutter speed or ISO speed is automatically adjusted to reduce loss of detail in highlights and shoot at standard exposure. In flash shots with certain lenses, shutter speeds and ISO speeds displayed when you press the shutter button halfway may not match the actual settings used. This may alter the brightness of backgrounds that are out of flash range.

: Handheld Night Scene

- Compared to other shooting modes, the image area will be smaller.
- RAW image quality cannot be set.
- Flash photography is not possible.
- Autofocusing at night or in dark scenes may be difficult when points of light lie within the AF point. In this case, focus manually by setting [: Focus mode] to [MF] or setting the lens's focus mode switch to <MF> (📖 55, 📖 182).
- Shots will look slightly different from the image as displayed on the screen.
- If you shoot a moving subject, the subject's movement may leave afterimages or the surrounding area of the subject may become dark.
- The image alignment may not function properly with repetitive patterns (lattice, stripes, etc.), flat or single-tone images, or images significantly misaligned due to camera shake.
- It takes some time to record images to the card since they are merged after shooting. [BUSY] is displayed as images are processed, and shooting is not possible until processing is finished.



: HDR Backlight Control

- Compared to other shooting modes, the image area will be smaller.
- RAW image quality cannot be set.
- Flash photography is not possible.
- Note that the image may not be rendered with a smooth gradation and may look irregular or have significant noise.
- HDR Backlight Control may not be effective for excessively backlit scenes or extremely high-contrast scenes.
- When shooting subjects that are sufficiently bright as they are, for example for normally lit scenes, the image may look unnatural due to the HDR effect.
- If you shoot a moving subject, the subject's movement may leave afterimages or the surrounding area of the subject may become dark.
- The image alignment may not function properly with repetitive patterns (lattice, stripes, etc.), flat or single-tone images, or images significantly misaligned due to camera shake.
- It takes some time to record images to the card since they are merged after shooting. **[BUSY]** is displayed as images are processed, and shooting is not possible until processing is finished.

: Silent Mode

- Be responsible when using silent shooting, and respect subject privacy and portrait rights.
- Images of fast-moving subjects may look distorted.
- Continuous shooting and flash photography are not available.

Creative Filters Mode

You can shoot with filter effects applied. You can preview filter effects before shooting.









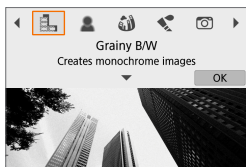

1 Set the shooting mode switch to .



2 Tap the shooting mode icon.





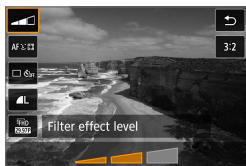

3 Select a filter effect (shooting mode).

- Choose from [>, [>, [>, [>, [>, [>, [>, [>, or [>.
- Press the <◀> <▶> keys to select a shooting mode, then press <SET>.
- You can also select by turning the dial.
- The image is shown with the filter effect applied.



4 Adjust the effect and shoot.

- Press the button and select an item in the upper left. (Not available for [>, [>, [>, [>, or [>.)
- Use the <◀> <▶> keys to adjust the effect, then press <SET>.



- RAW and RAW+JPEG are not available. When RAW image quality is set, images are captured with **L** image quality. When RAW+JPEG image quality is set, images are captured with the specified JPEG image quality.
- Continuous shooting is not available when [📷], [👤], [👁️], [🔍], [📷], or [📷] is set.



- With [📷], the grainy preview will differ somewhat from the appearance of your shots.
- With [👤] or [👁️] options, the soft focus preview may differ somewhat from the appearance of your shots.
- No histogram is displayed.
- A magnified view is not available.
- In advanced shooting modes, these settings are available from the Quick Control screen: [📷], [👤], [👁️], [🔍], [📷], [📷], and [📷].
- Take some test shots first to make sure you obtain the desired results.

Creative Filter Characteristics

-  **Grainy B/W**

Makes the image grainy and black and white. By adjusting the contrast, you can change the black-and-white effect.

-  **Soft focus**

Gives the image a soft look. By adjusting the blur, you can change the degree of softness.

-  **Fish-eye effect**

Gives the effect of a fish-eye lens. The image will have barrel distortion. Depending on the level of this filter effect, the area trimmed along the periphery of the image changes. Also, because this filter effect magnifies the center of the image, the apparent resolution at the center may degrade depending on the number of recorded pixels, so set the filter effect while checking the resulting image. One AF point is used, fixed at the center.

-  **Water painting effect**

Makes the photo look like a watercolor painting with soft colors. By adjusting the effect, you can change the color density. Note that night scenes or dark scenes may not be rendered with a smooth gradation and may look irregular or have significant noise.

-  **Toy camera effect**

Shifts colors to those typical of toy cameras and darkens the four corners of the image. Color tone options can be used to change the color cast.

-  **Miniature effect**

Creates a diorama effect.

Shooting under the default setting will keep the center looking sharp. You can move the area that looks sharp (the scene frame) as described in “Miniature Effect Operations” (📖 101). 1-point AF is used as the AF method. Shooting with the AF point and scene frame aligned is recommended.

-  **HDR art standard**

Photos retain more detail in highlights and shadows. With reduced contrast and flatter gradation, the finish resembles a painting. The subject outlines will have bright (or dark) edges.

-  **HDR art vivid**

The colors are more saturated than with **[HDR art standard]**, and the low contrast and flat gradation create a graphic art effect.

-  **HDR art bold**

The colors are the most saturated, making the subject pop out, and the picture looks like an oil painting.

-  **HDR art embossed**

The color saturation, brightness, contrast and gradation are decreased to make the picture look flat. The picture looks faded and old. The subject outlines will have intensely bright (or dark) edges.



- With **[HDR]**, **[HDR]**, **[HDR]**, and **[HDR]**, you can shoot high dynamic range photos that retain detail in highlights and shadows of high-contrast scenes. Three consecutive images are captured at different brightnesses each time you shoot and used to create a single image. See the cautions on 📖 100.



[], [], [], and [] Notes

- Compared to other shooting modes, the image area will be smaller.
- Filter effect previews will not look exactly the same as your shots.
- If you shoot a moving subject, the subject's movement may leave afterimages or the surrounding area of the subject may become dark.
- The image alignment may not function properly with repetitive patterns (lattice, stripes, etc.), flat or single-tone images, or images significantly misaligned due to camera shake.
- Be careful about camera shake in handheld shots.
- The color gradation of the sky or white walls may not be reproduced correctly. Irregular colors, irregular exposure or noise may appear.
- Shooting under fluorescent or LED lighting may result in unnatural color reproduction of the illuminated areas.
- It takes some time to record images to the card since they are merged after shooting. **[BUSY]** is displayed as images are processed, and shooting is not possible until processing is finished.
- Flash photography is not possible.

Miniature Effect Operations

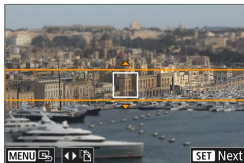

1 Move the scene frame.

- Use the scene frame to set an area that will look sharp.
- To make the scene frame movable (displayed in orange), press the <INFO> button or tap [📷] in the lower right of the screen.
- To switch between vertical and horizontal scene frame orientation, tap [📷] in the lower left of the screen.
- To move a horizontal scene frame, press the <▲> <▼> keys, and to move a vertical scene frame, press the <◀> <▶> keys.
- To return the scene frame to the center of the screen, tap [📷] in the lower left of the screen.
- Press <SET> to confirm the position of the scene frame. Next, set the AF point.



2 Move the AF point.

- The AF point turns orange and can be moved.
- Press the <⬆️> cross keys to move the AF point to the position to focus on.
- Aligning the AF point and scene frame is recommended.
- To return the AF point to the center of the screen, tap [📷] in the lower left of the screen.
- Press <SET> to confirm the position of the AF point.

3 Take the picture.

- 
- You can switch the scene frame orientation in step 1 with the <◀> <▶> keys when in horizontal orientation or the <▲> <▼> keys when in vertical orientation.

Advanced Shooting Modes



Advanced shooting modes ([P], [Tv], [Av], and [M]) give you the freedom to shoot in a variety of ways by setting your preferred shutter speed, aperture value, exposure, and more.

- To clear the description displayed after shooting mode selection, press <SET> (📖 38).

Program AE Mode (P)

The camera automatically sets the shutter speed and aperture to suit the subject's brightness.

* "P" stands for Program.

* "AE" stands for Auto Exposure.

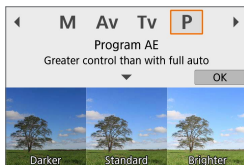

1 Set the shooting mode to [P].

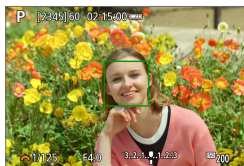

2 Focus on the subject.

- Aim the AF point over the subject and press the shutter button halfway.

3 Check the display and shoot.

- As long as the exposure value is not blinking, standard exposure will be obtained.



- If the "30" shutter speed and the lowest f/number blink, it indicates underexposure. Increase the ISO speed or use flash.
- If the "1/4000" shutter speed and the highest f/number blink, it indicates overexposure. Lower the ISO speed or use an ND filter (sold separately) to reduce the amount of light entering the lens.



Differences Between [P] and [A+] Modes

- In [A+] mode, many functions, such as the AF method and metering mode, are set automatically to prevent spoiled shots. The functions you can set are limited. On the other hand, with [P] mode, only the shutter speed and aperture are set automatically. You can freely set the AF method, metering mode, and other functions.

Program Shift

- To adjust the combination of shutter speed and aperture value while maintaining the same exposure, press the shutter button halfway and turn the dial. This is called Program shift.
- Program shift will be canceled automatically when the metering timer ends (exposure setting display turns off).
- Program shift cannot be used with flash.

Shutter-priority AE Mode (Tv)

In this mode, you set the shutter speed and the camera automatically sets the aperture to obtain the standard exposure matching the brightness of the subject. A faster shutter speed can freeze the action of a moving subject. A slower shutter speed can create a blurred effect, giving the impression of motion.

* "Tv" stands for Time value.



Blurred motion
(Slow speed: 1/30 sec.)



Frozen motion
(Fast speed: 1/2000 sec.)

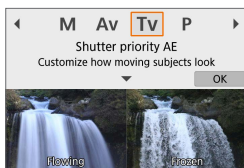

1 Set the shooting mode to [Tv].

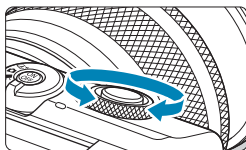

2 Set the desired shutter speed.

- Turn the  dial to set it.

3 Focus on the subject.

- Press the shutter button halfway.

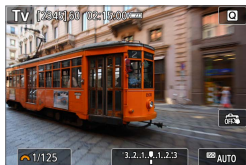

4 Check the display and shoot.

- As long as the aperture value is not blinking, the standard exposure will be obtained.



- If the lowest f/number blinks, it indicates underexposure. Turn the dial to set a slower shutter speed until the aperture value stops blinking or set a higher ISO speed.
- If the highest f/number blinks, it indicates overexposure. Turn the dial to set a faster shutter speed until the aperture value stops blinking or set a lower ISO speed.



Shutter Speed Display

- For example, "0"5" indicates 0.5 sec. and "15"', 15 sec.

Aperture-priority AE Mode (Av)

In this mode, you set the desired aperture and the camera sets the shutter speed automatically to obtain the standard exposure matching the subject brightness. A higher f/number (smaller aperture hole) will make more of the foreground and background fall within acceptable focus. On the other hand, a lower f/number (larger aperture hole) will make less of the foreground and background fall within acceptable focus.

* "Av" stands for Aperture value (aperture opening).



Blurred background

(With a low aperture f/number: f/5.6)



Sharp foreground and background

(With a high aperture f/number: f/32)

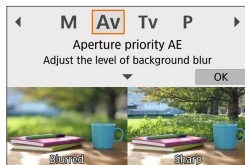

1 Set the shooting mode to [Av].

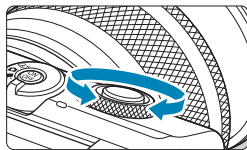

2 Set the desired aperture.

- Turn the dial to set it.

3 Focus on the subject.

- Press the shutter button halfway.

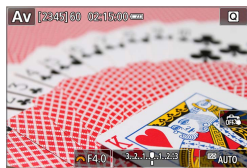

4 Check the display and shoot.

- As long as the shutter speed is not blinking, the standard exposure will be obtained.



- If the “30” shutter speed blinks, it indicates underexposure. Turn the dial to set a larger aperture (lower f/number) until the shutter speed blinking stops or set a higher ISO speed.
- If the “1/4000” shutter speed blinks, it indicates overexposure. Turn the dial to set a smaller aperture (higher f/number) until the shutter speed blinking stops or set a lower ISO speed.



Aperture Value Display

- The higher the f/number, the smaller the aperture opening will be. The f/number displayed varies depending on the lens. If no lens is attached to the camera, “F00” will be displayed for the aperture.

Checking the Area in Focus ☆

By assigning the movie shooting button to [**1: Depth-of-field preview**] (using [**Movie shooting button function**] in [**Custom Functions(C.Fn)**] (460)), you can press the movie shooting button to stop down the lens to the current aperture setting and check the area in focus (depth of field).



- The larger the aperture value, the wider the area in focus, from the foreground to the background.
- The resulting depth-of-field is apparent as you change the aperture value while holding down the depth-of-field preview button.
- Exposure is locked (AE lock) as you hold down the button assigned to depth-of-field preview.

Manual Exposure Mode (M)

In this mode, you set both the shutter speed and aperture as desired. To determine the exposure, refer to the exposure level indicator or use a commercially available exposure meter.

* "M" stands for Manual.

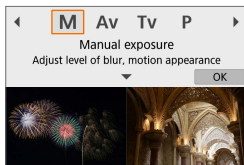

1 Set the shooting mode to [M].

2 Set the ISO speed (📖 138).

- With ISO Auto, you can set exposure compensation (📖 111).



3 Set the desired shutter speed.

- Turn the <🌅> dial to set it.



4 Set the aperture value.

- Press the <▲> key to select the aperture value, then turn the <🌅> dial to set a value.



5 Focus on the subject.

- Press the shutter button halfway.
- Check the exposure level mark [█] to see how far the current exposure level is from the standard exposure level.

- (1) Standard exposure index
- (2) Exposure level mark

6 Set the exposure and take the picture.

- Check the exposure level indicator and set the desired shutter speed and aperture value.

Exposure Compensation with ISO Auto

If the ISO speed is set to **[AUTO]** for manual exposure shooting, you can set exposure compensation (📖 137) as follows:

- Touch the exposure level indicator
- **[📷: Exposure comp.]**



- If ISO Auto is set, the ISO speed setting will change to obtain the standard exposure with the set shutter speed and aperture. Therefore, you may not obtain the desired exposure effect. In this case, set the exposure compensation.



- With evaluative metering, holding down the shutter button halfway locks the ISO speed once the subject is in focus with One-Shot AF.
- When ISO Auto is set, you can press the **<✳>** button to lock the ISO speed.
- To compare the current exposure to the exposure when you pressed the **<✳>** button initially with a manually set ISO speed, press the **<✳>** button, recompose the shot, and check the exposure level indicator.

Long (Bulb) Exposures

In this mode, the shutter stays open as long as you hold down the shutter button completely, and closes when you let go of the shutter button. Use bulb exposures for night scenes, fireworks, the heavens, and other subjects requiring long exposures.

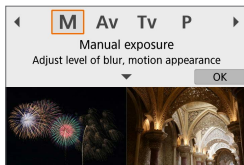

1 Set the shooting mode to [M].



2 Set the shutter speed to [BULB].

- Turn the <☀> dial to the left to set [BULB].

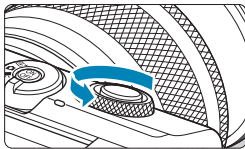

3 Set the aperture value.

- Press the <▲> key to select the aperture value, then turn the <☀> dial to set a value.

4 Take the picture.

- The exposure will continue for as long as you keep the shutter button pressed completely.
- The elapsed exposure time will be displayed on the screen.



- Do not point the camera toward an intense light source, such as the sun or an intense artificial light source. Doing so may damage the image sensor or the camera's internal components.
- Long bulb exposures produce more noise in the image than usual.
- If ISO Auto is set, ISO 400 will be set (📖 494).



- With [: **Long exp. noise reduction**], you can reduce the noise generated during long exposures (📖 162).
- To reduce camera shake, consider using a tripod and optional Wireless Remote Control BR-E1.



Shooting Settings

This chapter describes shooting and introduces menu settings on the [📷: Shooting settings] tab.

Still Photo Shooting

- A ☆ icon to the right of a page title indicates that the function is available only in advanced shooting modes ([P], [Tv], [Av], or [M]).

Tab Menus: Still Photo Shooting

● Shooting settings 1

Shooting settings								
1	2	3	4	5	6	7	8	SHOOT1
Shooting mode	P							103
Image quality	L							122
Still img aspect ratio	3:2							125
Image review	2 sec.							127
Lens aberration correction	-							128
Flash control	-							248
MENU →								

● Shooting settings 2

Shooting settings								
1	2	3	4	5	6	7	8	SHOOT2
Drive mode	□ OFF							133
Exposure comp.	3..2..1..0..1..2..3							137
ISO speed settings	-							138
ISO speed settings	-							236
Auto Lighting Optimizer	□ OFF							141
Highlight tone priority	OFF							142
MENU →								



● Shooting settings 3

Shooting settings								
1	2	3	4	5	6	7	8	SHOOT3
Metering mode	☉							143
Metering timer	8 sec.							145
Expo. simulation	Enable							146
MENU →								



● Shooting settings 4

Shooting settings								
1	2	3	4	5	6	7	8	SHOOT4
White balance		AWB						147
Custom White Balance								150
WB correction		0,0						152
Color space		sRGB						153
Picture Style		Auto						154, 157, 160
MENU 								

● Shooting settings 5

Shooting settings								
1	2	3	4	5	6	7	8	SHOOT5
Long exp. noise reduction		OFF						162
High ISO speed NR								163
Touch Shutter		Disable						165
MENU 								

● Shooting settings 6

Shooting settings								
1	2	3	4	5	6	7	8	SHOOT6
AF operation		ONE SHOT AF						167
AF method		AF 						170
Eye Detection AF		Disable						180
Continuous AF		Enable						181
Focus mode		AF						182
MENU 								

● Shooting settings 7

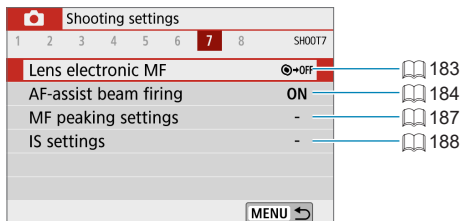

● Shooting settings 8

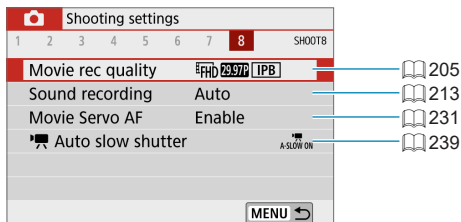

The following screens are displayed in [A+], [A], Special scene, and Creative filters modes.

● Shooting settings 1

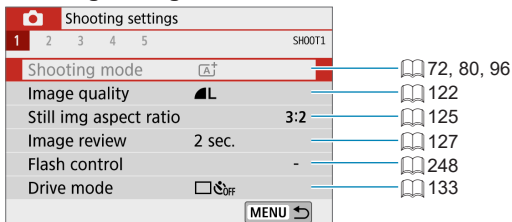

● Shooting settings 2

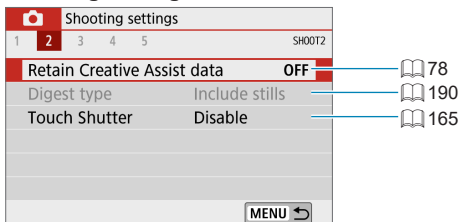

● Shooting settings 3

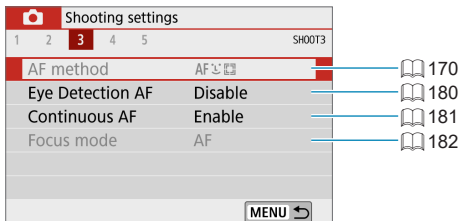

● Shooting settings 4

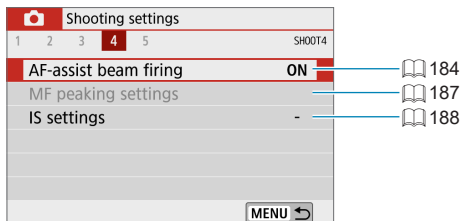

● Shooting settings 5

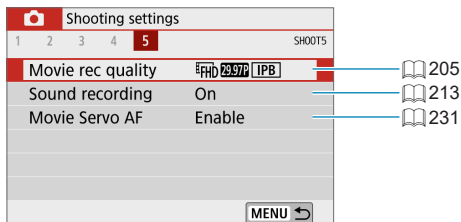

- Available setting items vary depending on shooting mode.
- **[Retain Creative Assist data]** is available in **[A+]** mode.
- **[Digest type]** is available in **[A]** mode.

Image Quality

You can select the pixel count and the image quality.

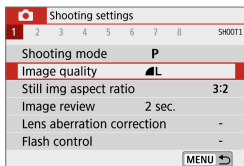

1 Select [: Image quality].

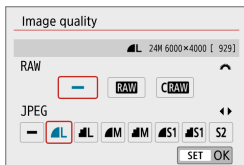

2 Set the image quality.

- To select the RAW quality, turn the dial, and to select the JPEG quality, press the keys.
- Press <SET> to set it.

• Number of shots available as indicated by [****] on the image quality setting screen always applies to a setting of [3:2], regardless of the actual aspect ratio setting (125).

-
- If [-] is set for both the RAW image and JPEG image, will be set.
 - If you select both RAW and JPEG, each time you shoot, the image will be recorded simultaneously to the card in both RAW and JPEG at the image-recording qualities that were set. The two images will be recorded with the same file numbers (file extension: .JPG for JPEG and .CR3 for RAW).
 - S2 is in (Fine) quality.
 - Meaning of image quality icons: RAW, Compact RAW, JPEG, Fine, Normal, Large, Medium, Small.

RAW Images

RAW images are raw data from the image sensor that are recorded to the card digitally as **RAW** or **CRRAW** (smaller than **RAW**) files, depending on your selection.

You can use Digital Photo Professional (EOS software) to process RAW images. You can make various adjustments to images depending upon how they will be used and can generate JPEG or other types of images reflecting the effects of those adjustments.



RAW Image Processing Software

- To display RAW images on a computer, using Digital Photo Professional (hereafter DPP, EOS software) is recommended.
- Previous versions of DPP Ver.4.x cannot process RAW images taken with this camera. If a previous version of DPP Ver.4.x is installed on your computer, obtain and install the latest version of DPP from the Canon website to update it (📖 472). (The previous version will be overwritten.) Note that DPP Ver.3.x or earlier cannot process RAW images taken with this camera.
- Commercially available software may not be able to display RAW images taken with this camera. For compatibility information, contact the software manufacturer.

Guide to Image Quality Settings

For guidelines on file sizes, number of possible shots, and maximum burst shots, see 📖 495.

Maximum Burst for Continuous Shooting



The estimated maximum burst is shown on the top of the shooting screen.

- If the maximum burst is displayed as "99", it indicates that you can shoot 99 or more shots continuously. The value starts decreasing once it reaches 98 or less. **[BUSY]** display indicates that internal memory is full and shooting will stop temporarily. If you stop continuous shooting, the maximum burst will increase. After all the captured images are written to the card, you can resume continuous shooting and shoot up to the maximum burst listed in the table on 495.

Still Image Aspect Ratio

You can change the image's aspect ratio.

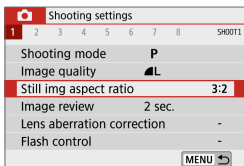

1 Select [: Still img aspect ratio].

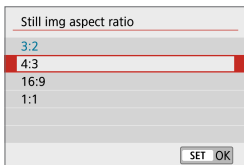

2 Set the aspect ratio.

- Select an aspect ratio, then press <SET>.

● JPEG images

The images will be recorded with the set aspect ratio.

● RAW images

The images will always be recorded in the **[3:2]** aspect ratio.

The selected aspect ratio information is added to the RAW image file. When you process the RAW image with Digital Photo Professional (EOS software), this allows you to generate an image with the same aspect ratio set for shooting.

Aspect Ratio		
4:3	16:9	1:1
		



- When you play back RAW images shot in the **[4:3]**, **[16:9]**, or **[1:1]** aspect ratio, they will be displayed with lines indicating the respective aspect ratio. (These lines are not recorded in the image.)

Image Review Time

You can change how long images are displayed after shots. Set to **[Hold]** to keep shots displayed immediately after you shoot, or set to **[Off]** if you prefer not to have shots displayed.

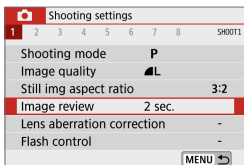

1 Select [: Image review].

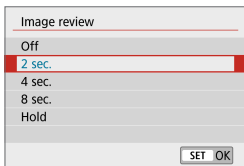

2 Set a time option.



- When **[Hold]** is set, images are displayed as long as the time set in [: Power saving].

Lens Aberration Correction



Vignetting, image distortion, and other issues may be caused by lens optical characteristics. The camera can compensate for these phenomena by using **[Lens aberration correction]**.

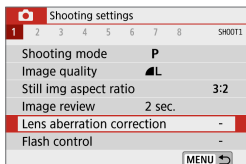

1 Select [: Lens aberration correction].

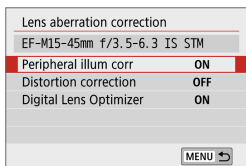

2 Select an item.

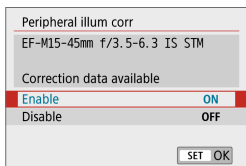

3 Select **[Enable]**.

- Confirm that the name of the attached lens and (except for diffraction correction) **[Correction data available]** are displayed.
- If **[Correction data not available]** or [] is displayed, see “Digital Lens Optimizer” (130).

Peripheral Illumination Correction

Vignetting (dark image corners) can be corrected.



- Depending on shooting conditions, noise may appear on the image periphery.
- The higher the ISO speed, the lower the correction amount will be.



- The correction amount applied will be lower than the maximum correction amount that applied with Digital Photo Professional (EOS software).
- Peripheral illumination is corrected automatically in [A+], [A⁺], Special scene, and Creative filters modes when correction data is registered on the camera.

Distortion Correction

Distortion (image warping) can be corrected.





- To correct distortion, the camera captures a narrower image area than the area seen when shooting, which crops the image a little and slightly lowers the apparent resolution.
- Setting distortion correction may change the angle of view slightly.
- When you magnify images, distortion correction is not applied to the images displayed.
- Distortion correction is not applied in movie recording.
- Playback of images with distortion correction applied may show the AF point out of position, relative to the time of shooting.

Digital Lens Optimizer

Various aberrations from lens optical characteristics can be corrected, along with diffraction and low-pass filter-induced loss of clarity.

If **[Correction data not available]** or  is displayed by **[Digital Lens Optimizer]**, you can use EOS Utility to add the lens correction data to the camera. For details, refer to the EOS Utility Instruction Manual.

-  Depending on shooting conditions, noise may be intensified together with the effects of correction. Image edges may also be emphasized. Adjust Picture Style sharpness or set **[Digital Lens Optimizer]** to **[Disable]** as needed before shooting.
- The higher the ISO speed, the lower the correction amount will be.
- For movie recording, **[Digital Lens Optimizer]** will not appear. (Correction is not possible.)

-  Enabling **[Digital Lens Optimizer]** corrects both chromatic aberration and diffraction, although these options are not displayed.
- Digital Lens Optimizer is applied automatically in **[A+]**, **[A-F]**, Special scene, and Creative filters modes when correction data is registered on the camera.

Chromatic Aberration Correction

Chromatic aberration (color fringing around subjects) can be corrected.



- **[Chromatic aberr corr]** is not displayed when **[Digital Lens Optimizer]** is enabled.

Diffraction Correction

Diffraction (loss of sharpness caused by the aperture) can be corrected.



- Depending on shooting conditions, noise may be intensified together with the effects of correction.
- The higher the ISO speed, the lower the correction amount will be.
- For movie recording, **[Diffraction correction]** will not appear.



- With “Diffraction correction”, degraded resolution due to the low-pass filter, etc. is corrected in addition to diffraction. Therefore, correction is effective even at an aperture close to the open aperture.
- **[Diffraction correction]** is not displayed when **[Digital Lens Optimizer]** is enabled.



General Cautions for Lens Aberration Correction

- Peripheral illumination correction, chromatic aberration correction, distortion correction, and diffraction correction cannot be applied to JPEG images already taken.
- When using a non-Canon lens, setting the corrections to **[Disable]** is recommended even if **[Correction data available]** is displayed.
- Magnifying the periphery of the image may display parts of the image that will not be recorded.
- The correction amount will be less (except for diffraction correction) if the lens used does not have distance information.



General Notes for Lens Aberration Correction

- The effect of the lens aberration correction varies depending on the lens used and shooting conditions. Also, the effect may be difficult to discern depending on the lens used, shooting conditions, etc.
- If the correction is difficult to discern, magnifying and checking the image after shooting is recommended.
- Corrections can be applied even when an extender or life-size converter is attached.
- If the correction data for the attached lens is not registered to the camera, the result will be the same as when the correction is set to **[Disable]** (except for diffraction correction).
- If necessary, refer to the EOS Utility Instruction Manual as well.

Drive Mode

Single and continuous drive modes are provided. You can select the drive mode suiting the scene or subject.

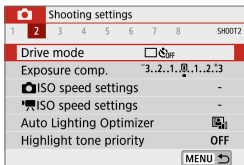

1 Select [: Drive mode].

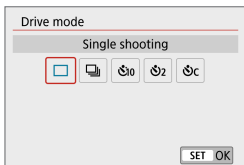



2 Set the drive mode.

- [] **Single shooting**

When you press the shutter button completely, only one shot will be taken.

- [] **Continuous shooting**



While you hold down the shutter button completely, you can shoot continuously at up to approx. 6.1 shots/sec. in One-Shot AF mode or 4.0 shots/sec. in Servo AF mode.

- [/ ] **Self-timer: 10 sec./remote control**

- [] **Self-timer: 2 sec.**

- [] **Self-timer: Continuous shooting**

For self-timer shooting, see  135. For remote control shooting, see  191.

-  Conditions for maximum continuous shooting speed ( 133) are as follows: shooting with a fully charged battery at a 1/1000 sec. or faster shutter speed and maximum aperture (which varies by lens) at room temperature (23°C/73°F).
- The maximum continuous shooting speed may be slower depending on factors such as the battery level, temperature, shutter speed, aperture value, subject conditions, brightness, AF operation, type of lens, use of flash, and shooting settings.
- With Servo AF, the maximum continuous shooting speed may become slower depending on subject conditions or the lens used.
- When internal memory becomes full during continuous shooting, the continuous shooting speed may drop off because shooting will be temporarily disabled ( 124).

Self-Timer

Use the self-timer when you want to be in the picture such as a commemorative photograph.

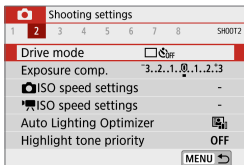

1 Select [: Drive mode].

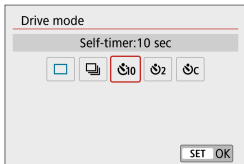

2 Select the self-timer.

- (): Shoot in 10 sec.
 - : Shoot in 2 sec.
 - : Shoot continuously in 10 sec. for the specified number of shots*
- * Press the <▲> <▼> keys to set the number of continuous shots (2–10).
- The [] icon is displayed when the camera is paired with a wireless remote control (sold separately, 191).

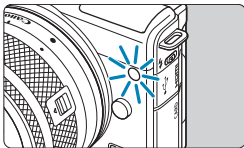



3 Take the picture.

- Focus on the subject, then press the shutter button completely.
- To check operation, look at the self-timer lamp, listen for beeps, or watch the countdown in seconds on the screen.
- Self-timer lamp blinking accelerates and the camera beeps quickly approx. 2 sec. before the picture is taken.



- With [], the shooting interval may become longer under some shooting conditions, such as image quality, use of flash, and other factors.



- [] enables you to shoot without touching the camera mounted on a tripod. This prevents camera shake if you shoot still-life or long exposures.
- After taking self-timer shots, playing back the image ( 256) to check focus and exposure is recommended.
- When using the self-timer to shoot yourself, use focus lock ( 76) on an object at the same distance as where you will stand.
- To cancel the self-timer after it starts, either tap the screen or press <SET>.
- Auto power off time may be extended when the camera is set for remote control shooting.

Exposure Compensation

Exposure compensation can brighten (increased exposure) or darken (decreased exposure) the standard exposure set by the camera.

Exposure compensation can be set in the **[P]**, **[Tv]**, **[Av]**, and **[M]** shooting modes. You can set exposure compensation up to ± 3 stops in 1/3-stop increments.

For details on exposure compensation when **[M]** mode and ISO Auto are both set, see  111.

Increased exposure for a brighter image



Decreased exposure for a darker image



1 Select the exposure level indicator.

- Press the **<▲>** key and select the exposure level indicator.

2 Set the compensation amount.

- Watch the screen and set by turning the **<☀>** dial.
- A **[☒]** icon is displayed to indicate exposure compensation.

3 Take the picture.

- To cancel exposure compensation, set the exposure level indicator **[■]** to the standard exposure index (**[☑]**).



- If **[📷: Auto Lighting Optimizer]** ( 141) is set to any setting other than **[Disable]**, the image may still look bright even if a decreased exposure compensation for a darker image is set.



- The exposure compensation amount will remain in effect even after you turn off the camera.
- You can also set with **[📷: Exposure comp.]**.

ISO Speed Settings



Set the ISO speed (image sensor's sensitivity to light) to suit the ambient light level. ISO speed is set automatically in [A+], [A], Special scene, and Creative filters modes.

Regarding the ISO speed during movie recording, see 499.

ISO Speed



1 Tap the ISO speed icon.

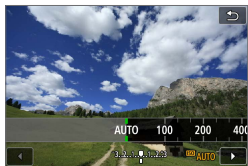

2 Set the ISO speed.

- Press the <◀> <▶> keys to set the ISO speed.
- ISO speed can be set within ISO 100–25600 in 1/3-stop increments.
- Select [AUTO] to set the ISO speed automatically.

ISO Speed Guide

- Low ISO speeds reduce image noise but may increase the risk of camera/subject shake or reduce the area in focus (shallower depth of field), in some shooting conditions.
- High ISO speeds enable low-light shooting, a larger area in focus (deeper depth of field), and longer flash range but may increase image noise.



- Can also be set in **[ISO speed]** in **[📷 ISO speed settings]**.
- Under **[🔧: Custom Functions(C.Fn)]**, if **[ISO expansion]** is set to **[1:On]**, "H" (equivalent to ISO 51200) can also be selected (📖 459).



- Image noise (such as dots of light or banding) may increase and apparent resolution may decrease at H (equivalent to ISO 51200), because this is an expanded ISO speed.
- If **[📷: Highlight tone priority]** is set to **[Enable]** or **[Enhanced]** (📖 142), ISO 100/125/160 and H (equivalent to ISO 51200) cannot be selected.
- When shooting with a high ISO speed, high temperature, or long exposure, image noise (rough grain, dots of light, banding, etc.), irregular colors, or color shift may become noticeable.
- When shooting in conditions that produce an extreme amount of noise, such as a combination of high ISO speed, high temperature, and long exposure, images may not be recorded properly.
- If you use a high ISO speed and flash to shoot a close subject, overexposure may result.

Max for Auto

The maximum ISO speed for the ISO Auto range can be set between ISO 400 and ISO 25600.

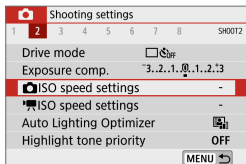

1 Select [ISO speed settings].

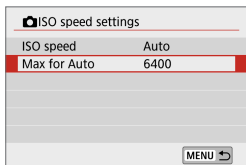

2 Select [Max for Auto].

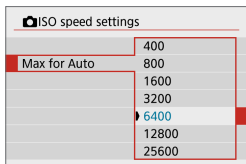

3 Set the maximum ISO speed.

- Select the ISO speed, then press <SET>.



Auto Lighting Optimizer

Brightness and contrast can be corrected automatically if shots look dark or contrast is too low or high.

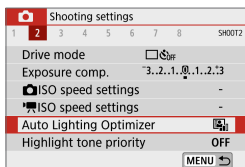

1 Select [: Auto Lighting Optimizer].

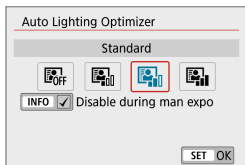

2 Set a correction option.



- Noise may increase and clarity may change, under some shooting conditions.
- If the effect of Auto Lighting Optimizer is too strong and results are not at your preferred brightness, set to **[Low]** or **[Disable]**.
- If a setting other than **[Disable]** is set and you use exposure compensation or flash exposure compensation to darken the exposure, the image may still come out bright. If you want a darker exposure, set this function to **[Disable]**.
- Maximum burst is lower with **[High]**. Image recording to the card also takes longer.



- In step 2, if you press the <INFO> button and remove the checkmark [✓] for **[Disable during man expo]** setting, **[Auto Lighting Optimizer]** can also be set even in **[M]** mode.

Highlight Tone Priority



You can reduce overexposed, clipped highlights.

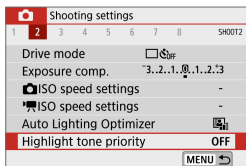

1 Select [: Highlight tone priority].

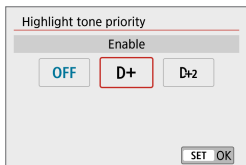

2 Set an option.

- **[Enable]**: Improves gradation in highlights. The gradation between the grays and highlights becomes smoother.
- **[Enhanced]**: Reduces overexposed highlights even more than **[Enable]**, under some shooting conditions.



- Noise may increase slightly.
- The available ISO range starts at ISO 200. Expanded ISO speeds cannot be set.
- **[Enhanced]** is not available when recording movies.
- With **[Enhanced]**, results in some scenes may not look as expected.

Metering Mode

You can select one of four methods to measure the subject brightness. Evaluative metering is set automatically in [A+], [A], Special scene, and Creative filters modes (except [A]).

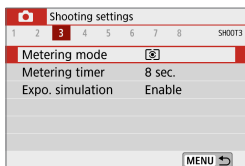

1 Select [CAMERA]: Metering mode].

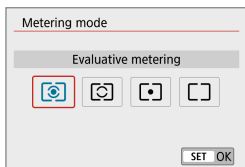

2 Set the metering mode.

- [CAMERA] **Evaluative metering**

General-purpose metering mode suited even for backlit subjects. The camera adjusts the exposure automatically to suit the scene.

- [CAMERA] **Partial metering**

Effective where there are much brighter lights around the subject due to backlight, etc. Covers approx. 5.8% of the area at the center of the screen. The partial metering area is indicated on the screen.

- [CAMERA] **Spot metering**

Effective when metering a specific part of the subject or scene. Covers approx. 2.9% of the area at the center of the screen. The spot metering area is indicated on the screen.

- [CAMERA] **Center-weighted average metering**

The metering across the screen is averaged, with the center of the screen weighted more heavily.



- By default, the camera will set the exposure as follows. With [⊕], holding down the shutter button halfway will lock the exposure setting (AE lock) after focus is achieved with One-Shot AF. In the [☉], [⊖], and [□] modes, the exposure is set at the moment the picture is taken. (Pressing the shutter button halfway does not lock the exposure.)



Metering Timer

You can set how long the metering timer runs (which determines the duration of exposure display) after it is triggered by an action such as pressing the shutter button halfway.

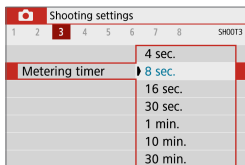

1 Select [: Metering timer].

2 Set a time option.

Exposure Simulation



Exposure simulation simulates and displays how the brightness (exposure) of the actual image will look.

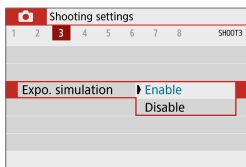

1 Select [: Expo. simulation].

2 Set an option.

- **Enable ()**

The displayed image brightness will be close to the actual brightness (exposure) of the resulting image. If you set exposure compensation, the image brightness will change accordingly.

- **Disable ()**

The image is displayed at standard brightness, so it is easy to see. Even if you set exposure compensation, the image is displayed at the standard brightness.



White Balance

White balance (WB) is for making the white areas look white. Normally, the Auto [**AWB**] (Ambience priority) or [**AWB w**] (White priority) setting will obtain the correct white balance. If natural-looking colors cannot be obtained with Auto, you can select the white balance to match the light source or set it manually by shooting a white object.

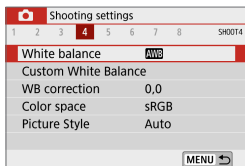

1 Select [: White balance].

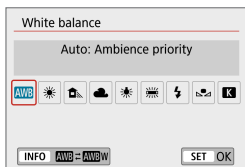

2 Select an item.

(Approx.)

Display	Mode	Color Temperature (K: Kelvin)
	Auto (Ambience priority, 149)	3000–7000
	Auto (White priority, 149)	
	Daylight	5200
	Shade	7000
	Cloudy, twilight, sunset	6000
	Tungsten light	3200
	White fluorescent light	4000
	Flash	Automatically set*
	Custom (150)	2000–10000
	Color temperature (151)	2500–10000

* Applicable with Speedlites having a color temperature transmission function. Otherwise, it will be fixed to approx. 6000K.

White Balance

To the human eye, a white object looks white regardless of the type of lighting. With a digital camera, the white for color correction basis is decided depending on the color temperature of the illumination, and then the color is adjusted with software to make the white areas look white. With this function, you can take the pictures with natural color tones.

[AWB] Auto White Balance

With [AWB], you can slightly increase the intensity of the image's warm color cast when shooting a tungsten-light scene. If you select [AWBw], you can reduce the intensity of the image's warm color cast.

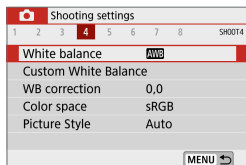

1 Select [: White balance].

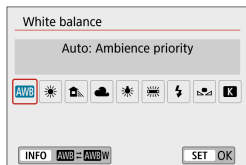

2 Select [AWB].

- With [AWB] selected, press the <INFO> button.

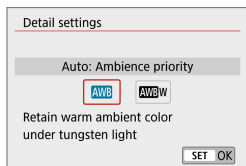

3 Select an item.



Cautions for Setting [AWBw]

- The warm color cast of subjects may fade.
- When multiple light sources are included in the scene, the warm color cast of the picture may not be reduced.
- When using flash, the color tone will be the same as with [AWB].

[] Custom White Balance

With custom white balance, you can manually set the white balance for the specific light source of the shooting location. Make sure to perform this procedure under the light source at the actual location of the shoot.



1 Shoot a white object.

- Aim the camera at a plain white object, so that white fills the screen.
- Focus manually and shoot with the standard exposure set for the white object.
- You can use any of the white balance settings.

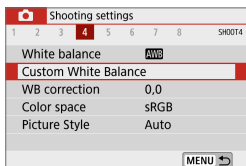

2 Select [: Custom White Balance].



3 Import the white balance data.

- Press the <<> <>> keys to select the image captured in step 1, then press <SET>. Select [**OK**] to import the data.

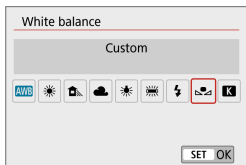

4 Select [: White balance].

5 Select the custom white balance.

- Select [].



- If the exposure obtained in step 1 differs greatly from the standard exposure, a correct white balance may not be obtained.
- These images cannot be selected: Images captured with Picture Style set to **[Monochrome]**, images with a Creative filter applied before or after shooting, cropped images, or images shot with another camera.
- Images that cannot be used in the setting may be displayed.



- Instead of shooting a white object, you can also shoot a gray chart or standard 18% gray reflector (commercially-available).

[K] Color Temperature

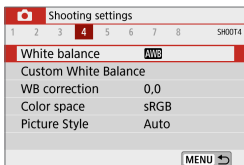

1 Select [: White balance].

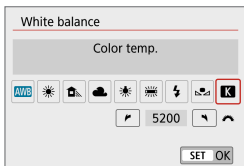

2 Set the color temperature.

- Select [].
- Turn the dial to set the desired color temperature, then press <SET>.
- The color temperature can be set from approx. 2500K to 10000K in 100K increments.



- When setting the color temperature for an artificial light source, set the white balance correction (magenta or green bias) as necessary.
- If you set [] to the reading taken with a commercially available color temperature meter, take test shots and adjust the setting to compensate for the difference between the color temperature meter's reading and the camera's color temperature reading.

White Balance Correction



White balance correction has the same effect as using a commercially available color temperature conversion filter or color compensating filter.

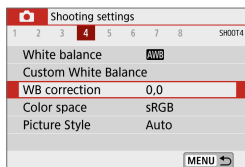

1 Select [: WB correction].

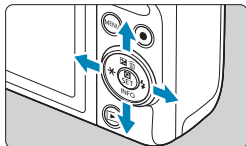

Sample setting: A2, G1

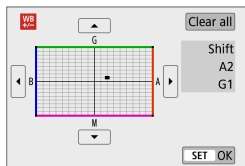

2 Set the white balance correction.

- Press the <⬅➡> cross keys to move the [] mark to your preferred position.
- B is for blue, A for amber, M for magenta, and G for green. The image's color balance will be adjusted toward the color in the direction of the move. On the right of the screen, [**Shift**] indicates the direction and correction amount, respectively.
- To clear all [**WB correction**] settings, tap [**Clear all**].
- Press <SET> to exit the setting.



- One level of the blue/amber correction is equivalent to approx. 5 mireds of a color temperature conversion filter. (Mired: Unit of measure for color temperature used to indicate values such as the density of a color temperature conversion filter.)

Color Space

The range of reproducible colors is called “color space”. For normal shooting, sRGB is recommended.

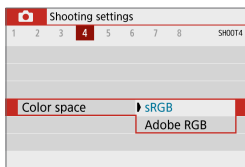

1 Select []: Color space].

2 Set a color space option.

Adobe RGB

This color space is mainly used for commercial printing and other industrial uses. Recommended when using equipment such as Adobe RGB-compatible monitors or DCF 2.0 (Exif 2.21 or later) compatible printers.



- If the still photo is shot in the Adobe RGB color space, the first character in the file name will be an underscore “_”.
- The ICC profile is not appended. For the descriptions about the ICC profile, refer to the Digital Photo Professional Instruction Manual (EOS software).
- [sRGB] is set automatically in [], [], Special scene, and Creative filters modes.

Picture Style Selection



Just by selecting a preset Picture Style, you can obtain image characteristics effectively matching your photographic expression or the subject.

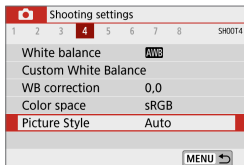

1 Select [: Picture Style].

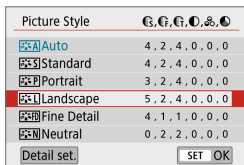

2 Select a Picture Style.

Picture Style Characteristics

● [] Auto

The color tone will be adjusted automatically to suit the scene. The colors will look vivid for blue skies, greenery and sunsets, particularly in nature, outdoor and sunset scenes.

● If the desired color tone is not obtained with [**Auto**], use another Picture Style.

● [] Standard

The image looks vivid, sharp, and crisp. This is a general-purpose Picture Style suitable for most scenes.

● [] Portrait

For nice skin tones. The image looks softer. Suited for close-up portraits. By changing the [**Color tone**] (158), you can adjust the skin tone.

-  **Landscape**

For vivid blues and greens, and very sharp and crisp images. Effective for impressive landscapes.

-  **Fine Detail**

Suited for detailed outline and fine texture description of the subject. The colors will be slightly vivid.

-  **Neutral**

Suited for processing the image with a computer. For natural colors and subdued images with modest brightness and color saturation.

-  **Faithful**

Suited for processing the image with a computer. The color of a subject that is captured in sunlight at a color temperature of 5200K will be adjusted to match the subject's colorimetric color. For subdued images with modest brightness and color saturation.

-  **Monochrome**

Creates black-and-white images.



- Color images cannot be recovered from JPEG images shot with the **[Monochrome]** Picture Style.

-  **User Defined 1–3**

You can register a basic style such as **[Portrait]**, **[Landscape]**, a Picture Style file, etc. and adjust it as desired (📖 160). With any of the User Defined Picture Style that has not yet been set, pictures will be taken with the same characteristics settings as with the default settings of **[Auto]**.

Symbols

The Picture Style selection screen has icons for **[Strength]**, **[Fineness]**, or **[Threshold]** for **[Sharpness]** as well as **[Contrast]** and other settings. The numbers indicate the values for these settings specified for the respective Picture Style.

Picture Style	
Auto	4, 2, 4, 0, 0, 0
Standard	4, 2, 4, 0, 0, 0
Portrait	3, 2, 4, 0, 0, 0
Landscape	5, 2, 4, 0, 0, 0
Fine Detail	4, 1, 1, 0, 0, 0
Neutral	0, 2, 2, 0, 0, 0
Detail set. SET OK	

Picture Style	
Fine Detail	4, 1, 1, 0, 0, 0
Neutral	0, 2, 2, 0, 0, 0
Faithful	0, 2, 2, 0, 0, 0
Monochrome	4, 2, 4, 0, N, N
User Def. 1	Auto
User Def. 2	Auto
Detail set. SET OK	

	Sharpness	
		Strength
		Fineness
		Threshold
	Contrast	
	Saturation	
	Color tone	
	Filter effect (Monochrome)	
	Toning effect (Monochrome)	

- During movie recording, an asterisk "*" will be displayed for both **[Fineness]** and **[Threshold]** for **[Sharpness]**. **[Fineness]** and **[Threshold]** will not be applied to movies.

Picture Style Customization

You can customize any Picture Style by changing it from the default settings. To customize **[Monochrome]**, see  159.

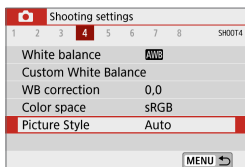

1 Select [: Picture Style].

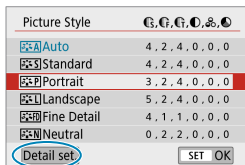

2 Select a Picture Style.

- Select the Picture Style to adjust, then tap **[Detail set.]**.

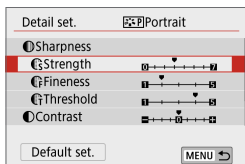

3 Select a setting item.

- See “Settings and Effects” ( 158) for details on the settings and effects.

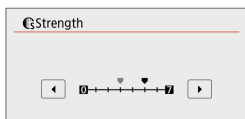





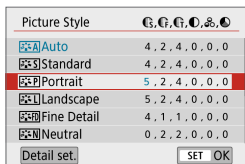

4 Set the effect level.

- Set a value, then press **<SET>**.



- Press the **<MENU>** button to save the adjusted setting and return to the Picture Style selection screen.
- Any settings you change from default values are displayed in blue.

Settings and Effects

	Sharpness		
	 Strength	0: Weak outline emphasis	7: Strong outline emphasis
	 Fineness* ¹	1: Fine	5: Grainy
 Threshold* ²	1: Low	5: High	
	Contrast	-4: Low contrast	+4: High contrast
	Saturation	-4: Low saturation	+4: High saturation
	Color tone	-4: Reddish skin tone	+4: Yellowish skin tone

*1: Indicates the fineness of the outlines to be emphasized. The smaller the number, the finer the outlines that can be emphasized.

*2: Sets how much the outline is emphasized based on the difference in contrast between the subject and the surrounding area. The smaller the number, the more the outline will be emphasized when the contrast difference is low. However, noise tends to be more noticeable when the number is smaller.



- For movie recording, **[Fineness]** and **[Threshold]** for **[Sharpness]** cannot be set (not displayed).
- By selecting **[Default set.]** in step 3, you can revert the parameter settings of the respective Picture Style to their defaults.
- To shoot with the Picture Style you adjusted, first select the adjusted Picture Style, then shoot.

[] Monochrome Adjustment

Besides the effects described on the preceding page such as **[Contrast]**, or **[Strength]**, **[Fineness]** and **[Threshold]** for **[Sharpness]**, you can also set **[Filter effect]** and **[Toning effect]**.

[] Filter effect

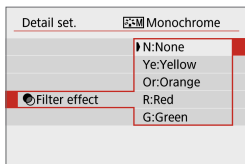

With a filter effect applied to a monochrome image, you can make white clouds or green trees stand out more.

Filter	Sample Effects
N: None	Normal black-and-white image with no filter effects.
Ye: Yellow	The blue sky will look more natural, and the white clouds will look crisper.
Or: Orange	The blue sky will look slightly darker. The sunset will look more brilliant.
R: Red	The blue sky will look quite dark. Fall leaves will look crisper and brighter.
G: Green	Skin tones and lips will appear muted. Green tree leaves will look crisper and brighter.



- Increasing the **[Contrast]** will make the filter effect more pronounced.

[] Toning effect

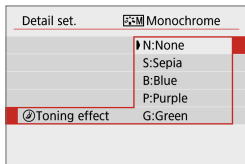

By applying a toning effect, you can create a monochrome image in the selected color. Effective when you want to create more impressive images.

Picture Style Registration



You can select a base Picture Style such as **[Portrait]** or **[Landscape]**, adjust it as desired, and register it under **[User Def. 1]**, **[User Def. 2]**, or **[User Def. 3]**. Useful when creating several Picture Styles with different settings.

Picture Styles that you have registered on the camera using EOS Utility (EOS software) can also be modified here.

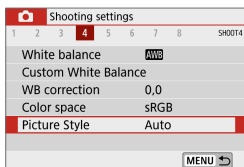

1 Select [📷: Picture Style].

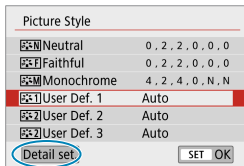

2 Select [User Def.].

- Select **[User Def. *]**, then tap **[Detail set.]**.

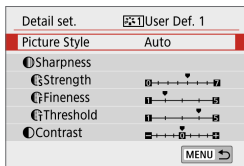

3 Press <SET>.

- With **[Picture Style]** selected, press **<SET>**.

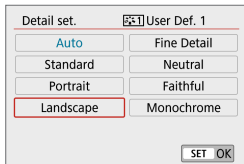

4 Select the base Picture Style.

- Select the base Picture Style.
- Also select styles this way when adjusting styles registered to the camera with EOS Utility (EOS software).

5 Select an item.

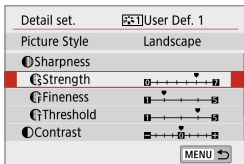

6 Set the effect level.

- For details, see “Picture Style Customization” (📖 157).

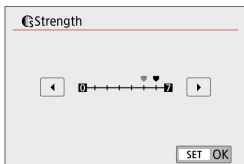

- Press the <MENU> button to save the adjusted setting and return to the Picture Style selection screen.

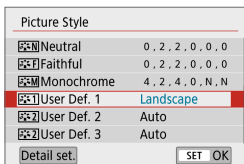

The base Picture Style will be indicated on the right of **[User Def. *]**. Blue style names indicate that you have changed the settings from default values.



- If a Picture Style is already registered under **[User Def. *]**, changing the base Picture Style will clear the parameter settings of the previously registered User Defined Picture Style.
- Selecting **[Basic settings]** in **[🔧: Reset camera]** (📖 453) will restore all **[User Def. *]** settings to defaults.



- To shoot with a registered Picture Style, select the registered **[User Def. *]**, then shoot.
- Regarding the procedure to register a Picture Style file to the camera, refer to the EOS Utility Instruction Manual.

Long Exposure Noise Reduction



For images exposed for 1 sec. or longer, noise (dots of light and banding) typical of long exposures can be reduced.

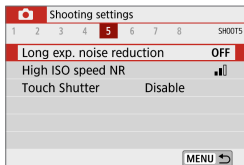

1 Select [: Long exp. noise reduction].

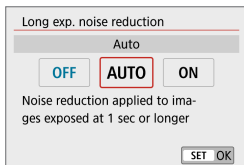

2 Set a reduction option.

● [AUTO] Auto

For exposures of 1 sec. or longer, noise reduction is performed automatically if noise typical of long exposures is detected. This **[Auto]** setting is effective enough in most cases.

● [ON] Enable

Noise reduction is performed for all exposures of 1 sec. or longer. The **[Enable]** setting may reduce noise that cannot be detected with the **[Auto]** setting.



- With **[Auto]** or **[Enable]** set, the noise reduction process after the picture is taken may take the same amount of time as that for the exposure.
- Images may look grainier with the **[Enable]** setting than with the **[Disable]** or **[Auto]** setting.
- **[BUSY]** is displayed as noise is reduced, and the shooting screen is not displayed until processing is finished, when you can shoot again.



High ISO Speed Noise Reduction

This function reduces the noise generated in the image. This function is especially effective when shooting at high ISO speeds. When shooting at low ISO speeds, the noise in the darker parts of the image (shadow areas) can further be reduced.

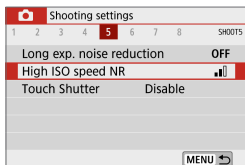

1 Select [: High ISO speed NR].

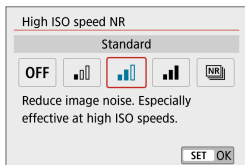

2 Set the level.

● [] Multi Shot Noise Reduction

Applies the noise reduction with higher image quality than **[High]**.

For a single photo, four shots are taken continuously and aligned and merged automatically into a single JPEG image.

If the image quality is set to RAW or RAW+JPEG, you cannot set **[Multi Shot Noise Reduction]**.



Cautions for Setting Multi Shot Noise Reduction

- If there is significant misalignment in the image due to camera shake, the noise reduction effect may become smaller.
- If you are handholding the camera, keep it steady to prevent camera shake. Using a tripod is recommended.
- If you shoot a moving subject, the moving subject may leave afterimages.
- Auto image alignment may not function properly with repetitive patterns (lattice, stripes, etc.) or flat, single-tone images.
- If the subject's brightness changes as the four consecutive shots are taken, irregular exposure in the image may result.
- After shooting, it may take some time to record an image to the card after performing noise reduction and merging the images. **[BUSY]** is displayed as images are processed, and shooting is not possible until processing is finished.
- **[Multi Shot Noise Reduction]** is not available with bulb shooting, shooting RAW or RAW+JPEG images, or with features such as long exposure noise reduction or Creative filters.
- Flash photography is not possible.
- **[Multi Shot Noise Reduction]** is not available (not displayed) when recording movies.
- The camera automatically switches to **[Standard]** if you turn it off, replace the battery or card, switch to **[A+]**, **[Sf]**, Special scene, or Creative filters mode, or switch to movie recording.

Touch Shutter

Just by tapping on the screen, you can focus and take the picture automatically.

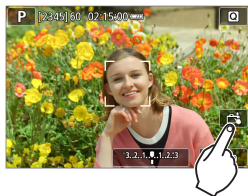

1 Enable the Touch Shutter.

- Tap **[OFF]** on the screen's bottom right.
- Each time you tap on the icon, it will toggle between **[OFF]** and **[ON]**.
- **[ON]** (Touch Shutter: Enable)
The camera will focus on the spot you tap on, then the picture will be taken.
- **[OFF]** (Touch Shutter: Disable)
You can tap on a spot to perform focusing on the spot. Press the shutter button completely to take the picture.



2 Tap on the screen to shoot.

- Tap on the face or subject on the screen.
- On the point you tap, the camera will focus (Touch AF) with the AF method that was set (170).
- When **[ON]** is set, the AF point turns green when focus is achieved, then the picture is taken automatically.
- If focus is not achieved, the AF point turns orange and the picture cannot be taken. Tap on the face or subject on the screen again.



- Even if you set the drive mode to [📷], the camera will still shoot in the single shooting mode.
- Even if [AF operation] is set to [Servo AF], tapping on the screen will focus on the image with [One-Shot AF].
- Tapping on the screen in magnified view will not focus or take the picture.
- If you shoot by tapping on the screen with [📷: Image review] set to [Hold], you can press the shutter button halfway to take the next shot.



- To shoot with bulb exposure, tap on the screen twice. The first tap on the screen will start the bulb exposure. Tapping it again will stop the bulb exposure. Be careful not to shake the camera when tapping on the screen.

AF Operation

You can select the AF operation characteristics to suit the shooting conditions or subject.

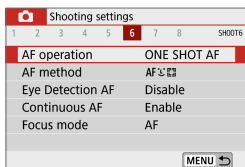

1 Select [: AF operation].

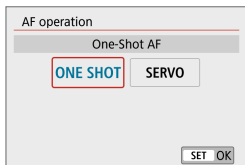

2 Select a setting item.



- If focus cannot be achieved, the AF point will turn orange. If this occurs, the picture cannot be taken even if the shutter button is pressed completely. Repcompose the shot and try to focus again. Or, see “Shooting Conditions that Make Focusing Difficult” (📖 179).

One-Shot AF for Still Subjects (ONE SHOT)

This AF operation is suited for still subjects. When you press the shutter button halfway, the camera will focus only once.

- When focus is achieved, the AF point will turn green and the beeper will sound.
- The focus remains locked while you hold down the shutter button halfway, allowing you to recompose the image before taking the picture.
- For details on the continuous shooting speed for continuous shooting, see  133.



- If [: **Beep**] is set to [**Disable**], the beeper will not sound when focus is achieved.

Servo AF for Moving Subjects (SERVO)

This AF operation is suited for moving subjects. While you hold down the shutter button halfway, the camera will keep focusing on the subject continuously.

- When focus is achieved, the AF point will turn blue.
- The exposure is set at the moment the picture is taken.
- For details on the continuous shooting speed for continuous shooting, see  133.



- Depending on the lens used, the distance to the subject and the subject's speed, the camera may not be able to achieve correct focus.
- Zooming during continuous shooting may throw off the focus. Zoom first, then recompose and shoot.



- The beeper will not sound even when focus is achieved.

AF-Assist Beam

The AF-assist beam (📖 36) may fire when you press the shutter button halfway under low light or in similar conditions, to make autofocusing easier.



- The AF-assist beam does not fire when [**📷: AF operation**] is set to [**Servo AF**].
- The AF-assist beam does not fire when Touch AF is used (when [**📷: Touch Shutter**] is set to [**Disable**]).

AF Method

You can select the AF method to suit the shooting conditions or subject. The camera attempts to focus on faces of any people in an AF point or Zone AF frame. In [A+], [AF] or [AF] mode, [Face+Tracking] is set automatically. For instructions on selecting an AF method, see 172.

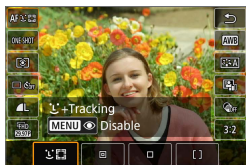

Face+Tracking

The camera detects and focuses on people's faces. [Face+Tracking] (an AF point) appears over any face detected, which is then tracked.

If no face is detected, the entire AF area is used for auto selection AF. With Servo AF, focusing continues as long as subjects can be tracked within the Area AF frame as you shoot.

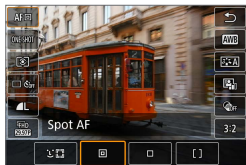

Spot AF

The camera focuses in a narrower area than 1-point AF.

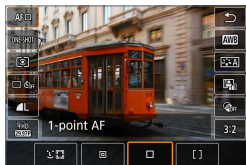

1-point AF

The camera focuses using a single AF point [1-point AF].

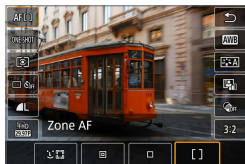

[] : Zone AF

Uses auto selection AF in Zone AF frames to cover a large area, which makes focusing easier than with 1-point AF.

Prioritizes focusing on the nearest subject. Faces of any people in the Zone AF frame are also given priority in focusing. AF points in focus are displayed with [□].

Selecting the AF Method



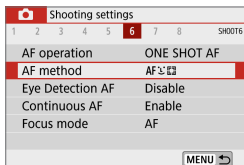

You can select the AF method to suit the shooting conditions or subject. If you prefer to focus manually, see  185.



1 Select [: AF method].

2 Select a setting item.



- The descriptions on  173– 175 assume that the AF operation is set to **[One-Shot AF]** ( 168). With **[Servo AF]** ( 168) set, the AF point will turn blue when focus is achieved.
- Regarding the Touch Shutter (AF and shutter release by touch operation), see  165.

● **☺ (face)+Tracking:** ☺

The camera detects and focuses on human faces. If a face moves, the AF point [] also moves to track the face.



1 Check the AF point.

- [] (an AF point) appears over any face detected.

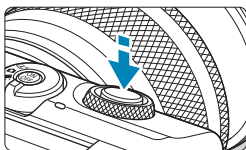

2 Focus on the subject.

- Once you press the shutter button halfway and the subject is in focus, the AF point turns green and the camera beeps.
- An orange AF point indicates that the camera could not focus on subjects.







3 Take the picture.

Tapping a Face for Focus

Tapping a face or subject to focus on changes the AF point to  and focuses where you tap.

Even if the face or subject moves on the screen, the AF point  moves to track it.

-  If the subject's face is significantly out of focus, face detection will not be possible. Adjust the focus manually ( 185) so that the face can be detected, then perform AF.
- An object other than a human face may be detected as a face.
- Face detection will not work if the face is very small or large in the picture, too bright or too dark, or partially hidden.
- AF cannot detect subjects or people's faces at the edges of the screen. Recompose the shot to center the subject or bring the subject closer to the center.

-  The  may cover only a part of the face, not the whole face.
- The size of the AF point changes depending on the subject.

● Spot AF/1-point AF/Zone AF

You can manually set the AF point or Zone AF frame. Here, 1-point AF screens are used as an example.



(1)

1 Check the AF point.

- The AF point (1) will appear.
With Zone AF, the Zone AF frame is displayed.



2 Move the AF point.

- To move the AF point, tap where you want to focus.
- To return the AF point or Zone AF frame to the center of the screen, tap [].
- For magnified display, tap []. Each tap of [] changes the magnification ratio.

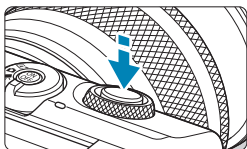

3 Focus on the subject.

- Aim the AF point over the subject and press the shutter button halfway.
When focus is achieved, the AF point will turn green and the beeper will sound.
If focus is not achieved, the AF point will turn orange.



4 Take the picture.

- The camera will keep moving the active AF point [□] to track subjects for Zone AF when Servo AF operation is used, but under some shooting conditions (such as when subjects are small), it may not be possible to track the subject.
- Focusing with an AF-assist beam may be difficult with AF points near the edge of the screen. In this case, move to an AF point in the center of the screen.

Magnified View

You can check the focus by tapping [Q] to magnify display by approx. 5× or 10×. Magnified view is not possible with [⌂+Tracking].

- Magnification is centered on the AF point for **[Spot AF]** or **[1-point AF]** and on the Zone AF frame for **[Zone AF]**.
- Autofocusing is performed with magnified display if you press the shutter button halfway when set to **[Spot AF]** and **[1-point AF]**. When set to **[Zone AF]**, autofocusing is performed after restoring normal display.
- With Servo AF, if you press the shutter button halfway in the magnified view, the camera will return to the normal view for focusing.



- If focusing is difficult in the magnified view, return to the normal view and perform AF.
- If you perform AF in the normal view and then use the magnified view, accurate focus may not be achieved.
- AF speed differs between the normal view and magnified view.
- Continuous AF and Movie Servo AF are not available when display is magnified.
- With the magnified view, achieving focus becomes more difficult due to camera shake. Using a tripod is recommended.

AF Shooting Tips

- Even when focus is achieved, pressing the shutter button halfway will focus again.
- Image brightness may change during autofocusing.
- Depending on the subject and shooting conditions, it may take longer to focus, or the continuous shooting speed may decrease.
- If the light source changes as you shoot, the screen may flicker, and focusing may be difficult. In this case, restart the camera and resume shooting with AF under the light source you will use.
- If focusing is not possible with AF, focus manually ( 185).
- For subjects at the edge of the screen that are slightly out of focus, try centering the subject (or AF point, or Zone AF frame) to bring them into focus, then recompose the shot before shooting.
- With certain lenses, it may take more time to achieve focus with autofocus, or accurate focusing may not be achieved.

Shooting Conditions that Make Focusing Difficult

- Subject with low-contrast such as the blue sky, solid-color flat surfaces or when highlight or shadow details are clipped.
- Subjects in low light.
- Stripes and other patterns where there is contrast only in the horizontal direction.
- Subjects with repetitive patterns (Example: Skyscraper windows, computer keyboards, etc.).
- Fine lines and subject outlines.
- Under a light source whose brightness, color, or pattern keeps changing.
- Night scenes or points of light.
- The image flickers under fluorescent or LED lighting.
- Extremely small subjects.
- Subjects at the edge of the screen.
- Strongly backlit or reflective subjects (Example: Car with a highly reflective body, etc.).
- Near and distant subjects covered by an AF point (Example: Animal in a cage, etc.).
- Subjects that keep moving within the AF point and will not stay still due to camera shake or subject blur.
- Performing AF when the subject is very far out of focus.
- Soft focus effect is applied with a soft focus lens.
- A special effect filter is used.
- Noise (dots of light, banding, etc.) appears on the screen during AF.

AF Range

The available autofocus range varies depending on the lens used and settings such as aspect ratio, movie recording quality, and Movie digital IS.

Eye Detection AF

With the AF method set to [**L**+Tracking], the camera can focus on people's eyes.

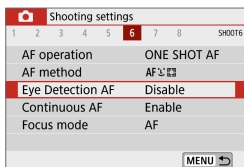

1 Select [**L**: Eye Detection AF].

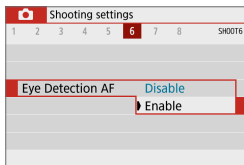

2 Select [Enable].

3 Aim the camera at the subject.

- An AF point is displayed around their eye.
- You can tap the screen to select an eye for focus.
- The entire face is selected when you tap other facial features, such as their nose or mouth. Eyes to focus on are selected automatically.

4 Take the picture.

! • Subject eyes may not be detected correctly, depending on the subject and shooting conditions.

☰ • [Eye Detection AF] can be set by pressing the <MENU> button when you have set [AF method] to [**L**+Tracking] on the Quick Control screen after pressing <SET>.

Continuous AF

This function keeps subjects generally in focus. The camera is ready to focus immediately when you press the shutter button halfway.

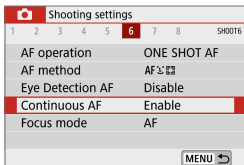

1 Select [: Continuous AF].

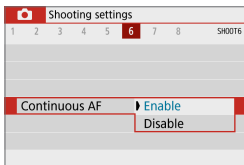

2 Select [Enable].



- Enabling this function reduces the number of shots available, because the lens is driven continuously and battery power is consumed.

Focus Mode

You can specify the method of focusing (focus mode) when using EF-M lenses.

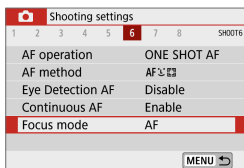

1 Select []: Focus mode].

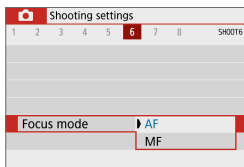

2 Select a setting item.

- [AF]: Autofocus
- [MF]: Manual focus

Manually Focusing with a Lens after AF ☆

For EF-M, EF, or EF-S lenses equipped with electronic manual focusing, you can specify how manual focus adjustment is used with One-Shot AF.

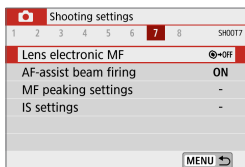

1 Select [: Lens electronic MF].

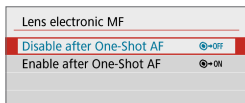

2 Select an item.

- **[→OFF] Disable after One-Shot AF**

Manual focus adjustment after the AF operation is disabled.

- **[→ON] Enable after One-Shot AF**

You can manually adjust the focus after the AF operation if you keep holding down the shutter button halfway.



- For details on your lens's manual focus specifications, refer to the lens instruction manual.

AF-Assist Beam Firing

You can enable firing of the camera's AF-assist beam.

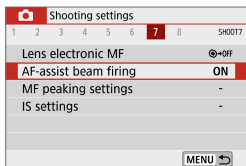

1 Select [: AF-assist beam firing].

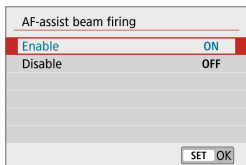

2 Select an item.

- **[ON] Enable**
Enables firing of the AF-assist beam, when needed.
- **[OFF] Disable**
Disables firing of the AF-assist beam. Set if you prefer not to fire the AF-assist beam.

Manual Focus

If focusing is not possible with autofocus, you can magnify the image and focus manually.

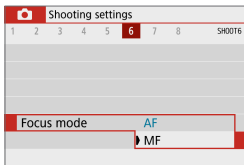

1 Set [CAMERA]: Focus mode] to [MF].

- Turn the lens focusing ring to focus roughly.



2 Magnify the image.

- Each tap of [Q] changes the screen, as follows.

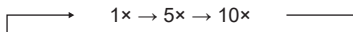

- (1) AE lock
- (2) Magnified area position
- (3) Magnification (approx.)



(1) (2) (3)

3 Determine an area to magnify.

- You can move the magnified area by scrolling with your finger after you tap.
- To center the magnified area, tap [CAMERA].

4 Focus manually.

- While looking at the magnified image, turn the lens focusing ring to focus.
- After achieving focus, tap [Q] to return to the normal view.

5 Take the picture.



- When using non EF-M lenses, set the lens's focus mode switch to <MF> in step 1.
- Even with manual focusing, you can use the Touch Shutter to take a picture.

Setting MF Peaking

Edges of subjects in focus can be displayed in color as you focus manually to make it easier to focus. You can set the outline color and adjust the sensitivity (level) of edge detection.

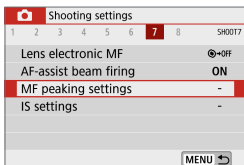

1 Select [: MF peaking settings].

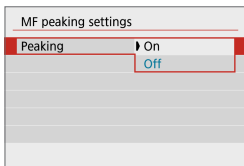

2 Select [Peaking].

- Select [On].

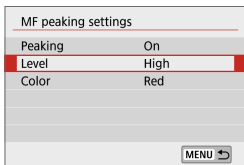

3 Set the level and color.

- Set it as necessary.



- Peaking display is not shown during magnified display.
- MF peaking may be hard to discern at high ISO speeds, especially when expanded ISO speed is set. If necessary, lower the ISO speed or set [Peaking] to [Off].



- Peaking display shown on the screen is not recorded in images.

Image Stabilization

You can adjust the Image Stabilizer (IS) setting when using IS-equipped EF-M lenses. For details on [📷 Digital IS], see 📖 233.

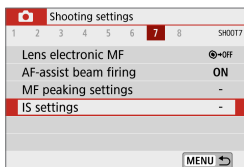

1 Select [📷: IS settings].

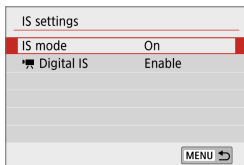

2 Select [IS mode].

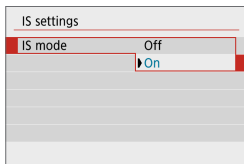

3 Set an option.

- [Off]
Deactivates image stabilization.
- [On]
Camera shake will be corrected.

- ❗ [IS mode] is not displayed for IS-equipped EF or EF-S lenses.
- If image stabilization cannot prevent camera shake, mount the camera on a tripod or take other measures to hold it still. Additionally, you should set [IS mode] to [Off] when using a tripod or other means to secure the camera.

Exposure Lock (AE Lock)

You can lock the exposure when you want to set the focus and exposure separately or when you are to take multiple shots at the same exposure setting. Press the **< * >** button to lock the exposure, then recompose and take the picture. It is effective for shooting backlit subjects, etc.

1 Focus on the subject.

- Press the shutter button halfway.

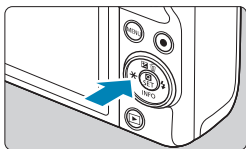

2 Press the **< * >** button.

- A [*****] icon is displayed in the lower left of the screen to indicate that exposure is locked (AE lock).
- To cancel AE Lock, press the **< * >** button again.

3 Recompose and take the picture.



AE Lock Effects

Metering Mode	AF Point Selection Method	
	Automatic Selection	Manual Selection
	Exposure centered on the AF point in focus is locked.	Exposure centered on the selected AF point is locked.
	Exposure at the center of the screen is locked.	

* When set to [] with [**Focus mode**] set to [**MF**], exposure at the center of the screen is locked.



- AE lock is not available in bulb exposure.

Type of Digest Movie

Both still photos and clips are captured when you shoot in [A/S] mode, but you can specify whether to include the still photos in the resulting digest movie.

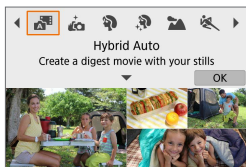

1 Set the shooting mode to [A/S].

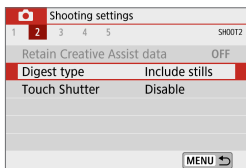

2 Select [📷: Digest type].

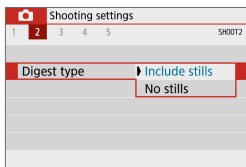

3 Set an option.

- **[Include stills]**
Digest movies include still photos.
- **[No stills]**
Digest movies do not include still photos.

Remote Control Shooting

You can shoot remotely by using an optional Wireless Remote Control BR-E1, which pairs via Bluetooth.

Wireless Remote Control BR-E1

You can shoot remotely up to approx. 5 meters/16.4 feet away from the camera.

After pairing the camera and BR-E1 ( 387), set the drive mode to  ( 134).

For operation procedures, refer to the BR-E1 instruction manual.



- Auto power off time may be extended when the camera is set for remote control shooting.
- The remote control can also be used for movie recording ( 235).

General Still Photo Shooting Cautions

- Do not point the camera toward an intense light source, such as the sun or an intense artificial light source. Doing so may damage the image sensor or the camera's internal components.

Image Quality

- When you shoot at high ISO speeds, noise (such as dots of light and banding) may become noticeable.
- Shooting in high temperatures may cause noise and irregular colors in the image.
- Frequent shooting over an extended period may cause the camera's internal temperature to rise and affect image quality. When you are not shooting, always turn off the camera.
- If you shoot a long exposure while the camera's internal temperature is high, image quality may decline. Stop shooting and wait a few minutes before shooting again.

White [🔥] and Red [🔥] Internal Temperature Warning Icons

- If the camera's internal temperature rises from extended shooting or use in hot environments, a white [🔥] or red [🔥] icon will appear.
- The white [🔥] icon indicates that the image quality of still photos will decline. Stop shooting for a while and allow the camera to cool down.
- The red [🔥] icon indicates that shooting will soon end automatically. Shooting will not be possible again until the camera cools down internally, so stop shooting temporarily or turn off the camera and let it cool down a while.
- Shooting in hot environments over extended periods will cause the white [🔥] or red [🔥] icon to appear sooner. When you are not shooting, always turn off the camera.
- If the camera's internal temperature is high, the quality of images shot with a high ISO speed or long exposure may decline even before the white [🔥] icon is displayed.

Shooting Results

- In magnified view, the shutter speed and aperture value will be displayed in orange. If you take the picture in magnified view, the exposure may not come out as desired. Return to the normal view before taking the picture.
- Even if you take the picture in magnified view, the image will be captured with the image area of the normal view.



Images and Display

- Under low- or bright-light conditions, the displayed image may not reflect the brightness of the captured image.
- Under low light, noise may be noticeable in image display even at low ISO speeds, but there will be less noise in your shots, because image quality varies between display and captured images.
- The screen or exposure value may flicker if the light source (lighting) changes. In this case, stop shooting temporarily and resume under the light source you will use.
- Pointing the camera at different direction may momentarily prevent correct display of brightness. Wait until the brightness level stabilizes before shooting.
- If there is a very bright light source in the image, the bright area may appear black on the screen. However, the actual captured image will correctly show the bright area.
- In low light, if you set the [**f**: **Disp. brightness**] to a bright setting, noise or irregular colors may appear in the image. However, the noise or irregular colors will not be recorded in the captured image.
- When you magnify the image, the image sharpness may look more pronounced than in the actual image.

Lens

- Image Stabilizer is active all times, even without the shutter button pressed halfway, when you use an IS-equipped EF-M lens with [**IS mode**] in [**☑**: **IS settings**] set to [**On**]. The Image Stabilizer consumes battery power and may decrease the number of possible shots depending on the shooting conditions. Setting [**IS mode**] to [**Off**] is recommended when you are using a tripod or other means to secure the camera.
- With EF lenses, focus preset during shooting is only available when using (super) telephoto lenses equipped with this function released in and after the second half of 2011.



- With an optional HDMI cable (camera end: Type D), you can display images on a television (270). Note that no sound will be output.

Information Display

For details on the icons displayed for still photo shooting, see  501.



- When **[Exp.SIM]** is displayed in white, it indicates that the image is displayed at the brightness level closely matching that of the actual image to be captured.
- If **[Exp.SIM]** is blinking, it indicates that the image is displayed at a brightness that differs from the actual shooting result because of low- or bright-light conditions. However, the actual image recorded will reflect the exposure setting. Note that the noise may be more noticeable than the actual image recorded.
- Exposure simulation may not be performed under some shooting settings. The **[Exp.SIM]** icon and histogram will be displayed in gray. The image will be displayed on the screen at the standard brightness. The histogram may not be properly displayed in low- or bright-light conditions.
- The histogram can be displayed when **[CAM: Expo. simulation]** is set to **[Enable]** ( 146).

Movie Recording



For movie recording, set the shooting mode switch to <[Movie camera icon]>.



- You can record movies by pressing the movie shooting button during still photo shooting.
- You can specify movie recording mode in [**☑**: **Shooting mode**] after setting the shooting mode switch to <[Movie camera icon]>.

Tab Menus: Movie Recording

● Shooting settings 1

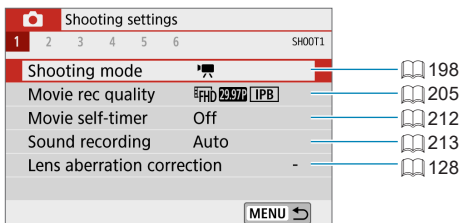

● Shooting settings 2

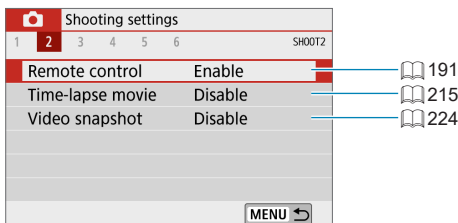

● Shooting settings 3

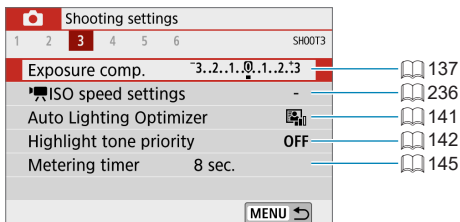

● Shooting settings 4

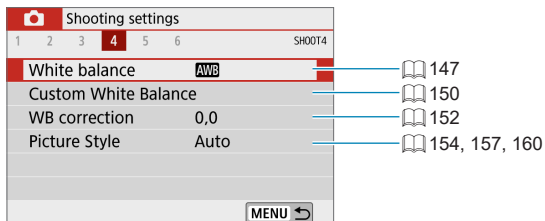

● Shooting settings 5

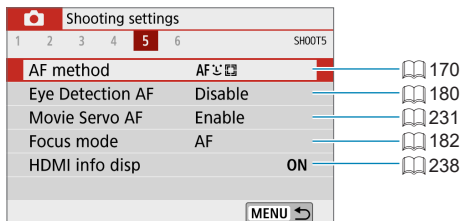

● Shooting settings 6

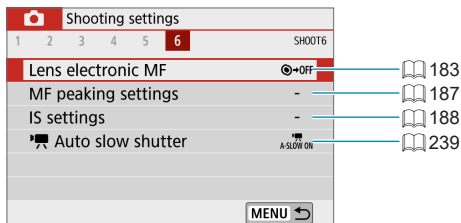

Movie Mode

[] Autoexposure Recording

Autoexposure control will take effect to suit the scene's current brightness.





1 Set the shooting mode switch to </>.

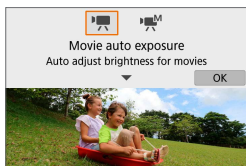

2 Tap the shooting mode icon.





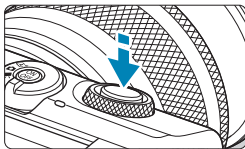

3 Set the shooting mode to [].

- Select [] (Movie auto exposure), then press <SET>.



4 Focus on the subject.

- Before recording a movie, focus with AF or manual focus ( 172– 179,  185).
- By default, [: **Movie Servo AF**] is set to [**Enable**] so that the camera always keeps focusing ( 231).
- When you press the shutter button halfway, the camera will focus with the current AF method.

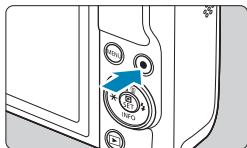

5 Record the movie.

- Press the movie shooting button to start recording a movie.
- While the movie is being recorded, the [●REC] mark (1) will be displayed on the upper right of the screen.
- Sound is recorded by the microphones at the positions indicated (2).
- To stop recording the movie, press the movie shooting button again.

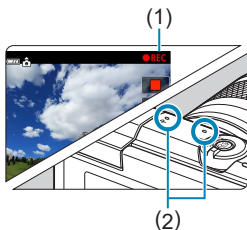

- You can lock the exposure (AE lock) by pressing the <★> button. To cancel, press the <★> button again. (Retained until the <★> button is pressed again.)
- Exposure compensation can be set in a range of up to ± 3 stops.
- ISO speed, shutter speed, and aperture value are not recorded in movie Exif information.

ISO Speed in [P] Mode

ISO speed is set automatically. For details on the ISO speed, see 499.

[M] Manual Exposure Recording

You can manually set the shutter speed, aperture, and ISO speed for movie recording.



1 Set the shooting mode switch to <[M]>.

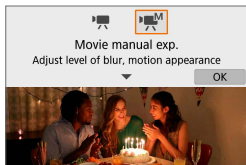

2 Set the shooting mode to [M].

- Select [M] (Movie manual exposure), then press <SET>.



3 Set the ISO speed (100).

- Tap the ISO speed icon.
- With ISO Auto, you can set exposure compensation (111).

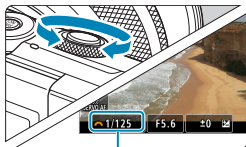

(1)

4 Set the desired shutter speed.

- Turn the <[DIAL]> dial to set it.
- Shutter speed can be set in a range of 1/4000–1/8 sec.

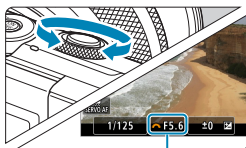

(2)

5 Set the aperture value.

- Press the <[KEY]> key to select the aperture value, then turn the <[DIAL]> dial to set a value.

6 Focus and record the movie.

- The procedure is the same as steps 4 and 5 for “[M] Autoexposure Recording” (198).



- Double-check camera settings before recording movies if you change the shooting mode switch from <A+> or <A> to <M>.
- During movie recording, avoid changing the shutter speed or aperture. Doing so may record the changes in the exposure or create more noise at high ISO speeds.
- When recording a movie of a moving subject, a shutter speed of approx. 1/25 sec. to 1/125 sec. is recommended. The faster the shutter speed, the less smooth the subject's movement will look.
- If you change the shutter speed while recording under fluorescent or LED lighting, image flicker may be recorded.



- With ISO Auto, exposure compensation can be set in a range of ± 3 stops.
- When ISO Auto is set, you can press the <M> button to lock the ISO speed. To cancel, press the <M> button again. (Retained until the <M> button is pressed again.)
- If you press the <M> button and recompose the shot, you can see the exposure level difference on the exposure level indicator compared to when the <M> button was pressed.
- With the camera ready to shoot in the [M] mode, you can display the histogram by pressing the <INFO> button.

ISO Speed for [Movie manual exp.]

You can set the ISO speed manually or select **[AUTO]** to set it automatically. For details on the ISO speed, see  499.

Still Photo Shooting

Still photos cannot be taken in movie modes. To shoot still photos, set the shooting mode switch to **<A+>** or **<A>**.

Information Display (Movie Recording)

For details on the icons displayed for movie recording, see  503.



Cautions for Movie Recording

- Do not point the camera toward an intense light source, such as the sun or an intense artificial light source. Doing so may damage the image sensor or the camera's internal components.
- If you shoot something that has fine detail, moire or false colors may result.
- If [**AWB**] or [**AWB w**] is set and the ISO speed or aperture changes during movie recording, the white balance may also change.
- If you record a movie under fluorescent or LED lighting, the movie image may flicker.
- If you perform AF with a USM lens during movie recording in low light, horizontal banding noise may be recorded in the movie. The same type of noise may occur if you focus manually with certain lenses equipped with an electronic focusing ring.
- Recording a few test movies is recommended if you intend to perform zooming during movie recording. Zooming as you record movies may cause exposure changes or lens sounds to be recorded, an uneven audio level, or loss of focus.
- Large aperture values may delay or prevent accurate focusing.
- During movie recording, if you perform AF, any of the following may occur: The focus is temporarily greatly thrown off, changes in movie brightness is recorded, the movie recording stops momentarily, and the mechanical sound of the lens is recorded.
- Avoid covering the built-in microphones (📖 199) with your fingers or other objects.
- The date/time/zone must be set to enable normal camera temperature control. Once the date/time/zone are set, temperature warnings can be displayed correctly.
- If [**Overheated! Shutting down.**] is displayed, turn off the camera and wait at least 3 min. Note that the camera should be off for 9 min. or more if you will record a 4K movie up to 9 min. 59 sec. or a high frame rate movie up to 7 min. 29 sec. (Actual movie recording times may be shorter, depending on the recording environment and conditions of use.)
- "General Movie Recording Cautions" are on 📖 240–📖 241.
- If necessary, also read "General Still Photo Shooting Cautions" on 📖 192–📖 193.



Notes for Movie Recording

- Each time you record a movie, a new movie file is created on the card.
- The movie's field of view coverage for recording 4K, Full HD, and HD movies is approx. 100%.
- To enable starting or stopping movie recording by pressing the shutter button completely, set **[Fully-press]** for **[☑: Shutter btn function for movies]** to **[Start/stop mov rec]**.
- Stereo sound is recorded by the camera's built-in microphone (📖 199).
- With EF lenses, focus preset during shooting is only available when using (super) telephoto lenses equipped with this function released in and after the second half of 2011.
- YCbCr 4:2:0 (8-bit) color sampling and the Rec. ITU-R BT.709 color space are used for 4K, Full HD, and HD movies.

Movie Recording Quality

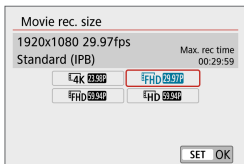

On the [**📷**: **Movie rec quality**] tab, select [**Movie rec. size**] to set the image size, frame rate, and compression method. The movie will be recorded as an MP4 file. The frame rate displayed on the [**Movie rec. size**] screen switches automatically depending on the [**📷**: **Video system**] setting (📖 443).

- The card's writing and reading speeds required for recording movies (card performance requirements) vary depending on the movie recording size. Before recording movies, see 📖 497 to check the performance requirements of the card.

Image Size

- [**4K**] **3840×2160**

The movie is recorded in 4K quality. The aspect ratio is 16:9. Not available unless the shooting mode switch is set to <📷>.

- [**FHD**] **1920×1080**

The movie is recorded in Full High-Definition (Full HD) quality. The aspect ratio is 16:9.

- [**HD**] **1280×720**

The movie is recorded in High-Definition (HD) quality. The aspect ratio is 16:9.

- If you change the [**📷**: **Video system**] setting, also set [**📷**: **Movie rec. size**] again.
- Normal playback of 4K and **FHD 59.94P / 50.00P** movies may not be possible on other devices, because playback is processing-intensive.
- Clarity and noise vary slightly depending on movie recording size, the lens used, and other settings.

- Movies cannot be recorded in VGA quality.

4K Movie Recording

- Recording 4K movies requires a high-performance card. For details, see “Cards that Can Record Movies” (📖 497).
 - The maximum recording time per 4K movie is 9 min. 59 sec. (📖 211).
 - Recording 4K movies greatly increases the processing load, which may cause the camera's internal temperature to increase faster or become higher than for regular movies. **If [🔥] or a red [🔴] icon appears during movie recording, the card may be hot, so stop recording the movie and let the camera cool down before removing the card. (Do not remove the card immediately.)**
 - From a 4K movie, you can select any frame to save as an approx. 8.3 megapixel (3840×2160) JPEG still image to the card (📖 266).
-  ● Contrast detection is used to focus when recording 4K movies. Focusing may take longer and be more difficult than when recording HD or Full HD movies.

Frame Rate (fps: frame per second)

- **[119.9P] 119.88fps/[59.94P] 59.94fps/[29.97P] 29.97fps**

For areas where the TV system is NTSC (North America, Japan, South Korea, Mexico, etc.).

- **[100.0P] 100.00fps/[50.00P] 50.00fps/[25.00P] 25.00fps**

For areas where the TV system is PAL (Europe, Russia, China, Australia, etc.).

- **[23.98P] 23.98fps**

Mainly for motion pictures. **[23.98P]** (23.98 fps) is available when **[⚡: Video system]** is set to **[For NTSC]**.

Compression Method

- **[IPB] IPB (Standard)**

Uses IPB compression for normal movie recording. Compresses multiple frames at a time efficiently for recording.

- **[ALL-I] ALL-I (For editing/I-only)**

Uses ALL-I compression for time-lapse movie recording (📖 215).

Compresses each frame, one at a time, for recording. Although file sizes are larger than with IPB (Standard), movies are more suitable for editing.



Movie Recording Format

- **[MP4] MP4**

All movies you shoot with the camera are recorded as movie files in MP4 format (file extension “.MP4”).

Cards that Can Record Movies

For details on cards you can use for various movie recording sizes, see  497.

When recording movies, use a high-capacity card with a writing and reading speed (as specified in card performance requirements) shown in the table on  497 or higher than the standard specification. **Test cards by recording a few movies to make sure they can record correctly at your specified size** ( 205).



- Format cards before recording 4K movies ( 433).
- If you use a slow-writing card when recording movies, the movie may not be recorded properly. Also, if you play back a movie on a card with a slow reading speed, the movie may not be played back properly.
- When recording movies, use high-performance cards with a writing speed sufficiently higher than the bit rate.
- When movies cannot be recorded normally, format the card and try again. If formatting the card does not resolve the problem, refer to the card manufacturer's website, etc.



- To obtain better performance with the card, formatting the card with the camera before recording movies is recommended ( 433).
- To check the card's writing and reading speed, refer to the card manufacturer's website, etc.

High Frame Rate

You can record HD movies at a high frame rate of 119.88 fps or 100.00 fps by setting **[High Frame Rate]** under **[📷: Movie rec quality]** to **[Enable]**. This is ideal for recording movies that will be played back in slow motion. The maximum recording time per movie is 7 min. 29 sec.

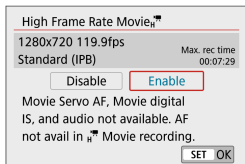

Movies are recorded as **[HD 119.9P IPB]** or **[HD 100.0P IPB]**.

Movie Servo AF and Movie digital IS have no effect when recording High Frame Rate movies. AF is not used to focus.

Because High Frame Rate movies are recorded as 29.97 fps/25.00 fps movie files, they are played back in slow motion at 1/4 speed.

- Check the **[Movie rec. size]** setting if you return this setting to **[Disable]**.
- The screen may flicker if you record High Frame Rate movies under fluorescent or LED lighting.
- For a moment when you start or stop recording High Frame Rate movies, the movie is not updated, and the frame stops momentarily. Be aware of this when recording movies to external devices via HDMI.
- Movie frame rates shown on the screen as you record High Frame Rate movies do not correspond to the frame rate of the movie recorded.
- Sound is not recorded.

Movie Files Exceeding 4 GB

Even if you record a movie exceeding 4 GB, you can keep recording without interruption.

● **Using SD/SDHC cards formatted with the camera**

If you use the camera to format an SD/SDHC card, the camera will format it in FAT32.

With a FAT32-formatted card, if you record a movie and the file size exceeds 4 GB, a new movie file will be created automatically.

When you play back the movie, you will have to play back each movie file individually. Movie files cannot be played back automatically in consecutive order. After the movie playback ends, select the next movie and play it back.

● **Using SDXC cards formatted with the camera**

If you use the camera to format an SDXC card, the camera will format it in exFAT.

When using an exFAT-formatted card, even if the file size exceeds 4 GB during movie recording, the movie will be saved as a single file (rather than being split into multiple files).

-  When importing movie files exceeding 4 GB to a computer, use either EOS Utility or a card reader (📖 475). It may not be possible to save movie files exceeding 4 GB if you attempt this using standard features of the computer's operating system.

Total Movie Recording Time and File Size Per Minute

For details on file sizes and the recording time available at each movie recording size, see  498.

Movie Recording Time Limit

- **When recording 4K movies**

The maximum recording time per movie is 9 min. 59 sec. Once 9 min. 59 sec. is reached, recording automatically stops. You can start recording a movie again by pressing the movie shooting button (which records the movie as a new file).

- **When recording Full HD/HD movies**

The maximum recording time per movie is 29 min. 59 sec. Once 29 min. 59 sec. is reached, recording automatically stops. You can start recording a movie again by pressing the movie shooting button (which records the movie as a new file).

- **When recording High Frame Rate movies**

The maximum recording time per movie is 7 min. 29 sec. Once 7 min. 29 sec. is reached, recording automatically stops. You can start recording a High Frame Rate movie again by pressing the movie shooting button (which records the movie as a new file).

Movie Self-Timer

Movie recording can be started by the self-timer.

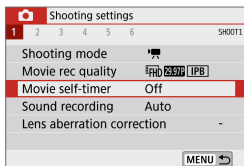

1 Select  [Movie self-timer].

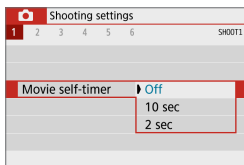

2 Select an item.

3 Record the movie.

- After you tap [●] or press the movie shooting button, the camera beeps and displays number of seconds left before recording.

Sound Recording

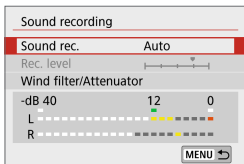

You can record movies while recording sound with the built-in stereo microphone. You can also freely adjust the sound-recording level.

Use [**📷**: **Sound recording**] to set sound recording functions.

Sound Recording/Sound-Recording Level

● Auto

The sound-recording level is adjusted automatically. Auto level control will take effect automatically in response to the sound level.

● Manual

You can adjust the sound-recording level as needed. Select [**Rec. level**] and press the <◀> <▶> keys while looking at the level meter to adjust the sound-recording level. Look at the peak hold indicator, and adjust so that the level meter sometimes lights up on the right of the [**12**] (-12 dB) mark for the loudest sounds. If it exceeds [**0**], the sound will be distorted.

● Disable

Sound will not be recorded.

Wind Filter

Set to [**Auto**] to reduce wind noise automatically when there is wind outdoors. When the wind filter function takes effect, part of the low bass sounds will also be reduced.

Attenuator

Automatically suppresses sound distortion caused by loud noises. Even if **[Sound rec.]** is set to **[Auto]** or **[Manual]** for recording, sound distortion may still result if there is a very loud sound. In this case, setting it to **[Enable]** is recommended.



- If you use the Wi-Fi (wireless communication) function with a microphone, the sound noise may be recorded. During sound recording, using the wireless communication function is not recommended.
- The camera's built-in microphone will also record the operation sound and mechanical sound of the camera during shooting.



- **[Sound rec.]** changes to **[Sound recording]: [On]/[Off]** in **[A⁺]**, **[A^B]**, Special scene, and Creative filters modes. Set to **[On]** for automatic adjustment of the recording level.
- Audio is also output when the camera is connected to televisions via HDMI, except when **[Sound rec.]** is set to **[Disable]**.
- The sound volume balance between L (left) and R (right) cannot be adjusted.
- Sound is recorded at a 48 kHz/16-bit sampling rate.

Time-lapse Movies

Images shot at a set interval can be stitched together automatically to create a 4K or Full HD time-lapse movie. A time-lapse movie shows how a subject changes in a much shorter period of time than the actual time it took. It is effective for a fixed-point observation of changing scenery, growing plants, celestial motion, etc.

Time-lapse movies will be recorded in MP4 format at the following quality: $\text{4K } 29.97\text{P } \text{ALL-I}$ (NTSC)/ $\text{4K } 25.00\text{P } \text{ALL-I}$ (PAL) for 4K shooting, and $\text{FHD } 29.97\text{P } \text{ALL-I}$ (NTSC)/ $\text{FHD } 25.00\text{P } \text{ALL-I}$ (PAL) for Full HD shooting.

Note that the frame rate will be switched automatically according to the **[P : Video system]** setting (📖 443).

1 Select a shooting mode.

- Select [P] (📖 198) or [M] (📖 200).

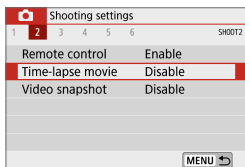

2 Select [M : Time-lapse movie].

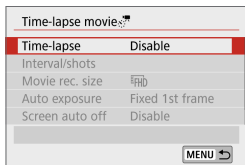

3 Select [Time-lapse].

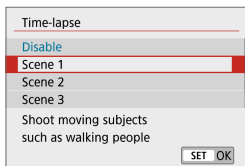

4 Select a scene.

- Select a scene to suit the shooting situation.
- For greater freedom when setting the shooting interval and number of shots manually, select [**Custom**].

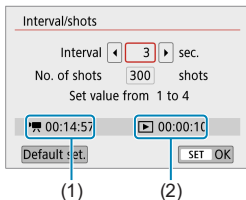

5 Set the shooting interval.

- Select **[Interval/shots]**.
- Select **[Interval]** (sec.). Use the <◀> <▶> keys to set a value.
- Refer to **[⏸: Time required]** (1) and **[▶: Playback time]** (2) to set the number.

When [Custom] is set

- Select **[Interval]** (min.:sec.).
- Press <SET> to display **[⏸]**.
- Set the desired number, then press <SET>. (Returns to **[□]**.)

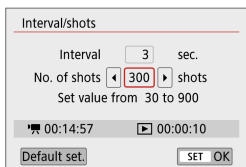

6 Set the number of shots.

- Select **[No. of shots]**. Use the <◀> <▶> keys to set a value, then press <SET>.
- Refer to the **[⏸: Time required]** and **[▶: Playback time]** to set the number.

When [Custom] is set

- Select the digit.
- Press <SET> to display **[⏸]**.
- Set the desired number, then press <SET>. (Returns to **[□]**.)
- Check that **[▶: Playback time]** is not displayed in orange.
- Select **[OK]** to register the setting.



- With **[Scene**]**, available intervals and numbers of shots are restricted, to suit the type of scene.
- If the number of shots is set to 3600, the time-lapse movie will be approx. 2 min. in NTSC and approx. 2 min. 24 sec. in PAL.

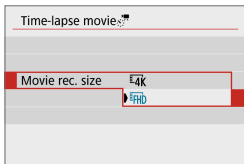

7 Select the desired movie recording size.

- **4K (3840×2160)**

The movie is recorded in 4K quality. The aspect ratio is 16:9. The frame rate is 29.97 fps (**29.97P**) for NTSC and 25.00 fps (**25.00P**) for PAL, and movies are recorded in MP4 (**MP4**) format with ALL-I (**ALL-I**) compression.

- **FHD (1920×1080)**

The movie is recorded in Full High-Definition (Full HD) quality. The aspect ratio is 16:9. The frame rate is 29.97 fps (**29.97P**) for NTSC and 25.00 fps (**25.00P**) for PAL, and movies are recorded in MP4 (**MP4**) format with ALL-I (**ALL-I**) compression.



- The **4K 29.97P** **4K 25.00P** bit rate is approx. 300 Mbps, and the **FHD 29.97P** **FHD 25.00P** bit rate, approx. 90 Mbps. Use a card with a sufficiently fast read speed.

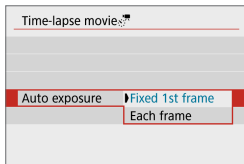

8 Configure [Auto exposure].

● Fixed 1st frame

When taking the first shot, metering is performed to set the exposure automatically to match the brightness. The exposure setting for the first shot will be applied to subsequent shots. Other shooting-related settings for the first shot will also be applied for subsequent shots.

● Each frame

Metering is also performed for each subsequent shot to set the exposure automatically to match the brightness. Note that if functions such as Picture Style and white balance are set to **[Auto]**, they will be set automatically for each subsequent shot.

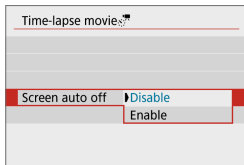

9 Configure [Screen auto off].

● Disable

Even during time-lapse movie recording, the image will be displayed. Note that the screen will turn off when approx. 30 min. elapse after the recording started.

● Enable

Note that the screen will turn off when approx. 10 sec. elapse after the shooting started.

- 
 ● During time-lapse movie recording, you can press the <INFO> button to turn on/off the screen.

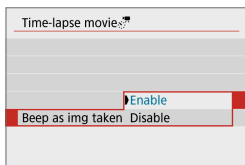

10 Set the beeper.

- Select **[Beep as img taken]**.
- If **[Disable]** is set, the beeper will not sound for shooting.

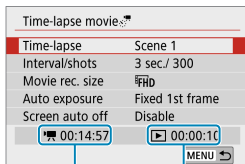

11 Check the settings.

(1)

(2)

(1) Time required

Indicates the time required to shoot the set number of shots with the set interval. If it exceeds 24 hours, “*** days” will be displayed.

(2) Playback time

Indicates the movie recording time (time required to play back the movie) when creating the time-lapse movie in 4K movie or Full HD movie from the still photos taken with the set intervals.

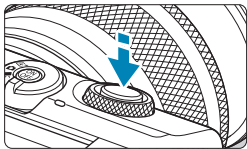

12 Close the menu.





- Press the <MENU> button to turn off the menu screen.

13 Record the time-lapse movie.

- Press the shutter button halfway to check the focus and exposure.
- Press the <●> button to start time-lapse movie recording.
- The number of shots remaining is displayed (1).
- While the time-lapse movie is recorded, [●REC] is displayed.
- AF will not work during time-lapse movie recording.
- Since the electronic shutter is used for shooting, the shutter make no mechanical sound during time-lapse movie recording.
- When the set number of shots are taken, the time-lapse movie recording ends.
- To cancel recording time-lapse movies, set [Time-lapse] to [Disable].



- If the card does not have enough free space to record the set number of shots, **[Playback time]** will be displayed in orange. Although the camera can continue shooting, the shooting will stop when the card becomes full.
- If the movie file size exceeds 4 GB with the **[No. of shots]** settings and the card is not formatted in exFAT (📖 434), **[Playback time]** will be displayed in orange. If you keep shooting in this condition and the movie file size reaches 4 GB, the time-lapse movie recording will stop.
- Do not point the camera toward an intense light source, such as the sun or an intense artificial light source. Doing so may damage the image sensor or the camera's internal components.
- Time-lapse movies cannot be recorded when the camera is connected to a computer with the interface cable, or when an HDMI cable is connected.
- Movie Servo AF will not function.
- Do not zoom the lens during time-lapse movie recording. Zooming the lens may cause the image to be out of focus, the exposure to change, or the lens aberration correction not to function properly.
- When recording a time-lapse movie under a flickering light, noticeable image flickering, horizontal stripes (noise), or irregular exposures may be recorded.
- Images that are displayed while time-lapse movies are being recorded may look different from the resulting movie. (For example, there may be inconsistent brightness from flickering light sources, or noise from a high ISO speed.)
- When recording a time-lapse movie under low light, the image displayed during shooting may look different from what is actually recorded in the movie.
- If you move the camera from left to right (panning) or shoot a moving subject during time-lapse movie recording, the image may look extremely distorted.
- During time-lapse movie recording, auto power off will not take effect. Also, you cannot adjust the shooting function and menu function settings, play back images, etc.
- Sound is not recorded for time-lapse movies.
- With **[Interval]** set to less than 3 sec. and **[Auto exposure]** set to **[Each frame]**, if the brightness differs greatly from the preceding shot, the camera may not shoot at the set interval.

- ❗
- If the next scheduled shot is not possible, it will be skipped. This may shorten the recording time of the created time-lapse movie.
- If the time it takes to record to the card exceeds the shooting interval due to the shooting functions set or card performance, some of the shots may not be taken with the set intervals.
- The captured images are not recorded as still photos. Even if you cancel the time-lapse movie recording after only one shot is taken, it will be recorded as a movie file.
- If you connect the camera to a computer with the interface cable and use EOS Utility (EOS software), set [: **Time-lapse movie**] to [**Disable**]. If an option other than [**Disable**] is selected, the camera cannot communicate with the computer.
- During time-lapse movie recording, the lens's Image Stabilizer will not operate.
- Time-lapse movie recording ends if the camera is turned off, and the setting changes to [**Disable**].
- Even if a flash is used, it will not fire.
- The following operations cancel standby for time-lapse movie recording and switch the setting to [**Disable**].
 - Selecting [**Basic settings**] in [: **Reset camera**]
 - Using the shooting mode switch
- If you start time-lapse movie recording while the white [] icon (📖 192) is displayed, the image quality of the time-lapse movie may deteriorate. It is recommended that you start time-lapse movie recording after the white [] icon disappears (camera's internal temperature decreases).
- With [**Auto exposure**] set to [**Each frame**], ISO speed, shutter speed, and aperture value may not be recorded in the time-lapse movie Exif information in some modes.



- Using a tripod is recommended.
- Recording test movies for time-lapse movies beforehand is recommended.
- The movie's field of view coverage for both the 4K and Full HD time-lapse movie recording is approx. 100%.
- To cancel the time-lapse movie recording, press the <●> button. The time-lapse movie shot so far will be recorded on the card.
- You can play back the recorded time-lapse movie with this camera the same way that you play back normal movies.
- If the time required for shooting is more than 24 hours but not more than 48 hours, "2 days" will be indicated. If three or more days are required, the number of days will be indicated in 24-hour increments.
- Even if the time-lapse movie's playback time is less than 1 sec., a movie file will still be created. For **[Playback time]**, "00'00" will be displayed.
- If the shooting time is long, using the household power outlet accessories (sold separately) is recommended.
- YCbCr 4:2:0 (8-bit) color sampling and the Rec. ITU-R BT.709 color space are used for 4K/Full HD time-lapse movies.
- You can use Wireless Remote Control BR-E1 (sold separately) to start and stop the time-lapse movie recording.

With Wireless Remote Control BR-E1

- First, pair the Wireless Remote Control BR-E1 with the camera (📖 387).
- Make sure **[📷: Remote control]** is set to **[Enable]**.

Video Snapshots

Record a series of short video snapshots, each a few seconds long, and the camera will combine them to create a video snapshot album that shows these highlights of your trip or event.

Video snapshots are available when the movie recording size is set to **FHD 29.97P IPB** (NTSC) / **FHD 25.00P IPB** (PAL).

Video snapshot albums can also be played back with background music (📖 299).

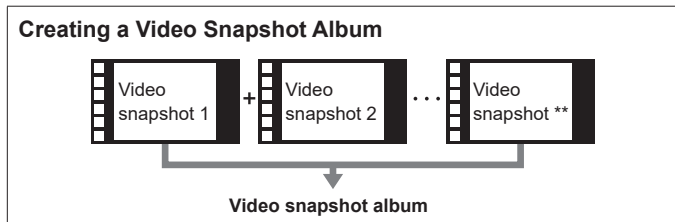

- 1 Select a shooting mode.
 - Select [**📷**] (📖 198) or [**📷M**] (📖 200).

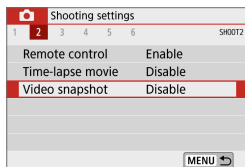

- 2 Select [**📷**: Video snapshot].

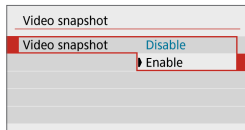

- 3 Select [**Enable**].

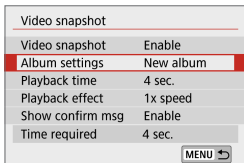

4 Select [Album settings].

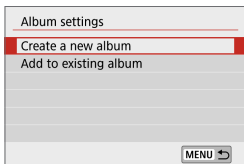

5 Select [Create a new album].

- Read the message and select [OK].

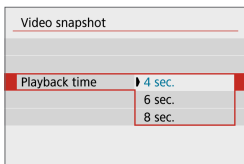

6 Specify the playback time.

- Specify playback time per video snapshot.

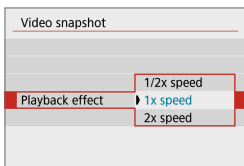

7 Specify the playback effect.

- This setting determines how fast albums are played back.

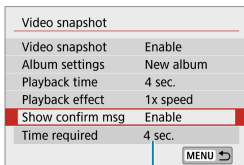

8 Check the required recording time.

- The time required to record each video snapshot is indicated (1), based on the playback time and effect.

(1)



(2)

9 Close the menu.

- Press the <MENU> button to close the menu.
- A blue bar is displayed to indicate the recording time (2).



10 Record the first video snapshot.

- Press the movie shooting button to start recording.
- The blue bar indicating recording time gradually decreases, and after the specified time elapses, recording stops automatically.
- A confirmation message is displayed (📖 227).



11 Save as a video snapshot album.

- Select [📖 Save as album].
- The clip is saved as the first video snapshot in the album.



12 Record your next video snapshots.

- Repeat step 10 to record the next video snapshot.
- Select [📖 Add to album].
- To create another album, select [📖 Save as a new album].
- Repeat step 12 as needed.

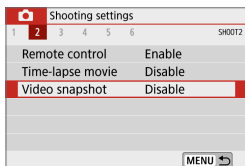

- 13 Stop recording video snapshots.**
- Set **[Video snapshot]** to **[Disable]**.
To return to normal movie recording, be sure to specify [Disable].
 - Press the **<MENU>** button to close the menu and return to normal movie recording.

Options in Steps 11 and 12

Function	Description
Save as album (step 11)	Saves the clip as the first video snapshot in an album.
Add to album (step 12)	Adds the current video snapshot to the album recorded most recently.
Save as a new album (step 12)	Creates a new album and saves the clip as the first video snapshot. This album file is different from the one recorded most recently.
Playback video snapshot (steps 11, 12)	Plays the video snapshot just recorded.
Do not save to album (step 11) Delete without saving to album (step 12)	Deletes the recently recorded video snapshot without saving it to an album. Select [OK] on the confirmation dialog.

- If you prefer to record the next video snapshot immediately, set **[Show confirm msg]** under **[CAM: Video snapshot]** to **[Disable]**. This setting enables you to record the next video snapshot immediately, without a confirmation message.

Adding to an Existing Album

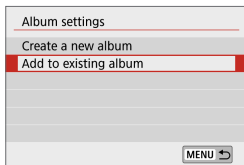

1 Select [Add to existing album].

- Follow step 5 on [\(p. 225\)](#) to select [Add to existing album].



2 Select an existing album.

- Use the <◀> <▶> keys to select an existing album, then press <SET>.
- Select [OK].
- Some video snapshot settings will be updated to match settings of the existing album.

3 Close the menu.

- Press the <MENU> button to close the menu.
- The video snapshot recording screen is displayed.

4 Record a video snapshot.

- Record the video snapshot as described in step 10 of “Video Snapshot” ([\(p. 224\)](#)).



- You cannot select an album shot with another camera.

General Video Snapshot Precautions

- No sound is recorded when you set [Playback effect] to [1/2x speed] or [2x speed].
- Recording time per video snapshot is only approximate. It may differ slightly from the actual recording time indicated during playback, due to the frame rate and other factors.

Miniature Effect Movie

By blurring image areas outside a selected area, you can record movies with a miniature model effect applied. By choosing the playback speed before the movie is recorded, you can also make movies that look like scenes happening in miniature models, with people and objects in the scene moving quickly during playback. Sound is not recorded.



1 Select [OFF].

- Press <SET>, and on the Quick Control screen, select [OFF].
- Select [5x], [10x], or [20x] as the playback speed.



2 Move the scene frame.

- Use the scene frame to set an area that will look sharp.
- To make the scene frame movable (displayed in orange), press the <INFO> button or tap [INFO] in the lower right of the screen.
- To switch between vertical and horizontal scene frame orientation, tap [ORIENT] in the lower left of the screen.
- To move a horizontal scene frame, press the <▲> <▼> keys, and to move a vertical scene frame, press the <◀> <▶> keys.
- To return the scene frame to the center of the screen, tap [CENTER] in the lower left of the screen.
- Press <SET> to confirm the position of the scene frame. Next, set the AF point.



3 Move the AF point.

- The AF point turns orange and can be moved.
- Press the <⬅➡> cross keys to move the AF point to the position to focus on.
- Aligning the AF point and scene frame is recommended.
- To return the AF point to the center of the screen, tap [] in the lower left of the screen.
- Press <SET> to confirm the position of the AF point.

4 Record the movie.

- Press the movie shooting button.

Estimated playback speed and time for a movie recorded for one minute

Speed	Playback Time
5x	Approx. 12 sec.
10x	Approx. 6 sec.
20x	Approx. 3 sec.

- To make people and objects in the scene move quickly during playback, select [], [], or [] before recording the movie. The scene will resemble a miniature model.
 - Sound is not recorded.

- You can switch the scene frame orientation in step 2 with the <◀> <▶> keys when in horizontal orientation or the <▲> <▼> keys when in vertical orientation.

Movie Servo AF

With this function enabled, the camera focuses on the subject continuously during movie recording.

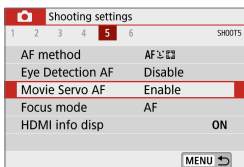

1 Select [: Movie Servo AF].

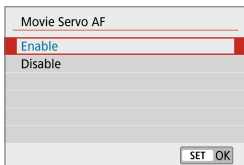

2 Select [Enable].

● When [Enable] is set:

- The camera focuses on the subject continuously even when you are not pressing the shutter button halfway.
- To keep the focus at a specific position, or if you prefer not to record mechanical sounds from the lens, you can temporarily stop Movie Servo AF by tapping [] in the lower left of the screen.
- When Movie Servo AF is paused, if you return to movie recording after operations such as pressing the <MENU> or <▶> button or changing the AF method, Movie Servo AF will resume.

● When [Disable] is set:

- Press the shutter button halfway to focus.

 **Cautions When [Movie Servo AF] is Set to [Enable]**

- **Shooting Conditions that Make Focusing Difficult**
 - A fast-moving subject approaching or moving away from the camera.
 - A subject moving at a close distance to the camera.
 - When shooting with a higher f/number.
 - Also see “Shooting Conditions that Make Focusing Difficult” (📖 179).
- Since the lens is driven continuously and the battery power is consumed, the possible movie recording time (📖 498) will be shortened.
- Movie Servo AF will pause during zooming or magnified view.
- During movie recording, if a subject approaches or moves away or if the camera is moved vertically or horizontally (panning), the recorded movie image may momentarily expand or contract (change in image magnification).

Movie Digital IS

In-camera image stabilization electronically corrects camera shake during movie recording. This function is called “Movie digital IS”. When using a lens with built-in optical Image Stabilizer, set the lens’s Image Stabilizer switch to <ON>.

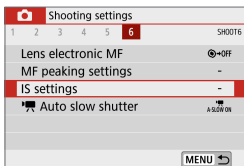

1 Select [: IS settings].

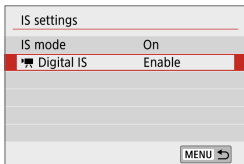

2 Select [Digital IS].

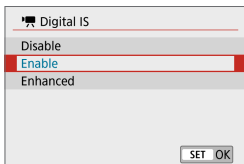

3 Select a setting item.

- **Disable** ()
Image stabilization with Movie digital IS is disabled.
- **Enable** ()
Camera shake will be corrected. The image will be slightly magnified.
- **Enhanced** () **(Not displayed for still photos shooting.)**
Compared to when [**Enable**] is set, stronger camera shake can be corrected. The image will be more magnified.

Combination IS

Even more effective correction is possible by recording movies with Movie digital IS and a Combination IS-compatible lens, which will combine optical and digital image stabilization by the lens and camera.



- Movie digital IS has no effect with a lens without Image Stabilizer, or when the lens IS switch is set to <OFF>. (In this case, when **[Enable]** or **[Enhanced]** is specified, the Movie digital IS icon blinks.)
- With a lens whose focal length is longer than 800 mm, Movie digital IS will not function.
- Stabilization by Movie digital IS may be less effective at some movie recording sizes.
- The wider the angle of view (wide angle), the more effective the image stabilization will be. The narrower the angle of view (telephoto), the less effective the image stabilization will be.
- When using a tripod, setting Movie digital IS to **[Disable]** is recommended.
- Depending on the subject and shooting conditions, the subject may blur noticeably (the subject momentarily looks out of focus) due to the effects of the Movie digital IS.
- When using a TS-E lens, fish-eye lens, or non-Canon lens, setting Movie digital IS to **[Disable]** is recommended.
- Since Movie digital IS magnifies the image, the image looks more grainy. Noise, dots of light, etc. may also become noticeable.



- For details on lenses compatible with Combination IS, visit the Canon website.
- "+" is added to the Movie digital IS icon (📖 233) when a lens compatible with Combination IS is used.

Other Menu Functions

[📷1]

- **Shooting mode**

Available options include autoexposure and manual exposure movie recording.

- **Lens aberration correction**

Peripheral illumination and chromatic aberration can be corrected as you record movies. For details on lens aberration correction, see 📖 128.

[📷2]

- **Remote control shooting**

When **[Enable]** is set, you can start or stop movie recording using Wireless Remote Control BR-E1 (sold separately). First, pair the BR-E1 with the camera (📖 387).

With Wireless Remote Control BR-E1

For normal movie recording, set the BR-E1 release timing/movie shooting switch to <📷>, then press the release button.

For details on Time-lapse movie recording, see 📖 223.

 3

- **Exposure compensation**



Exposure compensation is available in a range of ± 3 stops, in 1/3-stop increments. For details on exposure compensation, see  137.

-  **ISO speed settings**

- **ISO speed**

In [] mode, you can set the ISO speed manually. You can also select ISO Auto.

- **Max for Auto**

You can set the maximum limit for ISO Auto in Full HD/HD movie recording in [] mode or in [] mode with ISO Auto.



 ● ISO 16000/20000/25600 for Full HD/HD movie recording is an expanded ISO speed (indicated by [**H**]).

- **Auto Lighting Optimizer**

Brightness and contrast can be corrected automatically. For details on Auto Lighting Optimizer, see  141.

- **Highlight tone priority**

You can reduce overexposed, clipped highlights as you record movies. For details on Highlight tone priority, see  142.

 ● [**Enhanced**] is not available (not displayed) when recording movies with [: **Highlight tone priority**] set.

- **Metering timer**

For details on the metering timer, see  145.

[📷4]**● White balance**

For details on white balance, see 📖 147.

● Custom White Balance

For details on custom white balance, see 📖 150.

● White balance correction

For details on white balance correction, see 📖 152.

● Picture Style

For details on Picture Styles, see 📖 154.

[📷5]**● AF method**

For details on AF methods, see 📖 170.

● Eye Detection AF

For details on Eye Detection AF, see 📖 180.

● Focus mode

For details on focus modes, see 📖 182.

● HDMI information display

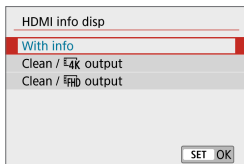

You can configure information display for image output via an HDMI cable.

● With info

The image, shooting information, AF points, and other information is shown on the other device via HDMI. Note that the camera screen goes off. Recorded movies are saved to the card.

● Clean / 4K output

HDMI output consists solely of 4K movies. Shooting information and AF points are also displayed on the camera, but no image is recorded to the card. Note that Wi-Fi communication is not available.

● Clean / FHD output

HDMI output consists solely of Full HD movies. Shooting information and AF points are also displayed on the camera, but no image is recorded to the card. Note that Wi-Fi communication is not available.

[📷6]

● Lens electronic MF

For details on Lens electronic MF, see 📖 183.

● MF peaking settings

For details on MF peaking settings, see 📖 187.

● IS settings

For details on image stabilization, see 📖 188.

● Auto slow shutter

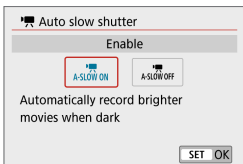

You can choose whether to record movies that are brighter than when set to **[Disable]** by automatically slowing the shutter speed under low light.

Applies when the frame rate of the movie recording size is **59.94P** or **50.00P**.

● **Disable**

Enables you to record movies with smoother, more natural movement, less affected by subject shake than when set to **[Enable]**. Note that under low light, movies may be darker than when set to **[Enable]**.

● **Enable**

Enables you to record brighter movies than when set to **[Disable]** by automatically reducing the shutter speed to 1/30 sec. (NTSC) or 1/25 sec. (PAL) under low light.



- Setting to **[Disable]** is recommended when recording moving subjects under low light, or when afterimages such as trails may occur.

General Movie Recording Cautions



Red [🔥] Internal Temperature Warning Icon

- If the camera's internal temperature increases due to prolonged movie recording or under a high ambient temperature, a red [🔥] icon will appear.
- The red [🔥] icon indicates that movie recording will soon be terminated automatically. If this happens, you will not be able to shoot again until the camera's internal temperature decreases. Turn off the power and let the camera rest for a while.
- Recording a movie at a high temperature for a prolonged period will cause the red [🔥] icon to appear earlier. When you are not recording, always turn off the camera.

[🔍] Display

- If [🔍] is displayed, see 📖 483.

Recording and Image Quality

- Image Stabilizer is active all times, even without the shutter button pressed halfway, when you use an IS-equipped EF-M lens with **[IS mode]** in **[📷: IS settings]** set to **[On]** or an EF/EF-S lens with the IS switch set to **<ON>**. The Image Stabilizer consumes battery power and may shorten the total movie recording time depending on the shooting conditions. Disabling the Image Stabilizer is recommended when you are using a tripod or other means to secure the camera.
- If the brightness changes as you record a movie with auto exposure, the movie may appear to stop momentarily. In this case, record movies with manual exposure.
- If there is a very bright light source in the image, the bright area may appear black on the screen. Movies are recorded almost exactly as they appear on the screen.
- Image noise or irregular colors may occur when shooting at high ISO speeds, high temperatures, low shutter speeds, or under low light. Movies are recorded almost exactly as they appear on the screen, except in time-lapse movie recording.
- If you play back a movie with other devices, image or sound quality may decline or playback may not be possible (even if the devices support MP4 format).



Recording and Image Quality

- If you use a card with a slow writing speed, an indicator may appear on the right of the screen during movie recording. It indicates how much data has not yet been written to the card (remaining capacity of the internal buffer memory). The slower the card, the faster the indicator will climb upward. If the indicator (1) becomes full, movie recording will stop automatically.
- If the card has a fast writing speed, the indicator will either not appear or the level (if displayed) will hardly go upward. First, record a few test movies to see if the card can write fast enough.
- If the indicator indicates that the card is full and movie recording stops automatically, the sound near the end of the movie may not be recorded properly.
- If the card's writing speed is slow (due to fragmentation) and the indicator appears, formatting the card may make the writing speed faster.

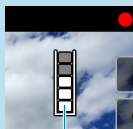

(1)

Audio Restrictions

- The following restrictions apply when recording movies that include sound.
 - Sound will not be recorded for approx. the last two frames.
 - When you play back movies on Windows, movie images and sound may become slightly out of synchronization.



Flash Photography

This chapter describes how to shoot with flash.



- Flash cannot be used while you are recording movies.

Flash Photography

Using flash is recommended when the [⚡] icon is displayed on the screen, when subjects in daytime shots are backlit, or when you shoot under low light.

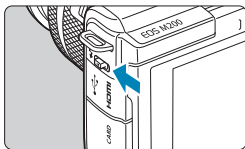

1 Use the <⚡> lever to raise the flash.

2 Press the shutter button halfway.

- Confirm that a [⚡] icon appears on the screen.

3 Take the picture.

- The flash fires according to **[Flash firing]** settings (📖 249).
- To retract the flash after shooting, push it down with your fingers until it clicks into place.

Approximate Flash Range

(Maximum approx. range in meters/feet)

ISO Speed (📖 138)	EF-M15-45mm f/3.5-6.3 IS STM	
	Wide-angle End	Telephoto End
	f/3.5	f/6.3
400	2.9/9.5	1.6/5.2
3200	8.1/26.6	4.5/14.8

* It may not be possible to obtain standard exposure when shooting distant subjects at high ISO speeds, or under certain subject conditions.

Shutter Speed and Aperture Value in Flash Photography

Shooting Mode	Shutter Speed	Aperture Value
P	Auto (1/200–30 sec.)*	Automatically set
Tv	Manual (1/200–30 sec.)	Automatically set
Av	Auto (1/200–30 sec.)*	Manually set
M	Manual (1/200–30 sec., Bulb)	Manually set

* When **[Slow synchro]** under **[Flash control]** is set to **[1/200-30sec. auto]**.



- Do not use the flash unless it is fully raised.
- The bottom of images may be dark if light from the flash is obstructed by a lens hood, or by a subject that is too close.

Flash Photography in [Av] Mode

Flash output is automatically adjusted to provide suitable flash exposure for your specified aperture value.

In low light, the main subject is exposed with autoflash metering and the background with a slow shutter speed, to provide standard exposure for both the subject and background. Using a tripod is recommended.

Flash Exposure Compensation



Just as exposure compensation is adjustable, you can also adjust flash output.

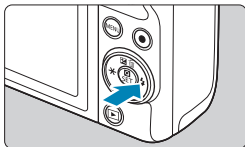

1 Press <▶>.

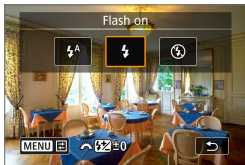

2 Press the <MENU> button.

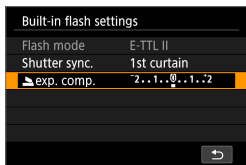

3 Select [exp. comp.].

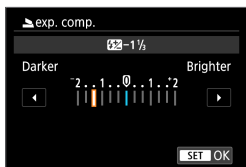

4 Set the compensation amount.

- To make flash exposure brighter, set the compensation amount toward **[Brighter]** (positive compensation), or to make it darker, set it toward **[Darker]** (negative compensation).
- After you are finished shooting, follow steps 1–3 to return the compensation amount to zero.

! When [: Auto Lighting Optimizer] (📖 141) is set to an option other than **[Disable]**, images may still look bright even if negative compensation is set.

- The exposure compensation amount will remain in effect even after you turn off the camera.
- Flash exposure compensation can also be set by turning the < > dial in step 2.
- You can also set flash exposure compensation with **[Built-in flash settings]** in [: Flash control] (📖 252).

FE Lock

Shooting with FE (flash exposure) Lock provides suitable flash exposure over your specified area of the subject.

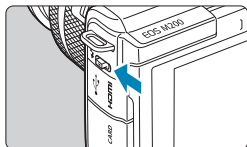

1 Use the <⚡> lever to raise the flash.

- Press the shutter button halfway and confirm that a [⚡] icon appears on the screen.

2 Focus on the subject.

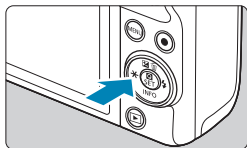

3 Press the <★> button (Ⓜ16).

- Center the subject on the screen, then press the <★> button.
- A preflash is fired by the flash, and the required flash output level is retained.
- [⚡★] is lit.
- Each time you press the <★> button, a preflash is fired, and the flash output required for shooting is retained.



4 Take the picture.

- Compose the shot and press the shutter button completely.



- The [⚡] icon blinks when subjects are too far away and your shots would be dark. Approach the subject and repeat steps 2–4.

Flash Control

Functions of the flash can be set from menu screens on the camera.

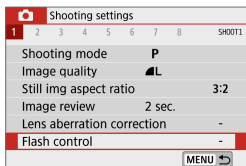

1 Select [: Flash control].

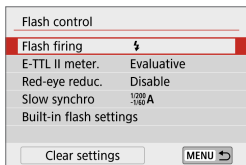

2 Select an item.

Flash Firing

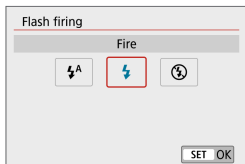

Set to [**⚡^A**] to have the flash fire automatically, based on shooting conditions.

Set to [**⚡**] to have the flash always fire when you shoot.

Set to [**⚡/**] to disable flash firing.



- The information displayed varies by shooting mode.
- Can also be set (except in some shooting modes) by pressing the <⚡> button when the shooting mode switch is set to <[A+]> or <[CAM]>.

E-TTL II Flash Metering ☆

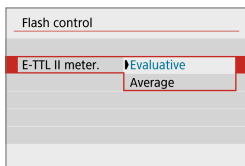

For normal flash exposures, set it to [**Evaluative**]. If [**Average**] is set, the flash exposure will be averaged for the entire metered scene.

Red-eye Reduction

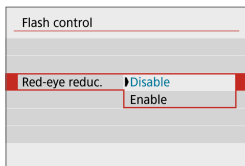

Set to [**Enable**] to reduce red-eye by emitting the red-eye reduction lamp (📖 36) before firing the flash.

Slow Synchro ☆

Slow synchro	
1/200-30sec. auto	1/200 A -30"
1/200-1/60sec. auto	1/200 A -1/60"
1/200 sec. (fixed)	1/200
SET OK	

You can set the flash-sync shutter speed for flash photography in **[Av]** Aperture-priority AE or **[P]** Program AE mode.

- **[^{1/200}_{-30"}A] 1/200-30sec. auto**

The flash sync speed is set automatically within a range of 1/200 sec. to 30 sec. to suit the scene's brightness. Slow-sync shooting is used under some shooting conditions, in low-light locations, and shutter speed is automatically lowered.

- **[^{1/200}_{-1/60"}A] 1/200-1/60sec. auto**

Prevents a slow shutter speed from being set automatically in low-light conditions. It is effective for preventing subject blur and camera shake. However, while the subject will be properly exposed with the flash, the background may come out dark.

- **[1/200] 1/200 sec. (fixed)**

The flash sync speed is fixed at 1/200 sec. This more effectively prevents subject blur and camera shake than with **[1/200-1/60sec. auto]**. However, in low light, the subject's background will come out darker than with **[1/200-1/60sec. auto]**.

- To use slow-sync shooting in **[Av]** or **[P]** mode, set to **[1/200-30sec. auto]**.

Built-in Flash Function Settings ☆

Built-in flash settings	
Flash mode	E-TTL II
Shutter sync.	1st curtain
exp. comp.	2...1..0..1..2
MENU ↩	

● Flash mode

Built-in flash settings	
Flash mode	E-TTL II Manual flash
MENU ↩	

Set to **[E-TTL II]** to shoot in E-TTL II/E-TTL fully automatic flash mode.

Built-in flash settings	
flash output	Maximum Medium Minimum
MENU ↩	

Set to **[Manual flash]** to specify your preferred flash output (**[Maximum]**, **[Medium]**, or **[Minimum]**) for **[flash output]**.

- Available in **[Tv]**, **[Av]**, and **[M]** modes.

● Shutter synchronization

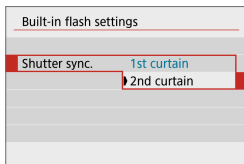

Normally, set this to **[1st curtain]** so that the flash fires immediately after the exposure starts.

Set to **[2nd curtain]** and use low shutter speeds for natural-looking shots of subject motion trails, such as car headlights.

- ⓘ When using second-curtain synchronization, set the shutter speed to 1/80 sec. or slower. If the shutter speed is 1/100 sec. or faster, first-curtain synchronization will be applied automatically even if **[2nd curtain]** is set.

● Flash exposure compensation

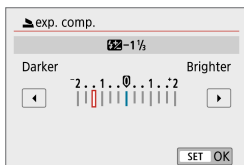

Just as exposure compensation is adjustable, you can also adjust flash output (📖 246).

Clearing Built-in Flash Settings

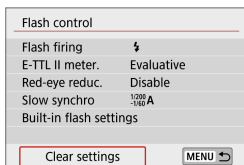

1 Select **[Clear settings]**.

2 Select **[OK]**.

- The default settings are now restored.

Playback Settings

This chapter covers topics related to playback—playing back captured still photos and movies—and introduces menu settings on the Playback Settings ([) tab.



- Normal display or selection on this camera may not be possible for images captured on other cameras, or images from this camera that have been edited or renamed on a computer.
- Images may be displayed that cannot be used with certain playback features.

Tab Menus: Playback Settings

● Playback settings 1

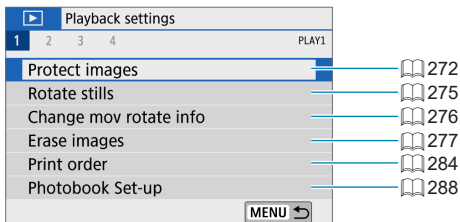

● Playback settings 2

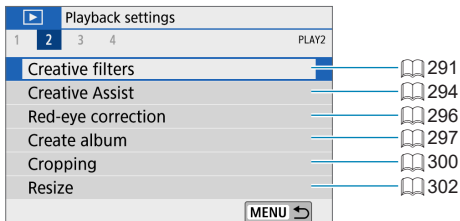

● Playback settings 3

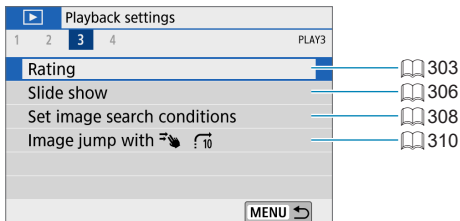

● Playback settings 4

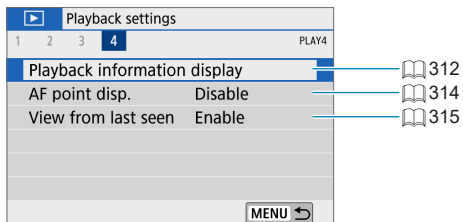
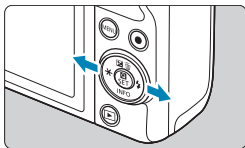

Image Playback

Single-Image Display



- 1 Play back the image.**
 - Press the  button.



- 2 Select an image.**
 - To play back newer images, press the  button, and to play back older images, press the  button.
 - Each time you press the  button, the display will change.



No information



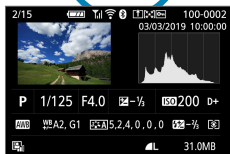

Basic information display



Shooting information display

- 3 Exit the image playback.**
 - Press the  button to exit the image playback.

Shooting Information Display

With the shooting information screen displayed, you can press the <INFO> button to change the information displayed. You can also customize the information displayed, in [: **Playback information display**] ( 312).

Touch Playback

The camera features a touch-screen panel that you can touch to control playback. Supported touch operations are like those used with smartphones and similar devices. First, press the <▶> button to prepare for touch playback.

Image browsing



Jump display



Index display

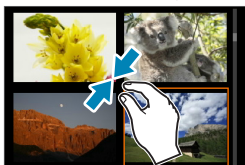

Magnified view



- You can also magnify display by double-tapping with one finger.

Magnified Image Display

You can magnify your captured images.

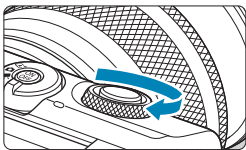

1 Magnify the image.

- During image playback, turn the dial clockwise. In magnified view, the position of the magnified area (1) is shown in the lower right of the screen.



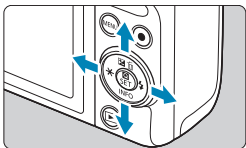

(1)



2 Scroll the image.

- Press the cross keys to scroll the image vertically and horizontally.



- To keep the same position magnified while switching images, tap [] in the upper right of the screen, then press the keys while [] is displayed.

Index Display (Multiple-Image Display)

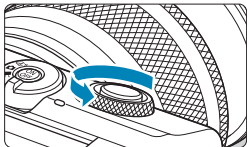

1 Switch to the index display.

- During image playback, turn the <☀> dial counterclockwise.

- The 4-image index display will appear. The selected image is highlighted with an orange frame.

Turning the <☀> dial further counterclockwise switches to 9, 36, and 100-image display.

Turning the dial the other way switches to 100, 36, 9, 4, and single-image display.

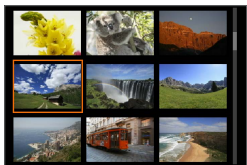

2 Select an image.

- Press the <⬅➡> cross keys to move the orange frame and select the image.
- Press <SET> in the index display to display the selected image.

Movie Playback

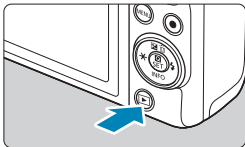

1 Play back the image.

- Press the <▶> button.



2 Select a movie.

- Use the <<◀> <▶> keys to select the movie to play back.
- In the single-image display, the [SET] icon displayed on the upper left indicates a movie.
- In the index display, perforations at the left edge of a thumbnail indicate a movie. As rolls cannot be played back from the index display, press <SET> to switch to the single-image display.

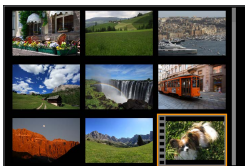

3 In the single-image display, press <SET>.



4 Press <SET> to play back the movie.



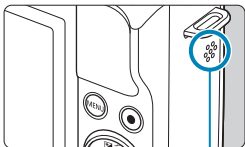







- The movie will start playing back.
- You can pause playback and display the movie playback panel by pressing <SET>. Press it again to resume the playback.
- You can also adjust the volume during movie playback by using the <▲> <▼> keys.



(1)

(1) Speaker











Movie Playback Panel

Item	Playback Operations
 Play	Pressing <SET> toggles between playback and stop.
 Slow motion	Adjust the slow motion speed with the <◀> <▶> keys. The slow motion speed is indicated on the upper right of the screen.
 Skip backward	Skips backward approx. 4 sec. each time you press <SET>.
 Previous frame	Displays the previous frame each time you press <SET>. Holding <SET> down will rewind the movie.
 Next frame	Plays the movie frame-by-frame each time you press <SET>. Holding <SET> down will fast forward the movie.
 Skip forward	Skips forward approx. 4 sec. each time you press <SET>.
 Edit	Displays the editing screen (📖 264).
 Frame Grab	Available when you play 4K or 4K time-lapse movies. Enables you to extract the current frame and save it as a JPEG still image (📖 266).
 Background music	Plays back a movie with the selected background music (📖 299).
	Playback position
mm' ss"	Playback time (minutes:seconds)
 Volume	Use the <▲> <▼> keys to adjust the speaker volume (📖 261).



- To skip back or forward approx. 4 sec. during movie playback, press the <◀> <▶> keys.

Movie Playback Panel (Video Snapshot Albums and Digest Movies)

Item	Playback Operations
 Play	Pressing <SET> toggles between playback and stop.
 Slow motion	Adjust the slow motion speed with the <◀> <▶> keys. The slow motion speed is indicated on the upper right of the screen.
 Previous clip	Displays the first frame of the previous clip or video snapshot.
 Previous frame	Displays the previous frame each time you press <SET>. Holding <SET> down will rewind the movie.
 Next frame	Plays the movie frame-by-frame each time you press <SET>. Holding <SET> down will fast forward the movie.
 Next clip	Displays the first frame of the next clip or video snapshot.
 Erase clip	Erases the current clip or video snapshot.
 Edit	Displays the editing screen (📖 264).
 Background music	Plays back an album with the selected background music (📖 299).
	Playback position
mm' ss"	Playback time (minutes:seconds)
 Volume	Use the <▲> <▼> keys to adjust the speaker volume (📖 261).



- Adjust the volume using television controls when the camera is connected to a television for movie playback (📖 270). (Volume cannot be adjusted with the <▲> <▼> keys.)
- Movie playback may stop if the card's read speed is too slow or movie files have corrupted frames.



- To skip back or forward to the beginning of the previous or next video snapshot or clip during playback of video snapshot albums or digest movies, press the <◀> <▶> keys.
- For details on the movie recording time available, see 📖 498.

Editing a Movie's First and Last Scenes

You can edit out the first and last scenes of a movie in approx. 1-sec. increments.



- 1 Pause movie playback.**
 - The movie playback panel will appear.

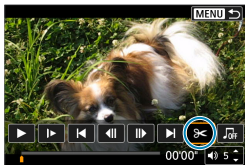

- 2 On the movie playback panel, select [⏏].**

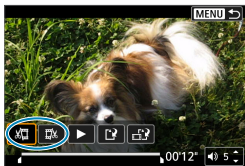

- 3 Specify the part to be edited out.**
 - Select either [⏏] (Cut beginning) or [⏏] (Cut end).
 - Press the <<> <>> keys for frame-by-frame playback.
 - After deciding which part to edit out, press <SET>. The portion indicated by a line at the bottom of the screen will remain.

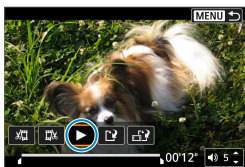

- 4 Check the edited movie.**
 - Select [▶] to play the edited movie.
 - To change the edited part, go back to step 3.
 - To cancel the editing, press the <MENU> button.

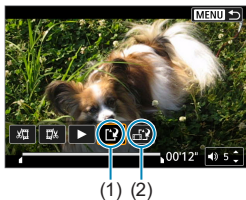

5 Save the image.

- Select **[▶]** (1).
- The save screen will appear.
- To save it as a new roll, select **[New file]**. To save it and overwrite the original movie file, select **[Overwrite]**.
- Select **[▶]** (2) to save a compressed version of the file. A separate version is saved, with 4K movies compressed and converted to Full HD.
- On the confirmation dialog, select **[OK]** to save the edited movie and return to the movie playback screen.



- Because editing is performed in approx. 1-sec. increments (at the position indicated by **[⌘]** at the bottom of the screen), the actual position where movies are trimmed may differ from your specified position.
- Movies shot with another camera cannot be edited with this camera.
- You cannot edit a movie when the camera is connected to a computer.
- **[▶]** is not available for movies created with **[Save compressed version]**, because further compression and saving is not possible.



- For instructions on editing video snapshot albums, see "Create Album" (📖297).

Frame Extraction

From 4K movies or 4K time-lapse movies, you can select individual frames to save as approx. 8.3 megapixel (3840×2160) JPEG still images. This function is called “Frame Grab (4K frame capture)”.

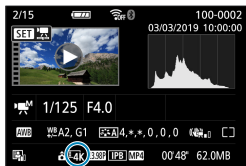

1 Play back the image.

- Press the <▶> button.

2 Select a 4K movie.

- Use the <◀> <▶> keys to select a 4K movie or 4K time-lapse movie.
- On the shooting information screen (📖 508), 4K movies and 4K time-lapse movies are indicated by an [4K] icon.
- In index display, press <SET> to switch to single-image display.

3 In the single-image display, press <SET>.

4 Pause movie playback.

- The movie playback panel will appear.



5 Select a frame to grab.

- Use the movie playback panel to select the frame to grab as a still photo.
- For movie playback panel instructions, see 📖 262.



6 Select [📷].

- Use the <◀> <▶> keys to select [📷].



7 Save the image.

- Select **[OK]** to save the current frame as a JPEG still image.

8 Select the image to display.

- Check the destination folder and image file number.
- Select **[View original movie]** or **[View extracted still image]**.



- Frame grabbing is not possible with Full HD movies, Full HD time-lapse movies, HD movies, or with 4K movies or 4K time-lapse movies from a different camera.

Digest Movie Editing

Individual chapters (clips) recorded in <[SET] [▶] [⏏]> mode can be erased. Be careful when erasing clips, because they cannot be recovered.



1 Play back the image.

- Press the <[▶]> button.

2 Select a digest movie.

- Use the <[◀]> <[▶]> keys to select the digest movie.
- In single-image display, digest movies are labeled with [SET [▶] [⏏]] in the upper left of the screen.
- In index display, press <SET> to switch to single-image display.

3 In the single-image display, press <SET>.



4 Select [▶] [⏏].

- Digest movie playback begins.



5 Press <SET> to pause the digest movie.

- The movie playback panel will appear.

6 Select a clip.

- Select [◀] or [▶] to select a clip.



7 Select [Erase].

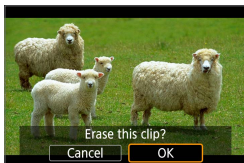

8 Select [OK].

- The clip is erased, and the digest movie is overwritten.



- Video snapshot albums can also be edited. Albums created with [Video Snapshot Album]: **Create album**] cannot be edited.
- For other instructions on using the movie playback panel for digest movies, see “Movie Playback Panel (Video Snapshot Albums and Digest Movies)” (263).

Playback on a TV Set

You can view your shots and movies on a TV by connecting the camera to a TV with an HDMI cable (not exceeding 2.5 m/8.2 ft., with a Type D terminal on the camera end).

If the image does not appear on the TV screen, check if the [**Video system**] is correctly set to [**For NTSC**] or [**For PAL**] (depending on the video system of your television).

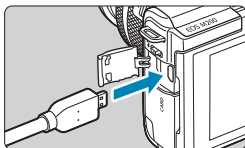

1 Connect the HDMI cable to the camera.

- Insert the cable plug in the <HDMI> terminal.

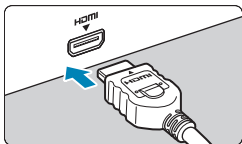

2 Connect the HDMI cable to the television.

- Connect the HDMI cable to the television's HDMI IN port.

3 Turn on the television and switch the television's video input to select the connected port.

4 Turn the camera on.

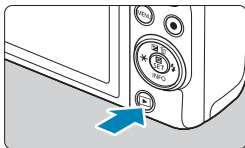

5 Press the <▶> button.

- The image will appear on the TV screen. (Nothing will be displayed on the camera screen.)
- The images will automatically be displayed at the optimum resolution matching the connected television.



- Adjust movie sound volume with the TV set. The sound volume cannot be adjusted with the camera.
- Before connecting or disconnecting the cable between the camera and television, turn off the camera and television.
- Depending on the television, part of the image displayed may be cut off.
- Do not connect any other device's output to the camera's <HDMI> terminal. Doing so may cause a malfunction.
- Certain televisions may not display the images due to incompatibility.
- It may take some time before images are displayed. To avoid delay, set [**⚙: HDMI resolution**] to [**1080p**] (📖 447).
- Touch-screen operations are not supported while the camera is connected to a television.

Protect Images

You can protect important images from being accidentally erased.

Protecting a Single Image

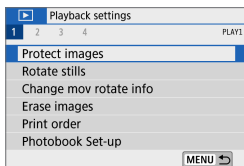

1 Select []: Protect images].

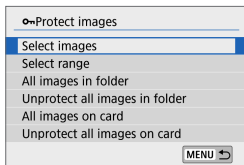

2 Select [Select images].

3 Select an image.

- Use the <<<> <>>> keys to select the image to protect.

4 Protect the image.

- Press <SET> to protect the selected image. The [] (1) will appear at the top of the screen.
- To cancel the image protection, press <SET> again. The [] icon will disappear.
- To protect another image, repeat steps 3 and 4.



Specifying the Range of Images to be Protected

While looking at the images in the index display, you can specify the first and last images for a range to protect all the specified images at once.

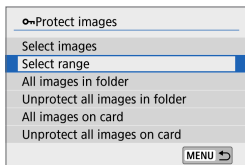

1 Select [Select range].

- Select [Select range] in [▶]: Protect images].

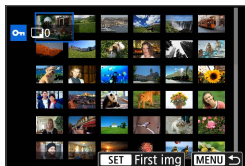

2 Specify the range of images.

- Select the first image (start point).
- Next, select the last image (end point).
- The images in the specified range will be protected and the [On] icon will appear.
- To select another image to be protected, repeat step 2.

Protecting All Images in a Folder or on a Card

You can protect all the images in a folder or on a card at once.

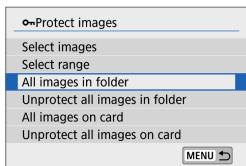

When you select **[All images in folder]** or **[All images on card]** in **[▶]: Protect images**, all the images in the folder or on the card will be protected.

To cancel the selection, select **[Unprotect all images in folder]** or **[Unprotect all images on card]**.

If the search conditions are set with **[▶]: Set image search conditions]** (📖 308), the display will change to **[All found images]** and **[Unprotect all found]**.

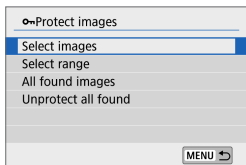

If you select **[All found images]**, all the images filtered by the search conditions will be protected.

If you select **[Unprotect all found]**, the protection of all the filtered images will be canceled.

● If you format the card (📖 433), the protected images will also be erased.

- Once an image is protected, it cannot be erased by the camera's erase function. To erase a protected image, you must first cancel the protection.
- If you erase all the images (📖 280), only the protected images will remain. This is convenient when you want to erase all unnecessary images at once.

Rotate Still Photos

You can use this feature to rotate the displayed image to the desired orientation.

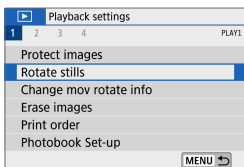

1 Select []: Rotate stills].

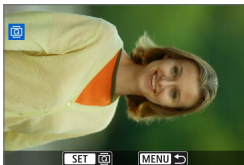

2 Select an image.



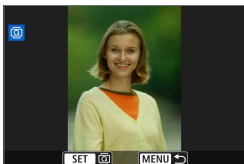



- Use the <<◀> <▶> keys to select the image to rotate.



3 Rotate the image.

- Each time you press <SET>, the image will rotate clockwise as follows: 90° → 270° → 0°.
- To rotate another image, repeat steps 2 and 3.



- If you set [: Auto rotate] to [On  ] ( 431) before taking vertical shots, you need not rotate the image with this function.
- If the rotated image is not displayed in the rotated orientation during image playback, set [: Auto rotate] to [On  ].

Change Movie Orientation Information

You can manually change movie orientation information (which determines which side is up).

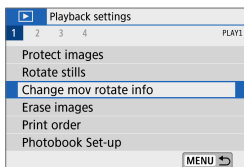

1 []: Change mov rotate info



2 Select a movie.

- Use the <◀> <▶> keys to select a movie with orientation information to change.



3 Press <SET>.

- As you watch the image orientation icon in the upper left of the screen, press <SET> to specify which side is up.

- Orientation information of digest movies and video snapshot albums cannot be changed.
- Movies are played horizontally on the camera, regardless of the []: Add ' rotate info] (432) setting.

Erase Images

You can either select and erase unnecessary images one by one or erase them in one batch. Protected images (🔒 272) will not be erased.



- Once an image is erased, it cannot be recovered. Make sure you no longer need the image before erasing it. To prevent important images from being erased accidentally, protect them.

Erasing a Single Image

1 Select the image to be erased.

- Press the <▶> button.
- Use the <◀> <▶> keys to select the image to erase.



2 Press the <🗑> button.



3 Erase the images.

JPEG or RAW images or movies

- Select [Erase].



RAW+JPEG images

- Select an item.

Checkmarking [✓] Images to Be Erased in a Batch

By adding checkmarks to the images to be erased, you can erase all those images at once.

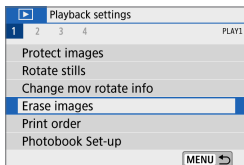

1 Select [: Erase images].

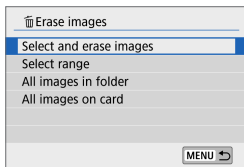

2 Select [Select and erase images].



3 Select an image.

- Use the <◀> <▶> keys to select the image to erase, then press <SET>.
- To select another image to be erased, repeat step 3.

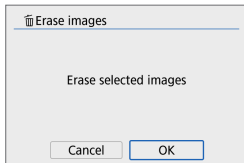

4 Erase the images.

- Press the <MENU> button, then press [OK].

Specifying the Range of Images to Be Erased

While looking at the images in the index display, you can specify the first and last images for a range to erase all the specified images at once.

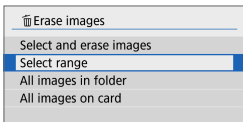

1 Select [Select range].

- Select [Select range] in [▶]: Erase images].

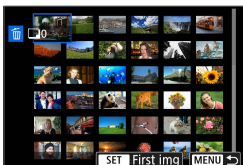

2 Specify the range of images.

- Select the first image (start point).
- Next, select the last image (end point).

3 Press the <MENU> button.

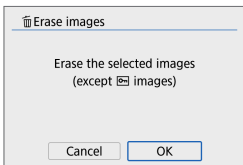

4 Erase the images.

- Select [OK].

Erasing All Images in a Folder or on a Card

You can erase all the images in a folder or on a card at once.

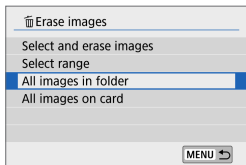

When [▶]: **Erase images** is set to [All images in folder] or [All images on card], all the images in the folder or on the card will be erased.

If the search conditions are set with [▶]: **Set image search conditions** (📖 308), the display will change to [All found images].

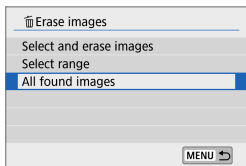

If you select [All found images], all the images filtered by the search conditions will be erased.



- To erase all the images including protected images, format the card (📖 433).

Prepare to Print

All operations in direct printing are performed on the camera, as you view screens for camera operations.

Connecting the Camera and Printer

1 Prepare the printer.

- For details, refer to the printer's instruction manual.

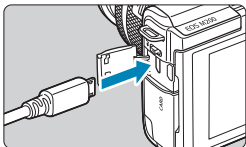

2 Connect the camera to the printer with an interface cable (sold separately).

- As an interface cable, you can use a IFC-600PCU cable (sold separately).
- Insert the cord's plug into the camera's digital terminal (USB Micro-B).
- Connect the cord's plug to the printer's USB terminal.

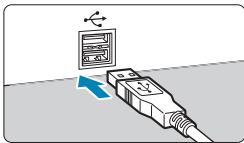

3 Turn the printer on.

4 Turn the camera on.

- Some printers may beep.
- The image is displayed, along with a printer connection icon in the upper left of the screen.



- ⚠ Confirm in advance that the printer has a PictBridge-compatible terminal.
- Movies cannot be printed.
- Printers only compatible with "CP Direct" or "Bubble Jet Direct" printing cannot be used.
- A series of long beeps in step 4 indicates a problem with the printer. Resolve the problem according to the error message displayed (📖 366).

- 📄 You can also print RAW images captured with this camera.
- When you use a battery to power the camera, make sure it is fully charged.
- Turn off the camera and printer before disconnecting the cable, and hold the cable by the plug when disconnecting it.
- For direct printing, consider powering the camera with DC Coupler DR-E12 and Compact Power Adapter CA-PS700 (each sold separately).

Print Images

The screen display and setting options vary depending on the printer. Also, certain settings may not be available. For details, refer to the printer's instruction manual.

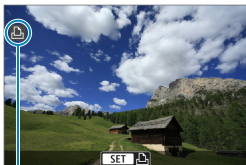

(1)

1 Select the image to be printed.

- Confirm that an icon is displayed in the upper left of the screen.
- Press the <◀> <▶> keys to select an image to print.

(1) Printer connected icon

2 Press <SET>.

- ➔ The print setting screen appears.
- For setting details, see "Print Settings" (📖 362).

Print Ordering

DPOF (Digital Print Order Format) enables you to print images recorded on the card according to your printing instructions such as the image selection, quantity to print, etc. You can print multiple images in one batch or create a print order for a photofinisher.

You can set the print settings such as print type, date imprinting, file number imprinting, etc. The print settings will be applied to all the images specified for printing. (They cannot be set individually for each image.)

Setting the Printing Option

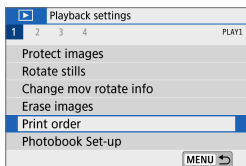

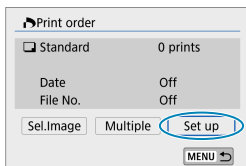

1 Select [: Print order].



2 Select [Set up].

3 Set the options as desired.

- Set the [Print type], [Date], and [File No.].

Print type	 Standard	Prints one image on one sheet.
	 Index	Multiple thumbnail images are printed on one sheet.
	 Both	Prints both the standard and index prints.
Date	On	[On] imprints the recorded date of the captured image.
	Off	
File number	On	[On] imprints the file number.
	Off	

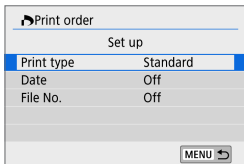

4 Exit the setting.

- Press the <MENU> button.
- Next, select [**Sel.Image**] or [**Multiple**] to specify the images to be printed.



- If you print an image with a large image size using the [**Index**] or [**Both**] setting (📖 284), the index print may not be printed with certain printers. In this case, resize the image (📖 302), then print the index print.
- Even if [**Date**] and [**File No.**] are set to [**On**], the date or file number may not be imprinted, depending on the print type setting and printer.
- With [**Index**] prints, the [**Date**] and [**File No.**] cannot both be set to [**On**] at the same time.
- When printing with DPOF, use the card for which print order specifications are set. You cannot print in the specified print order if you extract just the images from the card for printing.
- Certain DPOF-compliant printers and photofinishers may not be able to print the images as you specified. Refer to the printer's instruction manual before printing, or check with your photofinisher about compatibility when ordering prints.
- Do not use this camera to configure print settings for images with DPOF settings set up on another camera. All the print orders may be overwritten inadvertently. Also, the print order may not be possible, depending on the image type.

Specifying Images for Printing

Selecting Images

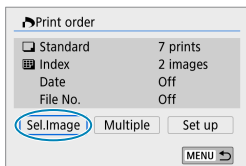

Select and specify the images one by one. Press the <MENU> button to save the print order to the card.



Standard/Both

Press <SET> to print a copy of the displayed image. By pressing the <▲> <▼> keys, you can set the number of copies to be printed up to 99.

- (1) Quantity
- (2) Total images selected



Index

Press <SET> to add a checkmark to the box [✓]. The image will be included in the index print.

- (3) Checkmark
- (4) Index icon

Selecting Multiple Images

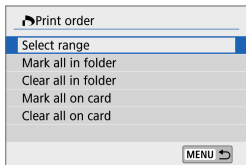

Select Range

Under [**Multiple**], select [**Select range**]. Selecting the first and last images of the range marks all the images in the range with a checkmark [✓], and one copy of each image will be printed.

- **All Images in a Folder**



Select [**Mark all in folder**] and select the folder. A print order for one copy of all the images in the folder will be specified.

If you select [**Clear all in folder**] and select the folder, the print order for all the images in the folder will be canceled.

- **All Images on a Card**

If you select [**Mark all on card**], one copy of all the images on the card will be specified for printing.

If you select [**Clear all on card**], the print order will be cleared for all the images on the card.

If the search conditions are set with []: **Set image search conditions** ( 308) and you select [**Multiple**], the display will change to [**Mark all found images**] and [**Clear all found images**].

- **All Found Images**

If you select [**Mark all found images**], one copy of all the images filtered by the search conditions will be specified for printing.

If you select [**Clear all found images**], all the print order of the filtered images will be cleared.



- RAW images or movies cannot be specified for printing. Note that RAW images or movies will not be specified for printing even if you specify all images with [**Multiple**].
- When using a PictBridge-compatible printer, do not specify more than 400 images for one print order. If you specify more than this, the images may not all be printed.

Photobook Set-up

You can specify up to 998 images to be printed in a photobook.

When you use EOS Utility (EOS software) to import images to a computer, the specified images for a photobook will be copied to a dedicated folder.

This function is useful for ordering photobooks online.

Specifying One Image at a Time

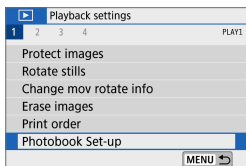

1 Select [: Photobook Set-up].

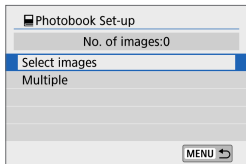

2 Select [Select images].



3 Select the image to be specified.

- Use the <◀> <▶> keys to select an image, then press <SET>.
- To select other images to be specified for a photobook, repeat step 3.

Specifying the Image Range for a Photobook

While looking at the images in the index display, you can specify the range (start point to end point) of images to be specified for a photobook at once.

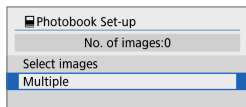

1 Select [Multiple].

- Under [▶]: Photobook Set-up], select [Multiple].

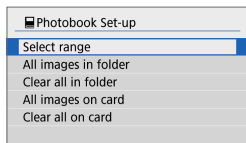

2 Select [Select range].

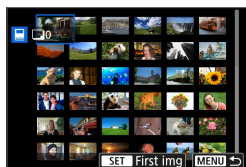

3 Specify the range of images.

- Select the first image (start point).
- Next, select the last image (end point).
- A checkmark [✓] will be appended to all the images within the range between first and last images.

Specifying All Images in a Folder or on a Card

You can specify all the images in a folder or on a card at once for a photobook.

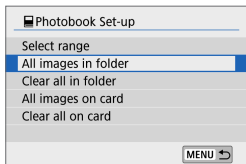

Under [**▶**]: **Photobook Set-up**], you can set [**Multiple**] to [**All images in folder**] or [**All images on card**] to specify all the images in the folder or on the card for a photobook.

To cancel the selection, select [**Clear all in folder**] or [**Clear all on card**].

If the search conditions are set with [**▶**]: **Set image search conditions**] (**308**) and you select [**Multiple**], the display will change to [**All found images**] and [**Clear all found images**].

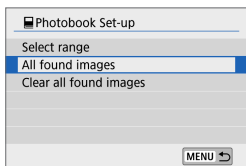

If you select [**All found images**], all the images filtered by the search conditions will be specified for the photobook.

If you select [**Clear all found images**], all the photobook order of the filtered images will be cleared.

- RAW images or movies cannot be specified for the photobook. Note that RAW images or movies will not be specified for the photobook even if you specify all images with [**Multiple**].
- Do not use this camera to configure photobook settings for images with photobook settings set up on another camera. All the photobook settings may be overwritten inadvertently.

Creative Filters

You can apply the following filter processing to an image and save it as a separate image: Grainy B/W, Soft focus, Fish-eye effect, Art bold effect, Water painting effect, Toy camera effect, and Miniature effect.

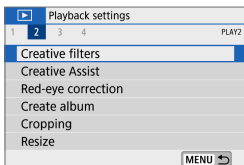

1 Select []: Creative filters].

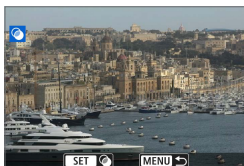

2 Select an image.

- Use the <◀> <▶> keys to select images, then press <SET>.
- You can turn the <☀> dial counterclockwise to select images from index display.



3 Select a filter effect (292).



4 Adjust the filter effect.

- Adjust the filter effect, then press <SET>.
- For the Miniature effect, press the <▲> <▼> <◀> <▶> keys to move the white frame indicating the area that looks sharp, then press <SET>.

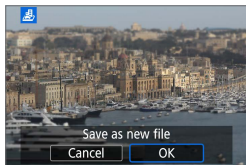

5 Save the image.

- Select **[OK]**.
- Check the destination folder and image file number displayed, then select **[OK]**.
- To apply filter processing to other images, repeat steps 2–5.



- For images captured in RAW+JPEG shooting, filter processing is applied to the RAW image, and the results are saved as a JPEG.
- For RAW images captured at a specific aspect ratio, the resulting image is saved at that aspect ratio after filter processing.

Creative Filter Characteristics

● **Grainy B/W**

Makes the image grainy and black and white. By adjusting the contrast, you can change the black-and-white effect.

● **Soft focus**

Gives the image a soft look. By adjusting the blur, you can change the degree of softness.

● **Fish-eye effect**

Gives the effect of a fish-eye lens. The image will have barrel distortion. Depending on the level of this filter effect, the area trimmed along the periphery of the image changes. Also, because this filter effect magnifies the center of the image, the apparent resolution at the center may degrade depending on the number of recorded pixels, so set the filter effect in step 4 while checking the resulting image.

-  **Art bold effect**

Makes the photo look like an oil painting and the subject look more three-dimensional. By adjusting the effect, you can change the contrast and saturation. Note that subjects such as the sky or white walls may not be rendered with a smooth gradation and may look irregular or have significant noise.

-  **Water painting effect**

Makes the photo look like a watercolor painting with soft colors. By adjusting the effect, you can change the color density. Note that night scenes or dark scenes may not be rendered with a smooth gradation and may look irregular or have significant noise.

-  **Toy camera effect**

Shifts colors to those typical of toy cameras and darkens the four corners of the image. Color tone options can be used to change the color cast.

-  **Miniature effect**

Creates a diorama effect. You can change where the image looks sharp. To switch between vertical and horizontal orientation of the sharp area (white frame), tap  at the bottom of the screen in step 4.

Creative Assist

You can process RAW images by applying your preferred effects and saving as JPEGs.

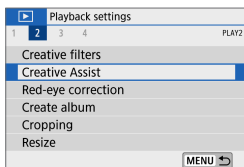

1 Select [▶]: Creative Assist].



2 Select an image.

- Use the <◀> <▶> keys to select images to process, then press <SET>.



3 Select an effect level.

- Use the <◀> <▶> keys to select the effect.
- By selecting **[Preset]** and pressing <SET>, you can choose **[VIVID]**, **[SOFT]**, or other preset effects. **[AUTO1]**, **[AUTO2]**, and **[AUTO3]** are effects recommended by the camera based on image conditions.



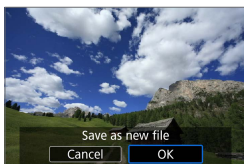

- You can adjust effects such as **[Brightness]** or **[Contrast]** by pressing **<SET>** and then using the **<◀>** **<▶>** keys.
- Press **<SET>** when adjustment is finished.
- To reset the effect, tap **[Reset]**.
- To confirm the effect, tap **[Save]** in the upper right of the screen.

4 Save the image.

- Select **[OK]**.



- For details on Creative Assist effects, see 78.

Red-Eye Correction

Automatically corrects portions of images affected by red-eye from flash.

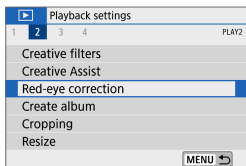

1 Select [: Red-eye correction].

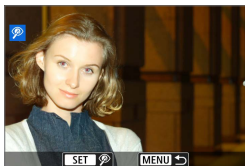

2 Select an image with <<> <>>.

- After image selection, either tap [] or press <SET>.
- White frames are displayed around corrected image areas.

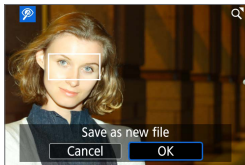

3 Save the image.

- Select [OK].
- The image is saved as a separate file.



- Some images may not be corrected accurately.

Create Album

You can rearrange, delete, or play back the video snapshots in an album.

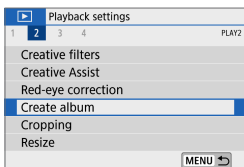

1 Select []: **Create album**].



2 Select an album to edit.

- Press <SET> to add a checkmark [✓].
- After selection, press the <MENU> button.

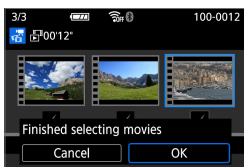

3 Select [OK].



4 Select an editing option.

Option	Description
↔ Rearrange video snapshots	Use the <◀> <▶> keys to select a video snapshot to move, then press <SET>. Use the <◀> <▶> keys to move it, then press <SET>.
🗑️ Remove video snapshot	Use the <◀> <▶> keys to select a video snapshot to delete, then press <SET>. Selected video snapshots are labeled [🗑️]. To clear the selection and remove [🗑️], press <SET> again.
▶ Play video snapshot	Use the <◀> <▶> keys to select a video snapshot to play, then press <SET>. Use the <▲> <▼> keys to adjust the volume.



5 Finish editing.

- Press the <MENU> button when you are finished editing.
- Select [↔] (Finish editing).

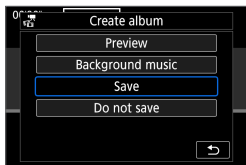

6 Save the image.

- To check your editing, select [**Preview**].
- To play an album with background music, use [**Background music**] to select the music (📖 299).
- Selecting [**Save**] saves the edited album as a new album.



- Video snapshot albums can only be edited once.

Selection of Background Music

Albums and slideshows can be played with background music once you copy the music to the card, using EOS Utility (EOS software).

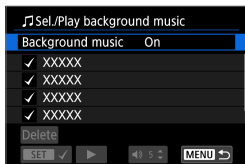

- 1 **Select [Background music].**
 - Set **[Background music]** to **[On]**.

- 2 **Select the background music.**
 - Use the <▲> <▼> keys to select the music, then press <SET>. For **[Slide show]**, you can select multiple tracks.

- 3 **Listen to a sample.**
 - To listen to a sample, tap **[▶]**.
 - Use the <▲> <▼> keys to adjust the volume. Tap **[■]** to stop playback.
 - To delete the music, use the <▲> <▼> keys to select it, then tap **[Delete]**.



- For instructions on copying background music to cards, refer to the EOS Utility Instruction Manual.

Cropping

You can crop a captured JPEG image and save it as another image. Cropping an image is possible only with JPEG images. Images shot in RAW cannot be cropped.

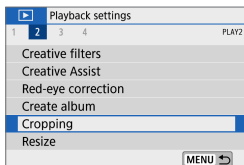

1 Select [: Cropping].



2 Select an image.

- Use the <<> <>> keys to select the image to crop.



3 Set the cropping frame.

- Press <SET> to display the cropping frame.
- The image area within the cropping frame will be cropped.

● Changing the Cropping Frame Size

You can adjust the frame size by pinching in or out on the screen. The smaller the cropping frame, the more magnified the cropped image will look.

● Moving the Cropping Frame

Press the <⬆> <⬇> <⬇> <⬆> cross keys to move the frame vertically or horizontally. Move the cropping frame until it covers the desired image area.

● Correcting the Tilt

You can correct image tilt by $\pm 10^\circ$. Turn the dial to select dial (in 0.1° increments) or tap the left or right wedge (in 0.5° increments) on the upper left of the screen to correct the tilt. After completing the tilt correction, press <SET>.

● Changing the Aspect Ratio and Orientation

Turn the dial to select



4 Check the image area to be cropped.

- Turn the dial to select .
- The image area to be cropped will be displayed.

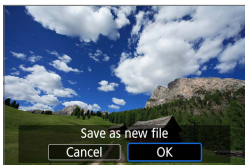

5 Save the image.

- Turn the dial to select .
- Select **[OK]** to save the cropped image.
- Check the destination folder and image file number, then select **[OK]**.
- To crop another image, repeat steps 2 to 5.



- The position and size of the cropping frame may change depending on the angle set for tilt correction.
- Once a cropped image is saved, it cannot be cropped again or resized.
- AF point display information (314) will not be appended to the cropped images.

Resizing

You can resize a JPEG image to make the pixel count lower and save it as a new image. Resizing an image is possible only with JPEG **L**, **M**, and **S1** images. JPEG **S2** and RAW images cannot be resized.

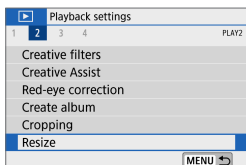

1 Select []: Resize].



2 Select an image.

- Use the <<> <>> keys to select the image to resize.



3 Select the desired image size.

- Press <SET> to display the image sizes.
- Select the desired image size (1).

(1)

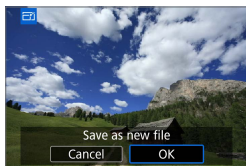

4 Save the image.

- Select [**OK**] to save the resized image.
- Check the destination folder and image file number, then select [**OK**].
- To resize another image, repeat steps 2 to 4.



● For details on image sizes of resized images, see 500.

Rating

You can rate images on a scale of 1–5 ([★]/[★]/[★★]/[★★★]/[★★★★]). This function is called rating.

* Rating images can help you organize them.

Rating a Single Image

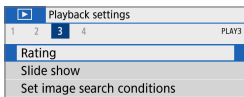

1 Select [▶]: Rating].

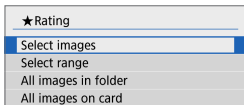

2 Select [Select images].



3 Select the image to be rated.

- Use the <<◀> <▶> keys to select the image to rate.



4 Rate the image.

- Press <SET>, and a blue highlight frame will appear as shown in the screen shown on the left.
- Use the <▲> <▼> keys to select a rating mark, then press <SET>.
- When you append a rating mark to the image, the number beside the set rating will increase by one.
- To rate another image, repeat steps 3 and 4.

Rating by Specifying the Range

While looking at the images in the index display, you can specify the first and last images for a range to rate all the specified images at once.

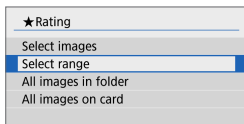

1 Select [Select range].

- Select [Select range] in [▶]: Rating].

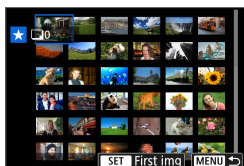

2 Specify the range of images.

- Select the first image (start point).
- Next, select the last image (end point).
- A checkmark [✓] will be appended to all the images within the range between first and last images.

3 Press the <MENU> button.

4 Rate the image.

- Turn the <☀> dial to select a rating mark, then select [OK].
- All the images in the specified range will be rated (same rating) at once.

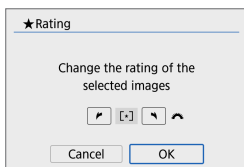

Rating All Images in a Folder or on a Card

You can rate all the images in a folder or on a card at once.

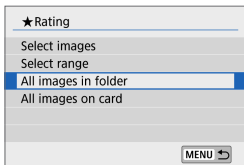

Under [**▶**]: **Rating**], when you select [**All images in folder**] or [**All images on card**], all the images in the folder or on the card will be rated.



Turn the <☀> dial to select a rating, then select [**OK**].

When you are not rating images or cancelling the rating, select [**OFF**].

If the search conditions are set with [**▶**]: **Set image search conditions**] (📖 308), the display will change to [**All found images**].

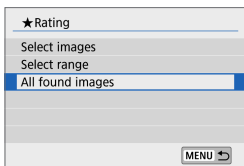

If you select [**All found images**], all the images filtered by the search conditions will be rated as specified.



- Values next to ratings are displayed as **###** if more than 1,000 images have that rating.
- With [**▶**]: **Set image search conditions**] and [**▶**]: **Image jump with** 🖱️], you can display only the images given a specific rating.

Slide Shows

You can play back the images on the card as an automatic slide show.

1 Specify the images to be played back.

- To play back all the images on the card, go to step 2.
- If you want to specify the images to be played back in the slide show, filter the images with [▶]: **Set image search conditions**] (📖 308).

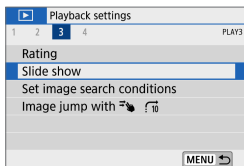

2 Select [▶]: Slide show].

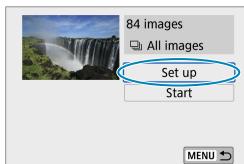

3 Set the playback as desired.

- Select [Set up].
- Set the [Display time], [Repeat] (repeated playback), and [Transition effect] (effect when changing images) for the still photos.
- To play background music, use [Background music] to select the music (📖 299).
- After completing the settings, press the <MENU> button.

Display time



Repeat

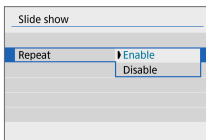

Transition effect

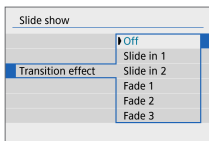

Background music

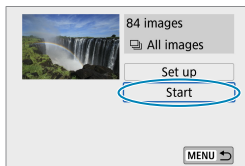
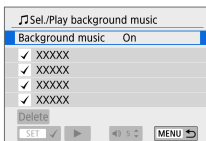

4 Start the slide show.

- Select **[Start]**.

After **[Loading image...]** is displayed, the slide show will start.

5 Exit the slide show.

- To exit the slide show and return to the setting screen, press the **<MENU>** button.



- To pause the slide show, press **<SET>**. During pause, **[III]** will be displayed on the upper left of the image. Press **<SET>** again to resume the slide show.
- Volume during movie playback can be adjusted by pressing the **<▲>** **<▼>** keys.
- During auto playback or pause, you can press the **<◀>** **<▶>** keys to view another image.
- During auto playback, auto power off will not take effect.
- The display time may differ depending on the image.

Set Image Search Conditions

You can filter image display according to your search conditions. After setting the image search conditions, you can play back and display only the found images.

You can also protect, rate, play a slide show, erase, and apply other operations to filtered images.

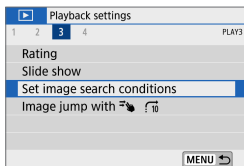

1 Select []: Set image search conditions].

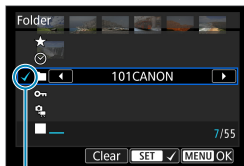

(1)

2 Set the search conditions.

- Use the <▲> <▼> keys to select an item.
- Use the <◀> <▶> keys to set the setting. A checkmark [] (1) is appended to the left of the item. (Specified as the search condition.)
- If you select the item and press <SET>, the checkmark [] will be removed. (The search condition is canceled.)
- To clear all specified search conditions, tap [**Clear**].

Item	Description
★ Rating	Displays images with the selected (rating) condition.
☺ Date	Displays images taken on the selected shooting date.
📁 Folder	Displays images in the selected folder.
🔒 Protect	Displays images with the selected (protect) condition.
📄 Type of file	Displays images in the selected file type.

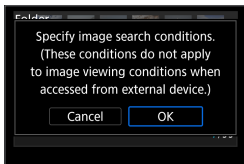

3 Apply the search conditions.

- Press the <MENU> button and read the message displayed.
- Select [OK].
- The search condition is specified.

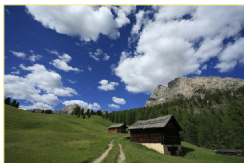

(2)

4 Display the found images.

- Press the <▶> button.
- Only the images that match the set conditions (filtered) will be played back.
- When the images are filtered for display, the screen will have an outer yellow frame (2).

Image Jump by Swiping

In single-image display, you can swipe left or right with two fingers to jump forward or back through images according to the jump method set.

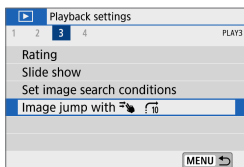



1 Select [▶]: Image jump with .



2 Select the jump method.



- With [Jump images by the specified number], you can turn the < > dial to select the number of images to jump by.
- When you select [Display by image rating], turn the < > dial to specify the rating ( 303). If you browse images with ★ selected, all the rated images will be displayed.

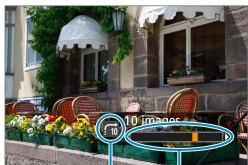

(1)

(2)

3 Browse by jumping.

- Press the <▶> button.
- In single-image display, swipe left or right with two fingers.
- You can browse by the set method.

(1) Jump method

(2) Playback position



- To search images by shooting date, select [: **Date**].
- To search images by folder, select [: **Folder**].
- If the card contains both movies and still photos, select [: **Movies**] or [: **Stills**] to display one or the other.

Playback Information Display

You can specify screens and accompanying information displayed during image playback.

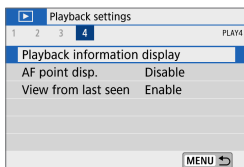

1 Select []: Playback information display].

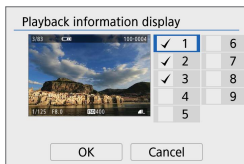

2 Add a checkmark [✓] next to the number of screens to display.

- Use the <▲> <▼> keys to select a number.
- Press <SET> to add a checkmark [✓].
- Repeat these steps to add a checkmark [✓] to the number of each screen to display, then select [OK].
- Your selected information can be accessed by pressing the <INFO> button during playback.

Histogram

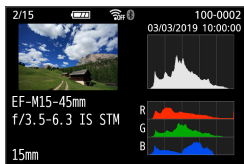

The brightness histogram shows the exposure level distribution and overall brightness. The RGB histogram is for checking the color saturation and gradation.

● [Brightness] display

This histogram is a graph showing the distribution of the image's brightness level. The horizontal axis indicates the brightness level (darker on the left and brighter on the right) while the vertical axis indicates how many pixels exist for each brightness level. The more pixels there are toward the left, the darker the image. The more pixels there are toward the right, the brighter the image. If there are too many pixels on the left, the shadow detail will be lost. If there are too many pixels on the right, the highlight detail will be lost. The gradation in-between will be reproduced. By checking the image and its brightness histogram, you can see the exposure level inclination and the overall gradation.

Sample Histograms



Dark image



Normal brightness



Bright image

● [RGB] display

This histogram is a graph showing the distribution of each primary color's brightness level in the image (RGB or red, green, and blue). The horizontal axis indicates the color's brightness level (darker on the left and brighter on the right), while the vertical axis indicates how many pixels exist for each color brightness level. The more pixels there are toward the left, the darker and less prominent the color. The more pixels there are toward the right, the brighter and denser the color. If there are too many pixels on the left, the respective color information will be lacking. If there are too many pixels on the right, the color will be too saturated with no gradation. By checking the image's RGB histogram, you can see the color's saturation and gradation condition, as well as white balance inclination.

AF Point Display

You can display the AF points that were used to focus, which will be outlined in red on the playback screen. If automatic AF point selection is set, multiple AF points may be displayed.

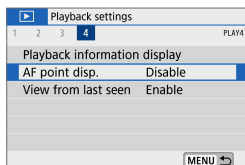

1 Select []: AF point disp.].

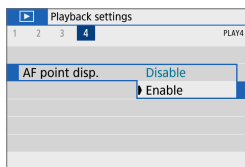

2 Select [Enable].

View from Last Seen

You can specify which image is displayed first when you start image playback.

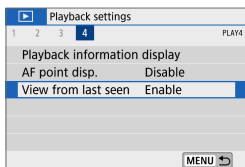

1 Select [▶]: **View from last seen**.

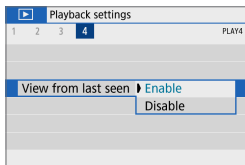

2 Select an item.

- **[Enable]**: Playback resumes from the last image displayed (except when you have just finished shooting).
- **[Disable]**: Playback resumes from your most recent shot whenever the camera is restarted.

Wireless Settings

This chapter describes how to connect the camera to a smartphone wirelessly via Bluetooth® or Wi-Fi® and send images to devices or Web services, how to control the camera from a computer or wireless remote control, and other operations.



Important

Note that Canon cannot be held liable for any loss or damage from erroneous wireless communication settings when using the camera. In addition, Canon cannot be held liable for any other loss or damage caused by use of the camera.

When using wireless communication functions, establish appropriate security at your own risk and discretion. Canon cannot be held liable for any loss or damage caused by unauthorized access or other security breaches.

Tab Menus: Wireless Settings

● Wireless settings 1

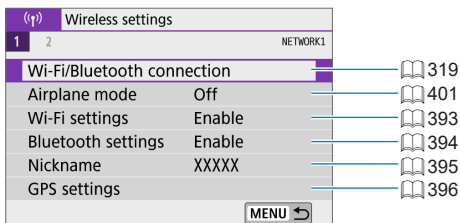

● Wireless settings 2

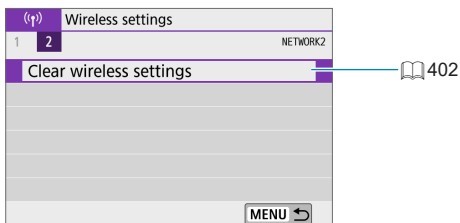

- Wireless communication is not available while the camera is connected via an interface cable to a computer or other device.
- Other devices, such as computers, cannot be used with the camera by connecting them with an interface cable while the camera is connected to devices via Wi-Fi.
- The camera cannot be connected via Wi-Fi if there is no card in the camera (except for [L]). Also, for [D] and Web services, the camera cannot be connected via Wi-Fi if there are no images saved on the card.
- The Wi-Fi connection will be terminated if you turn off the camera, or open the card slot cover or battery compartment cover.
- With a Wi-Fi connection established, the camera's auto power off does not function.

Selection of Wi-Fi/Bluetooth Connection

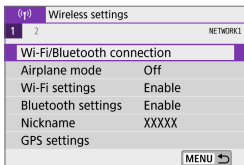

1 Select [ⓘ]: Wi-Fi/Bluetooth connection].



2 Select an item for the camera to connect to.

☎ Connect to smartphone (📖 321)

Control the camera remotely and browse images on the camera over a Wi-Fi connection by using the dedicated Camera Connect app on smartphones or tablets (collectively referred to as “smartphones” in this manual).

💻 Use with EOS software or other dedicated software (📖 349)

Connect the camera to a computer via Wi-Fi and operate the camera remotely using EOS Utility (EOS software). With the dedicated application Image Transfer Utility 2, images on the camera can also be sent to a computer automatically.

🖨 Print from Wi-Fi printer (📖 357)

Connect the camera to a printer supporting PictBridge (Wireless LAN) via Wi-Fi to print images.

 **Upload to Web service** (📖 367)

Share images with friends or family on social media or the CANON iMAGE GATEWAY online photo service for Canon customers after you complete member registration (free of charge).

 **Connect to Wireless Remote** (📖 387)

This camera can also be connected to Wireless Remote Control BR-E1 (sold separately) via Bluetooth for remote control shooting.

Connecting to a Smartphone

You can do the following after pairing the camera with a smartphone compatible with Bluetooth low energy technology (hereafter, “Bluetooth”).

- Establish a Wi-Fi connection using only the smartphone (📖 323).
- Establish a Wi-Fi connection with the camera even when it is off (📖 328).
- Geotag images with GPS information acquired by the smartphone (📖 396).
- Control the camera remotely from a smartphone (📖 327).

You can also do the following after connecting the camera to a smartphone via Wi-Fi.

- Browse and save images on the camera from a smartphone (📖 327).
- Control the camera remotely from a smartphone (📖 327).
- Send images to a smartphone from the camera (📖 336).

Turning on Bluetooth and Wi-Fi on a Smartphone

Turn on Bluetooth and Wi-Fi from the smartphone settings screen. Note that pairing with the camera is not possible from the smartphone’s Bluetooth settings screen.



- To establish a Wi-Fi connection via an access point, see “Wi-Fi Connection via Access Points” (📖 382).

Installing Camera Connect on a Smartphone

The dedicated app Camera Connect (free of charge) must be installed on the smartphone on which Android or iOS is installed.

- Use the latest version of the smartphone OS.
- Camera Connect can be installed from Google Play or App Store. Google Play or App Store can also be accessed using the QR codes that appear when the camera is paired or connected via Wi-Fi to a smartphone.



- For the operating system versions supported by Camera Connect, refer to the download site of Camera Connect.
- Sample screens and other details in this guide may not match the actual user interface elements after camera firmware updates or updates to Camera Connect, Android, or iOS.

Connecting to a Bluetooth-compatible Smartphone via Wi-Fi

Steps on the Camera (1)

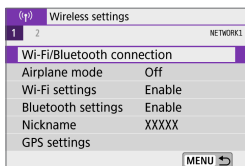

1 Select [**(P)**]: **Wi-Fi/Bluetooth connection**.

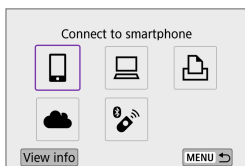

2 Select [**☎** **Connect to smartphone**].

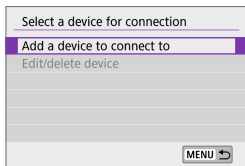

3 Select [**+** **Add a device to connect to**].

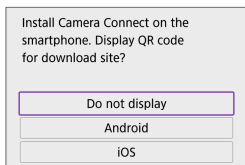

4 Select an item.

- If Camera Connect is already installed, select [**Do not display**].
- If Camera Connect is not installed, select [**Android**] or [**iOS**], scan the displayed QR code with the smartphone to access Google Play or App Store and install Camera Connect.



5 Select [Pair via Bluetooth].

- Pairing now begins.

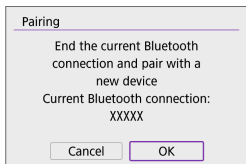

- To pair with a different smartphone after pairing with one initially, select **[OK]** on the screen at left.

Steps on the Smartphone (1)



6 Start Camera Connect.

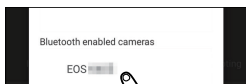

7 Tap the camera for pairing.

- If you are using an Android smartphone, go to step 9.

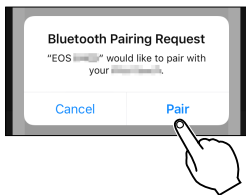

8 Tap on [Pair] (iOS only).

Steps on the Camera (2)

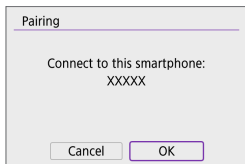

9 Select [OK].

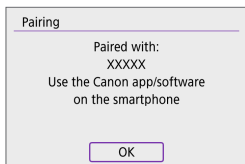

10 Press <SET>.

- Pairing is now complete, and the camera is connected to the smartphone via Bluetooth.

A Bluetooth icon appears on the main Camera Connect screen.

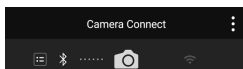

- The camera cannot be connected to two or more smartphones at the same time via Bluetooth. To switch to a different smartphone for the Bluetooth connection, see [399](#).
- Bluetooth connection consumes battery power even after the camera's auto power off is activated. Therefore, the battery level may be low when you use the camera.

Troubleshooting Pairing

- Keeping pairing records for previously paired cameras on your smartphone will prevent it from pairing with this camera. Before you try pairing again, remove pairing records for previously paired cameras from your smartphone's Bluetooth settings screen.



- With a Bluetooth connection established, you can operate the camera to send images to the smartphone ([336](#)).

Steps on the Smartphone (2)

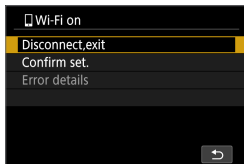
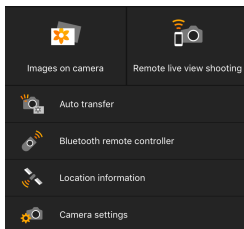

11 Tap on a Camera Connect function.

- In iOS, tap **[Join]** when a message is displayed to confirm camera connection.
- For the Camera Connect functions, see [327](#).
- When a Wi-Fi connection is established, the screen for the selected function will appear.
- **[Wi-Fi on]** is displayed on the camera.
- The Bluetooth and Wi-Fi icons are lit on the main Camera Connect screen.

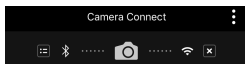

The Wi-Fi connection to a Bluetooth-compatible smartphone is now complete.

- For how to terminate the Wi-Fi connection, see “Terminating Wi-Fi Connections” ([344](#)).
- Terminating the Wi-Fi connection will switch the camera to the Bluetooth connection.
- To reconnect via Wi-Fi, start Camera Connect and tap the function you will use.

[Wi-Fi on] Screen

Disconnect,exit

- Terminates the Wi-Fi connection.

Confirm set.

- You can check the settings.

Error details

- When a Wi-Fi connection error occurs, you can check the details of the error.

Camera Connect Functions

Images on camera

- Images can be browsed, deleted, or rated.
- Images can be saved on a smartphone.

Remote live view shooting

- Enables remote shooting as you view a live image on the smartphone.

Auto transfer

- Enables camera and app setting adjustment to send shots to a smartphone automatically as they are captured (📖 335).

Bluetooth remote controller

- Enables remote control of the camera from a smartphone paired via Bluetooth. (Not available when connected via Wi-Fi.)
- Auto power off is disabled while you are using the Bluetooth remote controller feature.

Location information

- Not supported on this camera.

Camera settings

- Camera settings can be changed.

Maintaining a Wi-Fi Connection When the Camera Is Off

Even when the camera is off, as long as it is paired to a smartphone via Bluetooth, you can use the smartphone to connect via Wi-Fi.

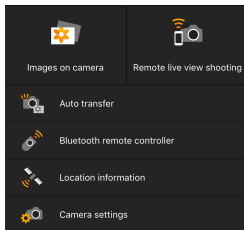

- Even if the camera is off, tapping **[Images on camera]** in the Camera Connect menu starts a Wi-Fi connection.
- In iOS, tap **[Join]** when a message is displayed to confirm camera connection. Images on the camera are listed when the Wi-Fi connection is established.

- You can use Camera Connect to save images to the smartphone, and you can delete images on the camera.
- To terminate the Wi-Fi connection, tap on **[X]** on the main Camera Connect screen (📖 344).

- ⚠️ ● This function can no longer be used if the wireless settings are reset or the smartphone connection information is erased.

Canceling the Pairing

Cancel pairing with a smartphone as follows.

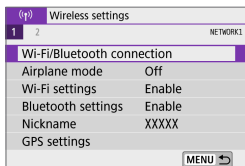

1 Select [()]: Wi-Fi/Bluetooth connection].

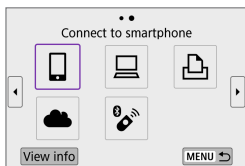

2 Select [Connect to smartphone].

- If the history (390) is displayed, switch the screen with the <<> <>> keys.

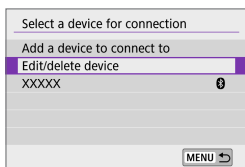

3 Select [Edit/delete device].

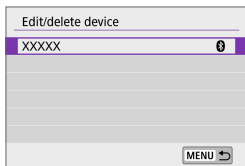

4 Select the smartphone to cancel pairing with.

- Smartphones currently paired with the camera are labeled [].

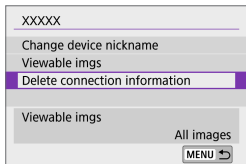

5 Select [Delete connection information].

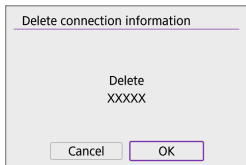

6 Select [OK].

7 Clear the camera information on the smartphone.

- In the smartphone's Bluetooth setting menu, clear the camera information registered on the smartphone.

Wi-Fi Connection Without Using Bluetooth

Steps on the Camera (1)

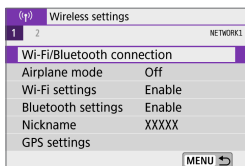

1 Select [**⌘**]: **Wi-Fi/Bluetooth connection**].

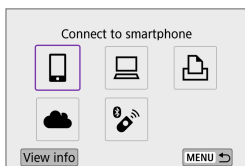

2 Select [**📱 Connect to smartphone**].

- If the history (**📖 390**) is displayed, switch the screen with the **<◀▶>** keys.

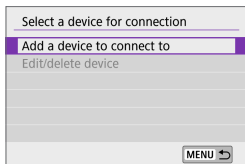

3 Select [**Add a device to connect to**].

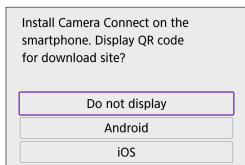

4 Select an item.

- If Camera Connect is already installed, select [**Do not display**].

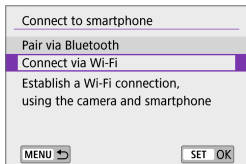

5 Select [Connect via Wi-Fi].

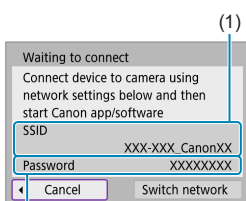

6 Check the SSID (network name) and password.

- Check the SSID (1) and password (2) displayed on the camera screen.
- In **[Wi-Fi settings]**, if you set **[Password]** to **[None]**, the password will not be displayed or required (📖 393).

- By selecting **[Switch network]** in step 6, you can establish a Wi-Fi connection via an access point (📖 382).

Steps on the Smartphone

Smartphone's screen (sample)



7 Operate the smartphone to establish a Wi-Fi connection.

- Activate the smartphone's Wi-Fi function, then tap the SSID (network name) checked in step 6.
- For the password, enter the password checked in step 6.

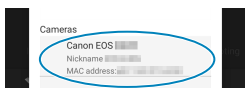

8 Start Camera Connect and tap the camera to connect to via Wi-Fi.

Steps on the Camera (2)

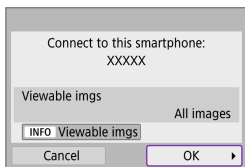

9 Select [OK].

- To specify viewable images, press the <INFO> button. See step 5 on 346 to set them.

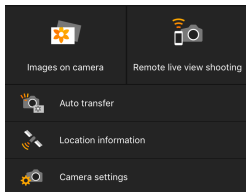

- The main window of Camera Connect will be displayed on the smartphone.

The Wi-Fi connection to a smartphone is now complete.

- Operate the camera using Camera Connect (📖 327).
- For how to terminate the Wi-Fi connection, see “Terminating Wi-Fi Connections” (📖 344).
 - To reconnect via Wi-Fi, see “Reconnecting via Wi-Fi” (📖 390).
-  ● When connected via Wi-Fi, you can send images to a smartphone from the Quick Control screen during playback (📖 336).

Automatic Image Transfer as You Shoot

Your shots can be automatically sent to a smartphone. Before following these steps, make sure the camera and smartphone are connected via Wi-Fi.

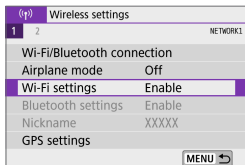

1 Select [(Wi-Fi icon): Wi-Fi settings].

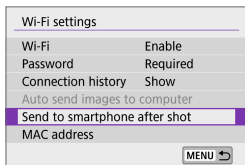

2 Select [Send to smartphone after shot].

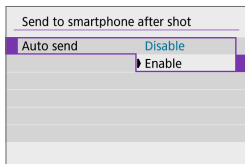

3 In [Auto send], select [Enable].

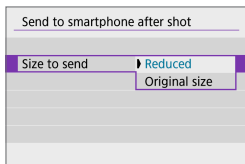

4 Set [Size to send].

5 Take the picture.

Sending Images to a Smartphone from the Camera

You can use the camera to send images to a smartphone paired via Bluetooth (Android devices only) or connected via Wi-Fi.



1 Play back the image.

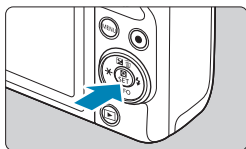

2 Press the <Q> button.

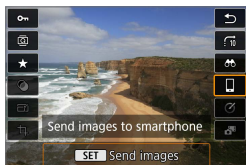

3 Select [ Send images to smartphone].

- If you perform this step while connected via Bluetooth, a message is displayed, and the connection switches to a Wi-Fi connection.

4 Select sending options and send the images.

(1) Sending Images Individually



1 Select an image to send.

- Use the <◀> <▶> keys to select images to send, then press <SET>.
- You can turn the <☀> dial counterclockwise to select images from index display.

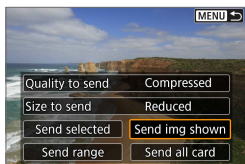

2 Select [Send img shown].

- In [Size to send], you can select the image sending size.
- When sending movies, you can select the image quality of movies to send in [Quality to send].

(2) Sending Multiple Selected Images



1 Press <SET>.

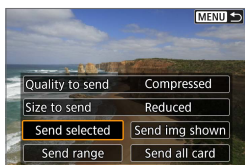

2 Select [Send selected].



3 Select images to send.

- Use the <◀> <▶> keys to select images to send, then press <SET>.

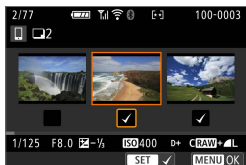

- You can turn the <☀> dial counterclockwise to select images from index display.
- After selecting the images to send, press the <MENU> button.

4 Exit image selection.

- Select [OK].

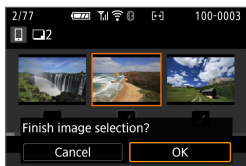

5 Select [Size to send].

- On the displayed screen, select an image size.

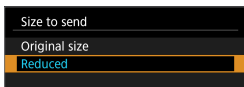
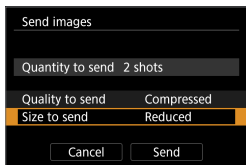

- When sending movies, select the image quality in [Quality to send].

6 Select [Send].

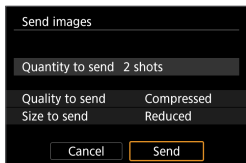

(3) Sending a Specified Range of Images



1 Press <SET>.

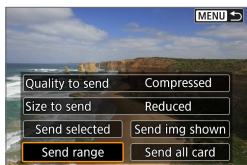

2 Select [Send range].

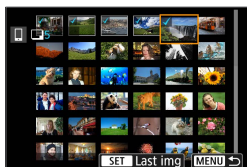

3 Specify the range of images.

- Select the first image (start point).
- Select the last image (end point).
- To cancel the selection, repeat this step.
- You can turn the <☀> dial to change the number of images shown in the index display.

4 Confirm the range.

- Press <SET>.

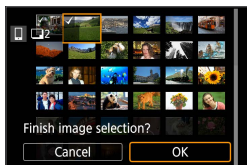

5 Exit image selection.

- Press the <MENU> button, then press [OK].

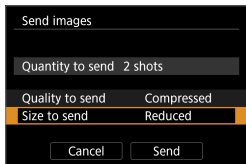

6 Select [Size to send].

- On the displayed screen, select an image size.

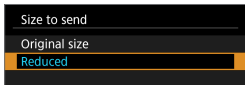

- When sending movies, select the image quality in [Quality to send].

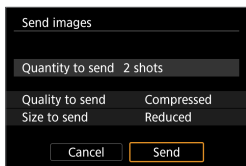

7 Select [Send].

(4) Sending All Images on the Card



1 Press <SET>.

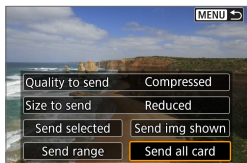

2 Select [Send all card].

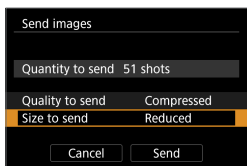

3 Select [Size to send].

- On the displayed screen, select an image size.

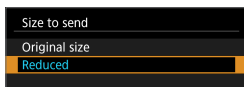

- When sending movies, select the image quality in [Quality to send].

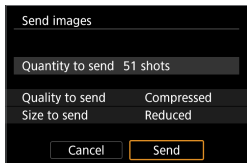

4 Select [Send].

(5) Sending Images that Match the Search Conditions

Send all the images that match the search conditions set in **[Set image search conditions]** at once.

For **[Set image search conditions]**, refer to “Set Image Search Conditions” (📖 308).



1 Press <SET>.

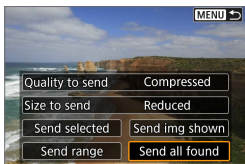

2 Select **[Send all found]**.

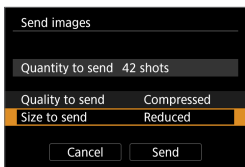

3 Select **[Size to send]**.

- On the displayed screen, select an image size.

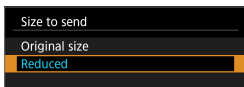

- When sending movies, select the image quality in **[Quality to send]**.

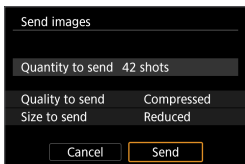

4 Select **[Send]**.

Ending Image Transfer

Sending Images from the Camera When Paired via Bluetooth (Android)



- Press the <MENU> button on the image transfer screen.

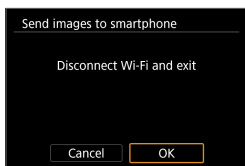

- Select [OK] on the screen on the left to end image transfer and the Wi-Fi connection.

Sending Images from the Camera over a Wi-Fi Connection



- Press the <MENU> button on the image transfer screen.
- For instructions on disconnecting from Wi-Fi, see "Terminating Wi-Fi Connections" (📖 344).

- During the image transfer operation, a picture cannot be taken even if the camera's shutter button is pressed.

- You can cancel the image transfer by selecting **[Cancel]** during the transfer.
- You can select up to 999 files at a time.
- With a Wi-Fi connection established, disabling the smartphone's power saving function is recommended.
- Selecting the reduced size for still photos applies to all still photos sent at that time. Note that **S2** size still photos are not reduced.
- Selecting compression for movies applies to all movies sent at that time.
- When you use a battery to power the camera, make sure it is fully charged.

Terminating Wi-Fi Connections

Perform either of the following operations.

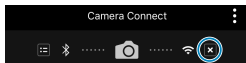

On the Camera Connect screen, tap on **[X]**.

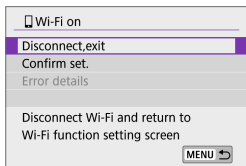

On the **[Wi-Fi on]** screen, select **[Disconnect,exit]**.

- If the **[Wi-Fi on]** screen is not displayed, select **[Wi-Fi/Bluetooth connection]**.
- Select **[Disconnect,exit]**, then select **[OK]** on the confirmation dialog.

Settings to Make Images Viewable from Smartphones

Images can be specified after the Wi-Fi connection is terminated.

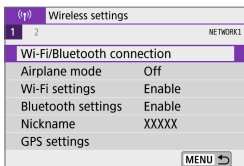

1 Select [**(1)**]: **Wi-Fi/Bluetooth connection**].

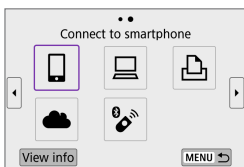

2 Select [**☎** **Connect to smartphone**].

- If the history (📖 390) is displayed, switch the screen with the <◀> <▶> keys.

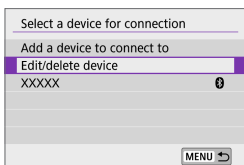

3 Select [**✎** **Edit/delete device**].

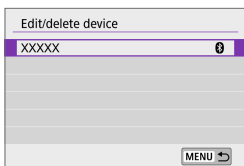

4 Select a **smartphone**.

- Select the name of the smartphone on which you want to make the images viewable.

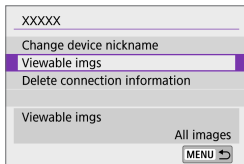

5 Select [Viewable imgs].

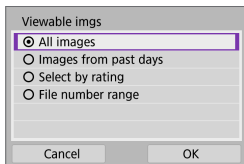

6 Select an item.

- Select **[OK]** to access the setting screen.

[All images]

All images stored on the card become viewable.

[Images from past days]

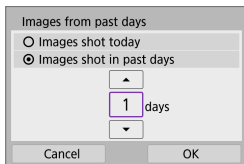

Specify viewable images on the shooting-date basis. Images shot up to nine days ago can be specified.

- When **[Images shot in past days]** is selected, images shot up to the specified number of days before the current date become viewable. Use the **<▲>** **<▼>** keys to specify the number of days, then press **<SET>** to confirm the selection.
- Once you select **[OK]**, the viewable images are set.

- If **[Viewable imgs]** is set to any setting other than **[All images]**, remote shooting is not possible.

[Select by rating]

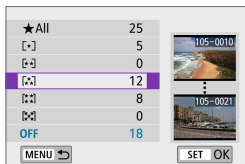

Specify viewable images depending on whether a rating is appended (or not appended) or by the type of rating.

- Once you select the type of rating, the viewable images are set.

[File number range] (Select range)

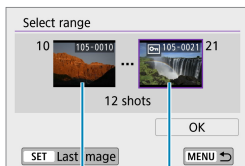

Select the first and last images from images arranged by the file number to specify the viewable images.

1. Press **<SET>** to display the image selection screen.
Use the **<<>** **<>>** keys to select the image.
You can turn the **<☀>** dial counterclockwise to select images from index display.
2. Select an image as the starting point (1).
3. Use **<>>** to select an image as the ending point (2).
4. Select **[OK]**.



- If the Wi-Fi connection is terminated while recording a movie with remote shooting, the following will occur.
 - Shooting mode switch set to : movie recording continues.
- With a Wi-Fi connection to a smartphone established, certain functions are unavailable.
- In remote shooting, the AF speed may become slower.
- Depending on the communication status, image display or shutter release timing may be delayed.
- When saving images to a smartphone, you cannot take a picture even if you press the camera's shutter button. Also, the camera screen may turn off.



- With a Wi-Fi connection established, disabling the smartphone's power saving function is recommended.

Connecting to a Computer via Wi-Fi

This section describes how to connect the camera to a computer via Wi-Fi and perform camera operations using EOS software or other dedicated software. Install the latest version of software on the computer before setting up a Wi-Fi connection.

For computer operating instructions, refer to the computer user manual.

Operating the Camera Using EOS Utility

Using EOS Utility (EOS software), you can import images from the camera, control the camera, and perform other operations.

Steps on the Camera (1)

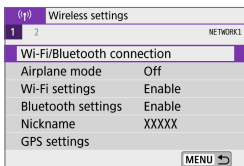

- 1 Select []: Wi-Fi/Bluetooth connection].

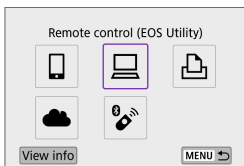

- 2 Select [Remote control (EOS Utility)].
 - If the history (390) is displayed, switch the screen with the <<> <>> keys.

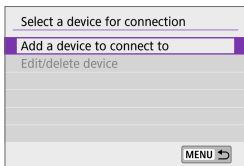

- 3 Select [Add a device to connect to].

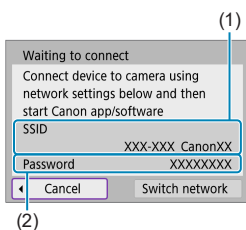

4 Check the SSID (network name) and password.

- Check the SSID (1) and password (2) displayed on the camera screen.
- In **[Wi-Fi settings]**, if you set **[Password]** to **[None]**, the password will not be displayed or required. For details, see 393.

Steps on the Computer (1)

Computer's screen (sample)

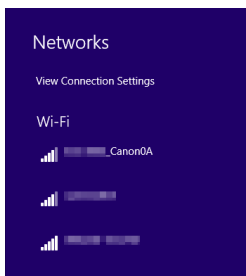

5 Select the SSID, then enter the password.

- On the computer's network setting screen, select the SSID checked in step 4.
- For the password, enter the password checked in step 4.

Steps on the Camera (2)

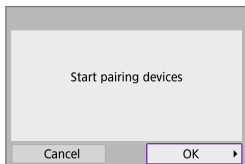

6 Select [OK].

- The following message is displayed. "*****" represents the last six digits of the MAC address of the camera to be connected.

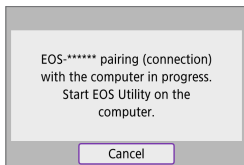

Steps on the Computer (2)

7 Start EOS Utility.

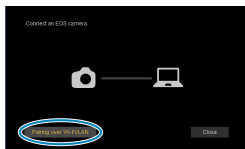

8 In EOS Utility, click [Pairing over Wi-Fi/LAN].

- If a firewall-related message is displayed, select [Yes].

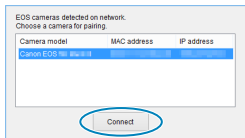

9 Click [Connect].

- Select the camera to connect to, then click [Connect].

Steps on the Camera (3)

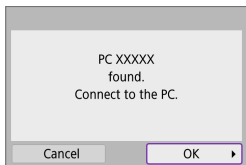

- 10** Establish a Wi-Fi connection.
- Select [OK].

[Wi-Fi on] Screen

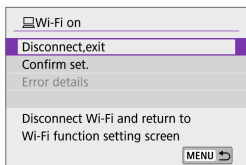

Disconnect,exit

- Terminates the Wi-Fi connection.

Confirm set.

- You can check the settings.

Error details

- When a Wi-Fi connection error occurs, you can check the details of the error.

The Wi-Fi connection to a computer is now complete.

- Operate the camera using EOS Utility on the computer.
- To reconnect via Wi-Fi, see "Reconnecting via Wi-Fi" ( 390).



- If the Wi-Fi connection is terminated while recording a movie with remote shooting, the following will occur.
 - Shooting mode switch set to <[Movie Mode Icon]>: movie recording continues.
 - Shooting mode switch not set to <[Movie Mode Icon]>: movie recording stops.
- Shooting operations using the camera are not possible after you use EOS Utility to switch from still photo mode to movie mode.
- With a Wi-Fi connection to EOS Utility established, certain functions are unavailable.
- In remote shooting, the AF speed may become slower.
- Depending on the communication status, image display or shutter release timing may be delayed.
- In Remote Live View shooting, the rate of image transmission is slower compared to a connection via an interface cable. Therefore, moving subjects cannot be displayed smoothly.

Sending Images on the Camera Automatically

With the dedicated software Image Transfer Utility 2, you can send images on the camera to a computer automatically.

Steps on the Computer (1)

1 Connect the computer and access point and start Image Transfer Utility 2.

- The screen to set up pairing is shown when you follow the instructions displayed the first time Image Transfer Utility 2 starts up.

Steps on the Camera (1)

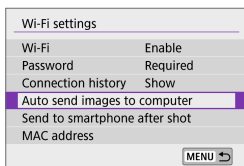

2 Select [Auto send images to computer].

- Select [(Ψ): Wi-Fi settings].
- Select [Auto send images to computer].

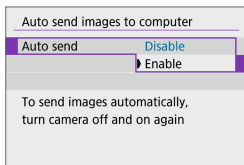

3 In [Auto send], select [Enable].

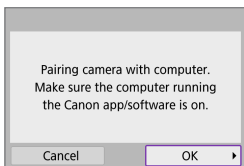

4 Select [OK].

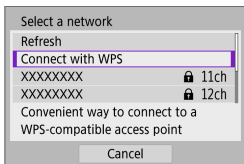

5 Connect to an access point via Wi-Fi.

- Establish a Wi-Fi connection between the camera and the access point connected to the computer. For connection instructions, see “Wi-Fi Connection via Access Points” (382).

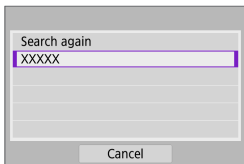

6 Select the computer to pair the camera with.

Steps on the Computer (2)

7 Pair the camera and computer.

- Select the camera, then click [Pairing].

Steps on the Camera (2)

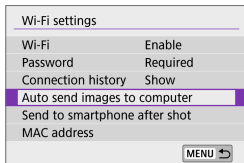

8 Select [Auto send images to computer].

- Select [(Wi): Wi-Fi settings].
- Select [Auto send images to computer].

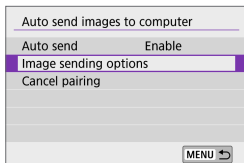

9 Select [Image sending options].

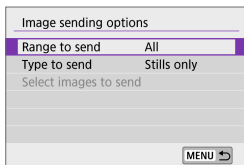

10 Select what to send.

- If you select [Selected imgs] in [Range to send], specify the images to send on the [Select images to send] screen.
- After the settings are complete, turn the camera off.

Images on the camera are automatically sent to the active computer when you turn the camera on within range of the access point.



- If images are not sent automatically, try restarting the camera.

Connecting to a Printer via Wi-Fi

This section describes how to print images by directly connecting the camera to a printer supporting PictBridge (Wireless LAN) via Wi-Fi. For printer operating instructions, refer to the printer user manual.

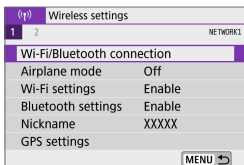

1 Select [**(Wi-Fi/Bluetooth connection)**].



2 Select [**Print from Wi-Fi printer**].

- If the history (390) is displayed, switch the screen with the <◀> <▶> keys.

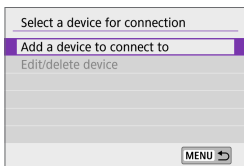

3 Select [**Add a device to connect to**].

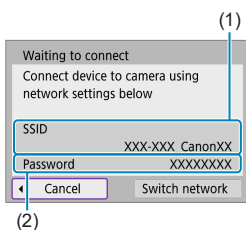

4 Check the SSID (network name) and password.

- Check the SSID (1) and password (2) displayed on the camera screen.
- In **[Wi-Fi settings]**, if you set **[Password]** to **[None]**, the password will not be displayed or required (📖 393).

5 Set up the printer.

- On the Wi-Fi settings menu of the printer to be used, select the SSID you have checked.
- For the password, enter the password checked in step 4.

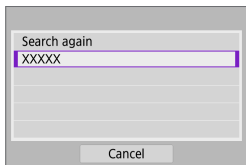

6 Select the printer.

- In the list of detected printers, select the printer to connect to via Wi-Fi.
- If your preferred printer is not listed, selecting **[Search again]** may enable the camera to find and display it.



- To establish a Wi-Fi connection via an access point, see "Wi-Fi Connection via Access Points" (📖 382).

Image Printing

Printing Images Individually



1 Select the image to be printed.

- Use the <◀> <▶> keys to select images to print, then press <SET>.
- You can turn the <☀> dial counterclockwise to select images from index display.



2 Select [Print image].

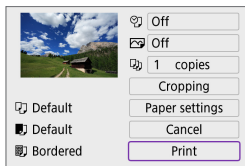

3 Print the image.

- For the print setting procedures, see 362.
- Select **[Print]**, then **[OK]** to start printing.

Printing According to Specified Image Options



1 Press <SET>.



2 Select [Print order].

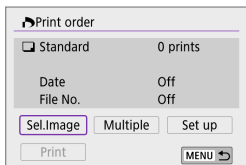

3 Set the printing options.

- For the print setting procedures, see “Print Ordering” (📖 284).
- If the print order is complete before establishing a Wi-Fi connection, go to step 4.

4 Select [Print].

- [Print] can be selected only when an image is selected and the printer is ready to print.

5 Set the [Paper settings] (📖 362).

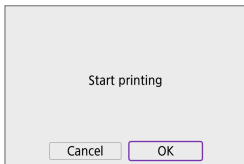

6 Print the image.

- When **[OK]** is selected, printing starts.



- Shooting is not possible while connected to a printer via Wi-Fi.
- Movies cannot be printed.
- Before printing, be sure to set the paper size.
- Certain printers may not be able to imprint the file number.
- If **[Bordered]** is set, certain printers may imprint the date on the border.
- Depending on the printer, the date may appear faint if it is imprinted on a bright background or on the border.
- RAW images cannot be printed by selecting **[Print order]**. When printing, select **[Print image]** and print.



- When you use a battery to power the camera, make sure it is fully charged.
- Depending on the image's file size and image quality, it may take some time to start printing after you select **[Print]**.
- To stop printing, press **<SET>** while **[Stop]** is displayed, then select **[OK]**.
- When printing with **[Print order]**, if you stopped printing and want to resume printing of the remaining images, select **[Resume]**. Note that printing will not resume if any of the following occurs.
 - You change the print order or delete any of the print ordered images before resuming printing.
- If a problem occurs during printing, see 366.

Print Settings

The screen display and setting options vary depending on the printer. Also, certain settings may not be available. For details, refer to the printer's instruction manual.

Print setting screen

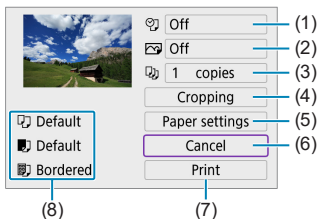

- (1) Sets date or file number printing (📖 364).
- (2) Sets the printing effects (📖 364).
- (3) Sets the number of copies to print (📖 364).
- (4) Sets the print area (📖 365).
- (5) Sets the paper size, type, and layout (📖 363).
- (6) Returns to the image selection screen.
- (7) Starts the printing.
- (8) The paper size, type, and layout you have set are displayed.

* Depending on the printer, certain settings may not be selectable.

Paper Settings

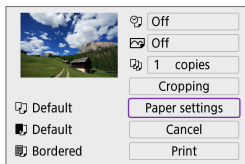

- Select **[Paper settings]**.

[📄] Setting the Paper Size

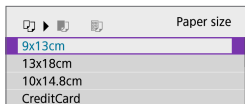

- Select the size of the paper in the printer.

[📄] Setting the Paper Type

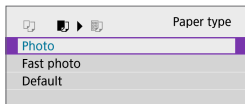

- Select the type of the paper in the printer.

[📄] Setting the Page Layout

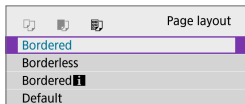

- Select the page layout.



- If the image's aspect ratio is different from the printing paper's aspect ratio, the image may be cropped significantly when you print it as a borderless print. Images may also be printed at lower resolution.

[🧠] Setting the Date/File Number Imprinting

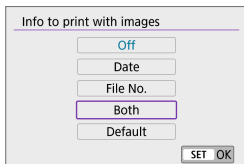

- Select [🧠].
- Select what to print.

[🖼️] Setting the Printing Effects (Image Optimization)

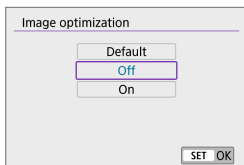

- Select [🖼️].
- Select printing effects.

- ❗ If you imprint shooting information on an image shot at an expanded ISO speed (H), the correct ISO speed may not be imprinted.
- The **[Default]** setting for printing effects and other options are the printer's own default settings as set by the printer's manufacturer. Refer to the printer's instruction manual to find out what the **[Default]** settings are.

[📄] Setting the Number of Copies



- Select [📄].
- Select the number of copies to print.

Cropping the Image

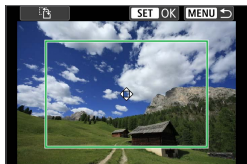

Set cropping immediately before printing. Changing other print settings after you crop images may require you to crop the images again.

- 1 On the print setting screen, select [Cropping].**
- 2 Set the cropping frame size, position, and aspect ratio.**
 - The image area within the cropping frame will be printed. The shape of the frame (aspect ratio) can be changed with **[Paper settings]**.

Changing the Cropping Frame Size

You can adjust the frame size by pinching in or out on the screen.

Moving the Cropping Frame

Use the <⬅➡> cross keys to move the frame vertically or horizontally.

Switching the Orientation of the Cropping Frame

Tap **[⌄]** on the screen to switch the cropping frame between vertical and horizontal orientation.

- 3 Press <SET> to exit the cropping.**
 - You can check the cropped image area on the upper left of the print setting screen.

- Depending on the printer, the cropped image area may not be printed as you specified.
- The smaller the cropping frame, the lower the resolution at which images are printed.



Handling Printer Errors

- If printing does not resume after you resolve a printer error (no ink, no paper, etc.) and select **[Continue]**, operate the buttons on the printer. For details on resuming printing, refer to the printer's instruction manual.

Error Messages

- If a problem occurs during printing, an error message will appear on the camera screen. After fixing the problem, resume printing. For details on how to fix a printing problem, refer to the printer's instruction manual.

Paper Error

- Confirm that paper is loaded correctly.

Ink Error

- Check the printer's ink level and the waste ink tank.

Hardware Error

- Check for any printer problems other than paper and ink problems.

File Error

- The selected image cannot be printed. Images taken with a different camera or images edited with a computer may not be printable.

Sending Images to a Web Service

This section describes how to use Web services to send images.

Registering Web Services

Use a smartphone or computer to add your Web services to the camera.

- A smartphone or computer with a browser and Internet connection is required to complete camera settings for CANON iIMAGE GATEWAY and other Web services.
- Visit the CANON iIMAGE GATEWAY website for details on versions of browsers (such as Microsoft Internet Explorer) and settings required for CANON iIMAGE GATEWAY access.
- For information on countries and regions where CANON iIMAGE GATEWAY is available, visit the Canon website (<http://www.canon.com/cig/>).
- For CANON iIMAGE GATEWAY instructions and setting details, refer to the help information for CANON iIMAGE GATEWAY.
- If you also intend to use Web services other than CANON iIMAGE GATEWAY, you must have an account with the services you intend to use. For further details, check the websites for each Web service you will register.
- Fees to connect to your provider and communication fees to access your provider's access point are charged separately.

Registering CANON iIMAGE GATEWAY

Link the camera and CANON iIMAGE GATEWAY by adding CANON iIMAGE GATEWAY as a destination Web service on the camera.

You will need to enter an email address used on your computer or smartphone.

Steps on the Camera (1)

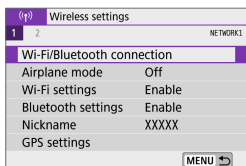

1 Select [**(Wi-Fi/Bluetooth connection)**].

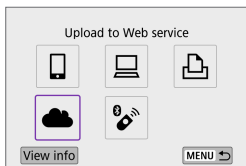

2 Select [**Cloud Upload to Web service**].



3 Select [**I Agree**].

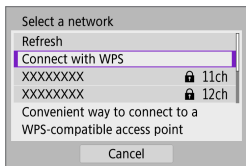

4 Establish a Wi-Fi connection.

- Connect to an access point via Wi-Fi. Go to step 7 on 383.

Camera web link settings

Enter your e-mail address to receive the link to initiate setup (up to 254 characters)

Cancel OK

5 Enter your email address.

- Enter your email address, then select [OK].

Camera web link settings

Enter a 4-digit code of your choice for verification on setup

Cancel OK

6 Enter a four-digit number.

- Enter a four-digit number of your choice, then select [OK].

Notification

Canon emailed you. If it doesn't arrive, check your email account settings. Upon reception, access the URL and complete Camera web link settings

OK

7 Select [OK].

- The [☁] icon changes to [☁📧].

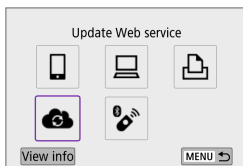

Steps on the Computer or Smartphone

8 Set up camera web link.

- Access the page in the notification message.
- Follow the instructions to complete the settings on the camera web link settings page.

Steps on the Camera (2)

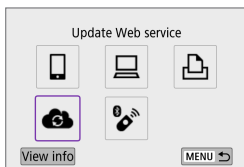

9 Add CANON iMAGE GATEWAY as a destination.

- Select [CLOUD].
CANON iMAGE GATEWAY is now added.

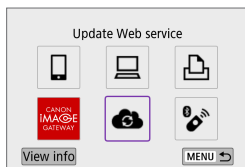

Registering Other Web Services

Steps on the Computer or Smartphone

1 Configure the Web service you want to use.

- Visit the CANON IMAGE GATEWAY website and access the camera web link settings page.
- Follow the on-screen instructions to complete settings for Web services you want to use.

Steps on the Camera



2 Add the Web service you configured as a destination.

- Select [(Wi-Fi/Bluetooth connection)].
- Select [(cloud icon)].

Sending Images

You can share images with your family and friends by sending images from the camera to a Web service registered on the camera or by sending Web links of the online albums.

Connecting to Web Services via Wi-Fi

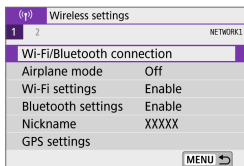

1 Select [(P) : Wi-Fi/Bluetooth connection].



2 Select a Web service.

- If the history (📖 390) is displayed, switch the screen with the <◀> <▶> keys.
- A screen to select a destination may be displayed, depending on the type and settings of the Web service (📖 385).

Sending Images Individually

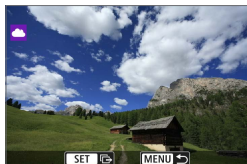

1 Select an image to send.

- Use the <◀> <▶> keys to select images to send, then press <SET>.
- You can turn the <☀> dial counterclockwise to select images from index display.



2 Select [Send img shown].

- In [Size to send], you can select the image sending size.
- On the screen after images are sent, select [OK] to end the Wi-Fi connection.

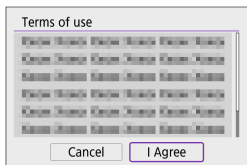

- When the [Terms of use] screen is displayed, thoroughly read the message, then select [I Agree].
- To scroll the screen, use the <▲> <▼> keys.

Sending Multiple Selected Images

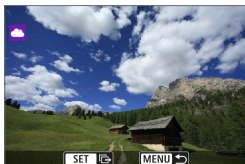

1 Press <SET>.

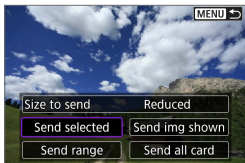

2 Select [Send selected].



3 Select images to send.

- Use the <◀> <▶> keys to select images to send, then press <SET>.
- You can turn the <☀> dial counterclockwise to switch to three-image display for image selection. To return to single-image display, turn the <☀> dial clockwise.
- After selecting the images to send, press the <MENU> button.

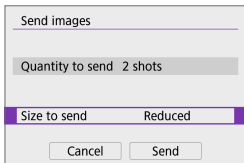

4 Select [Size to send].

- When YouTube is selected as the destination, **[Size to send]** is not displayed.
- On the displayed screen, select an image size.

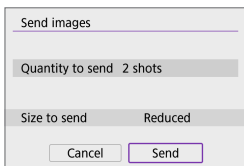
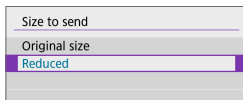

5 Select [Send].

- On the screen after images are sent, select **[OK]** to end the Wi-Fi connection.



- When the **[Terms of use]** screen is displayed, thoroughly read the message, then select **[I Agree]**.
- To scroll the screen, use the <▲> <▼> keys.

Sending a Specified Range of Images

Specify the range of images to send all the images in the range at once.



1 Press <SET>.

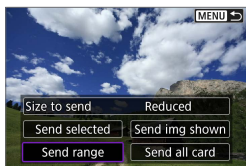

2 Select [Send range].

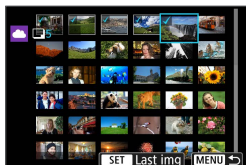

3 Specify the range of images.

- Select the first image (start point).
- Select the last image (end point).
Images will be selected and [✓] will appear.
- To cancel the selection, repeat this step.
- You can turn the <☀> dial to change the number of images shown in the index display.

4 Confirm the range.

- Press the <MENU> button.

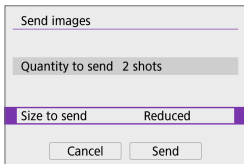

5 Select [Size to send].

- On the displayed screen, select an image size.

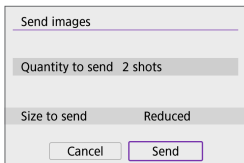
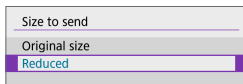

6 Select [Send].

- On the screen after images are sent, select **[OK]** to end the Wi-Fi connection.

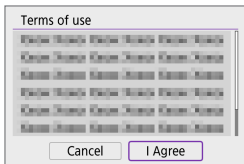

- When the **[Terms of use]** screen is displayed, thoroughly read the message, then select **[I Agree]**.
- To scroll the screen, use the **<▲>** **<▼>** keys.

Sending All Images on the Card

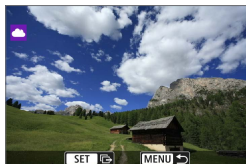

1 Press <SET>.



2 Select [Send all card].

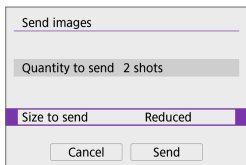

3 Select [Size to send].

- On the displayed screen, select an image size.

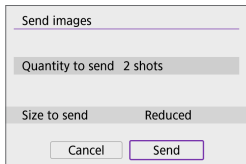
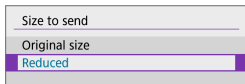

4 Select [Send].

- On the screen after images are sent, select [OK] to end the Wi-Fi connection.

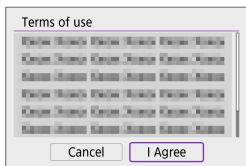

- When the [Terms of use] screen is displayed, thoroughly read the message, then select [I Agree].
- To scroll the screen, use the <▲> <▼> keys.

Sending Images that Match the Search Conditions

Send all the images that match the search conditions set in **[Set image search conditions]** at once.

For **[Set image search conditions]**, refer to “Set Image Search Conditions” (📖 308).

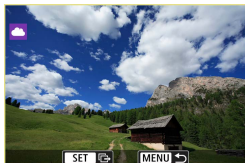

1 Press <SET>.

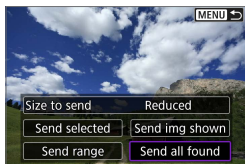

2 Select **[Send all found]**.

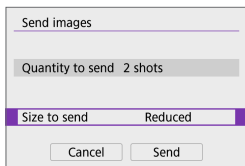

3 Select **[Size to send]**.

- On the displayed screen, select an image size.

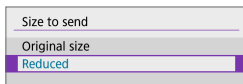

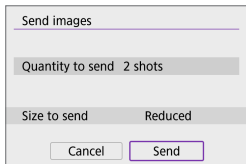

4 Select [Send].

- On the screen after images are sent, select **[OK]** to end the Wi-Fi connection.
- When the **[Terms of use]** screen is displayed, thoroughly read the message, then select **[I Agree]**.
- To scroll the screen, use the **<▲>** **<▼>** keys.





- With a Wi-Fi connection to a Web service established, a picture cannot be taken even if the camera's shutter button is pressed.
- When sending an image to a Web service other than CANON IMAGE GATEWAY, a send error message may not be displayed even if the image has not been sent to the Web service successfully. Since such send errors can be checked on the CANON IMAGE GATEWAY site, check the error content, then try sending the image again.



- Depending on the Web service, the type or number of images that can be sent and the length of movies will be limited.
- Certain images may not be able to be sent with **[Send range]**, **[Send all card]**, or **[Send all found]**.
- When you reduce the image size, all images to be sent at the same time are resized. Note that movies or **S2** size still photos are not reduced.
- **[Reduced]** is enabled only for still photos shot with cameras of the same model as this camera. Still photos shot with other models are sent without resizing.
- When accessing CANON IMAGE GATEWAY, you can check the send history for the Web services that the images were sent to.
- When you use a battery to power the camera, make sure it is fully charged.

Wi-Fi Connection via Access Points

This section describes how to join a Wi-Fi network via an access point compatible with WPS (PBC mode).

First, check the position of the WPS button and how long to press it. It may take approx. one minute to establish a Wi-Fi connection.

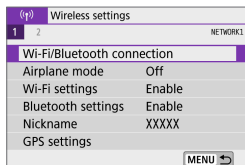

1 Select [**(P)**: **Wi-Fi/Bluetooth connection**].

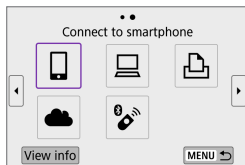

2 Select an item.

- If the history (📖 390) is displayed, switch the screen with the <◀> <▶> keys.

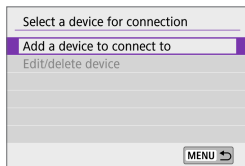

3 Select [**Add a device to connect to**].

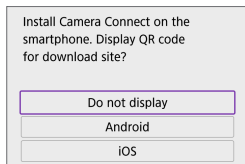

- When [**☑ Connect to smartphone**] is selected, the screen on the left is displayed. If Camera Connect is already installed, select [**Do not display**].
- On the [**Connect to smartphone**] screen displayed next, select [**Connect via Wi-Fi**].

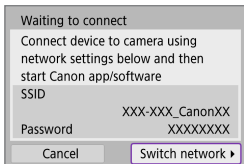

4 Select [Switch network].

- Displayed when [📱], [💻], or [📺] is selected.

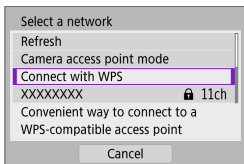

5 Select [Connect with WPS].



- For [Camera access point mode] displayed in step 5, see 📖 385.

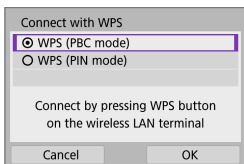

6 Select [WPS (PBC mode)].

- Select [OK].

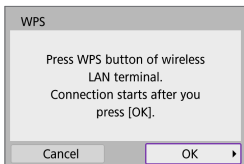

7 Connect to the access point via Wi-Fi.

- Press the access point's WPS button.
- Select [OK].

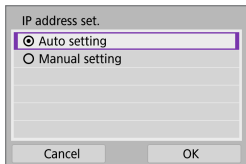

8 Select [Auto setting].

- Select **[OK]** to access the setting screen for the Wi-Fi function.
- If an error occurs with **[Auto setting]**, see 385.

9 Specify the settings for the Wi-Fi function.

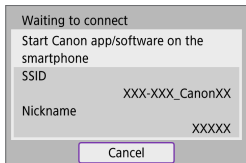

Connect to smartphone

- On the smartphone's Wi-Fi setting screen, tap the SSID (network name) shown on the camera, then enter the password of the access point for the connection. Go to step 8 on 333.

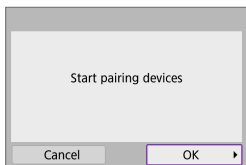

Remote control (EOS Utility)

Go to step 7 or 8 on 351.

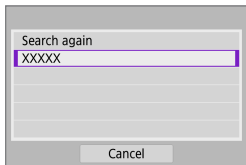

Print from Wi-Fi printer

Go to step 6 on 358.

Registering CANON IMAGE GATEWAY

Go to step 5 on 369.

Send To Screen

A screen to select a destination may be displayed depending on the Web service.

To register destinations or to specify the settings, you must use a computer. For more information, refer to the EOS Utility Instruction Manual.

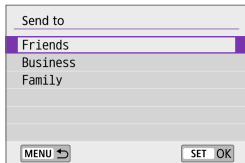

- The **[Send to]** screen may be displayed.
- Select the destination from the list of registered destinations.
- The procedures for setting up a connection and sending images are the same as those for other Web services.

Camera Access Point Mode

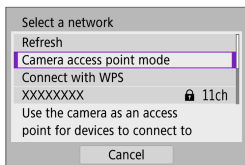

Camera access point mode is a connection mode for connecting the camera directly to each device via Wi-Fi.

Displayed when [📱], [💻], or [🖨️] is selected in **[Wi-Fi/Bluetooth connection]**.

Manual IP Address Setup

The items displayed vary depending on the Wi-Fi function.

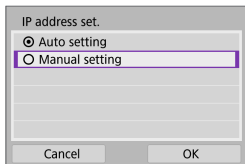

- 1 **Select [Manual setting].**
 - Select **[OK]**.

IP address set.	
IP address	192.168.1.2
Subnet mask	255.255.255.0
Gateway	Disable
<input type="button" value="Cancel"/> <input type="button" value="OK"/>	

2 Select an item.

- Select an item to access the screen for numerical input.
- To use a gateway, select **[Enable]**, then select **[Address]**.

Gateway	
<input checked="" type="radio"/> Enable	
<input type="radio"/> Disable	
Address	
<input type="text" value="0.0.0.0"/>	
<input type="button" value="Cancel"/> <input type="button" value="OK"/>	

IP address	
192 . 168 . 1 . 3	
0 1 2 3 4 5 6 7 8 9	
<input type="button" value="MENU x"/> <input type="button" value="OK"/> <input type="button" value="Cancel"/>	

3 Enter the desired values.

- Turn the  dial to move the input position in the upper area and use the <◀> <▶> keys to select the number. Press <SET> to enter the selected number.
- Press the <MENU> button to delete a character.

IP address set.	
IP address	192.168.1.3
Subnet mask	255.255.255.0
Gateway	Disable
<input type="button" value="Cancel"/> <input type="button" value="OK"/>	

4 Select [OK].

- When you have completed setting the necessary items, select **[OK]**.
- If you are not sure what to enter, see “Checking Network Settings” (419), or ask the network administrator or another person knowledgeable about the network.

Connecting to a Wireless Remote Control

This camera can also be connected to Wireless Remote Control BR-E1 (sold separately) via Bluetooth for remote control shooting (191).

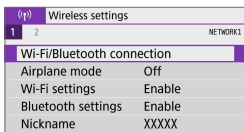

1 Select []: Wi-Fi/Bluetooth connection].

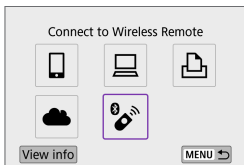

2 Select [] Connect to Wireless Remote].

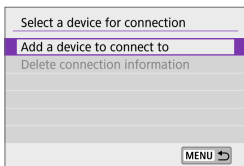

3 Select [Add a device to connect to].



4 Pair the devices.

- When the [Pairing] screen appears, press and hold the <W> and <T> buttons on the BR-E1 simultaneously for at least 3 sec.
- After a message confirms that the camera is paired with the BR-E1, press <SET>.

Still Photo Shooting

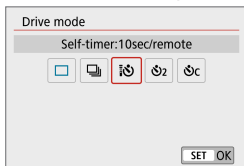

Movie Recording

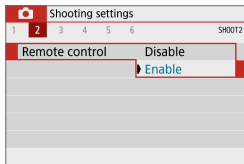

5 Set up the camera for remote shooting.

- Set **[Drive mode]** on the **[📷]** tab to **[i]** (135).
- In **[Remote control]** on the **[📷]** tab, select **[Enable]**.
- For instructions after the pairing is complete, refer to the BR-E1's Instruction Manual.

● Bluetooth connections consume battery power even after the camera's auto power off is activated.

● When you do not use the Bluetooth function, setting **[Bluetooth settings]** to **[Disable]** in step 1 is recommended.

Canceling the Pairing

Before pairing with a different BR-E1, clear the information about the connected remote control.

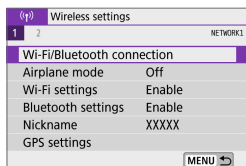

1 Select [**(1)**]: **Wi-Fi/Bluetooth connection**].

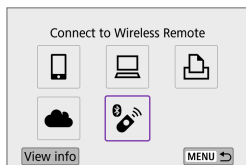

2 Select [**(2)**]: **Connect to Wireless Remote**].

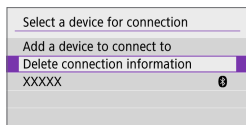

3 Select [**(3)**]: **Delete connection information**].

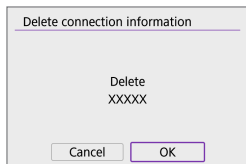

4 Select [**(4)**]: **OK**].

Reconnecting via Wi-Fi

Follow these steps to reconnect to devices or Web services with registered connection settings.

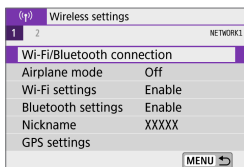

1 Select [(P): Wi-Fi/Bluetooth connection].

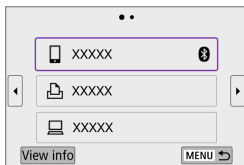

2 Select an item.

- Select the item to connect to via Wi-Fi from the displayed history. If the item is not displayed, use the <<> <>> keys to switch screens.
- If **[Connection history]** is set to **[Hide]**, the history will not be displayed (📖 393).

3 Operate the connected device.

[(📱)] Smartphone

- Start Camera Connect.
- If the smartphone's connection destination has been changed, restore the setting to connect via Wi-Fi to the camera or the same access point as the camera.

When directly connecting the camera to a smartphone via Wi-Fi, “_Canon0A” is displayed at the end of the SSID.

Computer

- On the computer, start the EOS software.
- If the computer's connection destination has been changed, restore the setting to connect via Wi-Fi to the camera or the same access point as the camera.

When directly connecting the camera to a computer via Wi-Fi, “_Canon0A” is displayed at the end of the SSID.

Printer

- If the printer's connection destination has been changed, restore the setting to connect via Wi-Fi to the camera or the same access point as the camera.

When directly connecting the camera to a printer via Wi-Fi, “_Canon0A” is displayed at the end of the SSID.

Registering Multiple Connection Settings

You can register up to 10 connection settings for the wireless communication functions.

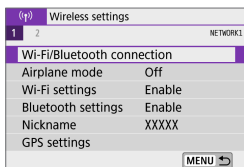

1 Select [(P) : Wi-Fi/Bluetooth connection].



2 Select an item.

- If the history (📖 390) is displayed, switch the screen with the <◀> <▶> keys.
- For details on [📱 **Connect to smartphone**], see “Connecting to a Smartphone” (📖 321).
- For details on [💻 **Remote control (EOS Utility)**], see “Connecting to a Computer via Wi-Fi” (📖 349).
- For details on [🖨️ **Print from Wi-Fi printer**], see “Connecting to a Printer via Wi-Fi” (📖 357).
- When sending images to a Web service, see “Sending Images to a Web Service” (📖 367).



- To delete connection settings, see 📖 399.

Wi-Fi Settings

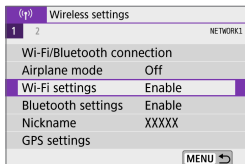

1 Select [(⌘)]: Wi-Fi settings].

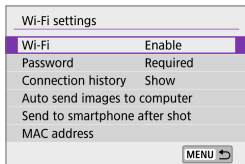

2 Select an item.

- **Wi-Fi**

When the use of electronic devices and wireless devices is prohibited, such as on board airplanes or in hospitals, set it to **[Disable]** or **[Airplane mode]** (📖 401).

- **Password**

Set to **[None]** to allow a Wi-Fi connection to be established without a password (except when connecting to an access point via Wi-Fi).

- **Connection history**

You can set whether to **[Show]** or **[Hide]** the history of the Wi-Fi connected devices.

- **Auto send images to computer**

With the dedicated software Image Transfer Utility 2, you can send images on the camera to a computer automatically (📖 354).

- **Send to smartphone after shot**

Your shots can be sent to a smartphone automatically (📖 335).

- **MAC address**

You can check the MAC address of the camera.

Bluetooth Settings

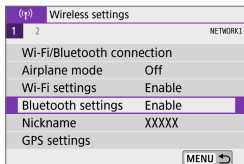

1 Select [(P)]: Bluetooth settings].

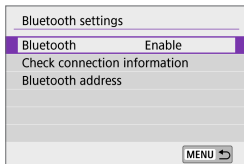

2 Select an item.

- **Bluetooth**

If you will not use the Bluetooth function, select **[Disable]**.

- **Check connection information**

You can check the name and communication status of the paired device.

- **Bluetooth address**

You can check the camera's Bluetooth address.

Changing the Nickname

You can change the camera nickname (displayed on smartphones and other cameras) as needed.

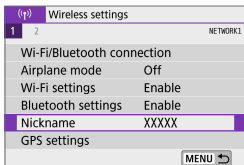

1 Select [(⌂) : Nickname].

2 Enter text using the virtual keyboard (📖 404).

- When you finish entering characters, press the <MENU> button.

Geotagging Images with GPS Information from Other Devices

You can geotag images with a Bluetooth enabled smartphone.

Complete these settings after installing the dedicated Camera Connect app (📖 322) on the smartphone.

- 1 On the smartphone, activate location services.
- 2 Establish a Bluetooth connection.
 - Connect the camera to a smartphone via Bluetooth (📖 323).
- 3 Select [(📍) : GPS settings].

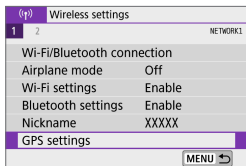

- 4 Select [GPS via mobile].

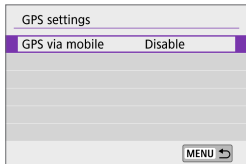

- 5 Select [Enable].

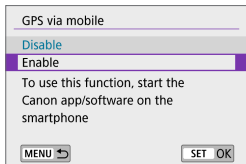

- 6 Take the picture.
 - Images are geotagged with the information from the smartphone.

GPS Connection Display

You can check the status of acquiring location information from a smartphone by referring to **[GPS]** display on screens for still photo shooting or movie recording (📖 501 and 📖 503, respectively).

- Gray: Location services are off
- Blinking: Location information cannot be acquired
- On: Location information acquired

Geotagging images as you shoot

Images captured while **[GPS]** is on are geotagged.

Geotagging information

You can check the location information added to your shots on the shooting information screen (📖 256, 📖 312).

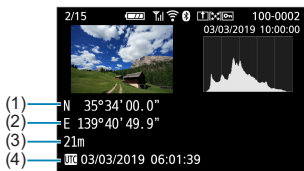

- (1) Latitude
- (2) Longitude
- (3) Elevation
- (4) UTC (Coordinated Universal Time)



- The smartphone can acquire location information only while it is paired with the camera via Bluetooth.
- Direction information is not acquired.
- Acquired location information may not be accurate, depending on traveling conditions or smartphone status.
- It may take some time to acquire location information from the smartphone after you turn the camera on.
- Location information is no longer acquired after any of the following operations.
 - Pairing with a wireless remote control via Bluetooth
 - Turning the camera off
 - Quitting Camera Connect
 - Deactivating location services on the smartphone
- Location information is no longer acquired in any of the following situations.
 - The camera power turns off
 - The Bluetooth connection is ended
 - The smartphone's remaining battery level is low



- Coordinated Universal Time, abbreviated as UTC, is essentially the same as Greenwich Mean Time.
- For movies, the GPS information initially acquired is added.

Changing or Deleting Connection Settings

To change or delete the connection settings, terminate the Wi-Fi connection first.

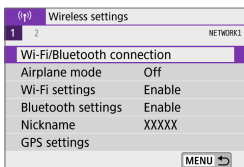

1 Select [**(1)**]: **Wi-Fi/Bluetooth connection**].



2 Select an item.

- If the history ( 390) is displayed, switch the screen with the <◀> <▶> keys.

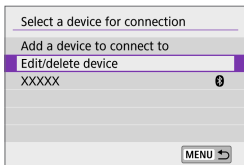

3 Select [**Edit/delete device**].

- You can change the Bluetooth connection by selecting a smartphone labeled with  in gray. After the [**Connect to smartphone**] screen is displayed, select [**Pair via Bluetooth**], then press <SET> on the next screen.

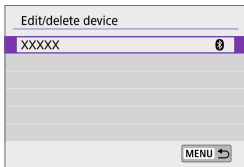

4 Select the device for which to change or delete the connection settings.

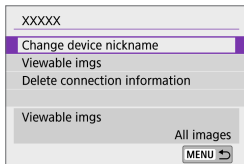

5 Select an item.

- Change or delete the connection settings on the displayed screen.

● Change device nickname

You can change the nickname using the virtual keyboard (📖 404).

● Viewable imgs (📖 345)

Displayed when [📱 **Connect to smartphone**] is selected. Settings will appear at the bottom of the screen.

● Delete connection information

When deleting connection information for a paired smartphone, also delete the camera information registered on the smartphone (📖 329).



- For Web services, visit the CANON IMAGE GATEWAY website to delete the connection settings.

Airplane Mode

You can temporarily disable Wi-Fi and Bluetooth functions.

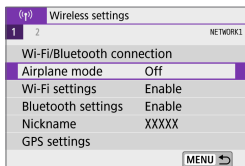

1 Select [**(↑)**]: Airplane mode].

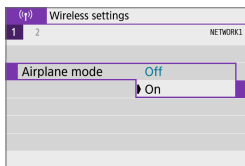

2 Set to [On].
• [**(↑)**] is displayed.

Clearing Wireless Communication Settings to Default

All wireless communication settings can be deleted. By deleting the wireless communication settings, you can prevent their information from being exposed when you lend or give your camera to other people.

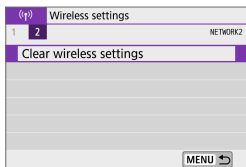

1 Select [(P)]: **Clear wireless settings**].

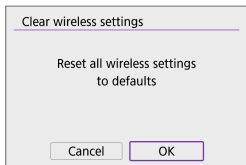

2 Select [OK].

- Information in wireless communication settings is retained even if you select **[Basic settings]** in [(P): **Reset camera**].
- If you have paired the camera with a smartphone, on the smartphone's Bluetooth settings screen, delete the connection information of the camera for which you restored default wireless communication settings.

View Info Screen

You can check error details and the camera's MAC address.

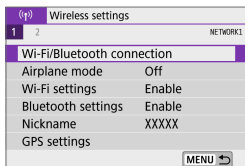

1 Select [(1)]: **Wi-Fi/Bluetooth connection**].



2 Tap **[View info]**.
• The **[View info]** screen will appear.

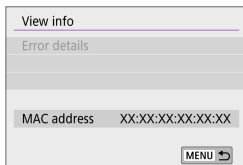

- When an error has occurred, press <SET> to display the error content.

Virtual Keyboard Operations

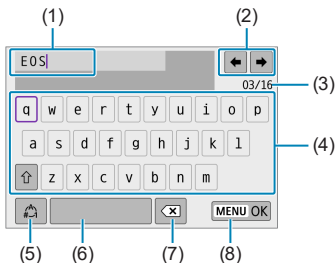

(1) Input area, for entering text

(2) Cursor keys, for moving in the input area

(3) Current no. of characters/no. available



(4) Keyboard

(5) Switch input modes

(6) Space

(7) Delete a character in the input area

(8) Finish the text entry

- To move the cursor within (1), turn the  dial.
- To move within (2) and (4)–(7), use the  cross keys.
- Press <SET> to confirm input or when switching input modes.

Responding to Error Messages

When an error occurs, display the details of the error by following one of the procedures below. Then, eliminate the cause of the error by referring to the examples shown in this chapter.

- On the **[View info]** screen, press <SET> (📖 403).
- Select **[Error details]** on the **[Wi-Fi on]** screen.

Click the error code number's page in the following chart to jump to the corresponding page.

11 (📖 406)	12 (📖 406)	21 (📖 407)	22 (📖 408)
23 (📖 409)	61 (📖 410)	63 (📖 411)	64 (📖 411)
65 (📖 412)	66 (📖 412)	67 (📖 412)	68 (📖 413)
69 (📖 413)	91 (📖 413)	121 (📖 413)	125 (📖 414)
126 (📖 414)	127 (📖 414)	141 (📖 414)	142 (📖 414)
151 (📖 415)	152 (📖 415)		



- When an error occurs, **[Err**]** is displayed on the upper right of the **[Wi-Fi/Bluetooth connection]** screen. It is no longer displayed after the camera is turned off.

11: Connection target not found

- In the case of [❏], is Camera Connect running?
 - ➔ Establish a connection using Camera Connect (📖 333).
- In the case of [📷], is the EOS software running?
 - ➔ Start the EOS software and reestablish the connection (📖 351).
- In the case of [🖨️], is the power of the printer on?
 - ➔ Turn on the printer.
- Are the camera and the access point set to use the same password for authentication?
 - ➔ This error occurs if the passwords do not match when the authentication method for encryption is set to **[Open system]**. The setting is case-sensitive, so check upper- and lower-case characters. Make sure that the correct password for authentication is set on the camera (📖 404).

12: Connection target not found

- Is the power of the target device and access point on?
 - ➔ Turn on the target device and access point, then wait a while. If a connection still cannot be established, perform the procedures to establish the connection again.

21: No address assigned by DHCP server

What to check on the camera

- On the camera, IP address is set to **[Auto setting]**. Is this the correct setting?
 - ➔ If no DHCP server is used, specify the settings after setting the IP address to **[Manual setting]** on the camera (📖 385).

What to check on the DHCP server

- Is the power of the DHCP server on?
 - ➔ Turn on the DHCP server.
- Are there enough addresses for assignment by the DHCP server?
 - ➔ Increase the number of addresses assigned by the DHCP server.
 - ➔ Remove devices assigned addresses by the DHCP server from the network to reduce the number of addresses in use.
- Is the DHCP server working correctly?
 - ➔ Check the DHCP server settings to make sure it is working correctly as a DHCP server.
 - ➔ If applicable, ask your network administrator to ensure the DHCP server is available.

22: No response from DNS server

What to check on the camera

- On the camera, does the DNS server's IP address setting match the server's actual address?
 - ➔ Set the IP address to **[Manual setting]**. Then, on the camera, set the IP address that matches the address of the DNS server used (📖 385, 📖 419).

What to check on the DNS server

- Is the power of the DNS server on?
 - ➔ Turn on the DNS server.
- Are the DNS server settings for IP addresses and the corresponding names correct?
 - ➔ On the DNS server, make sure IP addresses and the corresponding names are entered correctly.
- Is the DNS server working correctly?
 - ➔ Check the DNS server settings to make sure it is working correctly as a DNS server.
 - ➔ If applicable, ask your network administrator to ensure the DNS server is available.

What to check on the network as a whole

- Does the network that you are trying to connect to via Wi-Fi include a router or similar device that serves as a gateway?
 - ➔ If applicable, ask your network administrator for the network gateway address and enter it on the camera (📖 419, 📖 385).
 - ➔ Make sure that the gateway address setting is correctly entered on all network devices including the camera.

23: Device with same IP address exists on selected network

What to check on the camera

- Do the camera and another device connected via Wi-Fi to the same network have the same IP address?
 - ➔ Change the camera's IP address to avoid using the same address as another device on the network. Otherwise, change the IP address of the device that has a duplicate address.
 - ➔ If the camera's IP address is set to **[Manual setting]** in network environments using a DHCP server, change the setting to **[Auto setting]** (📖 384).



Responding to Error Messages 21–23

- Also check the following points when responding to errors numbered 21–23.
- **Are the camera and the access point set to use the same password for authentication?**
 - This error occurs if the passwords do not match when the authentication method for encryption is set to **[Open system]**. The setting is case-sensitive, so check upper- and lower-case characters. Make sure that the correct password for authentication is set on the camera (📖 404).

61: Selected SSID wireless LAN network not found

- Are any obstacles blocking the line of sight between the camera and the antenna of the access point?
 - ➔ Move the antenna of the access point to a position clearly visible from the point of view of the camera (📖416).

What to check on the camera

- Does the SSID set on the camera match that of the access point?
 - ➔ Check the SSID at the access point, then set the same SSID on the camera.

What to check at the access point

- Is the access point turned on?
 - ➔ Turn on the power of the access point.
- If filtering by MAC address is active, is the MAC address of the camera in use registered at the access point?
 - ➔ Register the MAC address of the camera used to the access point. The MAC address can be checked on the **[View info]** screen (📖403).

63: Wireless LAN authentication failed

- Are the camera and the access point set to use the same authentication method?
 - ➔ The camera supports the following authentication methods: **[Open system]**, **[Shared key]**, and **[WPA/WPA2-PSK]**.
- Are the camera and the access point set to use the same password for authentication?
 - ➔ The setting is case-sensitive, so check upper- and lower-case characters. Make sure that the correct password for authentication is set on the camera.
- If filtering by MAC address is active, is the MAC address of the camera in use registered at the access point?
 - ➔ Register the MAC address of the camera used to the access point. The MAC address can be checked on the **[View info]** screen (📖 403).

64: Cannot connect to wireless LAN terminal

- Are the camera and the access point set to use the same encryption method?
 - ➔ The camera supports the following encryption methods: WEP, TKIP, and AES.
- If filtering by MAC address is active, is the MAC address of the camera in use registered at the access point?
 - ➔ Register the MAC address of the camera used to the access point. The MAC address can be checked on the **[View info]** screen (📖 403).

65: Wireless LAN connection lost

- Are any obstacles blocking the line of sight between the camera and the antenna of the access point?
 - ➔ Move the antenna of the access point to a position clearly visible from the point of view of the camera (📖416).
- The Wi-Fi connection was lost for some reason, and the connection cannot be restored.
 - ➔ The following are possible reasons: excessive access to the access point from another device, a microwave oven or similar appliance in use nearby (interfering with IEEE 802.11b/g/n (2.4 GHz band)), or influence of rain or high humidity (📖416).

66: Incorrect wireless LAN password

- Are the camera and the access point set to use the same password for authentication?
 - ➔ The setting is case-sensitive, so check upper- and lower-case characters. Make sure that the correct password for authentication is set on the camera.

67: Incorrect wireless LAN encryption method

- Are the camera and the access point set to use the same encryption method?
 - ➔ The camera supports the following encryption methods: WEP, TKIP, and AES.
- If filtering by MAC address is active, is the MAC address of the camera in use registered at the access point?
 - ➔ Register the MAC address of the camera used to the access point. The MAC address can be checked on the **[View info]** screen (📖403).

68: Cannot connect to wireless LAN terminal. Retry from the beginning.

- Did you hold down the access point's WPS (Wi-Fi Protected Setup) button for the specified period of time?
 - ➔ Hold down the WPS button for the period of time specified in the access point's instruction manual.
- Are you trying to establish a connection near the access point?
 - ➔ Try establishing the connection when both devices are within reach of each other.

69: Multiple wireless LAN terminals have been found. Cannot connect. Retry from the beginning.

- Connection is in progress by other access points in Pushbutton Connection mode (PBC mode) of WPS (Wi-Fi Protected Setup).
 - ➔ Wait a while before trying to establish the connection.

91: Other error

- A problem other than error code number 11 to 69 occurred.
 - ➔ Turn the camera's power switch off and on.

121: Not enough free space on server

- The target Web server does not have enough free space.
 - ➔ Delete unnecessary images on the Web server, check the free space on the Web server, then try sending the data again.

125: Check the network settings

- Is the network connected?
 - ➔ Check the connection status of the network.

126: Could not connect to server

- CANON iIMAGE GATEWAY is under maintenance or load is concentrated temporarily.
 - ➔ Try connecting to the Web service again later.

127: An error has occurred

- A problem other than error code number 121 to 126 occurred while the camera is connected to the Web service.
 - ➔ Try again to establish the Wi-Fi connection to the Web service.

141: Printer is busy. Try connecting again.

- Is the printer performing a printing process?
 - ➔ Try again to establish the Wi-Fi connection to the printer after the printing process is finished.
- Is another camera connected to the printer via Wi-Fi?
 - ➔ Try again to establish the Wi-Fi connection to the printer after the Wi-Fi connection to the other camera has been terminated.

142: Could not acquire printer information. Reconnect to try again.

- Is the power of the printer on?
 - ➔ Try again to establish the Wi-Fi connection after turning on the printer.

151: Transmission canceled

- Automatic image transfer to the computer was somehow interrupted.
 - ➔ Restart the camera to resume automatic image transfer.

152: Card's write protect switch is set to lock

- Is the card's write protect switch set to the locked position?
 - ➔ Slide the card's write protect switch to the writing position.

Wireless Communication Function Notes

If the transmission rate drops, the connection is lost, or other problems occur when using the wireless communication functions, try the following corrective actions.

Distance Between the Camera and the Smartphone

If the camera is too far from the smartphone, a Wi-Fi connection may not be established even when Bluetooth connection is possible. In this case, bring the camera and the smartphone closer together, then establish a Wi-Fi connection.

Installation Location of Access Point Antenna

- When using indoors, install the device in the room where you are using the camera.
- Install the device where people or objects do not come between the device and the camera.

Nearby Electronic Devices



If the Wi-Fi transmission rate drops because of the influence of the following electronic devices, stop using them or move further away from the devices to transmit communication.

- The camera communicates over Wi-Fi via IEEE 802.11b/g/n using radio waves in the 2.4 GHz band. For this reason, the Wi-Fi transmission rate will drop if there are Bluetooth devices, microwave ovens, cordless telephones, microphones, smartphones, other cameras, or similar devices operating on the same frequency band nearby.

Cautions for Using Multiple Cameras

- When connecting multiple cameras to one access point via Wi-Fi, make sure the cameras' IP addresses are different.
- When multiple cameras are connected to one access point via Wi-Fi, the transmission rate drops.
- When there are multiple IEEE 802.11b/g/n (2.4 GHz band) access points, leave a gap of five channels between each Wi-Fi channel to reduce radio wave interference. For example, use channels 1, 6, and 11, channels 2 and 7, or channels 3 and 8.

Using the Wireless Remote Control BR-E1

- BR-E1 cannot be used while the camera and smartphone are paired via Bluetooth. Change the camera connection to the wireless remote control in [ **Connect to Wireless Remote**] under [(): **Wi-Fi/Bluetooth connection**].

Security

If security settings have not been properly set, the following problems may occur.

- **Transmission monitoring**

Third parties with malicious intent may monitor the Wi-Fi transmissions and attempt to acquire the data you are sending.

- **Unauthorized network access**

Third parties with malicious intent may gain unauthorized access to the network you are using to steal, modify, or destroy information. Additionally, you could fall victim to other types of unauthorized access such as impersonation (where someone assumes an identity to gain access to unauthorized information) or springboard attacks (where someone gains unauthorized access to your network as a springboard to cover their tracks when infiltrating other systems).

It is recommended to make use of the systems and functions to thoroughly secure your network, preventing these types of problems from occurring.

Checking Network Settings

- **Windows**

Open the Windows **[Command Prompt]**, then type `ipconfig/all` and press the **<Enter>** key.

In addition to the IP address assigned to the computer, the subnet mask, gateway, and DNS server information are also displayed.

- **Mac OS**

In Mac OS X, open the **[Terminal]** application, enter `ifconfig -a`, and press the **<Return>** key. The IP address assigned to the computer is indicated in the **[en0]** item next to **[inet]**, in the format `***.***.***.***`.

* For information about the **[Terminal]** application, refer to the Mac OS X help.

To avoid using the same IP address for the computer and other devices on the network, change the rightmost number when setting up the IP address assigned to the camera in the processes described on  385.

Example: 192.168.1 

Wireless Communication Status

Wireless communication status can be checked on the screen.

Information display screen
during shooting













- (1) —
- (2) —
- (3) —

Information display screen
during playback





- (1) —
- (2) —
- (3) —

-
- (1) Wi-Fi function
 - (2) Bluetooth function
 - (3) Wireless signal strength
-

Communication Status		Screen	
		Wi-Fi Function	Wireless Signal Strength
Not connected	Wi-Fi: Disable		Off
	Wi-Fi: Enable		
Connecting		 (Blinking)	
Connected			
Sending data		 (Animated)	
Connection error		 (Blinking)	

Bluetooth Function Indicator

Bluetooth Function	Connection Status	Screen
[Enable]	Bluetooth connected	
	Bluetooth not connected	
[Disable]	Bluetooth not connected	Not displayed



- “Bluetooth not connected” status is indicated when connected to computers, printers, or Web services via Wi-Fi.



Function Settings

This chapter describes menu settings on the function settings ([F]) tab.

- A ☆ icon to the right of a page title indicates that the function is available only in advanced shooting modes ([P], [Tv], [Av], or [M]) or [S/M] movie modes ([S/M] or [S/M]).

Tab Menus: Function Settings

● Function settings 1

Function settings	
1	2 3 4 5 SET UP1
Select folder	426
File numbering	Continuous 428
Auto rotate	On 431
Add rotate info	Enable 432
Format card	433
MENU →	

● Function settings 2

Function settings	
1	2 3 4 5 SET UP2
Eco mode	Off 435
Power saving	436
Disp. brightness	437
Date/Time/Zone	03/03/19 10:00 438
Language	English 441
Shutter btn function for movies	442
MENU →	

● Function settings 3

Function settings	
1	2 3 4 5 SET UP3
Video system	For NTSC 443
Touch control	Standard 444
Screen autolock settings	OFF 445
Beep	Enable 446
HDMI resolution	Auto 447
HDMI HDR output	Off 448
MENU →	

● Function settings 4

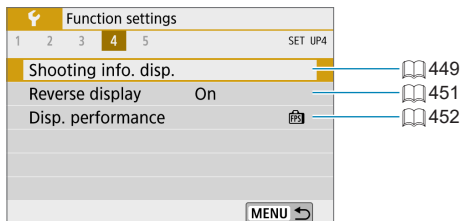

● Function settings 5

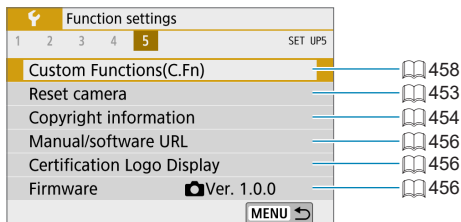

Select Folder

You can freely create and select the folder where the captured images are to be saved.

Creating a Folder

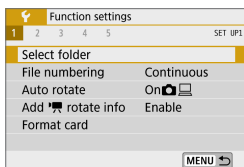

1 Select [**F**: Select folder].

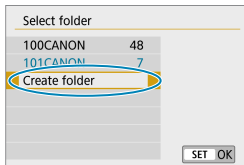

2 Select [Create folder].

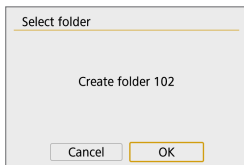

3 Select [OK].

Selecting a Folder

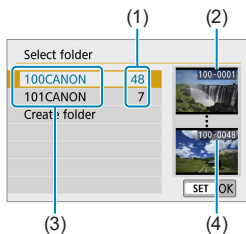

- Select a folder on the folder selection screen.
- Captured images are stored in your selected folder.

- (1) Number of images in folder
- (2) Lowest file number
- (3) Folder name
- (4) Highest file number



Folders

- A folder can contain up to 9999 images (file number 0001–9999). When a folder becomes full, a new folder with the folder number increased by one is created automatically. Also, if manual reset (📖430) is executed, a new folder will be created automatically. Folders numbered from 100 to 999 can be created.

Creating Folders with a Computer

- With the card open on the screen, create a new folder named "DCIM". Open the DCIM folder and create as many folders as necessary to save and organize your images. The folder name must follow the format "100ABC_D". The first three digits are always the folder number from 100 to 999. The last five characters can be any combination of upper- and lower-case letters from A to Z, numerals, and the underscore "_". The space cannot be used. Also note that two folder names cannot share the same three-digit folder number (for example, "100ABC_D" and "100W_XYZ") even if the remaining five characters in each name are different.

File Numbering

The captured images saved in a folder are assigned a file number from 0001 to 9999. You can change how the image files are numbered.

(Example) **IMG_0001.JPG**

File number

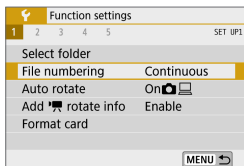

1 Select [**F**: File numbering].

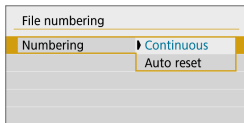

2 Set the item.

- Select [**N**umbering].
- Select [**C**ontinuous] or [**A**uto reset].

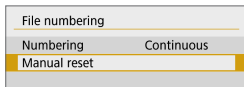

- If you want to reset the file numbering, select [**M**anual reset] (📖 430).
- Select [**O**K] to create a new folder, and the file number will start with 0001.

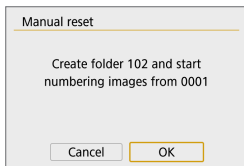

- If the file number in folder 999 reaches 9999, shooting will not be possible even if the card still has storage capacity. The screen will display a message telling you to replace the card. Replace it with a new card.

Continuous

When you wish to continue the file numbering sequence even after the card is replaced or a new folder is created.

Even after you replace the card or create a new folder, the file numbering continues in sequence up to 9999. This is useful when you want to save images numbered anywhere between 0001 to 9999 on multiple cards or in multiple folders into one folder on a computer.

If the replacement card or existing folder already contains images recorded previously, the file numbering of the new images may continue from the file numbering of the existing images on the card or in the folder. If you want to use continuous file numbering, it is recommended that you use a newly-formatted card each time.

File numbering after replacing the card File numbering after creating a folder

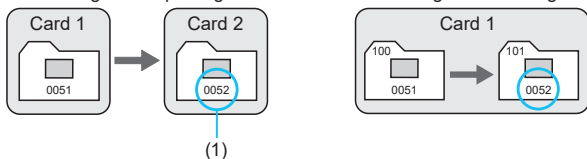

(1) Next sequential file number

Auto Reset

When you wish to restart the file numbering from 0001 each time the card is replaced or a new folder is created.

When you replace the card or create a folder, the file numbering restarts from 0001 for the new images saved. This is useful if you want to organize images by cards or folders.

If the replacement card or existing folder already contains images recorded previously, the file numbering of the new images may continue from the file numbering of the existing images on the card or in the folder. If you want to save images with the file numbering starting from 0001, use a newly formatted card each time.

File numbering after replacing the card File numbering after creating a folder

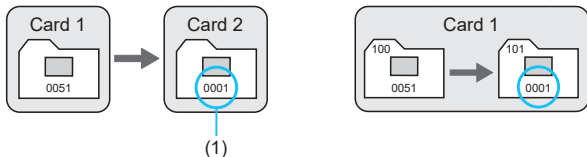

(1) File numbering is reset

Manual Reset

When you wish to reset the file numbering to 0001 or to start from file number 0001 in a new folder.

When you reset the file numbering manually, a new folder is created automatically and the file numbering of images saved to that folder starts from 0001.

This is useful, for example, if you want to use different folders for the images taken yesterday and the ones taken today.

Auto Rotate

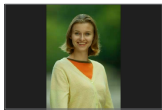

You can change the auto rotation setting that straightens images shot in vertical orientation when they are displayed.

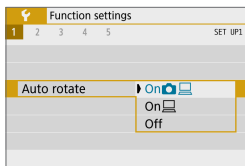

1 Select [**☑**: Auto rotate].

2 Select an item.

- **On**  

Automatically rotates images for display on both the camera and computers.

- **On** 

Automatically rotates images only for display on computers.

- **Off**



- Images captured with auto rotation set to **[Off]** will not rotate during playback even if you later set auto rotation to **[On]**.



- If a picture is taken while the camera is pointing up or down, auto rotation to the proper orientation for viewing may not be performed correctly.
- If images are not rotated automatically on a computer, try using EOS software.

Adding Orientation Information to Movies

For movies recorded with the camera held vertically, orientation information indicating which side is up can be added automatically to enable playback in the same orientation on smartphones or other devices.

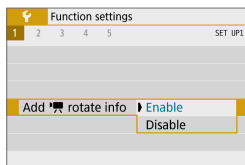

1 Select [: Add rotate info].

2 Select an item.

- **Enable**

Play movies on smartphones or other devices in the orientation in which they were recorded.

- **Disable**

Play movies horizontally on smartphones or other devices, regardless of the recording orientation.

- Movies are played horizontally on the camera, regardless of the [: Add rotate info] setting.

Format Card

If the card is new or was previously formatted (initialized) by another camera or computer, format the card with this camera.



- When the card is formatted, all images and data on the card will be erased. Even protected images will be erased, so make sure there is nothing you need to keep. If necessary, transfer the images and data to a computer, etc. before formatting the card.

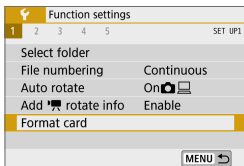

1 Select [**F** : Format card].

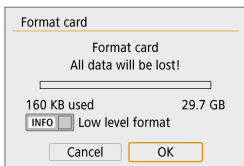

2 Format the card.

- Select [**OK**].

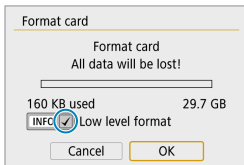

- For low-level formatting, press the <INFO> button to add a checkmark <✓> to [**Low level format**], then select [**OK**].



- The card capacity displayed on the card format screen may be smaller than the capacity indicated on the card.
- This device incorporates exFAT technology licensed from Microsoft.



Format the Card in the Following Cases:

- The card is new.
- The card was formatted by a different camera or a computer.
- The card is full of images or data.
- A card-related error is displayed (📖 493).

Low-Level Formatting

- Perform low-level formatting if the card's writing or reading speed seems slow or if you want to totally erase the data on the card.
- Since low-level formatting will format all recordable sectors on the card, the formatting will take longer than normal formatting.
- During low-level formatting, you can cancel formatting by selecting **[Cancel]**. Even in this case, normal formatting will already be complete and you can use the card as usual.

Card's File Formats

- **SD/SDHC cards will be formatted in FAT32. SDXC cards will be formatted in exFAT.**
- When recording a movie with a card formatted in exFAT, the movie will be recorded in a single file (instead of being split into multiple files) even if it exceeds 4 GB. (The movie file will exceed 4 GB.)



- It may not be possible to use SDXC cards formatted with this camera in other cameras. Also note that exFAT-formatted cards may not be recognized by some computer operating systems or card readers.
- Formatting or erasing data on a card does not completely erase the data. Be aware of this when selling or discarding the card. When disposing of cards, take steps to protect personal information if necessary, as by physically destroying cards.

Eco Mode

You can conserve battery power while the shooting screen is displayed. When the camera is not in use, the screen darkens to reduce battery consumption.

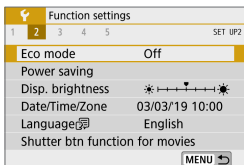

1 Select [**F**: Eco mode].

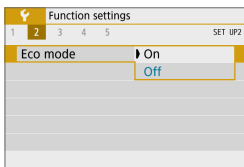

2 Select [**On**].

- If the camera is not used, the screen dims in approx. 2 sec. and then turns off in approx. 10 sec.



- To reactivate the screen and prepare for shooting when the screen has been off for less than about three minutes, press the shutter button halfway.
- The camera turns itself off automatically after about three minutes of inactivity once the screen is off.

Power Saving

You can adjust the timing of when the screen and camera turn off automatically ([**Display off**] and [**Auto power off**]).

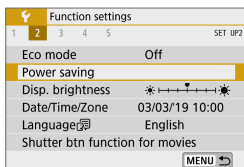

1 Select [**⚡**: Power saving].

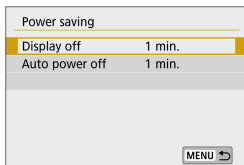

2 Select an item.



- Even when [**Auto power off**] is set to [**Disable**], the screen will turn off after the time set in [**Display off**].
- [**Display off**] and [**Auto power off**] settings do not apply when Eco mode is set to [**On**].

Display Brightness

Screen brightness is adjustable.

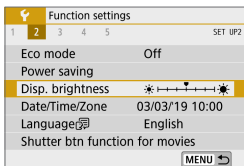

1 Select [**F**: Disp. brightness].

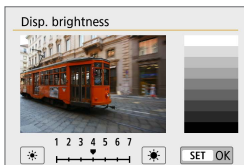

2 Make the adjustment.

- Referring to the gray chart, use the <◀> <▶> keys to adjust the brightness, then press <SET>.



- To check the image's exposure, referring to the histogram is recommended (📖 312).

Date/Time/Zone

When you turn on the power for the first time or if the date/time/zone have been reset, follow the steps below to set the time zone first.

By setting the time zone first, you can simply adjust this setting as needed in the future and the date/time will be updated to match it.

Since the captured images will be appended with the shooting date and time information, be sure to set your date/time.

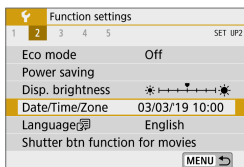

1 Select [**☒**: Date/Time/Zone].

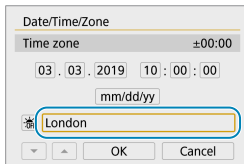

2 Set the time zone.

- Use the <◀> <▶> keys to select [**Time zone**].

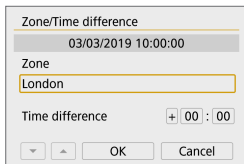

- Press <SET>.

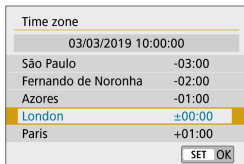

- Use the <▲> <▼> keys to select the time zone, then press <SET>.
- If your time zone is not listed, press the <MENU> button, then set the difference from UTC in [**Time difference**].

- Use the <◀> <▶> keys to select a **[Time difference]** item (+/-/hour/minute), then press <SET>.
- Use the <▲> <▼> keys to set it, then press <SET>.
- After entering the time zone or time difference, use the <◀> <▶> keys to select **[OK]**, then press <SET>.

3 Set the date and time.

- Use the <◀> <▶> keys to select an item, then press <SET>.
- Use the <▲> <▼> keys to set it, then press <SET>.

4 Set the daylight saving time.

- Set it as necessary.
- Use the <◀> <▶> keys to select [**☀**], then press <SET>.
- Use the <▲> <▼> keys to select [**☀**], then press <SET>.
- When the daylight saving time is set to [**☀**], the time set in step 3 will advance by 1 hour. If [**☀**] is set, the daylight saving time will be canceled and the time will go back by 1 hour.

5 Exit the setting.

- Use the <◀> <▶> keys to select **[OK]**.



- The date, time, and time zone settings may be reset when the camera is stored without the battery, when its battery becomes exhausted, or when it is exposed to below freezing temperatures for a prolonged period. If this happens, set them once again.
- After changing **[Zone/Time difference]**, check that the correct date/time are set.
- The date/time/zone must be set to enable normal camera temperature control. Once the date/time/zone are set, temperature warnings can be displayed correctly.



- Auto power off time may be extended while the **[👉: Date/Time/Zone]** screen is displayed.

Language

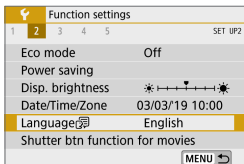

1 Select [**L**: Language].



2 Set the desired language.

Shutter Button Function for Movies

You can set the functions performed by pressing the shutter button halfway or completely during movie recording.

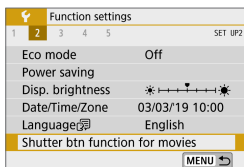

1 Select [**☺**: Shutter btn function for movies].

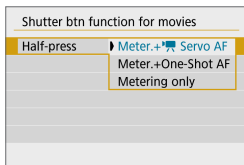

2 Select an item.

- **Half-press**

Specify the function performed by pressing the shutter button halfway.

- **Fully-press**

This item is displayed when the shooting mode switch is set to <[**☺**]>.

Specify the function performed by pressing the shutter button completely.

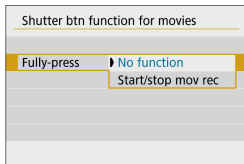

With [**Fully-press**] set to [**Start/stop mov rec**], you can start/stop movie recording with the movie shooting button or by pressing the shutter button completely.

- [**Half-press**] switches from [**Meter.+One-Shot AF**] to [**Meter.+☺ Servo AF**] when [**Movie rec. size**] is set to [**34K**].

Video System

Set the video system of any television used for display. This setting determines the frame rates available when you record movies.

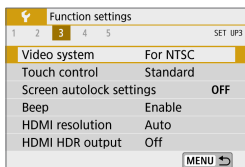

1 Select [**3**: Video system].

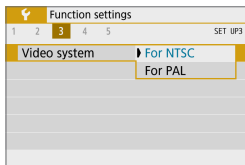

2 Select an item.

- **For NTSC**
For areas where the TV system is NTSC (North America, Japan, South Korea, Mexico, etc.).
- **For PAL**
For areas where the TV system is PAL (Europe, Russia, China, Australia, etc.).

Touch Control

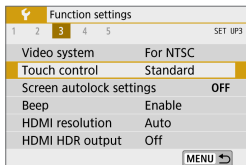

1 Select [**⏏**: Touch control].

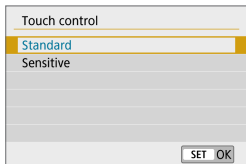

2 Select an item.

- **[Standard]** is the normal setting.
- **[Sensitive]** provides a more reactive touch-screen panel response than **[Standard]**.

⚠ Cautions for Touch Control Operations

- Do not use sharp objects such as fingernails or ballpoint pens for touch operations.
- Do not use wet fingers for touch operations. If the screen has any moisture or if your fingers are wet, the touch-screen panel may not respond or malfunction may occur. In this case, turn off the power and wipe off the moisture with a cloth.
- Attaching any commercially available protective sheet or sticker on the screen may degrade the touch operation response.
- If you quickly perform touch operation when **[Sensitive]** is set, the touch operation response may be poor.

Screen Autolock Settings

To make the camera less likely to detect unintended touch-screen operations, you can disable shooting screen touch operations after a specified period.

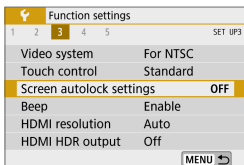

1 Select [**F**]: **Screen autolock settings**].

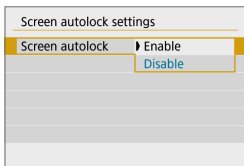

2 Set [**Screen autolock**] to [**Enable**].

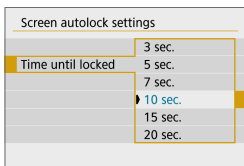

3 Set [**Time until locked**].

- Screen autolock is activated after your specified time elapses without any camera operations while the shooting screen is displayed.
- Pressing any button cancels screen autolock.



- Screen autolock is disabled when menus or playback screens are displayed, when the screen is facing subjects, and when the camera is autofocusing or shooting.

Beeping

You can disable beeping when subjects are in focus or for other operations.

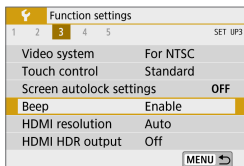

1 Select [: Beep].

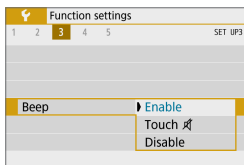

2 Select an item.

- **Touch** 

The beeper will be silent only for touch operations.

- **Disable**

Disables beeping when subjects are in focus, when shooting with the self-timer, when using touch operations, and at other times.

HDMI Resolution

Set the image output resolution used when the camera is connected to a television or external recording device with an HDMI cable.

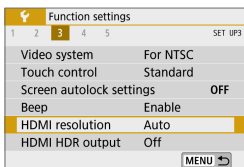

1 Select [**F**: HDMI resolution].

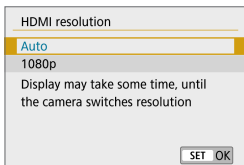

2 Select an item.

- **Auto**

The images will automatically be displayed at the optimum resolution matching the connected television.

- **1080p**

Output at 1080p resolution. Select if you prefer to avoid display or delay issues when the camera switches resolution.

HDMI HDR Output

You can view RAW images in HDR by connecting the camera to an HDR TV.

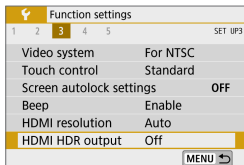

1 Select [**F**: HDMI HDR output].

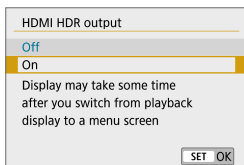

2 Select [On].



- Make sure the HDR TV is set up for HDR input. For details on how to switch inputs on the TV, refer to the TV manual.
- Depending on the TV used, images may not look as expected.
- Some image effects and information may not be displayed on an HDR TV.

Shooting Information Display

You can customize the information shown when you are shooting.

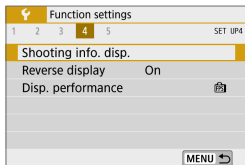

Select [**F**: Shooting info. disp.].

Grid Display

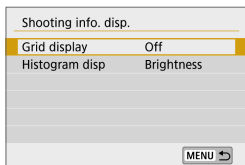

1 Select [Grid display].

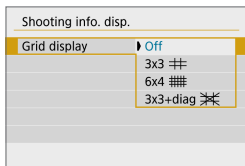

2 Select an item.

Histogram

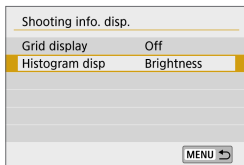

1 Select [Histogram disp].

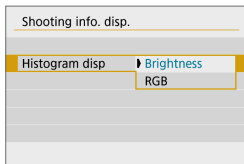

2 Select an item.

Reverse Display

A mirror image can be displayed when you shoot with the screen rotated toward the subject (toward the front of the camera).

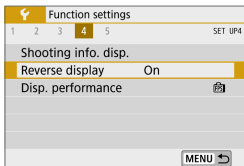

1 Select [**F**: Reverse display].

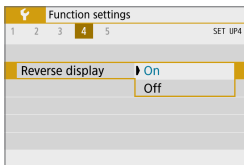

2 Select [**On**].

- Select [**Off**] if you prefer not to reverse display when the screen is rotated toward the front.

Display Performance

You can specify smooth display or power saving display in still photo shooting.

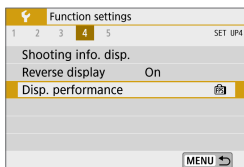

1 Select [: Disp. performance].

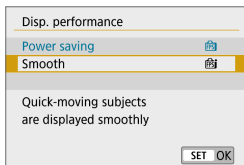

2 Select an item.



Reset Camera

You can restore default camera settings in [P], [Tv], [Av], [M], [P^u], and [M^u] shooting modes.

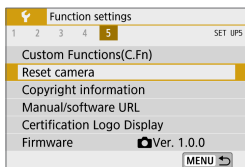

1 Select [**⚡**: Reset camera].

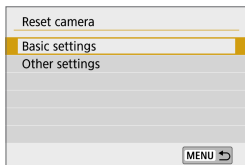

2 Select [**Basic settings**].

- To clear other settings, select [**Other settings**], then select an item.

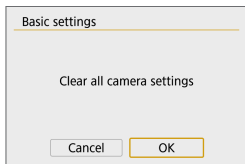

3 Select [**OK**].

- Basic settings such as [**Language** ] and [**Date/Time/Zone**] are not restored to defaults.
- Dots of light may appear in captured images or on the shooting screen if the sensor is affected by cosmic rays or similar factors. If so, it may help to reduce their appearance by doing one of the following with [**Basic settings**] selected: (1) Hold down the <⚡> button and press the <MENU> button, or (2) Select [**Basic settings**], press <SET>, then select [**OK**] (but note that (2) restores default camera settings).

Copyright Information



When you set the copyright information, it will be recorded to the image as Exif information.

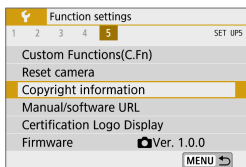

1 Select [**F**: Copyright information].



2 Select an item.

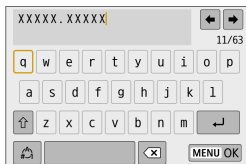

3 Enter text.

- Use the <↔> cross keys to select a character, then press <SET> to enter it.
- To switch input modes, select [**#**] and press <SET>.
- To delete the previous character, select [**X**] and press <SET>.

4 Exit the setting.

- Press the <MENU> button, then press [OK].

Checking the Copyright Information



Display copyright info.

Author
XXXX. XXXX

Copyright
Canon Inc.

MENU 

When you select **[Display copyright info.]** in step 2, you can check the **[Author]** and **[Copyright]** information that you entered.

Deleting the Copyright Information

When you select **[Delete copyright information]** in step 2, you can delete the **[Author]** and **[Copyright]** information.

-  If the entry for "Author" or "Copyright" is long, it may not be displayed entirely when you select **[Display copyright info.]**.

-  You can also set or check the copyright information with EOS Utility (EOS software).

Manual/Software URL

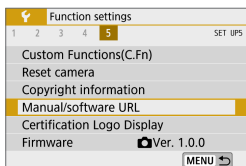

To download instruction manuals, select [**📄: Manual/software URL**] and scan the displayed QR code with a smartphone. You can also use a computer to access the website at the URL displayed and download software.

Certification Logo Display ☆

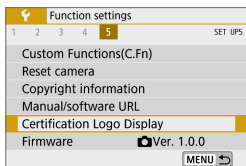

Select [**📄: Certification Logo Display**] to display some of the logos of the camera's certifications. Other certification logos can be found on the camera body and the camera's package.

Firmware ☆

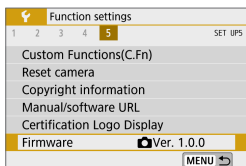

Select [**📄: Firmware**] to update the firmware of the camera or current lens.

Custom Functions (C.Fn)

You can fine-tune camera functions and change the functionality of buttons and dials to suit your shooting preferences.

Setting Custom Functions

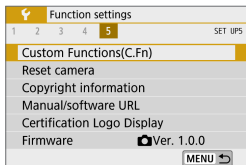

1 Select [Custom Functions(C.Fn)].



2 Select a Custom Function number (1).

- Press the <◀> <▶> keys to select the Custom Function number, then press <SET>.

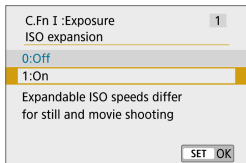

3 Change the setting as desired.

- Press the <▲> <▼> keys to select the desired setting (number), then press <SET>.
- To set up another Custom Function, repeat steps 2–3.
- At the bottom of the screen, the current Custom Function settings are indicated below the respective function numbers.

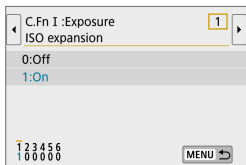

4 Exit the setting.

- Press the <MENU> button.

Clearing all Custom Functions

All Custom Function settings you have set are cleared by selecting [**Reset camera**], [**Other settings**], then [**Custom Functions(C.Fn)**] (453).

Custom Function Setting Items



Custom Functions are organized into two groups based on the function type: C.Fn I: Exposure, C.Fn II: Others.

C.Fn I: Exposure

C.Fn-1 ISO expansion

0: Off

1: On

When you set the ISO speed, you can set “H” (equivalent to ISO 51200) for still photos and “H” (equivalent to ISO 25600) for movies. Note that if [: **Highlight tone priority**] is set to **[Enable]** or **[Enhanced]**, “H” cannot be selected.



- For 4K movies, the ISO speed range is ISO 100–6400, even when **[ISO expansion]** is set to **[1: On]**.

C.Fn-2 Safety shift

0: Disable

1: Enable

You can shoot with the shutter speed and aperture value automatically adjusted to enable standard exposure if standard exposure would not be available under your specified shutter speed or aperture value in **[Tv]** or **[Av]** mode.

C.Fn II: Others

C.Fn-3 Shutter/AE lock button

0: AF/AE lock

1: AE lock/AF

This is convenient when you want to focus and meter separately.

Press the <★> button to autofocus, and press the shutter button halfway to apply AE lock.

2: AF/AF lock, no AE lock

During Servo AF, you can press the <★> button to pause the AF operation momentarily. This prevents the AF from being thrown off by any obstacle passing between the camera and subject. The exposure is set at the moment the picture is taken.

3: AE/AF, no AE lock

This is useful for subjects that keep moving and stopping repeatedly. During Servo AF, you can press the <★> button to start or stop the Servo AF operation. The exposure is set at the moment the picture is taken. Thus, you can set your camera to always maintain the optimum focusing and exposure and wait for the decisive moment.



- With setting 1 or 3, pressing the <★> button during movie recording starts One-Shot AF.

C.Fn-4 Movie shooting button function

You can change the <●> movie shooting button function during still photo shooting.

0: Movie record start/stop

1: Depth-of-field preview

Stops the lens down to the specified aperture value, enabling you to check the range of focus (depth of field).

2: Disabled

Disables the <●> button, so that pressing it has no effect.

C.Fn-5 Release shutter without lens

You can specify whether shooting still photos or movies is possible without a lens attached to the camera.

0: Disable

1: Enable

C.Fn-6 Retract lens on power off

Lens retraction setting for gear-driven EF or EF-S STM lenses (such as EF 40mm f/2.8 STM) attached to the camera. You can specify whether to retract lenses that are extended in use automatically when you turn the camera off.

0: Enable

1: Disable



- Retraction is not activated by auto power off (except for EF-M lenses).
- Before detaching the lens, make sure that it is retracted.



- When [**0:Enable**] is set, this function takes effect regardless of the lens's focus mode switch setting (AF or MF).



My Menu

Under My Menu tab, you can register menu items and Custom Functions whose settings you change frequently.

- The [**★ : My Menu**] tab is not displayed when [**Menu display**] on the [**⚙️ : Display level settings**] tab is set to [**Guided**]. To set up My Menu, change [**Menu display**] to [**Standard**].

Tab Menus: My Menu



A screenshot of a mobile application interface showing a menu titled "MY MENU: Set up". The menu items are:

- Add My Menu tab (465)
- Delete all My Menu tabs (468)
- Delete all items (468)
- Menu display Normal (469)

Four blue lines with book icons point from the page numbers 465, 468, 468, and 469 to the corresponding menu items.

Registering My Menu

Under My Menu tab, you can register menu items and Custom Functions whose settings you change frequently.

Creating and Adding My Menu Tab

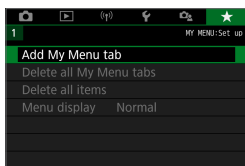

1 Select [Add My Menu tab].

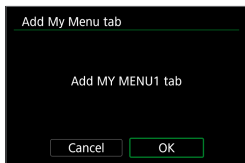

2 Select [OK].

- You can create up to five My Menu tabs by repeating steps 1 and 2.

Registering Menu Items under the My Menu Tab(s)



1 Select [★ : Configure].

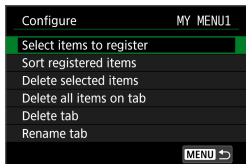

2 Select [Select items to register].

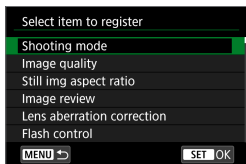

3 Register the desired items.

- Select the item to be set, then press <SET>.
- Select [OK] on the confirmation dialog.
- You can register up to six items.
- To return to the screen in step 2, press the <MENU> button.

My Menu Tab Settings

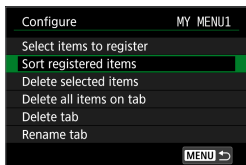

You can sort and delete items under the menu tab, and rename or delete the menu tab.

● Sort registered items

You can change the order of the registered items in My Menu.

Select [**Sort registered items**], select an item to rearrange, then press <SET>. With [**◆**] displayed, use the <▲> <▼> keys to move the item, then press <SET>.

● Delete selected items/Delete all items on tab

You can delete any of the registered items. [**Delete selected items**] deletes one item at a time, and [**Delete all items on tab**] deletes all the registered items under the tab.

● Delete tab

You can delete the current My Menu tab. Select **[Delete tab]** to delete the **[MY MENU*]** tab.

● Rename tab

You can rename the My Menu tab from **[MY MENU*]**.

1 Select [Rename tab].

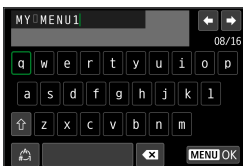

2 Enter text.

- Select [**X**] and press <SET> to delete any unneeded characters.
- Use the <⬆️⬇️⬇️⬆️> cross keys to select a character, then press <SET> to enter it.
- To switch input modes, select [**↻**] and press <SET>.

3 Confirm input.

- Press the <MENU> button, then press **[OK]**.

Deleting all My Menu tabs/Deleting all items

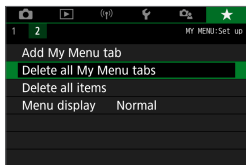

You can delete all the created My Menu tabs or My Menu items registered under them.

● Delete all My Menu tabs

You can delete all My Menu tabs you created. When you select **[Delete all My Menu tabs]**, all the tabs from **[MY MENU1]** to **[MY MENU5]** will be deleted and the **[★]** tab will revert to its default.

● Delete all items

You can delete all the items registered under the **[MY MENU1]** to **[MY MENU5]** tabs. The tab(s) will remain. When **[Delete all items]** is selected, all the items registered under all the created tabs will be deleted.

- ⚠ If you perform **[Delete tab]** or **[Delete all My Menu tabs]**, tab names renamed with **[Rename tab]** will also be deleted.

Menu Display Settings

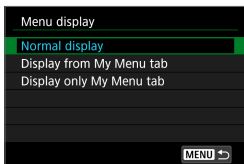

You can select **[Menu display]** to set the menu screen that is to appear first when you press the <MENU> button.

- **Normal display**

Displays the last displayed menu screen.

- **Display from My Menu tab**

Displays with the [★] tab selected.

- **Display only My Menu tab**

Only the [★] tab is displayed. (The [📷], [▶], [⏪], [🔍], and [🔧] tabs will not be displayed.)



Reference

Software

You can download the latest version of EOS software or other dedicated software from the Canon website.

Downloading and Installing the EOS Software or Other Dedicated Software

Always install the latest version of the software.

Update any previous versions that are installed by overwriting them with the latest version.



- Do not connect the camera to a computer before you install the software. The software will not be installed correctly.
- The software cannot be installed unless the computer is connected to the Internet.
- Previous versions cannot display images from this camera correctly. Also, processing RAW images from this camera is not possible.

1 Download the software.

- Connect to the Internet from a computer and access the following Canon website.

www.canon.com/icpd

- Enter the serial number on the back of the screen, then download the software.
- Decompress it on the computer.

- **For Windows**

Click the displayed installer file to start the installer.

- **For Macintosh**

A dmg file will be created and displayed. Follow the steps below to startup the installer.

- (1) Double-click the dmg file.
 - ➔ A drive icon and installer file will appear on the desktop.
If the installer file does not appear, double-click the drive icon to display it.
- (2) Double-click the installer file.
 - ➔ The installer starts.

2 Follow the on-screen instructions to install the software.

Downloading the Software Instruction Manuals

Software Instruction Manuals (PDF files) can be downloaded from the Canon website to your computer.

- **Software Instruction Manual Download Site**
www.canon.com/icpd



- **To view the Instruction Manuals (PDF files), an Adobe PDF viewing software such as Adobe Acrobat Reader DC (most recent version recommended) is required.**
 - Adobe Acrobat Reader DC can be downloaded for free from the Internet.
 - Double-click the downloaded Instruction Manual (PDF file) to open it.
 - To learn how to use PDF viewing software, refer to the software's Help section.

Importing Images to a Computer

You can use EOS software to import images from the camera to a computer. There are two ways to do this.

Connecting to a Computer via an Interface Cable (sold separately)

1 Install the software (📖 472).

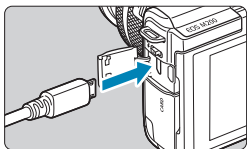

2 Connect the camera to the computer with an interface cable (sold separately).

- As an interface cable, you can use a IFC-600PCU cable (sold separately).
- Insert the cord's plug into the camera's digital terminal (USB Micro-B).
- Connect the cord's plug to the computer's USB terminal (USB Type-A).

3 Use EOS Utility to import the images.

- Refer to the EOS Utility Instruction Manual.

! ● With Wi-Fi connection established, the camera cannot communicate with the computer even if they are connected with an interface cable.

Card Reader

You can use a card reader to import images to a computer.

1 Install the software (📖 472).

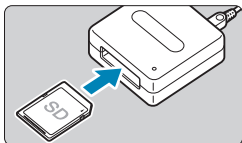

2 Insert the card into the card reader.

3 Use Digital Photo Professional to import the images.

- Refer to the Digital Photo Professional Instruction Manual.



- When downloading images from the camera to a computer with a card reader without using EOS software, copy the DCIM folder on the card to the computer.

Household Power Outlet Accessory

You can power the camera with a household power outlet by using the DC Coupler DR-E12 and Compact Power Adapter CA-PS700 (each sold separately).

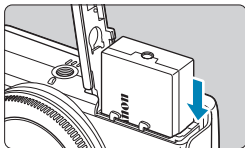

1 Insert the coupler.

- Turn the camera off.
- Open the cover and insert the coupler with the terminals facing as shown.
- Close the cover.

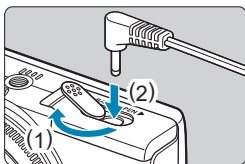

2 Connect the adapter to the coupler.

- Open the cover and insert the adapter plug fully into the coupler terminal.

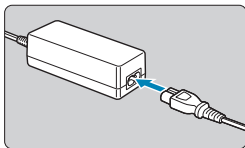

3 Connect the power cord.

- Insert one end of the power cord into the compact power adapter and plug the other end into a power outlet.
- When finished using the camera, turn it off and unplug the power cord from the outlet.

- Do not use an AC adapter other than the Compact Power Adapter CA-PS700.
- Do not plug in or unplug the adapter or power cord while the camera is on.
- When finished using the camera, turn it off and unplug the power cord from the outlet.

Troubleshooting Guide

If a problem occurs with the camera, first refer to this Troubleshooting Guide. If this Troubleshooting Guide does not resolve the problem, contact your dealer or nearest Canon Service Center.

Power-Related Problems

Batteries cannot be charged with the charger.

- Do not use any battery packs other than a genuine Canon Battery Pack LP-E12.

The battery charger's lamp blinks.

- In case of battery charger problems, the orange charge lamp blinks and a protective circuit stops charging. If this happens, unplug the charger plug from the power outlet, remove and reinsert the battery, and wait a while before plugging the charger into the power outlet again.

The camera is not activated even when turned on.

- Make sure the battery is installed properly in the camera (📖 44).
- Make sure the battery compartment cover is closed (📖 44).
- Make sure the card slot cover is closed (📖 46).
- Charge the battery (📖 42).

The access lamp is still lit when the camera is off.

- The access lamp remains on while the camera is recording images to the card. The access lamp goes off after image recording is finished, and the power turns off automatically.

The battery becomes exhausted quickly.

- Use a fully charged battery (📖 42).
- The battery performance may have degraded. If the battery performance is poor, replace the battery with a new one.
- The number of possible shots will decrease with any of the following operations:
 - Pressing the shutter button halfway for a prolonged period.
 - Activating the AF frequently without taking a picture.
 - Using the lens's Image Stabilizer.
 - Using the Wi-Fi/Bluetooth (wireless communication) function.

The camera turns off by itself.

- Auto power off is in effect. To deactivate auto power off, set **[Auto power off]** under [**🔋: Power saving**] to **[Disable]** (📖 436).
- Even if **[Auto power off]** is set to **[Disable]**, the screen will still turn off after the camera is left idle for the time set in **[Display off]**, but the camera will remain on.
- Set [**🔋: Eco mode**] to **[Off]**.

Shooting-Related Problems

The lens cannot be attached.

- To attach EF/EF-S lenses, you will need a mount adapter. The camera cannot be used with RF lenses.

No images can be shot or recorded.

- Make sure the card is properly inserted (📖 46).
- Slide the card's write-protect switch to the Write/Erase setting (📖 46).
- If the card is full, replace the card or delete unnecessary images to make space (📖 46, 📖 277).
- Shooting is not possible if the AF point turns orange when you attempt to focus. Press the shutter button halfway again to refocus automatically, or focus manually (📖 57, 📖 185).











The card cannot be used.

- If a card error message is displayed, see 📖 48 or 📖 493.

An error message is displayed when the card is inserted in another camera.

- Since SDXC cards are formatted in exFAT, if you format a card with this camera and then insert it into another camera, an error may be displayed and it may not be possible to use the card.

The image is out of focus or blurred.

- Set [: **Focus mode**] to [**AF**] ( 182).
- When using a lens with a focus mode switch, set the switch to <AF> ( 55).
- Press the shutter button gently to prevent camera shake ( 57).
- In [: **IS settings**], set [**IS mode**] to [**On**] ( 188).
- When using a lens with an Image Stabilizer switch, set the switch to <ON> ( 188).
- In low light, the shutter speed may become slow. Use a faster shutter speed ( 106), set a higher ISO speed ( 138), use flash ( 243), or use a tripod.
- See “Minimizing Blurred Photos” on  75.

I cannot lock the focus and recompose the shot.

- Set the AF operation to One-Shot AF. Shooting with the focus locked is not possible with Servo AF ( 76,  167).

The continuous shooting speed is slow.

- The continuous shooting speed for continuous shooting may be lower, depending on conditions such as these: battery level, temperature, shutter speed, aperture, subject conditions, brightness, AF operation, type of lens, use of flash, and shooting settings ( 134).



The maximum burst during continuous shooting is lower.

- If you shoot a subject that has fine detail such as a field of grass, the file size will be larger, and the actual maximum burst may be lower than the number listed on  495.





Even after I change the card, the maximum burst displayed for continuous shooting does not change.

- The maximum burst displayed does not change when you switch cards, even if you switch to a high-speed card. The maximum burst shown in the table on  495 is based on Canon's testing card. (The faster the card's writing speed, the higher the actual maximum burst will be.) For this reason, the maximum burst displayed may differ from the actual maximum burst.

Even if I set a decreased exposure compensation, the image comes out bright.

- Set [: **Auto Lighting Optimizer**] to [**Disable**] ( 141). When [**Low**], [**Standard**], or [**High**] is set, even if you set a decreased exposure compensation or flash exposure compensation, the image may come out bright.

ISO 100 cannot be set. ISO speed expansion cannot be selected.

- When [: **Highlight tone priority**] is set to [**Enable**] or [**Enhanced**], the available ISO speed range starts at ISO 200.
- When [: **Highlight tone priority**] is set to [**Enable**] or [**Enhanced**], H (expanded ISO speed) is not available, even with [**ISO expansion**] in [: **Custom Functions(C.Fn)**] set to [**1: On**].
- When [: **Highlight tone priority**] is set to [**Disable**], you can set ISO 100/125/160 or H (expanded ISO speed).

I cannot set the exposure compensation when both manual exposure and ISO Auto are set.

- See  111 to set the exposure compensation.

Not all the lens aberration correction options are displayed.

- Although [**Chromatic aberr corr**] and [**Diffraction correction**] are not displayed when [**Digital Lens Optimizer**] is set to [**Enable**], both functions are applied in shooting, as when set to [**Enable**].
- During movie recording, [**Distortion correction**], [**Digital Lens Optimizer**], or [**Diffraction correction**] will not be displayed.

The flash does not fire.

- Shooting with the flash may be temporarily disabled to protect the flash head if the flash is used repeatedly over a short period.

Using flash in [**Av**] or [**P**] mode lowers the shutter speed.

- To provide standard exposure for subjects and backgrounds, the shutter speed is automatically reduced (slow-sync shooting) for shots under low light in night scenes or with similar backgrounds. To prevent a slow shutter speed, under [**Flash control**], set [**Slow synchro**] to [**1/200-1/60sec. auto**] or [**1/200 sec. (fixed)**] ( 250).



The specified exposure changes when I shoot with ISO Auto using flash.

- When there is a risk of overexposure in flash photography, shutter speed or ISO speed is automatically adjusted to reduce loss of detail in highlights and shoot at standard exposure. In flash shots with certain lenses, shutter speeds and ISO speeds displayed when you press the shutter button halfway may not match the actual settings used. This may alter the brightness of backgrounds that are out of flash range.
- To avoid shooting at different shutter speeds or ISO speeds than displayed when you press the shutter button halfway in [**P**], [**Tv**], [**Av**], or [**M**] mode, shoot with a manually set ISO speed.

Remote control shooting is not possible.

- When taking still photos, set the drive mode to  (📖 135).
When recording movies, set **[CAM: Remote control]** to **[Enable]** (📖 235).
- Check the position of the remote control's release timing switch.
- If you are using Wireless Remote Control BR-E1, see 📖 191, 📖 387.







A white or red icon is displayed during still photo shooting.

- It indicates that the camera's internal temperature is high. Image quality of still photos may be worse when a white  icon is displayed. If the red  icon is displayed, it indicates that the shooting will soon stop automatically (📖 192).

During movie recording, the red icon is displayed.

- It indicates that the camera's internal temperature is high. If the red  icon is displayed, it indicates that the movie recording will soon stop automatically (📖 240).

is displayed.

-  may be displayed after repeated movie recording, or if you keep the camera standing by for movie recording over extended periods (except when set to  / ).
The camera turns off automatically in approx. 3 min. if you continue recording while  is displayed. The camera may also turn off automatically while standing by for movie recording when  is displayed. Turn off the camera when  is displayed, and wait to allow the camera to cool down.
- The date/time/zone must be set to enable normal camera temperature control. Once the date/time/zone are set, temperature warnings can be displayed correctly.
- If **[Overheated! Shutting down.]** is displayed, turn off the camera and wait at least 3 min. Note that the camera should be off for 9 min. or more if you will record a 4K movie up to 9 min. 59 sec. or a high frame rate movie up to 7 min. 29 sec. (Actual movie recording times may be shorter, depending on the recording environment and conditions of use.)





Movie recording stops by itself.

- If the card's writing speed is slow, movie recording may stop automatically. For cards that can record movies, see  497. To find out the card's writing speed, refer to the card manufacturer's website, etc.
- If you record a 4K movie for 9 min. 59 sec. or a Full HD/HD movie for 29 min. 59 sec., the movie recording stops automatically.

The ISO speed cannot be set for movie recording.

- ISO speed is set automatically in [] recording mode. In [M] mode, you can manually set the ISO speed ( 499).

ISO 100 cannot be set or ISO speed expansion cannot be selected during movie recording.

- When [: **Highlight tone priority**] is set to **[Enable]**, the available ISO speed range starts at ISO 200.
- H (expanded ISO speed) is not available when [: **Highlight tone priority**] is set to **[Enable]**, even with **[ISO expansion]** in [: **Custom Functions(C.Fn)**] set to **[1: On]**.
- When [: **Highlight tone priority**] is set to **[Disable]**, you can set ISO 100/125/160 or H (expanded ISO speed).
- H (expanded ISO speed) is not available (not displayed) in 4K movie recording.

The exposure changes during movie recording.

- If you change the shutter speed or aperture during movie recording, the changes in the exposure may be recorded.
- Recording a few test movies is recommended if you intend to perform zooming during movie recording. Zooming as you record movies may cause exposure changes or lens sounds to be recorded, an uneven audio level, or loss of focus.

The image flickers or horizontal stripes appear during movie recording.

- Flickering, horizontal stripes (noise), or irregular exposures can be caused by fluorescent lighting, LED lighting, or other light sources during movie recording. Also, changes in the exposure (brightness) or color tone may be recorded. In **[M]** mode, a slow shutter speed may reduce the problem. The problem may be more noticeable in time-lapse movie recording.

The subject looks distorted during movie recording.

- If you move the camera to the left or right (panning) or shoot a moving subject, the image may look distorted. The problem may be more noticeable in time-lapse movie recording.

I cannot take still photos during movie recording.

- Still photos cannot be taken with the shooting mode switch set to **<M>**. Before taking still photos, set the switch to **<A>**, then select a shooting mode for still photos.

Problems with Wireless Features

Cannot pair with a smartphone.

- Use a smartphone compliant with Bluetooth Specification Version 4.1 or later.
- Turn on Bluetooth from the smartphone settings screen.
- Pairing with the camera is not possible from the smartphone's Bluetooth settings screen. Install the dedicated app Camera Connect (free of charge) on the smartphone (📖 322).
- A previously paired smartphone cannot be paired with the camera again if the camera's registration is retained on the smartphone. In this case, remove the camera's registration retained in the Bluetooth settings on the smartphone and try pairing again (📖 329).

Wi-Fi function cannot be set.

- If the camera is connected to a computer or another device with an interface cable, Wi-Fi functions cannot be set. Disconnect the interface cable before setting any functions (📖 318).

A device connected with an interface cable cannot be used.

- Other devices, such as computers, cannot be used with the camera by connecting them with an interface cable while the camera is connected to devices via Wi-Fi. Terminate the Wi-Fi connection before connecting the interface cable.

Operations such as shooting and playback are not possible.





- With a Wi-Fi connection established, operations such as shooting and playback may not be possible. Terminate the Wi-Fi connection, then perform the operation.

Cannot reconnect to a smartphone.

- Even with a combination of the same camera and smartphone, if you have changed the settings or selected a different setting, reconnection may not be established even after selecting the same SSID. In this case, delete the camera connection settings from the Wi-Fi settings on the smartphone and set up a connection again.
- A connection may not be established if Camera Connect is running when you reconfigure connection settings. In this case, quit Camera Connect for a moment and then restart it.

Operation Problems

A camera button or dial does not work as expected.

- For movie recording, check the [: **Shutter btn function for movies**] setting ( 442).
- Check settings for [**Shutter/AE lock button**] and [ **Movie shooting button function**] in [: **Custom Functions(C.Fn)**] ( 460).

Display Problems

The menu screen shows fewer tabs and items.

- Some tabs and items are not displayed in [**A+**], [**sRGB**], Special scene, and Creative filters modes. Tabs and items on the menu screen also vary for still photos and movies.
- The [**★ : My Menu**] tab is not displayed when [**Menu display**] on the [**⚙️ : Display level settings**] tab is set to [**Guided**]. To set up My Menu, change [**Menu display**] to [**Standard**].

The display starts with [**★**] My Menu, or the [**★**] tab alone is displayed.

- [**Menu display**] on the [**★**] tab is set to [**Display from My Menu tab**] or [**Display only My Menu tab**]. Set [**Normal display**] (📖 469).

The file name's first character is an underscore (“_”).

- Set [**📷 : Color space**] to [**sRGB**]. If [**Adobe RGB**] is set, the first character will be an underscore (📖 153).

The file name starts with “MVI_”.

- It is a movie file.

The file numbering does not start from 0001.

- If the card already contains recorded images, the image number may not start from 0001 (📖 428).

The shooting date and time displayed are incorrect.

- Make sure the correct date and time are set (📖 438).
- Check the time zone and daylight saving time (📖 438).

The date and time are not in the image.

- The shooting date and time do not appear in the image. The date and time are recorded in the image data as shooting information. When printing, you can imprint the date and time in the picture, using the date and time recorded in the shooting information (📖 284).

[###] is displayed.

- If the number of images recorded on the card exceeds the number the camera can display, [###] will be displayed.

The screen does not display a clear image.

- If the screen is dirty, use a soft cloth to clean it.
- The screen display may seem slightly slow in low temperatures or may look black in high temperatures. It will return to normal at room temperature.

Playback Problems

A red box is displayed on the image.

- [▶]: **AF point disp.** is set to [Enable] (📖 314).

During image playback, the AF points are not displayed.

- The AF points are not displayed when the following types of images are played back:
 - Images captured in [📷] or [📷] Special scene modes.
 - Images captured in [📷], [📷], [📷], or [📷] Creative filters modes.
 - Images taken with Multi Shot Noise Reduction applied.
 - Cropped images.

The image cannot be erased.

- If the image is protected, it cannot be erased (📖 272).

Still photos and movies cannot be played back.

- The camera may not be able to play back images taken with another camera.
- Movies edited with a computer cannot be played back with the camera.

Only few images can be played back.

- The images have been filtered for playback with [▶]: **Set image search conditions** (📖 308). Clear the image search conditions.

Operation sound and mechanical sound can be heard during movie playback.

- If you operate the camera's dials or lens during movie recording, the operation sound will also be recorded.

The movie appears to freeze momentarily.

- If there is a drastic change in the exposure level during autoexposure movie recording, the recording will stop momentarily until the brightness stabilizes. In this case, shoot in the [M] mode (📖 200).

No picture appears on the television.

- Make sure [**4**: **Video system**] is set to [**For NTSC**] or [**For PAL**] correctly for the video system of your television (📖 443).
- Make sure the HDMI cable's plug is inserted all the way in (📖 270).

There are multiple movie files for a single movie recording.

- If the movie file size reaches 4 GB, another movie file will be created automatically (📖 210). However, if you use an SDXC card formatted with the camera, you can record a movie in a single file even if it exceeds 4 GB.

My card reader does not recognize the card.

- Depending on the card reader used and the computer's operating system, SDXC cards may not be correctly recognized. In this case, connect your camera to the computer with the interface cable, then import the images to the computer using EOS Utility (EOS software).

The image cannot be resized.

- With this camera, you cannot resize JPEG **S2** and RAW images (📖 302).

The image cannot be cropped.

- With this camera, you cannot crop RAW images (📖 300).

Computer Connection Problems

I cannot import images to a computer.

- Install EOS Utility (EOS software) in the computer (📖 472).
- If the camera is already connected via Wi-Fi, it cannot communicate with any computer connected with an interface cable.

Communication between the connected camera and computer does not work.

- When using EOS Utility (EOS software), set [: Time-lapse movie] to [Disable] (📖 215).

Error Codes

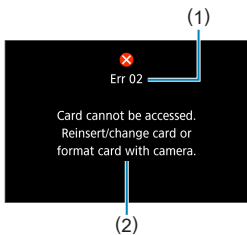

If there is a problem with the camera, an error message will appear. Follow the on-screen instructions. If the problem persists, write down the error code (Err xx) and contact a Canon Service Center.

- (1) Error number
- (2) Cause and countermeasures

Performance Data

Still Photo Shooting

● Number of Possible Shots

Approx. 315 shots (at a room temperature of 23°C/73°F)

- Based on using the screen and a fully charged Battery Pack LP-E12, and following CIPA (Camera & Imaging Products Association) testing standards.

● ISO Auto Range

Shooting Mode	ISO Speed	
	No Flash	With Flash
P/Tv/Av/M	ISO 100–25600*	ISO 100–1600*

* Varies depending on **[Max for Auto]** setting.

- ISO speed is set automatically in **[A+]**, **[A]**, Special scene, and Creative filters modes.
- For bulb exposure, the value is automatically set to ISO 400.

● Guide to Image Quality Settings

(Approx.)

Image Quality	Pixels Recorded	File Size (MB)	Possible Shots	Maximum Burst
JPEG				
L	24M	8.4	3600	71
L		4.5	6610	71
M	11M	4.6	6480	70
M		2.6	11400	70
S1	5.9M	3.1	9690	70
S1		1.8	16010	70
S2	3.8M	1.8	16340	70
RAW				
RAW	24M	27.2	1120	13
CRAW	24M	15.8	1930	31
RAW+JPEG				
RAW L	24M 24M	27.2+8.4	850	12
CRAW L	24M 24M			
CRAW L	24M 24M	15.8+8.4	1250	22

- Number of possible shots and maximum burst as measured using a 32 GB UHS-I card conforming to Canon testing standards.
- File size, number of possible shots, and maximum burst vary depending on shooting conditions (such as aspect ratio, subject, memory card brand, ISO speed, Picture Style, Custom Functions, and other settings).



- Even if you use a high-speed SD card, maximum burst indicator will not change. The maximum burst in the table will apply instead.

● Pixel Count at Specific Aspect Ratios

(Approx. pixels)

Image Quality	3:2	4:3
RAW / CRAW	6000×4000 (24.0 megapixels)	6000×4000 (24.0 megapixels)
L	6000×4000 (24.0 megapixels)	5328×4000 (21.3 megapixels)*
M	3984×2656 (10.6 megapixels)	3552×2664 (9.5 megapixels)
S1	2976×1984 (5.9 megapixels)	2656×1992 (5.3 megapixels)
S2	2400×1600 (3.8 megapixels)	2112×1600 (3.4 megapixels)*

Image Quality	16:9	1:1
RAW / CRAW	6000×4000 (24.0 megapixels)	6000×4000 (24.0 megapixels)
L	6000×3368 (20.2 megapixels)*	4000×4000 (16.0 megapixels)
M	3984×2240 (8.9 megapixels)*	2656×2656 (7.1 megapixels)
S1	2976×1680 (5.0 megapixels)*	1984×1984 (3.9 megapixels)
S2	2400×1344 (3.2 megapixels)*	1600×1600 (2.6 megapixels)

- The image area displayed for the asterisked "*" aspect ratio may be slightly different from the actual image area. Check the captured images on the screen during shooting.

- The actual aspect ratio of images in the sizes marked with an asterisk "*" will differ from the aspect ratio indicated.
- For details on JPEG file sizes, see the values on [p. 495](#). Under equivalent shooting conditions, file sizes will be smaller than when **[CAMERA] : Still img aspect ratio** is set to **[3:2]**.

Movie Recording

● Cards that Can Record Movies

Movie Recording Size			SD Card
4K	23.98P 25.00P	1PB	UHS-I, UHS Speed Class 3 or higher
FHD	59.94P 50.00P	1PB	SD Speed Class 10 or higher
	29.97P 25.00P	1PB	SD Speed Class 4 or higher
HD	119.9P 100.0P	1PB	SD Speed Class 10 or higher
	59.94P 50.00P	1PB	SD Speed Class 4 or higher

- When [Digital IS] is disabled.
- This table indicates the card's writing and reading speeds required for recording movies (card performance requirements).

● Total Movie Recording Time and File Size Per Minute

(Approx.)

Movie Recording Size				Total Possible Recording Time on Card			File Size
				8 GB	32 GB	128 GB	
4K	23.98P	25.00P	IPB	8 min.	35 min.	2 hr. 21 min.	860 MB/min.
	59.94P	50.00P	IPB	17 min.	1 hr. 10 min.	4 hr. 43 min.	431 MB/min.
FHD	29.97P	25.00P	IPB	35 min.	2 hr. 20 min.	9 hr. 23 min.	216 MB/min.
	119.9P	100.0P	IPB	20 min.	1 hr. 22 min.	5 hr. 28 min.	371 MB/min.
EHD	59.94P	50.00P	IPB	40 min.	2 hr. 42 min.	10 hr. 49 min.	187 MB/min.

- When [Digital IS] is disabled.



- An increase of the camera's internal temperature may cause movie recording to stop before the total recording time shown in the table (240).

● Total Possible Time for Movie Recording

Approx. 90 min. (at a room temperature of 23°C/73°F)

- With a fully charged Battery Pack LP-E12.
- With [Movie rec. size] under [: Movie rec quality] set to [FHD 29.97P IPB] (NTSC) or [FHD 25.00P IPB] (PAL), and with [: Movie Servo AF] set to [Enable].

ISO Speed in Movie Recording

In [P] mode, when set to ISO Auto

- ISO speed is automatically set in a range of ISO 100–12800 for Full HD/HD movies and ISO 100–6400 for 4K movies.
- The maximum value in the automatic setting range is expanded to H (equivalent to ISO 25600) in Full HD/HD movie recording when **[ISO expansion]** in [P: Custom Functions(C.Fn)] is set to **[1: On]** (145) and then **[Max for Auto]** in [C: ISO speed settings] is set to **[H (25600)]** (236). Note that in 4K movie recording, maximum ISO speed expansion is not available (**[Max for Auto]** is not available), even with **[ISO expansion]** set to **[1: On]**.
- With [C: Highlight tone priority] set to **[Enable]** (142), the minimum value in the automatic setting range is ISO 200. Maximum ISO speed expansion is not performed, even with **[Max for Auto]** set to **[H (25600)]**.

In [M] mode with ISO speed set manually

- ISO speed can be set manually in a range of ISO 100–12800 for Full HD/HD movies and ISO 100–6400 for 4K movies.
- The maximum value in the manual setting range is expanded to H (equivalent to ISO 25600) in Full HD/HD movie recording with **[ISO expansion]** in [P: Custom Functions(C.Fn)] set to **[1: On]**. Note that in 4K movie recording, maximum ISO speed expansion is not available (**[H]** is not displayed), even with **[ISO expansion]** set to **[1: On]**.
- With [C: Highlight tone priority] set to **[Enable]** (142), the minimum value in the manual setting range is ISO 200. Maximum ISO speed expansion is not performed, even with **[ISO expansion]** set to **[1: On]**.

Image Playback

● Resize Options by Original Image Quality

Original Image Quality	Available Resize Settings		
	M	S1	S2
L	<input type="radio"/>	<input type="radio"/>	<input type="radio"/>
M		<input type="radio"/>	<input type="radio"/>
S1			<input type="radio"/>

● Size for Resized Images

(Approx. pixels)

Image Quality	3:2	4:3
M	3984×2656 (10.6 megapixels)	3552×2664 (9.5 megapixels)
S1	2976×1984 (5.9 megapixels)	2656×1992 (5.3 megapixels)
S2	2400×1600 (3.8 megapixels)	2112×1600 (3.4 megapixels)*

Image Quality	16:9	1:1
M	3984×2240 (8.9 megapixels)*	2656×2656 (7.1 megapixels)
S1	2976×1680 (5.0 megapixels)*	1984×1984 (3.9 megapixels)
S2	2400×1344 (3.2 megapixels)*	1600×1600 (2.6 megapixels)



- The actual aspect ratio of images in the sizes marked with an asterisk "*" will differ from the aspect ratio indicated.
- The image may be cropped slightly depending on the resizing conditions.

Information Display

Still Photo Shooting Screen

Each time you press the <INFO> button, the information display will change.

- The display will show only the settings currently applied.

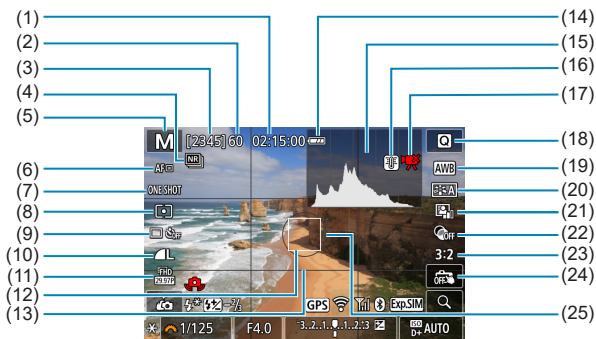

(1) Movie recording time available

(2) Maximum burst

(3) Possible shots/Sec. until self-timer shoots

(4) Multi Shot Noise Reduction

(5) Shooting mode/Scene icon

(6) Focus method

(7) AF operation

(8) Metering mode

(9) Drive mode/Self-timer

(10) Image quality

(11) Movie recording size

(12) AF point

(13) Grid lines

(14) Battery level

(15) Histogram

(16) Temperature warning

(17) Limited movie recording available

(18) Quick Control

(19) White balance/White balance correction

(20) Picture Style

(21) Auto Lighting Optimizer

(22) Creative filters

(23) Still image aspect ratio

(24) Touch Shutter

(25) Metering area

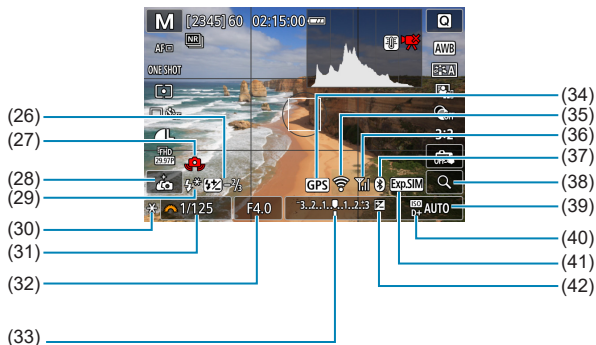

(26) Flash exposure compensation/
Flash output level

(27) Camera shake warning

(28) Self Portrait

(29) Flash mode/FE lock

(30) AE lock

(31) Shutter speed

(32) Aperture value

(33) Exposure level indicator

(34) GPS acquisition status

(35) Wi-Fi function

(36) Wi-Fi signal strength/Airplane
mode

(37) Bluetooth function

(38) Magnify button

(39) ISO speed

(40) Highlight tone priority

(41) Exposure simulation

(42) Exposure compensation



- Other icons may be displayed temporarily after setting adjustments.

Movie Recording Screen

Each time you press the <INFO> button, the information display will change.

- The display will show only the settings currently applied.

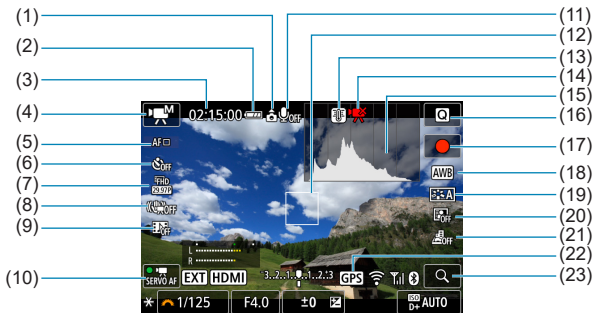

- | | |
|---|--|
| (1) Movie orientation information | (13) Temperature warning |
| (2) Battery level | (14) Limited movie recording available |
| (3) Movie recording time available/
Elapsed recording time | (15) Histogram (for manual exposure) |
| (4) Recording mode/Time-lapse
movie | (16) Quick Control |
| (5) Focus method | (17) Movie recording start button |
| (6) Movie self-timer | (18) White balance/White balance
correction |
| (7) Movie recording size | (19) Picture Style |
| (8) Movie digital IS | (20) Auto Lighting Optimizer |
| (9) Video snapshot | (21) Miniature effect movie |
| (10) Movie Servo AF | (22) GPS acquisition status |
| (11) Sound recording off | (23) Magnify button |
| (12) AF point | |

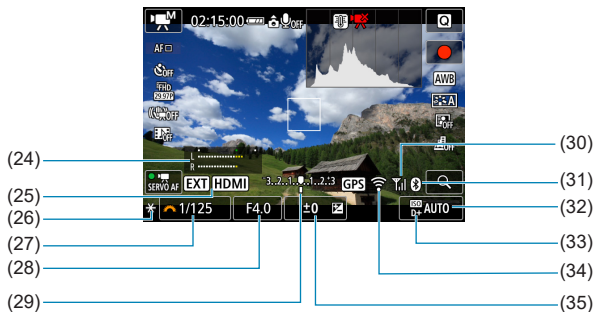

(24) Sound-recording level indicator (manual)

(25) Output without information display

(26) AE lock

(27) Shutter speed

(28) Aperture value

(29) Exposure level indicator

(30) Wi-Fi signal strength/Airplane mode

(31) Bluetooth function

(32) ISO speed

(33) Highlight tone priority

(34) Wi-Fi function

(35) Exposure compensation

- ❗ • The grid, or histogram cannot be displayed during movie recording. (The display will disappear when you start recording a movie.)
- When movie recording starts, the movie recording time available will change to the elapsed recording time.

- 📄 • Other icons may be displayed temporarily after setting adjustments.

Scene Icons

In the [A+] or [A] shooting mode, the camera detects the scene type and sets everything automatically to suit the scene. The detected scene type is indicated on the upper left of the screen.

Background \ Subject	Portrait		Non-Portrait			Background Color
		In Motion* ¹	Nature/ Outdoor Scene	In Motion* ¹	Close* ²	
Bright						Gray
Backlit						
Blue Sky Included						Light blue
Backlit						
Sunset	* ³			* ³		Orange
Spotlight						Dark blue
Dark						
With Tripod* ¹	* ⁴ * ⁵	* ³	* ⁴ * ⁵	* ³		

*1: Not displayed during movie recording.

*2: Displayed when the attached lens has distance information. With an extension tube or close-up lens, the icon displayed may not match the actual scene.

*3: The icon of the scene selected from the detectable scenes will be displayed.

*4: Displayed when all the following conditions apply:

The shooting scene is dark, it is a night scene, and the camera is mounted on a tripod.

*5: Displayed with any of the lenses below:

- EF300mm f/2.8L IS II USM
- EF400mm f/2.8L IS II USM
- EF500mm f/4L IS II USM
- EF600mm f/4L IS II USM
- Image Stabilizer lenses released in and after 2012.

*4+*5: If the conditions in both *4 and *5 are met, the shutter speed will slow down.



- For certain scenes or shooting conditions, the icon displayed may not match the actual scene.

Playback Screen

● Basic information display for still photos



- (1) Wi-Fi function
- (2) Wi-Fi signal strength/Airplane mode
- (3) Battery level
- (4) Playback No./Total images/
Number of found images
- (5) Shutter speed
- (6) Aperture value
- (7) Exposure compensation amount
- (8) Bluetooth function

- (9) Already sent to a computer/
smartphone
- (10) Rating
- (11) Image protection
- (12) Folder number-File number
- (13) Image quality/Edited image/
Cropping
- (14) Highlight tone priority
- (15) ISO speed

- ❗ If the image was taken by another camera, certain shooting information may not be displayed.
- It may not be possible to play back images taken with this camera on other cameras.

● Detailed information display for still photos

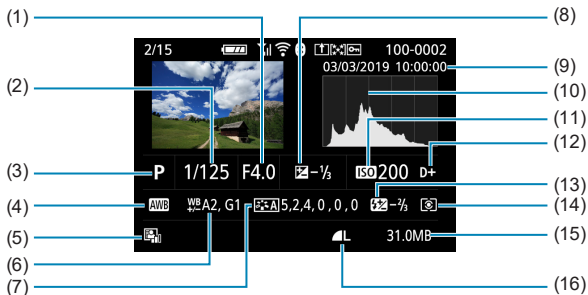

(1) Aperture value
(2) Shutter speed
(3) Shooting mode
(4) White balance
(5) Auto Lighting Optimizer
(6) White balance correction
(7) Picture Style/Settings
(8) Exposure compensation amount
(9) Shooting date and time

(10) Histogram
(11) ISO speed
(12) Highlight tone priority
(13) Flash exposure compensation/ HDR shooting/Multi Shot Noise Reduction
(14) Metering mode
(15) File size
(16) Image quality/Edited image/ Cropping

* When you shoot in RAW+JPEG image quality, the RAW image file size will be displayed.

* Lines indicating the image area will be displayed for images taken with the aspect ratio set (125) and with RAW or RAW+JPEG set for image quality.

* During flash photography without flash exposure compensation, [] will be displayed.

* [] will be displayed for images shot with Multi Shot Noise Reduction.

* [] will be displayed for images created and saved after performing resizing, cropping, Creative Assist, or red-eye correction.

* [] will be displayed for images cropped and then saved.

● Detailed information display for movies

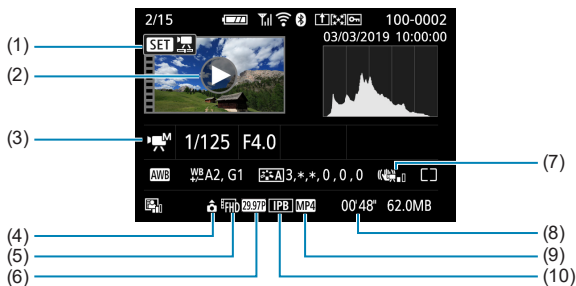

- (1) Quick Control
- (2) Movie playback
- (3) Recording mode/Time-lapse movie/Video snapshot
- (4) Movie orientation information
- (5) Image size

- (6) Frame rate
- (7) Movie digital IS
- (8) Recording time
- (9) Movie recording format
- (10) Compression method

● During movie playback, “*,” “*” will be displayed for **[Fineness]** and **[Threshold]** of **[Picture Style]**'s **[Sharpness]**.

Trademarks

- Adobe is a trademark of Adobe Systems Incorporated.
- Microsoft and Windows are trademarks or registered trademarks of Microsoft Corporation in the United States and/or other countries.
- Macintosh and Mac OS are trademarks of Apple Inc., registered in the U.S. and other countries.
- SDXC logo is a trademark of SD-3C, LLC.
- HDMI, HDMI logo, and High-Definition Multimedia Interface are trademarks or registered trademarks of HDMI Licensing LLC.
- The Wi-Fi CERTIFIED logo and the Wi-Fi Protected Setup mark are trademarks of the Wi-Fi Alliance.
- WPS used on camera settings screens and in this manual stands for Wi-Fi Protected Setup.
- The Bluetooth® word mark and logos are registered trademarks owned by Bluetooth SIG, Inc. and any use of such marks by Canon Inc. is under license. Other trademarks and trade names are those of their respective owners.
- All other trademarks are the property of their respective owners.

About MPEG-4 Licensing

“This product is licensed under AT&T patents for the MPEG-4 standard and may be used for encoding MPEG-4 compliant video and/or decoding MPEG-4 compliant video that was encoded only (1) for a personal and non-commercial purpose or (2) by a video provider licensed under the AT&T patents to provide MPEG-4 compliant video. No license is granted or implied for any other use for MPEG-4 standard.”

THIS PRODUCT IS LICENSED UNDER THE AVC PATENT PORTFOLIO LICENSE FOR THE PERSONAL USE OF A CONSUMER OR OTHER USES IN WHICH IT DOES NOT RECEIVE REMUNERATION TO (i) ENCODE VIDEO IN COMPLIANCE WITH THE AVC STANDARD (“AVC VIDEO”) AND/OR (ii) DECODE AVC VIDEO THAT WAS ENCODED BY A CONSUMER ENGAGED IN A PERSONAL ACTIVITY AND/OR WAS OBTAINED FROM A VIDEO PROVIDER LICENSED TO PROVIDE AVC VIDEO. NO LICENSE IS GRANTED OR SHALL BE IMPLIED FOR ANY OTHER USE. ADDITIONAL INFORMATION MAY BE OBTAINED FROM MPEG LA, L.L.C. SEE

[HTTP://WWW.MPEGLA.COM](http://www.mpegla.com)

* Notice displayed in English as required.

Use of Genuine Canon Accessories Is Recommended

This product is designed to achieve optimum performance when used with genuine Canon accessories. Therefore, using this product with genuine accessories is highly recommended.

Canon shall not be liable for any damage to this product and/or accidents such as malfunction, fire, etc. caused by the failure of non-genuine Canon accessories (e.g., a leakage and/or explosion of a battery). Please note that repairs arising out of the malfunction of non-genuine accessories will not be covered by the warranty for repairs, although you may request such repairs on a chargeable basis.



- Battery Pack LP-E12 is dedicated to Canon products only. Using it with an incompatible battery charger or product may result in malfunction or accidents for which Canon cannot be held liable.

Index

Numbers

1-point AF : 170, 175

[4K] 3840×2160 (Movie) : 205

4K frame capture : 266

A

Access lamp : 45, 47

Accessories : 3

Add movie orientation/rotation info : 432

Adobe RGB : 153

Advanced shooting modes : 103

AE lock : 189

AF

AF-assist beam : 169, 184

AF method : 170

AF operation : 167

AF point selection : 175

Area AF frame : 86

Beep (Beeper) : 446

Continuous AF : 181

Eye detection AF : 180

Lens electronic MF : 183

Manual focus : 185

Recomposing : 76

Album (video snapshot) : 224, 297

ALL-I : 207

Ambience priority (AWB) : 149

Angle of view : 53

Aperture-priority AE : 108

Area AF frame : 86

Art bold effect : 293

<A+> (Scene Intelligent Auto) : 72

Aspect ratio → Still image aspect ratio

Attenuator : 214

Autofocus → AF

Auto Lighting Optimizer : 141

Auto power off : 436

Auto reset : 430

Auto rotate : 431

Av (Aperture-priority AE) : 108

B

Background music : 299

Basic information display : 506

Basic shooting modes : 71

Battery → Power

Beep (Beeper) : 446

Bluetooth function : 321, 387

Address : 394

Connecting : 323

Bulb exposure : 112

BUSY : 124

C

Camera

Camera vibration blur : 113, 136

Default settings : 453

Holding the camera : 56

Camera shake : 57, 75

Card requirements : 208, 497

Cards : 11, 35, 46

Formatting : 433

Low-level formatting : 433

Troubleshooting : 48, 479

Write protection : 46

Center-weighted average metering : 143

Certification Logo : 456

Charger : 42

Charging : 42

Chromatic aberration correction : 131

Close-up : 87

Color space : 153

Color temperature : 151

Color tone : 158

Combination IS : 234

Continuous (file numbering) : 429

Continuous shooting : 133
 Contrast : 141, 158
 Copyright information : 454
 Creative Assist : 78, 294
 Creative filters : 291
 Cropping (images) : 300
 Custom Functions : 457
 Custom white balance : 150

D

Date/time : 438
 Daylight saving time : 439
 DC coupler : 476
 Default settings : 453
 Custom Functions : 458
 Flash function settings : 252
 My Menu : 468
 Wireless communication : 402
 Depth-of-field preview : 109
 Dial : 58
 Diffraction correction : 131
 Digital Lens Optimizer : 130
 Digital terminal : 474
 Display level : 60
 Display off : 436
 Distortion correction : 129
 Double-tap : 258
 DPOF (Digital Print Order Format) : 284
 Dragging : 68
 Drive mode : 133

E

Eco mode : 435
 Erasing (images) : 277
 Err (error codes) : 493
 Error messages : 493
 Evaluative metering : 143
 exFAT : 210, 434
 Expanded ISO speed : 138, 236, 499

Exposure compensation : 137
 Exposure compensation in M mode
 with ISO Auto : 111
 Exposure level indicator : 502
 Exposure simulation : 146

F

Face+Tracking : 170, 173
 FAT32 : 210, 434
 Feature guide : 62
 FE lock : 247
 File extension : 122, 207
 File size : 210, 495, 498
 Filter effect (Monochrome) : 159
 Fine (Image quality) : 122
 Firmware : 456
 First-curtain synchronization : 252
 Fish-eye effect : 98, 292
 Flash : 244
 Effective range : 244
 FE lock : 247
 Flash control (function settings) : 248
 Flash exposure compensation : 252
 Flash photography : 244
 Manual flash : 251
 Red-eye reduction : 249
 Shutter synchronization
 (1st/2nd curtain) : 252
 Slow synchro : 250
 Flash exposure compensation : 246, 252
 Flash mode : 251
 Focusing → AF
 Focus lock : 76
 Focus mode switch : 55
 Folder creation/selection : 426
 Food : 88
 Formatting : 433
 Formatting (card initialization) : 433
 Frame Grab : 266

Frame rate : 207, 443

Full High-Definition (Full HD)
(movie) : 205

G

GPS : 396

Grainy B/W : 98, 292

Grid display : 449

H

Handheld night scene : 90

[HD] 1280×720 (Movie) : 205

HDMI : 238, 270, 447

HDMI HDR : 448

HDMI output : 238

HDR art bold : 99

HDR art embossed : 99

HDR art standard : 99

HDR art vivid : 99

HDR Backlight Control : 91

High Frame Rate : 209

High ISO speed noise reduction : 163

Highlight tone priority : 142

Histogram : 312, 450

Household power : 476

I

ICC profile : 153

Icons : 9

Image browsing (jump display) : 310

Image quality : 122, 495

Image review time : 127

Images

AF point display : 314

Auto reset : 430

Auto rotation : 431

Continuous (file numbering) : 429

Erasing : 277

File numbering : 428

Histogram : 312

Image review time : 127

Importing (to computer) : 474

Index display : 260

Jump display (image browsing) : 310

Magnifying images : 259

Manual reset : 430

Manual rotation : 275

Playback : 253

Protecting images : 272

Rating : 303

Search conditions : 308

Shooting information : 257, 507

Slide show : 306

TV display : 270

Image search : 308

Image stabilization : 188

Importing images to a computer : 474

Index display : 260

INFO button : 59

IPB : 207

ISO speed : 138, 236

ISO Auto range : 494

ISO expansion : 459

Max for Auto : 140, 236

J

JPEG : 495

Jump display : 310

L

Landscape : 85

Language : 441

Large (image quality) : 122

Lens : 52, 54

Chromatic aberration correction : 131

Diffraction correction : 131

Digital Lens Optimizer : 130

Distortion correction : 129

Focus mode switch : 55
 Lock release : 53, 55
 Optical aberration correction : 128
 Peripheral illumination correction : 129
 Lens electronic MF : 183
 Location information : 396
 Long (bulb) exposures : 112
 Long Exposure Noise Reduction : 162

M

M (Manual exposure) : 110
 Magnifying images : 177, 185, 259
 Malfunction : 477
 Manual exposure : 110
 Manual focus : 185
 Manual reset : 430
 Maximum burst : 124, 495
 Medium (image quality) : 122
 Memory cards → Cards
 Menu : 63
 Dimmed menu items : 67
 Display level : 60
 Function settings : 424
 Movie recording : 196
 My Menu : 465
 Playback : 254
 Setting procedure : 64
 Still photo shooting : 117
 Wireless communication
 functions : 318
 Menu display : 61
 Metering mode : 143
 Metering timer : 145
 MF (Manual focusing) : 185
 MF peaking : 187
 Miniature effect : 99, 101, 229, 293
 Monochrome : 155, 159
 Movies : 195
 AE lock : 199

Attenuator : 214
 Autoexposure recording : 198
 Auto slow shutter : 239
 Cards that can record movies : 497
 Compression method : 207
 Editing : 264, 268
 Editing out first and last scenes : 264
 File size : 210, 498
 Frame Grab : 266
 Frame rate : 207
 Grid display : 449
 HDMI output : 238, 447
 Information display : 503
 Manual exposure recording : 200
 Movie digital IS : 233
 Movie recording size : 205
 Movie Servo AF : 231
 Playback : 261
 Recording time : 211, 498
 Sound recording/
 Sound-recording level : 213
 Time-lapse movie : 215
 Video snapshot : 224
 Wind filter : 213
 MP4 : 207
 Multi Shot Noise Reduction : 163
 My Menu : 465

N

Night Portrait : 89
 Noise reduction
 High ISO speed : 163
 Long (bulb) exposures : 162
 Normal (Image quality) : 122
 NTSC : 207, 443
 Number of pixels : 122, 495

O

One-Shot AF : 168

P

P (Program AE) : 104

PAL : 207, 443

Partial metering : 143

Part names : 36

Peripheral illumination correction : 129

Photobook set-up : 288

Picture Style : 154, 157, 160

Playback : 253

Portrait : 83

Possible recording time (movie) : 498

Possible shots : 494

Power : 50

Auto power off : 436

Battery level : 51

Charging : 42

Household power : 476

Possible shots : 494

Power saving : 436

Pressing completely : 57, 442

Pressing halfway : 57, 442

Printing

Photobook set-up : 288

Print order : 284

Program AE : 104

Program shift : 105

Protecting images : 272

Q

[Q] (Quick Control) : 69

Quick Control : 69

R

Rating : 303

RAW : 123

RAW+JPEG : 122, 495

Red-eye reduction : 249

Reduced display : 260

Remote controller : 191

Resizing : 302

Rotating (images) : 275, 431

Rotating (movies) : 276

S

Safety instructions : 30

Safety shift : 459

Saturation : 158

Scene icons : 77, 505

Scene Intelligent Auto : 72

Screen : 34, 49

Angle adjustment : 49

Brightness : 437

SD/SDHC/SDXC cards → Cards

Second-curtain synchronization : 252

Self Portrait : 82

Self-timer : 135, 212

Sensitivity → ISO speed

Sepia (Monochrome) : 159

Servo AF

Movie Servo AF : 231

SERVO : 168

SERVO (Servo AF) : 168

Sharpness : 158

Shooting information display : 449, 501

Shooting mode

<A+> (Scene Intelligent Auto) : 72

Av (Aperture-priority AE) : 108

Creative filters : 96

M (Manual exposure) : 110

P (Program AE) : 104

Special scene mode : 80

Switch : 38

Tv (Shutter-priority AE) : 106

Shutter button : 57

Shutter button functions : 442

Shutter-priority AE : 106

Shutter synchronization : 252

Silent : 92

Single-image display : 256
 Single shooting : 133
 Slide show : 306
 Small (image quality) : 122
 Smooth skin : 84
 Soft focus : 98, 292
 Software : 472
 Instruction Manual : 473
 Sound recording/
 Sound-recording level : 213
 Special scene mode : 80
 Sports : 86
 Spot AF : 170, 175
 Spot metering : 143
 sRGB : 153
 Still image aspect ratio : 125, 496
 Strap : 40

T

Temperature warning : 192, 240
 Tilt correction : 301
 Time-lapse movie : 215
 Time zone : 438
 Tone priority : 142
 Toning effect (Monochrome) : 159
 Touch beeping : 446
 Touch operation : 68, 258, 444
 Touch Shutter : 165
 Toy camera effect : 98, 293
 Troubleshooting : 477
 TV display : 270
 Tv (Shutter-priority AE) : 106

U

UHS-I : 11
 USB (digital) terminal : 474
 UTC (Coordinated Universal Time) : 398

V

Video snapshot : 224
 Video system : 443
 Volume (movie playback) : 262, 263

W

Water painting effect : 98, 293
 WB (White balance) : 147
 White balance (WB) : 147
 Ambience priority : 149
 Auto : 149
 Color temperature setting : 151
 Correction : 152
 Custom : 150
 White priority (AWB) : 149
 Wi-Fi function : 317
 Airplane mode : 401
 Android : 322
 Camera access point mode : 385
 Camera Connect : 322, 327
 CANON iMAGE GATEWAY : 367
 Clearing wireless communication
 settings : 402
 Connection history : 390, 393
 Edit device information : 345, 399
 EOS Utility : 349
 Erase connection information : 400
 Image Transfer Utility 2 : 354
 iOS : 322
 IP address : 385
 MAC address : 403
 Network : 332, 350, 358
 Network settings : 419
 Nickname : 400
 Notes : 416
 Pairing : 324
 Password : 393
 PictBridge : 357
 Printer : 357

Printing : 359
Print settings : 362
Reconnecting : 390
Remote operation : 327
Resize image : 335, 340, 375
Sending all images on the card : 341, 378
Sending images that match search conditions : 342, 379
Send selected : 337, 374
SSID : 332, 350, 358
Switch network : 383
Viewable images : 345
View info screen : 403
Viewing images : 327
Virtual keyboard : 404
Wi-Fi settings : 393
WPS (Wi-Fi Protected Setup) : 382
Wind filter : 213
Wireless communication : 317

Z

Zone AF : 171, 175





CANON INC.

30-2 Shimomaruko 3-chome, Ohta-ku, Tokyo 146-8501, Japan

Europe, Africa & Middle East

CANON EUROPA N.V.

Bovenkerkerweg 59, 1185 XB Amstelveen, The Netherlands

For your local Canon office, please refer to your warranty card or to www.canon-europe.com/Support

The product and associated warranty are provided in European countries by Canon Europa N.V.

The descriptions in this Instruction Manual are current as of October 2019. For information on the compatibility with any products introduced after this date, contact any Canon Service Center. For the latest version Instruction Manual, refer to the Canon website.