

Introduction

Contents

Index



Getting Ready



Camera Basics



Shooting



Playback



Wireless Features



Other Settings



Preliminary Notes and Legal Information



- Take and review some test shots initially to make sure the images were recorded correctly. Please note that Canon Inc., its subsidiaries and affiliates, and its distributors are not liable for any consequential damages arising from any malfunction of a camera or accessory, including memory cards, that result in the failure of an image to be recorded or to be recorded in a way that is machine readable.
- The user's unauthorized photographing or recording (video and/or sound) of people or copyrighted materials may invade the privacy of such people and/or may violate others' legal rights, including copyright and other intellectual property rights. Note that restrictions may apply even when such photographing or recording is intended solely for personal use.
- For information on camera warranty or Customer Support, please refer to the warranty information provided with your camera User Manual Kit.
- Although the screen is produced under extremely high-precision manufacturing conditions and more than 99.99% of the pixels meet design specifications, in rare cases some pixels may be defective or may appear as red or black dots. This does not indicate camera damage or affect recorded images.
- When the camera is used over an extended period, it may become warm. This does not indicate damage.



Introduction

Top Page

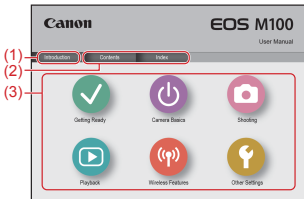

- (1) Jump to this page
This section introduces manual navigation and conventions.
- (2) Jump to the table of contents and index pages
- (3) Jump to the first page of a section, by clicking one of the six sections



Introduction Portal Pages



Portal pages are gateways to each section.

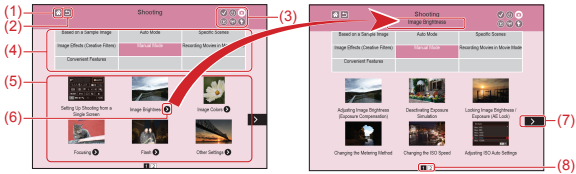

- (1) Jump to the first page
- (2) Return to the previous page
- (3) Section icons
Click an icon to jump to the section's portal page.
- (4) Section themes
Topics in the selected theme are shown in (5). Note that some portal pages do not include themes.





Introduction Portal Pages



- (5) Topics in the selected theme. Click a topic title to jump to the topic page.
- (6) Indicates multiple topics
- (7) Indicates that the information continues on the next page
- (8) Identifies the current page among multiple portal pages





Introduction

Topic Pages



(1) Jump to the first page

(2) Return to the previous page

(3) Section icons

Adjusting Image Brightness (Exposure Compensation)

Standard exposure is adjustable in 1/3-stop increments, in a range of -3 to +3.

1 Access the exposure compensation bar

2 Set up the camera

Turn the dial as you reach the screen → ▲ button

- (1) Jump to the first page
- (2) Return to the previous page
- (3) Section icons
- Click an icon to jump to the section's portal page.
- (4) Indicates that the information is continued from the previous page
- (5) Indicates that the information continues on the next page

(1) Jump to the first page

(2) Return to the previous page

(3) Section icons

Registering Web Services
CANON IMAGE GATEWAY

4 Choose how to connect to the access point

(a) WPS connection
→ [Connect with WPS] button → step 5 (A)

(b) Choosing from the list
→ Choose an access point → [] button → step 5 (B)

5 (A) Establish the connection

(a) WPS (PBC mode)
→ [] button

On the access point, hold down the WPS connection button for a few seconds.

(4) ←

(5) →



Introduction Manual Conventions



- Instructions in this manual may include icons representing camera buttons and dials.
- The following camera controls are represented by icons.



- Shooting modes and on-screen icons and text are indicated in brackets.
- Instructions in this manual apply to the camera under default settings.
- For convenience, all lenses and mount adapters are simply referred to as “lenses” and “mount adapters”, whether they are included or sold separately.
- Illustrations in this manual show the camera with the EF-M15-45mm f/3.5-6.3 IS STM lens attached as an example.
- For convenience, all supported memory cards are simply referred to as the “memory card”.
- Instructions in this manual apply to the camera as set to P mode if “set the shooting mode” step is omitted.



Contents



Preliminary Notes and Legal Information

Introduction

Contents

Safety Instructions

Getting Ready

Attaching the Strap

Charging the Battery Pack

Preparing a Memory Card

Inserting/Removing the Battery Pack

Inserting/Removing a Memory Card

Setting the Date and Time

Setting the Display Language

Attaching a Lens

Detaching a Lens

Attaching EF and EF-S Lenses

Detaching EF and EF-S Lenses

Using a Tripod with EF or EF-S Lenses

Using EF or EF-S Lens Image Stabilization

Holding the Camera



Camera Basics

- Trying the Camera Out
- Part Names
- On/Off
- Shutter Button
- Shooting Modes
- Adjusting the Screen Angle
- Frames on the Shooting Screen
- Shooting Display Options
- Playback Display Options
- Using the Quick Control Screen
- Using the Menu Screen
- Entering Characters
- Indicator Display
- Touch Operations

Shooting

- Based on a Sample Image
- Auto Mode
- Specific Scenes



Image Effects (Creative Filters)

Manual Mode

Recording Movies in Movie Mode

Convenient Features

Playback

Viewing

Finding

Managing

Erasing Images

Editing Stills

Processing RAW Images with the Camera

Editing Movies

Wireless Features

Available Wireless Features

Sending Images to an NFC-Compatible Smartphone

Sending Images to an NFC-Compatible Smartphone (Playback Mode)

Sending Images to a Bluetooth Enabled Smartphone

Registering Web Services

Uploading Images to Web Services



Other Settings

- Preventing the AF-Assist Beam from Firing
- Deactivating the Red-Eye Reduction Lamp
- Changing the Image Display Period after Shots
- Date-Based Image Storage
- File Numbering
- Formatting Memory Cards
- Low-Level Formatting
- Changing the Video System
- Using Eco Mode
- Power-Saving Adjustment
- Screen Brightness
- Customizing Shooting Information Display
- Customizing Playback Information Display
- World Clock
- Date and Time
- Display Language
- Muting Camera Sounds
- Activating Camera Sounds



- Hiding Hints and Tips
- Listing Shooting Modes by Icon
- Adjusting the Touch-Screen Panel
- Automatically Locking the Touch-Screen Panel
- Disabling Auto Sensor Cleaning
- Activating Sensor Cleaning
- Cleaning the Sensor Manually
- Checking Certification Logos
- Setting Copyright Information to Record in Images
- Deleting All Copyright Information
- Restoring Main Camera Default Settings
- Restoring Defaults for Individual Camera Functions

Index

- Precautions for Wireless Features (Wi-Fi, Bluetooth, or Others)
- Radio Wave Interference Precautions
- Trademarks and Licensing
- Disclaimer



Safety Instructions



Be sure to read these instructions in order to operate the product safely.
Follow these instructions to prevent injury or harm to the operator of the product or others.



WARNING

Denotes the risk of serious injury or death.

- Keep the product out of the reach of young children.

A strap wrapped around a person's neck may result in strangulation.

- Use only power sources specified in this instruction manual for use with the product.
- Do not disassemble or modify the product.
- Do not expose the product to strong shocks or vibration.
- Do not touch any exposed internal parts.
- Stop using the product in any case of unusual circumstances such as the presence of smoke or a strange smell.
- Do not use organic solvents such as alcohol, benzine or paint thinner to clean the product.
- Do not get the product wet.
- Do not insert foreign objects or liquids into the product.





Safety Instructions



- Do not use the product where flammable gases may be present.

This may cause electric shock, explosion or fire.

- For products featuring a viewfinder, do not look through the viewfinder at strong light sources such as the sun on a bright day or lasers and other strong artificial light sources.

This may harm your vision.

- Observe the following instructions when using commercially available batteries or provided battery packs.
 - Use batteries/battery packs only with their specified product.
 - Do not heat batteries/battery packs or expose them to fire.
 - Do not charge batteries/battery packs using non-authorized battery chargers.
 - Do not expose the terminals to dirt or let them come into contact with metallic pins or other metal objects.
 - Do not use leaking batteries/battery packs.
 - When disposing of batteries/battery packs, insulate the terminals with tape or other means.

This may cause electric shock, explosion or fire.

If a battery/battery pack leaks and the material contacts your skin or clothing, flush the exposed area thoroughly with running water. In case of eye contact, flush thoroughly with copious amounts of clean running water and seek immediate medical assistance.



Safety Instructions



- Observe the following instructions when using a battery charger or AC adapter.
 - Periodically remove any dust buildup from the power plug and power outlet using a dry cloth.
 - Do not plug in or unplug the product with wet hands.
 - Do not use the product if the power plug is not fully inserted into the power outlet.
 - Do not expose the power plug and terminals to dirt or let them come into contact with metallic pins or other metal objects.
- Do not touch the battery charger or AC adapter connected to a power outlet during lightning storms.
- Do not place heavy objects on the power cord. Do not damage, break or modify the power cord.
- Do not wrap the product in cloth or other materials when in use or shortly after use when the product is still warm in temperature.
- Do not leave the product connected to a power source for long periods of time.

This may cause electric shock, explosion or fire.

- Do not allow the product to maintain contact with the same area of skin for extended periods of time during use.

This may result in low-temperature contact burns, including skin redness and blistering, even if the product does not feel hot. The use of a tripod or similar equipment is recommended when using the product in hot places and for people with circulation problems or less sensitive skin.



Safety Instructions



- Follow any indications to turn off the product in places where its use is forbidden. Not doing so may cause other equipment to malfunction due to the effect of electromagnetic waves and even result in accidents.



CAUTION

Denotes the risk of injury.

- Do not fire the flash near the eyes.

It may hurt the eyes.

- Strap is intended for use on the body only. Hanging the strap with any product attached on a hook or other object may damage the product. Also, do not shake the product or expose the product to strong impacts.
- Do not apply strong pressure on the lens or allow an object to hit it.

This may cause injury or damage to the product.

- Flash emits high temperatures when fired. Keep fingers, any other part of your body, and objects away from the flash unit while taking pictures.

This may cause burns or malfunction of the flash.

- Do not leave the product in places exposed to extremely high or low temperatures. The product may become extremely hot/cold and cause burns or injury when touched.



CAUTION

Denotes the possibility of property damage.

- Do not aim the camera at intense light sources, such as the sun on a clear day or an intense artificial light source.

Doing so may damage the image sensor or other internal components.

- When using the camera on a sandy beach or at a windy location, be careful not to allow dust or sand to enter the camera.
- Wipe off any dust, grime, or other foreign matter on the flash with a cotton swab or cloth.

The heat emitted from the flash may cause foreign matter to smoke or the product to malfunction.

- Remove and store the battery pack/batteries when you are not using the product.

Any battery leakage that occurs may cause product damage.

- Before you discard the battery pack/batteries, cover the terminals with tape or other insulators.

Contacting other metal materials may lead to fire or explosions.

- Unplug any battery charger used with the product when not in use. Do not cover with a cloth or other objects when in use.

Leaving the unit plugged in for a long period of time may cause it to overheat and distort, resulting in fire.



Safety Instructions



- Do not leave any dedicated battery packs near pets.

Pets biting the battery pack could cause leakage, overheating, or explosion, resulting in product damage or fire.

- If your product uses multiple batteries, do not use batteries that have different levels of charge together, and do not use old and new batteries together. Do not insert the batteries with the + and – terminals reversed.

This may cause the product to malfunction.





Getting Ready

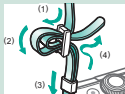

Attaching the Strap



Charging the Battery Pack



Preparing a Memory Card



Inserting/Removing the Battery Pack



Inserting/Removing a Memory Card



Setting the Date and Time

English	Norsk	Română
Deutsch	Svenska	Türkçe
Français	Español	العربية
Nederlands	Ελληνικά	मराठी
Dansk	Русский	繁體中文
Português	Polski	繁體中文
Suomi	Čeština	한국어

Setting the Display Language



Attaching a Lens

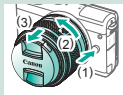

Detaching a Lens





Getting Ready



Attaching EF and EF-S Lenses

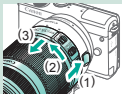

Detaching EF and EF-S Lenses



Using a Tripod with EF or EF-S Lenses



Using EF or EF-S Lens Image Stabilization



Holding the Camera





Attaching the Strap

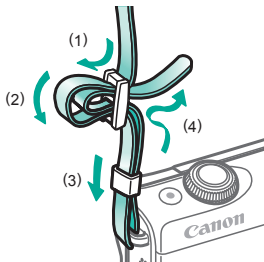



Charging the Battery Pack



1

Remove the battery cover

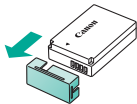

2

Insert the battery pack



3

Charge the battery pack



- Charging: Orange
- Fully charged: Green





4

Remove the
battery pack

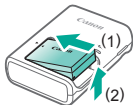



Preparing a Memory Card



Use the following memory cards (sold separately), in any capacity.

- SD memory cards*¹
- SDHC memory cards*^{1*2}
- SDXC memory cards*^{1*2}



- *1 Cards conforming to SD standards. However, not all memory cards have been verified to work with the camera.
- *2 UHS-I memory cards are also supported.



Inserting/Removing the Battery Pack



1

Open the battery cover

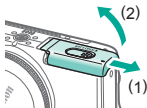

2

When inserting the battery pack:

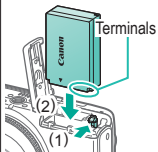

When removing the battery pack:

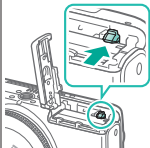

3

Close the battery cover

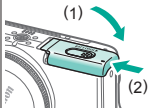



Inserting/Removing a Memory Card



1

Open the memory card cover



2

When inserting the memory card:

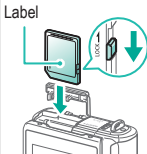

When removing the memory card:



3

Close the memory card cover





Setting the Date and Time



1

Turn the camera on



2

Set the date and time



- ◀▶ buttons to navigate → ▲▼ buttons to adjust →  button

3

Set your home time zone

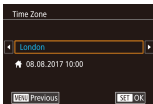

- ◀▶ buttons to adjust →  button



Setting the Display Language



1

Enter Playback mode



2

Access the menu screen

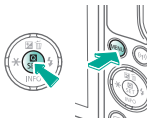

- Hold down the  button and press the **MENU** button.

3

Set the display language



English	Norsk	Română
Deutsch	Svenska	Türkçe
Français	Español	العربية
Nederlands	Ελληνικά	Ελληνικά
Dansk	Русский	简体中文
Português	Polski	繁體中文
Suomi	Čeština	한국어

-     buttons to adjust →  button



Attaching a Lens



1

Make sure the camera is off



2

Remove the lens cap and body cap



3

Attach the lens

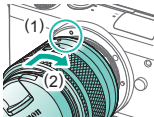

4

Remove the front lens cap

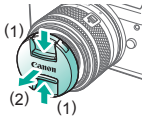

5

Prepare to shoot

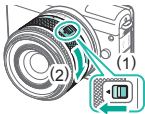

- Press (1) as you turn (2) slightly, and then release the switch.
- Turn (2) a little more until it clicks.
- Zoom in or out before focusing.

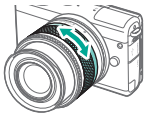



Detaching a Lens



1

Make sure the camera is off



2

Detach the lens

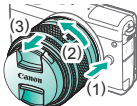

- Press (1) as you turn the lens toward (2) until it stops.
- Remove it in the direction shown (3).

3

Attach the lens cap and body cap





Attaching EF and EF-S Lenses



1

Make sure the camera is off



2

Remove the lens cap and body cap

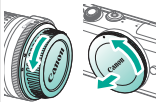

3

Attach the adapter to the camera



4

Attach the lens

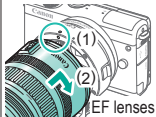

EF lenses

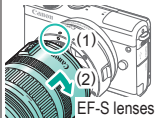

EF-S lenses



Detaching EF and EF-S Lenses



1

Make sure the camera is off



2

Detach the lens

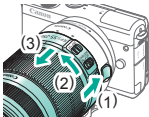

- Slide (1) as you turn the lens toward (2) until it stops.
- Remove it in the direction shown (3).

3

Detach the adapter

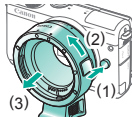

- Press (1) as you turn the adapter toward (2) until it stops.
- Remove it in the direction shown (3).

4

Attach the lens cap and body cap

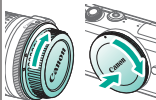



Using a Tripod with EF or EF-S Lenses



1

Attach the tripod mount to the adapter

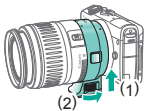

2

Attach the tripod to the tripod mount socket

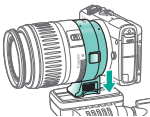



Using EF or EF-S Lens Image Stabilization

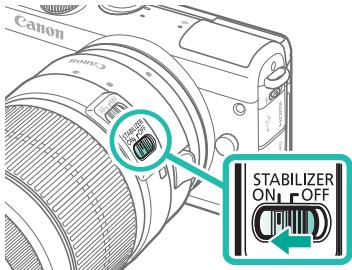



Holding the Camera





Camera Basics



Trying the Camera Out ▶

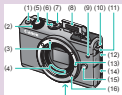

Part Names



On/Off



Shutter Button

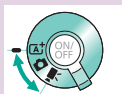

Shooting Modes



Adjusting the Screen Angle



Frames on the Shooting Screen



Shooting Display Options



Playback Display Options





Camera Basics



Using the Quick Control
Screen

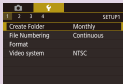

Using the Menu Screen

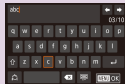

Entering Characters



Indicator Display



Touch Operations >





Camera Basics

Trying the Camera Out



Shooting Stills (Scene Intelligent Auto)



Recording Movies (Scene Intelligent Auto)



Viewing Stills



Viewing Movies



Erasing Images



Trying the Camera Out

Shooting Stills (Scene Intelligent Auto)



1

Turn the camera on



2

Set the mode



3

Zoom in or out, as needed



- (1) Scene icon
- (2) Remaining number of shots
- (3) Remaining recording time





Trying the Camera Out

Shooting Stills (Scene Intelligent Auto)



4

Focus

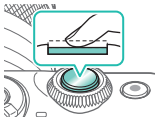

- Press the shutter button lightly.
- The camera beeps twice after focusing.



- An AF frame is displayed around positions in focus.

5

Raise the flash as needed



- If [Raise the flash] is displayed, move the  switch.

6

Shoot





Trying the Camera Out

Recording Movies (Scene Intelligent Auto)



1

Turn the camera on



2

Set the mode



3

Zoom in or out, as needed



- (1) Scene icon
- (2) Remaining number of shots
- (3) Remaining recording time





Trying the Camera Out Recording Movies (Scene Intelligent Auto)



4

Start recording

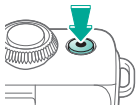

5

Stop recording

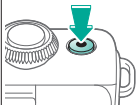

- Frames are displayed around any detected faces that are in focus.





Trying the Camera Out Viewing Stills



1

Enter Playback
mode



2

Browse your
images



- ◀ button: Previous image
- ▶ button: Next image



Trying the Camera Out Viewing Movies



1

Enter Playback
mode



2

Browse your
images



- ◀ button: Previous image
- ▶ button: Next image



- Movies are labeled with **[SET ▶]**.

3

Play the movie





Trying the Camera Out Viewing Movies



4

Adjust the volume



● ▲/▼ buttons →

[▶] → (SET) button





Trying the Camera Out Erasing Images



1

Enter Playback mode



2

Browse your images



- ◀ button: Previous image
- ▶ button: Next image

3

Erase

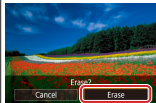



- ◀▶ buttons → [Erase] →

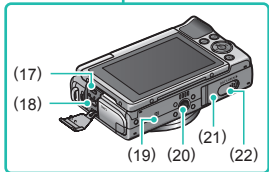
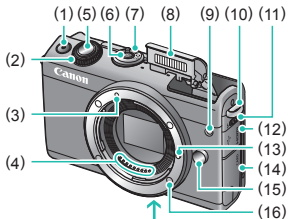

Part Names

Front



No.	Name	Symbol in This Manual
(1)	Movie button	
(2)	Front dial	
(3)	EF-M lens mount index	
(4)	Contacts	
(5)	Shutter button	
(6)	ON/OFF button	
(7)	Mode switch	
(8)	Flash	
(9)	Lamp	





Part Names Front

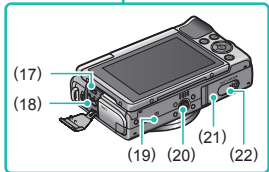
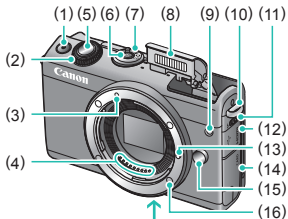

No.	Name	Symbol in This Manual
(10)	Strap mount	
(11)	Flash pop up switch	
(12)	Terminal cover	
(13)	Lens lock pin	
(14)	Memory card cover	
(15)	Lens release button	
(16)	Lens mount	
(17)	HDMI™ terminal	
(18)	Digital terminal	



Part Names Front

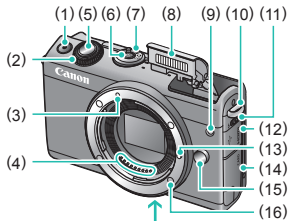

No.	Name	Symbol in This Manual
(19)	N-Mark	
(20)	Tripod socket	
(21)	Battery cover	
(22)	DC coupler terminal cover	

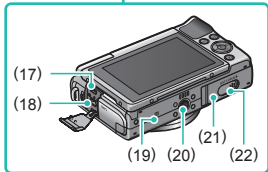



Part Names Back

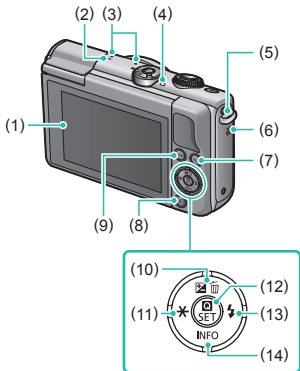

No.	Name	Symbol in This Manual
(1)	Screen / Touch-screen panel	
(2)	Focal plane mark	
(3)	Microphone	
(4)	Indicator	
(5)	Strap mount	
(6)	Speaker	
(7)	Wi-Fi button	
(8)	Playback button	





Part Names Back

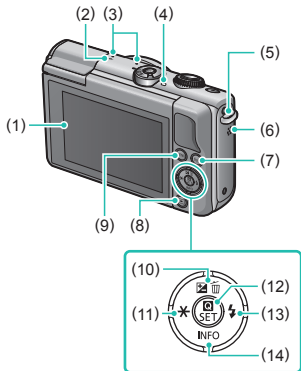

No.	Name	Symbol in This Manual
(9)	Menu button	MENU
(10)	Exposure compensation / Single-image erase / Up button	
(11)	AE lock / Left button	
(12)	Quick Control / Set button	
(13)	Flash / Right button	
(14)	Information / Down button	INFO





Part Names Lens

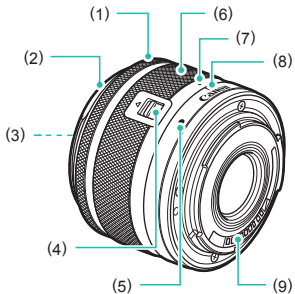

No.	Name	Symbol in This Manual
(1)	Focusing ring	
(2)	Hood mount	
(3)	Filter-mounting thread	
(4)	Lens retraction switch	
(5)	Lens mount index	
(6)	Zoom ring	
(7)	Lens retraction index	
(8)	Zoom position index	
(9)	Contacts	





On/Off



Shooting Mode



Playback Mode



- On: Press the  button.
- Off: Press the ON/OFF button.



Shutter Button



1

Press halfway
(Press lightly to
focus)

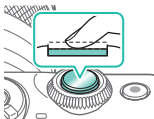

- The camera beeps twice.
- A frame is displayed around positions in focus.

2

Press all the way
down (From the
halfway position,
press fully to shoot)



- The camera shoots.



Shooting Modes





Switch to a shooting mode for how or what you will shoot.

- (1) Fully automatic shooting, with camera-determined settings.
- (2) Add a variety of effects and use your preferred settings.
- (3) For recording movies.

1

Set the mode



- Move the mode switch.
- When choosing  or , go to step 2.

2

Set the shooting mode



- Touch the icon in the upper left.

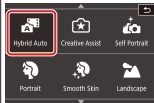



Shooting Modes



Switch to a shooting mode for how or what you will shoot.

- (1) Fully automatic shooting, with camera-determined settings.
- (2) Add a variety of effects and use your preferred settings.
- (3) For recording movies.

3

Set up the camera

- Drag up or down to browse shooting modes, and touch a mode of your choice.

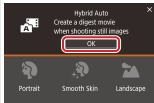

- Touch [OK].



Adjusting the Screen Angle

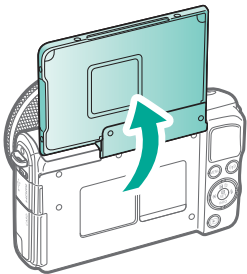

- The screen can be opened to about 180°.



Frames on the Shooting Screen



White frame



- Displayed around the subject or person's face detected as the main subject.

Green frame



- Displayed after the camera focuses when you press the shutter button halfway.

Blue frame



- Displayed as the camera continues to focus on moving subjects in [A+] mode. Displayed as long as you press the shutter button halfway.

Orange frame + [!]



- Displayed if the camera cannot focus when you press the shutter button halfway.



Shooting Display Options



Shooting information



Histogram



No information display



INFO. Quick Control screen

1

Switch the display modes





Playback Display Options



No information display



Information display 1
(summary)



Information display 2
(details)



Information display 3
(details)

1

Switch the display
modes





Using the Quick Control Screen



1

Access the setting screen



- (1) Setting items
- (2) Setting options

2

Choose the setting item



3

Choose the setting option





4

Confirm your choice and exit



- To set items labeled **[MENU]**, press the **MENU** button.





Using the Menu Screen



1

Access the menu screen

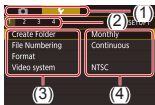
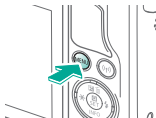

- (1) Function tabs
- (2) Page tabs
- (3) Setting items
- (4) Setting options

2

Choose a tab



3

Choose the setting item





4

Choose the setting option



5

Confirm your choice and exit



Entering characters



- Touch a character → [OK]

Moving the cursor

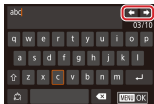

- Touch [←]/[→].

Switching input modes

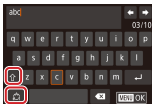

- [⇧]: Switch to numbers or symbols
- [⇧]: Switch to uppercase

Deleting characters



- Touch [✕].





Entering Characters



Entering line breaks



● Touch [↵].



Returning to the previous screen

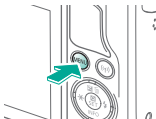



Indicator Display



Indicator display varies depending on the camera status.

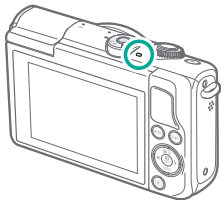

Color	Status	Camera Status
Green	Slow blinking	<ul style="list-style-type: none">● Connected to a computer● Display off
	Blinking	<ul style="list-style-type: none">● Starting up● Recording to/reading from a memory card● Communicating with other devices● Shooting long exposures● Connecting/transmitting via Wi-Fi



Camera Basics

Touch Operations



Quick Control Screen

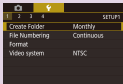

MENU



Playback



Touch Operations

Quick Control Screen



Accessing the setting screen



- Touch **[Q]**.

Setting up the camera



- Touch a setting item (1)
→ option (2).

Returning to the previous screen



- Touch **[↶]**, or touch the selected item again.

Switching screens



- Touch **[MENU]**.





Touch Operations Quick Control Screen



Adjusting amounts on bars



- Touch or drag the bar.





Touch Operations MENU



Setting up the camera

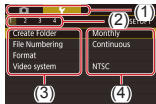

- Touch a function tab (1) → page tab (2) → setting item (3) → option (4).

Returning to the previous screen

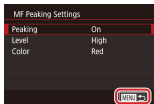

- Touch **[MENU]**.

Adding/removing check marks



- Touch a check box.

Instead of pressing the **INFO** button

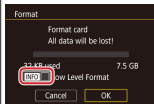

- Touch **[INFO]**.





Touch Operations

MENU



Instead of pressing the **MENU** button

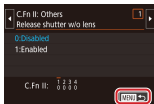

- Touch **[MENU]**.

Instead of pressing the **SET** button

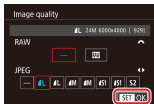

- Touch **[SET]**.





Touch Operations Playback



Viewing images individually



- Next image: Drag left
- Previous image: Drag right

Playing movies

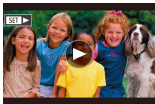

- Play: Touch [▶]
- Adjust volume: During playback, drag up/down quickly

Operations during movies



- Stop: Touch the screen
- Resume: Touch [▶]
- Adjust volume: Touch [🔊]

Switching to index display





Touch Operations Playback



Displaying fewer
images

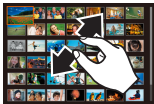

Magnifying images
(about 3x)



- Quickly touch twice.

Magnifying images
(up to 10x)



Reducing
magnified images



- Restore original size:
Touch **[MENU]**





Shooting



Based on a Sample Image	Auto Mode	Specific Scenes
Image Effects (Creative Filters)	Manual Mode	Recording Movies in Movie Mode
Convenient Features		



Self Portraits under Optimal Settings



Portraits



Smooth Skin



Landscapes



Close-ups



Moving Subjects





Shooting



Based on a Sample Image	Auto Mode	Specific Scenes
Image Effects (Creative Filters)	Manual Mode	Recording Movies in Movie Mode
Convenient Features		



Enhancing Colors of Food



Evening Scenes without a Tripod



Backlit Scenes



Monochrome



Soft Focus Effect



Fish-Eye Lens Effect



Shooting



Based on a Sample Image	Auto Mode	Specific Scenes
Image Effects (Creative Filters)	Manual Mode	Recording Movies in Movie Mode
Convenient Features		



Oil Painting Effect



Watercolor Effect



Toy Camera Effect



Miniature Model Effect



High-Contrast Scenes



Shooting



Based on a Sample Image	Auto Mode	Specific Scenes
Image Effects (Creative Filters)	Manual Mode	Recording Movies in Movie Mode
Convenient Features		



Scene Intelligent Auto (Stills)



Scene Intelligent Auto (Movies)



Hybrid Auto Mode



Scene Intelligent Auto (Stills)



1

Turn the camera on



2

Set the mode



3

Zoom in or out, as needed



4

Shoot





Scene Intelligent Auto (Movies)



1

Turn the camera on



2

Set the mode



3

Zoom in or out, as needed



4

Start recording

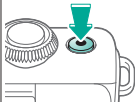



5

Adjust how the shot is composed, as needed



6

Stop recording

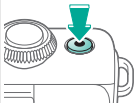



Hybrid Auto Mode



You can make a short movie of the day just by shooting stills. The camera records 2 – 4-second clips of scenes before each shot, which are later combined in a digest movie.

1

Set the mode



2

Set the shooting mode

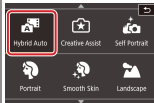

[A] → [OK]

3

Compose the shot and shoot





Shooting



Based on a Sample Image	Auto Mode	Specific Scenes
Image Effects (Creative Filters)	Manual Mode	Recording Movies in Movie Mode
Convenient Features		



Self Portraits under Optimal Settings



Portraits



Smooth Skin



Landscapes



Close-ups



Moving Subjects





Shooting



Based on a Sample Image	Auto Mode	Specific Scenes
Image Effects (Creative Filters)	Manual Mode	Recording Movies in Movie Mode
Convenient Features		



Enhancing Colors of Food



Evening Scenes without a Tripod



Backlit Scenes





Self Portraits under Optimal Settings



 Self Portrait

For self-portraits, customizable image processing includes skin smoothing as well as brightness and background adjustment to make yourself stand out.

1

Open the screen

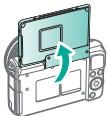

2

Set the shooting mode



- Touch .

3

Set up the camera

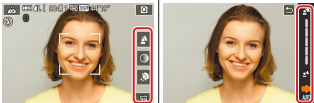

- Adjust the level.





Self Portraits under Optimal Settings



 Self Portrait

For self-portraits, customizable image processing includes skin smoothing as well as brightness and background adjustment to make yourself stand out.

4

Shoot





Portraits



 Portrait

Take shots of people with a softening effect.

1

Set the mode



2

Set the shooting mode

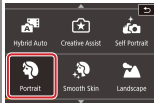

●  → [OK]

3

Shoot





Smooth Skin



 Smooth Skin

Processes images to make skin look smoother.

1

Set the mode



2

Set the shooting mode



● [] → [OK]

3

Shoot





Landscapes



 Landscape

Capture wide-open landscapes or similar scenery in sharp focus from near to far, with blue skies and greenery reproduced vividly.

1

Set the mode



2

Set the shooting mode

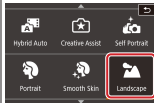

●  → [OK]

3

Shoot





Close-ups



 Close-up

For shooting close-ups of flowers or other small objects.

1

Set the mode



2

Set the shooting mode

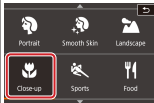

●  → [OK]

3

Shoot





Moving Subjects



 Sports

Shoot continuously as the camera keeps the subject in focus.

1

Set the mode



2

Set the shooting mode

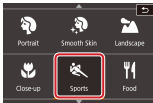

●  → [OK]

3

Shoot





Enhancing Colors of Food



 Food

Adjust color tones to make food look fresh and vibrant.

1

Set the mode



2

Set the shooting mode

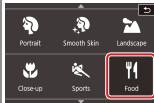

●  → [OK]

3

Adjust the color tone

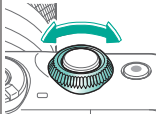



Enhancing Colors of Food



 Food

Adjust color tones to make food look fresh and vibrant.

4

Shoot





Evening Scenes without a Tripod



 Handheld Night Scene

Beautiful shots of evening scenes or portraits with evening scenery in the background, without the need to hold the camera very still (as with a tripod).

1

Set the mode



2

Set the shooting mode

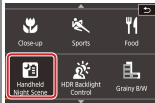

●  → [OK]

3

Shoot





Backlit Scenes



 HDR Backlight Control

Three consecutive images are captured at different brightness levels each time you shoot, and the camera combines image areas with optimal brightness to create a single image. This mode can reduce the loss of detail in shadows that tends to occur in shots with mixed bright and dark image areas.

1

Set the mode



2

Set the shooting mode

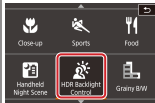

●  → [OK]

3

Shoot





Shooting



Based on a Sample Image	Auto Mode	Specific Scenes
Image Effects (Creative Filters)	Manual Mode	Recording Movies in Movie Mode
Convenient Features		



Monochrome



Soft Focus Effect



Fish-Eye Lens Effect



Oil Painting Effect



Watercolor Effect



Toy Camera Effect





Shooting



Based on a Sample Image	Auto Mode	Specific Scenes
Image Effects (Creative Filters)	Manual Mode	Recording Movies in Movie Mode
Convenient Features		



Miniature Model Effect



High-Contrast Scenes



HDR Effect





Monochrome



 Grainy B/W

Take monochrome pictures with a gritty, rough feeling.

1

Set the mode



2

Set the shooting mode

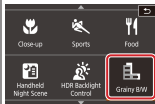

●  → [OK]

3

Adjust the effect level

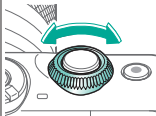



Monochrome



 Grainy B/W

Take monochrome pictures with a gritty, rough feeling.

4

Shoot





Soft Focus Effect



Normal



 Soft focus

This function allows you to shoot images as if a soft focus filter were attached to the camera.

1

Set the mode



2

Set the shooting mode



●  → [OK]

3

Adjust the effect level

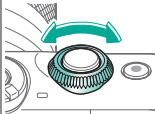



Soft Focus Effect



Normal



 Soft focus

This function allows you to shoot images as if a soft focus filter were attached to the camera.

4

Shoot





Fish-Eye Lens Effect



 Fish-eye effect

Shoot with the distorting effect of a fish-eye lens.

1

Set the mode



2

Set the shooting mode



●  → [OK]

3

Adjust the effect level

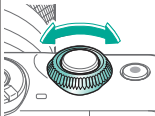



Fish-Eye Lens Effect



 Fish-eye effect

Shoot with the distorting effect of a fish-eye lens.

4

Shoot





Oil Painting Effect



 Art bold effect

Make subjects look more substantial, like subjects in oil paintings.

1

Set the mode



2

Set the shooting mode



●  → [OK]

3

Adjust the effect level

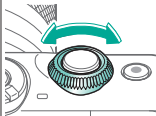



Oil Painting Effect



 Art bold effect

Make subjects look more substantial, like subjects in oil paintings.

4

Shoot





Watercolor Effect



 Water painting effect

Soften colors, for photos resembling watercolor paintings.

1

Set the mode



2

Set the shooting mode

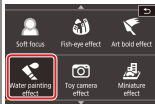

●  → [OK]

3

Adjust the effect level

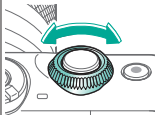



Watercolor Effect



 Water painting effect

Soften colors, for photos resembling watercolor paintings.

4

Shoot





Toy Camera Effect



 Toy camera effect

This effect makes images resemble shots from a toy camera, with vignetting (darker, blurred image corners) and modified color overall.

1

Set the mode



2

Set the shooting mode



 → [OK]

3

Choose an effect

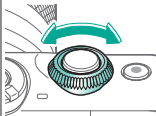



Toy Camera Effect



This effect makes images resemble shots from a toy camera, with vignetting (darker, blurred image corners) and modified color overall.

 Toy camera effect

4

Shoot





Miniature Model Effect



 Miniature effect

Creates the effect of a miniature model, by blurring image areas outside a selected area.

1

Set the mode



2

Set the shooting mode

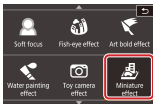

●  → [OK]

3

Choose the area to keep in focus





Miniature Model Effect



 Miniature effect

Creates the effect of a miniature model, by blurring image areas outside a selected area.



● To resize the frame:



● To move the frame:



4

For movies,
choose the speed

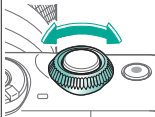

5

Return to the
shooting screen





Miniature Model Effect



Miniature effect

Creates the effect of a miniature model, by blurring image areas outside a selected area.

6

Shoot





High-Contrast Scenes



Normal



HDR

Three consecutive images are captured at different brightness levels each time you shoot, and the camera combines image areas with optimal brightness to create a single image (High Dynamic Range). This mode can reduce the washed-out highlights and loss of detail in shadows that tend to occur in high-contrast shots.

1

Set the mode



2

Set the shooting mode

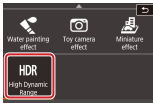

● (HDR) → [OK]

3

Shoot





HDR Effect



Natural



Art Standard



Art Vivid



Art Bold

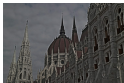

Art Embossed

1

Set the mode



2

Set the shooting mode



● [HDR] → [OK]

3

Choose an effect

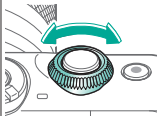



HDR Effect



Natural



Art Standard



Art Vivid



Art Bold

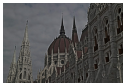

Art Embossed

4

Shoot





Shooting



Based on a Sample Image	Auto Mode	Specific Scenes
Image Effects (Creative Filters)	Manual Mode	Recording Movies in Movie Mode
Convenient Features		



Setting Up Shooting from a Single Screen



Focusing >



Image Brightness >



Image Colors >



Flash >



Other Settings >





Shooting



Based on a Sample Image	Auto Mode	Specific Scenes
Image Effects (Creative Filters)	Manual Mode	Recording Movies in Movie Mode
Convenient Features		



Specific Shutter Speeds and Apertures ➤



Customizing the Camera ➤



Creative Assist ➤



Setting Up Shooting from a Single Screen



The INFO. Quick Control screen provides convenient, single-screen access to a variety of shooting settings.

1

Access the setting screen



- Press the button a few times.

2

Choose a setting to configure



- Press the button.

- buttons to navigate → dial to adjust



Shooting Image Brightness



Based on a Sample Image	Auto Mode	Specific Scenes
Image Effects (Creative Filters)	Manual Mode	Recording Movies in Movie Mode
Convenient Features		



Adjusting Image Brightness
(Exposure Compensation)



Deactivating Exposure
Simulation



Locking Image Brightness /
Exposure (AE Lock)



Changing the Metering Method



Changing the ISO Speed



Adjusting ISO Auto Settings





Shooting Image Brightness



Based on a Sample Image	Auto Mode	Specific Scenes
Image Effects (Creative Filters)	Manual Mode	Recording Movies in Movie Mode
Convenient Features		



Auto Correction of Brightness and Contrast (Auto Lighting Optimizer)



Shooting Bright Subjects (Highlight Tone Priority)





Adjusting Image Brightness (Exposure Compensation)



Set toward -



± 0



Set toward +

Standard exposure is adjustable in 1/3-stop increments, in a range of -3 to +3.

1

Access the exposure compensation bar



2

Set up the camera



- Turn the  dial as you watch the screen \rightarrow  button



Deactivating Exposure Simulation



Images are displayed at a brightness simulating the actual brightness as captured. For this reason, screen brightness is also adjusted in response to changes in exposure compensation. This feature can be disabled to keep the screen at a brightness convenient for shooting, unaffected by exposure compensation.

1

Access the menu screen

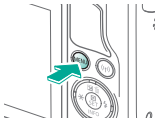

2

Set up the camera



- [Camera icon 1] → [Expo. simulation] → [Disable]



Locking Image Brightness / Exposure (AE Lock)



Without AE lock



AE lock

Before shooting, you can lock the exposure, or you can specify focus and exposure separately.

1

Lock the exposure



- Aim the camera at the subject to shoot with the exposure locked, and then press the button.

2

Compose the shot and shoot





Changing the Metering Method

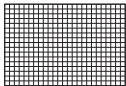

Evaluative metering



Partial metering



Spot metering



Center-weighted average

1

Access the setting screen



2

Set up the camera



- → choose an option →



Changing the ISO Speed



Low



High

Set the ISO speed to [AUTO] for automatic adjustment to suit the shooting mode and conditions. Otherwise, set a higher ISO speed for higher sensitivity, or a lower value for lower sensitivity.

1

Access the ISO speed bar



- Touch [ISO AUTO].

2

Set up the camera



- ◀▶ buttons → button



Adjusting ISO Auto Settings



Maximum set low



Maximum set high

You can limit the ISO speed when ISO speed is set to [AUTO].

1

Access the menu screen

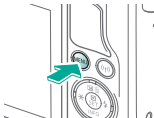

2

Set up the camera



- [CAMERA] → [ISO speed] → [ISO Auto]
- choose an option
- [SET] button



Auto Correction of Brightness and Contrast (Auto Lighting Optimizer)



 Off
Disable



 Low



 Standard



 High

1



Access the setting screen



2

Set up the camera



-  → choose an option → 



Shooting Bright Subjects (Highlight Tone Priority)



Improve gradation in bright image areas to avoid loss of detail in subject highlights.

1

Access the menu screen

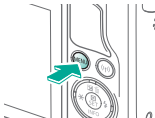

2

Set up the camera

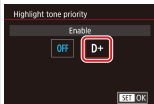

- [CAMERA] → [Highlight tone priority] → [Enable] → [SET] button



Shooting Image Colors



Based on a Sample Image	Auto Mode	Specific Scenes
Image Effects (Creative Filters)	Manual Mode	Recording Movies in Movie Mode
Convenient Features		



Capturing Natural Colors (White Balance)



Custom White Balance



Manually Correcting White Balance



Manually Setting White Balance
Color Temperature



Choosing Color Tones (Picture Style)



Customizing Picture Styles





Shooting Image Colors



Based on a Sample Image	Auto Mode	Specific Scenes
Image Effects (Creative Filters)	Manual Mode	Recording Movies in Movie Mode
Convenient Features		



Saving Customized Picture
Styles





Capturing Natural Colors (White Balance)



Daylight



Cloudy



Tungsten light

By adjusting white balance (WB), you can make image colors look more natural for the scene you are shooting.

1

Access the setting screen



2

Set up the camera



- **[WB]** → choose an option → **[SET]** button



Custom White Balance



Loading white

For image colors that look natural under the light in your shot, adjust white balance to suit the light source where you are shooting. Set the white balance under the same light source that will illuminate your shot.

1

Shoot a white object



- With a plain white object filling the entire screen, focus and shoot.

2

Access the menu screen



3

Access the custom WB screen

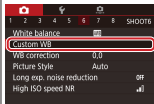

- [CAMERA] → [Custom WB] → [SET] button





Custom White Balance



Loading white

For image colors that look natural under the light in your shot, adjust white balance to suit the light source where you are shooting. Set the white balance under the same light source that will illuminate your shot.

4

Load the white data



- Select your image from step 1 → button → [OK] → button

5

Return to the shooting screen

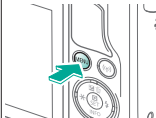

6

Access the setting screen





Custom White Balance



Loading white

For image colors that look natural under the light in your shot, adjust white balance to suit the light source where you are shooting. Set the white balance under the same light source that will illuminate your shot.

7

Set up the camera

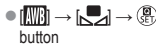



Manually Correcting White Balance



Daylight shot



Corrected

You can manually correct white balance. This adjustment can match the effect of using a commercially available color temperature conversion filter or color-compensating filter.

1

Access the setting screen



2

Set up the camera



- [AWB] → choose an option →  dial to adjust

3

Set in greater detail, as needed

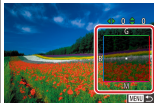



Manually Correcting White Balance



Daylight shot



Corrected

You can manually correct white balance. This adjustment can match the effect of using a commercially available color temperature conversion filter or color-compensating filter.



- **MENU** button →
▲/▼/◀▶ buttons
to adjust → **MENU**
button



Manually Setting White Balance Color Temperature



A value can be set representing the white balance color temperature.

1

Access the setting screen



2

Choose the setting item



● [AVB] → [K] →
[5200K]

3

Set up the camera



● Choose an option →
[SET] button



Choosing Color Tones (Picture Style)



Standard



Landscape

Choose a Picture Style with color settings that express moods or subjects well. Eight Picture Styles are available, and each can be further customized.

1

Access the setting screen



2

Set up the camera

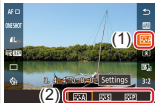

- → choose an option → button



Customizing Picture Styles



Customize parameters of Picture Styles such as contrast or saturation.

1

Access the setting screen



2

Choose a style

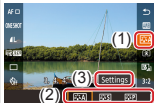

-  → choose an option → [Settings]

3

Set up the camera



- Choose an item → adjust →  button



Saving Customized Picture Styles



Save presets (such as [P] or [L]) that you have customized as new styles. You can create several Picture Styles with different settings for parameters such as sharpness or contrast.

1

Access the setting screen



2

Select a user-defined style number

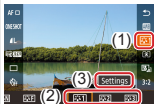



3

Select a style to modify





Save presets (such as  or ) that you have customized as new styles. You can create several Picture Styles with different settings for parameters such as sharpness or contrast.

4

Customize the style



- ▲/▼ buttons to choose an option to modify → ◀▶ buttons to customize →  button



Shooting Focusing



Based on a Sample Image	Auto Mode	Specific Scenes
Image Effects (Creative Filters)	Manual Mode	Recording Movies in Movie Mode
Convenient Features		



Shooting in Manual Focus
Mode



Fine-Tuning the Focus



Easily Identifying the Focus
Area (MF Peaking)



Choosing the AF Method



Shooting with Servo AF



Changing the Focus Setting





Shooting Focusing



Based on a Sample Image	Auto Mode	Specific Scenes
Image Effects (Creative Filters)	Manual Mode	Recording Movies in Movie Mode
Convenient Features		



Choosing Subjects to Focus On
(Touch AF)





Shooting in Manual Focus Mode



When focusing is not possible in AF mode, use manual focus. To make focusing easier, magnify the display.

1

Choose **[MF]**
(EF-M lenses)

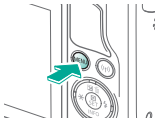

- [CAMERA] → [Focus mode] → [MF] → **MENU** button

(Other lenses)

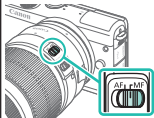

- Set the lens switch to MF.





Shooting in Manual Focus Mode



When focusing is not possible in AF mode, use manual focus. To make focusing easier, magnify the display.

2

Activate magnification



- Touch [Q].

3

Choose an area to focus on



- Drag across the screen to display an area to focus on.
- To center the display again, press the ▼ button.

4

Focus





Shooting in Manual Focus Mode



When focusing is not possible in AF mode, use manual focus. To make focusing easier, magnify the display.

5

Shoot





Fine-Tuning the Focus



Autofocus



Focusing ring

Fine-tune autofocusing with an EF-M lens attached by turning the focusing ring.

1

Access the menu screen

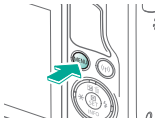

2

Set up the camera

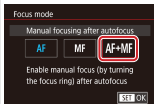

- [CAMERA] → [Focus mode] → [AF+MF] → [SET] button

3

Focus

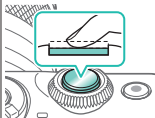

- Hold the shutter button halfway down.





Fine-Tuning the Focus



Autofocus



Focusing ring

Fine-tune autofocusing with an EF-M lens attached by turning the focusing ring.

4

Fine-tune the focus



- Magnification is activated.

5

Shoot





Easily Identifying the Focus Area (MF Peaking)



MF peaking off



MF peaking on

Edges of subjects in focus are displayed in color to make manual focusing easier. You can adjust the colors and the sensitivity (level) of edge detection as needed.

1

Access the menu screen

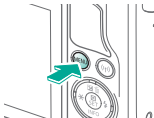

2

Set up the camera

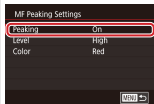

● [CAMERA] → [MF Peaking Settings] → [Peaking] → [On]

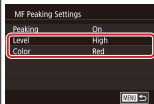



Easily Identifying the Focus Area (MF Peaking)



MF peaking off



MF peaking on

Edges of subjects in focus are displayed in color to make manual focusing easier. You can adjust the colors and the sensitivity (level) of edge detection as needed.



- ▲/▼ buttons to navigate → ▲/▼ buttons to adjust



Choosing the AF Method



1-point AF



+Tracking



Smooth zone AF

Change the auto focus (AF) mode to suit shooting conditions.

1

Access the setting screen



2

Set up the camera



- [AF □] → choose an option → SET button



Shooting with Servo AF



This mode helps avoid missing shots of subjects in motion, because the camera continues to focus on the subject and adjust the exposure as long as you press the shutter button halfway.

1

Access the setting screen



2

Set up the camera



● [ONE SHOT] →
[SERVO] → SET
button

3

Focus

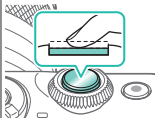



Shooting with Servo AF



This mode helps avoid missing shots of subjects in motion, because the camera continues to focus on the subject and adjust the exposure as long as you press the shutter button halfway.

4

Shoot





Changing the Focus Setting



Enable: Focus on moving subjects



Disable: Focus on stationary subjects

You can change default camera operation of constantly focusing on subjects it is aimed at, even when the shutter button is not pressed. Instead, you can limit camera focusing to the moment you press the shutter button halfway.

1

Access the menu screen

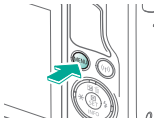

2

Set up the camera



- [Camera Icon] 3 → [Continuous AF] → [Disable]



Choosing Subjects to Focus On (Touch AF)



AF □



AF ☺

You can shoot after the camera focuses on your selected subject, person's face, or position on the screen.

1

Touch a subject to focus on



2

Shoot





Shooting Flash



Based on a Sample Image	Auto Mode	Specific Scenes
Image Effects (Creative Filters)	Manual Mode	Recording Movies in Movie Mode
Convenient Features		



Changing the Flash Mode



Adjusting the Flash Exposure Compensation



Shooting with the FE Lock



Changing the Flash Timing

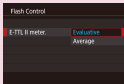

Changing the Flash Metering Mode



Adjusting the Flash Output





Shooting Flash



Based on a Sample Image	Auto Mode	Specific Scenes
Image Effects (Creative Filters)	Manual Mode	Recording Movies in Movie Mode
Convenient Features		

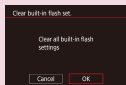

Resetting Flash Settings





Changing the Flash Mode



You can change the flash mode to match the shooting scene. To illuminate the main subject (such as people) and reduce shadows in the background, use Slow Synchro.

1

Raise the flash



2

Set up the camera



- ▶ button → choose a flash mode →  button



Adjusting the Flash Exposure Compensation



Set toward -



Set toward +

Just as with regular exposure compensation, you can adjust the flash exposure from -2 to +2 stops, in 1/3-stop increments.

1



Raise the flash

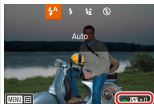

2

Set up the camera



▶ button → 
dial to adjust → 
button



Shooting with the FE Lock



FE lock



Without FE lock
(overexposed)

Just as with the AE lock, you can lock the exposure for flash shots.

1

Raise the flash



2

Set to [⚡]

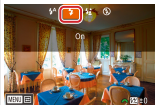

▶ button → [⚡]

3

Lock the flash exposure



- Aim at subject for fixed exposure → ◀ button





Shooting with the FE Lock



FE lock



Without FE lock
(overexposed)

Just as with the AE lock, you can lock the exposure for flash shots.

4

Compose the shot
and shoot





Changing the Flash Timing



1st-curtain flash



2nd-curtain flash

Change the timing of the flash and shutter release.

1

Access the menu screen

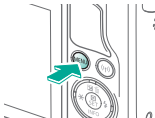

2

Set up the camera

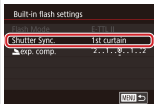

- [CAMERA] → [Flash Control] → [Built-in flash settings] → [Shutter Sync.] → choose an option



Changing the Flash Metering Mode



Evaluative

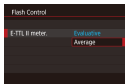

Average

[Evaluative] flash metering, which enables standard flash exposure, can be changed to average flash metering across the metering area, as when using an externally metered flash.

1

Access the menu screen

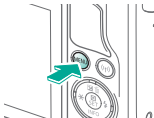

2

Set up the camera

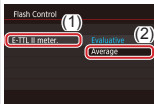

- [CAMERA] → [Flash Control] → [E-TTL II meter.] → [Average] → [SET] button



Adjusting the Flash Output



Minimum



Maximum

Choose from the three flash levels in **[M/Av/Tv]** modes.

1

Set the mode



2

Set the shooting mode

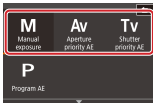

● **[M/Av/Tv]** →
[OK]

3

Access the menu screen

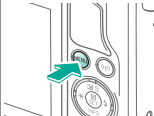



Adjusting the Flash Output



: Minimum



: Maximum

Choose from the three flash levels in **[M/Av]** modes.

4

Set up the camera

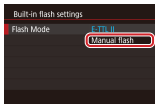

- [5] → [Flash Control] → [Built-in flash settings] → [Flash Mode] → [Manual flash] → **MENU** button

5

Raise the flash



6

Adjust the flash output





Adjusting the Flash Output



Minimum



Maximum

Choose from the three flash levels in **[M/Av]** / **[Tv]** modes.



- ▶ button → dial to adjust → SET button



Resetting Flash Settings



1

Access the menu screen

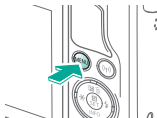

2

Restore the default settings



- [CAMERA] → [Flash Control] → [Clear settings]

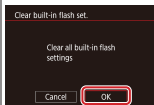

- [OK] → [SET] button



Shooting Other Settings



Based on a Sample Image	Auto Mode	Specific Scenes
Image Effects (Creative Filters)	Manual Mode	Recording Movies in Movie Mode
Convenient Features		



Changing the IS Mode Settings



Correcting Camera Shake when Recording Movies



Correcting Lens Aberrations



Changing the Noise Reduction Level



Using Multi Shot Noise Reduction



Reducing Noise at Slow Shutter Speeds



Changing the IS Mode Settings



Continuous



Off

Configure image stabilization via the camera menu when using an EF-M lens with image stabilization.

1

Access the menu screen

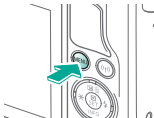

2

Set up the camera



- [CAMERA] → [IS Settings]
→ [IS Mode] →
choose an option



Correcting Camera Shake when Recording Movies



Enable



Disable

Activate image stabilization on the camera to correct camera shake when recording movies with a lens that supports image stabilization.

1

Access the menu screen

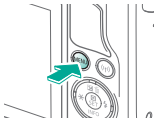

2

Set up the camera

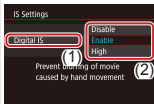

- [CAMERA] → [IS Settings]
→ [Digital IS] →
choose an option



Correcting Lens Aberrations



Peripheral illumination correction: Disable



Peripheral illumination correction: Enable

Correct vignetting and subject color fringing due to lens characteristics, or lack of image sharpness due to aperture.

1

Access the menu screen

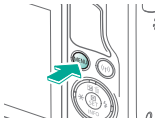

2

Set up the camera

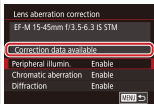

- [CAMERA] → [Lens aberration correction] → choose an option
- Confirm that [Correction data available] is displayed.

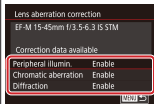

- Choose an option → [SET] button



Changing the Noise Reduction Level



You can choose from 3 levels of noise reduction: [Standard], [High], [Low]. This function is especially effective when shooting at high ISO speeds.

1

Access the menu screen

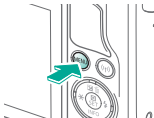

2

Set up the camera



- [CAMERA] → [High ISO speed NR] → choose an option → [SET] button



Using Multi Shot Noise Reduction



Automatically combine four images captured at once to reduce noise. This enables higher image quality than setting [High ISO speed NR] to [High].

1

Access the menu screen

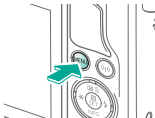

2

Set up the camera



- [CAMERA] → [High ISO speed NR] → [NR] → [SET] button



Reducing Noise at Slow Shutter Speeds



Reduce noise from long exposures at shutter speeds of one second or slower.

1

Access the menu screen

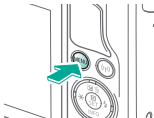

2

Set up the camera

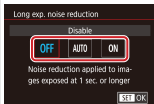

- [CAMERA] → [Long exp. noise reduction] → choose an option → [SET] button



Shooting

Specific Shutter Speeds and Apertures



Based on a Sample Image	Auto Mode	Specific Scenes
Image Effects (Creative Filters)	Manual Mode	Recording Movies in Movie Mode
Convenient Features		



Specific Shutter Speeds (Tv Mode)



Specific Aperture Values (Av Mode)



Specific Brightness/Exposure (M Mode)



Shooting Long Exposures (Bulb)



Recording Movies at Specific Shutter Speeds and Aperture Values



Specific Shutter Speeds (Tv Mode)



Slow



Fast

Set your preferred shutter speed before shooting. The camera automatically adjusts the aperture value to suit your shutter speed.

1

Set the mode



2

Set the shooting mode



• [Tv] → [OK]

3

Set up the camera



• Turn the  dial.





Specific Shutter Speeds (Tv Mode)



Slow



Fast

Set your preferred shutter speed before shooting. The camera automatically adjusts the aperture value to suit your shutter speed.

4

Shoot





Specific Aperture Values (Av Mode)



Small



Large

Set your preferred aperture value before shooting. The camera automatically adjusts the shutter speed to suit your aperture value.

1

Set the mode



2

Set the shooting mode

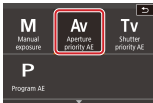

● [Av] → [OK]

3

Set up the camera



● Turn the  dial.





Specific Aperture Values (Av Mode)



Small



Large

Set your preferred aperture value before shooting. The camera automatically adjusts the shutter speed to suit your aperture value.

4

Shoot





Specific Brightness/Exposure (M Mode)



Set the shutter speed and aperture value to obtain your desired exposure.

1

Set the mode



2

Set the shooting mode

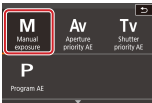

● **[M]** → [OK]

3

Set the ISO speed



● **[ISO AUTO]** → choose an ISO speed





Specific Brightness/Exposure (M Mode)



Set the shutter speed and aperture value to obtain your desired exposure.

4

Set the shutter speed





● Turn the  dial.

5

Set the aperture value



●  button →  dial

6

Shoot





Shooting Long Exposures (Bulb)



With bulb exposures, shots are exposed for as long as you hold down the shutter button all the way down.

1

Set the mode



2

Set the shooting mode

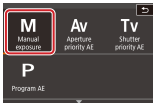

● **M** → [OK]

3

Set up the camera





Shooting Long Exposures (Bulb)



With bulb exposures, shots are exposed for as long as you hold down the shutter button all the way down.

4

Shoot



- Turn the  dial to set the shutter speed to [BULB].



Recording Movies at Specific Shutter Speeds and Aperture Values



Manual movie

Set your preferred shutter speed, aperture value, and ISO speed.

1

Set the mode



2

Set the shooting mode



● [M] → [OK]

3

Set the ISO speed



● ▲ button → 





Recording Movies at Specific Shutter Speeds and Aperture Values



Manual movie

Set your preferred shutter speed, aperture value, and ISO speed.

4

Set the shutter speed



● ▲ button → 
dial

5

Set the aperture value



● ▲ button → 
dial

6

Shoot

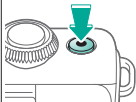



Shooting

Customizing the Camera



Based on a Sample Image	Auto Mode	Specific Scenes
Image Effects (Creative Filters)	Manual Mode	Recording Movies in Movie Mode
Convenient Features		

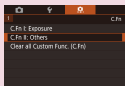

Configuring Custom Functions



Changing Items on the Quick Control Screen



Rearranging Items on the Quick Control Screen



Configuring Custom Functions



Configure custom functions on the [Fn] tab of the menu to customize how the camera works to suit your shooting preferences.

You can also assign commonly used functions to specific buttons.

1

Access the menu screen

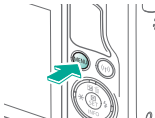

2

Choose the type of function to customize

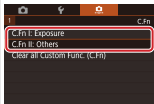

- [Fn] → choose an item → [SET] button

3

Choose a function

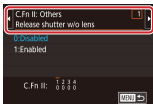

- Choose a function → [SET] button

4

Choose an option

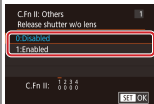

- Choose an option → [SET] button



Changing Items on the Quick Control Screen



1

Access the menu screen

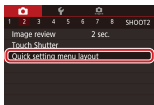
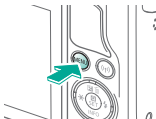

- [CAMERA] → [Quick setting menu layout] → [MENU] button

2

Choose icons to include

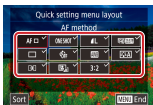

- Choose an icon → [MENU] button to select (✓) → MENU button

3

Set up the camera

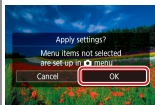

- [OK] → [MENU] button



Rearranging Items on the Quick Control Screen



1

Access the menu screen

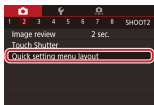
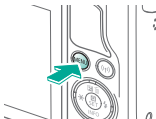

- [CAMERA] → [Quick setting menu layout] → [MENU] button

2

Rearrange the icons



- Touch [Sort].



- Choose an icon → [MENU] button → ▲/▼ buttons → choose a destination → [MENU] button → **MENU** button







Rearranging Items on the Quick Control Screen

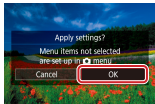

3

Set up the camera



● [OK] →  button





Shooting Creative Assist



Based on a Sample Image	Auto Mode	Specific Scenes
Image Effects (Creative Filters)	Manual Mode	Recording Movies in Movie Mode
Convenient Features		



Shooting with Your Favorite
Settings (Creative Assist)



Saving Creative Assist
Settings



Loading Creative Assist
Settings



Using Settings from Creative
Assist Images



Shooting with Your Favorite Settings (Creative Assist)



Defocus the background, adjust brightness, or change other settings in other ways as you watch the screen. You can also save your settings or apply settings from past images captured in [★] mode.

1

Set the mode



2

Set the shooting mode



● [★] → [OK]

3

Access the setting screen





Shooting with Your Favorite Settings (Creative Assist)



Defocus the background, adjust brightness, or change other settings in other ways as you watch the screen. You can also save your settings or apply settings from past images captured in [★] mode.

4

Set up the camera



● ▲/▼ buttons to navigate → ◀▶ buttons to adjust

5

Return to the shooting screen



6

Shoot





Saving Creative Assist Settings



1

Set the mode



2

Set the shooting mode



3

Access the setting screen





4

Set up the camera



- ▲/▼ buttons to navigate → ◀▶ buttons to adjust → (SET) button

5

Register

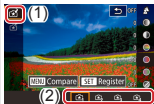

- [★] → choose an option → (SET) button

6

Return to the shooting screen



- [OK] → (SET) button





Loading Creative Assist Settings



1

Set the mode



2

Set the shooting mode

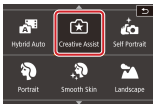

● [Creative Assist icon] → [OK]

3

Access the setting screen





4

Load the settings



- [Creative Assist icon] → choose an option → [Creative Assist icon] button





Using Settings from Creative Assist Images



1

Set the mode



2

Set the shooting
mode

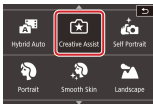

● [Creative Assist] → [OK]

3

Enter Playback
mode





4

Choose an image from  mode





- Choose an image →  button

5

Apply the settings



-  →  button





Shooting



Based on a Sample Image	Auto Mode	Specific Scenes
Image Effects (Creative Filters)	Manual Mode	Recording Movies in Movie Mode
Convenient Features		



Recording Movies



Locking or Changing Image Brightness



Disabling Auto Slow Shutter



Recording Time-Lapse Movies
(Time-Lapse Movie)



Adjusting the Recording
Volume



Deactivating the Wind Filter





Shooting



Based on a Sample Image	Auto Mode	Specific Scenes
Image Effects (Creative Filters)	Manual Mode	Recording Movies in Movie Mode
Convenient Features		



Using the Attenuator





Recording Movies



Record movies in [M] mode using a variety of effects and features.

1

Set the mode



2

Set the shooting mode

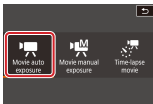

● [M] → [OK]

3

Start recording

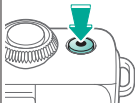



Recording Movies



Record movies in [📹] mode using a variety of effects and features.

4

Stop recording

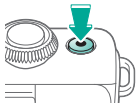



Locking or Changing Image Brightness



Set toward -



Set toward +

You can lock the exposure before or during recording or adjust it in 1/3-stop increments within a range of -3 to +3 stops.

1

Set the mode



2

Set the shooting mode

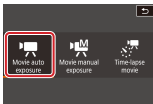

● [MOVIE] → [OK]

3

Lock the exposure





Locking or Changing Image Brightness



Set toward -



Set toward +

You can lock the exposure before or during recording or adjust it in 1/3-stop increments within a range of -3 to +3 stops.

4

Adjust the exposure



● ▲ button → turn dial while watching the screen

5

Shoot

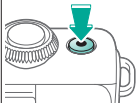



Disabling Auto Slow Shutter



Auto slow shutter can be disabled if movement in movies is rough. However, under low light, movies may look dark.

1

Set the mode



2

Set the shooting mode

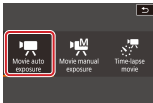

● [Movie auto exposure] → [OK]

3

Access the menu screen

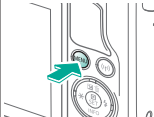



Disabling Auto Slow Shutter



Auto slow shutter can be disabled if movement in movies is rough. However, under low light, movies may look dark.

4

Set up the camera

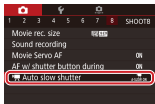

- [CAMERA] → [Auto slow shutter] → [SET] button



- [Disable] → [SET] button



Recording Time-Lapse Movies (Time-Lapse Movie)



Time-lapse movies combine images that are shot automatically at a specified interval. Any gradual changes of the subject (such as changes in a landscape) are played back in fast motion.

1

Set the mode



2

Set the shooting mode

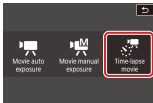

● [Time-lapse movie] → [OK]

3

Set up the camera





Recording Time-Lapse Movies (Time-Lapse Movie)



Time-lapse movies combine images that are shot automatically at a specified interval. Any gradual changes of the subject (such as changes in a landscape) are played back in fast motion.

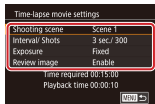

- Choose an item → adjust → **MENU** button

4

Secure the camera and start recording

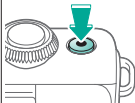



Adjusting the Recording Volume



Adjusting the recording volume

Although the recording level (volume) is automatically adjusted when set to [Auto], you can set the level manually to suit the scene recorded.

1

Set the mode



2

Set the shooting mode

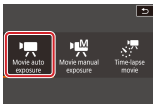

● [Movie auto exposure] → [OK]

3

Access the menu screen

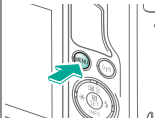



Adjusting the Recording Volume



Adjusting the recording volume

Although the recording level (volume) is automatically adjusted when set to [Auto], you can set the level manually to suit the scene recorded.

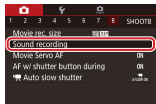

● [CAMERA] → [Sound recording] → [SET] button

4

Set up the camera



● [Sound recording] → [Manual] → [SET] button





Adjusting the Recording Volume



Adjusting the recording volume

Although the recording level (volume) is automatically adjusted when set to [Auto], you can set the level manually to suit the scene recorded.



- [Rec. level] →
- [SET] button → 
- buttons to adjust →
- [SET] button



Deactivating the Wind Filter



Noise caused by strong wind can be reduced with the wind filter. However, the recording may sound unnatural when this option is used when there is no wind. In this case, you can deactivate the wind filter.

1

Set the mode



2

Set the shooting mode

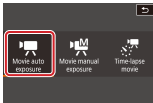

● [Movie auto exposure] → [OK]

3

Access the menu screen

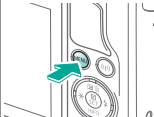



Deactivating the Wind Filter



Noise caused by strong wind can be reduced with the wind filter. However, the recording may sound unnatural when this option is used when there is no wind. In this case, you can deactivate the wind filter.

4

Set up the camera

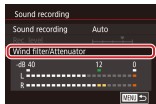

- [CAMERA] → [Sound recording] → [Wind filter/Attenuator] → [SET] button



- [Wind Filter] → [Off] → [SET] button



Using the Attenuator



Recording in noisy places

Set to [Auto] to reduce audio distortion by automatically activating and deactivating the attenuator to suit recording conditions. The attenuator can also be set to [On] or [Off] manually.

1

Set the mode



2

Set the shooting mode

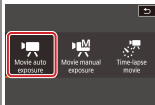

● [Movie auto exposure] → [OK]

3

Access the menu screen

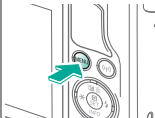



Using the Attenuator



Recording in noisy places

Set to [Auto] to reduce audio distortion by automatically activating and deactivating the attenuator to suit recording conditions. The attenuator can also be set to [On] or [Off] manually.

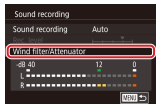

- [CAMERA] → [Sound recording] → [Wind filter/Attenuator] → [SET] button

4

Set up the camera

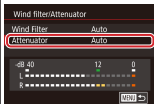

- [Attenuator] → choose an option → [SET] button



Shooting



Based on a Sample Image	Auto Mode	Specific Scenes
Image Effects (Creative Filters)	Manual Mode	Recording Movies in Movie Mode
Convenient Features		



Using the Self-Timer



Using the Self-Timer to Avoid Camera Shake



Adjusting the Self-Timer



Shooting by Touching the Screen (Touch Shutter)



Continuous Shooting



Changing Image Quality





Shooting



Based on a Sample Image	Auto Mode	Specific Scenes
Image Effects (Creative Filters)	Manual Mode	Recording Movies in Movie Mode
Convenient Features		



Capturing in RAW Format



Changing the Aspect Ratio



Changing Movie Image Quality





Using the Self-Timer



With the self-timer, you can include yourself in group photos or other timed shots. The camera will shoot about 10 seconds after you press the shutter button.

1

Access the setting screen



2

Set up the camera



● [OFF] → [10] → [SET]
button

3

Shoot





Using the Self-Timer to Avoid Camera Shake



This option delays shutter release until about two seconds after you have pressed the shutter button. If the camera is unsteady while you are pressing the shutter button, it will not affect your shot.

1

Access the setting screen



2

Set up the camera



● [OFF] → [C2] → SET
button

3

Shoot





Adjusting the Self-Timer



You can specify the delay (0 – 30 seconds) and number of shots (1 – 10).

1

Access the setting screen



2

Set up the camera



● [OFF] → [C] →
MENU button



- Choose time/no. of shots → ◀▶ buttons to choose a value → **MENU** button





Adjusting the Self-Timer



You can specify the delay (0 – 30 seconds) and number of shots (1 – 10).

3

Shoot





Shooting by Touching the Screen (Touch Shutter)



With this option, instead of pressing the shutter button, you can simply touch the screen and release your finger to shoot. The camera will focus on subjects and adjust image brightness automatically.

1

Set up the camera



- Touch [OFF] and change it to [Touch Shutter].

2

Shoot





Continuous Shooting



In [A+] mode, hold the shutter button all the way down to shoot continuously.

1

Set the mode



2

Access the setting screen



3

Set up the camera

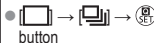

4

Shoot





Continuous Shooting



In **[A+]** mode, hold the shutter button all the way down to shoot continuously.



- Hold the shutter button all the way down.



Changing Image Quality



	24.0 megapixels/ high quality		Approx. 10.6 megapixels/ high quality		Approx. 5.9 megapixels/ high quality		Approx. 3.8 megapixels/ normal quality
	24.0 megapixels/ normal quality		Approx. 10.6 megapixels/ normal quality		Approx. 5.9 megapixels/ normal quality		

1

Access the setting screen



2

Choose the setting item



- → choose an option →



Capturing in RAW Format



The camera can capture images in JPEG and RAW format. RAW images are “raw” (unprocessed) data, recorded with essentially no loss of image quality from the camera’s image processing.

1

Access the setting screen



2

Choose the setting item



- Choose [L].

3

Set up the camera



- RAW format only:
choose [RAW]





Capturing in RAW Format



The camera can capture images in JPEG and RAW format. RAW images are “raw” (unprocessed) data, recorded with essentially no loss of image quality from the camera’s image processing.



- JPEG+RAW:
choose JPEG image
quality → press the
MENU button to
select (✓) [RAW]



Changing the Aspect Ratio



16:9



3:2



4:3



1:1

1

Access the setting screen



2

Choose the setting item



- **3:2** → choose an option → button



Changing Movie Image Quality



Adjust movie image quality (image size and frame rate). The frame rate indicates how many frames are recorded per second, and your options depend on the NTSC or PAL setting.

1

Access the setting screen



2

Choose the setting item



- [FHD 29.97P] →
choose an option →
[SET] button



Playback



Viewing	Finding	Managing
Erasing Images	Editing Stills	Processing RAW Images with the Camera
Editing Movies		



Viewing Stills



Magnifying Images



Viewing Slideshows



Viewing Movies



Viewing Digest Movies



Viewing Stills



After shooting images, you can view them on the screen.

1

Enter Playback mode



2

Browse your images



- button: Next image
- button: Previous image



Magnifying Images



Images can be magnified or reduced.

1

Enter Playback mode



2

Browse your images



3

Magnify or reduce images

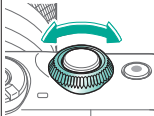

4

Change image display





Magnifying Images



Images can be magnified or reduced.



- Move images: ▲/▼
/◀▶ buttons
- Switch images:
Ⓢ button → ◀▶
buttons



Viewing Slideshows



Automatically play back images from a memory card.

1

Enter Playback mode



2

Access the menu screen

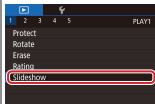
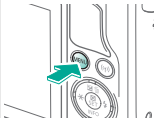

- [▶] → [Slideshow] → [SET] button

3

Play the slideshow

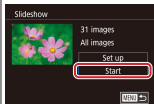

- [Start] → [SET] button



Viewing Movies



After recording movies, you can view them on the screen.

Movies are identified by a **[SET ▶]** icon.

1

Enter Playback mode



2

Browse your images



- ▶ button: Next image
- ◀ button: Previous image





Viewing Movies



After recording movies, you can view them on the screen.

Movies are identified by a **[SET ▶]** icon.

3

Play the movie



● [▶] → button

4

Adjust the volume





Viewing Digest Movies



A short movie of scenes that include your shots in [A] mode is created automatically. Playing a digest movie shows the scenes captured that day.

1

Enter Playback mode



2

Browse your images



3

Play the movie





Viewing Digest Movies



A short movie of scenes that include your shots in [A] mode is created automatically. Playing a digest movie shows the scenes captured that day.



● [A] → [SET] button



Playback



Viewing	Finding	Managing
Erasing Images	Editing Stills	Processing RAW Images with the Camera
Editing Movies		



Finding Images in an Index



Finding Images Matching Specified Conditions



Finding Images with the Front Dial



Finding Images in an Index



By displaying multiple images in an index, you can quickly find the images you are looking for.

1

Enter Playback mode



2

Display images in an index

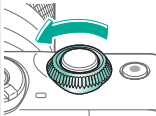

3

Browse your images

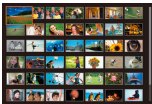



Finding Images Matching Specified Conditions



Find desired images quickly on a memory card full of images by filtering image display according to your specified conditions.

1

Enter Playback mode



2

Access the setting screen



3

Choose a condition



● [👁️] → [SET] button





Finding Images Matching Specified Conditions



Find desired images quickly on a memory card full of images by filtering image display according to your specified conditions.



- Choose a condition.
- After choosing [★ / (🕒) / (📷)]: choose a second condition

4

View the images



- Matching images are displayed in yellow frames.



Finding Images with the Front Dial



Use the front dial to find and jump between desired images quickly according to your specified conditions.

1

Enter Playback mode



2

Choose a condition



- In single-image display, drag left or right with two fingers.





Use the front dial to find and jump between desired images quickly according to your specified conditions.

3

View the images

- When search conditions are displayed, press the ▲/▼ buttons to choose one.

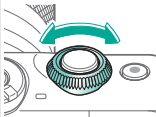



Playback



Viewing	Finding	Managing
Erasing Images	Editing Stills	Processing RAW Images with the Camera
Editing Movies		



Protecting Individual Images

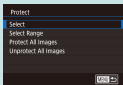

Protecting Multiple Images

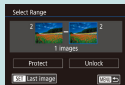

Protecting a Range of Images



Protecting All Images at Once



Rating Images (Rating)



Protecting Individual Images

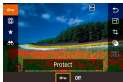

Individual images can be protected to prevent accidental erasure of important images.

1

Enter Playback mode



2

Browse your images



3

Access the setting screen



4

Protect



● [PLAYBACK] → [SET] →
[SET] button



Protecting Multiple Images



Multiple images can be selected individually and protected.

1

Enter Playback mode



2

Access the menu screen

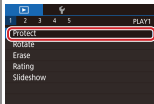
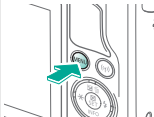

- [▶1] → [Protect]
→ [SET] button

3

Choose the setting item

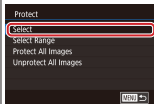

- [Select] → [SET] button





Protecting Multiple Images



Multiple images can be selected individually and protected.

4

Browse your images

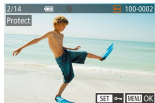

- Choose an image →
SET button

5

Protect

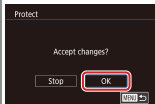
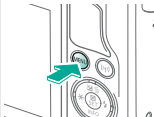

- [OK] → SET button



Protecting a Range of Images

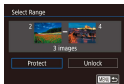

Ranges of images can be protected to prevent accidental erasure of important images.

1

Enter Playback mode



2

Access the menu screen

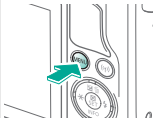

3

Choose the setting item

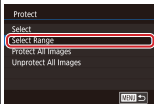

- [▶] 1 → [Protect] → [Select Range] → [SET] button





Protecting a Range of Images

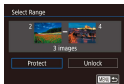

Ranges of images can be protected to prevent accidental erasure of important images.

4

Choose a starting image

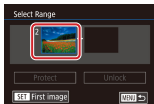

- [First image] → button



- Choose an image → button

5

Choose an ending image

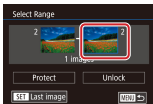

- [Last image] → button



- Choose an image → button



Protecting a Range of Images

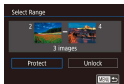

Ranges of images can be protected to prevent accidental erasure of important images.

6

Protect

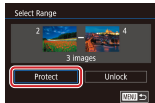

- ▼ button → [Protect]
- [SET] button



Protecting All Images at Once

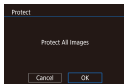

All images can be protected to prevent accidental erasure of important images.

1

Enter Playback mode



2

Access the menu screen

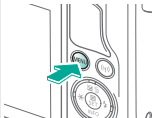

3

Choose the setting item

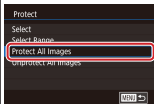

- [▶] 1 → [Protect] → [Protect All Images] → [SET] button





Protecting All Images at Once

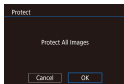

All images can be protected to prevent accidental erasure of important images.

4

Set up the camera

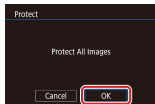

● [OK] →  button



Rating Images (Rating)



Organize images by rating them on a scale of 1 – 6.

1

Enter Playback mode



2

Browse your images



3

Access the setting screen



4

Set up the camera



- [★] → choose a rating → [SET] button



Playback



Viewing	Finding	Managing
Erasing Images	Editing Stills	Processing RAW Images with the Camera
Editing Movies		



Erasing Individual Images



Erasing Multiple Images

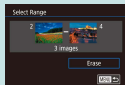

Erasing a Range of Images

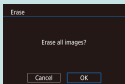

Erasing All Images



Erasing Individual Images



You can choose and erase unneeded images one by one. Be careful when erasing images, because they cannot be recovered.

1

Enter Playback mode



2

Browse your images



3

Erase



● [Erase] → button



Erasing Multiple Images



Multiple images can be selected individually and erased. Be careful when erasing images, because they cannot be recovered.

1

Enter Playback mode



2

Access the menu screen

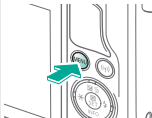

3

Choose the setting item

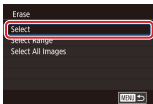

- [▶] → [Erase] → [Select] → [SET] button

4

Browse your images





Erasing Multiple Images



Multiple images can be selected individually and erased. Be careful when erasing images, because they cannot be recovered.

5

Erase

- Choose an image →

 button to select
(✓)

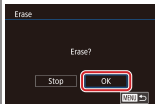
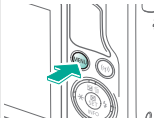

- [OK] →  button



Erasing a Range of Images

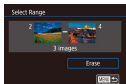

A range of images can be selected and erased. Be careful when erasing images, because they cannot be recovered.

1

Enter Playback mode



2

Access the menu screen

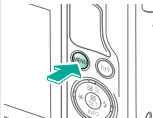

3

Choose the setting item

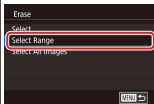

● [▶] 1 → [Erase] →
[Select Range] → [SET] button





Erasing a Range of Images

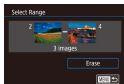

A range of images can be selected and erased. Be careful when erasing images, because they cannot be recovered.

4

Choose a starting image

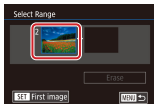

- [First image] → button



- Choose an image → button

5

Choose an ending image

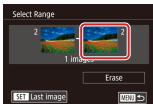

- [Last image] → button



- Choose an image → button



Erasing a Range of Images

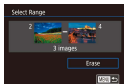

A range of images can be selected and erased. Be careful when erasing images, because they cannot be recovered.

6

Erase

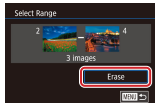

- ▼ button → [Erase]
- [SET] button



Erasing All Images

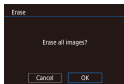

All images can be erased at once. Be careful when erasing images, because they cannot be recovered.

1

Enter Playback mode



2

Access the menu screen

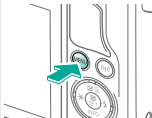

3

Choose the setting item

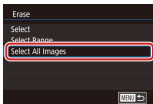

- [▶] 1 → [Erase] → [Select All Images] → [SET] button





Erasing All Images

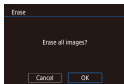

All images can be erased at once. Be careful when erasing images, because they cannot be recovered.

4

Erase

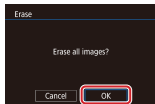

● [OK] →  button



Playback



Viewing	Finding	Managing
Erasing Images	Editing Stills	Processing RAW Images with the Camera
Editing Movies		



Rotating Images



Resizing Images



Cropping



Applying Filter Effects



Correcting Red-Eye



Rotating Images



Change the orientation of images and save them.

1

Enter Playback mode



2

Browse your images



3

Access the setting screen



4

Choose the setting item



● Choose .





Rotating Images



Change the orientation of images and save them.

5

Rotate the image

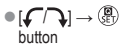
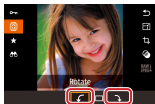



Resizing Images



Save a smaller version of an image, with fewer pixels.

1

Enter Playback mode



2

Browse your images



3

Access the setting screen



4

Choose the setting item

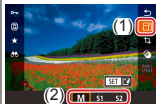

- → choose an option →





Resizing Images



Save a smaller version of an image, with fewer pixels.

5

Save the new image



● [OK] →  button

6

Review the new image



● [Processed img.] →  button



Cropping



You can specify a portion of an image to save as a separate image file.

1

Enter Playback mode



2

Browse your images



3

Access the setting screen



4

Choose the setting item



● [Crop] → [SET] button





Cropping



You can specify a portion of an image to save as a separate image file.

5

Adjust the cropping frame



- Resize: Pinch in or out on the screen
- Move: ▲/▼/◀▶ buttons

6

Preview the image



- Change orientation: gear dial → [↻] button
- Change aspect ratio: gear dial → [↔] button



Cropping



You can specify a portion of an image to save as a separate image file.



- dial → → button
- Switch display: button

7

Save the new image



- dial → → button

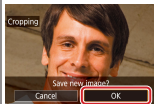

- [OK] → button

8

Review the new image



- [Processed img.] → button



Applying Filter Effects



Apply effects equivalent to shooting in [📷/👤/👤]
[👤/👤/📷/📷] modes to images and save
them as separate images.

1

Enter Playback
mode



2

Browse your
images



3

Access the setting
screen



4

Choose an effect



- [📷] → choose an option → [SET] button



Applying Filter Effects



Apply effects equivalent to shooting in [MENU/PERSON/VIDEO] modes to images and save them as separate images.

5

Adjust the effect



• ▲/▼/◀▶ buttons
or  dial to
adjust →  button

6

Save the new image



• [OK] →  button

7

Review the new image



• [Processed img.] →
 button



Correcting Red-Eye



Automatically corrects images affected by red-eye. You can save the corrected image as a separate file.

1

Enter Playback mode



2

Access the menu screen

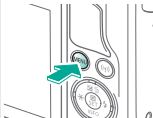

3

Choose the setting item

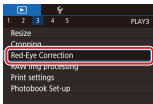

● [▶] 3 → [Red-Eye Correction] → [SET]





Correcting Red-Eye



Automatically corrects images affected by red-eye. You can save the corrected image as a separate file.

4

Browse your images



5

Correct the image



● Press the  button.

6

Save the new image



● [New File] →  button

7

Review the new image





Correcting Red-Eye



Automatically corrects images affected by red-eye. You can save the corrected image as a separate file.



- **MENU** button →
[Processed img.] →
 button



Playback



Viewing	Finding	Managing
Erasing Images	Editing Stills	Processing RAW Images with the Camera
Editing Movies		



Processing RAW Images



Setting Processing Conditions and Processing RAW Images



Processing RAW Images



Process images captured in RAW format on the camera. The original RAW image is retained, and a copy is saved as a JPEG.

1

Enter Playback mode



2

Choose a RAW image



3

Access the setting screen



4

Choose the setting item



● [RAW | JPEG] → [RAW] → [SET] button





Processing RAW Images



Process images captured in RAW format on the camera. The original RAW image is retained, and a copy is saved as a JPEG.

5

Save

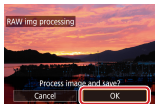

● [OK] → button

6

Review the new image



● [Processed img.] → button



Setting Processing Conditions and Processing RAW Images



Processing conditions can be set in detail before processing RAW images on the camera. The original RAW image is retained, and a copy is saved as a JPEG.

1

Enter Playback mode



2

Choose a RAW image



3

Access the setting screen



4

Choose the setting item



● [RAW] → [RAW] → [SET] button





Setting Processing Conditions and Processing RAW Images



Processing conditions can be set in detail before processing RAW images on the camera. The original RAW image is retained, and a copy is saved as a JPEG.

5

Set the processing conditions



- Choose an item →



- Choose an option →

6

Save



- → button → [OK] →

7

Review the new image



- [Processed img.] →



Playback



Viewing	Finding	Managing
Erasing Images	Editing Stills	Processing RAW Images with the Camera
Editing Movies		



Cutting Off the Beginning/End of Movies



Reducing File Sizes



Editing Digest Movies



Cutting Off the Beginning/End of Movies



You can remove unneeded portions from the beginning and end of movies. Note that digest movies cannot be cut off.

1

Enter Playback mode



2

Browse your movies

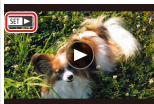

- Choose a movie →
SET button

3

Start and then pause playback



- [▶] → SET button
→ SET button during playback





Cutting Off the Beginning/End of Movies

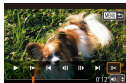

You can remove unneeded portions from the beginning and end of movies. Note that digest movies cannot be cut off.

4

Choose the setting item



- [SC] → [SET] button

5

Specify portions to cut



- [SC] → [LEFT] → [RIGHT] buttons to move [SC]
- [SC] is displayed.

- Cut the beginning of the movie (from [SC]) by choosing [LEFT], and cut the end of the movie by choosing [RIGHT].



Cutting Off the Beginning/End of Movies



You can remove unneeded portions from the beginning and end of movies. Note that digest movies cannot be cut off.

6

Review the edited movie



● [▶] → [SET] button

7

Save



● [📁] → [SET] button



● [New File] → [SET] button



● [Save w/o Comp.] → [SET] button



Reducing File Sizes



Movie file sizes can be reduced by compressing movies.

1

Enter Playback mode



2

Browse your movies

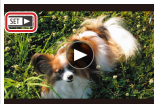

- Choose a movie →
[SET] button

3

Start and then pause playback



- [▶] → [SET] button
→ [SET] button during playback





Reducing File Sizes



Movie file sizes can be reduced by compressing movies.

4

Choose the setting item

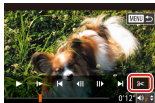

● [Set] → [SET] button

5

Choose the setting item



● [New File] → [SET] button

6

Save



● [New File] → [SET] button



● [Compress & Sav.] → [SET] button



Editing Digest Movies



Individual chapters (clips) recorded in [A] mode can be erased, as needed. Be careful when erasing clips, because they cannot be recovered.

1

Enter Playback mode



2

Browse your images



- Choose a [SET] image
→ [SET] button





Individual chapters (clips) recorded in [A] mode can be erased, as needed. Be careful when erasing clips, because they cannot be recovered.

3

Start and then pause playback



- [A] → [SET] button
→ [SET] button during playback

4

Select the clip to erase



- [A] → [SET] button

5

Choose [trash]

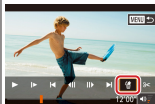

- [trash] → [SET] button



Individual chapters (clips) recorded in [A⁵+] mode can be erased, as needed. Be careful when erasing clips, because they cannot be recovered.

6

Erase

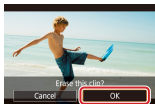

● [OK] →  button



Wireless Features



Available Wireless Features



Sending Images to an
NFC-Compatible Smartphone



Sending Images to an NFC-Compatible
Smartphone (Playback Mode)



Sending Images to a Bluetooth
Enabled Smartphone

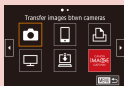

Registering Web Services
CANON iMAGE GATEWAY

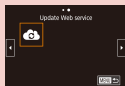

Registering Web Services
Other Web Services



Uploading Images to Web
Services



Available Wireless Features



Wi-Fi Features

Smartphones and Tablets

Send images to smartphones and tablet computers that have Wi-Fi features.

Web Services

Send images to CANON iMAGE GATEWAY or other Web services.

Bluetooth® Features

You can easily pair the camera with a smartphone featuring Bluetooth low energy technology (hereafter referred to as “Bluetooth”).

You can shoot or view images by using your smartphone as a remote control.





Available Wireless Features



Media Players

View images on DLNA*-compatible TVs or other devices.

* Digital Living Network Alliance

Printers

Print images wirelessly on a PictBridge-compatible printer (supporting DPS over IP).

Other Cameras

Send and receive images wirelessly between Wi-Fi-compatible Canon cameras.

For instructions on these three features, refer to the Help Guide.





Sending Images to an NFC-Compatible Smartphone



1

Turn the camera on



2

Install Camera Connect



- Turn on NFC.

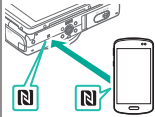

- Touch the **N** marks together.
- Google Play starts up automatically on the smartphone.



- Download and install Camera Connect.





Sending Images to an NFC-Compatible Smartphone



3

Establish the connection

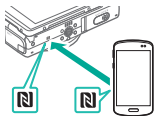

- Touch the  marks together.



- [OK] →  button
- Camera Connect starts up on the smartphone, and the devices are connected automatically.

4

Adjust the privacy setting

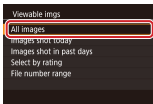

- [All images] →  button

5

Send

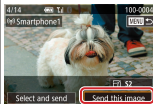

- Choose an image → [Send this image] →  button







Sending Images to an NFC-Compatible Smartphone

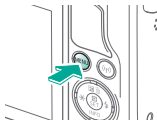

6

End the connection



- **MENU** button →
- [OK] →  button





Sending Images to an NFC-Compatible Smartphone (Playback Mode)



1

Enter Playback mode



2

Install Camera Connect



- Turn on NFC.

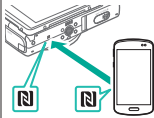

- Touch the **N** marks together.
- Google Play starts up automatically on the smartphone.



- Download and install Camera Connect.





Sending Images to an NFC-Compatible Smartphone (Playback Mode)



3

Establish the connection

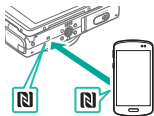

- Touch the  marks together.



4

Browse your images



- [OK] →  button
- Camera Connect starts up on the smartphone, and the devices are connected automatically.



- Choose an image →  button to select 
- **MENU** button → [OK] →  button

5

Send

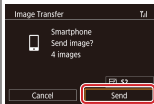

- [Send] →  button





Sending Images to an NFC-Compatible Smartphone (Playback Mode)



6

End the connection

- **MENU** button →
[OK]





Sending Images to a Bluetooth Enabled Smartphone



1

Install Camera Connect



- Download and install Camera Connect from the App Store/ Google Play.

2

Turn the camera on



3

Register a nickname

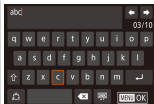
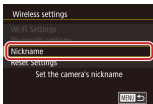

- **MENU** button → [F4] → [Wireless settings] → [Nickname] → [SET] button
- Enter a nickname → **MENU** button





Sending Images to a Bluetooth Enabled Smartphone

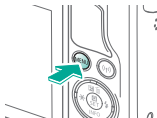

- The [Wireless settings] screen is displayed again.

4

Prepare for pairing

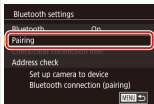

- [Bluetooth settings] → [Pairing] →



- The camera is ready for the connection.

5

Start Camera Connect



- Turn on Bluetooth.
- Start Camera Connect.





Sending Images to a Bluetooth Enabled Smartphone



6

Select the camera to connect to



- Do this on the smartphone.



7

Complete pairing

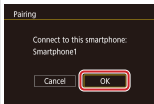

- [OK] → button

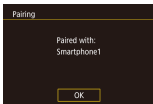

- Press the button.

8

Import images



- Do this on the smartphone.



Registering Web Services

CANON IMAGE GATEWAY



1

Access the Wi-Fi menu



2

Choose [Cloud]



- If [Device Nickname] screen is displayed:
[OK] → [SET] button

3

Accept the agreement to enter an email address



- [Cloud] → [SET] button

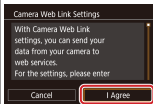

- [I Agree] → [SET] button





Registering Web Services CANON IMAGE GATEWAY



4

Choose how to connect to the access point



(a) WPS connection

- [Connect with WPS]
→ button →
step 5 (A)

(b) Choosing from the list

- Choose an access point → button
→ step 5 (B)

5

(A) Establish the connection

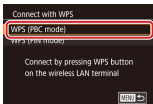

- [WPS (PBC mode)]
→ button



- On the access point, hold down the WPS connection button for a few seconds.







Registering Web Services CANON IMAGE GATEWAY





- Press the  button.

(B) Establish the connection

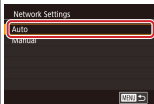

-  button → enter the password → [Next] → 





- [Auto] → 

6

Enter your email address



-  button → enter your email address → [Next] → 





Registering Web Services CANON IMAGE GATEWAY



7

Enter a four-digit number



- button → enter a number → [Next] → button
- This number is also needed in step 9.

8

Check for the message

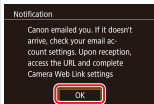

- You will receive a notification message at the email address entered in step 6.
- On the confirmation screen, press the button.

9

Set up camera link



- now changes to .



- On a computer/ smartphone, visit the page in the message and follow the instructions.





Registering Web Services CANON iIMAGE GATEWAY



- [Cloud icon] → [SET] button
- [Camera icon] and CANON iIMAGE GATEWAY are now added as destinations.





Registering Web Services

Other Web Services



1

Access the setting screen



- From a computer/ smartphone, access <http://www.canon.com/cig/> to visit CANON IMAGE GATEWAY.

2

Configure the Web service you want to use



- Follow the instructions to complete the settings.

3

Access the Wi-Fi menu

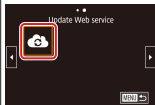

- [Web service icon] → [SET] button
- The Web service settings are now updated.



Uploading Images to Web Services



1

Access the Wi-Fi menu



2

Choose the destination



- Choose an icon →
- If [Select Recipient] screen is displayed: choose an option →

3

Send

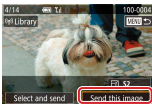

- Choose an image → [Send this image] →
- [OK] on screen after sending →



Other Settings

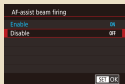

Preventing the AF-Assist Beam from Firing

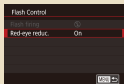

Deactivating the Red-Eye Reduction Lamp

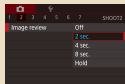

Changing the Image Display Period after Shots



Date-Based Image Storage

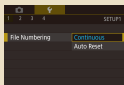

File Numbering

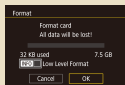

Formatting Memory Cards

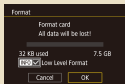

Low-Level Formatting

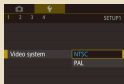

Changing the Video System

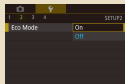

Using Eco Mode





Other Settings



Power-Saving Adjustment



Screen Brightness

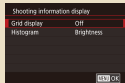

Customizing Shooting Information Display

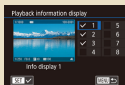

Customizing Playback Information Display

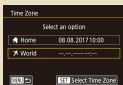

World Clock



Date and Time



Display Language

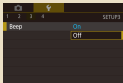

Muting Camera Sounds

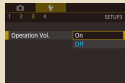

Activating Camera Sounds



Other Settings

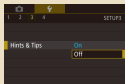

Hiding Hints and Tips



Listing Shooting Modes by Icon

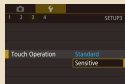

Adjusting the Touch-Screen Panel

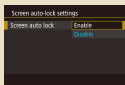

Automatically Locking the Touch-Screen Panel

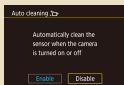

Disabling Auto Sensor Cleaning

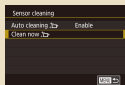

Activating Sensor Cleaning



Cleaning the Sensor Manually

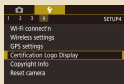

Checking Certification Logos



Setting Copyright Information to Record in Images



Other Settings



Deleting All Copyright
Information

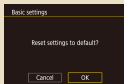

Restoring Main Camera
Default Settings

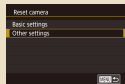

Restoring Defaults for
Individual Camera Functions





Preventing the AF-Assist Beam from Firing



The lamp lights up to help you focus when you press the shutter button halfway in low-light conditions. This lamp can be deactivated.

1

Access the menu screen

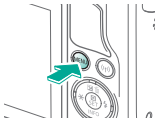

2

Choose the setting item



● [CAMERA] → [AF-assist beam firing] → [SET]

3

Set up the camera

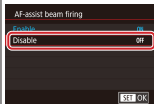

● [Disable] → [SET]



Deactivating the Red-Eye Reduction Lamp



A red-eye reduction lamp lights up to reduce red-eye when the flash is used in low-light shots. This lamp can be deactivated.

1

Access the menu screen

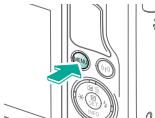

2

Choose the setting item

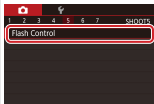

● [CAMERA] → [Flash Control] → [SET] button

3

Set up the camera

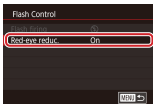

● [Red-eye reduc.] → [SET] button

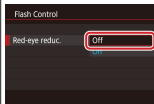

● [Off] → [SET] button



Changing the Image Display Period after Shots



1

Access the menu screen

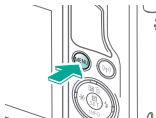

2

Choose the setting item

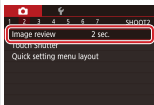

- [CAMERA] → [Image review] → [SET] button

3

Set up the camera

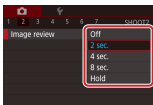

- Choose an option → [SET] button



Date-Based Image Storage



Instead of saving images in folders created each month, you can have the camera create folders each day you shoot to store shots taken that day.

1

Access the menu screen

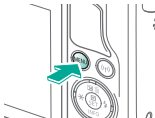

2

Choose the setting item

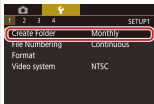

- [F1] → [Create Folder] → [SET] button

3

Set up the camera

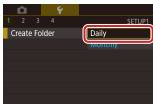

- [Daily] → [SET] button



File Numbering



Your shots are automatically numbered in sequential order (0001 – 9999) and saved in folders that store up to 2,000 images each. You can change how the camera assigns file numbers.

1

Access the menu screen

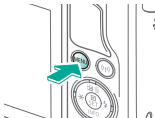

2

Choose the setting item

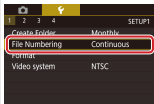

- [MENU] → [File Numbering]
→ [SET] button

3

Set up the camera

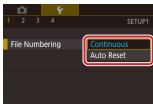

- Choose an option →
[SET] button



Formatting Memory Cards



Before using a new memory card or a card formatted in another device, you should format the card with this camera.

Formatting erases all data on a memory card, which cannot be recovered.

1

Access the menu screen

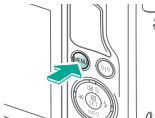

2

Choose the setting item

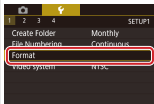

● [MENU] → [Format] →
[SET] button

3

Execute

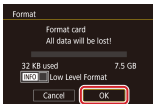

● [OK] → [SET] button

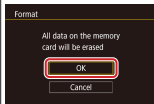

● [OK] → [SET] button →
[OK]



Low-Level Formatting



Perform low-level formatting in the following cases: [Memory card error] is displayed, the camera is not working correctly, card image reading/writing is slower, continuous shooting is slower, or movie recording suddenly stops.
Low-level formatting erases all data on a memory card, which cannot be recovered.

1

Access the menu screen

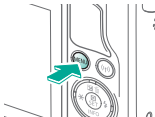

2

Choose the setting item

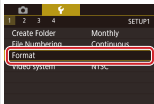

- [MENU] → [Format] → [SET] button

3

Execute

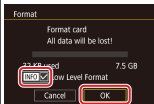

- ▼ button to select (✓) → [OK] → [SET] button







Low-Level Formatting

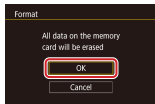

Perform low-level formatting in the following cases: [Memory card error] is displayed, the camera is not working correctly, card image reading/writing is slower, continuous shooting is slower, or movie recording suddenly stops.
Low-level formatting erases all data on a memory card, which cannot be recovered.



- [OK] →  button → [OK]



Changing the Video System



Set the video system of any television used for display. This setting determines the image quality (frame rate) available for movies.

1

Access the menu screen

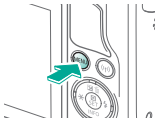

2

Choose the setting item

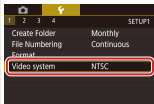

● [Y1] → [Video system] → [SET] button

3

Set up the camera

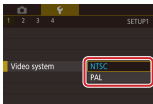

● Choose an option → [SET] button



Using Eco Mode



This function allows you to conserve battery power in Shooting mode. When the camera is not in use, the screen darkens to save battery life.

1

Access the menu screen

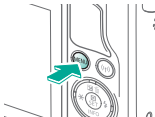

2

Choose the setting item

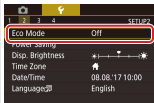

- [MENU] → [Eco Mode]
→ [SET] button

3

Set up the camera

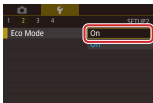

- [On] → [SET] button



Power-Saving Adjustment



Adjust the timing of automatic camera and screen deactivation (Auto Power Down and Display Off, respectively) as needed.

1

Access the menu screen

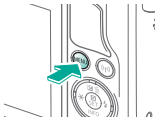

2

Choose the setting item

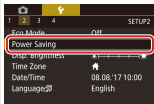

- [F2] → [Power Saving] → [SET] button

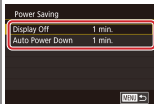

- [Display Off] or [Auto Power Down] → [SET] button







Adjust the timing of automatic camera and screen deactivation (Auto Power Down and Display Off, respectively) as needed.

3

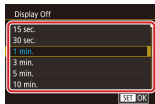
Set up the camera



- Adjust →  button



Screen Brightness



Adjust screen brightness.

1

Access the menu screen

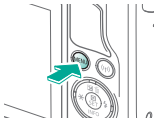

2

Choose the setting item

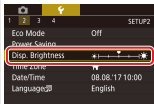

● [Y2] → [Disp. Brightness] → [SET] button

3

Set up the camera







Screen Brightness



Adjust screen brightness.



-  buttons to adjust brightness →  button



Customizing Shooting Information Display



A grid can be shown on the shooting screen. You can also choose the type of histogram shown when the ▼ button is pressed.

1

Access the menu screen

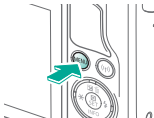

2

Choose the setting item

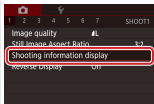

● [CAMERA] → [Shooting information display] → [SET] button

3

Set up the camera

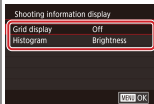





A grid can be shown on the shooting screen. You can also choose the type of histogram shown when the ▼ button is pressed.

4

Set up the camera

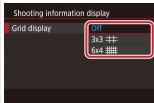
- [Grid display] or [Histogram] →  button



- ▲/▼ buttons to choose an option →  button



Customizing Playback Information Display



The shooting information displayed changes each time you press the ▼ button in Playback mode. You can customize the information displayed.

1

Access the menu screen

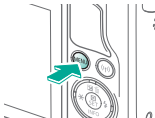

2

Choose the setting item

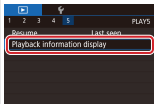

• [▶] 5 → [Playback information display]
→ [SET] button

3

Set up the camera





Customizing Playback Information Display



The shooting information displayed changes each time you press the ▼ button in Playback mode. You can customize the information displayed.



- Choose info to display →  button to select (✓)



World Clock



To ensure that your shots will have the correct local date and time when you travel abroad, simply register the destination in advance and switch to that time zone. This convenient feature eliminates the need to change the Date/Time setting manually.

1

Access the menu screen

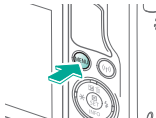

2

Choose the setting item

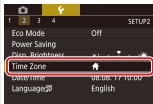

- [MENU] → [Time Zone] → [SET] button

3

Specify your destination

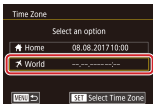

- [World] → [SET] button

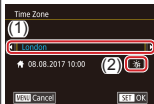



To ensure that your shots will have the correct local date and time when you travel abroad, simply register the destination in advance and switch to that time zone. This convenient feature eliminates the need to change the Date/Time setting manually.

4

Switch to the destination time zone

- Choose a destination

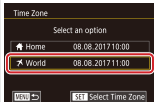

- [World] →
MENU button



Date and Time



Adjust the date and time.

1

Access the menu screen

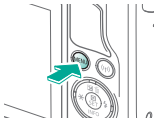

2

Choose the setting item

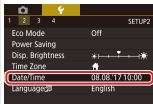

- [F2] → [Date/Time]
→ [SET] button

3

Set up the camera

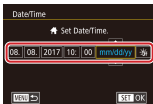

- Navigate and adjust
→ [SET] button



Display Language



Change the display language as needed.

1

Access the menu screen

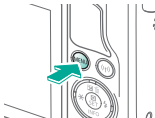

2

Choose the setting item

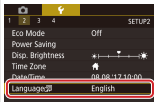

- [CAMERA] → [Language] → [SET] button

3

Set up the camera



- Choose a language → [SET] button



Muting Camera Sounds



Prevent the camera from playing sounds when you press the shutter button halfway or activate the self-timer.

1

Access the menu screen

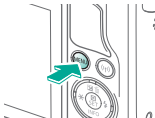

2

Choose the setting item

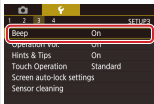

● [3] → [Beep] →
[SET] button

3

Set up the camera

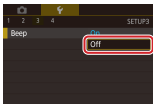

● [Off] → [SET] button



Activating Camera Sounds



Sounds can be played as feedback after camera operations, such as pressing buttons or touching the screen.

1

Access the menu screen

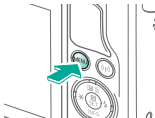

2

Choose the setting item

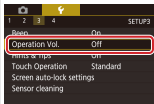

- [Y3] → [Operation Vol.] → [SET] button

3

Set up the camera

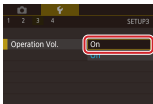

- [On] → [SET] button



Hiding Hints and Tips



Guidance is normally shown when you choose items on Quick Control or shooting screens. If you prefer, you can deactivate this information.

1

Access the menu screen

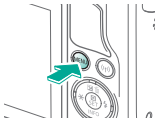

2

Choose the setting item

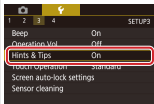

- [Y/3] → [Hints & Tips]
- [SET] button

3

Set up the camera

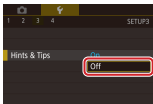

- [Off] → [SET] button



Listing Shooting Modes by Icon



List shooting modes on the selection screen by icon only, without mode names, for faster selection.

1

Set the mode



2

Access the menu screen

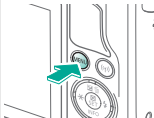

3

Choose the setting item

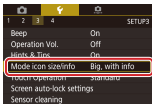

● [Y3] → [Mode icon size/info] → [SET] button







List shooting modes on the selection screen by icon only, without mode names, for faster selection.

4

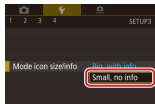
Set up the camera



- [Small, no info] →
 button



Adjusting the Touch-Screen Panel



Sensitivity of the touch-screen panel can be increased, so that the camera responds to a lighter touch.

1

Access the menu screen

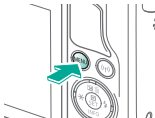

2

Choose the setting item

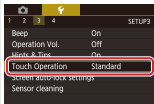

● [Y3] → [Touch Operation] → [SET]

3

Set up the camera

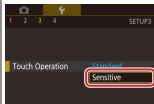

● [Sensitive] → [SET]



Automatically Locking the Touch-Screen Panel



To prevent unintended operations, you can set up automatic locking of the touch-screen panel.

1

Access the menu screen

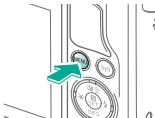

2

Choose the setting item

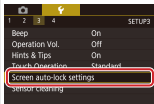

● [Y3] → [Screen auto-lock settings] → [SET] button

3

Set up the camera

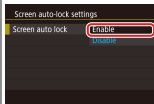



Automatically Locking the Touch-Screen Panel



To prevent unintended operations, you can set up automatic locking of the touch-screen panel.



- [Screen auto lock]
→ [Enable] →  button

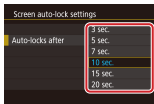

- [Auto-locks after] →
choose an option →
 button



Disabling Auto Sensor Cleaning



The image sensor is automatically cleaned to remove dust whenever you turn the camera on or off, or when the camera shuts off in Power Saving mode. You can disable automatic cleaning.

1

Access the menu screen

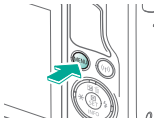

2

Choose the setting item

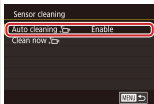

- [MENU] → [Sensor cleaning] → [SET] button
→ [Auto cleaning] → [SET] button

3

Set up the camera

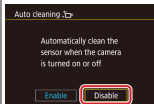

- [Disable] → [SET] button



Activating Sensor Cleaning



The image sensor is automatically cleaned to remove dust whenever you turn the camera on or off, or when the camera shuts off in Power Saving mode. You can activate cleaning as needed.

1

Access the menu screen

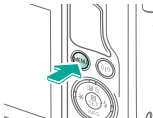

2

Choose the setting item

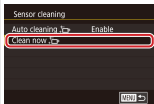

- [Y/3] → [Sensor cleaning] → [SET] button → [Clean now] → [Clean now] → [SET] button

3

Execute

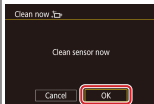

- [OK] → [SET] button



Cleaning the Sensor Manually



Any dust that remains after automatic cleaning can also be removed by using an optional blower or other specialized tool.

The surface of the image sensor is extremely delicate. If the sensor must be cleaned manually, we recommend requesting service from a Customer Support Help Desk.

1

Make sure the camera is off



2

Detach the lens

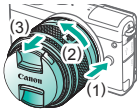

3

Clean the sensor





Checking Certification Logos



Some logos for certification requirements met by the camera can be viewed on the screen. Other certification logos appear in this manual, on the camera packaging, or on the camera body.

1

Access the menu screen

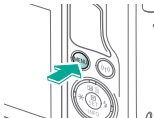

2

Choose the setting item

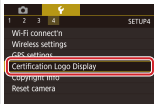

● [4] → [Certification Logo Display] → [SET] button



Setting Copyright Information to Record in Images



To record the author's name and copyright details in images, set this information beforehand.

1

Access the menu screen

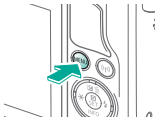

2

Choose the setting item

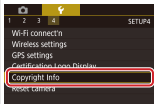

- [F4] → [Copyright Info] → [SET] button

3

Register



- [Enter Author's Name] or [Enter Copyright Details] → [SET] button → enter a name → **MENU** button





Setting Copyright Information to Record in Images



To record the author's name and copyright details in images, set this information beforehand.



● [Yes] →  button



Deleting All Copyright Information



You can delete both the author's name and copyright details at the same time.

1

Access the menu screen

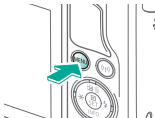

2

Choose the setting item

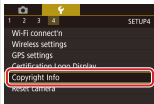

- [MENU] → [Copyright Info] → [SET] button

3

Delete



- [Delete Copyright Info] → [SET] button

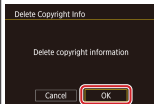

- [OK] → [SET] button



Restoring Main Camera Default Settings



If you accidentally change a setting, you can restore default camera settings.

1

Access the menu screen

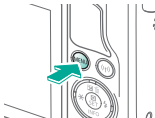

2

Choose the setting item

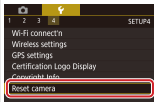

● [MENU] → [Reset camera] → [SET] button

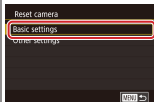

● [Basic settings] → [SET] button

3

Execute

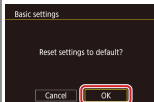

● [OK] → [SET] button



Restoring Defaults for Individual Camera Functions



1

Access the menu screen

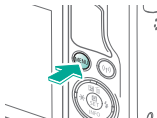

2

Choose the setting item

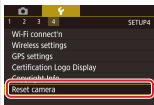

- [F4] → [Reset camera] → [SET] button

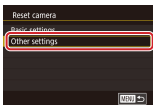

- [Other settings] → [SET] button

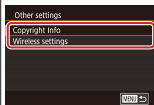

- Choose the function to reset → [SET] button





Restoring Defaults for Individual Camera Functions



3

Execute



- [OK] →  button





1-point (AF frame mode) 152

A

AE lock 124

AF frames 152

AF-point zoom 145

Art bold effect (shooting mode) 105

Aspect ratio 230

Auto Lighting Optimizer 128

Auto mode (shooting mode) 40, 80, 81

Av (shooting mode) 179

B

Battery pack

Charging 22

Eco mode 325

Black and white images 99

Bulb exposure 183

C

Camera

Resetting 353, 354

Camera Connect 296, 299, 302

CANON IMAGE GATEWAY 305, 310

Charging 22

Chromatic aberration correction 172

Cleaning (image sensor) 346, 347, 348

Close-up (shooting mode) 91

Color temperature 136, 138



- Color (white balance) 132
- Compression 227
- Creative Assist (shooting mode) 193
- Creative filters 274
- Cropping 271
- Custom WB 133
- Custom white balance 133

D

Date/time

- Changing 336
- Settings 27
- World clock 334

Display language 28

Display period 318

DLNA 294

E

Eco mode 325

Editing

- Cropping 271
- Red-eye correction 276
- Resizing images 269

Erasing 258, 259, 261, 264

Erasing all 264

Exposure

- AE lock 124
- Compensation 122
- FE lock 161



F

Face+Tracking 152

Favorites 256

FE lock 161

File numbering 320

Fish-eye effect (shooting mode) 103

Flash

FE lock 161

Flash exposure compensation 160

Flash metering 164

Flash output 165

Flash timing 163

Mode 159

Resetting 168

Flash exposure compensation 160

Focusing

AF frames 152

MF peaking 150

Servo AF 153

Touch AF 156

Focus range

Manual focus 145

Food (shooting mode) 93

G

Grainy B/W (shooting mode) 99



H

- Handheld night scene (shooting mode) 95
- High dynamic range (shooting mode) 114
- High ISO speed noise reduction 173
- Hybrid Auto (shooting mode) 83

I

- Image dust prevention 347, 348
- Images
 - Display period 318
 - Erasing 258, 259, 261, 264
 - Protecting 248, 249, 251, 254
- Image stabilization 170
- Index display 242
- Indicator 68, 316, 317
- ISO speed 126

J

- Jump display 245

L

- Landscape (shooting mode) 90

Lens

- Attaching 29
- Detaching 31
- Lock release 31
- Long exposure 183
- Long exposure noise reduction 175

M

- Macro photography 91
- Magnified display 234
- Manual focus 145
- Memory cards 24



Menu

Basic operations 64

Touch operations 72

Metering method 125

MF (Manual focusing) 145

MF peaking 150

Miniature effect (shooting mode) 111

Movies

Editing 285, 288, 290

Image quality (recording pixels/frame rate) 231

M (shooting mode) 181

Multi Shot Noise Reduction 174

N

Noise reduction

High ISO speed 173, 174

Long exposure 175

P

Part names 48

Peripheral illumination correction 172

Picture Style 139, 140, 141



Playback

- Digest movies 239
 - Image search 243
 - Index display 242
 - Jump display 245
 - Magnified display 234
 - Movies 237
 - Slideshow 236
 - Stills 233
 - Touch operations 74
- Portrait (shooting mode) 88
- Protecting 248, 249, 251, 254
- P (shooting mode) 7

Q

- Quick Control screen
- Basic operations 62
 - Touch operations 70

R

- Rating 256
- RAW 228
- RAW image processing 280, 282
- Recording pixels (image size) 227
- Red-eye correction 276
- Resetting 353, 354
- Resizing images 269
- Rotating 267



S

Saturation 140

Screen

 Display language 28

Searching 243

Self portrait (shooting mode) 86

Self-timer

 Customizing the self-timer 222

 Using the self-timer 220

Sending images 311

Sending images to a smartphone 296, 299,
302

Sending images to Web services 311

Sensor cleaning 346, 347

Servo AF 153

Slideshow 236

Smooth zone AF 152

Soft focus (shooting mode) 101

Sounds 338

Sports (shooting mode) 92

Strap 21

T

Time-lapse movie (shooting mode) 209

Tone priority 129

Touch AF 156

Touch Shutter 224

Traveling with the camera 334

Tv (shooting mode) 177



W

Water painting effect (shooting mode) 107

White balance (color) 132

Wind filter 214

Wireless features 294

World clock 334

Z

Zoom 40, 42



Precautions for Wireless Features (Wi-Fi, Bluetooth, or Others)



- Countries and Regions Permitting Wireless Function Use
 - Use of wireless functions is restricted in some countries and regions, and illegal use may be punishable under national or local regulations.
To avoid violating wireless regulations, visit the Canon website to check where use is allowed.
Note that Canon cannot be held liable for any problems arising from wireless function use in other countries and regions.
- Doing any of the following may incur legal penalties:
 - Altering or modifying the product
 - Removing the certification labels from the product
- Before goods or technologies in the camera regulated by the Foreign Exchange and Foreign Trade Act are exported (which includes bringing them outside Japan or showing them to non-residents in Japan), export or service transaction permission may be required from the Japanese government.
- Because this product includes American encryption items, it falls under U.S. Export Administration Regulations, and cannot be exported to or brought into a country under U.S. trade embargo.
- Be sure to make notes of the Wi-Fi settings you use.
- The wireless settings saved to this product may change or be erased due to incorrect operation of the product, the effects of radio waves or static electricity, or accident or malfunction.





Precautions for Wireless Features (Wi-Fi, Bluetooth, or Others)



- Please note that Canon accepts no responsibility for direct or indirect damages or loss of earnings resulting from a degradation or disappearance of content.
- When transferring ownership, disposing of the product, or sending it for repair, restore the default wireless settings by erasing any settings you have entered.
- Canon will not make compensation for damages resulting from loss or theft of the product.
- Canon accepts no responsibility for damages or loss resulting from unauthorized access or use of target devices registered on this product due to loss or theft of the product.
- Be sure to use the product as directed in this manual.
Be sure to use the wireless function of this product within the guidelines noted in this manual. Canon accepts no responsibility for damages or loss if the function and product are used in ways other than as described in this manual.
- Do not use the wireless function of this product near medical equipment or other electronic equipment.
Use of the wireless function near medical equipment or other electronic equipment may affect operation of those devices.





Radio Wave Interference Precautions



- This product may receive interference from other devices that emit radio waves. To avoid interference, be sure to use this product as far away as possible from such devices, or avoid using the devices at the same time as this product.



Trademarks and Licensing



- Microsoft and Windows are trademarks or registered trademarks of Microsoft Corporation in the United States and/or other countries.
- Macintosh and Mac OS are trademarks of Apple Inc., registered in the U.S. and other countries.
- App Store, iPhone, and iPad are trademarks of Apple Inc.
- The SDXC logo is a trademark of SD-3C, LLC.
- HDMI, the HDMI logo and High-Definition Multimedia Interface are trademarks or registered trademarks of HDMI Licensing, LLC.
- Wi-Fi[®], Wi-Fi Alliance[®], WPA[™], WPA2[™] and Wi-Fi Protected Setup[™] are trademarks or registered trademarks of the Wi-Fi Alliance.
- The Bluetooth[®] word mark and logos are registered trademarks owned by Bluetooth SIG, Inc. and any use of such marks by Canon Inc. is under license. Other trademarks and trade names are those of their respective owners.
- The N-Mark is a trademark or registered trademark of NFC Forum, Inc. in the United States and in other countries.
- All other trademarks are the property of their respective owners.
- This device incorporates exFAT technology licensed from Microsoft.





- This product is licensed under AT&T patents for the MPEG-4 standard and may be used for encoding MPEG-4 compliant video and/or decoding MPEG-4 compliant video that was encoded only (1) for a personal and non-commercial purpose or (2) by a video provider licensed under the AT&T patents to provide MPEG-4 compliant video. No license is granted or implied for any other use for MPEG-4 standard.





Disclaimer



- Unauthorized reproduction of this manual is prohibited.
- All measurements based on Canon testing standards.
- Information subject to change without notice, as are product specifications and appearance.
- Illustrations and screenshots in this manual may differ slightly from the actual equipment.
- The above items notwithstanding, Canon cannot be held liable for any loss arising from the use of this product.

Canon