

# Canon

# EOS 7D Mark II

## EOS 7D Mark II (G)



- This manual is for the EOS 7D Mark II installed with firmware version 1.1.0 or later.
- Instruction manuals (PDF files) can be downloaded from the Canon website (p.4).

[www.canon.com/icpd](http://www.canon.com/icpd)

**ENGLISH**

**INSTRUCTION  
MANUAL**

# Introduction

The EOS 7D Mark II (G) is a digital single-lens reflex camera featuring a fine-detail CMOS sensor with approx. 20.2 effective megapixels, Dual DIGIC 6, approx. 100% viewfinder coverage, high-precision and high-speed 65-point AF (Cross-type AF point: Max. 65 points), approx. 10.0 fps continuous shooting, Live View shooting, Full High-Definition (Full HD) movie shooting, Dual Pixel CMOS AF, and GPS function.

## **Before Starting to Shoot, Be Sure to Read the Following**

To avoid botched pictures and accidents, first read the “Safety Precautions” (p.525-527) and “Handling Precautions” (p.20-21). Also, read this manual carefully to ensure that you use the camera correctly.

## **Refer to This Manual While Using the Camera to Further Familiarize Yourself with the Camera**

While reading this manual, take a few test shots and see how they come out. You can then better understand the camera. Be sure to store this manual safely, too, so that you can refer to it again when necessary.

## **Testing the Camera Before Use and Liability**

After shooting, play images back and check whether they have been properly recorded. If the camera or memory card is faulty and the images cannot be recorded or downloaded to a computer, Canon cannot be held liable for any loss or inconvenience caused.

## **Copyrights**

Copyright laws in your country may prohibit the use of your recorded images of people and certain subjects for anything but private enjoyment. Also be aware that certain public performances, exhibitions, etc., may prohibit photography even for private enjoyment.

# Item Check List

Before starting, check that all the following items are included with your camera. If anything is missing, contact your dealer.

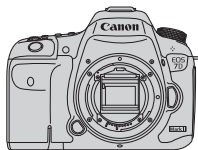

**Camera**  
(with body cap)



**Eyecup Eg**  
(p.247)



**Battery Pack  
LP-E6N**  
(p.38)  
(with protective cover)



**Battery Charger  
LC-E6/LC-E6E\***  
(p.32)

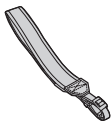

**Wide Strap**  
(p.33)

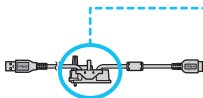

**Interface Cable  
IFC-150U II**



**Cable protector**  
(p.34)



**Wi-Fi Adapter W-E1**  
(p.36)



**EOS Solution Disk**  
(Software)

\* Battery Charger LC-E6 or LC-E6E is provided. (The LC-E6E comes with a power cord.)

- The Instruction Manuals provided are listed on the next page.
- If you purchased a Lens Kit, check that the lenses are included.
- Be careful not to lose any of the above items.



When you need Lens Instruction Manuals, download them from the Canon website (p.4). The Lens Instruction Manuals (PDF) are for lenses sold individually. Note that when purchasing the Lens Kit, some of the accessories included with the lens may not match those listed in the Lens Instruction Manual.

# Instruction Manuals



**Basic Instruction Manual\***



**Wi-Fi Adapter W-E1 Preliminary Notes and Legal Information\***

\* Detailed Instruction Manuals (PDF files) can be downloaded from the Canon website (see below).

## Downloading and Viewing the Instruction Manuals (PDF Files)

### 1 Download the Instruction Manuals (PDF files).

- Connect to the Internet and access the following Canon website.

**[www.canon.com/icpd](http://www.canon.com/icpd)**

- Select your country or region of residence and download the Instruction Manuals.

#### **Instruction Manuals Available for Download**

- **Camera Instruction Manual**
- **Camera Basic Instruction Manual**
- **Wi-Fi Adapter W-E1 Instruction Manual**
- **Lens Instruction Manuals**
- **Software Instruction Manuals**

### 2 View the Instruction Manuals (PDF files).

- Double-click a downloaded Instruction Manual (PDF file) to open it.
- To view the Instruction Manuals (PDF files), Adobe Acrobat Reader DC or other Adobe PDF viewer (most recent version recommended) is required.
- Adobe Acrobat Reader DC can be downloaded free from the Internet.
- To learn how to use a PDF viewer, refer to its Help section.



## Compatible Cards

The camera can use the following cards regardless of capacity: **If the card is new or was previously formatted by another camera or computer, format the card with this camera (p.67).**

- **CF (CompactFlash) cards**
  - \* Type I, UDMA mode 7-compatible.
- **SD/SDHC\*/SDXC\* memory cards**
  - \* UHS-I cards supported.

### Cards that Can Record Movies

When shooting movies, use a large-capacity card with a fast reading/writing speed as shown in the table.

Movie Recording Size (p.330)	CF Card: Recording Formats	
	MOV	MP4
ALL-I (For editing)	30 MB/sec. or faster	
IPB (Standard)	FHD : 59.94P 50.00P	30 MB/sec. or faster
	Other than above	10 MB/sec. or faster
IPB (Light)	-	10 MB/sec. or faster

Movie Recording Size (p.330)	SD Card: Recording Formats	
	MOV	MP4
ALL-I (For editing)	20 MB/sec. or faster	
IPB (Standard)	FHD : 59.94P 50.00P	20 MB/sec. or faster
	Other than above	6 MB/sec. or faster
IPB (Light)	-	4 MB/sec. or faster

- If you use a slow-writing card when shooting movies, the movie may not be recorded properly. Also, if you play back a movie on a card with a slow reading speed, the movie may not play back properly.
- If you want to shoot still photos while shooting a movie, you will need an even faster card.
- To check the card's reading/writing speed, refer to the card manufacturer's website.



In this manual, "CF card" refers to CompactFlash cards and "SD card" refers to SD/SDHC/SDXC cards. "Card" refers to all memory cards used to record images or movies.

\* **The camera does not come with a card for recording images/movies.** Please purchase it separately.

# Quick Start Guide

1

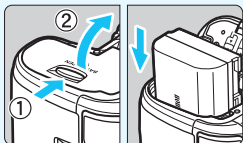

**Insert the battery** (p.40).

- To charge the battery, see page 38.

2

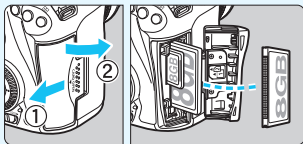

**Insert the card** (p.41).

- The camera-front side slot is for a CF card, and the camera-back side slot is for an SD card.

\* Shooting is possible with either a CF card or an SD card in the camera.

3

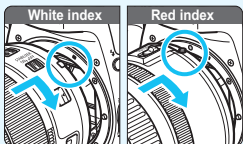

**Attach the lens** (p.50).

- Align the lens's white or red mount index with the camera's index of the same color.

4

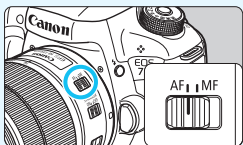

**Set the lens's focus mode switch to <AF>** (p.50).

5

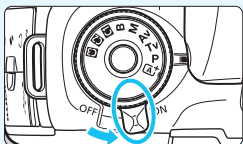

**Set the power switch to <ON>** (p.45).

6

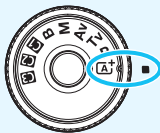

**While holding down the center of the Mode Dial, set it to <AI+> (Scene Intelligent Auto) (p.29).**

- All the necessary camera settings will be set automatically.

7

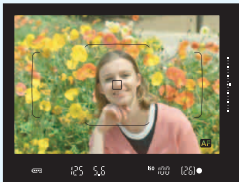

**Focus on the subject (p.55).**

- Look through the viewfinder and aim the viewfinder center over the subject.
- Press the shutter button halfway, and the camera will focus on the subject.
- If necessary, the built-in flash will be raised.

8



**Take the picture (p.55).**

- Press the shutter button completely to take the picture.

9







**Review the picture.**

- The image just captured will be displayed for 2 sec. on the LCD monitor.
- To display the image again, press the <▶> button (p.354).





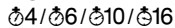

- To shoot while looking at the LCD monitor, see “Live View Shooting” (p.285).
- To view the images captured so far, see “Image Playback” (p.354).
- To delete an image, see “Erasing Images” (p.392).

# Conventions Used in this Manual

## Icons in this Manual

-  : Indicates the Main Dial.
-  : Indicates the Quick Control Dial.
-  : Indicates the AF area selection lever.
-  : Indicates the Multi-controller.
-  : Indicates the Setting button.
-  : Indicates that the corresponding function remains active for 4 sec., 6 sec., 10 sec., or 16 sec. respectively after you let go of the button.

\* In this manual, the icons and markings indicating the camera's buttons, dials, and settings correspond to the icons and markings on the camera and on the LCD monitor.

-  : Indicates a function that can be changed by pressing the <MENU> button to change its settings.
-  : This icon at the upper right of the page titles indicates that the function is available only in the <P>, <Tv>, <Av>, <M>, or <B> mode.
- (p.\*\*)
-  : Warning to prevent shooting problems.
-  : Supplemental information.
-  : Tips or advice for better shooting.
-  : Troubleshooting advice.

## Basic Assumptions

- All operations explained in this manual assume that the power switch is set to <ON> and the <LOCK▶> switch is set to the left (Multi function lock released) (p.45, 59).
- It is assumed that all the menu settings, Custom Functions, etc. are set to their defaults.
- The illustrations in this manual show the camera attached with the EF-S18-135mm f/3.5-5.6 IS USM lens as an example.

# Chapters

For first-time DSLR users, Chapters 1 and 2 explain the camera's basic operations and shooting procedures.



	<b>Introduction</b>	<b>2</b>
<b>1</b>	<b>Getting Started</b>	<b>37</b>
<b>2</b>	<b>Basic Shooting</b>	<b>79</b>
<b>3</b>	<b>Setting the AF and Drive Modes</b>	<b>85</b>
<b>4</b>	<b>Image Settings</b>	<b>145</b>
<b>5</b>	<b>GPS Settings</b>	<b>197</b>
<b>6</b>	<b>Advanced Operations</b>	<b>215</b>
<b>7</b>	<b>Flash Photography</b>	<b>253</b>
<b>8</b>	<b>Shooting with the LCD Monitor (Live View Shooting)</b>	<b>285</b>
<b>9</b>	<b>Shooting Movies</b>	<b>313</b>
<b>10</b>	<b>Image Playback</b>	<b>353</b>
<b>11</b>	<b>Post-Processing Images</b>	<b>397</b>
<b>12</b>	<b>Sensor Cleaning</b>	<b>405</b>
<b>13</b>	<b>Printing Images and Transferring Images to a Computer</b>	<b>411</b>
<b>14</b>	<b>Customizing the Camera</b>	<b>431</b>
<b>15</b>	<b>Reference</b>	<b>467</b>
<b>16</b>	<b>Downloading Images to a Computer / Software</b>	<b>531</b>

# Contents



<b>Introduction</b>	<b>2</b>
Item Check List.....	3
Instruction Manuals .....	4
Compatible Cards.....	5
Quick Start Guide .....	6
Conventions Used in this Manual.....	8
Chapters.....	9
Index to Features .....	17
Handling Precautions .....	20
Nomenclature .....	22

## **1 Getting Started** **37**



Charging the Battery .....	38
Installing and Removing the Battery.....	40
Installing and Removing the Card .....	41
Turning on the Power .....	45
Setting the Date, Time, and Zone .....	47
Selecting the Interface Language.....	49
Attaching and Detaching a Lens .....	50
Lens Image Stabilizer.....	53
Basic Operation.....	54
<b>Q</b> Quick Control for Shooting Functions .....	61
<b>MENU</b> Menu Operations.....	64
Before You Start.....	67
Formatting the Card.....	67
Disabling the Beeper .....	69
Setting the Power-off Time/Auto Power Off.....	69
Setting the Image Review Time.....	70
Reverting the Camera to the Default Settings .....	70

 Displaying the Grid.....	74
 Displaying the Electronic Level .....	75
Setting the Viewfinder Information Display .....	77
 Help .....	78



## 2 Basic Shooting 79



 Fully Automatic Shooting (Scene Intelligent Auto) .....	80
 Full Auto Techniques (Scene Intelligent Auto) .....	83

## 3 Setting the AF and Drive Modes 85

AF: Selecting the AF Operation .....	86
 Selecting the AF Area and AF Point .....	90
AF Area Selection Modes .....	95
AF Sensor .....	99
Lenses and Usable AF Points.....	100
Selecting AI Servo AF Characteristics .....	108
Customizing AF Functions .....	117
Fine Adjustment of AF's Point of Focus.....	133
When Autofocus Fails .....	139
MF: Manual Focus .....	140
 Selecting the Drive Mode.....	141
 Using the Self-timer .....	143

## 4 Image Settings 145

Selecting the Card for Recording and Playback .....	146
Setting the Image-Recording Quality .....	149
ISO: Setting the ISO Speed .....	154
 Selecting a Picture Style.....	160
 Customizing a Picture Style.....	163
 Registering a Picture Style .....	166

<b>WB</b> : Setting the White Balance .....	168
 Custom White Balance .....	169
 Setting the Color Temperature .....	171
 White Balance Correction .....	172
Auto Correction of Brightness and Contrast .....	175
Setting Noise Reduction .....	176
Highlight Tone Priority .....	180
Correction of Lens Peripheral Illumination and Aberrations .....	181
Reducing Flicker .....	185
Setting the Color Space .....	187
Creating and Selecting a Folder .....	188
Changing the File Name .....	190
File Numbering Methods .....	193
Setting Copyright Information .....	195









## 5 GPS Settings 197

GPS Features .....	198
GPS Precautions .....	200
Acquiring GPS Signals .....	201
Setting the Positioning Interval .....	205
Using the Digital Compass .....	206
Setting Time from GPS on the Camera .....	209
Logging the Route Traveled .....	210



## 6 Advanced Operations 215

<b>P</b> : Program AE .....	216
<b>Tv</b> : Shutter-Priority AE .....	218
<b>Av</b> : Aperture-Priority AE .....	220
Depth-of-Field Preview .....	221
<b>M</b> : Manual Exposure .....	222



 Selecting the Metering Mode .....	224
 Setting Exposure Compensation .....	226
 Auto Exposure Bracketing (AEB) .....	227
 AE Lock .....	229
<b>B</b> : Bulb Exposures .....	230
<b>HDR</b> : HDR (High Dynamic Range) Shooting .....	233
 Multiple Exposures .....	238
 Mirror Lockup .....	246
Using the Eyepiece Cover .....	247
 Using a Remote Switch .....	248
 Remote Control Shooting .....	248
 Interval Timer Shooting .....	250

## **7 Flash Photography 253**

 Using the Built-in Flash .....	254
 Using an External Speedlite .....	259
Setting the Flash .....	262
Using Wireless Flash .....	272

## **8 Shooting with the LCD Monitor (Live View Shooting) 285**















 Shooting with the LCD Monitor .....	286
Shooting Function Settings .....	292
Menu Function Settings .....	294
Using AF to Focus (AF Method) .....	299
MF: Focusing Manually .....	308

## **9 Shooting Movies 313**

 Shooting Movies .....	314
Autoexposure Shooting .....	314
Shutter-priority AE .....	315

Aperture-priority AE .....	316
Manual Exposure Shooting.....	320
Shooting Still Photos.....	327
Shooting Function Settings .....	329
Setting the Movie Recording Size .....	330
Setting the Sound Recording .....	336
Silent Control.....	338
Setting the Time Code.....	339
Menu Function Settings.....	342

## 10 Image Playback **353**

 Image Playback .....	354
<b>INFO.</b> : Shooting Information Display .....	356
 Searching for Images Quickly .....	361
 Display Multiple Images on One Screen (Index Display).....	361
 Jump through Images (Jump Display).....	362
 Magnifying Images.....	364
 Comparing Images (Two-Image Display).....	366
 Rotating the Image.....	367
 Protecting Images.....	368
Setting Ratings .....	371
 Quick Control for Playback .....	374
 Enjoying Movies .....	376
 Playing Movies .....	378
 Editing a Movie's First and Last Scenes .....	380
Slide Show (Auto Playback) .....	382
Viewing Images on a TV Set.....	385
 Copying Images .....	388
 Erasing Images.....	392

Changing Image Playback Settings .....	394
Adjusting the LCD Monitor Brightness .....	394
Auto Rotation of Vertical Images .....	395
<b>11 Post-Processing Images</b> .....	<b>397</b>
RAW/JPEG <sup>↓</sup> Processing RAW Images with the Camera .....	398
☑ Resizing JPEG Images .....	403
<b>12 Sensor Cleaning</b> .....	<b>405</b>
🗑️ Automatic Sensor Cleaning .....	406
Appending Dust Delete Data .....	407
Manual Sensor Cleaning .....	409
<b>13 Printing Images and Transferring Images to a Computer</b> .....	<b>411</b>
Preparing to Print .....	412
🖨️ Printing .....	414
🖨️ Digital Print Order Format (DPOF) .....	421
🖨️ Direct Printing of Print-Ordered Images .....	424
📁 Transferring Images to a Computer .....	425
📖 Specifying Images for a Photobook .....	429
<b>14 Customizing the Camera</b> .....	<b>431</b>
Custom Functions .....	432
Setting Custom Functions .....	434
C.Fn1: Exposure .....	434
C.Fn2: Exposure/Drive .....	438
C.Fn3: Display/Operation .....	440
C.Fn4: Others .....	443
🔧 C: Custom Controls .....	445
Registering My Menu .....	459
📷: Registering Custom Shooting Modes .....	464

<b>15</b>	<b>Reference</b>	<b>467</b>
	INFO. Button Functions .....	468
	Checking the Battery Information .....	470
	Using a Household Power Outlet .....	474
	📶 Using Eye-Fi Cards.....	475
	System Map .....	478
	Function Availability Table According to Shooting Mode .....	480
	Menu Settings .....	484
	Troubleshooting Guide .....	495
	Error Codes .....	510
	Specifications .....	511
	Safety Precautions .....	525
<b>16</b>	<b>Downloading Images to a Computer / Software</b>	<b>531</b>
	Downloading Images to a Computer .....	532
	About the Software .....	534
	Installing the Software .....	536
	Index.....	538

# Index to Features

## Power

- Charging the battery → p.38
- Battery check → p.46
- Battery information check → p.470
- Household power outlet → p.474
- Auto power off → p.69

## Card

- Formatting → p.67
- Recording function → p.146
- Select card → p.148
- Release shutter without card → p.42

## Lens

- Attaching → p.50
- Zoom → p.51
- Hood → p.52
- Image Stabilizer → p.53

## Basic Settings

- Language → p.49
- Date/Time/Zone → p.47
- Beeper → p.69
- Copyright information → p.195
- Clear all camera settings → p.70

## Viewfinder

- Dioptic adjustment → p.54
- Eyepiece cover → p.247
- Grid display → p.74
- Electronic level → p.76
- Show/hide in viewfinder → p.77

## LCD Monitor

- Brightness adjustment → p.394
- Electronic level → p.75
- Help → p.78

## AF

- AF operation → p.86
- AF area selection mode → p.90
- AF point selection → p.93
- AF point registration → p.450
- Lens group → p.100
- AF points lighting up in red → p.131
- AI Servo AF characteristics → p.108
- AF Custom Functions → p.117
- AF Microadjustment → p.133
- Focusing manually → p.140

## Metering

- Metering mode → p.224

## Drive

- Drive mode → p.141
- Self-timer → p.143
- Maximum burst → p.153

## Recording Images

- Recording function → p.146
- Creating/Selecting a folder → p.188
- File name → p.190
- File numbering → p.193

**Image Quality**

- Image-recording quality → p.149
- ISO speed → p.154
- Picture Style → p.160
- White balance → p.168
- Auto Lighting Optimizer → p.175
- Noise reduction for high ISO speeds → p.176
- Noise reduction for long exposures → p.178
- Highlight tone priority → p.180
- Lens aberration correction → p.181
- Anti-flicker → p.185
- Color space → p.187

**Shooting**

- Shooting mode → p.29
- HDR → p.233
- Multiple exposures → p.238
- Mirror lockup → p.246
- Bulb timer → p.231
- Interval timer → p.250
- Depth-of-field preview → p.221
- Remote control → p.248
- Quick Control → p.61

**Exposure**

- Exposure compensation → p.226
- Exposure compensation with M+Auto ISO → p.223
- AEB → p.227
- AE lock → p.229
- Safety shift → p.436

**GPS**

- GPS → p.197
- Digital compass → p.206
- Logging → p.210

**Flash**

- Built-in flash → p.254
- External Speedlite → p.259
- Flash exposure compensation → p.257
- FE lock → p.258
- Flash function settings → p.262
- Wireless shooting → p.272
- External Speedlite Custom Functions → p.271

**Live View Shooting**

- Live View shooting → p.285
- AF method → p.299
- Continuous AF → p.294
- Focusing manually → p.308
- Aspect ratio → p.295
- Silent LV shooting → p.297

## Movie Shooting

- Movie shooting → p.313
- AF method → p.299
- Movie Servo AF → p.342
- Movie Servo AF speed → p.345
- Movie Servo AF tracking sensitivity → p.346
- Movie recording quality → p.330
- Sound recording → p.336
- Time code → p.339
- HDMI output → p.348
- Still photo shooting → p.327

## Playback

- Image review time → p.70
- Single-image display → p.354
- Shooting information → p.356
- Index display → p.361
- Image browsing (Jump display) → p.362
- Magnified view → p.364
- Two-image display → p.366
- Image rotation → p.367
- Protect → p.368
- Rating → p.371
- Movie playback → p.378
- Slide show → p.382
- Viewing images on a TV set → p.385
- Copying → p.388
- Erase → p.392
- Quick Control → p.374

## Image Editing

- RAW image processing → p.398
- Resizing JPEG → p.403

## Printing and Transferring Images

- PictBridge → p.411
- Print Order (DPOF) → p.421
- Image transfer → p.425
- Photobook Set-up → p.429

## Customization

- Custom Functions (C.Fn) → p.432
- Custom Controls → p.445
- My Menu → p.459
- Custom shooting mode → p.464

## Sensor Cleaning and Dust Reduction

- Sensor cleaning → p.406
- Append Dust Delete Data → p.407

## Interface

- Cable protector → p.34

## Software

- Overview → p.534
- Installation → p.536

## Wireless Function

- W-E1 Instruction Manual

# Handling Precautions

Also read “Handling Precautions” on page 529.

## Camera Care

- This camera is a precision instrument. Do not drop it or subject it to physical shock.
- The camera is not waterproof and cannot be used underwater.
- To maximize the camera's dust- and drip- resistance, keep the terminal cover, battery compartment cover, card slot cover, and all other covers firmly closed.
- This camera is designed to be dust- and drip- resistant, in order to help prevent sand, dust, dirt, or water that falls on it unexpectedly from getting inside, but it is impossible to prevent dirt, dust, water, or salt from getting inside at all. As far as possible, do not allow dirt, dust, water, and salt to get on the camera.
- If water gets on the camera, wipe it off with a dry and clean cloth. If dirt, dust, or salt gets on the camera, wipe it off with a clean, well-wrung wet cloth.
- Using the camera in a location with large amounts of dirt or dust may cause a malfunction.
- Cleaning the camera after use is recommended. Allowing dirt, dust, water, or salt to remain on the camera may cause a malfunction.
- If you accidentally drop the camera into water or are concerned that moisture (water), dirt, dust, or salt may have gotten inside it, promptly consult the nearest Canon Service Center.
- Never leave the camera near anything having a strong magnetic field such as a magnet or electric motor. Also avoid using or leaving the camera near anything emitting strong radio waves, such as a large antenna. Strong magnetic fields can cause camera misoperation or destroy image data.
- Do not leave the camera in excessive heat, such as in a car in direct sunlight. High temperatures can cause the camera to malfunction.
- The camera contains precision electronic circuitry. Never attempt to disassemble the camera yourself.



- Do not block the mirror operation with your finger, etc. Doing so may cause a malfunction.
- Use a blower to blow away dust on the lens, viewfinder, reflex mirror, and focusing screen. Do not use cleaners that contain organic solvents to clean the camera body or lens. For stubborn dirt, take the camera to the nearest Canon Service Center.
- Do not remove the focusing screen unless you are changing it. When changing the focusing screen, do not touch it with bare hands. Instead use the dedicated tool that came with the interchangeable focusing screen (sold separately).
- Do not touch the camera's electrical contacts with your fingers. This is to prevent the contacts from corroding. Corroded contacts can cause camera misoperation.
- If the camera is suddenly brought in from the cold into a warm room, condensation may form on the camera and internal parts. To prevent condensation, first put the camera in a sealed plastic bag and let it adjust to the warmer temperature before taking it out of the bag.
- If condensation forms on the camera, do not use the camera. This is to avoid damaging the camera. If there is condensation, remove the lens, card and battery from the camera, and wait until condensation has evaporated before using the camera.
- If the camera will not be used for an extended period, remove the battery and store the camera in a cool, dry, well-ventilated location. Even while the camera is in storage, press the shutter button a few times once in a while to check that the camera is still working.
- Avoid storing the camera where there are chemicals that result in rust and corrosion such as in a chemical lab.
- If the camera has not been used for an extended period, test all its functions before using it. If you have not used the camera for some time or if there is an important shoot such as a foreign trip coming up, have the camera checked by your Canon dealer or check the camera yourself and make sure it is working properly.
- If you use continuous shooting, Live View shooting, or movie shooting for a prolonged period, the camera may become hot. This is not a malfunction.
- If there is a bright light source inside or outside the image area, ghosting may occur.

# Nomenclature

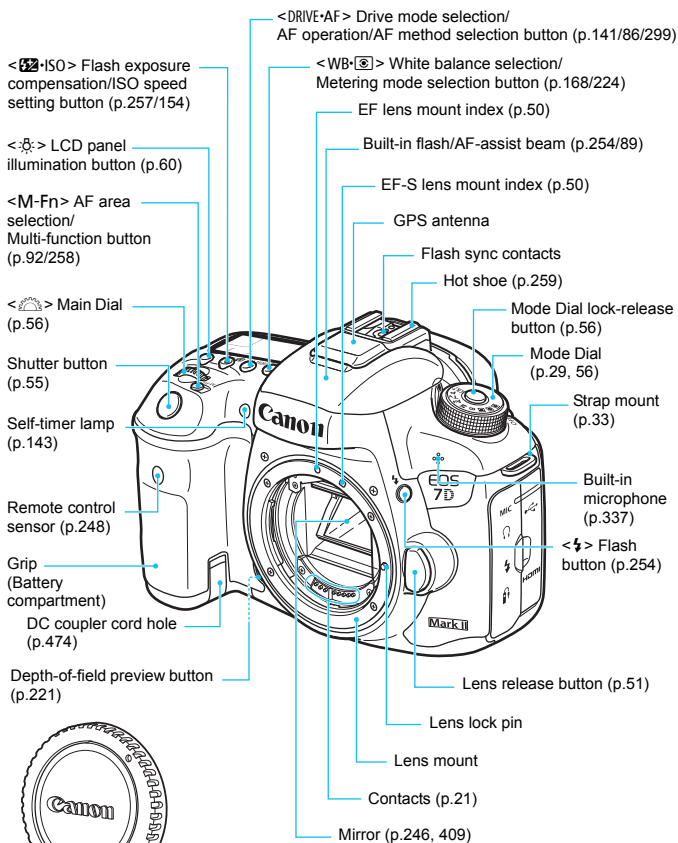

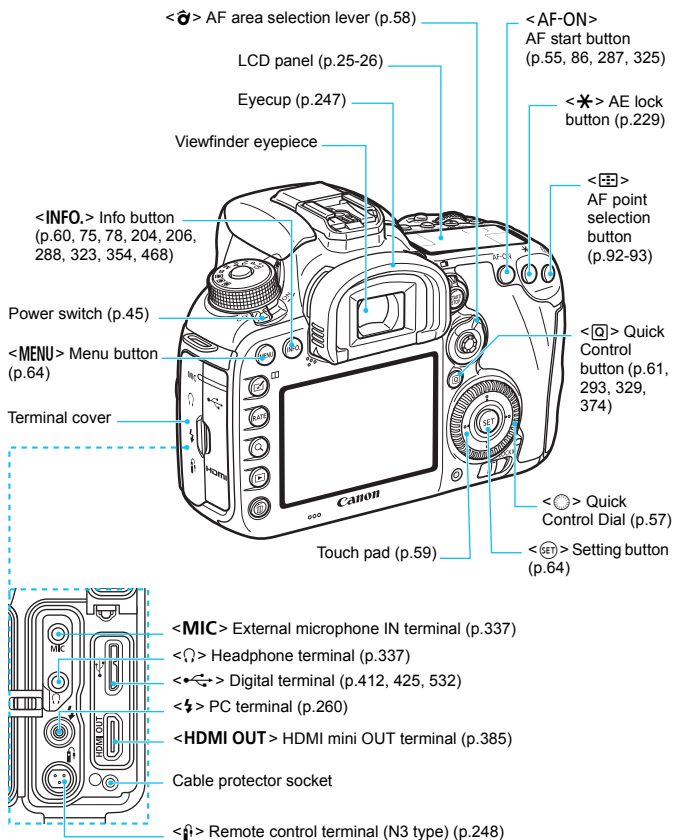

When connecting the interface cable to a digital terminal, also use the provided cable protector (p.34).

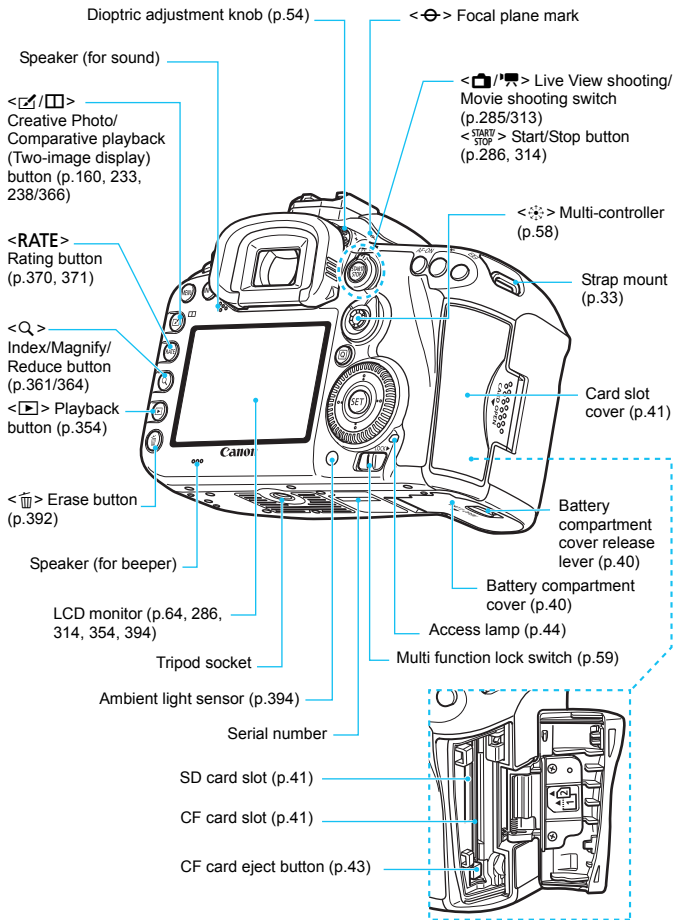

## LCD Panel

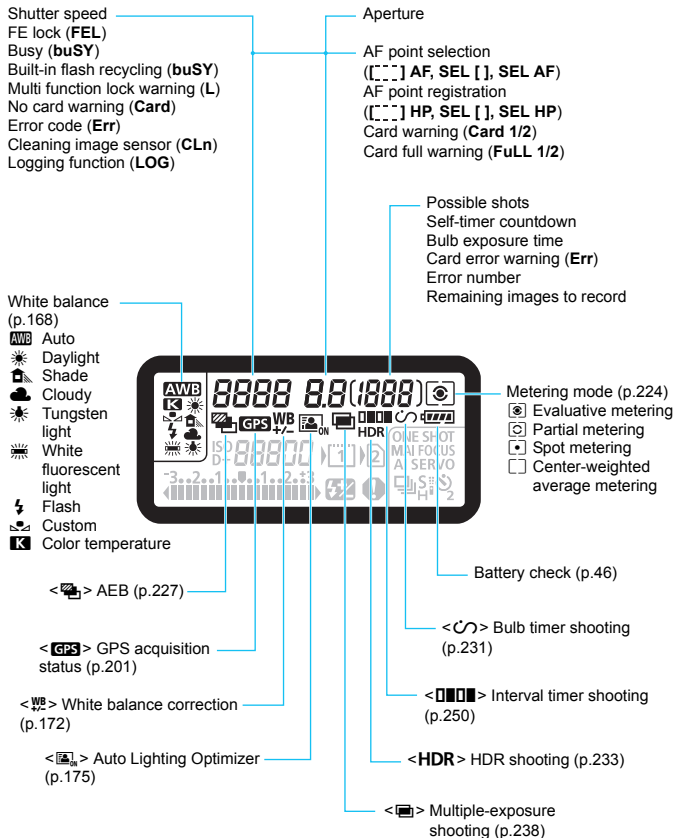

\* The display will show only the settings currently applied.

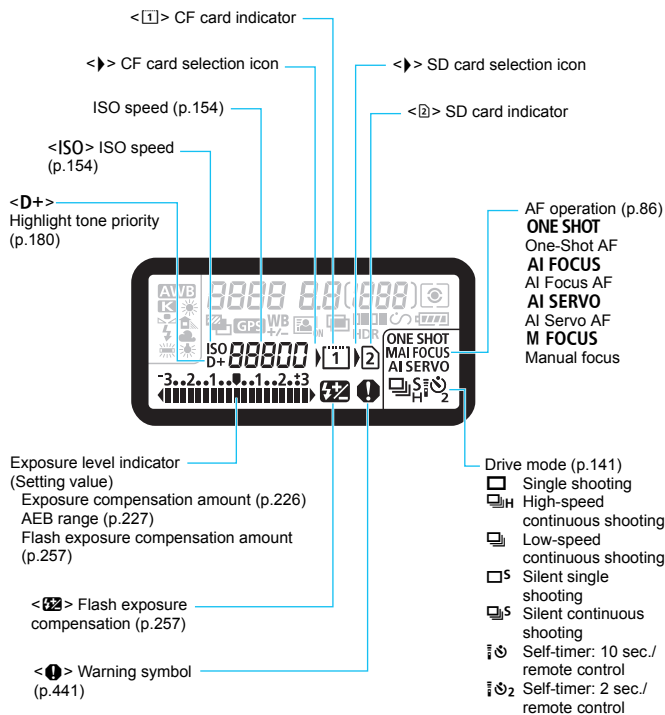

## Viewfinder Information

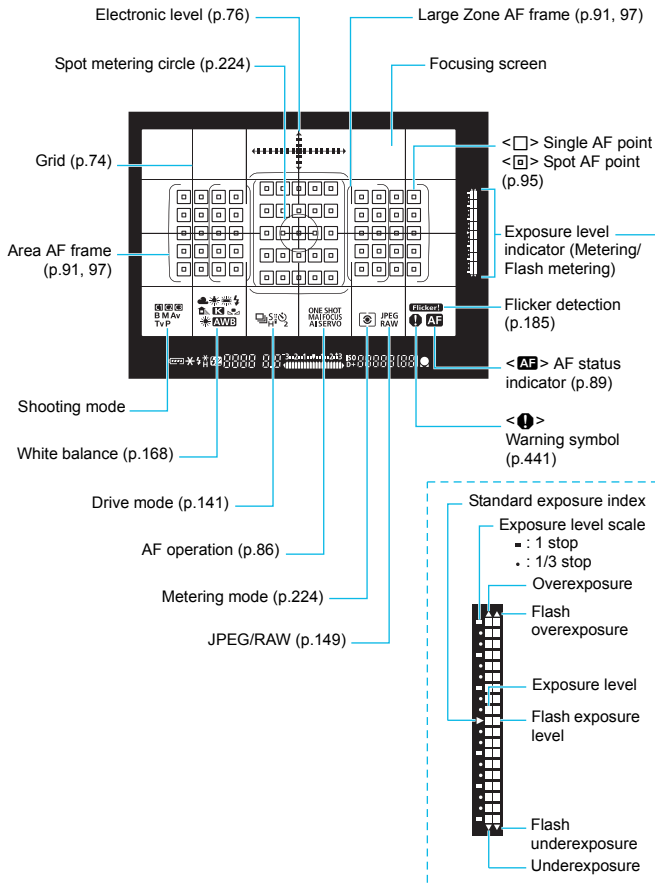

\* The display will show only the settings currently applied.

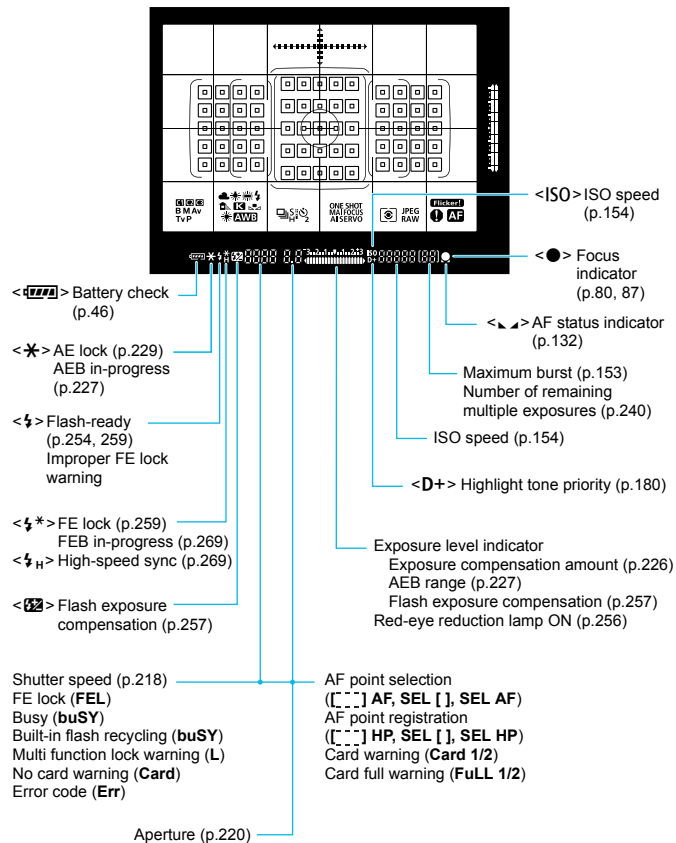



## Mode Dial

You can set the shooting mode. Turn the Mode Dial while holding down the Mode Dial center (Mode Dial lock release button).

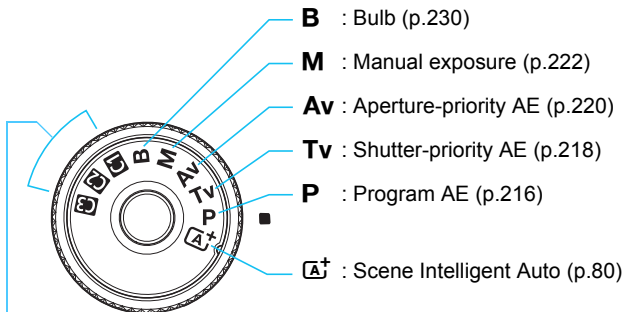

## Custom shooting mode

You can register the shooting mode (**P/Tv/Av/M/B**), AF operation, menu settings, etc., to **1**, **2**, **3** Mode Dial positions (p.464).

## EF-S18-135mm f/3.5-5.6 IS USM Lens

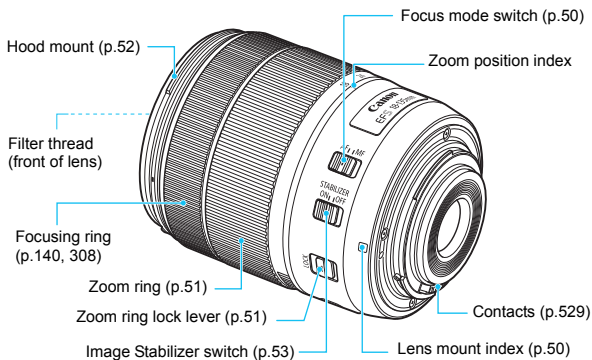

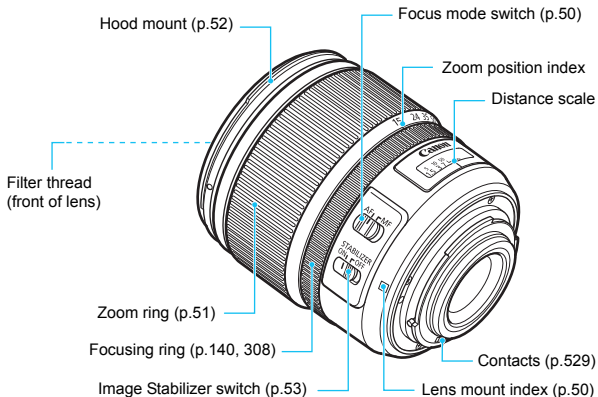
**EF-S15-85mm f/3.5-5.6 IS USM Lens**

## Battery Charger LC-E6

Charger for Battery Pack LP-E6N/LP-E6 (p.38).

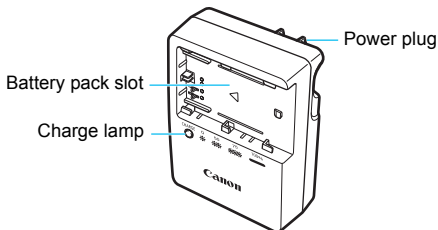

**IMPORTANT SAFETY INSTRUCTIONS-SAVE THESE INSTRUCTIONS.  
DANGER-TO REDUCE THE RISK OF FIRE OR ELECTRIC SHOCK,  
CAREFULLY FOLLOW THESE INSTRUCTIONS.**

For connection to a supply not in the U.S.A., use an attachment plug adapter of the proper configuration for the power outlet, if needed.

## Battery Charger LC-E6E

Charger for Battery Pack LP-E6N/LP-E6 (p.38).

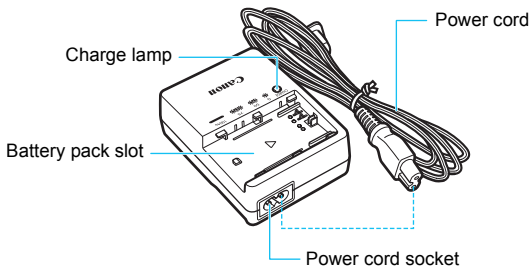

## Attaching the Strap

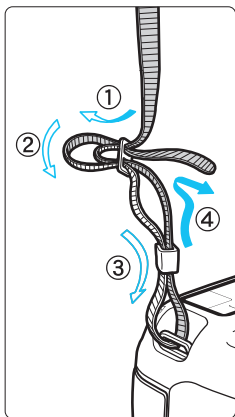

Pass the end of the strap through the camera's strap mount eyelet from the bottom. Then pass it through the strap's buckle as shown in the illustration. Pull the strap to take up any slack and make sure the strap will not loosen from the buckle.

- The eyepiece cover is also attached to the strap (p.247).

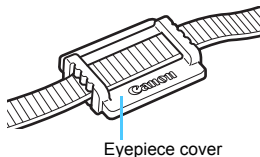

## Using the Cable Protector

When connecting the camera to a computer, printer or Wireless File Transmitter, use the provided interface cable or one from Canon (shown in the System Map on page 478).

When connecting the interface cable, also use the provided cable protector. Using the cable protector prevents the cable from accidental disconnection and the terminal from getting damaged.

### Using a Provided Interface Cable and a Genuine HDMI Cable (sold separately)

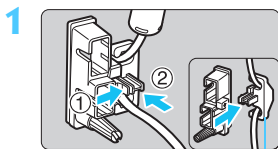

Clamp

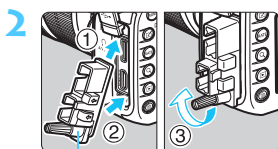

Cable protector

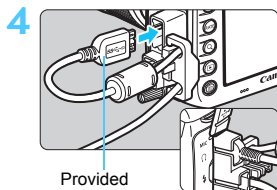
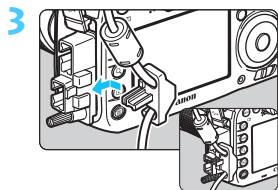

Provided interface cable

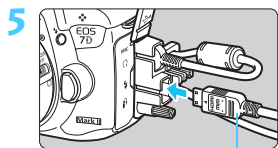

HDMI cable (sold separately)

### Using a Genuine Interface Cable (sold separately)

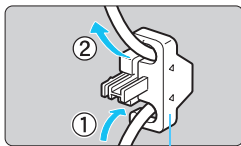

Clamp

If you use a genuine interface cable (sold separately, p.478), run the cable through the clamp before attaching the clamp to the cable protector.



- Connecting interface cable without using the cable protector may damage the digital terminal.
- Do not use a USB 2.0 cable equipped with a Micro-B plug. It may damage the camera's digital terminal.
- As shown in the lower-right illustration for step 4, check that the interface cable is securely attached to the digital terminal.





To connect the camera to a TV set, using HDMI Cable HTC-100 (sold separately) is recommended. Using the cable protector is recommended even when connecting an HDMI cable.

## Wi-Fi Adapter W-E1

This adapter is an accessory that enables Wi-Fi (wireless communication) functions when installed in the SD card slot of the camera.

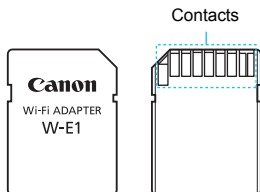
For instructions, refer to “Wi-Fi Adapter W-E1 Preliminary Notes and Legal Information” and “Wi-Fi Adapter W-E1 Instruction Manual” (p.4).



 The W-E1 cannot record images. To record images, be sure to use a CF card.



# 1

## Getting Started

This chapter explains preparatory steps before you start shooting and basic camera operations.

### Minimizing Dust

- When changing lenses, do it quickly in a place with minimal dust.
- When storing the camera without a lens attached, be sure to attach the body cap to the camera.
- Remove dust on the body cap before attaching it.

# Charging the Battery

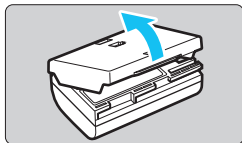

- 1 Remove the protective cover.**
- Detach the protective cover provided with the battery.

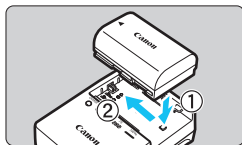

- 2 Attach the battery.**
- As shown in the illustration, attach the battery securely to the charger.
  - To detach the battery, follow the above procedure in reverse.

## LC-E6

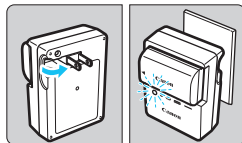

- 3 Recharge the battery.**
- For LC-E6**

- As shown by the arrow, flip out the battery charger's prongs and insert the prongs into a power outlet.

## LC-E6E

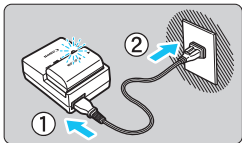

**For LC-E6E**

- Connect the power cord to the charger and insert the plug into a power outlet.
- ▶ Recharging starts automatically and the charge lamp blinks in orange.

Charge Level	Charge Lamp	
	Color	Display
0-49%	Orange	Blinks once per second
50-74%		Blinks twice per second
75% or higher		Blinks three times per second
Fully charged	Green	Lights up

- It takes approx. 2 hr. and 30 min. to fully recharge a completely exhausted battery at room temperature (23°C / 73°F). The time required to recharge the battery will vary greatly depending on the ambient temperature and the battery's remaining capacity.
- For safety reasons, recharging in low temperatures (5°C - 10°C / 41°F - 50°F) will take longer (up to approx. 4 hr.).



## Tips for Using the Battery and Charger

- **Upon purchase, the battery is not fully charged.**  
Charge the battery before use.
- **Recharge the battery on the day before or on the day it is to be used.**  
Even during storage, a charged battery will gradually drain and lose its capacity.
- **After recharging the battery, detach it and disconnect the charger from the power outlet.**

- **You can attach the cover in a different orientation to indicate whether the battery has been recharged or not.**

If the battery has been recharged, attach the cover so that the battery-shaped hole <  > is aligned over the blue sticker on the battery. If the battery is exhausted, attach the cover in the opposite orientation.

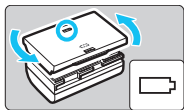

- **When not using the camera, remove the battery.**  
If the battery is left in the camera for a prolonged period, a small amount of power current is released, resulting in excess discharge and shorter battery life. Store the battery with the protective cover attached. Storing the battery when it is fully charged may lower the battery's performance.
- **The battery charger can also be used in foreign countries.**  
The battery charger is compatible with a 100 V AC to 240 V AC 50/60 Hz power source. If necessary, attach a commercially-available plug adapter for the respective country or region. Do not attach any portable voltage transformer to the battery charger. Doing so can damage the battery charger.
- **If the battery becomes exhausted quickly even after being fully charged, the battery has reached the end of its service life.**  
Check the battery's recharge performance (p.470) and purchase a new battery.



- After disconnecting the charger's power plug, do not touch the prongs for approx. 10 sec.
- If the battery's remaining capacity (p.470) is 94% or higher, the battery will not be recharged.
- The charger cannot charge any battery other than Battery Pack LP-E6N/LP-E6.

# Installing and Removing the Battery

Load a fully-charged Battery Pack LP-E6N (or LP-E6) into the camera. The camera's viewfinder becomes bright when a battery is installed, and darkens when the battery is removed.

## Installing the Battery

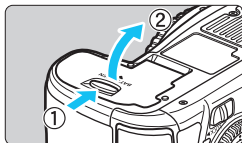

### 1 Open the cover.

- Slide the lever as shown by the arrows and open the cover.

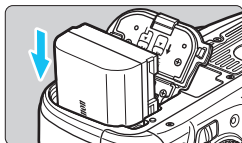

### 2 Insert the battery.

- Insert the end with the battery contacts.
- Insert the battery until it locks in place.

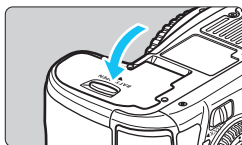

### 3 Close the cover.

- Press the cover until it snaps shut.

 Only Battery Pack LP-E6N/LP-E6 can be used.

## Removing the Battery

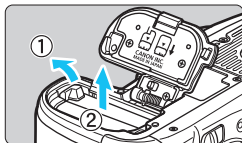

### Open the cover and remove the battery.

- Press the battery lock lever as shown by the arrow and remove the battery.
- To prevent short circuiting of the battery contacts, be sure to attach the provided protective cover (p.38) to the battery.

# Installing and Removing the Card

The camera can use a CF card and an SD card. **Images can be recorded when at least one card is installed in the camera.**

If both types of card are inserted, you can select which card to record images to, or simultaneously record images on both cards (p.146-148).

**🔊 If you use an SD card, be sure the card's write-protect switch is set upward to enable writing/erasing.**

## Installing the Card

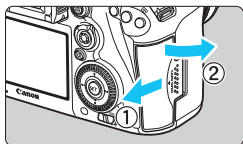

### 1 Open the cover.

- Slide the cover as shown by the arrows to open it.

### CF card

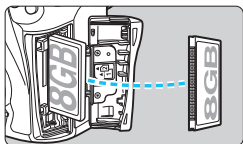

### 2 Insert the card.

- The camera-front side slot is for a CF card, and the camera-back side slot is for an SD card.
- **Face the CF card's label toward you and insert the end with the small holes into the camera.**
- **If the card is inserted in the wrong way, it may damage the camera.**

### SD card

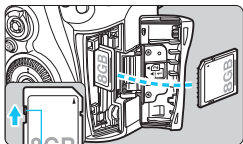

Write-protect switch

- ▶ The CF card eject button will stick out.
- **With the SD card's label facing you, push in the card until it clicks in place.**

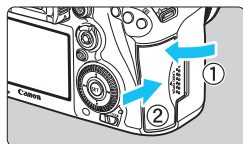

### 3 Close the cover.

- Close the cover and slide it in the direction shown by the arrows until it snaps shut.
- ▶ When you set the power switch to <ON> (p.45), the number of possible shots and the loaded card(s) will be displayed on the LCD panel.

The images will be recorded to the card indicated by the arrow <▶> icon.

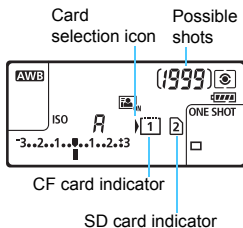

- ⚠ ● The camera cannot use Type II CF cards or hard disk-type cards.
- The Wi-Fi Adapter W-E1 cannot save images. Also, the SD card indicator will not be displayed for it.

- 📄 ● Ultra DMA (UDMA) CF cards can also be used with the camera. UDMA cards enable faster data writing.
- SD/SDHC/SDXC memory cards are supported. UHS-I SDHC or SDXC memory cards can also be used.
- The number of possible shots depends on the remaining capacity of the card, image-recording quality, ISO speed, etc.
- Even if shooting 2,000 or more shots is possible, the indicator will display only up to 1999.
- Setting [📷 1: Release shutter without card] to [Disable] will prevent you from forgetting to insert a card (p.484).

## Removing the Card

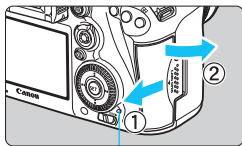

Access lamp

### 1 Open the cover.

- Set the power switch to <OFF>.
- **Make sure the access lamp is off, then open the cover.**
- If [Recording...] is displayed, close the cover.

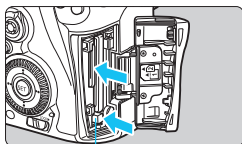

CF card eject button

### 2 Remove the card.

- To remove the CF card, push the eject button.
- To remove the SD card, push it in gently and release it. Then pull it out.
- Pull the card straight out, then close the cover.



- **When the access lamp is lit or blinking, it indicates that images are being written to, read from, or erased from the card, or data is being transferred. Do not open the card slot cover during this time. Also, never do any of the following while the access lamp is lit or blinking. Otherwise, it can damage the image data, card, or camera.**
  - **Removing the card.**
  - **Removing the battery.**
  - **Shaking or banging the camera around.**
- If the card already contains recorded images, the image number may not start from 0001 (p.193).
- If a card-related error message is displayed on the LCD monitor, remove and reinsert the card. If the error persists, use a different card. If you can transfer all the images on the card to a computer, transfer all the images and then format the card with the camera (p.67). The card may then return to normal.
- Do not touch the SD card's contacts with your fingers or metal objects. Do not expose the contacts to dust or water. If smudges adhere to the contacts, contact failure may result.
- Multimedia cards (MMC) cannot be used (card error will be displayed).



## Turning on the Power

If you turn on the power switch and the date/time/zone setting screen appears, see page 47 to set the date/time/zone.

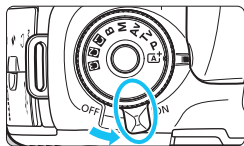

- <ON> : The camera turns on.
- <OFF> : The camera is turned off and does not operate. Set to this position when not using the camera.

## Automatic Sensor Cleaning

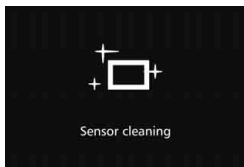

- Whenever you set the power switch to <ON> or <OFF>, sensor cleaning will be executed automatically. (A small sound may be heard.) During the sensor cleaning, the LCD monitor will display <+□+>.
- You can still shoot during sensor cleaning by pressing the shutter button halfway (p.55) to stop cleaning and take a picture.
- If you repeatedly turn the power switch <ON>/<OFF> at a short interval, the <+□+> icon may not be displayed. This is normal and not a malfunction.

## MENU Auto Power Off

- To save battery power, the camera turns off automatically after 1 minute of non-operation. To turn on the camera again, just press the shutter button halfway.
- You can set the auto power off time with [**F2: Auto power off**] (p.69).







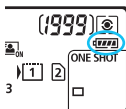

If you set the power switch to <OFF> while an image is being recorded to the card, [Recording...] will be displayed and the power will turn off after the recording finishes.

## Checking the Battery Level

When the power switch is set to <ON>, the battery level will be indicated in one of six levels. A blinking battery icon () indicates that the battery will be exhausted soon.





Display						
Level (%)	100 - 70	69 - 50	49 - 20	19 - 10	9 - 1	0

## Number of Possible Shots

Temperature	Room Temperature (23°C / 73°F)	Low Temperatures (0°C / 32°F)
No Flash	Approx. 800 shots	Approx. 760 shots
50% Flash Use	Approx. 670 shots	Approx. 640 shots

- The figures above are based on a fully-charged Battery Pack LP-E6N, no Live View shooting, and CIPA (Camera & Imaging Products Association) testing standards.
- Possible shots with Battery Grip BG-E16 (sold separately)
  - With LP-E6N x 2: approx. twice the shots without the battery grip.
  - With size-AA/LR6 alkaline batteries at room temperature (23°C / 73°F): approx. 270 shots with no flash, approx. 210 shots with 50% flash use.



- Doing any of the following will exhaust the battery sooner:
  - Pressing the shutter button halfway for a prolonged period.
  - Activating the AF frequently without taking a picture.
  - Using the lens Image Stabilizer.
  - Using the LCD monitor often.
- The number of possible shots may decrease depending on the actual shooting conditions.
- The lens operation is powered by the camera's battery. Depending on the lens used, the battery may exhaust faster.
- For the number of possible shots with Live View shooting, see page 287.
- See [**3: Battery info.**] to check the battery's condition in detail (p.470).
- With Battery Grip BG-E16 (sold separately) loaded with size AA/LR6 batteries, a four-level indicator will be displayed. () [] will not be displayed.)

## MENU Setting the Date, Time, and Zone

When you turn on the power for the first time or if the date/time/zone are reset, the date/time/zone setting screen will appear. Follow the steps below, making sure to set the time zone first. Set the camera to the time zone in which you currently live so that, when you travel, you can simply change the setting to the correct time zone for your destination and the camera will automatically adjust the date/time.

**Note that the date/time appended to recorded images will be based on this date/time setting. Be sure to set the correct date/time.**



### 1 Display the menu screen.

- Press the <MENU> button to display the menu screen.

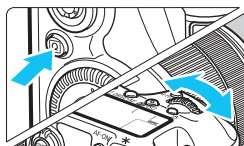

### 2 Under the [Date/Time/Zone] tab, select [Date/Time/Zone].

- Press the <Q> button and select the [Date/Time/Zone] tab.
- Turn the <Mode Dial> to select the [Date/Time/Zone] tab.
- Turn the <Date/Time/Zone Dial> to select [Date/Time/Zone], then press <SET>.

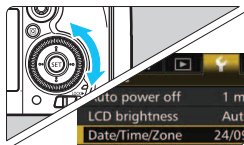

### 3 Set the time zone.

- [London] is set by default.
- Turn the <Date/Time/Zone Dial> to select [Time zone].
- Press <SET> so <OK> is displayed.
- Turn the <Date/Time/Zone Dial> to select the time zone, then press <SET>.

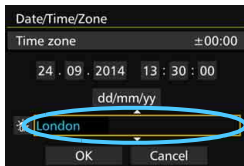

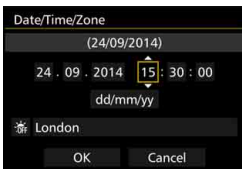

## 4 Set the date and time.

- Turn the <⌚> dial to select the number.
- Press <SET> so <⌚> is displayed.
- Turn the <⌚> dial to select the desired setting, then press <SET> (Returns to <□>).

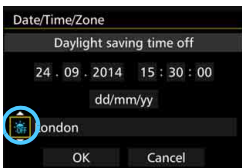

## 5 Set the daylight saving time.

- Set it if necessary.
- Turn the <⌚> dial to select [☀️].
- Press <SET> so <⌚> is displayed.
- Turn the <⌚> dial to select [☀️], then press <SET>.
- When the daylight saving time is set to [☀️], the time set in step 4 will advance by 1 hr. If [☀️] is set, the daylight saving time will be canceled and the time will go back by 1 hr.



## 6 Exit the setting.

- Turn the <⌚> dial to select [OK], then press <SET>.
- ▶ The date/time/zone and daylight saving time will be set and the menu will reappear.

- The date/time/zone settings may be reset when the camera is stored without the battery, when its battery becomes exhausted, or when it is exposed to below freezing temperatures for a prolonged period. If this happens, set the date/time/zone again.
- After changing the time zone, check that the correct date/time are set.
- When performing [Sync time between cameras] via Wireless File Transmitter, using another EOS 7D Mark II is recommended. If you perform [Sync time between cameras] using different models, the time zone or time may not be set correctly.



- The date/time that were set will start from when you press **<SET>** in step 6.
- In step 3, the time displayed on the upper right of the screen is the time difference compared with Coordinated Universal Time (UTC). If you do not see your time zone, set the time zone while referring to the difference with UTC.
- The time can be set using the GPS auto time setting function (p.209).

## **MENU** Selecting the Interface Language



### **1** Display the menu screen.

- Press the **<MENU>** button to display the menu screen.

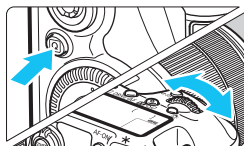

### **2** Under the [**F2**] tab, select [**Language**].

- Press the **<Q>** button and select the [**F2**] tab.
- Turn the **<WHEEL>** dial to select the [**F2**] tab.
- Turn the **<WHEEL>** dial to select [**Language**], then press **<SET>**.

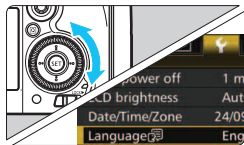

### **3** Set the desired language.

- Turn the **<WHEEL>** dial to select the language, then press **<SET>**.
- ▶ The interface language will change.

English	Norsk	Română
Deutsch	Svenska	Türkçe
Français	Español	العربية
Nederlands	Ελληνικά	עברית
Dansk	Русский	简体中文
Português	Polski	繁體中文
Suomi	Čeština	한국어
Italiano	Magyar	日本語
Українська		

# Attaching and Detaching a Lens

The camera is compatible with all Canon EF and EF-S lenses. **The camera cannot be used with EF-M lenses.**

## Attaching a Lens

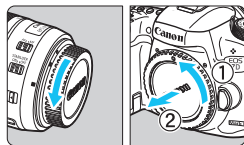

### 1 Remove the caps.

- Remove the rear lens cap and the body cap by turning them as shown by the arrows.

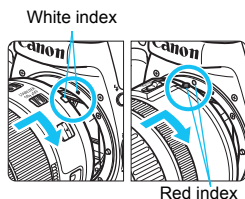

### 2 Attach the lens.

- Align the lens's red or white mount index with the camera's mount index of the same color. Turn the lens as shown by the arrow until it clicks in place.

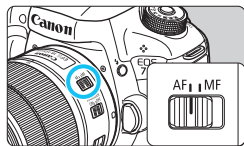

### 3 Set the lens's focus mode switch to <AF>.

- <AF> stands for autofocus.
- <MF> stands for manual focus. Autofocus will not operate.

### 4 Remove the front lens cap.



## Image Conversion Factor

Since the image sensor size is smaller than the 35mm film format, the angle of view of an attached lens will be equivalent to that of a lens with approx. 1.6x of the focal length indicated.

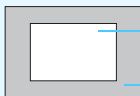
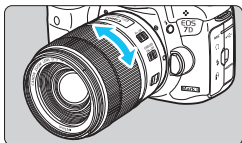

Image sensor size (Approx.)  
(22.4 x 15.0 mm / 0.88 x 0.59 in.)

35mm image size  
(36 x 24 mm / 1.42 x 0.94 in.)

## Zooming



**Turn the zoom ring on the lens with your fingers.**

- If you want to zoom, do it before focusing. Turning the zoom ring after achieving focus may throw off the focus.

## Detaching the Lens

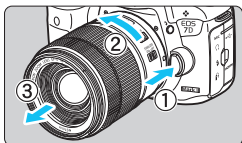

**While pressing the lens release button, turn the lens as shown by the arrow.**

- Turn the lens until it stops, then detach it.
  - Attach the rear lens cap to the detached lens.
- **To owners of the EF-S18-135mm f/3.5-5.6 IS USM lens:**  
You can prevent the lens from extending out while you are carrying it around. Set the zoom ring to the 18mm wide-angle end, then slide the zoom ring lock lever to <LOCK>. The zoom ring can be locked only at the wide-angle end.



- Do not look at the sun directly through any lens. Doing so may cause loss of vision.
- When attaching or detaching a lens, set the camera's power switch to <OFF>.
- If the front part (focusing ring) of the lens rotates during autofocus, do not touch the rotating part.

## Attaching a Lens Hood

A lens hood can block unwanted light and prevent rain, snow, dust, etc. adhering to the front of the lens. Before storing the lens in a bag, etc., you can attach the hood in reverse.

- **If the Lens and the Lens Hood Have a Mount Index**

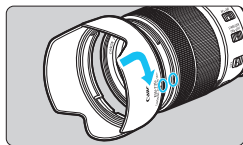

**1** **Align the red dots, then turn the hood as shown by the arrow.**

- Align the red dots on the hood and lens edge, then turn the hood as shown by the arrow.

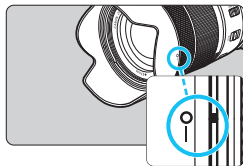

**2** **Turn the hood as shown in the illustration.**

- Turn the hood clockwise until it attaches securely.

- If the hood is not attached properly, it may obstruct the image's periphery, making the image look dark.
- When attaching or detaching the hood, grasp the base of the hood when turning it. Grasping the hood's edges when turning it may deform the hood, resulting in failure to turn.



# Lens Image Stabilizer

When you use the IS lens's built-in Image Stabilizer, camera shake is corrected to obtain a sharper shot. The procedure explained here is based on the EF-S18-135mm f/3.5-5.6 IS USM lens as an example.

\* IS stands for Image Stabilizer.

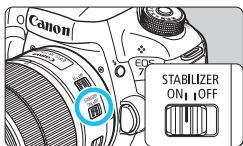

- 1 Set the IS switch to <ON>.**
  - Also set the camera's power switch to <ON>.
- 2 Press the shutter button halfway.**
  - ▶ The Image Stabilizer will operate.
- 3 Take the picture.**
  - When the picture looks steady in the viewfinder, press the shutter button completely to take the picture.



- The Image Stabilizer will not be effective if the subject moves during the exposure.
- For bulb exposures, set the IS switch to <OFF>. If <ON> is set, Image Stabilizer misoperation may occur.
- The Image Stabilizer may not be effective for excessive shaking such as on a rocking boat.



- The Image Stabilizer can operate with the lens's focus mode switch set to either <AF> or <MF>.
- When using a tripod, you can still shoot with the IS switch set to <ON> with no problem. However, to save battery power, setting the IS switch to <OFF> is recommended.
- The Image Stabilizer is effective even when the camera is mounted on a monopod.
- With the EF-S18-135mm f/3.5-5.6 IS USM or EF-S15-85mm f/3.5-5.6 IS USM lens, the Image Stabilizer mode may switch automatically to suit the shooting conditions.

# Basic Operation

## Adjusting the Viewfinder Clarity

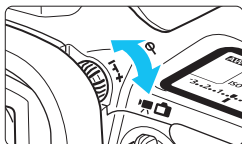

### Turn the dioptic adjustment knob.

- Turn the knob left or right so that the AF points in the viewfinder look sharp.
- If the knob is difficult to turn, remove the eyecup (p.247).

 If the camera's dioptic adjustment still cannot provide a sharp viewfinder image, using Dioptic Adjustment Lens Eg (sold separately) is recommended.

## Holding the Camera

To obtain sharp images, hold the camera still to minimize camera shake.

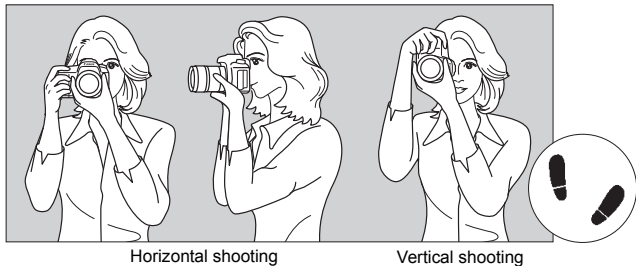

Horizontal shooting

Vertical shooting

1. Wrap your right hand around the camera grip firmly.
2. Hold the lens bottom with your left hand.
3. Rest your hand's right index finger lightly on the shutter button.
4. Press your arms and elbows lightly against the front of your body.
5. To maintain a stable stance, place one foot slightly ahead of the other.
6. Press the camera against your face and look through the viewfinder.

 To shoot while looking at the LCD monitor, see page 285.

## Shutter Button

The shutter button has two steps. You can press the shutter button halfway. Then you can further press the shutter button completely.

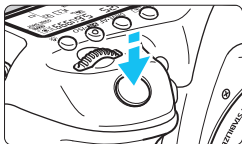

### Pressing Halfway

This activates autofocus and the automatic exposure system that sets the shutter speed and aperture.

The exposure setting (shutter speed and aperture) is displayed in the viewfinder and on the LCD panel for 4 sec. (metering timer/ ) 4).

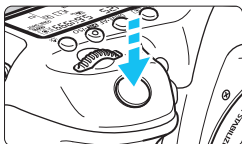

### Pressing Completely

This releases the shutter and takes the picture.

## Preventing Camera Shake

Hand-held camera movement during the moment of exposure is called camera shake. It can cause blurred pictures. To prevent camera shake, note the following:

- Hold and steady the camera as shown on the preceding page.
- Press the shutter button halfway to autofocus, then slowly press the shutter button completely.



- In the **<P>** **<Tv>** **<Av>** **<M>** **<B>** shooting modes, pressing the **<AF-ON>** button will execute the same operation as pressing the shutter button halfway.
- If you press the shutter button completely without pressing it halfway first or if you press the shutter button halfway and then press it completely immediately, the camera will take a moment before it takes the picture.
- Even during menu display, image playback, or image recording, you can go back to shooting-ready by pressing the shutter button halfway.

## Mode Dial

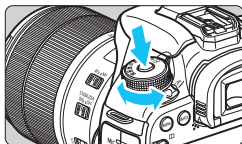



Turn the dial while holding down the lock release button at the center of the dial.



Use it to set the shooting mode.

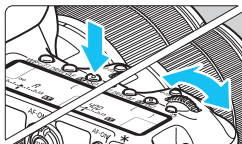

## Main Dial





- (1) After pressing a button, turn the  dial.

When you press a button such as <WB>•> <DRIVE>•AF > <•ISO>, the respective function remains selected for 6 sec. (⌚6). During this time, you can turn the  dial to change the setting. When the function selection ends or if you press the shutter button halfway, the camera will be ready to shoot.

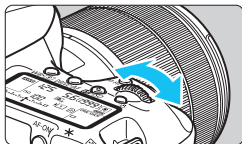
- Use this dial to select or set the metering mode, AF operation, ISO speed, AF point, etc.



- (2) Turn the  dial only.

While looking at the viewfinder or LCD panel, turn the  dial to change the setting.

- Use this dial to set the shutter speed, aperture, etc.

 The operations in (1) are possible even when the <LOCK▶> switch is set to the right (Multi function lock, p.59).

## Quick Control Dial

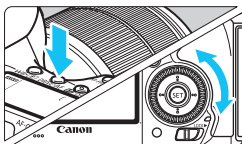

### (1) After pressing a button, turn the dial.

When you press a button such as <WB> <DRIVE> <AF> <ISO>, the respective function remains selected for 6 sec. (6). During this time, you can turn the  dial to change the setting. When the function selection ends or if you press the shutter button halfway, the camera will be ready to shoot.

- Use this dial to select or set the white balance, drive mode, flash exposure compensation, AF point, etc.

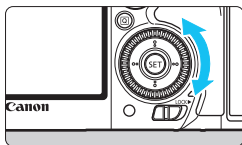

### (2) Turn the dial only.

While looking at the viewfinder or LCD panel, turn the  dial to change the setting.

- Use this dial to set the exposure compensation amount, the aperture setting for manual exposures, etc.







The operations in (1) are possible even when the <LOCK> switch is set to the right (Multi function lock, p.59).

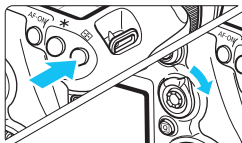

## AF Area Selection Lever

The  lever can be tilted to the right. Use it to select the AF area selection mode.



**After pressing the  button, tilt the .**



- Pressing the  button will make the AF area selection mode and AF point selectable for 6 sec. (). Then, when you tilt the  to the right within that time, you can change the AF area selection mode.

 You can also press the  button and then press the  button to select the AF area selection mode.

## Multi-controller

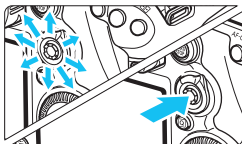
The  consists of an eight-direction key and a button at the center.





- Use it to select the AF point, correct the white balance, move the AF point or magnifying frame during Live View shooting, scroll around magnified images during playback, operate the Quick Control screen, etc.
- You can also use it to select and set menu items.
- For menus and Quick Control, the Multi-controller works only in the vertical and horizontal directions  . It does not work in diagonal directions.

## Touch Pad

During movie shooting, the touch pad provides a quiet way to adjust the shutter speed, aperture, exposure compensation, ISO speed, sound recording level, and headphone volume (p.338).

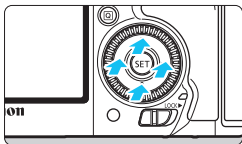
This function works when [**5: Silent Control**] is set to [Enable 



After pressing the  button, tap the  dial's inner ring at the top, bottom, left, or right.

## LOCK Multi Function Lock

By setting [**3: Multi function lock**] (p.442) and moving the  switch to the right, you can prevent the Main Dial, Quick Control Dial, Multi-controller, and AF area selection lever from moving and changing a setting inadvertently.

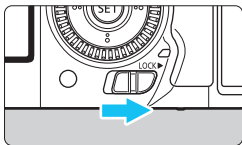



<LOCK  > switch set to the left:

Lock released



<LOCK  > switch set to the right:

Lock engaged

 If the  switch is set to the right and you try to use one of the locked camera controls, <L> will be displayed in the viewfinder and on the LCD panel. On the shooting settings display (p.60), [LOCK] will be displayed.

## LCD Panel Illumination



Turn on () or off the LCD panel illumination by pressing the  button. During a bulb exposure, pressing the shutter button completely will turn off the LCD panel illumination.

## Displaying Shooting Function Settings

After you press the **<INFO.>** button a number of times, the shooting function settings will be displayed.

With the shooting function settings displayed, you can turn the Mode Dial to see the settings for each shooting mode (p.469).

Pressing the **<Q>** button enables Quick Control of the shooting function settings (p.61).

Press the **<INFO.>** button again to turn off the display.

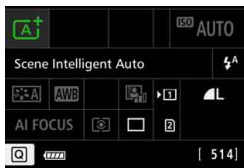



## Q Quick Control for Shooting Functions

You can directly select and set the shooting functions displayed on the LCD monitor. This is called Quick Control.

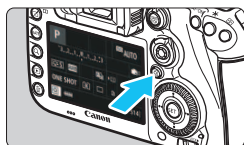

### 1 Press the <Q> button (📷10).

- ▶ The Quick Control screen will appear.

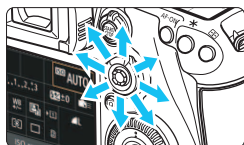

### 2 Set the desired functions.

- Use <📷> to select a function.
- ▶ The setting of the selected function is displayed.
- Turn the <📷> or <📷> dial to change the setting.

#### ● <A+> mode



#### ● <P/Tv/Av/M/B> modes



### 3 Take the picture.

- Press the shutter button completely to take the picture.
- ▶ The captured image will be displayed.

In the <A+> mode, you can only select the recording function and card, and set the image-recording quality, drive mode, and flash firing.

## Settable Functions on Quick Control Screen

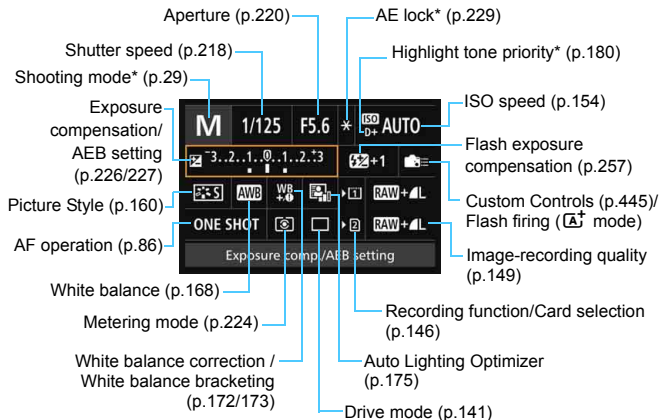

\* Functions marked with an asterisk cannot be set with the Quick Control screen.

## Function Setting Screen

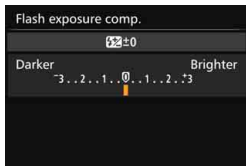

- Select a function and press **<SET>**. The function setting screen will appear.
- Turn the **<DISP/AF-ON>** or **<OK>** dial to change some of the settings. There are also functions that are set by pressing the button.
- Press **<SET>** to finalize the setting and return to the previous screen.
- When you select **<MENU>** (p.445) and press the **<MENU>** button, the previous screen will reappear.

## MENU Menu Operations

You can set various settings with the menus such as the image-recording quality, date/time, etc.

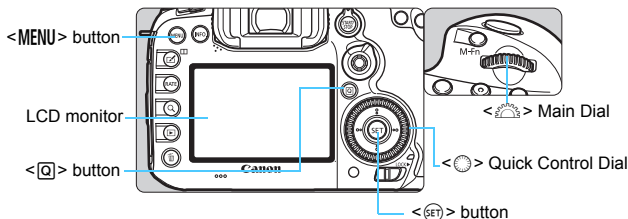

### [A]<sup>+</sup> Mode Menu Screen

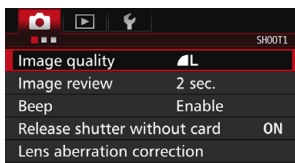
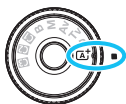

\* Certain menu tabs and menu items are not displayed in the [A]<sup>+</sup> mode.

### P/Tv/Av/M/B Mode Menu Screen

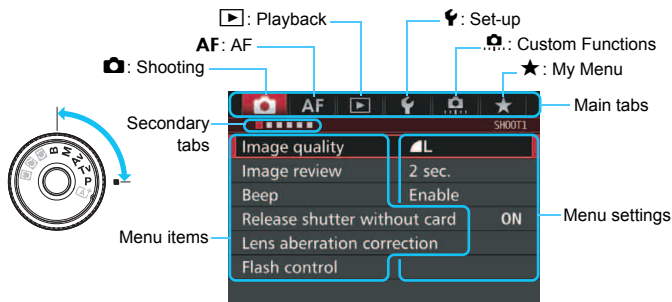

## Menu Setting Procedure

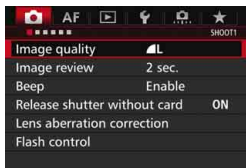

### 1 Display the menu screen.

- Press the <MENU> button to display the menu screen.

### 2 Select a tab.

- Each time you press the <Q> button, the main tab will switch.
- Turn the <DISP> dial to select a secondary tab.
- For example, the [4] tab refers to the screen displayed when the [CAMERA] (Shooting) tab's fourth dot "■" from the left is selected.

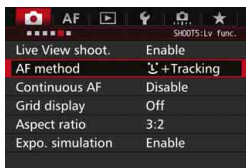

### 3 Select the desired item.

- Turn the <DISP> dial to select the item, then press <SET>.

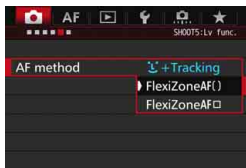

### 4 Select the setting.

- Turn the <DISP> dial to select the desired setting.
- The current setting is indicated in blue.

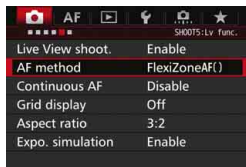

### 5 Adjust the setting.

- Press <SET> to set it.

### 6 Exit the setting.

- Press the <MENU> button to exit the menu and return to shooting-ready.

- The explanation of menu functions hereinafter assumes that you have pressed the <MENU> button to display the menu screen.
- You can also use <⏏> to operate and set menu functions. (Except for [▶]1: Erase images] and [⏏]1: Format card].)
- To cancel the operation, press the <MENU> button.
- For details about each menu item, see page 484.

## Dimmed Menu Items

Example: When Multi Shot Noise Reduction is set

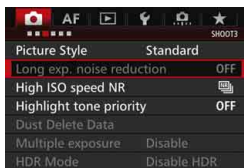

Dimmed menu items cannot be set. The menu item is dimmed if another function setting is overriding it.

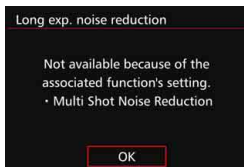

You can see the overriding function by selecting the dimmed menu item and pressing <SET>. If you cancel the overriding function's setting, the dimmed menu item will become settable.

Some dimmed menu items will not show the overriding function.

With [⏏]4: Clear all camera settings], you can reset the menu functions to the default settings (p.70).

# Before You Start

## MENU Formatting the Card

If the card is new or was previously formatted by another camera or computer, format the card with this camera.

- 1** When the card is formatted, all images and data on the card will be erased. Even protected images will be erased, so make sure there is nothing you need to keep. If necessary, transfer the images and data to a computer, etc., before formatting the card.

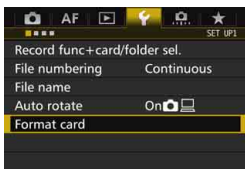

### 1 Select [Format card].

- Under the [**1**] tab, select [**Format card**], then press <SET>.

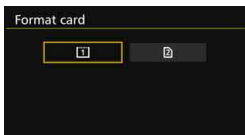

### 2 Select the card.

- [**1**] is the CF card, and [**2**] is the SD card.
- Select the card, then press <SET>.



### 3 Select [OK].

- The card will be formatted.

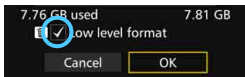

- When [**2**] is selected, low-level formatting is possible (p.68). For low-level formatting, press the <FORMAT> button to append [**Low level format**] with a checkmark <✓>, then select [**OK**].



## Format the card in the following cases:

- The card is new.
- The card was formatted by a different camera or a computer.
- The card is full with images or data.
- A card-related error is displayed (p.510).

### Low-level Formatting

- Perform low-level formatting if the SD card's reading or writing speed seems slow or if you want to totally erase all data on the card.
- Since low-level formatting will erase all recordable sectors on the SD card, the formatting will take slightly longer than normal formatting.
- You can stop the low-level formatting by selecting **[Cancel]**. Even in this case, normal formatting will be completed and you can use the SD card as usual.



- When the card is formatted or data is erased, only the file management information is changed. The actual data is not completely erased. Be aware of this when selling or discarding the card. When discarding the card, execute low-level formatting or destroy the card physically to prevent the personal data from being leaked.
- **Before using a new Eye-Fi card (p.475), the software on the card must be installed on your computer. Then format the card with the camera.**



- The card capacity displayed on the card format screen may be smaller than the capacity indicated on the card.
- This device incorporates exFAT technology licensed from Microsoft.



## MENU Disabling the Beeper

You can prevent the beeper from sounding when focus is achieved or during self-timer operation.

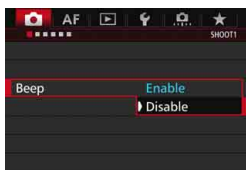

- 1 **Select [Beep].**
  - Under the [**1**] tab, select [**Beep**], then press <SET>.
- 2 **Select [Disable].**
  - Select [**Disable**], then press <SET>.
  - ▶ The beeper will not sound.

## MENU Setting the Power-off Time/Auto Power Off

To save battery power, the camera turns off automatically after a set time of idle operation elapses. The default setting is 1 min., but this setting can be changed. If you do not want the camera to turn off automatically, set this to [**Disable**]. After the power turns off, you can turn on the camera again by pressing the shutter button or other buttons.



- 1 **Select [Auto power off].**
  - Under the [**2**] tab, select [**Auto power off**], then press <SET>.
- 2 **Set the desired time.**
  - Select the desired setting, then press <SET>.

 Even if [**Disable**] is set, the LCD monitor will turn off automatically after 30 min. to save power. (The camera's power does not turn off.)

## MENU Setting the Image Review Time

You can set how long the image is displayed on the LCD monitor just after shooting. To keep the image displayed, set **[Hold]**. To not have the image displayed, set **[Off]**.

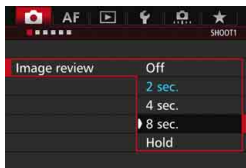

### 1 Select **[Image review]**.

- Under the [**1**] tab, select **[Image review]**, then press < **SET** >.

### 2 Set the desired time.

- Select the desired setting, then press < **SET** >.

If **[Hold]** is set, the image will be displayed until the auto power off time elapses.

## MENU Reverting the Camera to the Default Settings <sup>☆</sup>

The camera's shooting function settings and menu settings can be reverted to their defaults.

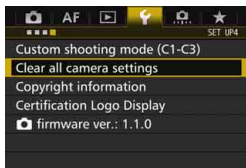

### 1 Select **[Clear all camera settings]**.

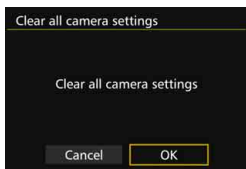

- Under the [**4**] tab, select **[Clear all camera settings]**, then press < **SET** >.



### 2 Select **[OK]**.

- ▶ Clearing all the camera settings will reset the camera to the default settings on pages 71-73.

## Shooting Function Settings

AF operation	One-Shot AF
AF area selection mode	Single-point AF (Manual Selection)
AF point selection	Center
Registered AF point	Canceled
Metering mode	 (Evaluative metering)
ISO speed	Auto
ISO speed range	Minimum limit: 100 Maximum limit: 16000
Auto ISO range	Minimum limit: 100 Maximum limit: 6400
Minimum shutter speed	Auto
Drive mode	 (Single shooting)
Exposure compensation/AEB	Canceled
Flash exposure compensation	Canceled
Red-eye reduction	Disable
Multiple exposure	Disable
HDR Mode	Disable HDR
Interval timer	Disable
Bulb timer	Disable
Anti-flicker shooting	Disable
Mirror lockup	Disable
Viewfinder display	
Viewfinder level	Hide
VF grid display	Disable
Show/hide in viewfinder	Only Flicker checkmarked
Custom Functions	Unchanged
Flash control	
Flash firing	Enable
E-TTL II Flash metering	Evaluative flash metering
Flash sync. speed in Av mode	Auto

## AF Settings

Case 1 - 6	Case1/Parameter settings of all cases cleared
AI Servo 1st image priority	Equal priority
AI Servo 2nd image priority	Equal priority
Lens electronic MF	Enable after One-Shot AF
AF-assist beam firing	Enable
One-Shot AF release priority	Focus priority
Lens drive when AF impossible	Continue focus search
Selectable AF point	65 points
Select AF area selection mode	All items selected
AF area selection method	M-Fn button
Orientation linked AF point	Same for both vertical/horizontal
Initial AF point,  AI Servo AF	Auto
Automatic AF point selection: EOS iTR AF	Enable
Manual AF point selection pattern	Stops at AF area edges
AF point display during focus	Selected (constant)
VF display illumination	Auto
AF point during AI Servo AF	Non illuminated
AF status in viewfinder	Show in field of view
AF Microadjustment	Disable/ Adjustment amount retained

## Image Recording Settings

Image quality	L
Picture Style	Standard
Auto Lighting Optimizer	Standard
Peripheral illumination correction	Enable/Correction data retained
Chromatic aberration correction	Enable/Correction data retained
Distortion correction	Disable/Correction data retained
White balance	(Auto)
Custom White Balance	Canceled
White balance shift	Canceled
White balance bracketing	Canceled
Color space	sRGB
Long exposure noise reduction	Disable
High ISO speed noise reduction	Standard
Highlight tone priority	Disable
Record function	Standard
File numbering	Continuous
File name	Preset code
Auto cleaning	Enable
Dust Delete Data	Erased

## Camera Settings

Auto power off	1 min.
Beep	Enable
Release shutter without card	Enable
Image review time	2 sec.
Highlight alert	Disable
AF point display	Disable
Playback grid	Off
Histogram display	Brightness
Movie playback count	Unchanged
Magnification (Approx.)	2x (magnify from center)
Control over HDMI	Disable
Image jump w/	(10 images)
Auto rotate	On
LCD brightness	Auto
Date/Time/Zone	Unchanged
Eye-Fi settings	Disable
Language	Unchanged
GPS and digital compass settings	Disable
Video system	Unchanged
<b>INFO</b> button display options	All items selected
<b>RATE</b> button function	Rating
Custom shooting mode	Unchanged
Copyright information	Unchanged
Configure: MY MENU*	Unchanged
Menu display	Normal display
Wi-Fi Function (only with W-E1)	Unchanged

## Live View Shooting Settings

Live View shooting	Enable
AF method	+Tracking
Continuous AF	Disable
Grid display	Off
Aspect ratio	3:2
Exposure simulation	Enable
Silent LV shooting	Mode 1
Metering timer	8 sec.

## Movie Shooting Settings

Movie Servo AF	Enable
AF method	+Tracking
Grid display	Off
<b>Movie recording quality</b>	
MOV/MP4	MOV
Movie recording size	NTSC: PAL:
24.00P	Disable
Sound recording	Auto
Wind filter	Disable
Attenuator	Disable
<b>Movie Servo AF speed</b>	
When active	Always on
AF speed	Standard
Movie Servo AF tracking sensitivity	0 (Standard)
Silent LV shooting	Mode 1
Metering timer	8 sec.
<b>Time code</b>	
Count up	Unchanged
Start time setting	Unchanged
Movie recording count	Unchanged
Movie playback count	Unchanged
HDMI	Unchanged
Drop frame	Unchanged
Silent control	Disable
button function	AF /
HDMI output + LCD	No mirroring
HDMI frame rate	Auto

## # Displaying the Grid

You can display a grid in the viewfinder to help you check the camera tilt or compose the shot.

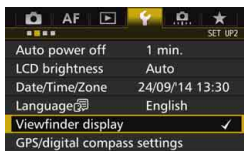

### 1 Select [Viewfinder display].

- Under the [**2**] tab, select [Viewfinder display], then press <SET>.





### 2 Select [VF grid display].

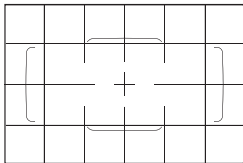

### 3 Select [Enable].

- ▶ When you exit the menu, the grid will appear in the viewfinder.



 You can display a grid on the LCD monitor during Live View shooting and before you start shooting a movie (p.295, 344).

## Displaying the Electronic Level

You can display the electronic level on the LCD monitor and in the viewfinder to help you correct camera tilt.

### Displaying the Electronic Level on the LCD Monitor

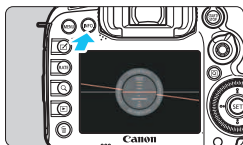

#### 1 Press the <INFO.> button.

- Each time you press the <INFO.> button, the screen display will change.
- Display the electronic level.
- If the electronic level does not appear, set [ 3: **INFO** button display options] so that the electronic level can be displayed (p.468).

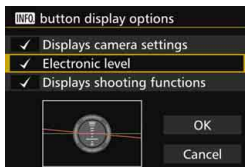

#### 2 Check the camera's tilt.

- The horizontal and vertical tilt are displayed in 1° increments.
- When the red line turns green, it indicates that the tilt is almost corrected.

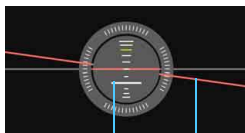

Vertical level    Horizontal level



- Even when the tilt is corrected, there may be a margin of error of approx.  $\pm 1^\circ$ .
- If the camera is very tilted, the electronic level's margin of error will be larger.



During Live View shooting and before movie shooting (except with  + Tracking), you can also display the electronic level as described above.

## **MENU** Displaying the Electronic Level in the Viewfinder

An electronic level can be displayed on the upper part of the viewfinder. Since this can be displayed while you shoot, you can correct the camera tilt while shooting.



### 1 Select [Viewfinder display].

- Under the [📷] tab, select [Viewfinder display], then press <SET>.



### 2 Select [Viewfinder level].

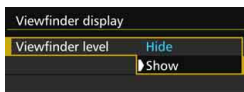

### 3 Select [Show].

### 4 Press the shutter button halfway.

- The electronic level will be displayed in the viewfinder.
- This also works with vertical shooting.

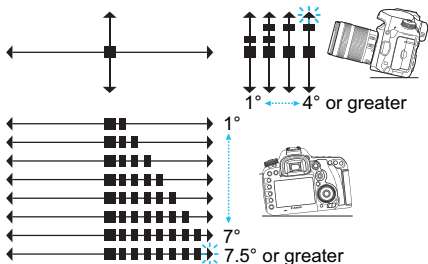

⚠ Even when the tilt is corrected, there may be a margin of error of approx.  $\pm 1^\circ$ .



## MENU Setting the Viewfinder Information Display ☆

The shooting function settings (Shooting mode, White balance, Drive mode, AF operation, Metering mode, Image quality: JPEG/RAW, Flicker detection) can be displayed in the viewfinder.

By default, only Flicker detection is checkmarked [✓].



### 1 Select [Viewfinder display].

- Under the [2] tab, select [Viewfinder display], then press <SET>.



### 2 Select [Show/hide in viewfinder].

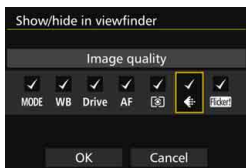

### 3 Checkmark [✓] the information to be displayed.

- Select the information to display and press <SET> to append a checkmark <✓>.
- Repeat this procedure to append a checkmark [✓] to all the information to be displayed. Then select [OK].
- When you exit the menu, the checkmarked information will appear in the viewfinder (p.27).



If no card is inserted in the camera, the image-recording quality will not be displayed in the viewfinder.

When you press the <WB> or <DRIVE> button, operate the lens's focus mode switch, or when a lens equipped with electronic manual focusing is used and the AF/MF switches as the lens's focusing ring is turned (p.119), the respective information will appear in the viewfinder regardless of whether it is checkmarked.

## ? Help

When [INFO Help] is displayed at the bottom of the menu screen, the feature's description (Help) can be displayed. The Help screen is displayed only while you hold down the <INFO.> button. If the Help fills more than one screen, a scroll bar will appear on the right edge. To scroll, hold down the <INFO.> button and turn the <DIAL> dial.

### ● Example: [AF1: Case2]

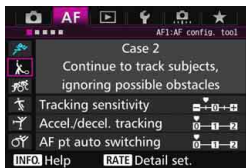

INFO.

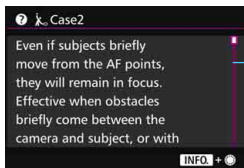

Scroll bar

### ● Example: [AF4: Orientation linked AF point]

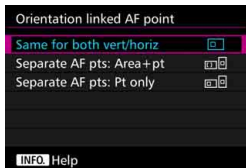

INFO.

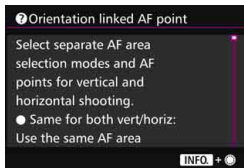

### ● Example: [..3: Multi function lock]



INFO.

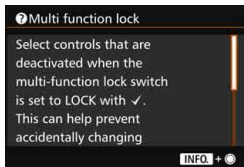

# 2

## Basic Shooting

This chapter explains how to use the Mode Dial's **<A<sup>+</sup>>** (Scene Intelligent Auto) mode for easy picture taking.

In the **<A<sup>+</sup>>** mode, all you do is point and shoot and the camera sets everything automatically (p.480). Also, to prevent botched pictures due to mistaken operations, advanced shooting function settings cannot be changed.

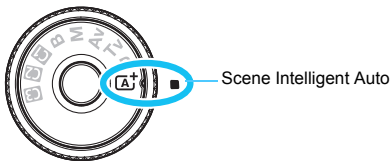

### Auto Lighting Optimizer

In the **<A<sup>+</sup>>** mode, the Auto Lighting Optimizer (p.175) will adjust the image automatically to obtain the optimum brightness and contrast. It is also enabled by default in the **<P>**, **<Tv>**, or **<Av>** mode.

## **[A<sup>+</sup>]** Fully Automatic Shooting (Scene Intelligent Auto) ■

**<[A<sup>+</sup>]>** is a fully automatic mode. The camera analyzes the scene and sets the optimum settings automatically. It also adjusts focus automatically by detecting whether the subject is still or moving (p.83).



### **1 Set the Mode Dial to <[A<sup>+</sup>]>.**

- Turn the Mode Dial while holding down the lock release button at the center.

Area AF frame

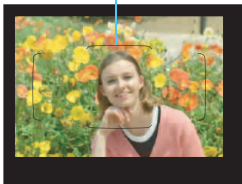

### **2 Aim the Area AF frame over the subject.**

- All the AF points will be used to focus, and the camera will focus on the closest object.
- Aiming the center of the Area AF frame over the subject will make focusing easier.

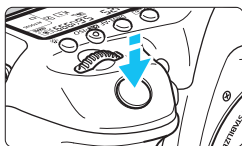

### **3 Focus on the subject.**

- Press the shutter button halfway. The lens elements will shift to focus.
- ▶ During the autofocus operation, **<AF>** will be displayed.
- ▶ The AF point that achieves focus will be displayed. At the same time, the beeper will sound and the focus indicator **<●>** will light up.
- ▶ In low light, the AF point(s) will light up briefly in red.
- ▶ If necessary, the built-in flash will be raised automatically.

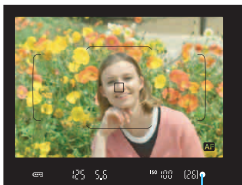

Focus indicator

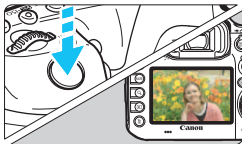

## 4 Take the picture.

- Press the shutter button completely to take the picture.
- ▶ The captured image will be displayed for 2 sec. on the LCD monitor.
- After you finish shooting, push down the built-in flash with your fingers.



The **A+** mode makes the colors look more impressive in nature, outdoor, and sunset scenes. If you did not obtain the desired color tones, change the mode to **P**, **Tv**, **Av**, or **M**, set a Picture Style other than **A**, then shoot again (p.160).



## FAQ

- **The focus indicator <●> blinks and focus is not achieved.**  
Aim the Area AF frame over an area with good contrast, then press the shutter button halfway (p.55). If you are too close to the subject, move away and try again.
- **When focus is achieved, the AF points do not light up in red.**  
The AF points light up in red in low-light conditions.
- **Multiple AF points light up simultaneously.**  
Focus has been achieved at all those points. As long as the AF point covering the desired subject lights up, you can take the picture.
- **The beeper continues to beep softly. (The focus indicator <●> does not light up.)**  
It indicates that the camera is focusing continuously on a moving subject. (The focus indicator <●> does not light up.) You can take sharp pictures of a moving subject.  
Note that focus lock (p.83) will not work in this case.

- **Pressing the shutter button halfway does not focus on the subject.**

If the focus mode switch on the lens is set to <MF> (manual focus), set it to <AF> (autofocus).

- **The flash fired even though it was daylight.**

For a backlit subject, the flash may fire to help lighten the subject's dark areas. If you do not want the flash to fire, use the Quick Control to set [Flash firing] to [☺] (p.61).

- **The flash fired and the picture came out extremely bright.**

Move further away from the subject and shoot. When shooting flash photography, if the subject is too close to the camera, the picture may come out extremely bright (overexposure).

- **In low light, the built-in flash fired a series of flashes.**

Pressing the shutter button halfway may trigger the built-in flash to fire a series of flashes to assist autofocusing. This is called the AF-assist beam (p.89). Its effective range is approx. 4 meters/13.1 feet. The built-in flash will make a sound when firing continuously. This is normal and not a malfunction.

- **When flash was used, the bottom part of the picture came out unnaturally dark.**

The shadow of the lens barrel was captured in the picture because the subject was too close to the camera. Move further away from the subject and shoot. If a hood is attached to the lens, remove it before taking the flash picture.

## Full Auto Techniques (Scene Intelligent Auto) ■

### Recomposing the Shot



Depending on the scene, position the subject toward the left or right to create a balanced background and good perspective.

In the  mode, pressing the shutter button halfway to focus on a still subject will lock the focus on that subject. Recompose the shot while keeping the shutter button pressed halfway, and then press the shutter button completely to take the picture. This is called “focus lock”.

### Shooting a Moving Subject



In the  mode, if the subject moves (distance to camera changes) while or after you focus, AI Servo AF will take effect to focus on the subject continuously. (The beeper will continue beeping softly.) As long as you keep the Area AF frame positioned over the subject while pressing the shutter button halfway, the focusing will be continuous. When you want to take the picture, press the shutter button completely.

## Live View Shooting

You can shoot while viewing the image on the LCD monitor. This is called “Live View shooting”. For details, see page 285.

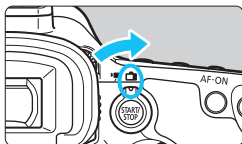

- 1 Set the Live View shooting/Movie shooting switch to .**

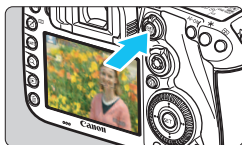

- 2 Display the Live View image on the LCD monitor.**

- Press the  $\langle \text{START/STOP} \rangle$  button.
- ▶ The Live View image will appear on the LCD monitor.

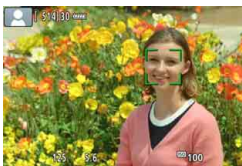

- 3 Focus on the subject.**

- Press the shutter button halfway to focus.
- ▶ When focus is achieved, the AF point will turn green and the beeper will sound.

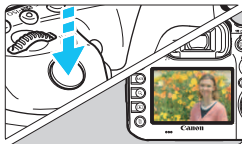

- 4 Take the picture.**

- Press the shutter button completely.
- ▶ The picture is taken and the captured image is displayed on the LCD monitor.
- ▶ When the playback display ends, the camera will return to Live View shooting automatically.
- Press the  $\langle \text{START/STOP} \rangle$  button to end the Live View shooting.



# 3

## Setting the AF and Drive Modes

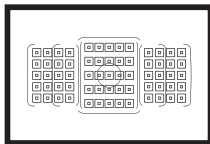

The AF points in the viewfinder are arranged to make AF shooting suitable for a wide variety of subjects and scenes.

You can also select the AF operation and drive mode that best match the shooting conditions and subject.

- A ☆ icon at the upper right of a page title indicates a function that can be used only in these modes: <P> <Tv> <Av> <M> <B>.
- In the <A+> mode, the AF operation and AF area selection mode are set automatically.



<AF> stands for autofocus. <MF> stands for manual focus.

# AF: Selecting the AF Operation ☆

You can select the AF operation characteristics to suit the shooting conditions or subject. In the <A+> mode, “AI Focus AF” is set automatically.

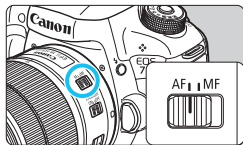

**1** Set the lens's focus mode switch to <AF>.

**2** Set the <P> <Tv> <Av> <M> <B> mode.

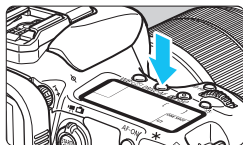

**3** Press the <DRIVE·AF> button. (Ⓞ6)

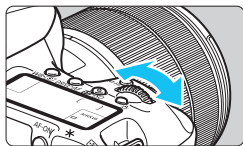

**4** Select the AF operation.

- While looking at the LCD panel or through the viewfinder, turn the <AF-ON> dial.

**ONE SHOT** : One-Shot AF

**AI FOCUS** : AI Focus AF

**AI SERVO** : AI Servo AF

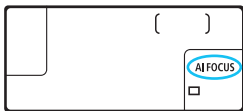

In the <P>, <Tv>, <Av>, <M>, or <B> mode, AF is also possible by pressing the <AF-ON> button.

## One-Shot AF for Still Subjects

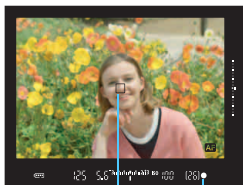

AF point

Focus indicator

**Suited for still subjects. When you press the shutter button halfway, the camera will focus only once.**

- When focus is achieved, the AF point that achieved focus will be displayed, and the focus indicator <●> in the viewfinder will also light up.
  - With evaluative metering (p.224), the exposure setting will be set at the same time as focus is achieved.
- While you hold down the shutter button halfway, the focus will be locked. You can then recompose the shot if desired.



- If focus cannot be achieved, the focus indicator <●> in the viewfinder will blink. If this occurs, the picture cannot be taken even if the shutter button is pressed completely. Recompose the shot and try to focus again or see “When Autofocus Fails” (p.139).
- If [CAM 1: Beep] is set to [Disable], the beeper will not sound when focus is achieved.
- After achieving focus with One-Shot AF, you can lock the focus on a subject and recompose the shot. This is called “focus lock”. This is convenient when you want to focus on a peripheral subject not covered by the Area AF frame.

## AI Servo AF for Moving Subjects

**This AF operation is suited for moving subjects when the focusing distance keeps changing. While you hold down the shutter button halfway, the camera will keep focusing on the subject continuously.**

- The exposure is set at the moment the picture is taken.
- When the AF area selection mode (p.90) is set to 65-point automatic selection AF, focus tracking will continue as long as the Area AF frame covers the subject.

 With AI Servo AF, the beeper will not sound even when focus is achieved. Also, the focus indicator <●> in the viewfinder will not light up.

## AI Focus AF for Switching the AF Operation Automatically

**AI Focus AF switches the AF operation from One-Shot AF to AI Servo AF automatically if a still subject starts moving.**

- After the subject is focused in One-Shot AF, if the subject starts moving, the camera will detect the movement, change the AF operation automatically to AI Servo AF, and start tracking the moving subject.

 When focus is achieved with AI Focus AF with the Servo operation active, the beeper will continue beeping softly. However, the focus indicator <●> in the viewfinder will not light up. Note that focus will not be locked in this case.

## AF Operation Indicator



When you press the shutter button halfway and the camera is focusing with AF, the <AF> icon will appear on the lower right of the viewfinder.

In the One-Shot AF mode, the icon also appears if you press the shutter button halfway after focus is achieved.



The AF operation indicator can be displayed outside the viewfinder's image area (p.132).

## AF Points Lighting Up in Red

The AF points light up in red in low-light conditions. In the <P>, <Tv>, <Av>, <M>, or <B> mode, you can set whether to have the AF points light up in red (p.131).

## AF-Assist Beam with the Built-in Flash

Under low-light conditions, when you press the shutter button halfway, the built-in flash may fire a brief burst of flashes. It illuminates the subject to help autofocusing.



- In the <A+> mode, if [Flash firing] is set to <⊕>, the built-in flash will not emit the AF-assist beam.
- The AF-assist beam will not be emitted with AI Servo AF operation.
- The built-in flash will make a sound when firing continuously. This is normal and not a malfunction.



- The effective range of the AF-assist beam emitted by the built-in flash is approx. 4 meters/13.1 feet.
- In the <P>, <Tv>, <Av>, <M>, or <B> mode, press the <⚡> button to raise the built-in flash. Then it will fire the AF-assist beam when necessary.

## Selecting the AF Area and AF Point <sup>☆</sup>

The camera has 65 AF points for autofocusing. You can select the AF area selection mode and AF point(s) suiting the scene or subject.

 **Depending on the lens attached to the camera, the number of usable AF points and AF point patterns will differ. For details, see “Lenses and Usable AF Points” on page 100.**

---

### AF Area Selection Mode

You can select one of seven AF area selection modes. For the setting procedure, see page 92.

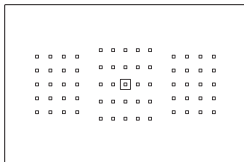

#### **Single-point Spot AF (Manual selection)**

For pinpoint focusing.

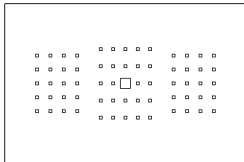

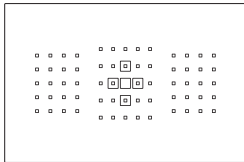

#### **Single-point AF (Manual selection)**

Select one AF point to focus.



#### **AF point expansion (Manual selection )**

The manually-selected AF point <> and four adjacent AF points < > (above, below, on the left, and on the right) are used to focus.

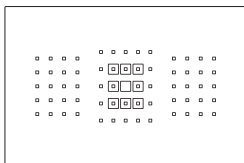

### **AF point expansion (Manual selection, surrounding points)**

The manually-selected AF point <□> and the surrounding AF points <◻> are used to focus.

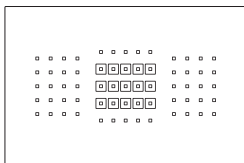

### **Zone AF (Manual selection of zone)**

One of nine zones is used to focus.

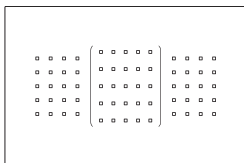

### **( ) Large Zone AF (Manual selection of zone)**

One of three zones (left, center, or right) is used to focus.

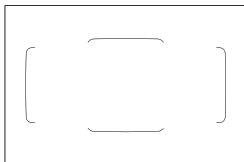

### **( ) 65-point automatic selection AF**

The Area AF frame (entire AF area) is used to focus. **This mode is set automatically in the <A+> mode.**

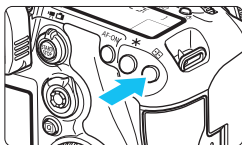

## Selecting the AF Area Selection Mode



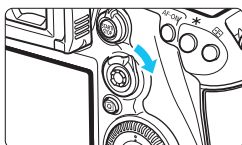



1 Press the  button. (P.6)

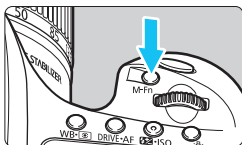

2 Operate the  or **<M-Fn>** button.

- Look through the viewfinder and operate the  or **<M-Fn>** button.
- Each time you tilt  to the right, the AF area selection mode changes.
- Each time you press the **<M-Fn>** button, the AF area selection mode changes.



- With [**AF4: Select AF area selec. mode**], you can limit the selectable AF area selection modes (p.124).
- If you set [**AF4: AF area selection method**] to [ → **Main Dial**], you can select the AF area selection mode by pressing the  button, then turning the  dial (p.125).



## Selecting the AF Point Manually

You can manually select the AF point or zone.

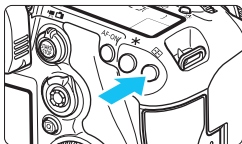

### 1 Press the **<AF-ON>** button.

- ▶ The AF points will be displayed in the viewfinder.
- In AF point expansion modes, adjacent AF points will also be displayed.
- In the Zone AF mode, the selected zone will be displayed.

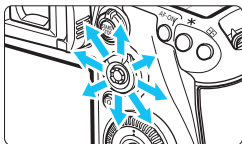

### 2 Select an AF point.

- The AF point selection will change in the direction you tilt **<AF-ON>**. If you press **<AF-ON>** straight down, the center AF point (or center zone) will be selected.
- You can also select a horizontal AF point by turning the **<AF-ON>** dial and select a vertical AF point by turning the **<AF-ON>** dial.
- In the Zone AF mode, turning the **<AF-ON>** or **<AF-ON>** dial will change the zone in a looping sequence.

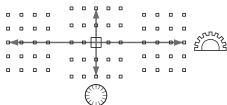

- When [**AF4: Initial AF pt**, **AI Servo AF**] is set to [**Initial AF pt selected**] (p.127), you can use this method to manually select the AI Servo's AF starting position.
- When you press the **<AF-ON>** button, the LCD panel displays the following:
  - 65-point automatic selection AF, Zone AF, Large Zone AF: **[AF]** AF
  - Single-point Spot AF, Single-point AF, and AF point expansion: **SEL [ ]** (Center)/**SEL AF** (Off-center)
- With [**AF5: Manual AF pt. selec. pattern**], you can set either [**Stops at AF area edges**] or [**Continuous**] (p.129).

## AF Point Display Indications

Pressing the <> button lights up the AF points that are cross-type AF points for high-precision autofocusing. The blinking AF points are horizontal-line or vertical-line sensitive. For details, see pages 99-103.

## Registering the AF point

You can register a frequently-used AF point to the camera.

When you use the button or lever set with the [ **3: Custom Controls**] (p.445) menu's detailed settings screens for [**Metering and AF start**], [**Switch to registered AF point**], [**Selected AFpt ↔ Cent/Reg AFpt**], [**Direct AF point selection**], or [**Register/recall shooting func**], you can instantly switch from the current AF point to the registered AF point. For details on registering the AF point, see page 450.

# AF Area Selection Modes ☆

## ▣ Single-point Spot AF (Manual selection)

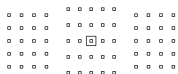

For pinpoint focusing over a narrower area than with single-point AF (manual selection). Select one AF point <▣> to focus.

Effective for pinpoint focusing or focusing overlapping subjects such as an animal in a cage. Since Single-point Spot AF (manual selection) covers a very small area, focusing may be difficult during hand-held shooting or for a moving subject.

## □ Single-point AF (Manual selection)



Select one AF point <□> to be used for focusing.

## ◻ AF point expansion (Manual selection ◻)

The manually-selected AF point <□> and adjacent AF points <◻> (above, below, on the left and on the right) are used to focus. Effective when it is difficult to track a moving subject with just one AF point. With AI Servo AF, the initial manually-selected AF point <□> must focus-track the subject first. However, it is superior to Zone AF in focusing on the target subject.

With One-Shot AF, when focus is achieved with expanded AF points, the expanded AF points <◻> will also be displayed along with the manually-selected AF point <□>.



## AF point expansion (Manual selection, surrounding points)

The manually-selected AF point <□> and surrounding AF points <□> are used to focus. The AF point expansion is larger than with AF point expansion (manual selection=□), so the focusing is executed over a wider area. Effective when it is difficult to track a moving subject with just one AF point.

AI Servo AF and One-Shot AF work in the same way as with AF point expansion (manual selection=□) mode (p.95).



## Zone AF (Manual selection of zone)

The AF area is divided into nine focusing zones for focusing. All the AF points in the selected zone are used for the automatic AF point selection. It is superior to single-point AF or AF point expansion in achieving focus, and it is effective for moving subjects.

However, since it is inclined to focus on the nearest subject, focusing on a specific target may be more difficult than with single-point AF or AF point expansion.

The AF point(s) achieving focus is displayed as <□>.

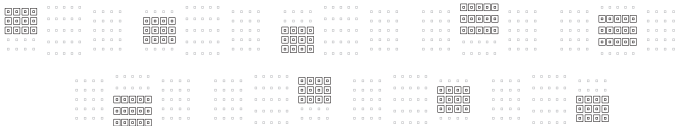

## [ ] Large Zone AF (Manual selection of zone)

The AF area is divided into three focusing zones (left, center, and right) for focusing. Since the focusing area is larger than with Zone AF, it is superior in focusing on the subject. Since auto selection AF is used, it is superior to single-point AF or AF point expansion in achieving focus, making it effective for moving subjects.

However, since it is inclined to focus on the nearest subject, focusing on a specific target may be more difficult than with single-point AF.

The AF point(s) achieving focus is displayed as <□>.



## [ ] 65-point automatic selection AF

The Area AF frame (entire AF area) is used to focus. This mode is set automatically in the <A+> mode.

With One-Shot AF, pressing the shutter button halfway will display the AF point(s) <□> that achieved focus. If multiple AF points are displayed, it means they all have achieved focus. This mode tends to focus on the nearest subject.

With AI Servo AF, you can set the AI Servo AF's starting position with [Initial AF pt, [ ] AI Servo AF] (p.127). As long as the Area AF frame can track the subject during shooting, focusing will continue.

The AF point(s) achieving focus is displayed as <□>.



- When AI Servo AF mode is set with 65-point automatic selection AF, Large Zone AF (manual selection of zone), or Zone AF (manual selection of zone), the active AF point <□> will keep switching to track the subject. However, under certain shooting conditions (such as when the subject is small), it may not be able to track the subject. Also, in low temperatures, the tracking response may become slower.
- With Single-point Spot AF (manual selection), focusing with the Speedlite's AF-assist beam may be difficult.
- If a peripheral AF point or a wide-angle lens is used, achieving focus may be difficult with an EOS-dedicated, external Speedlite's AF-assist beam. In such a case, use an AF point closer to the center.
- When the AF point(s) light up, part or all of the viewfinder may light up in red. This is a characteristic of AF point display (using liquid crystal).
- In low temperatures, the AF point's display may be difficult to see. This is a characteristic of AF point display (using liquid crystal).



- With [**AF4: Orientation linked AF point**], you can set the AF area selection mode + AF point (or only the AF point) separately for the horizontal and vertical orientations (p.125).
- With [**AF4: Selectable AF point**], you can change the number of manually selectable AF points (p.123).

## AF Sensor

The camera's AF sensor has 65 AF points. The illustration below shows the AF sensor pattern corresponding to each AF point. With  $f/2.8$  or larger maximum aperture lenses, high-precision AF is possible with the center AF point.



**Depending on the lens attached to the camera, the number of usable AF points and AF pattern will differ. For details, see pages 100-107.**

### Diagram

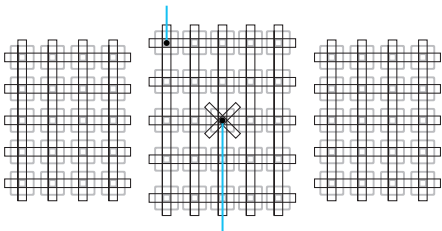
Cross-type focusing:  $f/5.6$  vertical +  $f/5.6$  horizontal



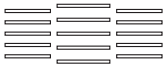



Dual cross-type focusing:  
 $f/2.8$  right diagonal +  $f/2.8$  left diagonal  
 $f/5.6$  vertical +  $f/5.6$  horizontal

	<p>The focusing sensor is geared to obtain higher precision focusing with <math>f/2.8</math> or larger maximum aperture lenses. A diagonal cross pattern makes it easier to focus on subjects difficult for AF. It is provided at the center AF point.</p>
	<p>The focusing sensor is geared for <math>f/5.6</math> or larger maximum aperture lenses. Since it has a horizontal pattern, it can detect vertical lines. It covers all 65 AF points. The center AF point and the adjacent AF points at the top and bottom are compatible with <math>f/8</math> or larger maximum-aperture lenses.</p>
	<p>The focusing sensor is geared for <math>f/5.6</math> or larger maximum aperture lenses. Since it has a vertical pattern, it can detect horizontal lines. It covers all 65 AF points. The center AF point and the adjacent AF points on the left and on the right are compatible with <math>f/8</math> or larger maximum-aperture lenses.</p>

# Lenses and Usable AF Points

- Although the camera has 65 AF points, **the number of usable AF points and focusing patterns will differ depending on the lens. The lenses are thereby classified into seven groups from A to G.**
- **When using a lens in Groups E to G, fewer AF points will be usable.**
- **See which group each lens belongs to on pages 104-107. Check which group the lens in use belongs to.**

- When you press the  button, the AF points indicated by the  mark will blink (The / AF points will stay lit). Regarding lighting up or blinking of the AF points, see page 94.
- Regarding new lenses marketed after the sales start of EOS 7D Mark II in the second half of 2014, check the Canon website to see which group they belong to.
- Some lenses may not be available in certain countries or regions.

## Group A

Autofocusing with 65 points is possible. All the AF area selection modes are selectable.

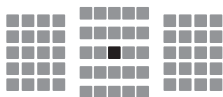

- : Dual cross-type AF point. Subject tracking is superior and the focusing precision is higher than with other AF points.
- : Cross-type AF point. Subject tracking is superior and high-precision focusing is achieved.



## Group B

Autofocusing with 65 points is possible. All the AF area selection modes are selectable.

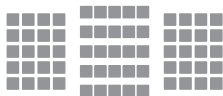

- : Cross-type AF point. Subject tracking is superior and high-precision focusing is achieved.

## Group C

Autofocusing with 65 points is possible. All the AF area selection modes are selectable.

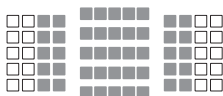

- : Cross-type AF point. Subject tracking is superior and high-precision focusing is achieved.
- : AF points sensitive to horizontal lines.

## Group D

Autofocusing with 65 points is possible. All the AF area selection modes are selectable.

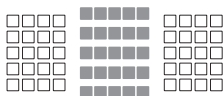

- : Cross-type AF point. Subject tracking is superior and high-precision focusing is achieved.
- : AF points sensitive to horizontal lines.

## Group E

Autofocusing with only 45 points is possible. (Not possible with all 65 AF points.) All the AF area selection modes are selectable. During automatic AF point selection, the outer frame marking the AF area (Area AF frame) will be different from 65-point automatic selection AF.

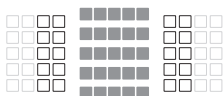

- : Cross-type AF point. Subject tracking is superior and high-precision focusing is achieved.
- : AF points sensitive to horizontal lines.
- : Disabled AF points (not displayed).

## Group F

Autofocusing with only 45 points is possible. (Not possible with all 65 AF points.) All the AF area selection modes are selectable. During automatic AF point selection, the outer frame marking the AF area (Area AF frame) will be different from 65-point automatic selection AF.

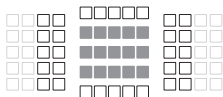

- : Cross-type AF point. Subject tracking is superior and high-precision focusing is achieved.
- : AF points sensitive to vertical lines (AF points in the horizontal array at the top and bottom) or horizontal lines (AF points in a vertical array on the left and right).
- : Disabled AF points (not displayed).

## Group G

AF is possible with the center AF point and the adjacent AF points above, below, on the left, and on the right. Only the following AF area selection modes are selectable: Single-point AF (manual selection), Single-point Spot AF (manual selection), and AF point expansion (manual selection  $\text{☐}^{\text{☐}}$ ).

If an Extender is attached to the lens and the maximum aperture is  $f/8$  (between  $f/5.6$  and  $f/8$ ), AF will be possible.

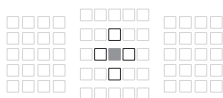

- : Cross-type AF point. Subject tracking is superior and high-precision focusing is achieved.
- ☐: AF point sensitive to vertical lines (top and bottom AF points adjacent to the center AF point) or horizontal lines (left and right AF points adjacent to the center AF point).  
Not manually selectable. It works only when “AF point expansion (manual selection  $\text{☐}^{\text{☐}}$ )” is selected.
- ☐: Disabled AF points (not displayed).



- If the maximum aperture is smaller than  $f/5.6$  (maximum aperture number is between  $f/5.6$  and  $f/8$ ), focus may not be achieved with AF when shooting low-contrast or low-light subjects.
- When Extender EF2x is attached to the EF180mm  $f/3.5L$  Macro USM lens, AF is not possible.
- If the maximum aperture is smaller than  $f/8$  (maximum aperture number exceeds  $f/8$ ), AF is not possible during viewfinder shooting.

## Lens Group Designations

EF-S24mm f/2.8 STM	A
EF-S60mm f/2.8 Macro USM	B
EF-S10-18mm f/4.5-5.6 IS STM	E
EF-S10-22mm f/3.5-4.5 USM	C
EF-S15-85mm f/3.5-5.6 IS USM	B
EF-S17-55mm f/2.8 IS USM	A
EF-S17-85mm f/4-5.6 IS USM	B
EF-S18-55mm f/3.5-5.6	C
EF-S18-55mm f/3.5-5.6 USM	C
EF-S18-55mm f/3.5-5.6 II	C
EF-S18-55mm f/3.5-5.6 II USM	C
EF-S18-55mm f/3.5-5.6 III	C
EF-S18-55mm f/3.5-5.6 IS	C
EF-S18-55mm f/3.5-5.6 IS II	C
EF-S18-55mm f/3.5-5.6 IS STM	C
EF-S18-135mm f/3.5-5.6 IS	B
EF-S18-135mm f/3.5-5.6 IS USM	B
EF-S18-135mm f/3.5-5.6 IS STM	B
EF-S18-200mm f/3.5-5.6 IS	B
EF-S55-250mm f/4-5.6 IS	B
EF-S55-250mm f/4-5.6 IS II	B
EF-S55-250mm f/4-5.6 IS STM	B
EF14mm f/2.8L USM	A
EF14mm f/2.8L II USM	A
EF15mm f/2.8 Fisheye	A
EF20mm f/2.8 USM	A
EF24mm f/1.4L USM	A
EF24mm f/1.4L II USM	A
EF24mm f/2.8	A
EF24mm f/2.8 IS USM	A
EF28mm f/1.8 USM	A
EF28mm f/2.8	A
EF28mm f/2.8 IS USM	A
EF35mm f/1.4L USM	A
EF35mm f/1.4L II USM	A
EF35mm f/2	A
EF35mm f/2 IS USM	A
EF40mm f/2.8 STM	A
EF50mm f/1.0L USM	A
EF50mm f/1.2L USM	A
EF50mm f/1.4 USM	A
EF50mm f/1.8	A
EF50mm f/1.8 II	A
EF50mm f/1.8 STM	A
EF50mm f/2.5 Compact Macro	B

EF50mm f/2.5 Compact Macro + LIFE SIZE Converter	B
EF85mm f/1.2L USM	A
EF85mm f/1.2L II USM	A
EF85mm f/1.8 USM	A
EF100mm f/2 USM	A
EF100mm f/2.8 Macro	B
EF100mm f/2.8 Macro USM	E
EF100mm f/2.8L Macro IS USM	B
EF135mm f/2L USM	A
EF135mm f/2L USM + Extender EF1.4x	A
EF135mm f/2L USM + Extender EF2x	B
EF135mm f/2.8 (Softfocus)	A
EF180mm f/3.5L Macro USM	B
EF180mm f/3.5L Macro USM + Extender EF1.4x	F
EF200mm f/1.8L USM	A
EF200mm f/1.8L USM + Extender EF1.4x	A*
EF200mm f/1.8L USM + Extender EF2x	B*
EF200mm f/2L IS USM	A
EF200mm f/2L IS USM + Extender EF1.4x	A
EF200mm f/2L IS USM + Extender EF2x	B
EF200mm f/2.8L USM	A
EF200mm f/2.8L USM + Extender EF1.4x	B
EF200mm f/2.8L USM + Extender EF2x	B
EF200mm f/2.8L II USM	A
EF200mm f/2.8L II USM + Extender EF1.4x	B
EF200mm f/2.8L II USM + Extender EF2x	B
EF300mm f/2.8L USM	A
EF300mm f/2.8L USM + Extender EF1.4x	B*
EF300mm f/2.8L USM + Extender EF2x	B*
EF300mm f/2.8L IS USM	A
EF300mm f/2.8L IS USM + Extender EF1.4x	B

EF300mm f/2.8L IS USM + Extender EF2x	B	EF400mm f/5.6L USM + Extender EF1.4x	G (f/8)
EF300mm f/2.8L IS II USM	A	EF500mm f/4L IS USM	B
EF300mm f/2.8L IS II USM + Extender EF1.4x	B	EF500mm f/4L IS USM + Extender EF1.4x	B
EF300mm f/2.8L IS II USM + Extender EF2x	B	EF500mm f/4L IS USM + Extender EF2x	G (f/8)
EF300mm f/4L USM	B	EF500mm f/4L IS II USM	B
EF300mm f/4L USM + Extender EF1.4x	B	EF500mm f/4L IS II USM + Extender EF1.4x	B
EF300mm f/4L USM + Extender EF2x	G (f/8)	EF500mm f/4L IS II USM + Extender EF2x	G (f/8)
EF300mm f/4L IS USM	B	EF500mm f/4.5L USM	B
EF300mm f/4L IS USM + Extender EF1.4x	B	EF500mm f/4.5L USM + Extender EF1.4x	G (f/8)*
EF300mm f/4L IS USM + Extender EF2x	G (f/8)	EF600mm f/4L USM	B
EF400mm f/2.8L USM	A	EF600mm f/4L USM + Extender EF1.4x	B*
EF400mm f/2.8L USM + Extender EF1.4x	B*	EF600mm f/4L USM + Extender EF2x	G (f/8)*
EF400mm f/2.8L USM + Extender EF2x	B*	EF600mm f/4L IS USM	B
EF400mm f/2.8L II USM	A	EF600mm f/4L IS USM + Extender EF1.4x	B
EF400mm f/2.8L II USM + Extender EF1.4x	B*	EF600mm f/4L IS USM + Extender EF2x	G (f/8)
EF400mm f/2.8L II USM + Extender EF2x	B*	EF600mm f/4L IS II USM	B
EF400mm f/2.8L IS USM	A	EF600mm f/4L IS II USM + Extender EF1.4x	B
EF400mm f/2.8L IS USM + Extender EF1.4x	B	EF600mm f/4L IS II USM + Extender EF2x	G (f/8)
EF400mm f/2.8L IS USM + Extender EF2x	B	EF800mm f/5.6L IS USM	E
EF400mm f/2.8L IS II USM	A	EF800mm f/5.6L IS USM + Extender EF1.4x	G (f/8)
EF400mm f/2.8L IS II USM + Extender EF1.4x	B	EF1200mm f/5.6L USM	E
EF400mm f/2.8L IS II USM + Extender EF2x	B	EF1200mm f/5.6L USM + Extender EF1.4x	G (f/8)*
EF400mm f/4 DO IS USM	B	EF8-15mm f/4L Fisheye USM	B
EF400mm f/4 DO IS USM + Extender EF1.4x	B	EF11-24mm f/4L USM	C
EF400mm f/4 DO IS USM + Extender EF2x	G (f/8)	EF16-35mm f/2.8L USM	A
EF400mm f/4 DO IS II USM	B	EF16-35mm f/2.8L II USM	A
EF400mm f/4 DO IS II USM + Extender EF1.4x	B	EF16-35mm f/2.8L III USM	A
EF400mm f/4 DO IS II USM + Extender EF2x	G (f/8)	EF16-35mm f/4L IS USM	B
EF400mm f/4 DO IS II USM	B	EF17-35mm f/2.8L USM	A
EF400mm f/4 DO IS II USM + Extender EF1.4x	B	EF17-40mm f/4L USM	B
EF400mm f/4 DO IS II USM + Extender EF2x	G (f/8)	EF20-35mm f/2.8L	A
EF400mm f/5.6L USM	B	EF20-35mm f/3.5-4.5 USM	C
		EF22-55mm f/4-5.6 USM	F
		EF24-70mm f/2.8L USM	A

EF24-70mm f/2.8 II USM	A	EF55-200mm f/4.5-5.6 USM	D
EF24-70mm f/4L IS USM	B	EF55-200mm f/4.5-5.6 II USM	D
EF24-85mm f/3.5-4.5 USM	D	EF70-200mm f/2.8L USM	A
EF24-105mm f/3.5-5.6 IS STM	B	EF70-200mm f/2.8L USM + Extender EF1.4x	B*
EF24-105mm f/4L IS USM	B	EF70-200mm f/2.8L USM + Extender EF2x	B*
EF24-105mm f/4L IS II USM	B	EF70-200mm f/2.8L IS USM	A
EF28-70mm f/2.8L USM	A	EF70-200mm f/2.8L IS USM + Extender EF1.4x	B
EF28-70mm f/3.5-4.5	E	EF70-200mm f/2.8L IS USM + Extender EF2x	B
EF28-70mm f/3.5-4.5 II	E	EF70-200mm f/2.8L IS II USM	A
EF28-80mm f/2.8-4L USM	B	EF70-200mm f/2.8L IS II USM + Extender EF1.4x	B
EF28-80mm f/3.5-5.6	E	EF70-200mm f/2.8L IS II USM + Extender EF2x	B
EF28-80mm f/3.5-5.6 USM	E	EF70-200mm f/2.8L IS II USM	A
EF28-80mm f/3.5-5.6 II	E	EF70-200mm f/2.8L IS II USM + Extender EF1.4x	B
EF28-80mm f/3.5-5.6 II USM	E	EF70-200mm f/2.8L IS II USM + Extender EF2x	B
EF28-80mm f/3.5-5.6 III USM	E	EF70-200mm f/4L USM	B
EF28-80mm f/3.5-5.6 IV USM	E	EF70-200mm f/4L IS USM	B
EF28-80mm f/3.5-5.6 V USM	E	EF70-200mm f/4L IS USM + Extender EF1.4x	B
EF28-90mm f/4-5.6	B	EF70-200mm f/4L IS USM + Extender EF2x	G (f/8)
EF28-90mm f/4-5.6 USM	B	EF70-200mm f/4L IS USM	B
EF28-90mm f/4-5.6 II	B	EF70-200mm f/4L IS USM + Extender EF1.4x	B
EF28-90mm f/4-5.6 II USM	B	EF70-200mm f/4L IS USM + Extender EF2x	G (f/8)
EF28-90mm f/4-5.6 III	B	EF70-210mm f/3.5-4.5 USM	B
EF28-105mm f/3.5-4.5 USM	B	EF70-210mm f/4	B
EF28-105mm f/3.5-4.5 II USM	B	EF70-300mm f/4-5.6 IS USM	B
EF28-105mm f/4-5.6	F	EF70-300mm f/4-5.6 IS II USM	B
EF28-105mm f/4-5.6 USM	F	EF70-300mm f/4-5.6L IS USM	B
EF28-135mm f/3.5-5.6 IS USM	B	EF70-300mm f/4.5-5.6 DO IS USM	B
EF28-200mm f/3.5-5.6	B	EF75-300mm f/4-5.6	B
EF28-200mm f/3.5-5.6 USM	B	EF75-300mm f/4-5.6 USM	C
EF28-300mm f/3.5-5.6L IS USM	B	EF75-300mm f/4-5.6 II	B
EF35-70mm f/3.5-4.5	E	EF75-300mm f/4-5.6 II USM	B
EF35-70mm f/3.5-4.5A	E	EF75-300mm f/4-5.6 III	B
EF35-80mm f/4-5.6	F	EF75-300mm f/4-5.6 III USM	B
EF35-80mm f/4-5.6 PZ	E	EF75-300mm f/4-5.6 IS USM	B
EF35-80mm f/4-5.6 USM	F	EF80-200mm f/2.8L	A
EF35-80mm f/4-5.6 II	E	EF80-200mm f/4.5-5.6	D
EF35-80mm f/4-5.6 III	F	EF80-200mm f/4.5-5.6 USM	E
EF35-105mm f/3.5-4.5	B	EF80-200mm f/4.5-5.6 II	E
EF35-105mm f/4.5-5.6	G	EF90-300mm f/4.5-5.6	D
EF35-105mm f/4.5-5.6 USM	G	EF90-300mm f/4.5-5.6 USM	D
EF35-135mm f/3.5-4.5	B		
EF35-135mm f/4-5.6 USM	C		
EF35-350mm f/3.5-5.6L USM	D		
EF38-76mm f/4.5-5.6	E		
EF50-200mm f/3.5-4.5	B		
EF50-200mm f/3.5-4.5L	B		

EF100-200mm f/4.5A	B
EF100-300mm f/4.5-5.6 USM	C
EF100-300mm f/5.6	B
EF100-300mm f/5.6L	B
EF100-400mm f/4.5-5.6L IS USM	B
EF100-400mm f/4.5-5.6L IS USM + Extender EF1.4x	G (f/8)
EF100-400mm f/4.5-5.6L IS II USM	B
EF100-400mm f/4.5-5.6L IS II USM + Extender EF1.4x	G (F8)
EF200-400mm f/4L IS USM Extender 1.4x	B
EF200-400mm f/4L IS USM Extender 1.4x: With built-in Ext. 1.4x	B
EF200-400mm f/4L IS USM Extender 1.4x + Extender EF1.4x	B
EF200-400mm f/4L IS USM Extender 1.4x: With built-in Ext. 1.4x + Extender EF1.4x	G (f/8)
EF200-400mm f/4L IS USM Extender 1.4x + Extender EF2x	G (f/8)
TS-E17mm f/4L	B
TS-E24mm f/3.5L	B
TS-E24mm f/3.5L II	B
TS-E45mm f/2.8	A
TS-E90mm f/2.8	A



When using a lens and an Extender in the combination marked with \*, precise focus may not be achieved with AF. Refer to the instruction manual of the lens or Extender used.



- Both “Extender EF1.4x” and “Extender EF2x” apply to all the I/II/III models (under this grouping).
- If you use a TS-E lens, manual focusing will be required. The lens group designation of TS-E lenses applies only when you do not use tilt or shift function.

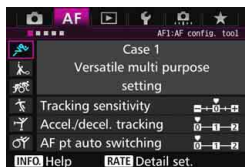

## MENU Selecting AI Servo AF Characteristics ☆

You can easily fine-tune AI Servo AF to suit a particular subject or scene just by selecting an option from case 1 to case 6. This feature is called the “AF Configuration Tool.”









### 1 Select the [AF 1] tab.

### 2 Select a case.

- Turn the <  > dial to select a case icon, then press <  >.
- ▶ The selected case will be set. The selected case is indicated in blue.

## Case 1 to 6

As explained on pages 113 to 115, case 1 to 6 are six setting combinations of “Tracking sensitivity”, “Acceleration/deceleration tracking”, and “AF point auto switching”. Refer to the table below to select the case applicable to the subject or scene.

Case	Icon	Description	Applicable Subjects	Page
Case 1		Versatile multi purpose setting	For any moving subject.	109
Case 2		Continue to track subjects, ignoring possible obstacles	Tennis players, butterfly swimmers, freestyle skiers, etc.	109
Case 3		Instantly focus on subjects suddenly entering AF points	Starting line of a bicycle race, alpine downhill skiers, etc.	110
Case 4		For subjects that accelerate or decelerate quickly	Soccer, motor sports, basketball, etc.	110
Case 5		For erratic subjects moving quickly in any direction	Figure skaters, etc.	111
Case 6		For subjects that change speed and move erratically	Rhythm gymnastics, etc.	112



## Case 1: Versatile multi purpose setting

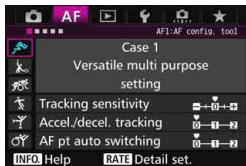

Standard setting suited for any moving subject. Works with many subjects and scenes.

Select [**Case 2**] to [**Case 6**] for the following: When an obstacle cuts across the AF points or the subject tends to stray from the AF points, when you want to focus on a subject appearing suddenly, when the speed of a moving subject changes suddenly, or when the subject dramatically moves horizontally or vertically.

### Default settings

- Tracking sensitivity: 0
- Accel./decel. tracking: 0
- AF pt auto switching: 0

## Case 2: Continue to track subjects, ignoring possible obstacles

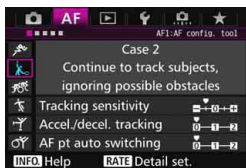

The camera will try to continue focusing on the subject even if an obstacle enters the AF points or if the subject strays from the AF points. Effective when there may be an obstacle blocking the subject or when you do not want to focus on the background.

### Default settings

- Tracking sensitivity: Locked on: -1
- Accel./decel. tracking: 0
- AF pt auto switching: 0

If an obstacle gets in the way or if the subject moves away from the AF points for a prolonged period and the default setting is unable to track the target subject, setting [**Tracking sensitivity**] to [-2] may give better results (p.113).

### Case 3: Instantly focus on subjects suddenly entering AF points

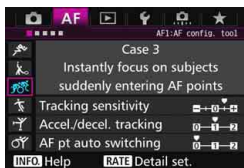

Once an AF point starts tracking the subject, this setting enables the camera to consecutively focus on subjects at different distances. If a new subject appears in front of the target subject, the camera will start focusing on the new subject. Also effective when you want to always focus on the closest subject.

#### Default settings

- Tracking sensitivity: Responsive: +1
- Accel./decel. tracking: +1
- AF pt auto switching: 0

If you want to quickly focus on a subject appearing suddenly, setting [**Tracking sensitivity**] to [+2] may give better results (p.113).

### Case 4: For subjects that accelerate or decelerate quickly

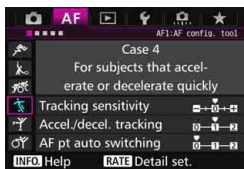

Geared for tracking moving subjects whose speed can change dramatically and suddenly. Effective for subjects having sudden movements, sudden acceleration, sudden deceleration, or sudden stops.

#### Default settings

- Tracking sensitivity: 0
- Accel./decel. tracking: +1
- AF pt auto switching: 0

If the subject is in motion, and prone to sudden, dramatic changes in speed, setting [**Accel./decel. tracking**] to [+2] may give better results (p.114).

## Case 5: For erratic subjects moving quickly in any direction

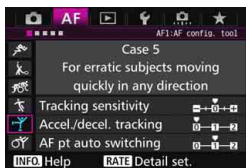

### Default settings

- Tracking sensitivity: 0
- Accel./decel. tracking: 0
- AF pt auto switching: +1

Even if the target subject moves dramatically up, down, left, or right, the AF point will switch automatically to focus-track the subject. Effective for shooting subjects that move dramatically up, down, left, or right.

It is recommended to use this setting with the following modes; AF point expansion (manual selection  $\square \square \square$ ), AF point expansion (manual selection, surrounding points), Zone AF (manual selection of zone), Large Zone AF (manual selection of zone), or 65-point automatic selection AF.

With Single-point Spot AF (manual selection) or Single-point AF (manual selection) mode, the tracking action will be the same as with Case 1.



If the subject moves even more dramatically up, down, left, or right, setting **[AF pt auto switching]** to **[+2]** may give better results (p.115).

## Case 6: For subjects that change speed and move erratically

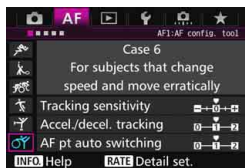

### Default settings

- Tracking sensitivity: 0
- Accel./decel. tracking: +1
- AF pt auto switching: +1

Geared for tracking moving subjects whose speed can change dramatically and suddenly. Also, if the target subject moves dramatically up, down, left or right and it is difficult to focus, the AF point switches automatically to track the subject.

It is recommended to use this setting with the following modes; AF point expansion (manual selection  $\square \square \square$ ), AF point expansion (manual selection of zone), Zone AF (manual selection of zone), Large Zone AF (manual selection of zone), or 65-point automatic selection AF.

With Single-point Spot AF (manual selection) or Single-point AF (manual selection) mode, the tracking action will be the same as with Case 4.

- If the subject is in motion, and prone to sudden, dramatic changes in speed, setting **[Accel./decel. tracking]** to **[+2]** may give better results (p.114).
- If the subject moves even more dramatically up, down, left, or right, setting **[AF pt auto switching]** to **[+2]** may give better results (p.115).

## Parameters

### ● Tracking sensitivity

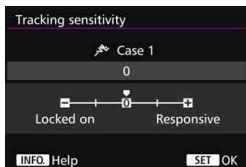

Sets the subject-tracking sensitivity during AI Servo AF when an obstacle enters the AF points or when the AF points stray from the subject.

0

Default setting. Suitable for moving subjects in general.

#### Locked on: -2 / Locked on: -1

The camera will try to continue focusing on the subject even if an obstacle enters the AF points or if the subject strays from the AF points. The -2 setting makes the camera track the target subject longer than with the -1 setting.

However, if the camera focuses on a wrong subject, it may take slightly longer to switch and focus on the target subject.

#### Responsive: +2 / Responsive: +1

The camera can focus consecutively on subjects at different distances that are covered by the AF points. Also effective when you want to always focus on the closest subject. The +2 setting is more responsive when focusing on the next subject than +1.

However, the camera will be more prone to focus on the wrong subject.



[Tracking sensitivity] is the feature named [AI Servo tracking sensitivity] in the EOS-1D Mark III/IV, EOS-1Ds Mark III, and EOS 7D.

## ● Acceleration/deceleration tracking

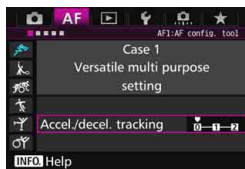

This sets the tracking sensitivity for moving subjects whose speed can suddenly change dramatically by starting or stopping suddenly, etc.

0

Suited for subjects that move at a steady speed (minimal change in moving speed).

+2 / +1

Effective for subjects having sudden movements, sudden acceleration/deceleration, or sudden stops. Even if the moving subject's speed suddenly changes dramatically, the camera continues to focus on the target subject. For example, for an approaching subject, the camera becomes less prone to focus behind it to avoid subject blur. For a subject stopping suddenly, the camera becomes less prone to focus in front of it. Setting +2 can track dramatic changes in the moving subject's speed better than with +1.

However, since the camera will be sensitive even to the slight movements of the subject, the focusing may momentarily become unstable.

## ● AF point auto switching

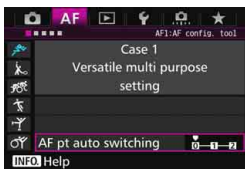

This sets the switching sensitivity of the AF points as they track the subject moving dramatically up, down, left, or right.

This setting takes effect when the AF area selection mode is set to AF point expansion (manual selection  $\square$ ), AF point expansion (manual selection, surrounding points), Zone AF (manual selection of zone), Large Zone AF (manual selection of zone), or 65-point automatic selection AF.

### 0

Standard setting for gradual AF point switching.

### +2 / +1

Even if the target subject moves dramatically up, down, left, or right and moves away from the AF point, the camera switches its focus to neighboring AF points to continue focusing on the subject. The camera switches to the AF point deemed most likely to focus on the subject based on the subject's continual movement, contrast, etc. Setting +2 makes the camera more prone to switch the AF point than with +1.

However, with a wide-angle lens having a wide depth of field or if the subject is too small in the frame, the camera may focus with the wrong AF point.

## Changing Cases' Parameter Settings

You can manually adjust each case's three parameters: 1. Tracking sensitivity, 2. Acceleration/deceleration tracking, and 3. AF point auto switching.

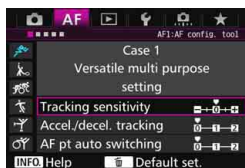

### 1 Select a case.

- Turn the <⌚> dial to select the icon of the case you want to adjust.

### 2 Press the <RATE> button.

- The selected parameter will have a purple frame.

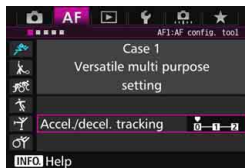

### 3 Select the parameter to adjust.

- Select the parameter to adjust, then press <ⓈET>.
- When Tracking sensitivity is selected, the setting screen will appear.

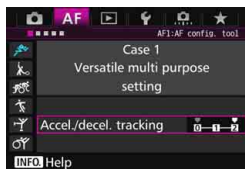

### 4 Make the adjustment.

- Adjust the setting, then press <ⓈET>.
- ▶ The adjustment is saved.
- The default setting is indicated by the light gray [■] mark.
- To return to the screen in step 1, press the <RATE> button.



- In step 2, if you press the <RATE> button and then press the <⌫> button, you can revert the 1, 2 and 3 parameter settings above for each case.
- You can also register the 1, 2, and 3 parameter settings to My Menu (p.459). Doing so will change the selected case's settings.
- When shooting with a case whose parameters you adjusted, select the adjusted case and then take the picture.



## MENU Customizing AF Functions ☆

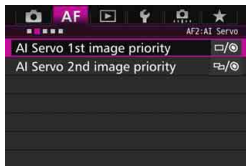

With the [AF2] to [AF5] menu tabs, you can set the AF functions to suit your shooting style or subject.

### AF2: AI Servo

#### AI Servo 1st image priority

You can set the AF operation characteristics and shutter-release timing for the first shot with AI Servo AF.

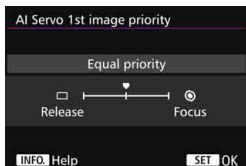

#### /☉: Equal priority

Equal priority is given to focusing and shutter release.

#### : Release priority

Pressing the shutter button takes the picture immediately even if focus has not been achieved. It is effective when you want to give priority to capturing the image rather than achieving focus.

#### ☉: Focus priority

Pressing the shutter button does not take the picture until focus is achieved. Effective when you want to achieve focus before capturing the image.

## AI Servo 2nd image priority

You can set the AF operation characteristics and shutter-release timing during continuous shooting after the first shot with AI Servo AF.

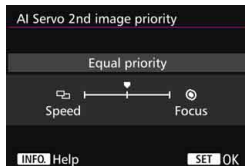

### **Equal priority**

Equal priority is given to focusing and continuous shooting speed. In low light or with low-contrast subjects, shooting speed may slow down.

### **Shooting speed priority**

Priority is given to the continuous shooting speed instead of achieving focus.

### **Focus priority**

Priority is given to achieving focus instead of the continuous shooting speed. The picture will not be taken until focus is achieved.

 Under shooting conditions which activate anti-flicker shooting (p.185), even if [**Shooting speed priority**] is set, the continuous shooting speed may become slightly slower or the shooting interval may become irregular.

## AF3: One Shot

### Lens electronic MF

With the following USM and STM lenses equipped with an electronic focusing ring, you can set whether to use electronic manual focusing.

EF-S18-135mm f/3.5-5.6 IS USM	EF300mm f/2.8L USM	EF1200mm f/5.6L USM
EF50mm f/1.0 L USM	EF400mm f/2.8L USM	EF28-80mm f/2.8-4L USM
EF85mm f/1.2L USM	EF400mm f/2.8 II USM	EF70-300mm f/4-5.6 IS II USM
EF85mm f/1.2L II USM	EF500mm f/4.5L USM	
EF200mm f/1.8L USM	EF600mm f/4L USM	
EF-S24mm f/2.8 STM	EF-S18-135mm f/3.5-5.6 IS STM	EF50mm f/1.8 STM
EF-S10-18mm f/4.5-5.6 IS STM	EF-S55-250mm f/4-5.6 IS STM	EF24-105mm f/3.5-5.6 IS STM
EF-S18-55mm f/3.5-5.6 IS STM	EF40mm f/2.8 STM	

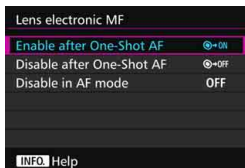

#### ☞ON: Enable after One-Shot AF

After AF operates, if you keep pressing the shutter button halfway, you can adjust the focus manually.

#### ☞OFF: Disable after One-Shot AF

After AF operates, manual focusing adjustment is disabled.

### OFF: Disable in AF mode

When the lens's focus mode switch is set to <AF>, manual focusing is disabled.

## AF-assist beam firing

Enables or disables the AF-assist beam from the built-in flash or EOS-dedicated external Speedlite.

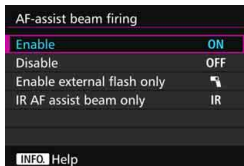

### ON: Enable

The AF-assist beam is emitted when necessary.

### OFF: Disable

The AF-assist beam is not emitted. Prevents the AF-assist beam from disturbing others.

### : Enable external flash only

The AF-assist beam will be emitted when necessary only if an external Speedlite is used. The camera's built-in flash will not fire the AF-assist beam.

### IR: IR AF assist beam only

When an external Speedlite is attached, only infrared AF-assist beam will be emitted. This prevents the AF-assist light from firing as a burst of small flashes.

With an EX-series Speedlite equipped with an LED light, the LED light will not automatically turn on for AF-assist.

If an external Speedlite's [AF-assist beam firing] Custom Function is set to [Disabled], the Speedlite will not emit the AF-assist beam regardless of this setting.

## One-Shot AF release priority

You can set the AF operation characteristics and shutter-release timing for One-Shot AF.

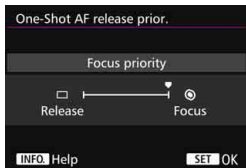

### Focus priority

The picture will not be taken until focus is achieved. Effective when you want to achieve focus before capturing the shot.

### Release priority

Priority is given to taking the picture instead of achieving focus. This gives priority to getting the shot rather than achieving correct focus.

**Note that the picture will be taken even if focus has not been achieved.**

## AF4

## Lens drive when AF impossible

If focus cannot be achieved with autofocus, you can have the camera keep searching for the correct focus or have it stop searching.

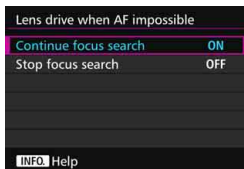
**ON: Continue focus search**

If focus cannot be achieved with autofocus, the lens is driven to search for the correct focus.

**OFF: Stop focus search**

If autofocus starts and the focus is far off or if focus cannot be achieved, the lens drive stops. This prevents the lens from becoming grossly out of focus due to focus searching.

 Super telephoto lenses, etc., with a wide focusing drive range can become grossly out of focus during focus search, taking more time to achieve focus next time. Setting [**Stop focus search**] is recommended.

## Selectable AF point

You can change the number of manually selectable AF points. If 65-point automatic selection AF is set, the Area AF frame (entire AF area) will be used for AF regardless of the setting below.

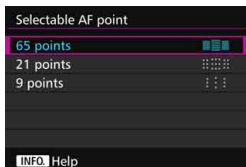

### : **65 points**

All 65 AF points will be manually selectable.

### : **21 points**

Twenty-one major AF points will be manually selectable.



### : **9 points**

Nine major AF points will be manually selectable.



With a lens from Groups E to G (p.102-103), the number of manually selectable AF points will be fewer.



- Even with settings other than **[65 points]**, AF point expansion (manual selection ) , AF point expansion (manual selection, surrounding points), Zone AF (manual selection of zone) and Large Zone AF (manual selection of zone) are still possible.
- When you press the  button, the AF points which are not manually selectable will not be displayed in the viewfinder.

## Select AF area selection mode

You can limit the selectable AF area selection modes to suit your shooting preferences. Select the desired selection mode and press **<SET>** to append a checkmark **<√>**. Then select **[OK]** to register the setting.

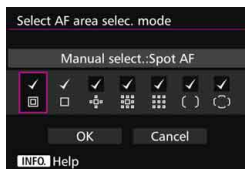

### **Manual select.:Spot AF**

For pinpoint focusing with a narrower area than single-point AF (manual selection).

### **Manual selection:1 pt AF**

One of the AF points set by **[Selectable AF point]** setting can be selected.

### **Expand AF area:**

The camera will focus with the manually-selected AF point and the adjacent AF points (above, below, on the left, and on the right).

### **Expand AF area:Surround**

The camera will focus with the manually-selected AF point and the surrounding AF points.

### **Manual select.:Zone AF**



The AF area is divided into nine focusing zones for focusing.

### **Manual select.:Large Zone AF**

The AF area is divided into three focusing zones for focusing.

### **Auto selection:65 pt AF**

The Area AF frame (entire AF area) is used for focusing.

-  The **<√>** mark cannot be deleted from **[Manual selection:1 pt AF]**.
-  If the attached lens belongs to group G (p.103), you can only select **[Manual select.:Spot AF]**, **[Manual selection:1 pt AF]**, and **[Expand AF area:**  **]**.



## AF area selection method

You can set the method for changing the AF area selection mode.

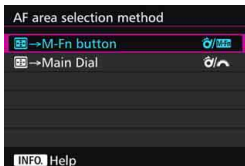

### /M-Fn: → **M-Fn button**

After you press the < > button, operating the < > or <M-Fn > button changes the AF area selection mode.

### /: → **Main Dial**

After you press the < > button, operating the < > or < > dial changes the AF area selection mode.

When [ → **Main Dial**] is set, use the < > to move the AF point horizontally.

## Orientation linked AF point

You can set the AF point or the AF area selection mode + AF point separately for vertical shooting and horizontal shooting.

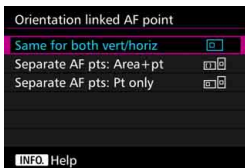

### : **Same for both vert/horiz**

The same AF area selection mode and manually-selected AF point (or zone) are used for both vertical shooting and horizontal shooting.

**☐☐: Separate AF pts: Area+pt**

The AF area selection mode and AF point (or zone) can be set separately for each camera orientation (1. Horizontal, 2. Vertical with the camera grip at the top, 3. Vertical with the camera grip at the bottom).

When you manually select the AF area selection mode and AF point (or zone) for each of the three camera orientations, they will be set for the respective orientation. Whenever you change the camera orientation during shooting, the camera will switch to the AF area selection mode and manually-selected AF point (or zone) set for that orientation.

**☐☐: Separate AF pts: Pt only**

The AF point can be set separately for each camera orientation (1. Horizontal, 2. Vertical with the camera grip at the top, 3. Vertical with the camera grip at the bottom). While using the same AF area selection mode, the AF point will switch automatically for the respective camera orientation.

When you manually select the AF point for each of the three camera orientations, it will be recorded for the respective orientation. During shooting, the manually-selected AF point will switch to match the respective camera orientation. Even if you change the AF area selection mode to Manual select.:Spot AF, Manual selection:1 pt AF, Expand AF area:☐☐, or Expand AF area:Surround, the AF point set for the respective orientation will be retained.

If you change the AF area selection mode to Zone AF (manual selection of zone) or Large Zone AF (manual selection of zone), the zone will switch to match the respective camera orientation.

- If you clear the camera settings to their defaults (p.70), the setting will be [**Same for both vert/horiz**]. Also, your settings for the three camera orientations (1, 2 and 3) will be cleared and all three will revert to Single-point AF (Manual selection) with the center AF point selected.
- If you set this and later attach a lens from a different AF group (p.100-103, particularly Group G), the setting may be cleared.

## Initial AF Point, (C) AI Servo AF

You can set the AI Servo AF's starting AF point for when the AF area selection mode is set to Auto selection: 65 pt AF.

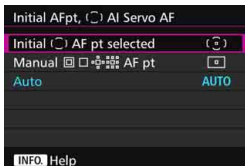

### (C): Initial (C) AF pt selected

AI Servo AF will start with the manually-selected AF point when the AF operation is set to AI Servo AF and the AF area selection mode is set to Auto selection: 65 pt AF.

### [icon]: Manual [icon] AF pt

If you switch from Manual select.:Spot AF, Manual selection:1 pt AF, Expand AF area: [icon], or Expand AF area:Surround to Auto selection: 65 pt AF, AI Servo AF will start with the AF point that was manually selected before the switch. Convenient if you want AI Servo AF to start with the AF point which was selected before the AF area selection mode was switched to Auto selection: 65 pt AF. After you set the AF area selection mode to Auto selection: 65 pt AF with the [Custom Controls] menu's [Metering and AF start] (p.450), [Switch to registered AF func.] (p.452), or [Register/recall shooting func] (p.457), you can press the assigned button during Manual select: Spot AF, Manual selection: 1 pt AF, Expand AF area: [icon], or Expand AF area: Surround to switch to AI Servo AF using Auto selection: 65 pt AF instead of the AF point used immediately before.

## AUTO: Auto

The AF point which AI Servo AF starts with is set automatically to suit the shooting conditions.



When [Manual [icon] AF pt] is set, AI Servo AF will start with the zone that corresponds to the manually selected AF point, even if you switch AF area selection mode to Zone AF (manual selection of zone) or Large Zone AF (manual selection of zone).

## Auto AF point selection: EOS iTR AF

EOS iTR\* AF executes autofocus by recognizing faces and subject colors. EOS iTR AF works when the AF area selection mode is set to Zone AF (manual selection of zone), Large Zone AF (manual selection of zone), or 65-point automatic selection AF.

\* intelligent Tracking and Recognition: The metering sensor recognizes the subject and the AF points track it.



### ON: Enable

The AF point is automatically selected based not only on AF information, but also faces and other details.

In AI Servo AF mode, the camera remembers the color at the position it focused on first, then continues to track and focus the subject by switching AF points to track that color. This makes it easier to keep track of the subject than when only AF information is available. In One-Shot AF mode, EOS iTR AF makes focusing on people easier, so you can prioritize composition.

### OFF: Disable

AF points are automatically selected based only on AF information. (The AF will not use information based on faces, subject colors and other details.)

- If **[Enable]** is set, the camera will take longer to focus than when **[Disable]** is set.
- When EOS iTR AF is operating, maximum continuous shooting speed with <[H]> set will be approx. 9.5 shots/sec. Also, under low-light conditions, the continuous shooting speed may decrease.
- Even if you set **[Enable]**, expected result may not be obtained depending on the shooting conditions and subject.
- Under light so low that the flash emits the AF-assist beam automatically, AF points are selected automatically based only on AF information.
- Face detection may not work if the face is small or under low-light conditions.

## AF5

### Manual AF point selection pattern

During manual AF point selection, the selection can either stop at the outer edge or it can cycle around to the opposite side. This function works in AF area selection modes other than Zone AF (manual selection of zone), Large Zone AF (manual selection of zone), and 65-point automatic selection AF (works with AI Servo AF).

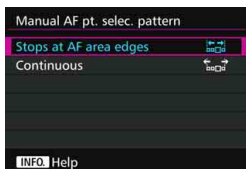

#### : **Stops at AF area edges**

Convenient if you often use an AF point at the periphery.

#### : **Continuous**

Instead of stopping at the outer edge, the selection of AF point continues to the opposite side.

## AF point display during focus

You can set whether or not to display the AF point(s) in the following cases: 1. When selecting the AF point(s), 2. When the camera is ready to shoot (before AF operation), 3. During AF operation, and 4. When focus is achieved.

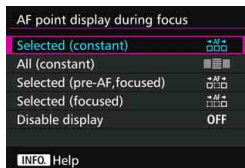

### : **Selected (constant)**

The selected AF point(s) is always displayed.

### : **All (constant)**

All AF points are always displayed.

### : **Selected (pre-AF, focused)**

The selected AF point(s) is displayed for 1, 2, and 4.

### : **Selected (focused)**



The selected AF point(s) is displayed for 1 and 4 and for when AF starts.

### **OFF: Disable display**

For 2, 3, and 4, the selected AF point(s) will not be displayed.

## VF display illumination

You can set whether the AF points in the viewfinder are to light up in red when focus is achieved.

VF display illumination	
Auto	AUTO
Enable	ON
Disable	OFF
AF point during AI Servo AF OFF	
 AF point during AI Servo AF	
 Help	

### AUTO: Auto

The AF points automatically light up in red under low light.

### ON: Enable

The AF points light up in red regardless of the ambient light level.

### OFF: Disable

The AF points do not light up in red.

With **[Auto]** or **[Enable]** set, you can set whether the AF point is to be light up in red (blink) when you press the **<Q>** button during AI Servo AF.

AF point during AI Servo AF	
Non illuminated	OFF
Illuminated	ON

### OFF: Non illuminated

The AF point will not light up during AI Servo AF.

### ON: Illuminated

AF points used for focusing light up in red during AI Servo AF. They are also illuminated during continuous shooting.

This will not work if **[VF display illumination]** is set to **[Disable]**.



- When you press the **<Q>** button, the AF points will light up in red regardless of this setting.
- The electronic level and grid in the viewfinder and the information set with **[Show/hide in viewfinder]** (p.77) will also light up in red.

## AF status in viewfinder

The AF status icon indicating AF operation can be displayed in the viewfinder's field of view or outside the field of view.

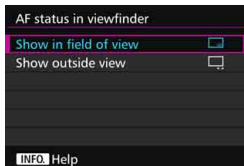

### : Show in field of view

The AF status icon <AF> is displayed in the lower right of the viewfinder's field of view.

### : Show outside view

The <▲▶> icon is displayed below the focus indicator <●> outside the viewfinder's field of view.

 The AF status icon is displayed while you press the shutter button halfway after focus is achieved and while you hold down the <AF-ON> button.

## AF Microadjustment

You can make fine adjustments for the AF's point of focus. For details, see "Fine Adjustment of AF's Point of Focus" on the next page.



## MENU Fine Adjustment of AF's Point of Focus ☆

Fine adjustment of the AF's point of focus is possible for viewfinder shooting. This is called "AF Microadjustment". Before making the adjustment, read "Cautions for AF Microadjustment" on page 138.

**!** Normally, this adjustment is not required. Perform this adjustment only if necessary. Note that performing this adjustment may prevent accurate focusing from being achieved.

### Adjust All by Same Amount

Set the adjustment manually by adjusting, shooting, and checking the result. Repeat this until appropriate adjustment is made. During AF, regardless of the lens used, the point of focus will always be shifted by the adjustment amount.

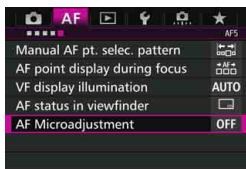

- 1 Select [AF Microadjustment].
  - Under the [AF5] tab, select [AF Microadjustment], then press <SET>.

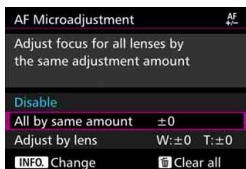

- 2 Select [All by same amount].
- 3 Press the <INFO.> button.
  - ▶ The [All by same amount] screen will appear.

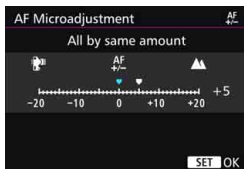

## 4 Make the adjustment.

- Set the adjustment amount. The adjustable range is  $\pm 20$  steps.
- Setting it toward “-: ” will shift the point of focus in front of the standard point of focus.
- Setting it toward “+: ” will shift the point of focus to the rear of the standard point of focus.
- After making the adjustment, press  $\langle \text{SET} \rangle$ .
- Select [**All by same amount**], then press  $\langle \text{SET} \rangle$ .

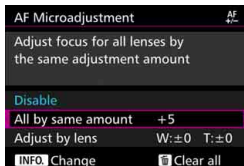

## 5 Check the result of the adjustment.

- Take a picture and play back the image (p.354) to check the adjustment result.
- If the shooting result comes out with focus in front of the targeted point, adjust toward the “+: ” side. If it comes out with focus behind the targeted point, adjust toward the “-: ” side.
- If necessary, repeat the adjustment.

If [**All by same amount**] is selected, separate AF adjustment will not be possible for the wide-angle and telephoto ends of zoom lenses.

## Adjust by Lens

You can make the adjustment for each lens and register the adjustment in the camera. You can register the adjustment for up to 40 lenses. When you autofocus with a lens whose adjustment is registered, the point of focus will always be shifted by the adjustment amount.

Set the adjustment manually by adjusting, shooting, and checking the result. Repeat this until the desired adjustment is made. If you use a zoom lens, make the adjustment for the wide-angle (W) and telephoto (T) ends.

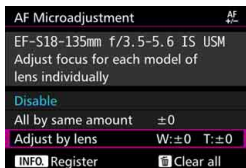

### 1 Select [Adjust by lens].

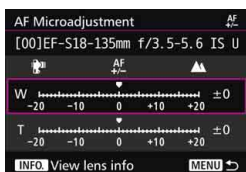

### 2 Press the <INFO.> button.

- ▶ The [Adjust by lens] screen will appear.

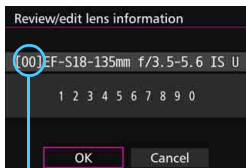

### 3 Check and change the lens information.

#### Check the lens information.

- Press the <INFO.> button.
- ▶ The screen will show the lens name and a 10-digit serial number. When the serial number is displayed, select [OK] and go to step 4.
- If the lens's serial number cannot be confirmed, "0000000000" will be displayed. In this case, enter the number by following the instructions on the next page.
- Regarding the asterisk "\*" displayed in front of some lens serial numbers, see the next page.

Registered number

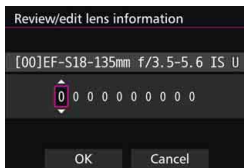

### Entering the Serial Number

- Select the digit to be entered, then press <SET> so that <☐> appears.
- Enter the number, then press <SET>.
- After entering all the digits, select [OK].

### Lens Serial Number

- In step 3, if “\*” appears in front of the 10-digit lens serial number, you can register only one unit of the same lens model. Even if you enter the serial number, “\*” will remain displayed.
- The lens serial number on the lens may differ from the serial number displayed on the screen in step 3. This is not a malfunction.
- If the lens serial number includes letters, enter only the numbers.
- If the lens serial number is eleven digits or longer, enter only the last ten digits.
- The location of the serial number varies depending on the lens.
- Some lenses may not have a serial number inscribed. To register a lens that has no serial number inscribed, enter any serial number.



- If [Adjust by lens] is selected and an Extender is used, the adjustment will be registered for the lens and Extender combination.
- If 40 lenses have already been registered, a message will appear. After you select a lens whose registration is to be erased (overwritten), you can register another lens.

### Single focal length lens

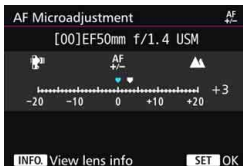

### Zoom lens

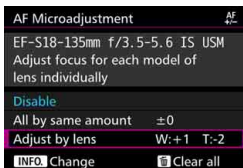
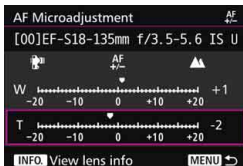

## 4 Make the adjustment.



- For a zoom lens, select the wide-angle (W) or telephoto (T) end. Pressing **<SET>** will turn off the purple frame and make the adjustment possible.
- Set the adjustment amount, then press **<SET>**. The adjustable range is  $\pm 20$  steps.
- Setting it toward “-: ” will shift the point of focus in front of the standard point of focus.
- Setting it toward “+: ” will shift the point of focus to the rear of the standard point of focus.
- For a zoom lens, repeat this procedure and adjust it for the wide-angle (W) and telephoto (T) ends.
- After completing the adjustment, press the **<MENU>** button to return to the screen in step 1.
- Select **[Adjust by lens]**, then press **<SET>**.

## 5 Check the result of the adjustment.

- Take a picture and play back the image (p.354) to check the adjustment result.
- If the shooting result comes out with focus in front of the targeted point, adjust toward the “+: ” side. If it comes out with focus behind the targeted point, adjust toward the “-: ” side.
- If necessary, repeat the adjustment.

 When shooting with the intermediate range (focal length) of a zoom lens, the AF's point of focus is corrected automatically relative to the adjustments made for the wide-angle and telephoto ends. Even if only the wide-angle or telephoto end is adjusted, a correction will be made automatically for the intermediate range.

## Clearing All AF Microadjustments

When  **Clear all** appears at the bottom of the screen, pressing the  button will clear all the adjustments made for **[All by same amount]** and **[Adjust by lens]**.

## Cautions for AF Microadjustment

- The AF's point of focus will vary slightly depending on the subject conditions, brightness, zoom position, and other shooting conditions. Therefore, even if you perform AF Microadjustment, focus may still not be achieved at the suitable position.
- The adjustment amount of one stop varies depending on the maximum aperture of the lens. Keep adjusting, shooting, and checking the focus repeatedly to adjust the AF's point of focus.
- The adjustment will not be applied to AF during Live View shooting or movie shooting.
- The adjustments will be retained even if you clear all the camera settings (p.70). However, the setting itself will be **[Disable]**.

## Notes for AF Microadjustment

- It is best to make the adjustment at the actual location where you will shoot. This will make the adjustment more precise.
- Using a tripod when making the adjustment is recommended.
- For making adjustments, shooting at the  **L** image-recording quality is recommended.

## When Autofocus Fails

Autofocus can fail to achieve focus (viewfinder's focus indicator <●> blinks) with certain subjects such as the following:

### Subjects Difficult to Focus

- Subjects with very low contrast  
(Example: Blue skies, solid-color flat surfaces, etc.)
- Subjects in very low light
- Strongly backlit or reflective subjects  
(Example: Cars with highly reflective bodies, etc.)
- Near and distant subjects framed close to an AF point  
(Example: Animals in cages, etc.)
- Subjects such as dots of light framed close to an AF point  
(Example: Night scenes, etc.)
- Repetitive patterns  
(Example: Skyscraper windows, computer keyboards, etc.)

In such cases, focus by doing either of the following:

- (1) With One-Shot AF, focus on an object at the same distance as the subject and lock the focus, then recompose the shot (p.83).
- (2) Set the lens's focus mode switch to <MF> and focus manually (p.140).



- Depending on the subject, focus may be achieved by slightly recomposing the shot and performing AF operation again.
- Conditions that make focusing difficult with AF during Live View shooting or movie shooting are listed on page 306.

## MF: Manual Focus

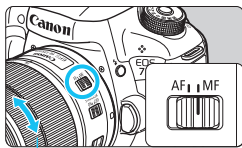

Focusing ring

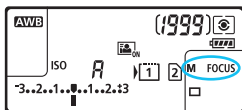

**1 Set the lens's focus mode switch to <MF>.**

- ▶ <M FOCUS> will be displayed on the LCD panel.

**2 Focus on the subject.**

- Focus by turning the lens's focusing ring until the subject looks sharp in the viewfinder.

- If you press the shutter button halfway while focusing manually, the focus indicator <●> will light up when focus is achieved.
- With 65-point automatic selection AF, when the center AF point achieves focus, the focus indicator <●> will light up.



## Selecting the Drive Mode

Single and continuous drive modes are provided. You can select the drive mode suiting the scene or subject.

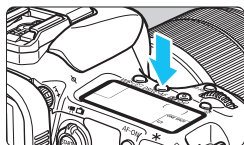

1 Press the **<DRIVE-AF> button**. ()

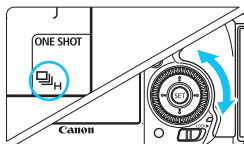

2 Select the drive mode.

- While looking at the LCD panel or viewfinder, turn the **<DRIVE-AF> dial**.

### : **Single shooting**

When you press the shutter button completely, only one shot will be taken.

### : **High-speed continuous shooting**

While you hold down the shutter button completely, the camera will shoot continuously at a **maximum of approx. 10.0 shots/sec.**

### : **Low-speed continuous shooting**



While you hold down the shutter button completely, shots will be taken at a speed of **approx. 3.0 shots/sec.**

### : **Silent single shooting**

Single shooting with less shooting sound than  during viewfinder shooting.

### : **Silent continuous shooting**









Continuous shooting with less shooting sound than  during viewfinder shooting. The continuous shooting speed will be **approx. 4.0 shots/sec.**



 During Live View shooting and movie shooting, shooting will not be silent even if  or  is set.

  : **10-sec. self-timer/remote control**

  2: **2-sec. self-timer/remote control**

For self-timer shooting, see page 143. For remote control shooting, see page 248.

-  When EOS iTR AF is operating (p.128), maximum continuous shooting speed with  will be approx. 9.5 shots/sec. Also, under low-light conditions, the continuous shooting speed may decrease.
- If  5 or  5 is set, the time lag from when you press the shutter button completely until the picture is shot will be slightly longer than standard.
- If you perform high-speed continuous shooting in low temperatures when the remaining battery capacity is low, the continuous shooting speed will be slow.
- In AI Servo AF operation, the continuous shooting speed may become slower depending on the subject and the lens used.
-  H: The maximum continuous shooting speed of approx. 10 shots/sec. is attained under the following conditions\*: 1/1000 sec. or faster shutter speed, maximum aperture (varies depending on the lens), EOS iTR AF: OFF, and Anti-flicker shooting: Disable. The continuous shooting speed may decrease depending on the shutter speed, aperture, subject conditions, brightness, lens, flash use, temperature, remaining battery capacity, etc.
  - \* With the AF mode set to One-Shot AF and the Image Stabilizer turned off when using the following lenses: EF300mm f/4L IS USM, EF28-135mm f/3.5-5.6 IS USM, EF75-300mm f/4-5.6 IS USM, EF100-400mm f/4.5-5.6L IS USM.
- If the [ 1: Record func+card/folder sel.] menu's [**Record func.**] is set to [**Rec. separately**] (p.146) and the recording quality setting for the CF card [ 1] and SD card [ 2] is different, the maximum burst (p.151) will decrease. When internal memory becomes full during continuous shooting, the continuous shooting speed may drop during shooting since shooting will be temporally disabled (p.153).

 By setting [ 2: **Continuous shooting speed**] (p.439), you can manually set the continuous shooting speed.

## 📷 Using the Self-timer

Use the self-timer when you want to be in the picture.

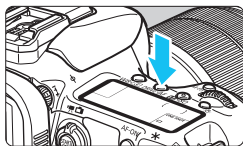

1 Press the <DRIVE-AF> button. (📷)

2 Select the self-timer.

- While looking at the LCD panel or viewfinder, turn the <📷> dial.

📷 : 10-sec. self-timer

📷<sub>2</sub> : 2-sec. self-timer

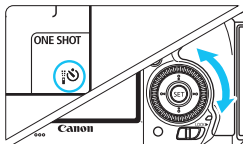

3 Take the picture.

- Look through the viewfinder, focus on the subject, then press the shutter button completely.
- ▶ You can check the self-timer operation with the self-timer lamp, beeper, and countdown display (in seconds) on the LCD panel.
- ▶ Two seconds before the picture is taken, the self-timer lamp will light up and the beeper will sound faster.

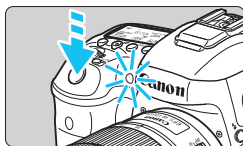

📷 If you do not look through the viewfinder when you press the shutter button, attach the eyepiece cover (p.247). If stray light enters the viewfinder when the picture is taken, it may throw off the exposure.



- The <📷> enables you to shoot while not touching the camera mounted on a tripod. This prevents camera shake while you shoot still lifes or long exposures.
- After taking self-timer shots, playing back the image (p.354) to check focus and exposure is recommended.
- When using the self-timer to shoot yourself, use focus lock (p.83) on an object at the same distance as where you will stand.
- To cancel the self-timer after it starts, press the <DRIVE-AF> button.



# 4

## Image Settings

This chapter explains image-related function settings: Image-recording quality, ISO speed, Picture Style, white balance, Auto Lighting Optimizer, noise reduction, highlight tone priority, lens aberration correction, anti-flicker shooting, and other functions.

- A ☆ icon at the upper right of a page title indicates a function that can be used only in these modes: <P> <Tv> <Av> <M> <B>.

## MENU Selecting the Card for Recording and Playback

If either a CF card or SD card is already inserted in the camera, you can start recording captured images. When only one card is inserted, you do not have to follow the procedures described on pages 146-148.

If you insert both a CF card and SD card, you can select the recording method and select which card to use for recording and playing back images.

[1] indicates the CF card, and [2] the SD card.

### Recording Method with Two Cards Inserted

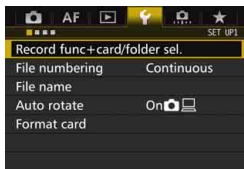

#### 1 Select [Record func+card/folder sel.].

- Under the [⚡ 1] tab, select [Record func+card/folder sel.], then press <SET>.

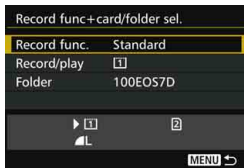

#### 2 Select [Record func.].

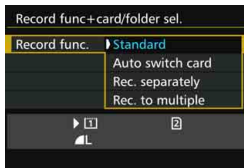

#### 3 Select the recording method.

- Select the recording method, then press <SET>.

- **Standard**

Images will be recorded to the card selected with **[Record/play]**.

- **Auto switch card**

Same as with the **[Standard]** setting, but if the card becomes full, the camera will automatically switch to the other card to record images. When the card is automatically switched, a new folder will be created.

- **Rec. separately**

You can set the image-recording quality for each card (p.149). Each image is recorded to both the CF and SD cards at the image-recording quality you set. You can freely set the image-recording quality, such as to **L** and **RAW**, or **S3** and **M RAW**.

- **Rec. to multiple**

Each image is recorded to both the CF and SD cards simultaneously at the same image size. You can also select RAW+JPEG.



- If **[Rec. separately]** is set and different recording qualities are set for the CF card and SD card, the maximum burst for continuous shooting will decrease (p.151).
- Even if **[Record func.]** is set to **[Rec. to multiple]**, movies cannot be recorded to both the CF card and SD card at the same time. If **[Rec. separately]** or **[Rec. to multiple]** is set, the movie will be recorded to the card which is set for **[Playback]**.



#### **[Rec. separately]** and **[Rec. to multiple]**

- The same file number is used for recording to both the CF card and SD card.
- The LCD panel will display the number of possible shots of the card having the lower number.
- If one of the cards becomes full, **[Card\* full]** will be displayed and shooting will be disabled. If this happens, either replace the card or set **[Record func.]** to **[Standard]** or **[Auto switch card]**, and select the card with remaining capacity to continue shooting.

## Selecting the CF or SD Card for Recording and Playback

If **[Record func.]** is set to **[Standard]** or **[Auto switch card]**, select the card for recording and playing images.

If **[Record func.]** is set to **[Rec. separately]** or **[Rec. to multiple]**, select the card for playing images.

### Standard / Auto switch card

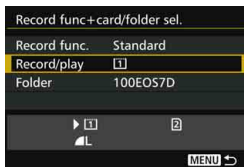

#### Select **[Record/play]**.

- Select **[Record/play]**, then press < (SET) >.
  - 1 : Record images to and play images back from the CF card.
  - 2 : Record images to and play images back from the SD card.
- Select the card, then press < (SET) >.

### Rec. separately / Rec. to multiple

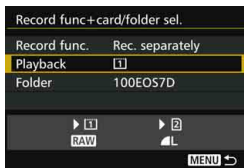

#### Select **[Playback]**.

- Select **[Playback]**, then press < (SET) >.
  - 1 : Play back the CF card's images.
  - 2 : Play back the SD card's images.
- Select the card, then press < (SET) >.



## MENU Setting the Image-Recording Quality

You can select the pixel count and the image quality. There are eight JPEG image-recording quality settings: **L**, **L**, **M**, **M**, **S1**, **S1**, **S2**, **S3**. There are three RAW image quality settings: **RAW**, **M RAW**, **S RAW** (p.152).

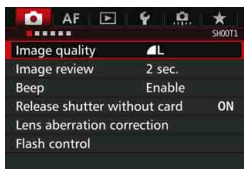

### 1 Select [Image quality].

- Under the [**1**] tab, select [**Image quality**], then press <SET>.

### Standard / Auto switch card / Rec. to multiple



### 2 Select the image-recording quality.

- To select a RAW quality, turn the <DIAL> dial. To select a JPEG quality, turn the <DIAL> dial.
- On the upper right, the “\*\*M (megapixels) \*\*\*x\*\*\*” number indicates the recorded pixel count, and [\*\*\*] is the number of possible shots (displayed up to 9999).
- Press <SET> to set it.

### Rec. separately

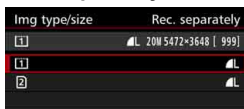

- Under [**1: Record func+card/ folder sel.**], if [**Record func.**] is set to [**Rec. separately**], select CF card [**1**] or SD card [**2**], then press <SET>.
- Select the desired image-recording quality, then press <SET>.

## Image-recording Quality Setting Examples

**L** only



**RAW** only



**RAW** + **L**



**S RAW** + **M**



- If [-] is set for both RAW and JPEG, **L** will be set.
- The number of possible shots will be displayed up to 1999 on the LCD panel.

## Guide to Image-Recording Quality Settings (Approx.)

Image Quality		Pixels Recorded	Printing Size	File Size (MB)	Possible Shots	Maximum Burst
JPEG	L	20M	A2	6.6	1090	130 (1090)
	L			3.5	2060	2060 (2060)
	M	8.9M	A3	3.6	2000	2000 (2000)
	M			1.8	3810	3810 (3810)
	S1	5.0M	A4	2.3	3060	3060 (3060)
	S1			1.2	5800	5800 (5800)
	S2 <sup>*1</sup>	2.5M	9x13 cm	1.3	5240	5240 (5240)
	S3 <sup>*2</sup>	0.3M	-	0.3	20330	20330 (20330)
RAW	RAW	20M	A2	24.0	290	24 (31)
	M RAW	11M	A3	19.3	350	28 (31)
	S RAW	5.0M	A4	13.3	510	35 (35)
RAW + JPEG	RAW	20M	A2	24.0+6.6	220	18 (19)
	L	20M	A2			
	M RAW	11M	A3	19.3+6.6	260	18 (19)
	L	20M	A2			
S RAW	5.0M	A4	13.3+6.6	340	18 (19)	
L	20M	A2				

\*1: S2 is suitable for playing the images on a digital photo frame.

\*2: S3 is suitable for emailing the image or using it on a website.

- S2 and S3 will be in (Fine) quality.
- The file size, possible shots, and maximum burst during continuous shooting are based on Canon's testing standards (3:2 aspect ratio, ISO 100 and Standard Picture Style) using an 8 GB CF card. **These figures will vary by the subject, card brand, aspect ratio, ISO speed, Picture Style, Custom Functions, and other settings.**
- The maximum burst applies to high-speed continuous shooting. Figures in parentheses apply to an Ultra DMA (UDMA) 7 CF card based on Canon's testing standards.

Even if you use a UDMA card, the maximum burst indicator will not change. The maximum burst in parentheses in the table will apply instead.



- If you select both RAW and JPEG, the same image will be recorded simultaneously to the card in both RAW and JPEG at the image-recording qualities that were set. The two images will be recorded with the same file numbers (file extension: .JPG for JPEG and .CR2 for RAW).
- The image-recording quality icons are as follows: **RAW** (RAW), **M RAW** (Medium RAW), **S RAW** (Small RAW), **JPEG** (JPEG), **Fine** (Fine), **Normal** (Normal), **L** (Large), **M** (Medium), and **S** (Small).

## RAW Images

A RAW image is raw data output by the image sensor converted to digital data. It is recorded to the card as is, and you can select the quality as follows: **RAW**, **M RAW**, or **S RAW**.

A **RAW** image can be processed with [▶] **1: RAW image processing** (p.398) and saved as a JPEG image. (**M RAW** and **S RAW** images cannot be processed with the camera.) As the RAW image itself does not change, you can process the RAW image according to different processing conditions to create any number of JPEG images from it. You can use Digital Photo Professional (EOS software, p.534) to process RAW images. You can make various adjustments as desired and generate a JPEG, TIFF, etc., image incorporating those adjustments.



### RAW Image Processing Software

- To display RAW images on a computer, using Digital Photo Professional (DPP, EOS software) is recommended.
- Previous versions of DPP may not be able to process RAW images taken with this camera. If your computer has a previous version of DPP, update it with the EOS Solution Disk (p.534). (The previous version will be overwritten.)
- Commercially-available software may not be able to display RAW images taken with this camera. For compatibility information, contact the software manufacturer.

## One-touch Image Quality Setting

With Custom Controls, you can assign the image-recording quality to the <M-Fn> button or depth-of-field preview button so you can switch to it momentarily. If you assign [**One-touch image quality setting**] or [**One-touch image quality (hold)**] to the <M-Fn> button or depth-of-field preview button, you can quickly switch to the desired image-recording quality and shoot.

For details, see Custom Controls (p.445).

- Under [**1: Record func+card/folder sel.**], if [**Record func.**] is set to [**Rec. separately**], you cannot switch to the One-touch image quality setting.

## Maximum Burst for Continuous Shooting

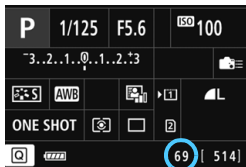

The approximate maximum burst is displayed on the bottom right both in the viewfinder and on the shooting function settings screen.

If the maximum burst for continuous shooting is 99 or higher, "99" will be displayed.

- The maximum burst is displayed even when a card is not inserted in the camera. Make sure that a card is inserted before taking a picture.

- If the maximum burst is displayed as "99", it indicates that you can shoot 99 or more shots continuously. If the maximum burst decreases to 98 or lower and the internal buffer memory becomes full, "buSY" will be displayed in the viewfinder and on the LCD panel. Shooting will then be disabled temporarily. If you stop continuous shooting, the maximum burst will increase. After all the captured images are written to the card, you can resume continuous shooting and shoot up to the maximum burst listed on page 151.

# ISO: Setting the ISO Speed <sup>☆</sup>

Set the ISO speed (image sensor's sensitivity to light) to suit the ambient light level. With the  $\langle \text{A}^+ \rangle$  mode selected, the ISO speed will be set automatically (p.156).

Regarding the ISO speed during movie shooting, see pages 317 and 321.

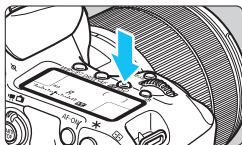

**1** Press the  $\langle \text{ISO} \rangle$  button. (ⓘ6)

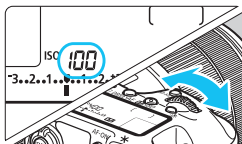

**2** Set the ISO speed.

- While looking at the LCD panel or in the viewfinder, turn the  $\langle \text{gear} \rangle$  dial.
- ISO speed can be set within ISO 100 - ISO 16000 in 1/3-stop increments.
- “A” indicates Auto ISO. The ISO speed will be set automatically (p.156).

## ISO Speed Guide

ISO speed	Shooting Situation (No flash)	Flash Range
ISO 100 - ISO 400	Sunny outdoors	The higher the ISO speed, the farther the flash range will be.
ISO 400 - ISO 1600	Overcast skies or evening time	
ISO 1600 - ISO 16000, H1, H2	Dark indoors or night	

\* High ISO speeds will result in grainier images.



- As H1 (equivalent to ISO 25600) and H2 (equivalent to ISO 51200) are expanded ISO speed settings, noise (dots of light, banding, etc.) and irregular colors will be more noticeable, and the resolution lower than usual.
- If [**3: Highlight tone priority**] is set to [**Enable**] (p.180), ISO 100/125/160, H1 (equivalent to ISO 25600), and H2 (equivalent to ISO 51200) cannot be selected.
- Shooting in high temperatures may result in images that look grainier. Long exposures can also cause irregular colors in the image.
- When you shoot at high ISO speeds, noise (such as dots of light and banding) may become noticeable.
- When shooting in conditions that produce an extreme amount of noise, such as a combination of high ISO speed, high temperature, and long exposure, images may not be recorded properly.
- If you use a high ISO speed and flash to shoot a close subject, overexposure may result.
- If you set H2 (equivalent to ISO 51200) and shoot a movie, it will switch to H1 (equivalent to ISO 25600) with manual-exposure movie shooting. Even if you switch back to still photo shooting, the ISO speed will not revert to H2.



- Under [**2: ISO speed settings**], you can use [**ISO speed range**] to expand the settable ISO speed range up to H2 (equivalent to ISO 51200) (p.157).
- Even if [**1: ISO speed setting increments**] is set to [**1-stop**], you can still select ISO 16000.

## Auto ISO

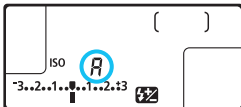

If the ISO speed is set to “**A**” (Auto), the actual ISO speed to be set will be displayed when you press the shutter button halfway.

As indicated below, the ISO speed will be set automatically to suit the shooting mode.

Shooting Mode	ISO Speed Setting
<b>A</b> <sup>†</sup>	Automatically set within ISO 100 - ISO 6400
<b>P/Tv/Av/M</b>	Automatically set within ISO 100 - ISO 16000 <sup>*1</sup>
<b>B</b>	ISO 400 <sup>*1</sup>
With flash	ISO 400 <sup>*1*2*3*4</sup>

\*1: The actual ISO speed range depends on the **[Minimum]** and **[Maximum]** settings set in **[Auto ISO range]**.

\*2: If fill flash will cause overexposure, ISO speed may be reduced, down to a possible minimum of ISO 100 (except in the **<M>** and **<B>** modes).

\*3: Except in the **<A<sup>†</sup>>** mode.

\*4: In the **<P>** mode, if the external Speedlite is set for bounce flash, ISO 400 - ISO 1600 will be set automatically.



## MENU Setting the Manually-Settable ISO Speed Range

You can set the manually-settable ISO speed range (minimum and maximum limits). You can set the minimum limit within ISO 100 to H1 (equivalent to ISO 25600), and the maximum limit within ISO 200 to H2 (equivalent to ISO 51200).

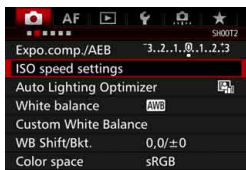

### 1 Select [ISO speed settings].

- Under the [CAMERA] tab, select [ISO speed settings], then press <SET>.

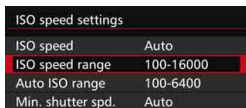

### 2 Select [ISO speed range].



### 3 Set the minimum limit.

- Select the minimum limit box, then press <SET>.
- Select the ISO speed, then press <SET>.



### 4 Set the maximum limit.

- Select the maximum limit box, then press <SET>.
- Select the ISO speed, then press <SET>.

### 5 Select [OK].

**MENU** Setting the ISO Speed Range for Auto ISO

You can set the automatic ISO speed range for Auto ISO within ISO 100 - ISO 16000. You can set the minimum limit within ISO 100 - ISO 12800, and the maximum limit within ISO 200 - ISO 16000.

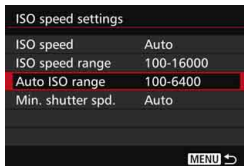
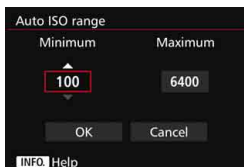
**1** Select [Auto ISO range].**2** Set the minimum limit.

- Select the minimum limit box, then press < **SET** >.
- Select the ISO speed, then press < **SET** >.

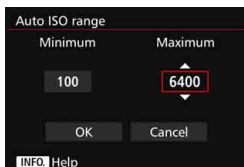
**3** Set the maximum limit.

- Select the maximum limit box, then press < **SET** >.
- Select the ISO speed, then press < **SET** >.

**4** Select [OK].

The [Minimum] and [Maximum] settings will also apply to the ISO speed safety shift's minimum and maximum ISO speeds (p.436).

**MENU** Setting the Minimum Shutter Speed for Auto ISO

You can set the minimum shutter speed so that the shutter speed set automatically will not be too slow when Auto ISO is set.

This is convenient in the <P> and <Av> modes when you use a wide-angle lens to shoot a moving subject or when you use a telephoto lens. It helps to reduce camera shake and blurred subjects.

ISO speed settings	
ISO speed	Auto
ISO speed range	100-16000
Auto ISO range	100-6400
Min. shutter spd.	Auto

**1** Select [Min. shutter spd.].**Automatically set**

Min. shutter spd.	
Auto(Standard)	
Auto	
Manual	
Slower	Faster

**2** Set the desired minimum shutter speed.

- Select [Auto] or [Manual].
- If you select [Auto], turn the < > dial to set the desired speed (slower or faster) compared to the standard speed, then press < (SET) >.
- If you select [Manual], turn the < > dial to select the shutter speed, then press < (SET) >.

**Manually set**

Min. shutter spd.	
Manual(1/125)	
Auto	
Manual	
1/8000	1/4000
1/2000	1/1000
1/500	
1/250	1/125
1/60	1/30
1/15	
1/8	1/4
0.5	1"





- If a correct exposure cannot be obtained with the maximum ISO speed limit set with [Auto ISO range], a shutter speed slower than the [Min. shutter spd.] will be set to obtain a standard exposure.
- This function will not be applied to flash and movie shooting.





When [Auto: 0] is set, the minimum shutter speed will be the reciprocal of the lens focal length. A single step from [Slower] to [Faster] is equivalent to a single shutter speed stop.

## Selecting a Picture Style ☆

By selecting a Picture Style, you can obtain image characteristics matching your photographic expression or the subject.

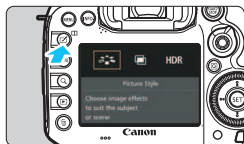
The Picture Style is set automatically to [] (Auto) in the < > mode.



1 Press the < > button.

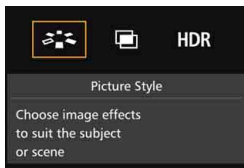

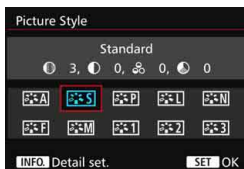

2 Select [].

▶ The Picture Style selection screen will appear.



3 Select a Picture Style.

▶ The Picture Style will be set and the camera will be ready to shoot.

 You can also select the Picture Style with [ 3: Picture Style].

## Picture Style Characteristics

### **Auto**

The color tone will be adjusted automatically to suit the scene. The colors will look vivid, especially for blue skies, greenery and sunsets, and in nature, outdoor and sunset scenes.



If the desired color tone is not obtained with **[Auto]**, use another Picture Style.

### **Standard**

The image looks vivid, sharp, and crisp. This is a general-purpose Picture Style suitable for most scenes.

### **Portrait**

For nice skin tones. The image looks softer. Suited for close-up portraits.

By changing the **[Color tone]** (p.163), you can adjust the skin tone.

### **Landscape**

For vivid blues and greens, and very sharp and crisp images. Effective for impressive landscapes.

### **Neutral**

Suited for processing the image with a computer. For natural colors and subdued images.

### **Faithful**

Suited for processing the image with a computer. The color of a subject that is captured in sunlight at a color temperature of 5200K will be adjusted to match the subject's colorimetric color. Images will appear subdued.

## ☰ M Monochrome

Creates black-and-white images.

ⓘ Black-and-white images shot in JPEG cannot be reverted to color. If you want to later shoot pictures in color, make sure the **[Monochrome]** setting is canceled.

📷 You can display < ⓘ > in the viewfinder and on the LCD panel when **[Monochrome]** is set (p.441).

## ☰ 1 User Def. 1-3

You can register a basic style such as **[Portrait]**, **[Landscape]**, a Picture Style file, etc., and adjust it as desired (p.166). Any User Defined Picture Style that is not set will have the same settings as the **[Standard]** Picture Style.

## Symbols

The symbols of the Picture Style selection screen refer to parameters such as **[Sharpness]** and **[Contrast]**. The numerals indicate the parameter settings, such as for **[Sharpness]** and **[Contrast]**, for each Picture Style.

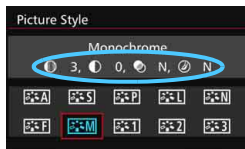
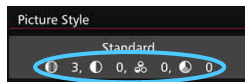

## Symbols

☰	Sharpness
☰	Contrast
☰	Saturation
☰	Color tone
☰	Filter effect (Monochrome)
☰	Toning effect (Monochrome)

## Customizing a Picture Style ☆

You can customize a Picture Style by adjusting individual parameters such as **[Sharpness]** and **[Contrast]**. To see the resulting effects, take test shots. To customize **[Monochrome]**, see page 165.

1 Press the  button.

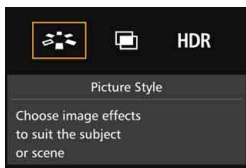

2 Select [].

- ▶ The Picture Style selection screen will appear.

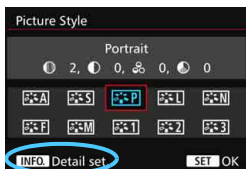

3 Select a Picture Style.

- Select a Picture Style, then press <INFO.> button.

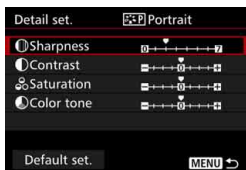

4 Select a parameter.

- Select a parameter such as **[Sharpness]**, then press <.>

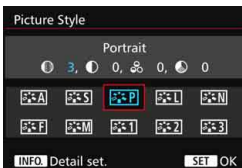
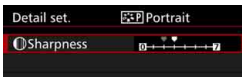

## 5 Set the parameter.

- Adjust the parameter as desired, then press <SET>.
- Press the <MENU> button to save the adjusted parameters. The Picture Style selection screen will reappear.
  - ▶ Any parameter settings different from the default will be displayed in blue.

### Parameter Settings and Effects

Sharpness	0: Less sharp outline	+7: Sharp outline
Contrast	-4: Low contrast	+4: High contrast
Saturation	-4: Low saturation	+4: High saturation
Color tone	-4: Reddish skin tone	+4: Yellowish skin tone

- By selecting [**Default set.**] in step 4, you can revert the respective Picture Style to its default parameter settings.
- To shoot with the Picture Style you adjusted, first select the adjusted Picture Style, then shoot.



## Monochrome Adjustment

For Monochrome, you can also set **[Filter effect]** and **[Toning effect]** in addition to **[Sharpness]** and **[Contrast]** explained on the preceding pages.

### Filter effect

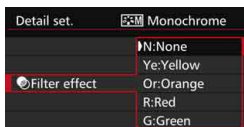

With a filter effect applied to a monochrome image, you can make white clouds or green trees stand out more.

Filter	Sample Effects
N: None	Normal black-and-white image with no filter effects.
Ye: Yellow	The blue sky will look more natural, and the white clouds will look crisper.
Or: Orange	The blue sky will look slightly darker. The sunset will look more brilliant.
R: Red	The blue sky will look quite dark. Fall leaves will look crisper and brighter.
G: Green	Skin tones and lips will appear muted. Green tree leaves will look crisper and brighter.

 Increasing the **[Contrast]** will make the filter effect more pronounced.

### Toning effect



By applying a toning effect, you can create a monochrome image in that color. It can make the image look more impressive.

The following can be selected: **[N:None]**, **[S:Sepia]**, **[B:Blue]**, **[P:Purple]** or **[G:Green]**.

## Registering a Picture Style ☆

You can select a base Picture Style such as [Portrait] or [Landscape], adjust its parameters as desired and register it under [User Def. 1], [User Def. 2], or [User Def. 3].

You can create multiple Picture Styles with different settings for parameters such as sharpness and contrast.

You can also adjust the parameters of a Picture Style that is registered to the camera with EOS Utility (EOS software, p.534).

**1** Press the  button.

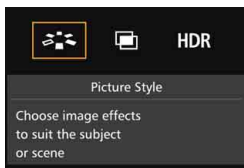

**2** Select [].

- ▶ The Picture Style selection screen will appear.

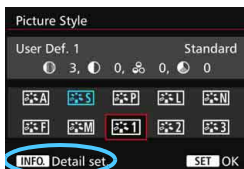

**3** Select [User Def. \*].

- Select [User Def. \*], then press <INFO.> button.

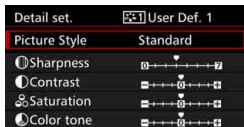

**4** Press <SET>.

- With [Picture Style] selected, press <SET>.

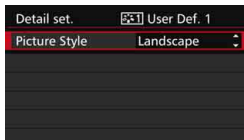

**5** Select the base Picture Style.

- Select the base Picture Style, then press <SET>.
- To adjust the parameters of a Picture Style that is registered to the camera with EOS Utility (EOS software), select the Picture Style here.



## 6 Select a parameter.

- Select a parameter such as **[Sharpness]**, then press **<SET>**.

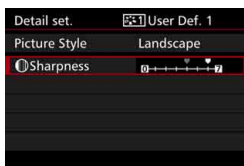

## 7 Set the parameter.

- Adjust the parameter as desired, then press **<SET>**.  
For details, see “Customizing a Picture Style” (p.163).
- Press the **<MENU>** button to register the modified Picture Style. The Picture Style selection screen will then reappear.
- ▶ The base Picture Style will be indicated on the right of **[User Def. \*]**.

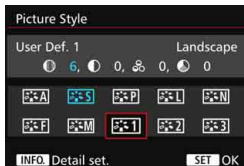

- If a Picture Style has already been registered under **[User Def. \*]**, changing the base Picture Style in step 5 will nullify the parameter settings of the registered Picture Style.
- If you execute **[Clear all camera settings]** (p.70), all the **[User Def. \*]** settings will revert to their defaults. Any Picture Style registered via EOS Utility (EOS software) will have only its modified parameters reverted to the default setting.



- To shoot with the Picture Style you adjusted, select the registered **[User Def. \*]**, then shoot.
- Regarding the procedure to register a Picture Style file to the camera, refer to the EOS Utility Instruction Manual.

## WB: Setting the White Balance ☆

White balance (WB) is for making the white areas look white. Normally, the [AWB] (Auto) setting will obtain the correct white balance. If natural-looking colors cannot be obtained with [AWB], you can select the white balance to match the light source or set it manually by shooting a white object.

<A+> is automatically set in the [AWB] mode.

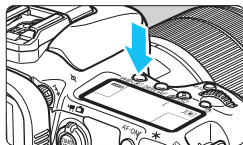

1 Press the <WB> button. (ⓘ6)

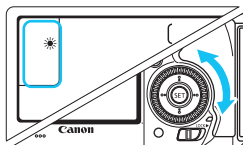

2 Select a white balance setting.

- While looking at the LCD panel or viewfinder, turn the <WB> dial.

(Approx.)

Display	Mode	Color Temperature (K: Kelvin)
AWB	Auto	3000-7000
☀	Daylight	5200
🏠	Shade	7000
☁	Cloudy, twilight, sunset	6000
☀	Tungsten light	3200
💡	White fluorescent light	4000
⚡	Flash use	Automatically set*
📷	Custom (p.169)	2000-10000
K	Color temperature (p.171)	2500-10000

\* Applicable with Speedlites having a color temperature transmission function. Otherwise, it will be fixed to approx. 6000 K.



You can also set this with [📷2: White balance].

## White Balance

To the human eye, a white object looks white regardless of the type of lighting. With a digital camera, the color temperature is adjusted with software to make the white areas look white. This adjustment serves as the basis for the color correction. With this function, pictures with natural color shades can be taken.

### Custom White Balance

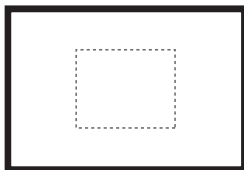

Custom white balance enables you to manually set the white balance for a specific light source for better accuracy. Perform this procedure under the actual light source to be used.



#### 1 Shoot a white object.

- Look through the viewfinder and aim the entire dotted line box (shown in the illustration) over a plain, white object.
- Focus manually and shoot with the standard exposure set for the white object.
- You can use any white balance setting.

#### 2 Select [Custom White Balance].

- Under the [2] tab, select [**Custom White Balance**], then press <  >.
- ▶ The custom white balance selection screen will appear.

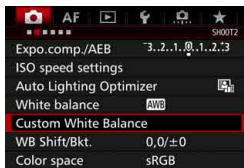



### 3 Import the white balance data.

- Turn the <DISP> dial to select the image captured in step 1, then press <SET>.
- ▶ On the dialog screen that appears, select [OK] and the data will be imported.
- Press the <MENU> button to exit the menu.

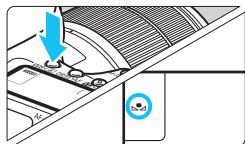

### 4 Press the <WB> button. (6)

### 5 Select the custom white balance.

- Look at the LCD panel and turn the <DISP> dial to select <WB>.

- If the exposure obtained in step 1 differs greatly from the standard exposure, a correct white balance may not be obtained.
- In step 3, the following images cannot be selected: Images captured while the Picture Style was set to [Monochrome], multiple-exposure images, and images shot with another camera.

- Instead of a white object, a gray chart or 18% gray reflector (commercially available) can produce a more accurate white balance.
- The personal white balance registered with the EOS software will be registered under <WB>. If you perform step 3, the data for the registered personal white balance will be erased.

## K Setting the Color Temperature

You can set the white balance's color temperature numerically. This is for advanced users.

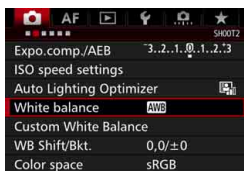

### 1 Select [White balance].

- Under the [**2**] tab, select [White balance], then press <SET>.

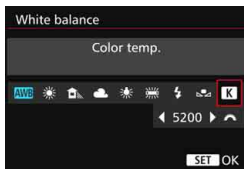

### 2 Set the color temperature.

- Select [**K**].
- Turn the <DIAL> dial to set the color temperature, then press <SET>.
- The color temperature can be set from approx. 2500 K to 10000 K in 100 K increments.



- When setting the color temperature for an artificial light source, set white balance correction (magenta or green) as necessary.
- If you set [**K**] to the reading taken with a commercially-available color temperature meter, take test shots and adjust the setting to compensate for the difference between the color temperature meter's reading and the camera's color temperature reading.

# WB $\pm$ White Balance Correction ☆

You can correct the white balance that is set. This adjustment will have the same effect as using a commercially-available color temperature conversion filter or color compensating filter. Each color can be corrected to one of nine levels.

This function is for advanced users who are familiar with using color temperature conversion or color compensating filters.

## White Balance Correction

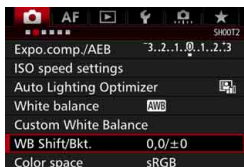

### 1 Select [WB Shift/Bkt.].

- Under the [CAMERA] tab, select [WB Shift/Bkt.], then press <SET>.

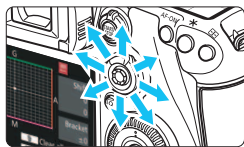

Sample setting: A2, G1

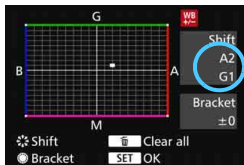

### 2 Set the white balance correction.

- Use <◂> to move the “■” mark to the appropriate position.
- B is for blue, A for amber, M for magenta, and G for green. The image's color balance will be corrected towards the selected color.
- On the right of the screen, “Shift” indicates the direction and correction amount, respectively.
- Pressing the <WASTE> button will cancel all the [WB Shift/Bkt.] settings.
- Press <SET> to exit the setting.



- During the white balance correction, <WB> will be displayed on the LCD panel.
- You can display <!> in the viewfinder and on the LCD panel when white balance correction is set (p.441).
- One level of the blue/amber correction is equivalent to approx. 5 mireds of a color temperature conversion filter. (Mired: Measuring unit indicating the density of a color temperature conversion filter.)



## White Balance Auto Bracketing

With just one shot, three images with different color tones can be recorded simultaneously. Based on the color temperature of the current white balance setting, the image will be bracketed with a blue/amber bias or magenta/green bias. This is called white balance bracketing (WB-BKT). White balance bracketing is possible up to  $\pm 3$  levels in single-level increments.

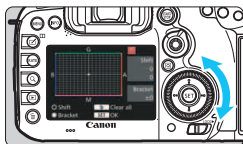

B/A bias  $\pm 3$  levels

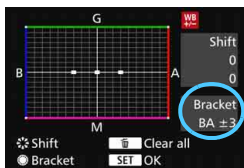

### Set the white balance bracketing amount.

- In step 2 for “White Balance Correction”, when you turn the  $\langle \odot \rangle$  dial, the “■” mark on the screen will change to “■■■” (3 points). Turning the dial to the right sets the B/A bracketing, and turning it to the left sets the M/G bracketing.
- ▶ On the right, “**Bracket**” indicates the bracketing direction and correction amount.
- Pressing the  $\langle \text{trash} \rangle$  button will cancel all the [WB Shift/Bkt.] settings.
- Press  $\langle \text{SET} \rangle$  to exit the setting.

### Bracketing Sequence

The images will be bracketed in the following sequence: 1. Standard white balance, 2. Blue (B) bias, and 3. Amber (A) bias, or 1. Standard white balance, 2. Magenta (M) bias, and 3. Green (G) bias.

- During WB bracketing, the maximum burst for continuous shooting will be lower and the number of possible shots will also decrease to one-third the normal number.
- Since three images are recorded for one shot, it takes longer to record the image to the card.

- You can also set white balance correction and AEB together with white balance bracketing. If you set AEB in combination with white balance bracketing, a total of nine images will be recorded for a single shot.
- When white balance bracketing is set, the white balance icon will blink.
- You can change the number of shots for white balance bracketing (p.435).
- “**Bkt.**” stands for bracketing.

## MENU Auto Correction of Brightness and Contrast ☆

If the image comes out dark or the contrast is low, the brightness and contrast can be corrected automatically. This function is called Auto Lighting Optimizer. The default setting is [Standard]. With JPEG images, the correction is applied when the image is captured.

[Standard] is automatically set in the <A+> mode.

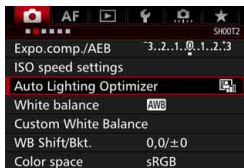

### 1 Select [Auto Lighting Optimizer].

- Under the [CAMERA] tab, select [Auto Lighting Optimizer], then press <SET>.

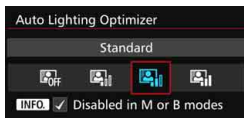

### 2 Select the setting.

- Select the desired setting, then press <SET>.

### 3 Take the picture.

- The image will be recorded with the brightness and contrast corrected if necessary.



- Depending on the shooting conditions, noise may increase.
- If the Auto Lighting Optimizer is too strong and the image is too bright, set [Low] or [Disable].
- If a setting other than [Disable] is set and you use exposure compensation or flash exposure compensation to darken the exposure, the image may still come out bright. If you want a darker exposure, set this function to [Disable].
- If [CAMERA: Highlight tone priority] is set to [Enable], the Auto Lighting Optimizer will be set automatically to [Disable].



In step 2, if you press the <INFO.> button and uncheck <✓> the [Disabled in M or B modes] setting, the [Auto Lighting Optimizer] can also be set in the <M> and <B> modes.

## MENU Setting Noise Reduction ☆

### High ISO Speed Noise Reduction

This function reduces the noise generated in the image. Although noise reduction is applied at all ISO speeds, it is particularly effective at high ISO speeds. At low ISO speeds, the noise in the darker parts of the image (shadow areas) is further reduced.



#### 1 Select [High ISO speed NR].

- Under the [**3**] tab, select [**High ISO speed NR**], then press <SET>.



#### 2 Set the level.

- Select the desired noise reduction level, then press <SET>.

#### ● **NR**: Multi Shot Noise Reduction

This applies noise reduction with higher image quality than [**High**].

For a single photo, four shots are taken continuously and aligned and merged automatically into a single JPEG image.

If the image-recording quality is set to RAW or RAW+JPEG, you cannot set [**Multi Shot Noise Reduction**].

#### 3 Take the picture.

- The image will be recorded with noise reduction applied.

When Multi Shot Noise Reduction is set, you can display <NR> in the viewfinder and on the LCD panel (p.441).



## Cautions for Setting Multi Shot Noise Reduction

- If there is significant misalignment in the image due to camera shake, the noise reduction effect may be minimal.
- If you are handholding the camera, keep it steady to prevent camera shake. Using a tripod is recommended.
- If you shoot a moving subject, the moving subject may leave afterimages.
- The image alignment may not function properly with repetitive patterns (lattice, stripes, etc.) or flat, single-tone images.
- If the subject's brightness changes as the four consecutive shots are taken, irregular exposure in the image may result.
- Recording the image to the card will take longer than with normal shooting. During the processing of the images, "buSY" will be displayed in the viewfinder and on the LCD panel, and you cannot take another picture until the processing is completed.
- You cannot use AEB and WB bracketing.
- The [Distortion] setting will be set automatically to [Disable].
- If [CAM3: Long exp. noise reduction], [CAM3: Multiple exposure], [CAM3: HDR Mode], AEB, or WB bracketing is set, [Multi Shot Noise Reduction] cannot be set.
- Flash shooting is not possible. The AF-assist beam will be emitted according to the [AF3: AF-assist beam firing] setting.
- You cannot set [Multi Shot Noise Reduction] for bulb exposures and movie shooting.
- The setting will automatically switch to [Standard] if you do any of the following: Turn the power switch to <OFF>, change the battery, replace the card, select the <A+> or <B> shooting mode, set or switch the image-recording quality to RAW or RAW+JPEG, or switch to movie shooting.

## Long Exposure Noise Reduction

Noise reduction is possible with images exposed for 1 sec. or longer.

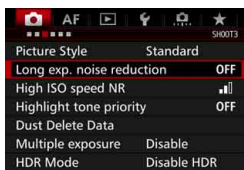

### 1 Select [Long exp. noise reduction].

- Under the [**3**] tab, select [**Long exp. noise reduction**], then press < **SET** >.

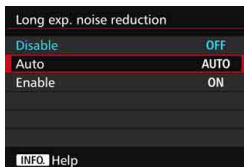

### 2 Set the desired setting.

- Select the desired setting, then press < **SET** >.

#### ● Auto

For exposures of 1 sec. or longer, noise reduction is performed automatically if noise typical of long exposures is detected. This [**Auto**] setting is effective in most cases.

#### ● Enable

Noise reduction is performed for all exposures of 1 sec. or longer. The [**Enable**] setting may reduce noise that cannot be detected with the [**Auto**] setting.

### 3 Take the picture.

- The image will be recorded with noise reduction applied.



- With **[Auto]** and **[Enable]**, the noise reduction process after the picture is taken may take the same amount of time as that for the exposure. During noise reduction, shooting is still possible as long as the maximum burst indicator in the viewfinder shows “1” or higher.
- Images taken at ISO 1600 or higher may look grainier with the **[Enable]** setting than with the **[Disable]** or **[Auto]** setting.
- With **[Enable]**, if a long exposure is shot with the Live View image displayed, “**BUSY**” will be displayed during the noise reduction process. The Live View display will not appear until the noise reduction is completed. (You cannot take another picture.)

## MENU Highlight Tone Priority ☆

You can reduce overexposed highlight areas.

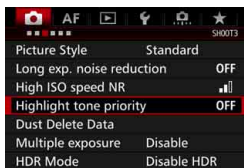

### 1 Select [Highlight tone priority].

- Under the [ 3] tab, select [Highlight tone priority], then press <SET>.



### 2 Select [Enable].

- Highlight details are improved. The dynamic range is expanded from the standard 18% gray to bright highlights. The gradation between the grays and highlights becomes smoother.

### 3 Take the picture.

- The image will be recorded with highlight tone priority applied.

When [Enable] is set, noise may increase slightly.

With [Enable], the settable range will be ISO 200 - ISO 16000. Also, the <D+> icon will be displayed in the viewfinder and on the LCD panel when highlight tone priority is enabled.



## MENU Correction of Lens Peripheral Illumination and Aberrations

Peripheral light fall-off is a phenomenon that makes the image corners look darker due to the lens characteristics. Color fringing along subject outlines is called chromatic aberration. And image distortion due to lens characteristics is called distortion. These lens aberrations and light fall-off can be corrected. By default, Peripheral illumination and Chromatic aberration correction are set to **[Enable]**, and Distortion correction is set to **[Disable]**.

If **[Cannot correct - no data]** is displayed, see “Lens Correction Data” on page 183.

### Peripheral Illumination Correction

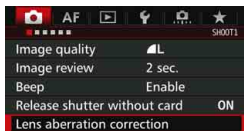

#### 1 Select **[Lens aberration correction]**.

- Under the [**1**] tab, select **[Lens aberration correction]**, then press **<SET>**.

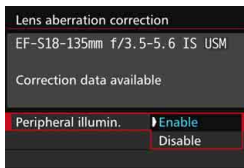

#### 2 Select the setting.

- Check that **[Correction data available]** is displayed for the attached lens.
- Select **[Peripheral illumin.]**, then press **<SET>**.
- Select **[Enable]**, then press **<SET>**.

#### 3 Take the picture.

- The image will be recorded with the peripheral illumination corrected.

Depending on shooting conditions, noise may appear on the image periphery.

- The correction amount applied will be lower than the maximum correction amount settable with Digital Photo Professional (EOS software, p.534).
- The higher the ISO speed, the lower the correction amount will be.

## Chromatic Aberration Correction

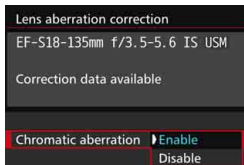

### 1 Select the setting.

- Check that [**Correction data available**] is displayed for the attached lens.
- Select [**Chromatic aberration**], then press <SET>.
- Select [**Enable**], then press <SET>.

### 2 Take the picture.

- The image will be recorded with the chromatic aberration corrected.

## Distortion Correction

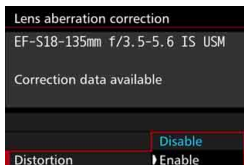

### 1 Select the setting.

- Check that [**Correction data available**] is displayed for the attached lens.
- Select [**Distortion**], then press <SET>.
- Select [**Enable**], then press <SET>.

### 2 Take the picture.

- The image will be recorded with the distortion corrected.



- When distortion correction is enabled, the camera records an image range narrower than that seen through the viewfinder. (Image periphery will be slightly cropped and resolution slightly lowered.)
- If you set [**Distortion**] to [**Enable**], the maximum burst (p.153) during continuous shooting will decrease.
- Distortion will not be corrected if you shoot a movie or set the HDR mode, multiple exposures, or Multi Shot Noise Reduction.
- Using distortion correction during Live View shooting will slightly affect the angle of view.
- When you magnify the image during Live View shooting, distortion correction is not applied to the image displayed. Therefore, if the image periphery is magnified, a part of the image range that will not be recorded in the actual image may be displayed.
- Dust Delete Data (p.407) will not be appended to images recorded with distortion correction enabled. Also, the AF point(s) will not be displayed (p.359) when you play back the image.

## Lens Correction Data

The camera already contains data for lens peripheral illumination correction, chromatic aberration correction, and distortion correction for approx. 30 lenses. If you select [**Enable**], the peripheral illumination correction, chromatic aberration correction, and distortion correction will be applied automatically for any lens whose correction data is registered in the camera.

With EOS Utility (EOS software), you can check the lenses of which correction data is registered in the camera. You can also register the correction data for unregistered lenses. For details, refer to the EOS Utility Instruction Manual.

 **Cautions for Lens Correction**

- Peripheral illumination correction, chromatic aberration correction, and distortion correction cannot be applied to JPEG images already taken.
- When using a non-Canon lens, setting the corrections to **[Disable]** is recommended, even if **[Correction data available]** is displayed.
- If you use magnified view during Live View shooting, the peripheral illumination correction, chromatic aberration correction, and distortion correction will not be reflected in the image shown on the screen.
- The correction amount will be less if the lens used does not have distance information.

 **Notes for Lens Correction**

- If the effect of the correction is not visible, magnify the image after shooting and check it again.
- Corrections can be applied even when an Extender or Life-size Converter is attached.
- If the correction data for the attached lens is not registered to the camera, the result will be the same as when the correction is set to **[Disable]**.

## MENU Reducing Flicker ☆

If you shoot an image with a fast shutter speed under a light source such as fluorescent light, the blinking of the light source causes flicker and the image may be vertically unevenly exposed. If continuous shooting is used under these conditions, uneven exposures or colors across the images may result.

With anti-flicker shooting, the camera detects the frequency of the light source's blinking and takes the picture when the flicker's effect on the exposure or color is minimal.

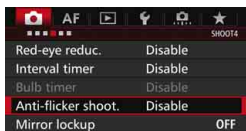

### 1 Select [Anti-flicker shoot.].

- Under the [CAMERA] tab, select [Anti-flicker shoot.], then press <SET>.

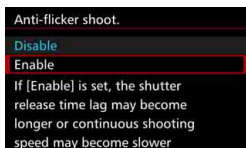

### 2 Select [Enable].

### 3 Take the picture.

- The image will be taken with reduced unevenness of exposure or color caused by the flicker.



- When [Enable] is set and you shoot under a flickering light source, the shutter-release time lag may become slightly longer. Also, the continuous shooting speed may become slightly slower, and the shooting interval may become irregular.
- This function does not work with Live View shooting and movie shooting.
- In the <P> or <Av> mode, if the shutter speed changes during continuous shooting or if you shoot multiple shots of the same scene at different shutter speeds, the color tone may be inconsistent. To avoid inconsistent color tones, use the <Tv> or <M> mode at a fixed shutter speed.
- The color tone of images shot when [Anti-flicker shoot.] is set to [Enable] may look different from when [Disable] is set.
- Flicker at a frequency other than 100 Hz or 120 Hz cannot be detected. Also, if the light's flicker frequency changes during continuous shooting, effects of the flicker cannot be reduced.



- If the subject is against a dark background or if there is a bright light in the image, flicker may not be detected.
- Under certain special types of lighting, the camera may not be able to reduce the effects of the flicker even while < **Flicker!** > is displayed.
- Depending on the light source, flicker may not be detected properly.
- If you recompose a shot, < **Flicker!** > may appear and disappear intermittently.
- Depending on the light sources or shooting conditions, expected result may not be obtained even if you use this function.



- Taking test shots is recommended.
- If < **Flicker!** > is not displayed in the viewfinder, checkmark [**Flicker detection**] in [**Show/hide in viewfinder**] (p.77). When the camera reduces the effects of the flicker when you shoot, < **Flicker!** > will light. Under a light source which does not flicker, or if no flicker is detected, < **Flicker!** > will not be displayed.
- If [**Flicker detection**] is checkmarked and [**4: Anti-flicker shoot.**] is set to [**Disable**], metering under flickering light source will cause < **Flicker!** > to blink in the viewfinder as a warning. Setting [**Enable**] before shooting is recommended.
- In the < **A<sup>+</sup>** > mode, the effects of flickering light will be reduced when you shoot, but < **Flicker!** > will not be displayed.
- Anti-flicker shooting also works with flash. However, the expected result may not be obtained during wireless flash shooting.

## MENU Setting the Color Space ☆

The range of reproducible colors is called “color space”. With this camera, you can set the color space for captured images to sRGB or Adobe RGB. For normal shooting, sRGB is recommended.

The color space is set automatically to [sRGB] in the <[A]<sup>+</sup>> mode.

### 1 Select [Color space].

- Under the [CAMERA 2] tab, select [Color space], then press <[SET]>.

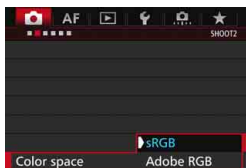

### 2 Set the desired color space.

- Select [sRGB] or [Adobe RGB], then press <[SET]>.

## Adobe RGB

This color space is mainly used for commercial printing and other industrial uses. This setting is not recommended if you are not familiar with image processing, Adobe RGB, and Design rule for Camera File System 2.0 (Exif 2.21 or higher). The image will look very subdued in a sRGB computer environment and with printers not compatible with Design rule for Camera File System 2.0 (Exif 2.21 or higher). Post-processing of the image with computer software will therefore be required.



- If the captured still photo was shot in the Adobe RGB color space, the first character in the file name will be an underscore “\_”.
- The ICC profile is not appended. For explanations about the ICC profile, refer to the Digital Photo Professional Instruction Manual.

## MENU Creating and Selecting a Folder

You can freely create and select the folder where the captured images are to be saved.

This operation is optional since a folder will be created automatically for saving captured images.

### Creating a Folder

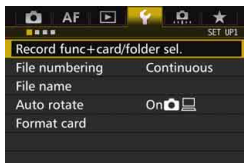

#### 1 Select [Record func+card/folder sel.].

- Under the [**⚡** 1] tab, select [**Record func+card/folder sel.**], then press < **SET** >.

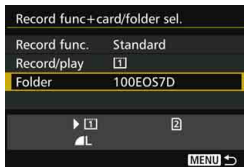

#### 2 Select [Folder].

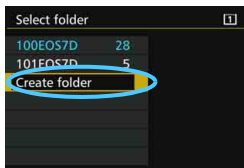

#### 3 Select [Create folder].

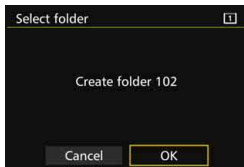

#### 4 Select [OK].

- ▶ A new folder with the folder number increased by one is created.



## Selecting a Folder



- Select a folder on the folder selection screen, then press  $\langle \text{SET} \rangle$ .
- ▶ The folder where the captured images will be saved is selected.
- Subsequently captured images will be recorded into the selected folder.



## Folders

As with “100EOS7D” for example, the folder name starts with three digits (the folder number) followed by five alphanumeric characters. A folder can contain up to 9999 images (file number 0001 - 9999). When a folder becomes full, a new folder with the folder number increased by one is created automatically. Also, if manual reset (p.194) is executed, a new folder will be created automatically. Folders numbered from 100 to 999 can be created.

### Creating Folders with a Computer

With the card open on the screen, create a new folder named “DCIM”. Open the DCIM folder and create as many folders as necessary to save and organize your images. The folder name must follow the format “100ABC\_D”. The first three digits are the folder number, from 100 to 999. The last five characters can be any combination of upper- and lower-case letters from A to Z, numerals, and the underscore “\_”. The space cannot be used. Also note that two folder names cannot share the same three-digit folder number (for example, “100ABC\_D” and “100W\_XYZ”), even if the remaining five characters in each name are different.

## MENU Changing the File Name

The file name has four alphanumeric characters followed by a four-digit image number (p.193) and extension. (Example) BE3B0001.JPG

The first four alphanumeric characters are set upon factory shipment and unique to the camera. However, you can change them.

With “User setting1”, you can change and register the four characters as desired. With “User setting2”, if you register three characters, the fourth character from the left will be appended automatically to indicate the image size.

### Registering or Changing the File Name

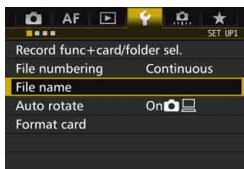

#### 1 Select [File name].

- Under the [**1**] tab, select [**File name**], then press < **SET** >.

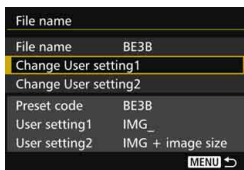

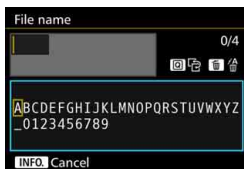

#### 2 Select [Change User setting\*].

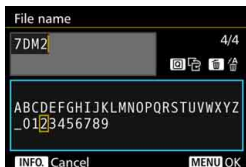

#### 3 Enter any alphanumeric characters.

- For User setting1, enter four characters. For User setting2, enter three characters.
- Press the < **⌫** > button to delete any unnecessary characters.
- Press the < **Q** > button. The text palette will be highlighted with a color frame, and text can be entered.



- Operate the <⊙> dial or <⊕> to move the  and select the desired character. Then press <Ⓢ> to enter it.

## 4 Exit the setting.

- After entering the correct number of characters, press the <MENU> button, then select [OK].
- ▶ The registered file name will be saved.

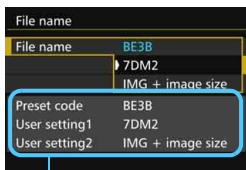

Settings

## 5 Select the registered file name.

- Select [File name], then press <Ⓢ>.
- Select the registered file name, then press <Ⓢ>.
- If User setting2 is registered, select “\*\*\* (the 3 characters registered) + image size”.



The first character cannot be an underscore “\_”.



## User setting2

When you select the “\*\*\* + image size” registered with User setting2 and take pictures, the image-recording quality character will be automatically appended as the file name’s fourth character from the left. The meaning of the image-recording quality characters is as follows:

“\*\*\*L” = L / L / RAW

“\*\*\*M” = M / M / M RAW

“\*\*\*S” = S1 / S1 / S RAW

“\*\*\*T” = S2

“\*\*\*U” = S3

When the image is transferred to a computer, the automatically appended fourth character will be included. You can then see the image size without having to open the image. RAW or JPEG images can be distinguished with the extension.



- The extension will be “.JPG” for JPEG images, “.CR2” for RAW images, and “.MOV” or “.MP4” for movies.
- When you shoot a movie with User setting2, the file name’s fourth character will be an underscore “\_”.

## MENU File Numbering Methods

The four-digit file number is like the frame number on a roll of film. The captured images are assigned a sequential file number from 0001 to 9999 and saved in one folder. You can change how the file number is assigned. (Example) **BE3B0001.JPG**

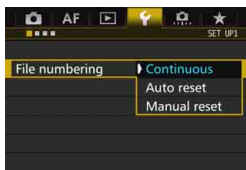

- 1 Select [File numbering].**
  - Under the [**1**] tab, select [**File numbering**], then press **< [SET] >**.
- 2 Select the file numbering method.**
  - Select the desired setting, then press **< [SET] >**.

### Continuous

**Continues the file numbering sequence even after the card is replaced or a new folder is created.**

Even after you replace the card, create a folder, or switch the target card (such as [1] → [2]), the file numbering continues in sequence up to 9999 for the images saved. This is convenient when you want to save images numbered anywhere between 0001 to 9999 on multiple cards or in multiple folders into one folder on your computer.

If the replacement card or existing folder already contains images recorded previously, the file numbering of the new images may continue from the file numbering of the existing images on the card or in the folder. If you want to use continuous file numbering, it is recommended that you use a newly-formatted card each time.

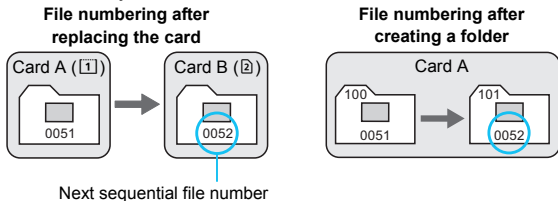

## Auto Reset

**Restarts the file numbering from 0001 each time the card is replaced or a new folder is created.**

When you replace the card, create a folder, or switch the target card (such as ① → ②), the file numbering continues in sequence from 0001 for the images saved. This is convenient if you want to organize images according to cards or folders.

If the replacement card or existing folder already contains images recorded previously, the file numbering of the new images may continue from the file numbering of the existing images on the card or in the folder. If you want to save images with the file numbering starting from 0001, use a newly formatted card each time.

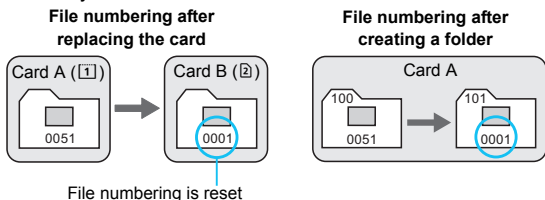

## Manual Reset

**Resets the file numbering to 0001 or to start from file number 0001 in a new folder.**

When you reset the file numbering manually, a new folder is created automatically and the file numbering of images saved to that folder starts from 0001.

This is convenient if you want to use different folders for the images taken yesterday and the ones taken today, for example. After the manual reset, the file numbering returns to continuous or auto reset. (There will be no manual reset confirmation screen.)

**!** If the file number in folder 999 reaches 9999, shooting will not be possible even if the card still has storage capacity. The LCD monitor will display a message telling you to replace the card. Replace it with a new card.

## MENU Setting Copyright Information ☆

When you set the copyright information, it will be recorded to the image as Exif information.

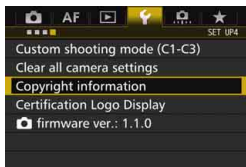

### 1 Select [Copyright information].

- Under the [**4**] tab, select [**Copyright information**], then press <SET>.



### 2 Select the option to be set.

- Select [**Enter author's name**] or [**Enter copyright details**], then press <SET>.



### 3 Enter text.

- Press the <Q> button. The text palette will be highlighted with a color frame, and text can be entered.
- Operate the <DIAL> or <DIAL> to move the cursor and select the desired character. Then press <SET> to enter it.
- You can enter up to 63 characters.
- To delete a character, press the <TRASH> button.
- To cancel the text entry, press the <INFO.> button, then select [OK] on the confirmation screen.

### 4 Exit the setting.

- After entering the text, press the <MENU> button, then select [OK].
- The information is saved.

## Checking the Copyright Information

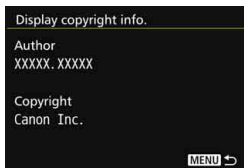

When you select [**Display copyright info.**] in step 2, you can check the [**Author**] and [**Copyright**] information that you entered.

## Deleting the Copyright Information

When you select [**Delete copyright information**] in step 2 on the preceding page, you can delete the [**Author**] and [**Copyright**] information.

 If the entry for “Author” or “Copyright” is long, it may not be displayed entirely when you select [**Display copyright info.**].

 You can also set or check the copyright information with EOS Utility (EOS software, p.534).



# 5

## GPS Settings

This chapter explains the camera's built-in GPS settings. The EOS 7D Mark II (G) can receive satellite navigation signals from GPS satellites (USA), GLONASS satellites (Russia), and the Quasi-Zenith Satellite System (QZSS) "Michibiki" (Japan).

- The GPS function is set to **[Disable]** by default.
- This manual uses the term "GPS" to refer to the satellite navigation function.

**When **[GPS]** is set to **[Enable]** (p.201), the camera will continue to receive GPS signals at regular intervals even after the power is turned off. The battery will thereby drain faster and the number of possible shots will decrease. If you will not use GPS, setting **[GPS]** to **[Disable]** is recommended.**

 When using GPS function, be sure to check the region of use and use the function in accordance with the laws and regulations of the country or region. Be particularly careful when using GPS outside your home country.

# GPS Features

## Geotagging Images

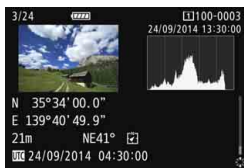

- Geotag information\*<sup>1</sup> (latitude, longitude, elevation) and coordinated universal time\*<sup>2</sup> can be appended to images.
- Using the digital compass (based on magnetic north), the shooting direction can be appended to images.
- These information can be used to show the shooting location and shooting direction on a map displayed on a computer.

\*1: Certain travel conditions or GPS settings may cause inaccurate geotag information to be added to images.

\*2: Coordinated Universal Time, abbreviated UTC, is essentially the same as Greenwich Mean Time.

## Logging the Route Traveled

You can use the GPS logging function to automatically record the camera's location information at set intervals. This geotag information can be viewed on a map displayed on a computer.

\* Certain traveling conditions, locations, or GPS settings may cause inaccurate geotag information to be added to images.

## Setting the Camera Time

The camera time can be set using GPS signals.

## Viewing Images and Information on a Virtual Map

Shooting locations and the route traveled can be viewed on a map displayed on a computer, using the Map Utility (EOS software, p.534).

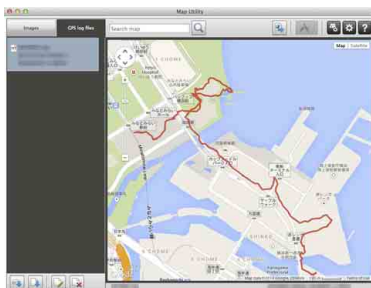

Map data ©2014 ZENRIN -

# GPS Precautions

## ■ Countries and Regions Permitting GPS Function Use

Use of GPS function is restricted in some countries and regions, and illegal use may be punishable under national or local regulations. To avoid violating GPS function regulations, visit the Canon website to check where use is allowed.

Note that Canon cannot be held liable for any problems arising from GPS function use in other countries and regions.

## ■ Model Number

EOS 7D Mark II (G): DS126461

(including GPS module model: CH9-1352)

- In certain countries and regions, the use of GPS function may be restricted. Therefore, be sure to use GPS function in accordance with the laws and regulations of your country or region. Be particularly careful when using GPS function outside your home country.
- Be careful about using GPS function where the operation of electronic devices is restricted.
- Others may be able to locate or identify you by using location data in your geotagged pictures or movies. Be careful when sharing these geotagged images, movies or GPS log files with others, such as when posting them online where many people can view them.
- GPS signal reception may take a longer time in some cases.

Hereby, Canon Inc., declares that this CH9-1352 is in compliance with the essential requirements and other relevant provisions of Directive 1999/5/EC.

Please contact the following address for the original Declaration of Conformity:

**CANON EUROPA N.V.**

Bovenkerkerweg 59, 1185 XB Amstelveen, The Netherlands

**CANON INC.**

30-2, Shimomaruko 3-chome, Ohta-ku, Tokyo 146-8501, Japan



# Acquiring GPS Signals

To acquire GPS signals, take the camera outside where the sky is unobstructed. Face the top of the camera toward the sky while keeping your hands, etc., away from the camera top.

When the signal acquisition conditions are good, it will take the camera approx. 30 sec. to 60 sec. to catch the GPS satellite signals after you set [GPS] to [Enable]. Check that [GPS] is displayed on the LCD panel, then shoot.



## 1 Select [GPS/digital compass settings].

- Under the [F2] tab, select [GPS/digital compass settings], then press < (SET) >.

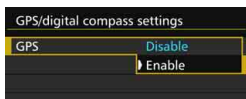

## 2 Set [GPS] to [Enable].

## GPS Acquisition Status

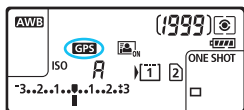

GPS acquisition status is indicated by the [GPS] icon on the LCD panel and on the shooting function settings screen.

**Constant [GPS]:** Signal acquired

**Blinking [GPS]:** Signal not acquired yet

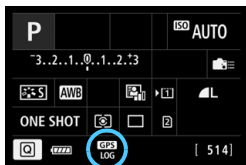

When you shoot while [GPS] is displayed, the image will be geotagged.



- If **[Enable]** is selected, < **GPS** > will still be displayed on the LCD panel even when you turn the camera's power switch to < **OFF** >. Also, since the camera will receive GPS signals at regular intervals, the battery will drain quickly and the number of possible shots will decrease. If you will not use the camera for a prolonged period, set to **[Disable]**.
- The GPS antenna is built-in around the hot shoe. Although the GPS signal can be acquired while an external Speedlite is attached to the hot shoe, the acquisition sensitivity will slightly decrease.
- GPS Receiver GP-E2 (sold separately) cannot be used.

### Poor GPS Coverage

Under the following conditions, the GPS satellite signal will not be properly acquired. As a result, the geotag information may not be recorded or inaccurate geotag information may be recorded.

- Indoors, underground, in tunnels or forests, between buildings, or in valleys.
- Near high-voltage power lines or mobile phones operating on the 1.5 GHz band.
- The camera is left inside a bag, etc.
- When traveling a long distance.
- When traveling through different environments.
- Since GPS satellites move as time passes, satellite movement can interfere with geotagging and cause missing or inaccurate geotag information even in conditions other than the above. Additionally, the geotag information may also include the route travelled even if the camera was used only at one location.



The camera can receive GPS signals even in the vertical orientation.

## Viewing GPS Information

GPS/digital compass settings	
GPS	Enable
Set up	

### 1 Select [Set up].

- Check that [GPS] is set to [Enable].
- Select [Set up], then press <SET>.

GPS/digital compass settings	
Auto time setting	Disable
Position update interval	Every 15s
Digital compass	Disable
GPS information display	
Calibrate digital compass	
GPS Logger	Disable

### 2 Select [GPS information display].

- ▶ Detailed GPS information is displayed.

GPS information display	
Latitude	N30°30'30.0"
Longitude	W30°30'30.0"
Elevation	50m
Direction	NE 45°
UTC	20/09/2014 00:00:00
Satellite reception	3D

### 3 Take the picture.

- Shots taken after GPS signal acquisition are geotagged.



Generally, elevation is not as accurate as latitude and longitude due to the nature of GPS.



- The <signal strength icon> icon indicates signal conditions. When <3D> is displayed, elevation can also be recorded. However, elevation cannot be recorded when <2D> is displayed.
- UTC (Coordinated Universal Time) is essentially the same as Greenwich Mean Time.
- In the sample screen, the NE45° direction indicates northeast 45°.

## Geotagging Information

Play back the images and press the **<INFO.>** button to display the shooting information screen (p.357). Then tilt  up or down to check the geotag information.

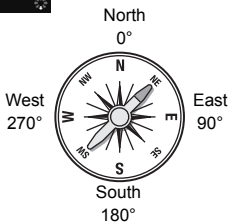
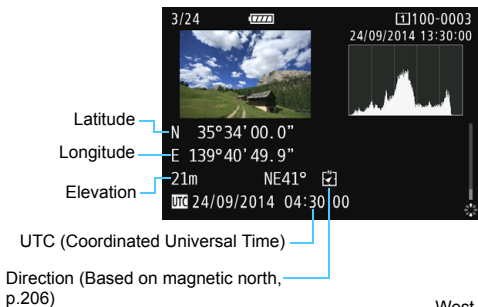

- When you shoot a movie, the GPS information at the time when shooting begins is recorded. Note that signal reception conditions are not recorded.
- Shooting locations can be viewed on a map displayed on a computer, using the Map Utility (EOS software, p.534).



# Setting the Positioning Interval

The interval (time) to update the geotag information can be set. Although updating the geotag information at shorter intervals will make it more accurate, it will reduce the number of possible shots.

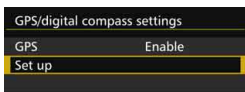

## 1 Select [Set up].

- Check that [GPS] is set to [Enable].
- Select [Set up], then press <SET>.

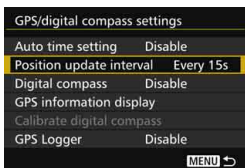

## 2 Select [Position update interval].

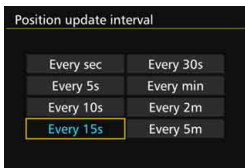

## 3 Set the desired update interval.

- Select the desired update interval, then press <SET>.



- The shorter the interval, the lower the number of possible shots will be.
- If you are in a location where the GPS acquisition condition is not good, the number of possible shots will decrease.
- The nature of GPS may cause some inconsistency in positioning intervals.

# Using the Digital Compass

Camera orientation information (the direction the camera is facing) can be appended to the image.

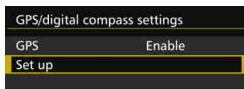

## 1 Select [Set up].

- Check that [GPS] is set to [Enable].
- Select [Set up], then press <SET>.

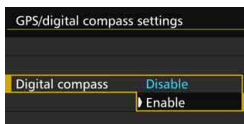

## 2 Set [Digital compass] to [Enable].

- Select [Digital compass], then press <SET>.
- Select [Enable], then press <SET>.
- If the [Calibrate digital compass] screen appears, perform steps 2 and 3 on page 208.

## Compass Display During Shooting

The camera's current orientation can be displayed on the LCD monitor.

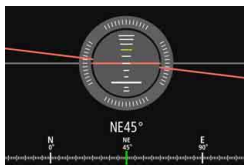

- When you press the <INFO.> button to display the digital compass, the direction will be displayed on the bottom of the screen.



- During Live View shooting and movie shooting, you can confirm the direction using the arrow icon at the location circled in this sample screen.

- During continuous shooting, if you change the camera direction or tilt the camera up or down, the correct direction information may not be recorded.
- The direction information is not recorded to the log file (p.211).

 Since the digital compass uses geomagnetism for direction sensing, correct directions may not be obtained or calibration may not be possible in the following environments.

- In or near buildings (including office buildings, residences built using reinforced concrete or masonry, and underground shopping malls), vehicles (including cars, trains, planes, and boats), or metal structures such as elevators
- Near metals (including steel desks and furnishings), permanent magnets (including magnetic jewelry), or home electronics (including televisions, computers, speakers, or mobile phones)
- Near high-voltage lines (including transmission towers), overhead power lines (including those powering trains), or metal facilities (including footbridges and guardrails)
- At high latitudes

## Calibrating the Digital Compass

While you are using the GPS function, if the **[Calibrate digital compass]** screen appears or if the direction indicated looks questionable, calibrate the digital compass as follows. The digital compass should be calibrated at the actual shooting location.

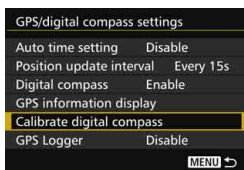

### 1 Select **[Calibrate digital compass]**.

- Check that **[Digital compass]** is set to **[Enable]**.
- Select **[Calibrate digital compass]**, then press **<SET>**.
- ▶ The camera will be ready for calibration.



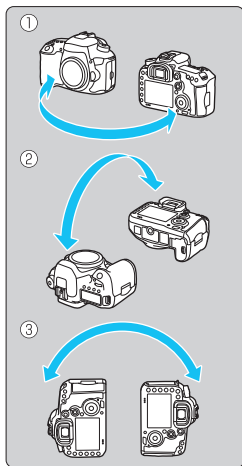

## 2 Move the camera.

- (1) Swing the camera to the left and right by at least  $180^\circ$ .
  - (2) Tilt the camera up and down by at least  $180^\circ$ .
  - (3) Turn the camera by at least  $180^\circ$ .
- Be careful not to drop the camera.
  - Steps (1), (2), and (3) can be performed in any order. Keep moving the camera until the calibration is completed.
  - If the compass is not calibrated after you perform this, turn your body to the right or left and move the camera again.

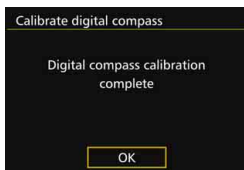

## 3 Exit the calibration.

- When the calibration is completed, a screen indicating completion will be displayed.
- Calibration will be completed normally even if the completion message appears while you are still moving the camera in step 2.

 For safety reasons, detaching the lens from the camera is recommended before you perform the calibration.

# Setting Time from GPS on the Camera

The time information obtained from GPS signals can be set in the camera. The margin of error is approx.  $\pm 1$  sec.

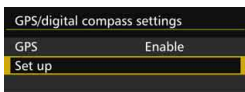

## 1 Select [Set up].

- Check that [GPS] is set to [Enable].
- Select [Set up], then press <SET>.

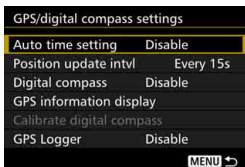

## 2 Select [Auto time setting].

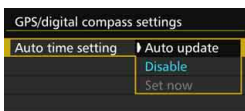

## 3 Select the desired setting.

- Select [Auto update] or [Set now], then press <SET>.
- [Auto update] updates the time when the camera is turned on and a GPS signal is received.



- If signals from at least five GPS satellites cannot be acquired, the time cannot be auto updated. [Set now] will be grayed out and not selectable.
- Even if [Set now] is selected, updating the time may not be possible due to an unfavorable timing of the GPS signal acquisition.
- When [Auto time setting] is set to [Auto update], the date or time cannot be manually set with [Date/Time/Zone] under the [📅2] tab.
- If you use Wireless Transmitter WFT-E7 (Ver. 2/sold separately) and do not want to change the time after performing [Sync time between cameras], set [Auto time setting] to [Disable] in step 2.

# Logging the Route Traveled

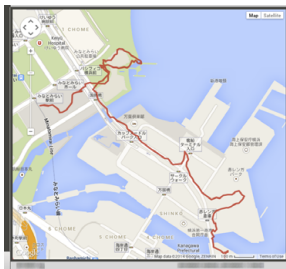

Map data ©2014 ZENRIN -

When using the GPS logging function, the geotag information of the route the camera traveled is automatically recorded in the camera's internal memory.

Shooting locations and the route traveled can be viewed on a map displayed on a computer using the Map Utility (EOS software, p.534).

Note that the GPS logging function will continue to log information even when the camera's power is off, including auto power off.

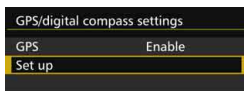

## 1 Select [Set up].

- Check that [GPS] is set to [Enable].
- Select [Set up], then press <SET>.

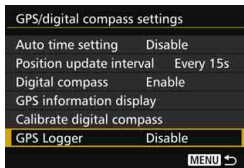

## 2 Select [GPS Logger].



## 3 Set [Log GPS position] to [Enable].

- Select [Log GPS position], then press <SET>.
- Select [Enable], then press <SET>.



- When the GPS logging function is enabled, the [LOG] icon will appear on the shooting function settings screen (p.201).
- When you set the power switch to <OFF> or when auto power off takes effect, <LOG> will be displayed on the LCD panel.

## Geotag Information Logs

Geotag information for the route the camera traveled is recorded at the intervals set with **[Position update interval]** (p.205). The log data is saved in the camera's internal memory by date. The table below shows how many days' worth of data can be saved.

### Log Data Capacity by Positioning Interval (Approx.)

Update Interval	Log Data	Update Interval	Log Data
Every 1 sec.	4.1 days	Every 30 sec.	100 days
Every 5 sec.	20 days	Every 1 min.	100 days
Every 10 sec.	41 days	Every 2 min.	100 days
Every 15 sec.	61 days	Every 5 min.	100 days

\* Assuming 8 hr. of data logged per day.

- The log data saved in the internal memory can be transferred as a log file to a card (p.212).
- One log file is created for each day. The log file name has the date (YYYYMMDD) and a number, for example, 14103100. If the time zone changes (p.47), a new log file will be created.
- If the camera's internal memory becomes full, the oldest log data will be overwritten with the newest log data.

## Battery Consumption During Logging

When **[GPS]** is set to **[Enable]**, the camera will continue to receive GPS signals at set intervals even while the camera's power is switched off. This will drain the battery faster, reducing the number of shots that can be taken. Additionally, when **[Log GPS position]** is set to **[Enable]**, shorter update intervals will drain the battery more quickly.

When you are not traveling or when GPS signals are weak, setting **[GPS]** to **[Disable]** is recommended.

## Downloading Log Data to a Computer

The log data in the camera's internal memory can be downloaded to a computer with EOS Utility (EOS software) or downloaded from a card after transferring the data to the card.

When you use Map Utility (EOS software, p.534) to open a log file saved on your computer, the camera's travel route will be displayed on a map.

## Importing the log data using EOS software

With the camera connected to a computer via the provided interface cable, you can download the log data to the computer with EOS Utility (EOS software). For details, refer to the EOS Utility Instruction Manual.

## Transferring the log data to a card for downloading

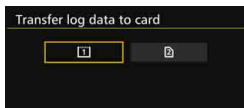
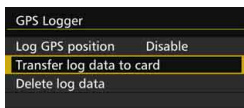

- When [Transfer log data to card] is selected, you can transfer the log data in the internal memory as log files to a CF card [1] or SD card [2]. Note that when log files are transferred to a card, that log data is permanently deleted from the camera's internal memory.

- The log files imported to the card will be stored in the "GPS" folder in the "MISC" folder. The extension is ".LOG".
- Selecting [Delete log data] will completely delete the log data saved in the internal memory. Deleting data may take approx. one minute.





- Use the provided interface cable or one from Canon (p.478). When connecting the interface cable, use the provided cable protector (p.34).
- The GPS antenna is located at the top of the camera's body. For this reason, even when carrying the camera, such as in a bag, try to keep the top of the camera facing upwards, and do not place anything on top of it.
- Set the camera time and date as accurately as possible. Also, set correct time zone and daylight saving time for the shooting location.
- Since the geotag information, date, and time are constantly recorded even when the camera is turned off, the battery will keep draining. When you use the camera again, the battery level may already be low. If necessary, recharge the battery or prepare a charged, spare battery (sold separately).



# 6

## Advanced Operations

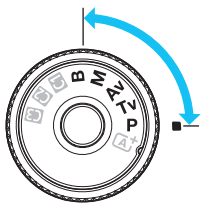

In the **<P>** **<Tv>** **<Av>** **<M>** **<B>** shooting modes, you can select the shutter speed, aperture, and other camera settings to change the exposure and obtain the desired result.

- A ☆ icon at the upper right of a page title indicates a function that can be used only in these modes: **<P>** **<Tv>** **<Av>** **<M>** **<B>**.
- After you press the shutter button halfway and let go, the exposure values will remain displayed in the viewfinder and on the LCD panel for 4 sec. (4).
- For the functions settable in each shooting mode, see page 480.



Set the **<LOCK>** switch to the left.

# P: Program AE

The camera automatically sets the shutter speed and aperture to suit the subject's brightness. This is called Program AE.

\* <P> stands for Program.

\* AE stands for Auto Exposure.



## 1 Set the Mode Dial to <P>.



## 2 Focus on the subject.

- Look through the viewfinder and aim the AF point over the subject. Then press the shutter button halfway.
- ▶ When focus is achieved, the focus indicator <●> in the viewfinder will light up (in One-Shot AF mode).
- ▶ The shutter speed and aperture will be set automatically and displayed in the viewfinder and on the LCD panel.



## 3 Check the display.

- A standard exposure will be obtained as long as the shutter speed and aperture displays do not blink.



## 4 Take the picture.

- Compose the shot and press the shutter button completely.



- If the “30” shutter speed and the lower f/number blink, it indicates underexposure. Increase the ISO speed or use flash.



- If the “8000” shutter speed and the higher f/number blink, it indicates overexposure. Lower the ISO speed or use an ND filter (sold separately) to reduce the amount of light entering the lens.



### Differences Between <P> and <A+> Modes

In the <A+> mode, many functions, such as the AF operation and metering mode, are set automatically to prevent spoiled shots. The functions you can set are limited. With <P> mode, only the shutter speed and aperture are set automatically. You can freely set the AF operation, metering mode, and other functions (p.480).

### Program Shift

- In the Program AE mode, you can freely change the shutter speed and aperture combination (Program) set automatically by the camera while maintaining the same exposure. This is called Program shift.
- To shift the program, press the shutter button halfway, then turn the <A+> dial until the desired shutter speed or aperture is displayed.
- Program shift will be canceled automatically when the metering timer (4) ends (exposure setting display turns off).
- Program shift cannot be used with flash.

# Tv: Shutter-Priority AE

In this mode, you set the shutter speed and the camera automatically sets the aperture to obtain the standard exposure matching the brightness of the subject. This is called shutter-priority AE. A faster shutter speed can freeze the action of a moving subject. A slower shutter speed can create a blurred effect, giving the impression of motion.

\* <Tv> stands for Time value.



Blurred motion  
(Slow shutter speed: 1/30 sec.)



Frozen action  
(Fast shutter speed: 1/2000 sec.)



## 1 Set the Mode Dial to <Tv>.

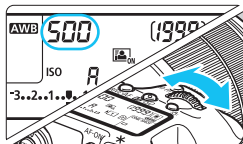

## 2 Set the desired shutter speed.

- While looking at the LCD panel or through the viewfinder, turn the <  > dial.

## 3 Focus on the subject.

- Press the shutter button halfway.
- ▶ The aperture is set automatically.



## 4 Check the viewfinder display and shoot.

- As long as the aperture is not blinking, a standard exposure will be obtained.



- If the lower f/number blinks, it indicates underexposure. Turn the  dial to set a slower shutter speed until the aperture stops blinking or set a higher ISO speed.



- If the higher f/number blinks, it indicates overexposure. Turn the  dial to set a faster shutter speed until the aperture stops blinking or set a lower ISO speed.



### Shutter Speed Display

The shutter speeds from “8000” to “4” indicate the denominator of the fractional shutter speed. For example, “125” indicates 1/125 sec., “0”5” indicates 0.5 sec. and “15”” is 15 sec.

## Av: Aperture-Priority AE

In this mode, you set the desired aperture and the camera sets the shutter speed automatically to obtain the standard exposure suiting the subject brightness. This is called aperture-priority AE. A higher f/number (smaller aperture hole) will make more of the foreground and background fall within acceptable focus. On the other hand, a lower f/number (larger aperture hole) will make less of the foreground and background fall within acceptable focus.

\* <Av> stands for Aperture value (aperture opening).



Blurred background  
(With a low aperture f/number: f/5.6)



Sharp foreground and background  
(With a high aperture f/number: f/32)

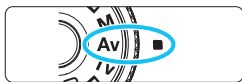

### 1 Set the Mode Dial to <Av>.

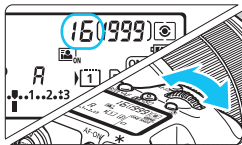

### 2 Set the desired aperture.

- While looking at the LCD panel or viewfinder, turn the <  > dial.

### 3 Focus on the subject.

- Press the shutter button halfway.
- ▶ The shutter speed is set automatically.



### 4 Check the viewfinder display and shoot.

- As long as the shutter speed is not blinking, a standard exposure will be obtained.





- If the “30” shutter speed blinks, it indicates underexposure. Turn the  dial to set a larger aperture (lower f/number) until the shutter speed blinking stops or set a higher ISO speed.

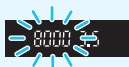

- If the “8000” shutter speed blinks, it indicates overexposure. Turn the  dial to set a smaller aperture (higher aperture f/number) until the shutter speed blinking stops or set a lower ISO speed.



### Aperture Display

The higher the f/number, the smaller the aperture opening will be. The f/number displayed will differ depending on the lens. If no lens is attached to the camera, “00” will be displayed for the aperture.

## Depth-of-Field Preview ☆

The aperture opening (diaphragm) changes only at the moment when the picture is taken. Otherwise, the aperture remains fully open. Therefore, when you look at the scene through the viewfinder or on the LCD monitor, the depth of field will look narrow.

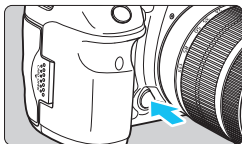

Press the depth-of-field preview button to stop down the lens to the current aperture setting and check the depth of field (range of acceptable focus).



- A higher f/number will make more of the foreground and background fall within acceptable focus. However, the viewfinder will look darker.
- While looking at the Live View image (p.286), you can change the aperture and press the depth-of-field preview button to see how the depth of field changes.
- The exposure will be locked (AE lock) while the depth-of-field preview button is pressed.

# M: Manual Exposure

In this mode, you set both the shutter speed and aperture as desired. To determine the exposure, refer to the exposure level indicator in the viewfinder or use a commercially-available exposure meter. This method is called manual exposure.

\* <M> stands for Manual.



**1 Set the Mode Dial to <M>.**

**2 Set the ISO speed (p.154).**

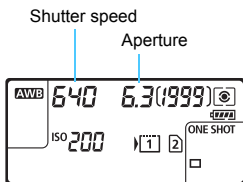

**3 Set the shutter speed and aperture.**

- To set the shutter speed, turn the <shutter speed dial> dial.
- To set the aperture, turn the <aperture dial> dial.
- If it cannot be set, set the <LOCK> switch to the left, then turn the <shutter speed dial> or <aperture dial> dial.



**4 Focus on the subject.**

- Press the shutter button halfway.
- ▶ The exposure setting will be displayed in the viewfinder and on the LCD panel.
- On the viewfinder's right side, the exposure level indicator <■> shows how far off the current exposure level is from the standard exposure level <▶>.

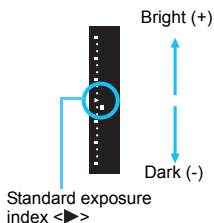

**5 Set the exposure and take the picture.**

- Check the exposure level indicator and set the desired shutter speed and aperture.
- If the exposure level exceeds  $\pm 3$  stops from the standard exposure, the end of the exposure level indicator will display <▲> or <▼>.

## Exposure Compensation with Auto ISO

If the ISO speed is set to **A** (AUTO), you can set exposure compensation (p.226) as follows.

- [2: Expo.comp./AEB]
- Under [3: Custom Controls], use [**SET**: Expo comp (hold btn, turn )] (p.455) or [: Expo comp (hold down lever, turn )] (p.455).
- Quick Control (p.61)

Set the exposure compensation amount while checking the exposure level indicator on the lower part of the viewfinder or on the LCD panel.



- If Auto ISO is set, the ISO speed setting will change to suit the shutter speed and aperture in order to obtain a standard exposure. Therefore, you may not obtain the desired exposure effect. In such a case, set the exposure compensation.
- If flash is used when Auto ISO is set, exposure compensation will not be applied even if an exposure compensation amount is set.



- Under [2: Auto Lighting Optimizer], if the checkmark <✓> for [Disabled in M or B modes] is removed, Auto Lighting Optimizer can be set even in the <M> mode (p.175).
- When Auto ISO is set, you can press the <✳> button to lock the ISO speed.
- If you press the <✳> button and recompose the shot, you can see the exposure level difference on the exposure level indicator compared to when you pressed the <✳> button.
- If exposure compensation (p.226) was applied in <P>, <Tv>, or <Av> mode, and then the shooting mode is switched to <M> with Auto ISO set, the exposure compensation amount already set will be maintained.
- With Auto ISO set and [1: ISO speed setting increments] set to [1/2-stop], any 1/2-stop exposure compensation will be implemented with the ISO speed (1/3 stop) and shutter speed. However, the shutter speed displayed will not change.

## Selecting the Metering Mode ☆

You can select one of four methods to measure the subject brightness. In the <A+> mode, evaluative metering is set automatically.

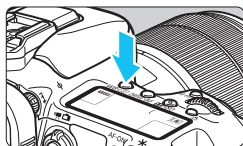

**1** Press the <WB>  button. (6)

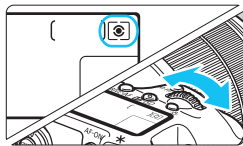



**2** Select the metering mode.

- While looking at the LCD panel or viewfinder, turn the <WB> dial.

: Evaluative metering

: Partial metering

: Spot metering

: Center-weighted average metering

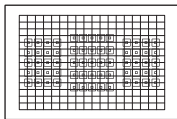

### **Evaluative metering**

This is a general-purpose metering mode suited even for backlit subjects. The camera sets the exposure automatically to suit the scene.

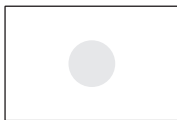

### **Partial metering**

Effective when the background is much brighter than the subject due to backlighting, etc. Partial metering covers approx. 6% of the viewfinder area at the center.

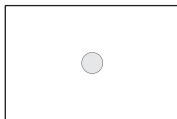

 **Spot metering**







This is for metering a specific spot of the subject or scene. Spot metering covers approx. 1.8% of the viewfinder area at the center. The spot metering circle will be displayed in the viewfinder.



 **Center-weighted average metering**

The metering is weighted at the center and then averaged for the entire scene.



- With  (Evaluative metering), the exposure setting will be locked when you press the shutter button halfway and focus is achieved. In the  (Partial metering),  (Spot metering), and  (Center-weighted average metering) modes, the exposure is set at the moment the photo is taken. (Pressing the shutter button halfway does not lock the exposure.)
- When  (Spot metering) is set, you can display  in the viewfinder and on the LCD panel (p.441).

## ☑ Setting Exposure Compensation ☆

Exposure compensation can brighten (increased exposure) or darken (decreased exposure) the standard exposure set by the camera. Exposure compensation can be set in the <P>, <Tv>, and <Av> shooting modes. Although you can set the exposure compensation up to  $\pm 5$  stops in 1/3-stop increments, the exposure compensation indicator in the viewfinder and on the LCD panel can only display the setting up to  $\pm 3$  stops. If you want to set the exposure compensation setting beyond  $\pm 3$  stops, use the Quick Control (p.61) or follow the instructions for [📷2: Expo.comp./AEB] on the next page. If the <M> mode with the Auto ISO set, see page 223 to set the exposure compensation.

### 1 Check the exposure.

- Press the shutter button halfway (📷) and check the exposure level indicator.

Increased exposure for a brighter image

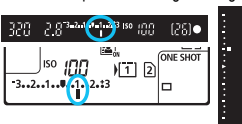

### 2 Set the exposure compensation amount.

- While looking at the viewfinder or LCD panel, turn the <📷> dial.
- If it cannot be set, set the <LOCK▶> switch to the left, then turn the <📷> dial.

Decreased exposure for a darker image

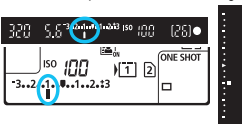

### 3 Take the picture.

- To cancel exposure compensation, set the exposure level indicator <📷> to the standard exposure index (<▼> or <📷>).

📷 If [📷2: Auto Lighting Optimizer] (p.175) is set to any setting other than [Disable], the image may still look bright even if a decreased exposure compensation for a darker image is set.

- The exposure compensation amount will remain in effect even after you set the power switch to <OFF>.
- After setting the exposure compensation amount, you can prevent the exposure compensation amount from changing accidentally by setting the <LOCK▶> switch to the right.
- If the exposure compensation amount exceeds  $\pm 3$  stops, the end of the exposure level indicator will display <▶/▲> or <◀/▼>.

# Auto Exposure Bracketing (AEB) <sup>☆</sup>

By changing the shutter speed or aperture automatically, the camera brackets the exposure up to  $\pm 3$  stops in  $1/3$ -stop increments for three successive shots. This is called AEB.

\* AEB stands for Auto Exposure Bracketing.

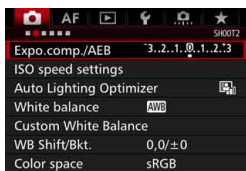

## 1 Select [Expo.comp./AEB].

- Under the [CAMERA] tab, select [Expo.comp./AEB], then press <SET>.

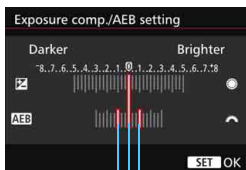

## 2 Set the AEB range.

- Turn the <WHEEL> dial to set the AEB range. If you turn <WHEEL>, you can set the exposure compensation.
- Press <SET> to set it.
- When you exit the menu, <CAMERA> and the AEB range will be displayed on the LCD panel.

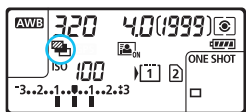





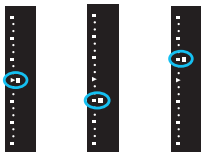



## 3 Take the picture.

- Three bracketed shots will be taken according to the drive mode set in this sequence: Standard exposure, decreased exposure, and increased exposure.
- AEB will not be automatically canceled. To cancel AEB, follow step 2 to turn off the AEB range display.



Standard exposure    Decreased exposure    Increased exposure

-  During AEB, <✳> in the viewfinder and < > on the LCD panel will blink.
- If the drive mode is set to < > or < S >, press the shutter button three times for each shot. When < H >, < >, or < S > is set and you hold down the shutter button completely, the three bracketed shots will be taken continuously and the camera will automatically stop shooting. When < 10 > or < 2 > is set, the three bracketed shots will be taken continuously after a 10-sec. or 2-sec. delay.
- You can set AEB in combination with exposure compensation.
- If the AEB range exceeds  $\pm 3$  stops, the end of the exposure level indicator will display <▶/▲> or <◀/▼>.
- AEB cannot be used with flash, bulb exposures, or when [Multi Shot Noise Reduction] or [HDR Mode] is set.
- AEB will be canceled automatically when you set the power switch to <OFF> or when the flash is ready to fire.



## ✳ AE Lock ☆

Use AE lock when the area of focus is to be different from the exposure metering area or when you want to take multiple shots at the same exposure setting. Press the <✳> button to lock the exposure, then recompose and take the shot. This is called AE lock. It is effective for backlit subjects, etc.

### 1 Focus on the subject.

- Press the shutter button halfway.
- ▶ The exposure setting will be displayed.

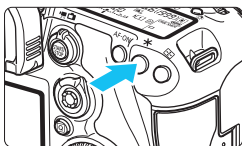

### 2 Press the <✳> button. (ⓘ4)



- ▶ The <✳> icon lights up in the viewfinder to indicate that the exposure setting is locked (AE lock).
- Each time you press the <✳> button, the current exposure setting is locked.



### 3 Recompose and take the picture.

- The exposure level indicator on the right of the viewfinder will show the AE lock exposure level and the current exposure level in real-time.
- If you want to maintain the AE lock while taking more shots, hold down the <✳> button and press the shutter button to take another shot.

## AE Lock Effects

Metering Mode (p.224)	AF Point Selection Method (p.93)	
	Automatic Selection	Manual Selection
 *	AE lock is applied at the AF point that achieved focus.	AE lock is applied at the selected AF point.
	AE lock is applied at the center AF point.	

\* When the lens's focus mode switch is set to <MF>, AE lock is applied at the center AF point.

 AE lock is not possible with bulb exposures.

## B: Bulb Exposures

In this mode, the shutter stays open as long as you hold down the shutter button completely, and closes when you let go of the shutter button. This is called bulb exposure. Use bulb exposures for night scenes, fireworks, the heavens, and other subjects requiring long exposures.



### 1 Set the Mode Dial to <B>.

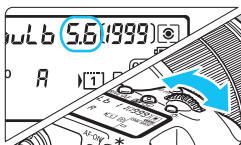

### 2 Set the desired aperture.

- While looking at the LCD panel or the viewfinder, turn the <☀> or <☾> dial.

Elapsed exposure time

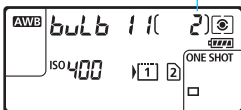

### 3 Take the picture.

- The exposure will continue for as long as you keep the shutter button pressed completely.
- ▶ The elapsed exposure time will be displayed on the LCD panel.

- ⚠ Long exposures produce more noise than usual.
- If Auto ISO is set, the ISO speed will be ISO 400 (p.156).
- For a bulb exposure, if you use both the self-timer and mirror lockup instead of the bulb timer, keep pressing the shutter button completely (self-timer delay time + bulb exposure time). If you let go of the shutter button during the self-timer countdown, there will be a shutter-release sound, but no picture will be taken. If you use the bulb timer under the same shooting conditions, you need not hold down the shutter button completely.
- Do not point the camera toward an intense light source, such as the sun on a sunny day or an intense artificial light source. Doing so may damage the image sensor or the camera's internal components.



- With [**3**: Long exp. noise reduction], you can reduce the noise generated during long exposures (p.178).
- For bulb exposures, using a tripod and bulb timer is recommended. Using mirror lockup (p.246) with bulb exposures is also possible.
- You can also shoot bulb exposures by using Remote Switch RS-80N3 or Timer Remote Controller TC-80N3 (both sold separately, p.248).
- You can also use Remote Controller RC-6 (sold separately, p.248) for bulb exposures. When you press the remote controller's transmit button, the bulb exposure will start immediately or 2 sec. later. Press the button again to stop the bulb exposure.

## Bulb Timer ☆

You can preset the bulb exposure's exposure time. With the bulb timer, you need not hold down the shutter button during the bulb exposure. This reduces camera shake.

The bulb timer can be set only in the <B> (Bulb) shooting mode. It cannot be set (or will not function) in any other shooting mode.

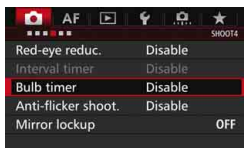

### 1 Select [Bulb timer].

- Under the [**4**] tab, select [**Bulb timer**], then press <SET>.

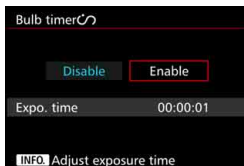

### 2 Select [Enable].

- Select [**Enable**], then press <INFO.> button.

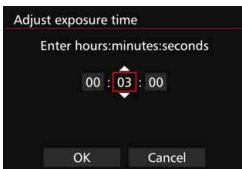

### 3 Set the desired exposure time.

- Select the hour, minute, or second.
- Press <SET> so <⏸> is displayed.
- Set the desired number, then press <SET> (Returns to <□>).

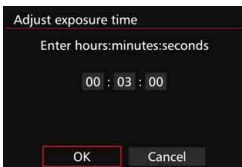

### 4 Select [OK].

- ▶ The set time will be displayed on the menu screen.
- ▶ <⏸> will be displayed on the LCD panel.

Elapsed exposure time

### 5 Take the picture.

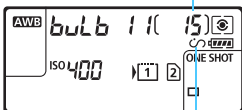

- ▶ Press the shutter button completely, and the bulb exposure will start and continue until the set time elapses.
- To cancel the timer setting, set [Disable] in step 2.

- If you press the shutter button completely while the bulb timer is operating, the bulb exposure will stop.
- Doing any of the following will cancel the bulb timer (reverts to [Disable]): Set the power switch to <OFF>, display the movie shooting screen, or change the shooting mode from <B>.

# HDR: HDR (High Dynamic Range) Shooting ☆

Highlight detail and shadow detail are retained for a high dynamic range of tones even with high-contrast scenes. HDR shooting is effective for landscape and still-life shots.

**With HDR shooting, three images of different exposures (standard exposure, underexposure, and overexposure) are captured for each shot and then merged together automatically. The HDR image is recorded as a JPEG image.**

\* HDR stands for High Dynamic Range.

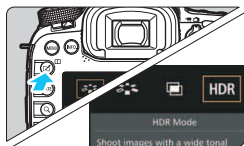

1 Press the button.

2 Select the HDR mode.

- Select [HDR], then press <SET>.
- ▶ The HDR mode screen will appear.

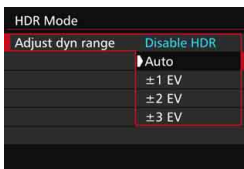

3 Set [Adjust dyn range].

- Select the desired dynamic range setting, then press <SET>.
- Selecting [Auto] will have the dynamic range set automatically depending on the image's overall tonal range.
- The higher the number, the wider the dynamic range will be.
- To exit HDR shooting, select [Disable HDR].

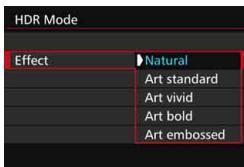

4 Set [Effect].

- Select the desired effect, then press <SET>.



● You can also set HDR shooting with [3: HDR Mode].

## Effects

- **Natural**

For images preserving a wide tonal range where the highlight and shadow details would otherwise be lost.

- **Art standard**

While the highlight and shadow details will be better preserved than with [**Natural**], the contrast will be lower, and the gradation flatter to have the picture look like a painting. The subject outlines will have bright (or dark) edges.

- **Art vivid**

The colors are more saturated than with [**Art standard**], and the low contrast and flat gradation create a graphic art effect.

- **Art bold**

The colors are the most saturated, making the subject pop out, and the picture look like an oil painting.

- **Art embossed**

The color saturation, brightness, contrast and gradation are decreased to make the picture look flat. The picture looks faded and old. The subject outlines will have bright (or dark) edges.

	Art standard	Art vivid	Art bold	Art embossed
Saturation	Standard	High	Higher	Low
Bold outline	Standard	Weak	Strong	Stronger
Brightness	Standard	Standard	Standard	Dark
Tone	Flat	Flat	Flat	Flatter

 Each effect will be applied based on the characteristics of the Picture Style currently set (p.160).

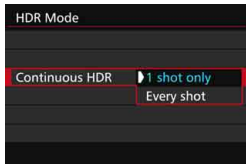

## 5 Set [Continuous HDR].

- Select either [**1 shot only**] or [**Every shot**], then press < (SET) >.
- With [**1 shot only**], HDR shooting will be canceled automatically after the shooting ends.
- With [**Every shot**], HDR shooting continues until the setting in step 3 is set to [**Disable HDR**].

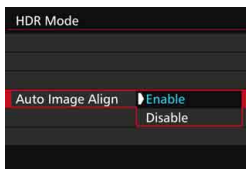

## 6 Set [Auto Image Align].

- For handheld shooting, select [**Enable**]. When using a tripod, select [**Disable**], then press < (SET) >.

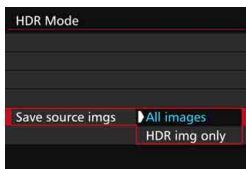

## 7 Set the images to be saved.

- To save all three images and the merged HDR image, select [**All images**], then press < (SET) >.
- To save only the HDR image, select [**HDR img only**], then press < (SET) >.

## 8 Take the picture.

- HDR shooting is possible with viewfinder shooting and Live View shooting.
- ▶ <HDR> will be displayed on the LCD panel.
- When you press the shutter button completely, three consecutive images will be captured, and the HDR image will be recorded to the card.

- If the image-recording quality is set to RAW, the HDR image will be recorded in **L** quality. If the image-recording quality is set to RAW+JPEG, the HDR image will be recorded in the JPEG quality set.
- HDR shooting is not possible with ISO expansion (H1, H2). HDR shooting is possible within ISO 100 - ISO 16000.
- The flash will not fire during HDR shooting.
- During HDR shooting, the settings of [**Distortion**], [**2: Auto Lighting Optimizer**], [**3: Highlight tone priority**], and [**5: Expo. simulation**] will be automatically switched to [**Disable**].
- AEB cannot be set.
- If you shoot a moving subject, the subject's movement may leave afterimages.
- In HDR shooting, 3 images are captured with different shutter speeds set automatically. Therefore, even in <Tv> and <M> shooting modes, the shutter speed will be shifted based on the shutter speed you set.
- To prevent camera shake, a high ISO speed may be set.





- When shooting HDR images with **[Auto Image Align]** set to **[Enable]**, AF point display information (p.359) and Dust Delete Data (p.407) will not be appended to the image.
- If you perform handheld HDR shooting while **[Auto Image Align]** is set to **[Enable]**, image periphery will be slightly cropped and resolution will be slightly lowered. Also, if the images cannot be aligned properly due to camera shake, etc., auto image alignment may not take effect. Note that when shooting with excessively bright or dark exposure settings, auto image alignment may not work properly.
- If you perform handheld HDR shooting while **[Auto Image Align]** is set to **[Disable]**, the 3 images may not be properly aligned and the HDR effect may be minimal. Using a tripod is recommended.
- Auto image alignment may not work properly with repetitive patterns (lattice, stripes, etc.) or flat, single-tone images.
- The color gradation of the sky or white walls may not be reproduced correctly. Irregular colors, irregular exposure or noise may appear.
- HDR shooting under fluorescent or LED lighting may result in unnatural color reproduction of the illuminated areas.
- With HDR shooting, the three images will be merged after you take a picture. Therefore, it will take a longer time to record the HDR image to the card than with normal shooting. During the processing of the images, “**buSY**” will be displayed in the viewfinder and on the LCD panel, and you cannot take another picture until the processing is completed.
- If you change the shooting mode or switch to movie shooting after setting HDR shooting, HDR shooting setting may be cleared (**[Adjust dyn range]** setting may be switched to **[Disable HDR]**).

## Multiple Exposures ☆

You can shoot two to nine exposures to be merged into one image. If you shoot multiple-exposure images with Live View shooting (p.285), you can see how the single exposures are being merged while shooting.

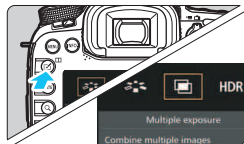

1 Press the button.

2 Select **Multiple exposure**.

- Select [], then press <SET>.
- ▶ The multiple exposure setting screen will appear.

3 Set [**Multiple exposure**].

- Select [**On:Func/Ctrl**] or [**On:ContShtng**], then press <SET>.
- To exit shooting multiple exposures, select [**Disable**].

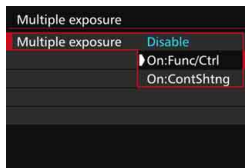

- **On: Func/Ctrl (Function and control priority)**

Convenient when you want to shoot multiple exposures while checking the result as you proceed. During continuous shooting, the continuous shooting speed will decrease greatly.

- **On: ContShtng (Continuous shooting priority)**

Geared for continuous multiple-exposure shooting of a moving subject. Continuous shooting is possible, but the following operations are disabled during shooting: menu viewing, Live View display, image review after image capture, image playback, and undo last image (p.244).

Also, only the multiple-exposure image will be saved. (The single exposures merged in the multiple-exposure image will not be saved.)

You can also set multiple exposure with [**3: Multiple exposure**].

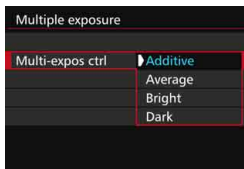

## 4 Set [Multi-expos ctrl].

- Select the desired multiple-exposure control method, then press < (SET) >.

### ● Additive

The exposure of each single exposure is added cumulatively. Based on the [No. of exposures], set a negative exposure compensation. Refer to the basic guide below to set a negative exposure compensation.

#### Exposure Compensation Setting Guide for Multiple Exposures

Two exposures: -1 stop, three exposures: -1.5 stop, four exposures: -2 stops

### ● Average

Based on the [No. of exposures], negative exposure compensation is set automatically as you shoot multiple exposures. If you shoot multiple exposures of the same scene, the exposure of the subject's background will be automatically controlled to obtain a standard exposure.

### ● Bright/Dark

The brightness (or darkness) of the base image and the images to be added are compared at the same position, and then the bright (or dark) part will be left in the picture. Depending on the overlapping colors, the colors may be mixed depending on the brightness (or darkness) ratio of the compared images.

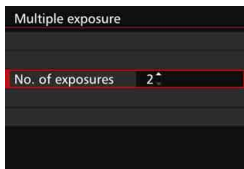

## 5 Set the [No. of exposures].

- Select the number of exposures, then press < (SET) >.
- You can set it from 2 to 9 exposures.

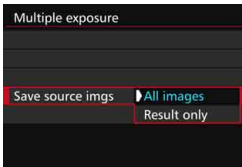

## 6 Set the images to be saved.

- To save all the single exposures and the merged multiple-exposure image, select **[All images]**, then press  $\langle \text{SET} \rangle$ .
- To save only the merged multiple-exposure image, select **[Result only]**, then press  $\langle \text{SET} \rangle$ .

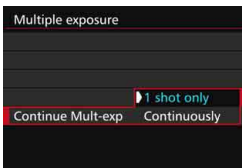

## 7 Set [Continue Mult-exp].

- Select either **[1 shot only]** or **[Continuously]**, then press  $\langle \text{SET} \rangle$ .
- With **[1 shot only]**, multiple-exposure shooting will be canceled automatically after the shooting ends.
- With **[Continuously]**, multiple-exposure shooting continues until the setting in step 3 is set to **[Disable]**.



Remaining number of exposures

## 8 Take the first exposure.

- When **[On:Func/Ctrl]** is set, the captured image will be displayed.
- The  $\langle \text{Image icon} \rangle$  icon will blink.
- The number of remaining exposures is displayed in brackets [ ] in the viewfinder or on the screen.
- Pressing the  $\langle \text{Image icon} \rangle$  button enables you to view the captured image (p.244).

## 9 Shoot subsequent exposures.

- ▶ When [**On:Func/Ctrl**] is set, the merged multiple-exposure image will be displayed.
- With Live View shooting, the multiple-exposure images merged so far will be displayed. By pressing the <**INFO.**> button, you can display only the Live View image.
- After you shoot the set number of exposures, multiple-exposure shooting will exit. With continuous shooting, after you finish shooting the set number of exposures while holding down the shutter button, the shooting will stop.



- The image-recording quality, ISO speed, Picture Style, high ISO speed noise reduction and color space, etc. set for the first single exposure will also be set for the subsequent exposures.
- [**📷5: Aspect ratio**] will be fixed at 3:2.
- During multiple exposure shooting, the settings of [**📷1: Lens aberration correction**], [**📷2: Auto Lighting Optimizer**], and [**📷3: Highlight tone priority**] will be automatically switched to [**Disable**].
- If [**📷3: Picture Style**] is set to [**Auto**], [**Standard**] will be applied for shooting.
- If [**On:Func/Ctrl**] and [**Additive**] are both set, the image displayed during shooting may look noisy. However, when you finish shooting the set number of exposures, noise reduction will be applied and the final multiple-exposure image will be less noisy.
- If you perform Live View shooting while [**On:ContShtng**] is set, the Live View function will stop automatically after the first shot is taken. From the second shot onward, shoot while looking through the viewfinder.



When [**On:Func/Ctrl**] is set, you can press the <**▶**> button to view the multiple exposures taken so far or delete the last single exposure (p.244).

- With multiple exposures, the more exposures there are, the more noticeable the noise, irregular colors, and banding will be. Also, as noise increases with higher ISO speeds, shooting at low ISO speeds is recommended.
- If [**Additive**] is set, the image processing after taking the multiple exposures will take time. (The access lamp will light up for longer than usual.)
- If you perform Live View shooting while [**On:Func/Ctrl**] and [**Additive**] are both set, the Live View function will stop automatically when the multiple-exposure shooting ends.
- In step 9, the brightness and noise of the multiple-exposure image displayed during Live View shooting will be different from the final multiple-exposure image recorded.
- If [**On:ContShtng**] is set, let go of the shutter button after shooting the set number of exposures.
- Doing any of the following will cancel the multiple-exposure shooting: Set the power switch to <**OFF**>, replace the battery, replace the card, or switch to movie shooting.
- If you switch the shooting mode to <**A**<sup>+</sup>> or <**1**/**2**/**3**> while shooting, multiple-exposure shooting will end.
- If you connect the camera to a computer or printer, multiple-exposure shooting will not be possible. If you connect the camera to a computer or printer during shooting, multiple-exposure shooting will stop.

## Merging Multiple Exposures with an Image Recorded on the Card

You can select an image recorded on the card as the first single exposure. The original of the selected image will remain intact.



**You can only select RAW images.** You cannot select M RAW/S RAW or JPEG images.

Multiple exposure	
Multiple exposure	On:Func/Ctrl
Multi-expos ctrl	Additive
No. of exposures	3
Save source imgs	All images
Continue Mult-exp	1 shot only
Select image for multi. expo.	
Deselect img	

### 1 Select [Select image for multi. expo.].

- ▶ The images on the card will be displayed.





### 2 Select an image.

- Turn the <  > dial to select the image to be used as the first single exposure, then press <  >.
- Select [OK].
- ▶ The file number of the selected image will be displayed at the bottom of the screen.

### 3 Take the picture.

- When you select the first image, the number of remaining exposures as set with [No. of exposures] will decrease by 1. For example, if [No. of exposures] is 3, you can shoot two exposures.



- The following cannot be selected as the first single exposure: Images shot with [ 3: Highlight tone priority] set to [Enable], images whose [Aspect ratio] is set to any setting other than [3:2] (p.295), and images having cropping information (p.443).
- [Disable] will be applied for [ 1: Lens aberration correction] and [ 3: Highlight tone priority] regardless of the settings of the RAW image selected as the first single exposure.
- The ISO speed, Picture Style, high ISO speed noise reduction, and color space, etc. set for the first RAW image will also apply for the subsequent images.
- If [ 3: Picture Style] is Auto for the RAW image selected as the first single exposure, Standard will be applied for shooting.
- You cannot select an image taken with another camera.

- You can also select a **RAW** multiple-exposure image as the first single exposure.
- If you select [**Deselect img**], the selected image will be canceled.

## Checking and Deleting Multiple Exposures During Shooting

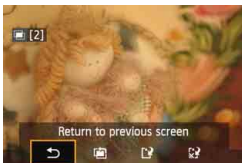

When [**On:Func/Ctrl**] is set and you have not finished shooting the set number of exposures, you can press the <▶> button to view the merged multiple-exposure image so far. You can check how it looks and the exposure. (Not possible when [**On:ContShrng**] is set.)

If you press the <⏮> button, the operations possible during multiple-exposure shooting will be displayed.

Operation	Description
<b>Undo last image</b>	Deletes the last image you shot (shoot another image). The number of remaining exposures will increase by 1.
<b>Save and exit</b>	If [ <b>Save source imgs: All images</b> ] is set, all of the single exposures and the merged multiple-exposure image will be saved before exiting. If [ <b>Save source imgs: Result only</b> ] is set, only the multiple-exposure image merged so far will be saved before exiting.
<b>Exit without saving</b>	None of the images will be saved before exiting.
<b>Return to previous screen</b>	The screen before you pressed the <⏮> button will reappear.

During multiple-exposure shooting, you can only play back multiple-exposure images.



## ? FAQ

### • Are there any restrictions on the image-recording quality?

All JPEG image-recording quality settings can be selected. If **M RAW** or **S RAW** is set, the merged multiple-exposure will be a **RAW** image.

Image-Recording Quality Setting	Single Exposures	Merged Multiple-Exposure
JPEG	JPEG	JPEG
<b>RAW</b>	<b>RAW</b>	<b>RAW</b>
<b>M RAW/S RAW</b>	<b>M RAW/S RAW</b>	<b>RAW</b>
<b>RAW+JPEG</b>	<b>RAW+JPEG</b>	<b>RAW+JPEG</b>
<b>M RAW/S RAW+JPEG</b>	<b>M RAW/S RAW+JPEG</b>	<b>RAW+JPEG</b>

### • Can I merge images recorded on the card?

With [**Select image for multi. expo.**], you can select the first single exposure from the images recorded on the card (p.243). Note that you cannot merge multiple images already recorded on the card.

### • Are multiple exposures possible with Live View shooting?

With [**On:Func/Ctrl**] set, you can shoot multiple exposures with Live View shooting (p.285). Note that [**5: Aspect ratio**] will be fixed at [**3:2**].

### • What file numbers are used for saving merged multiple-exposures?

If all images are set to be saved, the merged multiple-exposure image file number will be the serial number coming after the file number of the final single exposure used to create the merged multiple-exposure image.

### • Will auto power off take effect during multiple-exposure shooting?

As long as [**2: Auto power off**] is set to any setting other than [**Disable**], the power will turn off automatically after 30 min. of non-operation. If the auto power off takes effect, multiple-exposure shooting will end, and multiple-exposure settings will be canceled. Before starting the multiple-exposure shooting, the auto power off will take effect as set with the camera, and multiple-exposure settings will be canceled.

# Mirror Lockup <sup>☆</sup>

Although using the self-timer or a remote switch can prevent camera shake, using mirror lockup to prevent camera vibrations (mirror shock) can also help when you use a super telephoto lens or shoot close ups (macro photography).

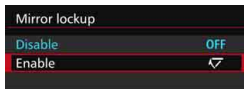
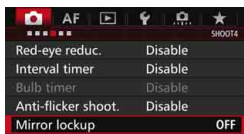

## 1 Set [Mirror lockup] to [Enable].

- Under the [CAMERA] tab, select [Mirror lockup], then press <SET>.
- Select [Enable], then press <SET>.

## 2 Focus on the subject, then press the shutter button completely.

- ▶ The mirror will swing up.

## 3 Press the shutter button completely again.

- ▶ The picture is taken and the mirror goes back down.

- In very bright light, such as at the beach or a ski slope on a sunny day, take the picture promptly after mirror lockup.
- Do not point the camera toward the sun. The sun's heat can scorch and damage the shutter curtains.
- During mirror lockup, shooting function settings and menu operations, etc. are disabled.



- Even if the drive mode is set to continuous shooting, only one shot can be taken.
- You can also use the self-timer or bulb timer with mirror lockup.
- If 30 seconds elapse after the mirror has locked up, it will go back down automatically. Pressing the shutter button completely locks up the mirror again.
- For mirror lockup, using a tripod and Remote Switch RS-80N3 (sold separately) or Timer Remote Controller TC-80N3 (sold separately) is recommended (p.248).
- You can also use a remote controller (sold separately, p.248). Setting the remote controller to a 2-sec. delay is recommended.

## Using the Eyepiece Cover

When you use the self-timer, bulb, or a remote switch and do not look through the viewfinder, stray light entering the viewfinder can cause the picture to look dark. To prevent this, use the eyepiece cover (p.33) attached to the camera strap.

During Live View shooting and movie shooting, attaching the eyepiece cover is unnecessary.

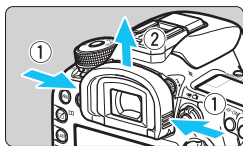

### 1 Detach the eyecup.

- While grasping both sides of the eyecup, slide it upward to detach it.

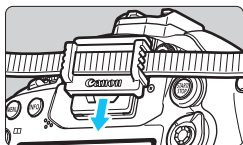

### 2 Attach the eyepiece cover.

- Slide the eyepiece cover down into the eyepiece groove to attach it.
- ▶ After you finish shooting, detach the eyepiece cover and attach the eyecup.

## Using a Remote Switch

You can connect the Remote Switch RS-80N3 (sold separately) or Timer Remote Controller TC-80N3 (sold separately) or any EOS accessory equipped with an N3-type terminal to the camera for shooting (p.478).

To operate the accessory, refer to its instruction manual.

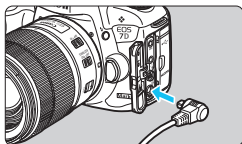

- 1 **Open the terminal cover.**
- 2 **Connect the plug to the remote control terminal.**
  - Connect the plug as shown in the illustration.
  - To disconnect the plug, grasp the silver part and pull.

## Remote Control Shooting



With Remote Controller RC-6 (sold separately), you can shoot remotely up to approx. 5 meters/16.4 feet from the camera. You can either shoot immediately or use a 2-sec. delay.

You can also use Remote Controller RC-1 and RC-5.

- 1 **Focus on the subject.**
- 2 **Set the lens's focus mode switch to <MF>.**
  - You can also shoot with <AF>.
- 3 **Press the <DRIVE•AF> button. (⓪6)**

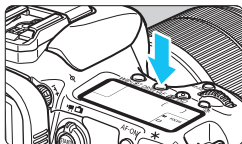

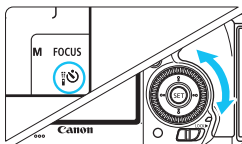

#### 4 Select the self-timer.

- While looking at the LCD panel or through the viewfinder, turn the <img alt="dial icon" data-bbox="885 155 915 175"/> dial to select <img alt="self-timer icon 1" data-bbox="885 175 915 195"/> or <img alt="self-timer icon 2" data-bbox="885 195 915 215"/>.

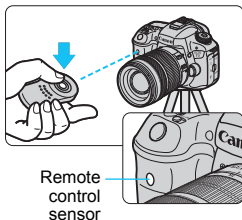

#### 5 Press the remote controller's transmit button.

- Point the remote controller toward the camera's remote control sensor, and press the transmit button.
- ▶ The self-timer lamp lights up and the picture is taken.



- Fluorescent or LED lighting may cause camera misoperation by triggering the shutter inadvertently. Try to keep the camera away from such light sources.
- If you point a remote controller for a TV set toward the camera and operate it, it may cause camera misoperation by triggering the shutter inadvertently.



Remote control shooting is also possible with devices such as an EX-series Speedlite equipped with a remote-release function.

# Interval Timer Shooting

With the interval timer, you can set the shooting interval and the number of shots. The camera will repeat taking one shot with the set interval until the set number of shots are taken.

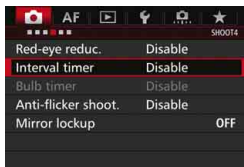

## 1 Select [Interval timer].

- Under the [CAMERA 4] tab (the [CAMERA 2] tab in <A+>), select [Interval timer], then press <SET>.



## 2 Select [Enable].

- Select [Enable], then press <INFO.> button.

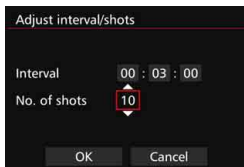

## 3 Set the interval and number of shots.

- Select the hour, minute, second, or number of shots.
- Press <SET> so <UP/DOWN> is displayed.
- Set the desired number, then press <SET> (Returns to <BACK>).

### • Interval

Settable from [00:00:01] to [99:59:59].

### • No. of shots

Settable from [01] to [99]. If you set [00], the camera will keep shooting until you stop the interval timer.

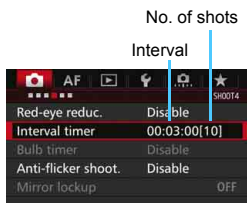

#### 4 Select [OK].

- ▶ The interval timer settings will be displayed on the menu screen.
- ▶ <■■■■> will be displayed on the LCD panel.

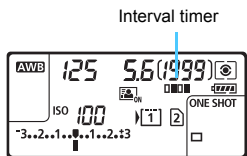

#### 5 Take the picture.

- ▶ Shooting will start according to the interval timer settings.
- During interval timer shooting, <■■■■> will blink.
- After the set number of shots are taken, the interval timer shooting will stop and be automatically canceled.



- Using a tripod is recommended.
- Taking test shots is recommended.
- After the interval timer shooting starts, you can still press the shutter button completely to take a picture as usual. However, from 5 sec. before the next interval timer shooting, the shooting function settings, menu operation, image playback, and other operations will be suspended, and the camera will be ready to shoot.
- If a picture is taken or an image is being processed as the next interval timer shooting, that interval timer shooting will be canceled. This will make the number of interval timer images captured lower than the set number of shots.
- Interval timer shooting can be combined with AEB, WB bracketing, multiple exposures, and HDR mode.
- You can stop the interval timer shooting by selecting [**Disable**] or turning the power switch to <OFF>.

- If the lens's focus mode switch is set to <AF>, the camera will not shoot when focus is not achieved. Setting it to <MF> and focus manually first is recommended.
- Live View shooting, movie shooting, bulb exposures, or mirror lockup cannot be performed with interval timer shooting.
- During interval timer shooting, auto power off will not take effect. For prolonged interval timer shooting, using the DC Coupler DR-E6 (sold separately) and AC Adapter AC-E6N (sold separately) to power the camera is recommended.
- If a long exposure or shutter speed longer than the shooting interval is set, the camera cannot shoot at the set interval. The camera will thereby shoot fewer shots than the number set for interval timer shooting. Also, the number of shots may decrease when the shutter speed and the shooting interval are almost the same or close.
- If card recording time is longer than the set shooting interval, due to card performance or shooting settings, etc., the camera may not shoot at the set shooting interval.
- If you use flash with interval timer shooting, set an interval longer than the flash's recycling time. Otherwise, if the interval is too short, the flash may not fire.
- If the shooting interval is too short, the camera may not take a picture or capture an image without autofocus.
- Interval timer shooting will be canceled and reset to **[Disable]** if you do any of the following: Set the power switch to <OFF>, display the Live View or movie shooting screen, set the shooting mode to <B> or a Custom shooting mode, or use EOS Utility (EOS software, p.534).
- After interval timer shooting starts, you cannot use remote control shooting (p.248) or remote-release shooting with an EOS-dedicated, external Speedlite.
- During interval timer shooting, if your eye will not remain on the viewfinder eyepiece, attach the eyepiece cover (p.247). Stray light entering the viewfinder can throw off the exposure.



# 7

## Flash Photography

This chapter explains how to shoot with the built-in flash and external Speedlites (EX-series, sold separately), how to set flash settings with the camera's menu screen, and how to use the built-in flash for wireless flash shooting.



- Flash cannot be used with movie shooting. It will not fire.
- AEB cannot be used with flash.

## ⚡ Using the Built-in Flash

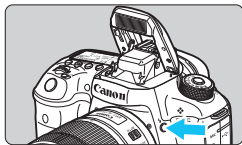

In the **<P>** **<Tv>** **<Av>** **<M>** **<B>** modes, just press the **<⚡>** button to raise the built-in flash for flash photography. Before shooting, check that **[⚡]** is displayed in the viewfinder. After shooting, push the built-in flash back down with your fingers until it clicks into place.

In the **<A<sup>+</sup>>** mode, the built-in flash will be raised and fire automatically in low-light or backlit conditions. You can also enable or disable the flash firing.

The table below shows the shutter speed and aperture settings that will be used with flash.

Shooting Mode	Shutter Speed	Aperture
<b>A<sup>+</sup></b>	Automatically set	Automatically set
<b>P</b>	Automatically set (1/250 sec. - 1/60 sec.)	Automatically set
<b>Tv</b>	Manually set (1/250 sec. - 30 sec.)	Automatically set
<b>Av</b>	Automatically set (1/250 sec. - 30 sec.)	Manually set
<b>M</b>	Manually set (1/250 sec. - 30 sec.)	Manually set
<b>B</b>	Exposure continues while you hold down the shutter button or while the bulb timer is operating.	Manually set



### Flash Photography in the **<Av>** Mode

To obtain a correct flash exposure, the flash output will be set automatically (autoflash exposure) to match the manually-set aperture. The shutter speed will be set automatically between 1/250 sec. - 30 sec. to suit the scene's brightness. In low light, the main subject is exposed with the automatic flash, and the background is exposed with a slow shutter speed set automatically. Both the subject and background look properly exposed (automatic slow-speed flash sync). If you are handholding the camera, keep it steady to prevent camera shake. Using a tripod is recommended.

To prevent a slow shutter speed, under **[📷 1: Flash control]**, set **[Flash sync. speed in Av mode]** to **[1/250-1/60 sec. auto]** or **[1/250 sec. (fixed)]** (p.263).

## Effective Range of Built-in Flash

(Approx. in meters/feet)

ISO Speed	EF-S18-135mm f/3.5-5.6 IS USM EF-S15-85mm f/3-5.6 IS USM	
	Wide Angle: f/3.5	Telephoto: f/5.6
ISO 100	1-3.1 / 3.3-10.3	1-2.0 / 3.3-6.4
ISO 200	1-4.4 / 3.3-14.6	1-2.8 / 3.3-9.1
ISO 400	1-6.3 / 3.3-20.6	1-3.9 / 3.3-12.9
ISO 800	1.1-8.9 / 3.6-29.2	1-5.6 / 3.3-18.2
ISO 1600	1.6-12.6 / 5.2-41.2	1-7.9 / 3.3-25.8
ISO 3200	2.2-17.8 / 7.3-58.3	1.4-11.1 / 4.6-36.5
ISO 6400	3.1-25.1 / 10.3-82.5	2.0-15.7 / 6.4-51.6
ISO 12800	4.4-35.6 / 14.6-116.7	2.8-22.2 / 9.1-72.9
ISO 16000	5.0-39.9 / 16.4-130.9	3.1-24.9 / 10.2-81.8
H1 (equivalent to ISO 25600)	6.3-50.3 / 20.6-165.0	3.9-31.4 / 12.9-103.1
H2 (equivalent to ISO 51200)	8.9-71.1 / 29.2-233.3	5.6-44.4 / 18.2-145.8



- When you use the built-in flash, detach any lens hood and keep at least 1 meter/3.3 feet away from the subject.
- If a lens hood is attached or if the subject is too close, the built-in flash will be obstructed and the bottom of the picture may look dark.
- Do not perform flash photography when the built-in flash is held down with your finger or not fully raised for some other reason.



If you use a super telephoto lens or large-aperture lens and the bottom of the picture looks dark, using an external Speedlite (sold separately, p.259) is recommended.

## **MENU** Red-eye Reduction

Using the red-eye reduction lamp when taking a flash picture can reduce red eye.

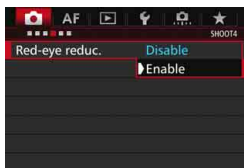

### 1 Select [Red-eye reduc.].

- Under the [**4**] tab (the [**2**] tab in <[A+]>), select [Red-eye reduc.], then press <[SET]>.

### 2 Select [Enable].

- For flash photography, when you press the shutter button halfway, the red-eye reduction lamp will be emitted.



- The red-eye reduction feature is most effective when the subject looks at the red-eye reduction lamp, the room is well lit, and you are close to the subject.
- When you press the shutter button halfway, the scale display on the bottom of the viewfinder will shrink and turn off. For best results, take the picture after this scale display turns off.
- The effectiveness of red-eye reduction varies depending on the subject.



## Flash Exposure Compensation ☆

Set flash exposure compensation if the flash exposure of the subject does not come out as desired. You can set flash exposure compensation up to  $\pm 3$  stops in 1/3-stop increments.

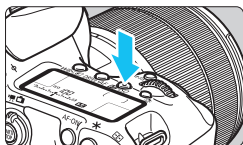

1 Press the  $\langle \text{Flash icon} \cdot \text{ISO} \rangle$  button. (ⓘ6)

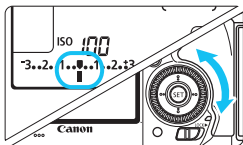

2 Set the exposure compensation amount.

- While looking at the LCD panel or through the viewfinder, turn the  $\langle \text{Mode dial} \rangle$  dial.
- To make the flash exposure brighter, turn the  $\langle \text{Mode dial} \rangle$  dial to the right (increased exposure). To make the flash exposure darker, turn the  $\langle \text{Mode dial} \rangle$  dial to the left (decreased exposure).
- After shooting, set the exposure compensation amount back to zero.

Increased exposure for a brighter image



Decreased exposure for a darker image



- If [**2: Auto Lighting Optimizer**] (p.175) is set to any setting other than [**Disable**], the image may still look bright even if a decreased flash exposure compensation is set.
- If flash exposure compensation is set with an external Speedlite (sold separately, p.259), you cannot set the flash exposure compensation with the camera. If it is set with both the camera and Speedlite, the Speedlite's setting overrides the camera's.



- The exposure compensation amount will remain in effect even after you set the power switch to **<OFF>**.
- You can also set flash exposure compensation with [**Built-in flash settings**] under [**1: Flash control**] (p.262).
- The camera can also be used to set the EOS-dedicated, external Speedlite's flash exposure compensation in the same way as with the built-in flash.

## ✳ FE Lock ☆

FE (flash exposure) lock obtains and locks the appropriate flash exposure for the desired part of the image.

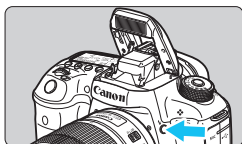

### 1 Press the <⚡> button.

- ▶ The built-in flash will be raised.
- Press the shutter button halfway and look through the viewfinder to check that the <⚡> icon is lit.

### 2 Focus on the subject.

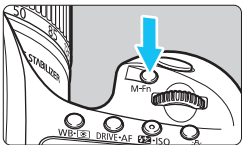

### 3 Press the <M-Fn> button. (ⓘ16)

- Aim the viewfinder center over the subject where you want to lock the flash exposure, then press the <M-Fn> button.
- ▶ The flash will fire a preflash and the required flash output is calculated and retained in memory.
- ▶ In the viewfinder, “FEL” is displayed for a moment and <⚡\*> will light up. Also, the flash exposure level indicator will be displayed as shown on the left.
- Each time you press the <M-Fn> button, a preflash is fired and the flash output is calculated and retained in memory.



### 4 Take the picture.

- Compose the shot and press the shutter button completely.
- ▶ The flash is fired when the picture is taken.

- ⓘ If the subject is too far away and beyond the effective flash range, the <⚡> icon will blink. Move closer to the subject and repeat steps 2 to 4.
- FE lock is not possible with Live View shooting.

## ⚡ Using an External Speedlite

### EOS-dedicated, EX-series Speedlites

Flash photography with EX-series Speedlite (sold separately) is as easy as with built-in flash.

**For detailed instructions, refer to the EX-series Speedlite's instruction manual.** This camera is a Type-A camera that can use all the features of EX-series Speedlites.

To set the flash functions and flash Custom Functions with the camera's menu, see pages 262-271.



- **Flash exposure compensation**

Set this in the same way as for the built-in flash. See page 257.

- **FE lock**

The setting procedure is basically the same as for the built-in flash. See page 258.



If it is difficult to achieve focus with autofocus, the EOS-dedicated, external Speedlite will automatically emit the AF-assist beam as necessary.

## Canon Speedlites Other Than the EX-series

- With an EZ/E/EG/ML/TL-series Speedlite set to A-TTL or TTL autoflash mode, the flash can be fired at full output only. Set the camera's shooting mode to <M> (manual exposure) or <Av> (aperture-priority AE) and adjust the aperture setting before shooting.
- When using a Speedlite that has manual flash mode, shoot in the manual flash mode.

## Non-Canon Flash Units

### Sync Speed

The camera can synchronize with non-Canon compact flash units at 1/250 sec. and slower speeds. With large studio flash units, be sure to test the flash synchronization before shooting with the sync speed set within approx. 1/60 sec. to 1/30 sec. The flash duration of such units is longer than that of compact flash units and varies depending on the model.

### PC Terminal

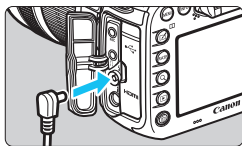

- The camera's PC terminal can be used with flash units having a sync cord. The PC terminal is threaded to prevent inadvertent disconnection.
- The camera's PC terminal has no polarity. You can connect any sync cord regardless of its polarity.

### Cautions for Live View Shooting

If you use a non-Canon flash unit with Live View shooting, set [**6**: Silent LV shoot.] to [**Disable**] (p.297). The flash will not fire if it is set to [**Mode 1**] or [**Mode 2**].





- If the camera is used with a flash unit or flash accessory dedicated to another camera brand, the camera may not operate properly and malfunction may result.
- Do not connect to the camera's PC terminal any flash unit with an output voltage of 250 V or more.
- Do not attach a high-voltage flash unit on the camera's hot shoe. It may not fire.



A flash unit attached to the camera's hot shoe and a flash unit connected to the PC terminal can both be used at the same time.

## MENU Setting the Flash ☆

With the built-in flash or an EX-series, external Speedlite compatible with flash function settings, you can use the camera's menu screen to set flash functions and the external Speedlite's Custom Functions.

**If you use an external Speedlite, attach the Speedlite to the camera and turn on the Speedlite before setting the flash functions.** For details on the external Speedlite's flash functions, refer to the Speedlite's instruction manual.

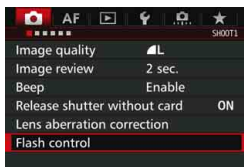

### 1 Select [Flash control].

- Under the [ 1] tab, select [Flash control], then press <SET>.
- ▶ The Flash control screen will appear.

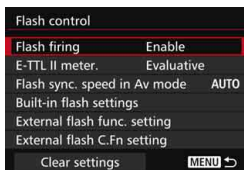

### 2 Select the desired item.

- Select the item to be set, then press <SET>.

## Flash Firing



To enable flash photography, set [**Enable**]. To enable only the AF-assist beam, set [**Disable**].

## E-TTL II Flash Metering

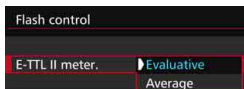

For normal flash exposures, set it to [**Evaluative**]. If [**Average**] is set, the flash exposure will be averaged for the entire metered area. Depending on the scene, flash exposure compensation may be necessary. This setting is for advanced users.

## Flash Synchronization Speed in Av Mode

Flash sync. speed in Av mode	
Auto	AUTO
1/250-1/60sec. auto	$\frac{1}{250}$ - $\frac{1}{60}$ A
1/250 sec. (fixed)	1/250
INFO Help	

You can set the flash sync speed for flash photography in the aperture-priority AE (**Av**) mode.

- **AUTO: Auto**

The flash sync speed is set automatically within a range of 1/250 sec. to 30 sec. to suit the scene's brightness. With an external Speedlite, high-speed sync is also possible.

- $\frac{1}{250}$ - $\frac{1}{60}$  A: **1/250-1/60sec. auto**

Prevents a slow shutter speed from being set in low-light conditions. It is effective for preventing subject blur and camera shake. However, while the subject will be properly exposed with the flash, the background may come out dark.

- 1/250: **1/250 sec. (fixed)**

The flash sync speed is fixed at 1/250 sec. This more effectively prevents subject blur and camera shake than with [**1/250-1/60sec. auto**]. However, in low light, the subject's background will come out darker than with [**1/250-1/60sec. auto**].



If [**1/250-1/60sec. auto**] or [**1/250 sec. (fixed)**] is set, high-speed sync is not possible in the <**Av**> mode with the external Speedlite.

## Displaying the Flash Function Setting Screen Directly

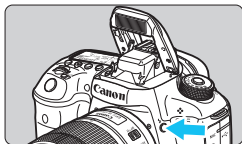

When you use the built-in flash or an external, EX-series Speedlite compatible with flash function settings, you can press the **<⚡>** button to directly display the **[Built-in flash settings]** or **[External flash func. setting]** screen without first displaying the menu screen.

### ● With built-in flash

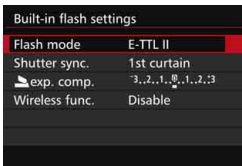

### Press the **<⚡>** button twice.

- Press the button again, and the built-in flash will be raised.
- Press the button again to display the **[Built-in flash settings]** screen.

### ● With external Speedlite

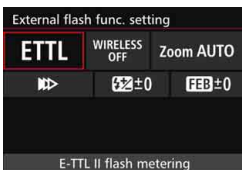

### Press the **<⚡>** button.

- With the external Speedlite turned on, press the **<⚡>** button to display the **[External flash func. setting]** screen.

- ⓘ When you press the **<⚡>** button to display the flash function setting screen, you cannot set **[Flash firing]**, **[E-TTL II meter.]**, or **[Flash sync. speed in Av mode]**. Set these functions with **[1: Flash control]** instead.
- If **[Flash firing]** is set to **[Disable]** and you press the **<⚡>** button, the **[Flash control]** screen will appear (p.262).

## Built-in Flash Settings

### ● Flash mode

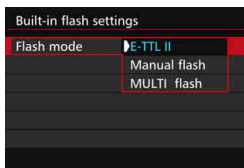

Normally, set this to **[E-TTL II]**. This enables autoexposure shooting with the built-in flash.

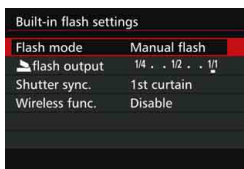

To set the flash output level manually, select **[Manual flash]**.

Select **[flash output]**, then set the flash output level to within 1/1 - 1/128 (1/3-stop increments) before shooting. This mode is for advanced users.

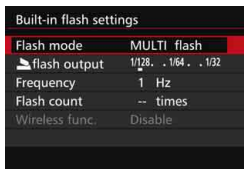

With **[MULTI flash]** selected, you can use a slow shutter speed to capture multiple moments of a moving subject in one image.

First set the **[flash output]**, **[Frequency]**, and **[Flash count]**, then shoot. This mode is for advanced users.



- To prevent the flash from damage due to overheating, do not use MULTI flash more than ten consecutive times. If you use MULTI flash 10 times, allow the flash to rest for at least 10 min. before firing the flash again.
- Flash will be output at 1/128 - 1/4 for MULTI flash.

## ● Shutter synchronization

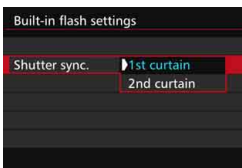

Normally, set this to [1st curtain] so that the flash fires immediately after the exposure starts.

If [2nd curtain] is set, the flash will fire right before the shutter closes. When this is combined with a slow shutter speed, you can create a trail of light such as from car headlights at night with a more natural feel. With second-curtain synchronization, two flashes will be fired: once when you press the shutter button completely, and once immediately before the exposure ends.

## ● Flash exposure compensation

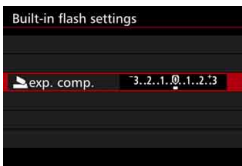

You can set flash exposure compensation up to  $\pm 3$  stops in 1/3-stop increments.

## ● Wireless functions

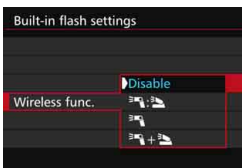

With wireless flash photography (via optical transmission), you can use the built-in flash to wirelessly control external Speedlites.

For details, see “Using Wireless Flash” on page 272.

**!** When using second-curtain synchronization, set the shutter speed to 1/25 sec. or slower. If the shutter speed is 1/30 sec. or faster, first-curtain synchronization will be applied automatically even if [2nd curtain] is set.

## External Flash Function Settings

The screen display and setting options will vary depending on the external Speedlite model, current flash mode, Speedlite's Custom Function settings, etc.

To see which functions your Speedlite (sold separately) provides, refer to the Speedlite's instruction manual.

### Sample display

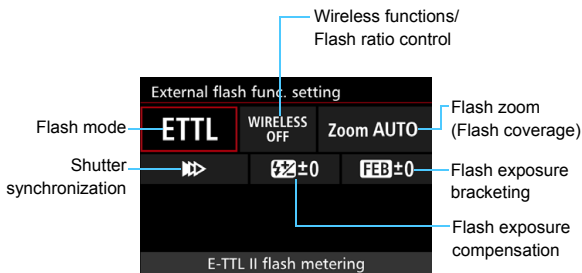

### Flash mode

You can select the flash mode to suit your desired flash shooting.

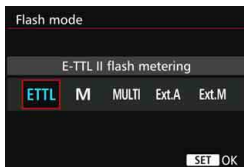

**[E-TTL II flash metering]** is the standard mode of EX-series Speedlites for automatic flash shooting.

**[Manual flash]** is for setting the Speedlite's **[Flash output level]** yourself.

Regarding other flash modes, refer to the instruction manual of a Speedlite compatible with the functions.

## ● Wireless functions / Flash ratio control



Wireless (multiple) flash shooting is possible with radio or optical transmission.

For details on wireless flash, refer to the instruction manual of a Speedlite compatible with the wireless flash shooting.



With a macro flash (MR-14EX II, etc.) compatible with external flash function settings, you can set the flash ratio between flash tubes or flash heads A and B, or use wireless flash with slave units.

For details on flash ratio control, refer to the macro flash's instruction manual.

## ● Flash zoom (Flash coverage)

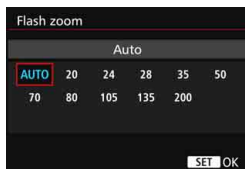

With Speedlites having a zooming flash head, you can set the flash coverage.

Normally, set this to **[AUTO]** so that the camera will automatically set the flash coverage to match the lens focal length.



## ● Shutter synchronization

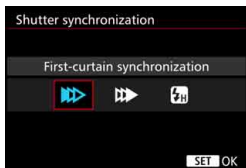

Normally, set this to [**First-curtain synchronization**] so that the flash fires immediately after the exposure starts.

If [**Second-curtain synchronization**] is set, the flash will fire right before the shutter closes. When this is combined with a slow shutter speed, you can create a trail of light such as from car headlights at night with a more natural feel. With second-curtain synchronization, two flashes will be fired: once when you press the shutter button completely, and once immediately before the exposure ends.

If [**High-speed synchronization**] is set, the flash can be used at all shutter speeds. This is especially effective for portraits using fill flash when you want to give priority to the aperture setting.

## ● Flash exposure compensation

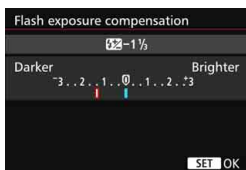

You can set flash exposure compensation up to  $\pm 3$  stops in 1/3-stop increments.

For details, refer to the Speedlite's instruction manual.

## ● Flash exposure bracketing



While the flash output is changed automatically, three shots are taken.

For details, refer to the instruction manual of a Speedlite equipped with flash exposure bracketing.

 When using second-curtain synchronization, set the shutter speed to 1/25 sec. or slower. If the shutter speed is 1/30 sec. or faster, first-curtain synchronization will be applied automatically even if **[Second-curtain synchronization]** is set.

- 
- With an EX-series Speedlite not compatible with flash function settings, you can only set the following: **[Flash firing]**, **[E-TTL II meter.]**, and **[Flash exposure compensation]** under **[External flash func. setting]**. (**[Shutter synchronization]** can also be set with certain EX-series Speedlites.)
  - If flash exposure compensation is set with an external Speedlite, you cannot set the flash exposure compensation with the camera. If it is set with both the camera and external Speedlite, the Speedlite's setting overrides the camera's.

## External Speedlite Custom Function Settings

For details on the external Speedlite's Custom Functions, refer to the Speedlite's (sold separately) instruction manual.

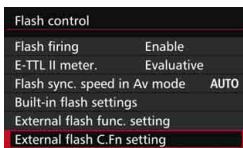

1 Select [**External flash C.Fn setting**].

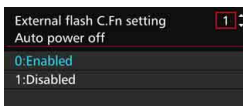

2 Set the desired functions.

- Select the number, then press <SET>.
- Select the setting, then press <SET>.



With an EX-series Speedlite, if the [**Flash metering mode**] Custom Function is set to [**TTL flash metering**] (autoflash), the Speedlite will always fire at full output.

## Clear Settings

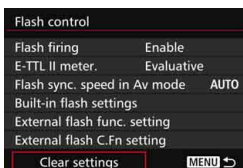

1 Select [**Clear settings**].

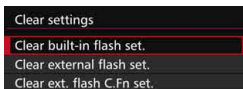

2 Select the settings to be cleared.

- Select [**Clear built-in flash set.**], [**Clear external flash set.**], or [**Clear ext. flash C.Fn set.**], then press <SET>.
- On the confirmation dialog, select [**OK**]. Then the flash settings or Custom Function settings will all be cleared.



The Speedlite's Personal Function (P.Fn) cannot be set or canceled with the camera's [**Flash control**] screen. Set it with the Speedlite.

## Using Wireless Flash ☆

The camera's built-in flash can work as a master unit for Canon EX-series, external Speedlites having a wireless slave feature. It can wirelessly trigger the Speedlite(s) to fire via optical transmission. Be sure to read about wireless flash photography (optical transmission) in the Speedlite's instruction manual.

### Slave Unit Settings and Position

Regarding your Speedlite (slave unit), refer to its instruction manual and set it as follows. The settings other than the ones below for the slave unit's control are all set with the camera. Different types of slave units can be used and controlled together.

- (1) Set the external Speedlite as a slave unit.
- (2) Set the external Speedlite's transmission channel to the same channel as set on the camera.\*<sup>1</sup>
- (3) For flash ratio control, set the slave unit's firing group.
- (4) Position the camera and slave unit(s) within the range shown below.
- (5) Face the slave unit's wireless sensor toward the camera.\*<sup>2</sup>

Example of Wireless Flash Set-up

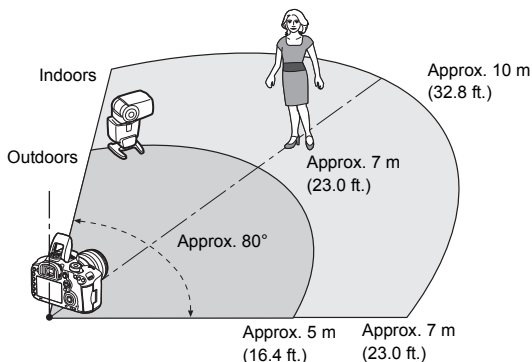

- \*1: If the Speedlite does not have a transmission channel setting function, it operates regardless of the channel set on the camera.
- \*2: In small rooms, the slave unit may work even if its wireless sensor does not face the camera. The camera's wireless signals can bounce off the walls and be received by the slave unit. When using an EX-series Speedlite with fixed flash head and wireless sensor, make sure it fires when you take pictures.

- **Canceling the slave unit's auto power off**

To cancel the slave unit's auto power off, press the camera's <M-Fn> button.



The camera's master unit function cannot be used for wireless flash shooting with radio transmission.

## Wireless Flash Shooting Configurations

The table below shows the possible configurations for wireless flash shooting. Choose the configuration suiting the subject, shooting conditions, the number of external Speedlites you use, etc.

	External Speedlite			Built-in Flash	Page	Setting	
	Quantity	A:B Flash Ratio	C Flash exp. comp.			Wireless Functions	Firing Group
Fully Automatic (E-TTL II autoflash)	Single	-	-	-	p.275		All
	Single	-	-	Used	p.277	:	-
	Multiple	-	-	-	p.278		All
	Multiple	Set	-	-	p.279		(A:B)
	Multiple	Set	Set	-	p.280		(A:B C)
	Multiple	-	-	Used	p.281	+	All and
	Multiple	Set	-	Used		+	(A:B)
	Multiple	Set	Set	Used		+	(A:B C)
	• Flash exposure compensation					p.282	
• FE lock							

	External Speedlite			Built-in Flash	Page	Setting	
	Quantity	A, B, C Flash Output				Wireless Functions	Firing Group
Manual Flash	Single/ Multiple	-	-	-	p.283		All
	Multiple	Set	-	-			(A:B:C)
	Single/ Multiple	-	Used	-		+	All and
	Multiple	Set	Used	-		+	(A:B:C)



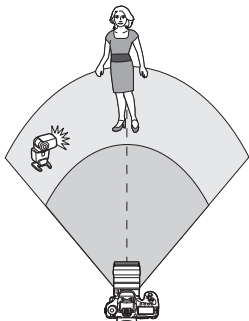

Even if the built-in flash is disabled in the camera settings, it will still fire in order to control the slave unit via optical transmission. The flash fired to control the slave unit may therefore appear in the picture depending on the shooting conditions.

## Fully Automatic Shooting with One External Speedlite



This shows the most basic setup for fully-automatic wireless flash shooting with one external Speedlite.

**Steps 1 to 4 and 6 apply to all wireless flash shooting. Therefore, these steps are omitted in other wireless flash setups explained on the pages hereafter.**

On the menu screens, the <  /  > icons refer to the external Speedlite, and the <  /  > icons refer to the built-in flash.

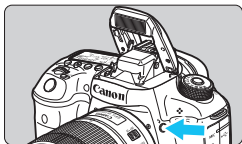

### 1 Press the < lightning bolt / flash > button to raise the built-in flash.

- For wireless flash shooting, be sure to raise the built-in flash.

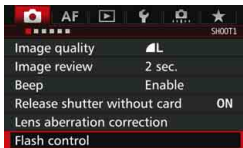

### 2 Select [Flash control].

- Under the [  1 ] tab, select [Flash control].

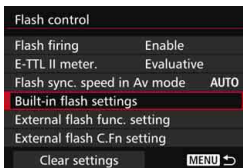

### 3 Select [Built-in flash settings].

Built-in flash settings	
Flash mode	E-TTL II
Shutter sync.	1st curtain

#### 4 Set [Flash mode] to [E-TTL II].

Built-in flash settings	
Flash mode	E-TTL II
Shutter sync.	1st curtain
Wireless func.	
Channel	1

#### 5 Set [Wireless func.] to [].

Built-in flash settings	
Flash mode	E-TTL II
Shutter sync.	1st curtain
Wireless func.	
Channel	1
Firing group	All

#### 6 Set [Channel].

- Set the channel (1-4) to the same one as the slave unit.

Built-in flash settings	
Flash mode	E-TTL II
Shutter sync.	1st curtain
Wireless func.	
Channel	1
Firing group	All
exp. comp.	3..2..1..0..1..2..3

#### 7 Set [Firing group] to [ All].

- The slave unit may be set to any firing group (A, B, or C).

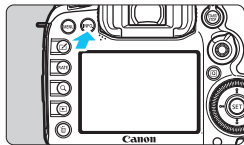

#### 8 Fire a test flash.

- Check that the slave unit is ready to fire, then while the [**Built-in flash settings**] screen is displayed, press the <INFO.> button.
- ▶ The slave unit will fire.

#### 9 Take the picture.

- Set the camera and take the picture in the same way as with normal flash shooting.
- To terminate wireless flash shooting, set [Wireless func.] to [Disable].



- Setting [E-TTL II meter.] to [Evaluative] is recommended.
- Wireless MULTI flash shooting is not possible.



## Fully Automatic Shooting with One External Speedlite and the Built-in Flash

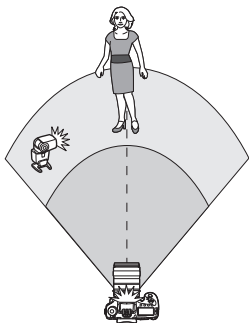

This is fully automatic wireless flash shooting with one external Speedlite and the built-in flash.

You can change the flash ratio between the external Speedlite and built-in flash to adjust how the shadows look on the subject.

Built-in flash settings	
Flash mode	E-TTL II
Shutter sync.	1st curtain
Wireless func.	
Channel	1
Flash exp. comp	3..2..1..0..1..2..3
	2:1 · 1:1 · 1:2
INFO Test flash firing	

1 Set [Wireless func.] to [ : ].

Built-in flash settings	
Flash mode	E-TTL II
Shutter sync.	1st curtain
Wireless func.	
Channel	1
Flash exp. comp	3..2..1..0..1..2..3
	2:1 · 1:1 · 1:2
INFO Test flash firing	

2 Set the desired flash ratio and take the picture.

- Select [ : ] and set the flash ratio within 8:1 to 1:1. Setting a flash ratio to the right of 1:1 is not possible.



- If the built-in flash does not fire sufficient light, set a higher ISO speed (p.154).
- The 8:1 to 1:1 flash ratio is equivalent to 3:1 to 1:1 stops (1/2-stop increments).

## Fully Automatic Shooting with Multiple External Speedlites

Multiple Speedlite slave units can be treated as one flash unit or separated into slave groups whose flash ratio can be set.

The basic settings are shown below. By changing the **[Firing group]** setting, you can shoot with various wireless flash setups with multiple Speedlites.

Built-in flash settings	
Flash mode	E-TTL II
Shutter sync.	1st curtain
Wireless func.	
Channel	1
Firing group	All
exp. comp.	3..2..1..0..1..2..3
INFO Test flash firing	

### Basic settings:

Flash mode : E-TTL II

Wireless func. :

Channel : (Same as slave units)

### ● All] Using multiple slave Speedlites as one flash unit

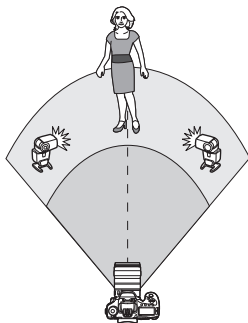

Convenient when you need a large flash output. All the slave units will fire at the same output and be controlled to obtain a standard exposure.

No matter which firing group (A, B, or C) the slave units belong to, they will all fire as one group.

Built-in flash settings	
Flash mode	E-TTL II
Shutter sync.	1st curtain
Wireless func.	
Channel	1
Firing group	All
exp. comp.	3..2..1..0..1..2..3
INFO Test flash firing	

**1** Set **[Firing group]** to All].

**2** Take the picture.

- [  (A:B) ] Multiple slave units in multiple groups

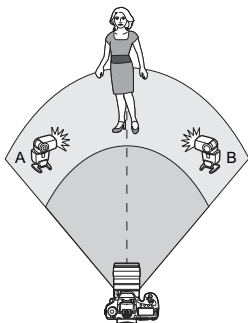

You can divide the slave units into groups A and B, and change the flash ratio to obtain the desired lighting effect. Refer to the Speedlite's instruction manual and set one slave unit to firing group A and the other to firing group B. Position the Speedlites as shown in the illustration.

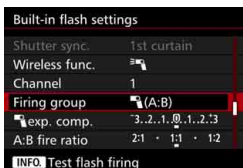

## 1 Set [Firing group] to [ (A:B) ].

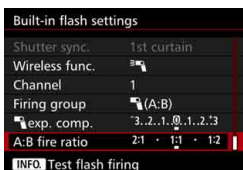

## 2 Set the A:B flash ratio and shoot.

- Select [A:B fire ratio] and set the flash ratio.



The 8:1 to 1:1 to 1:8 flash ratio is equivalent to 3:1 to 1:1 to 1:3 stops (1/2-stop increments).

- [  (A:B C) ] Multiple slave units in multiple groups

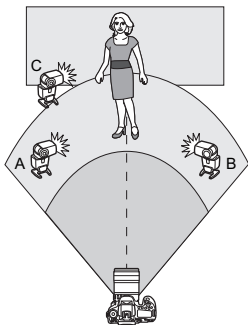

This is a variant of the [  (A:B) ] setup. This setup has group C eliminating the background shadows created by groups A and B.

Refer to the Speedlite's instruction manual and set three slave units to firing group A, B, and C, respectively. Position the Speedlites as shown in the illustration.

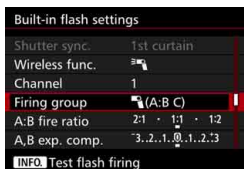

## 1 Set [Firing group] to [ (A:B C) ].

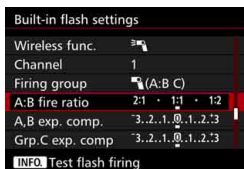

## 2 Set the A:B flash ratio and the flash exposure compensation amount for C, then shoot.

- Select [A:B fire ratio] and set the flash ratio.
- Select [Grp.C exp. comp.] and set the flash exposure compensation amount.

- If [Firing group] is set to [  (A:B) ], the slave units in firing group C will not fire.
- If firing group C is pointed toward the main subject, overexposure may result.

## Fully Automatic Shooting with the Built-in Flash and Multiple External Speedlites

The built-in flash can also be added to wireless flash shooting explained on pages 278-280.

The basic settings are shown below. By changing the **[Firing group]** setting, you can shoot with various wireless flash setups of multiple Speedlites complemented with the built-in flash.

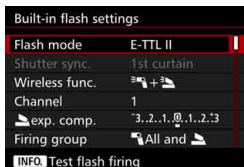

### 1 Basic settings:

Flash mode : E-TTL II

Wireless func. : [Wireless icon] + [Flash icon]

Channel : (Same as slave units)



### 2 Set [Firing group].

- Select one of the following: [Wireless icon] All and [Flash icon], [Wireless icon] (A:B) [Flash icon], or [Wireless icon] (A:B C) [Flash icon].
- With [Wireless icon] (A:B) [Flash icon], set the A:B flash ratio and shoot.
- With [Wireless icon] (A:B C) [Flash icon], set the A:B flash ratio and flash exposure compensation amount for C, then shoot.

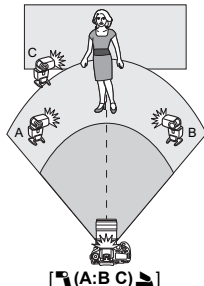
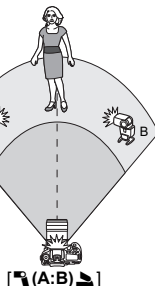
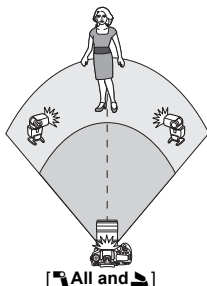

## Creative Wireless Flash Shooting

### ● Flash exposure compensation

When **[Flash mode]** is set to **[E-TTL II]**, flash exposure compensation can be set. The flash exposure compensation settings that can be set (see below) vary depending on the **[Wireless func.]** and **[Firing group]** settings.

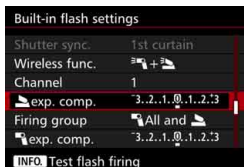

### Flash exposure compensation

The flash exposure compensation is applied to the built-in flash and all the external Speedlites.

#### [Flash icon] exp. comp.

The flash exposure compensation is applied to the built-in flash.

#### [Flash icon] exp. comp.

The flash exposure compensation is applied to all the external Speedlites.

#### A, B exp. comp.

The flash exposure compensation is applied to both groups A and B.

#### Grp.C exp. comp.

The flash exposure compensation is applied to group C.

### ● FE lock

If **[Flash mode]** is set to **[E-TTL II]**, you can press the **<M-Fn>** button to perform FE lock (p.258).

## Manual Setting of the Flash Output for Wireless Flash Shooting

When [Flash mode] is set to [Manual flash], flash exposure can be set manually. The flash output settings that can be set ([Flash output], [Group A output], etc.) vary depending on the [Wireless func.] setting (see below).

Built-in flash settings	
Flash mode	Manual flash
Shutter sync.	1st curtain
Wireless func.	
Channel	1
Firing group	All
flash output	1/4 . . 1/2 . . 1/1
[INFO] Test flash firing	

### Wireless func.:

- **Firing group: All**  
The manual flash output setting is applied to all the external Speedlites.
- **Firing group: (A:B:C)**  
You can divide the slave units into Groups A, B, and C and set the flash output separately for each group.

### Wireless func.: +

- **Firing group: All and**   
You can set the flash output separately for the external Speedlite(s) and built-in flash.
- **Firing group: (A:B:C)**   
You can divide the slave units into Groups A, B, and C and set the flash output separately for each group. You can also set the flash output for the built-in flash.



Built-in flash will be output at 1/4 - 1/128 when + is set.





# 8

## Shooting with the LCD Monitor (Live View Shooting)

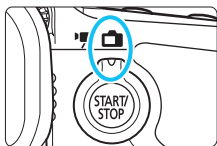

You can shoot while viewing the picture on the camera's LCD monitor. This is called "Live View shooting".

Live View shooting is enabled by setting the Live View shooting/ Movie shooting switch to <img alt="camera icon" data-bbox="758 593 798 613"/>.

- If you handhold the camera and shoot while viewing the LCD monitor, camera shake can cause blurred images. Using a tripod is recommended.



### Remote Live View Shooting

With EOS Utility (EOS software, p.534) installed on your computer, you can connect the camera to the computer and shoot remotely while viewing the computer screen. For details, refer to the EOS Utility Instruction Manual.

## Shooting with the LCD Monitor

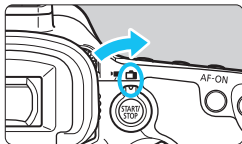

- 1 Set the Live View shooting/Movie shooting switch to .

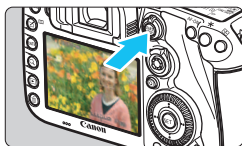



- 2 Display the Live View image.
  - Press the  button.
  - ▶ The Live View image will appear on the LCD monitor.
  - The Live View image will closely match the brightness level of the actual image you capture.

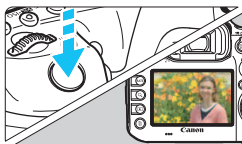

- 3 Focus on the subject.
  - When you press the shutter button halfway, the camera will focus with the current AF method (p.299).



- 4 Take the picture.
  - Press the shutter button completely.
  - ▶ The picture is taken and the captured image is displayed on the LCD monitor.
  - ▶ When the playback display ends, the camera will return to Live View shooting automatically.
  - Press the  button to exit the Live View shooting.

- The image's field of view is approx. 100% (when the image-recording quality is set to JPEG ).
- In the **<P>** **<Tv>** **<Av>** **<M>** **<B>** shooting mode, you can check the depth of field by pressing the depth-of-field preview button.
- During continuous shooting, the exposure set for the first shot will also be applied to subsequent shots.
- You can also use a remote controller (sold separately, p.248) for Live View shooting.

## Enabling Live View Shooting

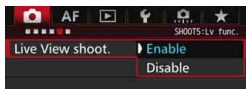

Set [**5: Live View shoot.**] (the [**3**] tab in <[**A**+]>) to [**Enable**].

## Number of Possible Shots with Live View Shooting

Temperature	Room Temperature (23°C / 73°F)	Low Temperatures (0°C / 32°F)
No Flash	Approx. 270 shots	Approx. 260 shots
50% Flash Use	Approx. 250 shots	Approx. 240 shots

- The figures above are based on a fully-charged Battery Pack LP-E6N and CIPA (Camera & Imaging Products Association) testing standards.
- With a fully-charged Battery Pack LP-E6N, continuous Live View shooting is possible for approx. 2 hr. 20 min. at room temperature (23°C / 73°F), or for approx. 2 hr. 10 min. at low temperatures (0°C / 32°F).



- Do not point the camera toward an intense light source, such as the sun on a sunny day or an intense artificial light source. Doing so may damage the image sensor or the camera's internal components.
- **General Live View Shooting Cautions are on pages 310-311.**



- You can also focus by pressing the <AF-ON> button.
- When flash is used, there will be two shutter sounds, but only one shot will be taken. Also, the time it takes to take the picture after you press the shutter button completely will be slightly longer than with viewfinder shooting.
- If the camera is not operated for a prolonged period, the power will turn off automatically after the time set in [**2: Auto power off**] (p.69). If [**2: Auto power off**] is set to [**Disable**], Live View shooting will end automatically after 30 min. (camera power remains on).
- With the HDMI cable HTC-100 (sold separately), you can display the Live View image on a TV screen (p.385). Note that no sound will be output. If the picture does not appear on the TV screen, set the [**3: Video system**] correctly to [**For NTSC**] or [**For PAL**] (depending on the video standard of your TV set).

## Information Display

- Each time you press the <INFO.> button, the information display will change.

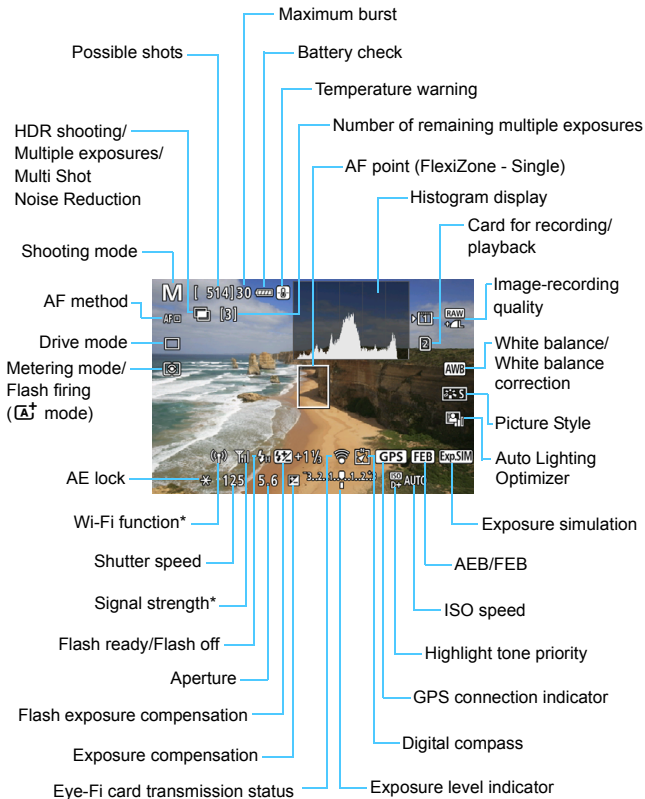

\* Refer to the Wi-Fi Adapter W-E1 Instruction Manual.



- The histogram can be displayed when [**5: Expo. simulation: Enable**] (p.296) is set.
- You can display the electronic level by pressing the <INFO.> button (p.75). Note that if the AF method is set to [**L+Tracking**] or the camera is connected to a TV set with an HDMI cable, the electronic level cannot be displayed.
- When <Exp.SIM> is displayed in white, it indicates that the Live View image brightness is close to what the captured image will look like.
- If <Exp.SIM> is blinking, it indicates that the Live View image is displayed at a brightness that differs from the actual shooting result because of low- or bright-light conditions. However, the actual image recorded will reflect the exposure setting. Note that the noise may be more noticeable than the actual image recorded.
- If Multi Shot Noise Reduction, bulb exposure, or flash is used, the <Exp.SIM> icon and histogram will be grayed out (for your reference). The histogram may not be properly displayed in low- or bright-light conditions.



**Do not hold the camera in the same position for long periods of time.**

Even if the camera does not feel too hot, prolonged contact with the same body part may cause skin redness, blistering or low-temperature contact burns. Using a tripod is recommended for people with circulation problems or very sensitive skin, or when using the camera in very hot places.

## Scene Icons

In the <A+> shooting mode, the camera detects the scene type and sets everything automatically to suit the scene. The detected scene type is indicated on the upper left of the screen. For certain scenes or shooting conditions, the icon displayed may not match the actual scene.

Subject Background	Portrait*1		Non-portrait			Background Color
		Movement	Nature and Outdoor Scene	Movement	Close*2	
Bright						Gray
Backlit						
Blue Sky Included						Light blue
Backlit						
Sunset	*3			*3		Orange
Spotlight						Dark blue
Dark						
With Tripod	*4*5	*3	*4*5	*3		

\*1: Displayed only when the AF method is set to [ +Tracking]. If another AF method is set, the “Non-portrait” icon will be displayed even if a person is detected.

\*2: Displayed when the attached lens has distance information. With an Extension Tube or Close-up Lens, the icon displayed may not match the actual scene.

\*3: The icon suiting the scene detected will be displayed.

\*4: Displayed when all the following conditions apply: The shooting scene is dark, it is a night scene, and the camera is mounted on a tripod.

\*5: Displayed with any of the lenses below:

- EF-S18-55mm f/3.5-5.6 IS II
- EF-S55-250mm f/4-5.6 IS II
- EF300mm f/2.8L IS II USM
- EF400mm f/2.8L IS II USM
- EF500mm f/4L IS II USM
- EF600mm f/4L IS II USM
- Image Stabilizer lenses marketed in 2012 or later.

\*4+\*5: If the conditions in both \*4 and \*5 are met, the shutter speed will slow down.

## Final Image Simulation

The final image simulation shows the results of the current settings for Picture Style, white balance and other functions in the Live View image, so you can see what the captured image will look like.

The Live View image will automatically show the effects of the settings listed below.

### Final Image Simulation During Live View Shooting





- Picture Style
  - \* All settings such as sharpness, contrast, color saturation, and color tone will be reflected.
- White balance
- White balance correction
- Metering mode
- Exposure (with [ 5: Expo. simulation: Enable] set)
- Depth of field (with depth-of-field preview button ON)
- Auto Lighting Optimizer
- Peripheral illumination correction
- Chromatic aberration correction
- Distortion correction
- Highlight tone priority
- Aspect ratio (image area confirmation)







Cautions for distortion correction during Live View shooting are on page 183.

# Shooting Function Settings

## WB//DRIVE/AF//ISO/ Settings

While the Live View image is displayed, if you press the <WB·>, <DRIVE·AF>, <·ISO>, or <> button, the setting screen will appear on the LCD monitor and you can turn the <> or <> dial to set the respective shooting function.

- By pressing the <WB·> button and then the <INFO.> button, you can set WB shift and WB bracketing.

 When you set  (Partial metering) or  (Spot metering), a metering circle will be displayed in the center.



## **Q** Quick Control

In the <P> <Tv> <Av> <M> <B> modes, the **AF method**, **Drive mode**, Metering mode, **Recording/playing back card and image quality**, White balance, Picture Style, and Auto Lighting Optimizer can be set.

In the <A+> mode, you can set the items in bold and the flash firing.



### 1 Press the <Q> button (10).

- ▶ The settable functions will be displayed.

### 2 Select a function and set it.

- Use <F1> to select a function.
- ▶ The setting of the selected function is displayed on the screen.
- Turn the <W/BALANCE> or <WB> dial to set it.
- To set the RAW image-recording quality, press <SET>.
- To select the card for recording/playing back, WB Shift/Bracketing, or Picture Style parameters, press the <INFO.> button.
- Press <SET> to finalize the setting and return to Live View shooting.

## MENU Menu Function Settings

### 5

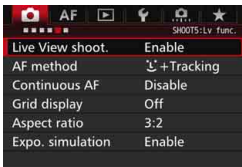

When the Live View shooting/Movie shooting switch is set to **<L>**, the Live View shooting menu options will appear under the [**5**] and [**6**] tabs (the [**3**] tab in **<A+>**).

The settable functions on this menu screen apply only to Live View shooting. They do not work with viewfinder shooting (settings become invalid).

- **Live View shooting**

You can set Live View shooting to **[Enable]** or **[Disable]**.

- **AF method**

You can select **[L+Tracking]**, **[FlexiZone - Multi]**, or **[FlexiZone - Single]**. See pages 299-307 for the AF method.

- **Continuous AF**

The default setting is **[Disable]**.

The camera attains rough focus on the subject continuously. This makes it quicker to achieve focus when you press the shutter button halfway. If **[Enable]** is set, the lens will operate constantly and consume more battery power. This will reduce the number of possible shots due to shorter battery life.

If you want to set the lens's focus mode switch to **<MF>** during Continuous AF, first stop Live View shooting.

- **Grid display**

With [3x3  $\equiv$ ] or [6x4  $\equiv$ ], you can display grid lines to help you level the camera vertically or horizontally. Also, with [3x3+diag  $\equiv$ ], the grid is displayed together with diagonal lines to help you compose with better balance by aligning the intersections over the subject.

- **Aspect ratio** \*

The image's aspect ratio can be set to [3:2], [4:3], [16:9], or [1:1]. The area surrounding the Live View image is masked in black when one of the following aspect ratios is set: [4:3] [16:9] [1:1].

JPEG images will be saved with the set aspect ratio. RAW images will always be saved with the [3:2] aspect ratio. Since aspect ratio information is appended to the RAW image, the image can be generated in the set aspect ratio when you process the RAW image with the camera or Digital Photo Professional (p.534). When you display RAW images on the camera, aspect ratio lines will be displayed to show the image area.

Image Quality	Aspect Ratio and Pixel Count (Approx.)			
	3:2	4:3	16:9	1:1
L	5472x3648 (20.0 megapixels)	4864x3648 (17.7 megapixels)	5472x3072* (16.8 megapixels)	3648x3648 (13.3 megapixels)
M	3648x2432 (8.9 megapixels)	3248x2432* (7.9 megapixels)	3648x2048* (7.5 megapixels)	2432x2432 (5.9 megapixels)
S1	2736x1824 (5.0 megapixels)	2432x1824 (4.4 megapixels)	2736x1536* (4.2 megapixels)	1824x1824 (3.3 megapixels)
S2	1920x1280 (2.5 megapixels)	1696x1280* (2.2 megapixels)	1920x1080 (2.1 megapixels)	1280x1280 (1.6 megapixels)
S3	720x480 (350,000 pixels)	640x480 (310,000 pixels)	720x408* (290,000 pixels)	480x480 (230,000 pixels)

- 
  - The image-recording quality settings marked with an asterisk do not match the respective aspect ratio exactly.
  - The recorded image areas of the aspect ratios marked with an asterisk may be slightly different from what are displayed. Check the captured images on the LCD monitor when shooting.
  - If you use a different camera to directly print images shot with this camera in the 1:1 aspect ratio, the images may not be correctly printed.

- **Exposure simulation** <sup>☆</sup>

Exposure simulation simulates and displays how the brightness of the actual image (exposure) will look.

- **Enable** (  )

The displayed image brightness will be close to the actual brightness (exposure) of the resulting image. If you set exposure compensation, the image brightness will change accordingly.

- **During**  (  /  )

Normally, the image is displayed at the standard brightness to make the Live View image easy to see. The image will be displayed close to the actual brightness (exposure) of the resulting image only while you hold down the depth-of-field preview button.

- **Disable** (  )

The image is displayed at the standard brightness to make the Live View image easy to see. Even if you set exposure compensation, the image is displayed at the standard brightness.

## 6 ☆

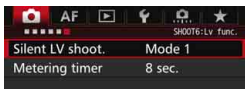

### ● Silent LV shooting ☆

#### • Mode 1

You can suppress the camera noise when shooting. Continuous shooting is also possible. If <[H]> is set, you can shoot at a maximum continuous shooting speed of approx. 10.0 fps.

#### • Mode 2

When the shutter button is pressed completely, only one shot will be taken. While you keep holding down the shutter button, the camera operation will be suspended. Then when you return to the shutter button's halfway position, the camera operation will resume. The shooting noise is thereby minimized. Even if continuous shooting is set, only a single shot will be taken.

#### • Disable

Be sure to set it to **[Disable]** if you use a TS-E lens (other than those listed in [ ] below) **for shifting or tilting the lens** or if you use an Extension Tube. If **[Mode 1]** or **[Mode 2]** is set, the standard exposure may not be obtained, or an irregular exposure may result.







- If you use **[Mode 1]** with continuous shooting, the **[Disable]** setting will be applied to the second and subsequent shots.
- When shooting with flash, the **[Disable]** setting will be applied regardless of the **[Silent LV shoot.]** setting. (Silent shooting cannot be performed.)
- When using a non-Canon flash unit, set it to **[Disable]**. The flash will not fire if it is set to **[Mode 1]** or **[Mode 2]**.
- If **[Mode 2]** is set and you use a Remote Controller (p.248), the operation will be the same as with **[Mode 1]**.



With the TS-E17mm f/4L or TS-E24mm f/3.5L II lens, you can use **[Mode 1]** or **[Mode 2]**.

● **Metering timer**★

You can change how long the exposure setting is displayed (AE lock time).

-  Performing any of the following operations will stop Live View shooting. To start Live View shooting again, press the <START/STOP> button.
- Selecting [ **3: Dust Delete Data**], [ **3: Sensor cleaning**], [ **4: Clear all camera settings**], or [ **4: firmware ver.**].

# Using AF to Focus (AF Method)

## Changes in AF Speed Depending On the AF Control Method

During Live View shooting and movie shooting, the AF control method used (phase-difference detection with the image sensor or contrast detection) will switch automatically depending on the lens and function used, such as magnified view. This can greatly affect the AF speed and the camera may take a longer time to focus (phase-difference detection generally allows faster AF focusing). For details, refer to the Canon website.

## Selecting the AF Method

You can select an AF method to suit the shooting conditions and your subject. The following AF methods are provided: [**AF** (face)+Tracking] (p.300), [**FlexiZone - Multi**] (p.302), and [**FlexiZone - Single**] (p.304). If you want to achieve precise focus, set the lens's focus mode switch to <MF>, magnify the image, and focus manually (p.308).

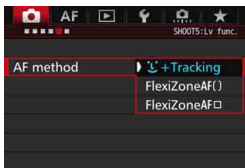

## Select the AF method.

- Under the [**5**] tab (the [**3**] tab in <A+>), select [**AF method**].
- Select the desired AF method, then press <SET>.
- When the Live View image is displayed, you can press the <DRIVE•AF> button to select the AF method.

## ☺ (face)+Tracking: AF ☺

The camera detects and focuses on human faces. If a face moves, the AF point <☺> also moves to track the face.

### 1 Display the Live View image.

- Press the <START/STOP> button.
- ▶ The Live View image will appear on the LCD monitor.



### 2 Select an AF point.

- When a face is detected, the <☺> frame will appear over the face to be focused on.
- If multiple faces are detected, <☺> will be displayed. Use <☺> to move the <☺> frame over the face you want to focus on.
- If no faces are detected, the camera will switch to FlexiZone - Multi for automatic selection (p.302).

### 3 Focus on the subject.

- Press the shutter button halfway to focus.
- ▶ When focus is achieved, the AF point will turn green and the beeper will sound.
- ▶ If focus is not achieved, the AF point will turn orange.

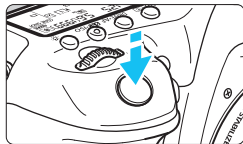





## 4 Take the picture.

- Check the focus and exposure, then press the shutter button completely to take the picture (p.286).

### ● Focusing on a subject other than a human face

Press  $\langle \text{AF-ON} \rangle$  or  $\langle \text{SET} \rangle$ , and the AF frame  $\langle \text{AF} \rangle$  will appear in the center. Then use  $\langle \text{AF-ON} \rangle$  to move the AF frame over the desired subject. Once the AF frame achieves focus, it will track the subject even if the subject moves or if you change the composition.



- If the subject's face is significantly out of focus, face detection will not be possible. You can prevent this by setting [**5: Continuous AF**] to **[Enable]**.
- An object other than a human face may be detected as a face.
- Face detection will not work if the face is very small or large in the picture, too bright or too dark, or partially hidden.
- The  $\langle \text{AF} \rangle$  may cover only part of the face.



- Since AF is not possible with a face detected near the edge of the picture, the  $\langle \text{AF} \rangle$  will be grayed out. If you press the shutter button halfway in this situation, the subject will be focused on in FlexiZone - Multi method with automatic selection.
- The shape of the AF frame  $\langle \text{AF} \rangle$  varies depending on the size and shape of the subject.

## FlexiZone - Multi: AF ( )

You can focus over a wide area with up to 31 AF points (automatic selection). This wide area can also be divided into 9 zones for focusing (zone selection).



Area frame



Zone frame

### 1 Display the Live View image.

- Press the  $\langle \text{START/STOP} \rangle$  button.
- ▶ The Live View image will appear on the LCD monitor.

### 2 Select the AF point. ☆

- Pressing  $\langle \text{AF} \rangle$  or  $\langle \text{SET} \rangle$  will toggle between automatic selection and zone selection. In the  $\langle \text{AF} \rangle$  mode, automatic selection is set automatically.
- Use  $\langle \text{AF} \rangle$  to select the zone. To return to the center zone, press  $\langle \text{AF} \rangle$  or  $\langle \text{SET} \rangle$  again.

### 3 Focus on the subject.

- Aim the AF point over the subject and press the shutter button halfway.
- ▶ When focus is achieved, the AF point will turn green and the beeper will sound.
- ▶ If focus is not achieved, the area frame will turn orange.

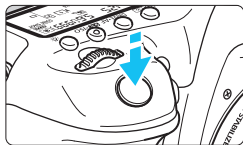



## 4 Take the picture.

- Check the focus and exposure, then press the shutter button completely to take the picture (p.286).



- If the camera does not focus on the desired target subject with automatic AF point selection, select a zone or switch the AF method to **[FlexiZone - Single]** and refocus.
- Depending on the **[CAM5: Aspect ratio]**, the number of AF points varies. At **[3:2]**, there are 31 AF points. At **[4:3]** and **[1:1]**, there are 25 AF points. And at **[16:9]**, 21 AF points. Also, at **[16:9]**, there are three zones.
- For movie shooting, there are 21 AF points (or 25 AF points if **[640x480]** is set) and three zones (or nine zones if **[640x480]** is set).

## FlexiZone - Single: AF □

The camera focuses with a single AF point. This is effective when you want to focus on a particular subject.



AF point

### 1 Display the Live View image.

- Press the <START/STOP> button.
- ▶ The Live View image will appear on the LCD monitor.
- ▶ The AF point <□> will appear.
- During movie shooting, if [Movie Servo AF] is set to [Enable], the AF point will be displayed in a larger size.



### 2 Move the AF point.

- Use <⦿> to move the AF point to where you want to focus. (It cannot be moved to the edge of the screen.)
- Pressing <⦿> or <SET> will return the AF point to the screen's center.

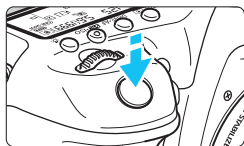

### 3 Focus on the subject.

- Aim the AF point over the subject and press the shutter button halfway.
- ▶ When focus is achieved, the AF point will turn green and the beeper will sound.
- ▶ If focus is not achieved, the AF point will turn orange.



### 4 Take the picture.

- Check the focus and exposure, then press the shutter button completely to take the picture (p.286).

## Notes for AF

### AF Operation

- Even when focus is achieved, pressing the shutter button halfway will focus again.
  - The image brightness may change during and after the AF operation.
  - If the light source changes while the Live View image is displayed, the screen may flicker and focusing may be difficult. If this happens, exit Live View shooting and execute AF under the actual light source.
  - If [**L** + **Tracking**] is set, magnified view is not possible.
  - When [**FlexiZone - Multi**] is set and you press the <Q> button, the center of the selected zone (or image center with automatic selection) will be magnified.
  - When [**FlexiZone - Single**] is set and you press the <Q> button, the area covered by the AF point will be magnified. If you press the shutter button halfway, focusing will be performed while displaying the magnified view. If focusing is difficult in magnified view, return to the normal display and use AF. Note that the AF speed may differ between the normal and magnified views.
  - If you magnify the view after focusing with [**FlexiZone - Multi**] or [**FlexiZone - Single**] in the normal view, precise focus may not be achieved.
- 
- When in magnified view, contrast-detection AF will be applied regardless of the lens used. The AF speed will therefore become slow.
  - When in magnified view, Continuous AF (p.294) will not be executed.
  - In magnified view, the image will be displayed without distortion correction applied.

## Shooting Conditions that Make Focusing Difficult

- Subject with low-contrast such as the blue sky, solid-color flat surfaces or when highlight or shadow details are lost.
- Subjects in low light.
- Stripes and other patterns where there is contrast only in the horizontal direction.
- Subjects with repetitive patterns (skyscraper windows, computer keyboards, etc.).
- Fine lines and subject outlines.
- Under a light source whose brightness, color, or pattern keeps changing.
- Night scenes or dots of light.
- Under fluorescent or LED lighting when the image flickers.
- Extremely small subjects.
- Subjects at the edge of the picture.
- Subjects strongly reflecting light.
- Near and distant subjects covered by an AF point (such as an animal in a cage).
- Subjects that keep moving within the AF point and cannot keep still due to camera shake or subject blur.
- A subject approaching or moving away from the camera.
- Performing AF while the subject is very far out of focus.
- Soft focus effect is applied with a soft focus lens.
- A special effect filter is used.
- Noise (spots, banding, etc.) appears on the screen during AF.



- If you cannot achieve focus with AF, set the lens's focus mode switch to **<MF>** and focus manually.
- If you shoot the subject at the periphery and it is slightly out of focus, aim the center AF point or zone over the subject to focus on, focus again, and then take the picture.
- The AF-assist beam will not be emitted. However, if an EX-series Speedlite (sold separately) equipped with an LED light is used, the LED light will turn on for AF-assist when necessary.
- During magnified view, camera shake may make it harder to achieve focus. Using a tripod is recommended.

# MF: Focusing Manually

You can magnify the image and focus precisely with MF (manual focus).

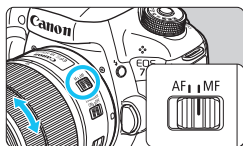

## 1 Set the lens's focus mode switch to <MF>.

- Turn the lens's focusing ring to focus roughly.



## 2 Display the magnifying frame.

- Press the <Q> button.
- ▶ The magnifying frame will appear.

Magnifying frame

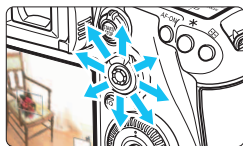

## 3 Move the magnifying frame.

- Use <⬆> to move the magnifying frame to the position where you want to focus.
- Pressing <⬆> will return the magnifying frame to the screen's center.

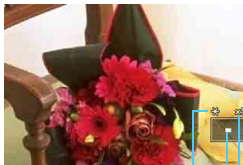

## 4 Magnify the image.

- Each time you press the <Q> button, the magnification within the frame will change as follows:

→ Normal view → 1x → 5x → 10x →

AE lock  
Magnified area position  
Magnification (Approx.)

- While in magnified view, you can use <⬆> to scroll around the magnified image.



## 5 Focus manually.

- While looking at the magnified image, turn the lens's focusing ring to focus.
- After achieving focus, press the <Q> button to return to the normal view.

## 6 Take the picture.







- Check the exposure, then press the shutter button completely to take the picture (p.286).

## General Live View Shooting Cautions

### Image Quality

- When you shoot at high ISO speeds, noise (such as dots of light and banding) may become noticeable.
- Shooting in high temperatures may cause noise and irregular colors in the image.
- If Live View shooting is used continuously for a prolonged period, the camera's internal temperature may rise, and image quality may deteriorate. Always exit Live View shooting when you are not shooting.
- If you shoot a long exposure while the camera's internal temperature is high, image quality may deteriorate. Exit Live View shooting and wait a few minutes before shooting again.

### White and Red Internal Temperature Warning Icons

- If the camera's internal temperature increases due to prolonged Live View shooting or under a high ambient temperature, a white  or red  icon will appear.
- The white  icon indicates that the image quality of still photos will deteriorate. It is recommended that you temporarily exit Live View shooting and allow the camera to cool down before shooting again.
- The red  icon indicates that the Live View shooting will soon stop automatically. If this happens, you will not be able to shoot again until the camera's internal temperature decreases. Exit the Live View shooting or turn off the power and let the camera rest for a while.
- Using Live View shooting at a high temperature for a prolonged period will cause the  or  icon to appear earlier. When you are not shooting, turn off the camera.
- If the camera's internal temperature is high, the quality of images shot with high ISO speed or long exposure may deteriorate even before the white  icon is displayed.

### Shooting Results

- In magnified view, the shutter speed and aperture will be displayed in red. If you take the picture in magnified view, the exposure may not come out as desired. Return to the normal view before taking the picture.
- Even if you take the picture in magnified view, the image will be captured in the normal view range.



## General Live View Shooting Cautions

### Live View Image

- Under low- or bright-light conditions, the Live View image may not reflect the brightness of the captured image.
- Even if a low ISO speed is set, noise may be noticeable in the displayed Live View image under low light. However, when you shoot, the image recorded will have minimal noise. (The image quality of the Live View image is different from that of the recorded image.)
- If the light source (illumination) within the image changes, the screen may flicker. If this happens, exit Live View shooting and resume Live View shooting under the actual light source.
- If you point the camera in a different direction, it may throw off the Live View image's correct brightness momentarily. Wait until the brightness level stabilizes before shooting.
- If there is a very bright light source in the image, the bright area may appear black on the LCD monitor. However, the actual captured image will correctly show the bright area.
- In low light, if you set the [**F2: LCD brightness**] to a bright setting, noise or irregular colors may appear in the Live View image. However, the noise or irregular colors will not be recorded in the captured image.
- When you magnify the image, the image sharpness may look more pronounced than in the actual image.

### Custom Functions

- During Live View shooting, some Custom Functions will not work (settings become invalid). For details, see p.432-433.

### Lens and Flash

- The focus preset function is possible for Live View shooting only when using a (super) telephoto lens equipped with the focus preset mode, available since the second half of 2011.
- FE lock will not work if the built-in flash is used. FE lock and modeling flash will not work if an external Speedlite is used.



# 9

## Shooting Movies

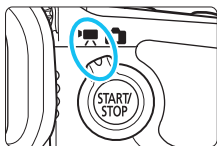

Movie shooting is enabled by setting the Live View shooting/Movie shooting switch to <img alt="movie camera icon" data-bbox="765 495 795 515"/>.

- For cards that can record movies, see page 5.
- If you handhold the camera and shoot movies, camera shake can cause blurred movies. Using a tripod is recommended.



### Full HD 1080

Full HD 1080 indicates compatibility with High-Definition featuring 1080 vertical pixels (scanning lines).



# Shooting Movies

## Autoexposure Shooting

When the shooting mode is set to  $\langle \text{A}^+ \rangle$ ,  $\langle \text{P} \rangle$ , or  $\langle \text{B} \rangle$ , autoexposure control will take effect to suit the scene's current brightness. Exposure control will be the same for all the shooting modes.

**1 Set the Mode Dial to  $\langle \text{A}^+ \rangle$ ,  $\langle \text{P} \rangle$ , or  $\langle \text{B} \rangle$ .**

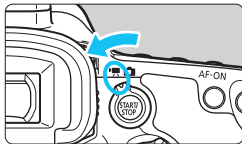

**2 Set the Live View shooting/Movie shooting switch to  $\langle \text{Movie} \rangle$ .**

- ▶ The reflex mirror will make a sound, then the image will appear on the LCD monitor.

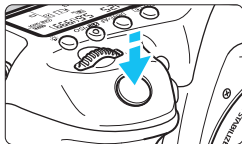

**3 Focus on the subject.**

- Before shooting a movie, focus with AF or manual focus (p.299-309).
- When you press the shutter button halfway, the camera will focus with the current AF method.

**4 Shoot the movie.**

- Press the  $\langle \text{START/STOP} \rangle$  button to start shooting a movie.
- ▶ While the movie is being shot, the “●” mark will be displayed on the upper right of the screen.
- ▶ Sound will be recorded by the built-in microphone.
- To stop shooting the movie, press the  $\langle \text{START/STOP} \rangle$  button again.

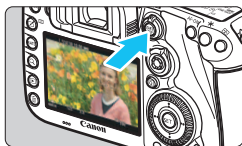

Recording movies

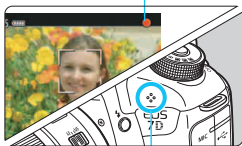

Built-in microphone

## Shutter-priority AE

When the shooting mode is <Tv>, you can manually set the shutter speed for movie shooting. The ISO speed and aperture will be set automatically to suit the brightness and obtain a standard exposure.



### 1 Set the Mode Dial to <Tv>.

### 2 Set the Live View shooting/Movie shooting switch to <Movie>.

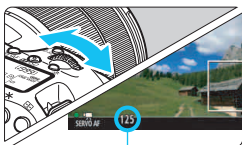

Shutter speed

### 3 Set the desired shutter speed.

- While looking at the LCD monitor, turn the <Gear> dial. The settable shutter speeds depend on the frame rate.
  - 29.97P 25.00P 24.00P 23.98P : 1/4000 sec. - 1/30 sec.
  - 59.94P 50.00P : 1/4000 sec. - 1/60 sec.

### 4 Focus and shoot the movie.

- The procedure is the same as steps 3 and 4 for “Autoexposure Shooting” (p.314).



- Changing the shutter speed during movie shooting is not recommended since the changes in the exposure will be recorded.
- When shooting a movie of a moving subject, a shutter speed of 1/30 sec. to 1/125 sec. is recommended. The faster the shutter speed, the less smooth the subject's movement will look.
- If you change the shutter speed while shooting under fluorescent or LED lighting, image flicker may be recorded.

## Av Aperture-priority AE

When the shooting mode is <Av>, you can manually set the aperture for movie shooting. The ISO speed and shutter speed will be set automatically to suit the brightness and obtain a standard exposure.



**1 Set the Mode Dial to <Av>.**

**2 Set the Live View shooting/Movie shooting switch to <Movie>.**

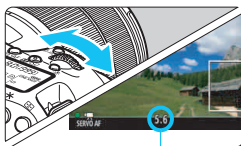

**3 Set the desired aperture.**

- While looking at the LCD monitor, turn the <Aperture> dial.

Aperture



**4 Focus and shoot the movie.**

- The procedure is the same as steps 3 and 4 for “Autoexposure Shooting” (p.314).



Changing the aperture during movie shooting is not recommended since variations in the exposure, due to the drive of the lens aperture, will be recorded.



### ISO speed in the <A+> mode

- In the <A+> mode, the ISO speed will be set automatically within ISO 100 - ISO 16000.

### ISO Speed in the <P>, <Tv>, <Av>, and <B> Mode

- The ISO speed will be set automatically within ISO 100 - ISO 16000.
- Under [ 2: ISO speed settings] (p.157), if you set the [ISO speed range]'s [Maximum] setting to [H1 (25600)] in the <P>, <Av>, or <B> mode, the automatic ISO range will be expanded to H1 (equivalent to ISO 25600). Even if you set the [Maximum] and [Minimum] to a narrower range than the default ISO range (ISO 100 - ISO 16000), it will not take effect.
- If [ 3: Highlight tone priority] is set to [Enable] (p.180), the automatic ISO range will be ISO 200 - ISO 16000.
- Under [ 2: ISO speed settings], [Auto ISO range] and [Min. shutter spd.] cannot be set (p.158-159) for movie shooting. Also, [ISO speed range] cannot be set in the <Tv> mode.

- For [ISO speed range], if [Maximum] is set to [H2 (51200)] and you switch from still photo shooting to movie shooting, the automatic ISO range's maximum for movie shooting will be H1 (equivalent to ISO 25600, except in <A+> and <Tv> modes). It cannot be expanded to ISO 51200.



### Notes for <A+>, <P>, <Tv>, <Av>, and <B> Modes

- In the <A+> mode, the scene icon for the scene detected by the camera is displayed on the upper left of the screen (p.319).
- You can lock the exposure (AE lock) by pressing the <★> button (except in the <A+> mode, p.229). The exposure setting will be displayed for the time length set with [6: Metering timer]. After applying AE lock during movie shooting, you can cancel it by pressing the <E> button. (AE lock setting is retained until you press the <E> button.)
- You can set exposure compensation up to ±3 stops by setting the <LOCK▶> switch to the left and turning the <◉> dial (except in the <A+> mode).
- Pressing the shutter button halfway displays the ISO speed and shutter speed at the screen bottom. This is the exposure setting for taking a still photo (p.323). The exposure setting for movie shooting is not displayed. Note that the exposure setting for movie shooting may differ from that for still photo shooting.
- In the <A+>, <P>, and <B> modes, the shutter speed and aperture will not be recorded in the movie's Exif information.

## Using an EX-series Speedlite (Sold Separately) Equipped with an LED Light

During movie shooting in the <A+>, <P>, <Tv>, <Av>, and <B> modes, this camera supports the function that turns on the Speedlite's LED light automatically in low-light conditions. **For detailed instructions, refer to the EX-series Speedlite's instruction manual.**

## Scene Icons

During movie shooting in the  $\langle \text{A}^+ \rangle$  mode, an icon representing the scene detected by the camera will be displayed, and the shooting will be adapted to that scene. For certain scenes or shooting conditions, the icon displayed may not match the actual scene.

Subject \ Background	Portrait <sup>*1</sup>	Non-Portrait		Background Color
		Nature and Outdoor Scene	Close <sup>*2</sup>	
Bright				Gray
Backlit				
Blue Sky Included				Light blue
Backlit				
Sunset	*3		*3	Orange
Spotlight				Dark blue
Dark				

\*1: Displayed only when the AF method is set to  $\langle \text{A}^+ \text{Tracking} \rangle$ . If another AF method is set, the “Non-portrait” icon will be displayed even if a person is detected.

\*2: Displayed when the attached lens has distance information. With an Extension Tube or Close-up Lens, the icon displayed may not match the actual scene.

\*3: The icon suiting the scene detected will be displayed.

## Manual Exposure Shooting

You can manually set the shutter speed, aperture, and ISO speed for movie shooting. Using manual exposure to shoot movies is for advanced users.



**1 Set the Mode Dial to <M>.**

**2 Set the Live View shooting/Movie shooting switch to <[Movie Icon]>.**



**3 Set the ISO speed.**

- Press the <[ISO]•ISO> button.
- ▶ The ISO speed setting screen will appear on the LCD monitor.
- Turn the <[ISO Dial]> dial to set the ISO speed.
- For details on the ISO speed, see the next page.

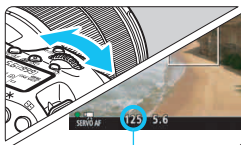

Shutter speed

**4 Set the shutter speed and aperture.**

- Press the shutter button halfway and check the exposure level indicator.
- To set the shutter speed, turn the <[Shutter Speed Dial]> dial. The settable shutter speeds depend on the frame rate.
  - **29.97P 25.00P 24.00P 23.98P** : 1/4000 sec. - 1/30 sec.
  - **59.94P 50.00P** : 1/4000 sec. - 1/60 sec.
- To set the aperture, turn the <[Aperture Dial]> dial.
- If it cannot be set, set the <[LOCK] switch to the left, then turn the <[Aperture Dial]> or <[Shutter Speed Dial]> dial.

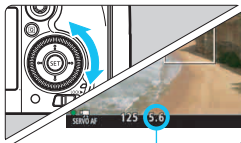

Aperture

## 5 Focus and shoot the movie.

- The procedure is the same as steps 3 and 4 for “Autoexposure Shooting” (p.314).

### ISO Speed in the <M> Mode

- With [**Auto**] (**A**), the ISO speed will be set automatically within ISO 100 - ISO 16000. Under [**2: ISO speed settings**], if you set [**ISO speed range**]’s [**Maximum**] setting to [**H1 (25600)**] (p.157), the automatic ISO range will not expand to the H1 maximum. Even if you set the [**Maximum**] and [**Minimum**] to a narrower range than the default ISO range (ISO 100 - ISO 16000), it will not take effect.
- You can set the ISO speed manually within ISO 100 - ISO 16000 in 1/3-stop increments. Under [**2: ISO speed settings**], if you set [**ISO speed range**]’s [**Maximum**] setting to [**H1 (25600)**], the manual ISO speed setting range’s maximum will be expanded to H1 (equivalent to ISO 25600). You can also set the [**Maximum**] and [**Minimum**] to a range narrower than the default range (ISO 100 - ISO 16000).
- If [**3: Highlight tone priority**] is set to [**Enable**] (p.180), the auto or manual ISO setting range will be ISO 200 - ISO 16000.
- Under [**2: ISO speed settings**], [**Auto ISO range**] and [**Min. shutter spd.**] cannot be set (p.158-159) for movie shooting.

- Under **[ISO speed range]**, if **[Maximum]** is set to **[H2 (51200)]** and you switch from still photo shooting to movie shooting, the maximum ISO speed for the manual ISO range during movie shooting will be H1 (equivalent to ISO 25600). It cannot be expanded to ISO 51200.
- Changing the shutter speed or aperture during movie shooting is not recommended since the changes in the exposure will be recorded.
- When shooting a movie of a moving subject, a shutter speed of 1/30 sec. to 1/125 sec. is recommended. The faster the shutter speed, the less smooth the subject's movement will look.
- If you change the shutter speed while shooting under fluorescent or LED lighting, image flicker may be recorded.

- Under **[. 3: Custom Controls]**, if **[SET: Expo comp (hold btn, turn )]** is set (p.455), you can set exposure compensation while Auto ISO is set.
- When Auto ISO is set, you can press the **< \* >** button to lock the ISO speed.
- If you press the **< \* >** button and recompose the shot, you can see the exposure level difference on the exposure level indicator (p.323) compared to when the **< \* >** button was pressed.
- By pressing the **< INFO. >** button, you can display the histogram.

## Information Display

- Each time you press the <INFO.> button, the information display will change.

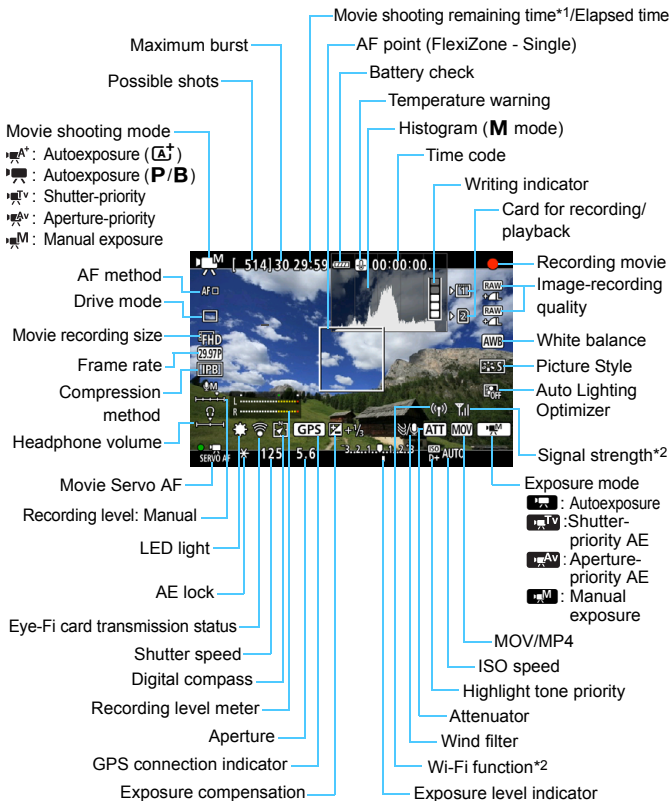

\*1: Applies to a single movie clip.

\*2: Refer to the Wi-Fi Adapter W-E1 Instruction Manual.

- 
- You can display the electronic level by pressing the <INFO.> button (p.75).
  - Note that if the AF method is set to [**L** +Tracking] or the camera is connected to a TV set with an HDMI cable (p.385), the electronic level cannot be displayed.
  - The electronic level cannot be displayed during movie shooting. (The electronic level will disappear when you start shooting a movie.)
  - When movie shooting starts, the movie shooting remaining time will change to the elapsed time.





## Cautions for Movie Shooting

- Do not point the camera toward an intense light source, such as the sun on a sunny day or an intense artificial light source. Doing so may damage the image sensor or the camera's internal components.
- Under [**F1: Record func+card/folder sel.**], even if [**Record func.**] is set to [**Rec. to multiple**] (p.147), the movie cannot be recorded to both the CF card [**1**] and SD card [**2**]. If [**Rec. separately**] or [**Rec. to multiple**] is set, the movie will be recorded to the card which is set for [**Playback**].
- If <AWB> is set and the ISO speed or aperture changes during movie shooting, the white balance may also change.
- If you shoot a movie under fluorescent or LED lighting, the movie may flicker.
- Shooting a few test movies is recommended where you will perform zooming during movie shooting. Zooming during movie shooting may result in recording of changes in exposure or mechanical sound of the lens, or images may be out of focus.
- During movie shooting, you cannot magnify the image even if you press the <Q> button.
- Be careful not to cover the built-in microphone (p.314) with your finger, etc.
- [**Multi Shot Noise Reduction**] (p.176) and [**Distortion**] (p.182) cannot be set. (They will not function.)
- If you connect or disconnect the HDMI cable during movie shooting, the movie shooting will end.
- **General Movie Shooting Cautions are on pages 351-352.**
- **If necessary, also read General Live View Shooting Cautions on pages 310-311.**





## Notes for Movie Shooting

- Movie-related settings are under the [CAMERA 4] and [CAMERA 5] tabs (p.342). In the <A+> mode, they are under the [CAMERA 2] and [CAMERA 3] tabs.
- A movie file is recorded each time you shoot a movie. If the file size exceeds 4 GB, a new file will be created for every subsequent approx. 4 GB.
- The movie image's field of view is approx. 100% (when the movie recording size is set to FHD).
- You can also focus on the image by pressing the <AF-ON> button.
- Under [CAMERA 5:  button function], if [CAMERA 5: ] [CAMERA 5: ] is selected, you can press the shutter button completely to start or stop the movie shooting (p.348).
- Monaural sound is recorded by the camera's built-in microphone (p.314).
- Stereo sound recording is also possible by connecting the Directional Stereo Microphone DM-E1 (sold separately) to the camera's external microphone IN terminal (p.23) as the external microphone is given the priority.
- By using HDMI Cable HTC-100 (sold separately), you can display the movie on a TV screen (p.385). If the picture does not appear on the TV screen, check if [CAMERA 3: Video system] is correctly set to [For NTSC] or [For PAL] (depending on the video standard of your TV set).
- By connecting stereo headphones (commercially available) equipped with a 3.5 mm diameter mini plug to the camera's headphone terminal (p.23), you can listen to the sound during movie shooting.
- You can use Remote Controller RC-6 (sold separately, p.248) to start and stop the movie shooting if the drive mode is <CAMERA 5: > or <CAMERA 5: \_2>. Set the shooting timing switch to <2> (2-sec. delay), then press the transmit button. If the switch is set to <●> (immediate shooting), still photo shooting will take effect.
- With a fully-charged Battery Pack LP-E6N, the total movie recording time will be as follows: At 23°C/73°F: Approx. 1 hr. 40 min., At 0°C/32°F: Approx. 1 hr. 30 min.
- The focus preset function is possible for movie shooting when using a (super) telephoto lens equipped with the focus preset mode, available since the second half of 2011.



### Do not hold the camera in the same position for long periods of time.

Even if the camera does not feel too hot, prolonged contact with the same body part may cause skin redness, blistering or low-temperature contact burns. Using a tripod is recommended for people with circulation problems or very sensitive skin, or when using the camera in very hot places.

## Final Image Simulation

The final image simulation shows the results of the current settings for Picture Style, white balance and other functions in the image so you can see what the captured image will look like.

During movie shooting, the image displayed will automatically show the effects of the settings listed below.

### Final Image Simulation for Movie Shooting

- Picture Style
  - \* All settings such as sharpness, contrast, color saturation, and color tone will be reflected.
- White balance
- White balance correction
- Exposure
- Depth of field
- Auto Lighting Optimizer
- Peripheral illumination correction
- Chromatic aberration correction
- Highlight tone priority

## Shooting Still Photos

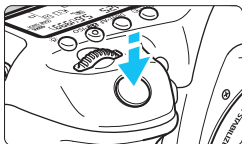



While shooting a movie, you can also take a still photo by pressing the shutter button completely.

### Taking Still Photos During Movie Shooting

- If you take a still photo during movie shooting, the movie will record a still moment lasting approx. 1 sec.
- The captured still photo will be recorded to the card, and the movie shooting will resume automatically when the Live View image is displayed.
- The movie and still photo will be recorded as separate files on the card.
- Under [**1: Record func+card/folder sel.**], if [**Record func.**] (p.146) is set to [**Standard**] or [**Auto switch card**], the movies and still photos will be recorded to the same card. If [**Rec. separately**] or [**Rec. to multiple**] is set, the movies will be recorded to the card set for [**Playback**] (p.148). The still photos will be recorded at the image-recording quality set for the respective card.
- Functions particular to still photo shooting are shown below. Other functions will be the same as for movie shooting.

Function	Settings
<b>Image-recording Quality</b>	As set in [ <b>1: Image quality</b> ]. When the movie recording size is [ <b>1920x1080</b> ] or [ <b>1280x720</b> ], the aspect ratio will be 16:9. When the size is [ <b>640x480</b> ], the aspect ratio will be 4:3.
<b>ISO Speed*</b>	<ul style="list-style-type: none"> <li>• &lt;[<b>A</b><sup>+</sup>&gt;: ISO 100 - ISO 6400</li> <li>• &lt;[<b>P</b>&gt;, &lt;[<b>Tv</b>&gt;, &lt;[<b>Av</b>&gt;, and &lt;[<b>B</b>&gt;: ISO 100 - ISO 16000</li> <li>• &lt;[<b>M</b>&gt;: See "ISO Speed in the &lt;[<b>M</b>&gt; mode" on page 321.</li> </ul>
<b>Exposure Setting</b>	<ul style="list-style-type: none"> <li>• &lt;[<b>A</b><sup>+</sup>&gt;, &lt;[<b>P</b>&gt;, and &lt;[<b>B</b>&gt;: Automatically-set shutter speed and aperture.</li> <li>• &lt;[<b>Tv</b>&gt;: Manually-set shutter speed and automatically-set aperture.</li> <li>• &lt;[<b>Av</b>&gt;: Manually-set aperture and automatically-set shutter speed.</li> <li>• &lt;[<b>M</b>&gt;: Manually-set shutter speed and aperture.</li> </ul>

\* If highlight tone priority is set, the ISO speed range will start from ISO 200.

- 
  - If  $\overline{\text{FHD}}$   $\overline{59.94\text{P}}$  (59.94 fps) or  $\overline{50.00\text{P}}$  (50.00 fps) is set, or if [**5:  button function**] is set to [ $\overline{\text{AF}}$ / $\overline{\text{AF}}$ ] or [ $\overline{\text{AF}}$ / $\overline{\text{AF}}$ ], you cannot take still photos.
  - Still photo shooting during movie shooting will have approx. 99% coverage with  $\overline{\text{FHD}}$  or  $\overline{\text{HD}}$ , and approx. 98% with  $\overline{\text{VGA}}$  (when the image-recording quality is set to JPEG  $\overline{\text{L}}$ ).
  - AEB cannot be used.
  - Even if a flash is used, it will not fire.
  - Continuous still photo shooting is possible during movie shooting. However, the captured images will not be displayed on the screen. Depending on the still photo's image-recording quality, number of shots during continuous shooting, card performance, etc., movie shooting may stop automatically.
  - AF is possible during movie shooting. However, the following may occur:
    - Focus may become far off momentarily.
    - The brightness of the recorded movie may change.
    - The recorded movie may be momentarily still.
    - The movie may record the lens operation noise.
    - If focus cannot be achieved, you cannot shoot still photos.

- 
  - Exposure compensation up to  $\pm 3$  stops can be applied for still photo shooting during movie shooting.
  - If you want to shoot still photos continuously during movie shooting, using a high-speed card is recommended. Setting a smaller image-recording quality for still photos and shooting fewer continuous still photos are also recommended.
  - You can shoot still photos in all drive modes.
  - The self-timer can be set before you start shooting a movie. During movie shooting, the camera will switch to single-image shooting.



- To select the card for recording/ playing back, WB Shift/Bracketing, or Picture Style parameters, press the <INFO.> button.
- Pressing <SET> will return the camera to movie shooting.

## **MENU** Setting the Movie Recording Size



With [**4: Movie rec quality**] (the [**2**] tab in <A+>), you can set the movie recording format, movie recording size (size, frame rate, compression method), and other functions.

The frame rate displayed on the [**Movie rec. size**] screen switches automatically depending on the [**3: Video system**] setting (p.491).

### **MOV/MP4**

You can select the movie's recording format.

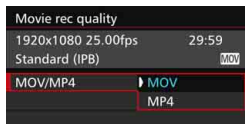

#### **MOV MOV**

The movie is recorded in the MOV format (file extension: “.MOV”).  
Convenient for editing with a computer.

#### **MP4 MP4**

The movie is recorded in the MP4 format (file extension: “.MP4”). This format is compatible with a much larger range of playback systems than the MOV format.

## Movie Recording Size

You can select the movie's size, frame rate, and compression method.



- **Image Size**

- **FHD 1920x1080**

Full High-Definition (Full HD) recording quality. The aspect ratio is 16:9.

- **FHD 1280x720**

High-Definition (HD) recording quality. The aspect ratio is 16:9.

- **VGA 640x480**

Standard-definition recording quality. The aspect ratio is 4:3.

- **Frame Rate** (fps: frames per second)

**29.97P 29.97 fps** / **59.94P 59.94 fps**

For areas where the TV format is NTSC (North America, Japan, South Korea, Mexico, etc.).

**25.00P 25.00 fps** / **50.00P 50.00 fps**

For areas where the TV format is PAL (Europe, Russia, China, Australia, etc.).

**23.98P 23.98 fps** / **24.00P 24.00 fps**

Mainly for motion pictures. Regarding **24.00P**, see page 333.



Movies recorded at **FHD 59.94P** (59.94fps) or **50.00P** (50.00fps) may not be played back properly on other devices, due to the heavy data processing load during playback.



The frame rate displayed on the movie recording size screen depends on whether [**3: Video system**] is set to [**For NTSC**] or [**For PAL**].

## ● Compression Method

### ALL-I (For editing/I-only)



Compresses one frame at a time for recording. Although the file size is larger than with IPB (Standard) and IPB (Light), the movie is more suited for editing.

### IPB (Standard)

Compresses multiple frames at a time efficiently for recording. Since the file size is smaller than with ALL-I (For editing), you can shoot longer (with the same card).

### IPB (Light)

Selectable when the movie recording format is set to **[MP4]**. The movie is recorded at bit rate lower than with IPB (Standard) resulting in a smaller file size and compatibility with a larger range of playback systems. Of the three methods available, this method allows the longest total possible movie shooting time on a card of a given capacity.

- If  **59.94P** (59.94 fps) or  (50.00 fps) is set, certain functions will not be available.
  - Movie Servo AF will not work.
  - Contrast-detection AF will be applied. (Focusing may take longer than usual.)
  - Still photos cannot be taken.
- If you change the [**3: Video system**] setting, set the movie recording size again.



## 24.00p

Records the movie at a frame rate of 24.00 fps. Applies to Full HD quality.

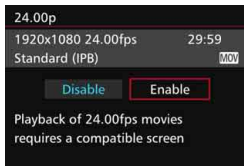

If **[Enable]** is set, the movie is recorded in **[FHD 24.00P ALL-I]** or **[FHD 24.00P IPB]**.

If you have set **[Movie rec. size]** and then set **[24.00p]** to **[Enable]**, set the **[Movie rec. size]** again.

### Cautions for [24.00p: Enable]

- **[⚡3: Video system]** cannot be set.
- **[⚡3: HDMI frame rate]** (p.350) cannot be set. The movie will be output at 1080/24.00p via HDMI. If you connect the camera to a TV set etc. not compatible with the 1080/24.00p signal via HDMI, the movie may not appear.
- If you set it back to **[Disable]**, **[⚡3: HDMI frame rate]** will be set to **[Auto]**.
- Even if you set it back to **[Disable]**, the movie recording size will not revert to the original. Set the movie recording size again.

## Total Movie Recording Time and File Size Per Minute

### ● In MOV Format

(Approx.)

Movie Recording Quality				Total Recording Time on Card			File Size
				4 GB	8 GB	16 GB	
FHD	59.94P	50.00P	IPB	8 min.	17 min.	34 min.	440 MB/min.
	29.97P	25.00P	ALL-I	5 min.	11 min.	23 min.	654 MB/min.
	29.97P	25.00P	IPB	16 min.	33 min.	1 hr. 7 min.	225 MB/min.
HD	59.94P	50.00P	ALL-I	6 min.	13 min.	26 min.	583 MB/min.
	59.94P	50.00P	IPB	19 min.	38 min.	1 hr. 17 min.	196 MB/min.
VGA	29.97P	25.00P	IPB	50 min.	1 hr. 41 min.	3 hr. 22 min.	75 MB/min.

### ● In MP4 Format

(Approx.)

Movie Recording Quality				Total Recording Time on Card			File Size
				4 GB	8 GB	16 GB	
FHD	59.94P	50.00P	IPB	8 min.	17 min.	35 min.	431 MB/min.
	29.97P	25.00P	ALL-I	5 min.	11 min.	23 min.	645 MB/min.
	29.97P	25.00P	IPB	17 min.	35 min.	1 hr. 10 min.	216 MB/min.
	29.97P	25.00P	IPB	43 min.	1 hr. 26 min.	2 hr. 53 min.	87 MB/min.
HD	59.94P	50.00P	ALL-I	6 min.	13 min.	26 min.	574 MB/min.
	59.94P	50.00P	IPB	20 min.	40 min.	1 hr. 21 min.	187 MB/min.
	29.97P	25.00P	IPB	2 hr. 5 min.	4 hr. 10 min.	8 hr. 20 min.	30 MB/min.
VGA	29.97P	25.00P	IPB	57 min.	1 hr. 55 min.	3 hr. 50 min.	66 MB/min.
	29.97P	25.00P	IPB	2 hr. 43 min.	5 hr. 26 min.	10 hr. 53 min.	23 MB/min.

 An increase of the camera's internal temperature may cause movie shooting to stop before the maximum recording time shown in the table (p.351).

- **Movie Files Exceeding 4 GB**

Even if you shoot a movie exceeding 4 GB, you can keep shooting without interruption.

During movie shooting, approx. 30 sec. before the movie reaches the 4 GB file size, the elapsed shooting time or time code displayed in the movie-shooting screen will start blinking. If you keep shooting until the movie file size exceeds 4 GB, a new movie file will be created automatically and the elapsed shooting time or time code will stop blinking.

When you play back the movie, you will have to play each movie file individually. Movie files cannot be played back automatically in consecutive order. After the movie playback ends, select the next movie and play it back.

- **Movie Shooting Time Limit**

The maximum recording time of one movie clip is 29 min. 59 sec. If the movie shooting time reaches 29 min. 59 sec., the movie shooting will stop automatically. You can start shooting a movie again by pressing the  button. (A new movie file starts being recorded.)



When shooting movies, if the file size exceeds 4 GB, “**buSY**” will be displayed on the LCD panel for a while. Still photo shooting is not possible while “**buSY**” is displayed on the screen.

## MENU Setting the Sound Recording

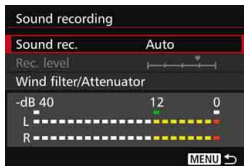

You can shoot movies while recording sound with the built-in monaural microphone or the Directional Stereo Microphone DM-E1 (sold separately). You can also freely adjust the sound-recording level.

Sound-recording settings are under [**4: Sound recording**] (the [**2**] tab in <[**A**+]>).

### Sound Recording/Sound-Recording Level

- Auto** : The sound-recording level is adjusted automatically. Auto level control will operate automatically in response to the sound level.
- Manual** : For advanced users. You can adjust the sound-recording level to one of 64 levels.  
Select [**Rec. level**] and look at the level meter while turning the <[**0**]> dial to adjust the sound-recording level. While looking at the peak hold indicator, adjust so that the level meter sometimes lights up the “12” (-12 dB) mark on the right for the loudest sounds. If it exceeds “0”, the sound will be distorted.
- Disable** : Sound will not be recorded. Also, no sound will be output through HDMI output (p.348).

### Wind Filter/Attenuator

- Wind filter** : When [**Enable**] is set, it reduces the wind noise when recording outdoors. This feature takes effect only with the built-in microphone. Note that [**Enable**] reduces low bass sounds, so set it to [**Disable**] when there is no wind. It will record a more natural sound than with [**Enable**].
- Attenuator** : Automatically suppresses sound distortion caused by loud noises. Even if [**Sound rec.**] is set to [**Auto**] or [**Manual**] before shooting, sound distortion may still result if there is a very loud sound. In such a case, setting it to [**Enable**] is recommended.

### ● Using a microphone

Normally, the built-in microphone will record monaural sound. Stereo sound recording is also possible by connecting the Directional Stereo Microphone DM-E1 (sold separately) to the camera's external microphone IN terminal (p.23) as the external microphone is given the priority.

### ● Using headphones

By connecting stereo headphones (commercially available) equipped with a 3.5 mm diameter mini plug to the camera's headphone terminal (p.23), you can listen to the sound during movie shooting. If you are using the Directional Stereo Microphone DM-E1 (sold separately), you can listen to the sound in stereo. To adjust the headphones' sound volume, press the <Q> button and select <Ω>. Then turn <⊙> to adjust (p.329).

You can also use headphones during movie playback.



When using headphones for audio, noise reduction will not be applied to the headphone output. Because of this, what you hear will differ from the actual audio recorded with the movie.



- In the <A+> mode, [Sound recording] can be set to [On] or [Off]. If [On] is set, the sound-recording level will be adjusted automatically (same as with [Auto]), but the wind filter function will not take effect.
- When the camera is connected to a TV set with the HDMI cable, sound will also be output (except when [Sound recording] is set to [Off]). If the sound from the TV set causes audio feedback, place the camera farther away from the TV set or turn down the TV set's sound volume.
- You can also adjust the headphones' volume by pressing the <Q> button, then holding down the <RATE> button and titling <⊙> up or down.
- The sound volume balance between L (left) and R (right) cannot be adjusted.
- Audio is recorded at a 48 kHz/16-bit sampling rate.
- If [5: Silent Control] is set to [Enable ⊕] (p.338), you can adjust the sound-recording level with the <⊕> touch pad with less operation noise during movie shooting.

## MENU Silent Control

You can change the settings of the ISO speed, sound-recording level, etc., without making too much noise while shooting a movie.



When [**5: Silent Control**] (the [**3**] tab in <[A+]>) is set to [**Enable [On]**], you can use the touch pad <[On]> on the inner ring of the Quick Control Dial.

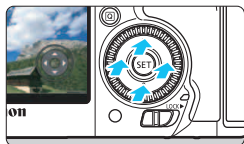

You can just touch the top, bottom, left, or right of <[On]> for silent operation. During movie shooting, you can press the <[Q]> button to display the Quick Control screen and change the functions below with <[On]>.



Settable Functions	Shooting Mode				
	[A+]	P/B	Tv	Av	M
Shutter speed	-	-	○	-	○
Aperture	-	-	-	○	○
Exposure compensation	-	○	○	○	○*1
ISO speed	-	-	-	-	○
Recording level*2	-	○	○	○	○
[V] Volume	○	○	○	○	○

\*1: With Auto ISO set.

\*2: With [**Sound recording: Manual**] set.

- ! If [**5: Silent Control**] is set to [**Enable [On]**], you cannot change Quick Control settings with the <[On]> Quick Control dial during movie shooting.
- Even if you change the aperture silently with <[On]>, the movie will still record the lens aperture-driving sound.
- If there is water or dirt on the <[On]>, the touch operation may not work. In such a case, use a clean cloth to clean the <[On]>. If it still does not work, wait a while and try again.

Before shooting a movie, you can use <[On]> with the [**Rec. level**] setting to adjust the sound-recording level.

## MENU Setting the Time Code

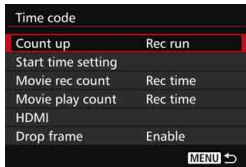

The time code is a time reference recorded automatically to synchronize the movie during movie shooting. It is recorded at all times in the following units: hours, minutes, seconds, and frames. It is mainly used during movie editing.

Use [**5: Time code**] (the [**3**] tab in <[A+] >) to set the time code.

### Count Up

- Rec run** : The time code counts up only while you are shooting a movie. The time code will continue in the sequence of the movie files captured.
- Free run** : The time code counts up whether you are shooting a movie or not.

### Start Time Setting

You can set the time code's start time.

- Manual input setting** : You can freely set the hour, minute, second, and frames.
- Reset** : The time set with [**Manual input setting**] and [**Set to camera time**] is reset to "00:00:00." or "00:00:00:" (p.341).
- Set to camera time** : Sets hours, minutes, and seconds to match the camera's internal clock. "Frames" will be set to 00.



- Shooting still photos during movie shooting will cause a discrepancy between the actual time and time code.
- If [**Free run**] is set and you change the time, zone, or daylight saving time (p.47), the time code will be affected.
- If you use a different camera to play an MP4 movie recorded with this camera, the time code may not be displayed correctly.

## Movie Recording Count

You can select what to display on the movie shooting screen.

**Rec time** : Indicates the elapsed time from the start of the movie shooting.

**Time code** : Indicates the time code during movie shooting.

## Movie Playback Count

You can select what to display on the movie playback screen.

**Rec time** : Displays the recording time and playback time during movie playback.

**Time code** : Displays the time code during movie playback.

With [Time code] set:



During movie shooting



During movie playback

- Regardless of the [Movie rec count] setting, the time code will always be recorded to the movie file.
- The [Movie play count] setting under [CAMERA 5: Time code] switches in tandem with the [CAMERA 3: Movie play count] setting. Changing either setting will automatically change the other.
- “Frames” are not displayed for movie shooting or during movie playback.



## HDMI

- **Time code**

The time code can be appended to a movie that is output via HDMI (p.350).

**Enable:** Appends time code to HDMI output movie.

**Disable:** Time code not appended to HDMI output movie.

- **Record command**

When you record a movie that is an output from HDMI to an external recording device, the camera's movie shooting start/stop can sync with the recording from that external recording device.

**Enable:** Synchronizes external recording device's recording start/stop with camera's movie shooting start/stop.

**Disable:** Controls external device's recording start/stop from external recording device.



To check whether your external recording device is compatible with the [Time code] or [Rec command], consult the manufacturer.

## Drop Frame

If the frame rate setting is **29.97P** (29.97 fps) or **59.94P** (59.94 fps), the time code's frame count causes a discrepancy between the actual time and time code. This discrepancy can be corrected automatically. This correction function is called "drop frame."

**Enable :** The discrepancy is corrected automatically by skipping time code numbers (DF: Drop frame).

**Disable :** The discrepancy is not corrected (NDF: Non-drop frame).

The time code will be displayed as follows:

Enable (DF) : 00:00:00. (Playback time: 00:00:00.00)

Disable (NDF) : 00:00:00: (Playback time: 00:00:00:00)



If the frame rate is **23.98P** (23.98 fps), **24.00P** (24.00 fps), **25.00P** (25.00 fps), or **50.00P** (50.00 fps), drop frame is not used. (If **23.98P** / **24.00P** is set or if [👉 3: Video system] is set to [For PAL], [Drop frame] will not be displayed.)

## MENU Menu Function Settings

### 4

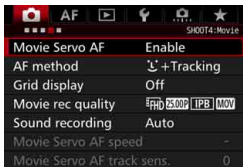

When the Live View shooting/Movie shooting switch is set to <[📷]>, the movie shooting menu options will appear under the [4] and [5] tabs (the [2] [3] tabs in <[A+]>).

#### ● Movie Servo AF

During movie shooting, the camera focuses on the subject continuously. The default setting is **[Enable]**.

#### When **[Enable]** is set:

- The camera focuses on the subject continuously even when you are not pressing the shutter button halfway.
- Since this drives the lens continuously, it will consume battery power and shorten the total possible movie shooting time (p.325).
- With certain lenses, the lens mechanical sound during focusing may be recorded. If this happens, the lens mechanical sound in the movie may be reduced by using the Directional Stereo Microphone DM-E1 (sold separately). Also, using a lens like the EF-S18-135mm f/3.5-5.6 IS USM will reduce lens operation noise.
- If you want to set the lens's focus mode switch to <MF> during Movie Servo AF, first set the Live View shooting/Movie shooting switch to <[📷]>.

ⓘ If **FHD 59.94P** (59.94 fps) or **50.00P** (50.00 fps) is set, Movie Servo AF will not work. Also, since contrast detection is used for AF control, it may take longer to focus.

- If you want to keep the focus at a specific point or you do not want the lens operation noise to be recorded, you can temporarily stop Movie Servo AF as follows. When you stop Movie Servo AF, the AF point will turn gray. When you perform the same steps below, Movie Servo AF will resume.
  - Press the <⚡> button.
  - Under [**3: Custom controls**], if a button is assigned to [**AF stop**], you can pause the Movie Servo AF while holding down that button. When you let go of the button, Movie Servo AF will resume.
- When Movie Servo AF is paused, if you return to movie shooting after pressing the <MENU> or <▶> button, changing the AF method, or performing some other operation, Movie Servo AF will resume automatically.

#### When [Disable] is set:

- Press the shutter button halfway or press the <AF-ON> button to focus.
- **AF method**  
The AF methods are the same as described on pages 299-307. You can select [**L+Tracking**], [**FlexiZone - Multi**], or [**FlexiZone - Single**].



#### Cautions When [Movie Servo AF] is Set to [Enable]

- **Shooting Conditions that Make Focusing Difficult**
  - A fast-moving subject approaching or moving away from the camera.
  - A subject moving at a close distance in front of the camera.
  - Also see “Shooting Conditions that Make Focusing Difficult” on page 306.
- Movie Servo AF will pause during zooming or magnified view.
- During movie shooting, if a subject approaches or moves away or if the camera is moved vertically or horizontally (panning), the recorded movie image may momentarily expand or contract (change in image magnification).

- **Grid display**

With [**3x3** 田] or [**6x4** 田田], you can display grid lines to help you level the camera vertically or horizontally. Also, with [**3x3+diag** 田田], the grid is displayed together with diagonal lines to help you compose with better balance by aligning the intersections over the subject.

Note that the grid is not displayed during movie shooting.

- **Movie recording quality**

You can set the movie recording format (MOV or MP4), movie recording size, and 24.00p. For details, see page 330.

- **Sound recording**

You can set sound-recording settings. For details, see page 336.

## ● Movie Servo AF speed ☆

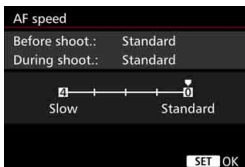

You can set the Movie Servo AF's AF speed and its operation conditions. This function is settable when **[Movie Servo AF]** is set to **[Enable]** and **[AF method]** is set to **[FlexiZone - Single]**. Additionally, the function is only enabled when using a lens compatible with slow focus transition during movie shooting\*.

**When active** : **[Always on]** sets the AF adjustment speed to take effect at all times for movie shooting (before and during movie shooting). **[During shooting]** sets the AF adjustment speed to take effect only during movie shooting.

**AF speed** : You can set the AF adjustment speed (focus transition speed) to one of five levels, from standard speed to slow, to obtain the desired effect.

\* **Lenses supporting slow focus transition during movie shooting**  
USM lenses marketed in 2009 or later and STM lenses (for example, the EF-S18-135mm f/3.5-5.6 IS STM) support slow focus transition during movie shooting. For details, refer to the Canon website.



If **[FHD 59.94P]** (59.94 fps) or **[50.00P]** (50.00 fps) is set, Movie Servo AF will not function and therefore the settings above will not be available.



If **[AF method]** is set to **[L+Tracking]** or **[FlexiZone - Multi]**, the AF adjustment speed will be equivalent to the **[Standard]** setting.

## ● Movie Servo AF tracking sensitivity<sup>☆</sup>



You can change the Movie Servo AF's tracking sensitivity to one of five levels. This affects the responsiveness of AF tracking sensitivity when the AF point loses the subject, such as during panning or when an obstacle enters the AF points.

This function is available when **[Movie Servo AF]** is set to **[Enable]** and **[AF method]** is set to **[FlexiZone - Single]**.

### Locked on: -2 / Locked on: -1

This setting makes the camera less inclined to track a different subject if the AF point loses the original subject. The -2 setting makes the camera less inclined to track a different subject than the -1 setting. It is effective when you want to prevent the AF points from rapidly tracking something that is not the intended subject during panning or when an obstacle enters the AF points.

### Responsive: +2 / Responsive: +1

This makes the camera more responsive when tracking a subject that covers the AF point. The +2 setting makes the AF point more responsive than +1. It is effective when you want to keep tracking a moving subject as its distance from the camera changes, or to rapidly focus on another subject.

⚠ If **[FHD 59.94P]** (59.94 fps) or **[50.00P]** (50.00 fps) is set, Movie Servo AF will not function and therefore the settings above will not be available.

📄 If **[AF method]** is set to **[L+Tracking]** or **[FlexiZone - Multi]**, the tracking sensitivity will be equivalent to the **[0]** setting.



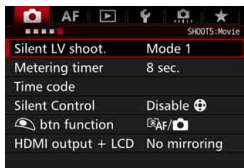

## 5











- **Silent LV shooting** <sup>☆</sup>  
This function applies to still photo shooting. For details, see page 297.
- **Metering timer** <sup>☆</sup>  
You can change how long the exposure setting is displayed (AE lock time).
- **Time code**  
You can set the time code. For details, see pages 339-341.
- **Silent Control**  
When [**Enable** (plus sign icon)] is set, you can use the touch pad < (plus sign icon) > and Quick Control screen to change settings silently during movie shooting. For details, see page 338.

●  **button function**

You can set the functions performed by pressing the shutter button halfway or completely during movie shooting.

Setting	Pressed Halfway	Pressed Completely
	Metering and AF	Still photo shooting
	Metering only	Still photo shooting
	Metering and AF	Starts/stops movie shooting
	Metering only	Starts/stops movie shooting

If [] or [] is set, besides pressing the < > button, you can start/stop the movie shooting by pressing the shutter button completely or by using Remote Switch RS-80N3 or Timer Remote Controller TC-80N3 (both sold separately, p.248). However, with [] or [] set, still photo shooting (p.327) is not possible.

 During movie shooting, the [ **button function**] setting overrides any function assigned to the shutter button with [ **3: Custom Controls**].

● **HDMI output + LCD**

This is for recording an HDMI movie to an external recording device. The default setting is [**No mirroring**].

**[No mirroring]**

- When HDMI output starts, the camera's LCD monitor turns off.
- Shooting information, AF point, and other details are overlaid on the HDMI output movie. However, while viewing an external monitor connected to an external recording device, you can press the <**INFO.**> button to switch to output without any information overlay.
- If you do not connect the HDMI output to an external device and only view the output on the camera's LCD monitor, you cannot make the settings for output without an information overlay even by pressing the <**INFO.**> button.
- When recording a movie without an information overlay, use an external monitor to confirm that the shooting information, AF point, and other details are not displayed (confirm that the movie is output without an information overlay) before recording.



**[Mirroring]**

- The movie is displayed on the LCD monitor and via the HDMI output simultaneously.
- The HDMI output movie does not show the shooting information, AF frame, and other details (output without an information overlay).

If you will leave the camera untouched for more than 30 minutes during HDMI output, select **[No mirroring]** and set [**⚡2: Auto power off**] to **[Disable]** (p.69).



- If the HDMI movie is output without an information overlay, remaining card capacity, remaining battery capacity, internal temperature warning (p.351), and other warnings will not be displayed on the HDMI output device's screen. Be especially careful if **[No mirroring]** is set. If **[Mirroring]** is set, you can check for warnings on the camera's LCD monitor.
- When you are not shooting movies, the power will turn off automatically after the [**⚡2: Auto power off**] time elapses. If **[Mirroring]** is selected and [**⚡2: Auto power off**] is set to **[Disable]**, HDMI output will stop (movie shooting will stop) if you leave the camera untouched for 30 minutes.
- Even when **[Mirroring]** is set, if you play back an image or display a menu, the HDMI movie will not be displayed.
- Avoid still photo shooting (p.327) while recording the HDMI output to an external recording device. Some external recording devices may not synchronize the time code or audio with movie images, or may produce audio interference, resulting in the movie not being recorded correctly as intended.
- Depending on the viewing environment, the brightness of the movie shot with the camera may look different from that of the HDMI output movie recorded to an external recording device.



- By pressing the <INFO.> button, you can change the information displayed.
- A time code can be appended to the HDMI output movie (p.341).
- The HDMI output will also output sound (except when **[Sound recording]** is set to **[Off]**).

### 4 3



#### ● HDMI frame rate

For HDMI output, you can set the frame rate to **[Auto]**, **[59.94i]**/**[50.00i]**, **[59.94p]**/**[50.00p]**, or **[23.98p]**. Set the frame rate that is compatible with the commercially-available external recording device you will use to record the movie via HDMI output.

ⓘ The frame rate cannot be set if **[24.00p]** for **[4: Movie rec quality]** is set to **[Enable]**.

- ⓘ ● The selectable frame rates vary according to the **[4: Video system]** setting. If the movie does not appear on the HDMI output device, set the **[4: Video system]** correctly to **[For NTSC]** or **[For PAL]** (depending on the video standard of your output device).
- If the manually-set frame rate is not compatible with the external recording device, the frame rate will be set automatically.
- If **[4: HDMI frame rate]**'s **[59.94i]** or **[59.94p]** is set together with the movie recording size **[23.98p]** (23.98 fps), the movie will be converted via 2:3 pull down.



## General Movie Shooting Cautions

### White <🔥> and Red <🔥> Internal Temperature Warning Icons

- If the camera's internal temperature increases due to prolonged movie shooting or under a high ambient temperature, a white <🔥> or red <🔥> icon will appear.
- The white <🔥> icon indicates that the image quality of still photos will deteriorate. It is recommended that you stop still photo shooting for a while and allow the camera to cool down. Since movie image quality will hardly be affected, you can still shoot movies.
- The red <🔥> icon indicates that movie shooting will soon be terminated automatically. If this happens, you will not be able to shoot again until the camera's internal temperature decreases. Turn off the power and let the camera rest for a while.
- Shooting a movie at a high temperature for a prolonged period will cause the <🔥> or <🔥> icon to appear earlier. When you are not shooting, turn off the camera.

### Recording and Image Quality

- If the attached lens has an Image Stabilizer and you set the Image Stabilizer (IS) switch to <ON>, the Image Stabilizer will operate at all times even if you do not press the shutter button halfway. The Image Stabilizer consumes battery power and may shorten the total movie shooting time or decrease the number of possible shots. If you use a tripod or if the Image Stabilizer is not necessary, it is recommended that you set the IS switch to <OFF>.
- The camera's built-in microphone will also pick up the operation sound and mechanical sound of the camera during shooting. These sounds in the movie may be reduced by using the Directional Stereo Microphone DM-E1 (sold separately).
- Do not connect anything other than an external microphone to the camera's external microphone IN terminal.
- With autoexposure shooting or shutter-priority AE, if the brightness changes during movie shooting, the movie may freeze temporarily. In such cases, shoot movies with aperture-priority AE or manual exposure.
- If there is a very bright light source in the image, the bright area may appear black on the LCD monitor. The movie will be recorded almost exactly as it appears on the LCD monitor.
- In low light, noise or irregular colors may appear in the image. The movie will be recorded almost exactly as it appears on the LCD monitor.
- If you play back a movie with other devices, image or sound quality may deteriorate or playback may not be possible (even if the devices support MOV/MP4 format).

## General Movie Shooting Cautions

### Recording and Image Quality

- If you use a card with a slow writing speed, a five-level indicator may appear on the right of the screen during movie shooting. It indicates how much data has not yet been written to the card (remaining capacity of the internal buffer memory). The slower the card, the faster the indicator will climb upward. If the indicator becomes full, movie shooting will stop automatically. If the card has a fast writing speed, the indicator will either not appear or the level (if displayed) will hardly go upward. First, shoot a few test movies to see if the card can write fast enough.
- If the indicator indicates that the card is full and movie shooting stops automatically, the sound near the end of the movie may not be recorded properly.
- If the card's writing speed decreases (due to fragmentation) and the indicator appears, formatting the CF card (p.67) or low-level formatting of the SD card (p.67-68) may resolve the problem.

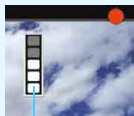

Indicator

### Still Photo Shooting during Movie Shooting

- Regarding the image quality of still photos, see “Image Quality” on page 310.

## Restrictions on MP4-format Movies

Note that generally the following restrictions apply to MP4-format movies.

- Sound will not be recorded on approx. the last two frames.
- When you play back movies on Windows, images and sound may become slightly out of synchronization.

# 10

## Image Playback

This chapter explains how to play back or erase photos and movies, how to display them on a TV screen, and other playback-related functions.

### **Images shot and saved with another device**

The camera may not be able to properly display images captured with a different camera, edited with a computer, or that have had their file names changed.

# ▶ Image Playback

## Single-Image Display



### 1 Play back the image.

- Press the <▶> button.
- ▶ The last image captured or played back will appear.

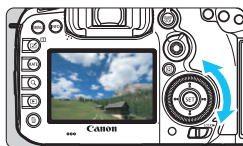

### 2 Select an image.

- To play back images starting with the last image captured, turn the <◀> dial counterclockwise.
- To play back images starting with the first captured image, turn the dial clockwise.
- Each time you press the <INFO.> button, the information display will change.



No information



Basic information display



Shooting information display

### 3 Exit the image playback.

- Press the <▶> button to exit the image playback and return to shooting-ready state.

## Shooting Information Display

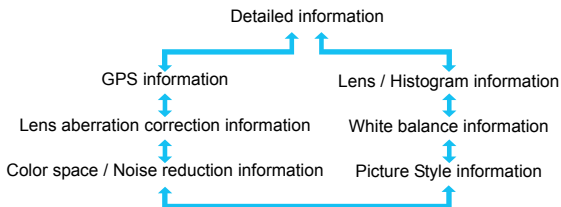

With the shooting information screen displayed (p.354), you can tilt <⬅> up or down to change the shooting information displayed at the screen's bottom as follows. For details, see pages 357-358.

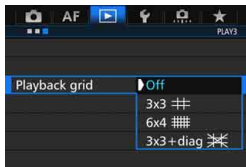

## MENU Grid Display



In single-image display and two-image display (p.366), you can overlay the grid on the image playback.

With [**▶3: Playback grid**], you can select [**3x3** , [**6x4** , or [**3x3+diag** ].

This function is convenient for checking the image's vertical or horizontal tilt, as well as composition.

 The grid is not displayed during movie playback.

# INFO.: Shooting Information Display

## Sample Information for Still Photos

### ● Basic information display

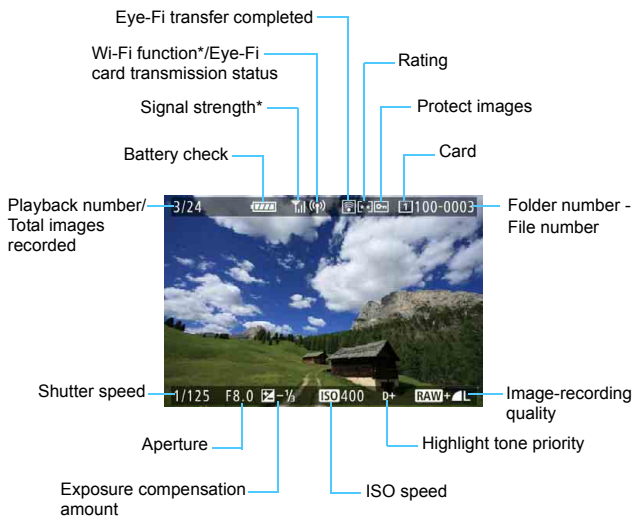

\* Refer to the Wi-Fi Adapter W-E1 Instruction Manual.



- Shooting information display
  - Detailed information

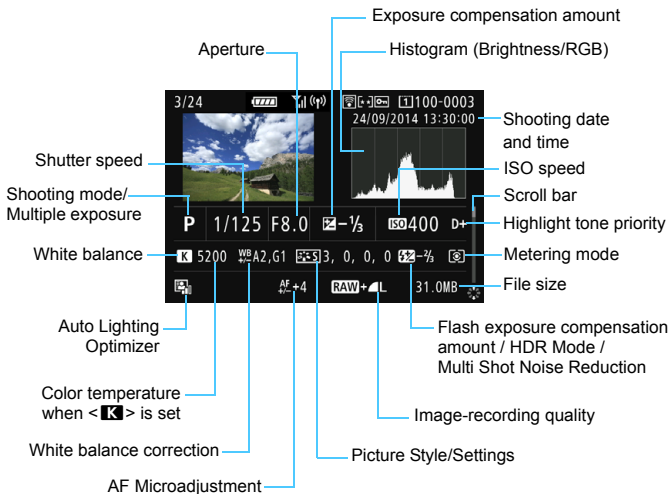

- \* When you shoot in RAW+JPEG image quality, the RAW image file size will be displayed.
- \* During flash photography without flash exposure compensation, <f> will be displayed.
- \* <HDR> and the dynamic range adjustment amount will be displayed for images taken in the HDR mode.
- \* <M> will be displayed for multiple-exposure photos.
- \* <NR> will be displayed for images shot with Multi Shot Noise Reduction.
- \* For still photos taken during movie shooting, <M> will be displayed.
- \* For images developed with the camera's RAW processing function or resized and then saved, <L> will be displayed.

 If the image was taken by another camera, certain shooting information may not be displayed.

• **Lens/Histogram information**

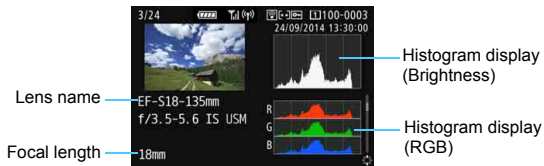

• **White balance information**

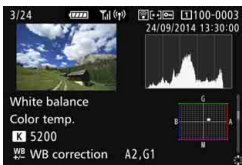

• **Picture Style information**

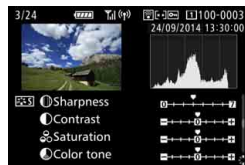

• **Color space / Noise reduction information**



• **Lens aberration correction information**



• **GPS information**

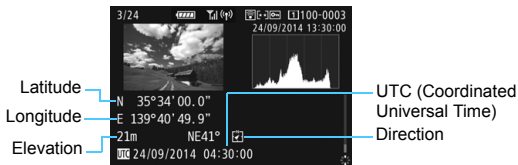

If GPS information was not recorded for the image, the GPS information screen will not be displayed.

## Sample Movie Information Display



- <img alt="M mode icon" data-bbox="125 465 145 485"/> and <img alt="A+ mode icon" data-bbox="125 465 145 485"/> modes: Shutter speed, aperture and ISO speed are not displayed.
- <img alt="Av mode icon" data-bbox="125 505 145 525"/> mode: Aperture and ISO speed are not displayed.
- <img alt="Av mode icon" data-bbox="125 525 145 545"/> mode: Shutter speed and ISO speed are not displayed.
- <img alt="M mode icon" data-bbox="125 545 145 565"/> mode + Auto ISO: ISO speed is not displayed.

### ● Highlight Alert

When [**3: Highlight alert**] is set to [**Enable**], overexposed highlight areas will blink. To obtain more image detail in the overexposed, blinking areas, set the exposure compensation to a negative amount and shoot again.

### ● AF Point Display

When [**3: AF point disp.**] is set to [**Enable**], the AF point that achieved focus will be displayed in red. If automatic AF point selection is set, multiple AF points may be displayed.

## ● Histogram

The brightness histogram shows the exposure level distribution and overall brightness. The RGB histogram is for checking the color saturation and gradation. The display can be switched with [▶] 3: **Histogram disp.**].

### [Brightness] Display

This histogram is a graph showing the distribution of the image's brightness level. The horizontal axis indicates the brightness level (darker on the left and brighter on the right), while the vertical axis indicates how many pixels exist for each brightness level. The more pixels there are toward the left, the darker the image. The more pixels there are toward the right, the brighter the image. If there are too many pixels on the left, the shadow detail will be lost. If there are too many pixels on the right, the highlight detail will be lost. The gradation in-between will be reproduced. By checking the image and its brightness histogram, you can see the exposure level inclination and the overall gradation.

### Sample Histograms



Dark image



Normal brightness



Bright image

### [RGB] Display

This histogram is a graph showing the distribution of each primary color's brightness level in the image (RGB or red, green, and blue). The horizontal axis indicates the color's brightness level (darker on the left and brighter on the right), while the vertical axis indicates how many pixels exist for each color brightness level. The more pixels there are toward the left, the darker and less prominent the color. The more pixels there are toward the right, the brighter and denser the color. If there are too many pixels on the left, the respective color information will be lacking. If there are too many pixels on the right, the color will be too saturated with no gradation. By checking the image's RGB histogram, you can see the color's saturation and gradation condition, as well as white balance inclination.

## ▶ Searching for Images Quickly

### ❑ Display Multiple Images on One Screen (Index Display)

You can search for images quickly with the index display showing 4, 9, 36, or 100 images on one screen.



#### 1 Press the <Q> button.

- During image playback or when the camera is ready to shoot, press the <Q> button.
- ▶ [☀️ Q] will be displayed on the lower right of the screen.



#### 2 Switch to the index display.

- Turn the <☀️> dial counterclockwise.
- ▶ The 4-image index display will appear. The selected image is highlighted with an orange frame.
- Turning the <☀️> dial further counterclockwise will switch the display from 9 images, 36 images and to 100 images. If you turn the dial clockwise, it will rotate through 100, 36, 9, 4, and single-image display.



#### 3 Select an image.



- Turn the <☀️> dial to move the orange frame and select the image.
- Press the <Q> button to turn off the [☀️ Q] icon, then turn the <☀️> dial to go to the next screen or previous image.
- Press <SET> in the index display to display the selected image in the single-image display.

## Jump through Images (Jump Display)

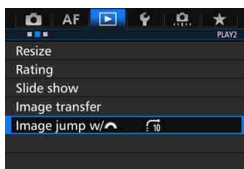
In the single-image display, you can turn the < > dial to jump through the images forward or backward according to the jump method set.



### 1 Select [Image jump w/ ].

- Under the [ 2] tab, select [Image jump w/ , then press < >.

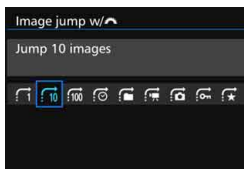

### 2 Select the jump method.

- Select the jump method, then press < >.

: Display images one by one

: Jump 10 images

: Jump 100 images

: Display by date

: Display by folder

: Display movies only

: Display stills only

: Display protected images only

: Display by image rating (p.371)

Turn the < > dial to select.



Jump method

Playback position

### 3 Browse by jumping.

- Press the <▶> button to play back images.
- In the single-image display, turn the <⚙> dial.
- ▶ You can browse by the method that was set.







- To search images by shooting date, select [**Date**].
- To search images by folder, select [**Folder**].
- If the card contains both movies and still photos, select [**Movies**] or [**Stills**] to display one or the other.
- If no images match the [**Protect**] or [**Rating**] setting, you cannot browse through images with the <⚙> dial.

# Q Magnifying Images

You can magnify a captured image by approx. 1.5x to 10x on the LCD monitor.



## 1 Magnify the image.



- The image can be magnified as follows: 1. During image playback (single-image display), 2. During the image review after image capture, and 3. From the shooting-ready state.
- Press the  button.
- ▶ The magnified view will appear. The magnified area and  will be displayed on the lower right of the screen.
- The image magnification increases as you turn the  dial clockwise. You can magnify the image up to 10x.
- The image magnification decreases as you turn the  dial counterclockwise. In the case of 1 and 3 only, turning the dial further will display the index display (p.361).

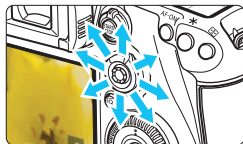

Magnified area position



## 2 Scroll around the image.

- Use  to scroll around the magnified image.
- To exit the magnified view, press the  button or  button and the single-image display will return.



- In the case of 1 and 3 only, you can turn the  dial to view another image while the magnification is maintained.
- A movie cannot be magnified.



## MENU Magnification Settings

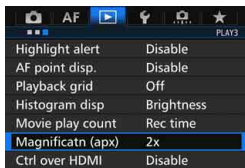

Under the [ ]3 tab, when you select [Magnificatn (apx)], you can set the starting magnification and initial position for the magnified view.

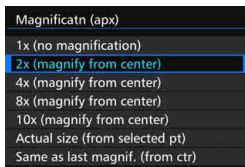

- **1x (no magnification)**  
The image is not magnified. The magnified view will start with the single-image display.
- **2x, 4x, 8x, 10x (magnify from center)**  
The magnified view starts at the image center at the selected magnification.
- **Actual size (from selected point)**  
The recorded image's pixels will be displayed at approx. 100%. The magnified view starts at the AF point that achieved focus. If the photo is taken with manual focus, the magnified view starts at the image center.
- **Same as last magnification (from center)**  
The magnification will be the same as the last time you exited the magnified view with the < ] > or < Q > button. The magnified view starts at the image center.

 For images taken with [ ]+Tracking] or [FlexiZone - Single] (p.299) or with [Distortion] set to [Enable] (p.182), the magnified view will start at the image center even if [Actual size (from selected pt)] is set.

## ☐ Comparing Images (Two-Image Display) ■

You can compare two images side by side on the LCD monitor. In the two-image display, you can use magnified view or jump display as well as protect, rate, and delete images.



### 1 Set the two-image display.

- During image playback, press the <☐> button.
- ▶ The two-image index display will appear. The currently-selected image will be highlighted with an orange frame.



### 2 Select the images to be compared.

- Pressing <SET> switches the orange frame between the two images.
- Turn the <◉> dial to select an image.
- Repeat this procedure to select the other image to be compared.
- If the left and right images are the same, the [☐☐] icon will appear on the upper left of both images.
- By pressing the <Q> button, you can set the same magnification and magnified area for both images. (The magnification settings will match those of the image not highlighted with an orange frame.)
- By holding the <▶> button, you can display the image highlighted with an orange frame as a single image.
- To return to the previous display, press the <☐> button.



- By pressing the <INFO.> button, you can change the information display.
- You cannot play back movies in the two-image display.

## Rotating the Image

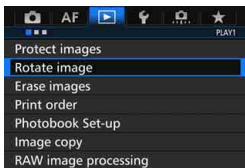
You can rotate the displayed image to the desired orientation.



### 1 Select [Rotate image].

- Under the [ 1] tab, select [Rotate image], then press < >.

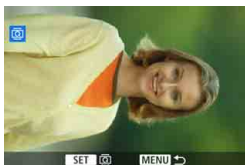

### 2 Select an image.



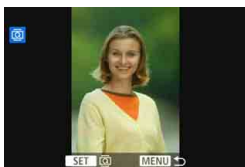



- Turn the < > dial to select the image to be rotated.
- You can also select an image in the index display (p.361).



### 3 Rotate the image.

- Each time you press < >, the image will rotate clockwise as follows: 90° → 270° → 0°.
- To rotate another image, repeat steps 2 and 3.





- If you set [ 1: Auto rotate] to [On  ] (p.395) before taking vertical shots, you need not rotate the image as described above.
- If the rotated image is not displayed in the rotated orientation during image playback, set [ 1: Auto rotate] to [On  ].
- A movie cannot be rotated.

# Protecting Images

Protecting an image prevents it from being erased accidentally.

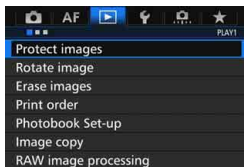
## **MENU** Protecting a Single Image



- 1 Select [Protect images].**
- Under the [ 1] tab, select [**Protect images**], then press < >.

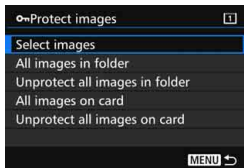





- 2 Select [Select images].**
- ▶ An image will be displayed.

Image protection icon



- 3 Select an image.**
- Turn the < > dial to select the image to be protected.
  - You can also select an image or movie on the index display (p.361).

- 4 Protect the image.**
- Press < > to protect the selected image. The < > icon will appear at the top of the screen.
  - To cancel the image protection, press < > again. The < > icon will disappear.
  - To protect another image, repeat step 3 and 4.

## MENU Protecting All Images in a Folder or on a Card

You can protect all the images in a folder or on a card at once.

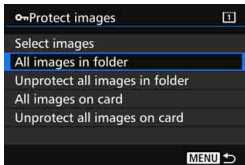

When you select [**All images in folder**] or [**All images on card**] in [**1: Protect images**], all the images in the folder or on the card will be protected. To cancel the image protection, select [**Unprotect all images in folder**] or [**Unprotect all images on card**].

 **If you format the card (p.67), the protected images will also be erased.**



- Movies can also be protected.
- Once an image is protected, it cannot be erased by the camera's erase function. To erase a protected image, you must first cancel the protection.
- If you erase all the images (p.393), only the protected images will remain. This is convenient when you want to erase unnecessary images all at once.
- When [**All images on card**] or [**Unprotect all images on card**] is selected, the images will be protected or unprotected on the card selected for [**Record/play**] or [**Playback**] under [**1: Record func+card/folder sel.**].

## Protecting Images with the <RATE> Button

During image playback, you can use the <RATE> button to protect an image.

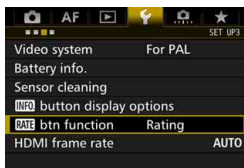

### 1 Select [RATE btn function].

- Under the [F3] tab, select [RATE button function], then press <SET>.



### 2 Select [Protect].



### 3 Select an image.

- Press the <▶> button to play back images.
- Turn the <DISP> dial to select the image to be protected.
- You can also select an image or movie on the index display (p.361).

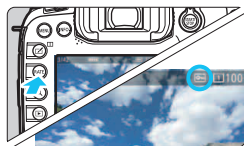

### 4 Protect the image.

- When you press the <RATE> button, the image will be protected and the <L> icon will appear.
- To cancel the image protection, press the <RATE> button again. The <L> icon will disappear.

# Setting Ratings

You can rate images (still photos and movies) with one of the five rating marks: [★]/[★.]/[★.]/[★.]/[★.]. This function is called rating.

## Rating Images with the <RATE> Button



### 1 Select an image.

- During image playback, turn the <◉> dial to select an image or movie to be rated.
- You can also select an image or movie on the index display (p.361).



### 2 Rate the image.

- Each time you press the <RATE> button, the rating mark will change: [★]/[★.]/[★.]/[★.]/[★.]/None.
- To rate another image, repeat steps 1 and 2.

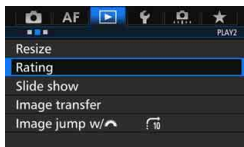

- If [☛3: RATE btn function] is set to [Protect], change it to [Rating].
- If you press the <Q> button when [Rating] is selected in [☛3: RATE btn function], you can set the rating marks that can be selected when you press the <RATE> button.

**MENU** Setting Ratings with the Menu**1** Select [Rating].

- Under the [▶] 2 tab, select [Rating], then press <ⓈET>.

**2** Select an image.

- Turn the <⦿> dial to select an image or movie to be rated.
- If you press the <Q> button and turn the <⦿> dial counterclockwise, you can select an image from a three-image display. To return to the single-image display, turn the <⦿> dial clockwise.

**3** Rate the image.

- Press <ⓈET> and a blue highlight frame will appear as shown in the screenshot.
- Turn the <⦿> dial to select a rating, then press <ⓈET>.
- ▶ The total number of images rated will be counted and displayed for each rating.
- To rate another image, repeat steps 2 and 3.







A total of up to 999 images of a given rating can be displayed. If there are more than 999 images with a given rating, [###] will be displayed.



### Taking Advantage of Ratings

- With [**▶2: Image jump w/** ], you can display only images having the specified rating.
- With [**▶2: Slide show**], you can play back only images with a specific rating.
- With Digital Photo Professional (EOS software, p.534), you can select only the image with a specific rating (still photos only).
- With Windows 8.1, Windows 8, Windows 7, etc., you can see each file's rating as part of the file information display or in the provided image viewer (JPEG images only).

## Quick Control for Playback

During playback, you can press the  $\langle \text{Q} \rangle$  button to set the following: [ $\text{On}$ : **Protect images**], [ $\text{Q}$ : Rotate image], [ $\star$ : **Rating**], [ $\text{RAW/JPEG}$ : RAW image processing] (RAW images only), [ $\text{R}$ : Resize] (JPEG image only), [ $\text{On}$ : **Highlight alert**], [ $\text{On}$ : **AF point display**], and [ $\text{10}$ : **Image jump w/** ].

For movies, **only the functions in bold above can be set.**

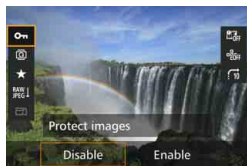

### 1 Press the $\langle \text{Q} \rangle$ button.

- During image playback, press the  $\langle \text{Q} \rangle$  button.
- ▶ The Quick Control options will appear.

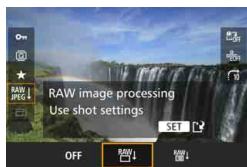







### 2 Select an item and set it.

- Tilt  $\langle \text{Q} \rangle$  up or down to select a function.
- ▶ The setting of the selected function is displayed at the bottom.
- Turn the  $\langle \text{DIAL} \rangle$  to set it.
- For RAW image processing and Resize, press  $\langle \text{SET} \rangle$  and set the function. For details, see page 398 for RAW image processing and page 403 for Resize. To cancel, press the  $\langle \text{MENU} \rangle$  button.

### 3 Exit the setting.

- Press the  $\langle \text{Q} \rangle$  button to exit the Quick Control screen.

 To rotate an image, set [**1: Auto rotate**] to [**On**  ]. If [**1: Auto rotate**] is set to [**On** ] or [**Off**], the [**Rotate image**] setting will be recorded to the image, but the camera will not rotate the image for display.

- 
- Pressing the <> button during the index display will switch to the single-image display and the Quick Control screen will appear. Pressing the <> button again will return to the index display.
  - For images taken with another camera, the options you can select may be restricted.

## Enjoying Movies

You can play back movies in the following three ways:

### Playback on a TV Set (p.385)



By connecting the camera to a TV set with HDMI Cable HTC-100 (sold separately), you can play back the camera's still photos and movies on the TV set.

- Since hard disk recorders do not have an HDMI IN port, the camera cannot be connected to a hard disk recorder with an HDMI cable.
- Even if the camera is connected to a hard disk recorder with a USB cable, movies and still photos cannot be played back or saved.

### Playback on the Camera's LCD Monitor (p.378-379)

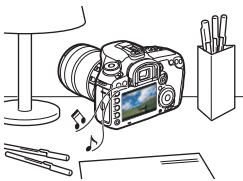

You can play back movies on the camera's LCD monitor. You can also edit out the movie's first and last scenes, and play back the still photos and movies on the card in an automatic slide show.

- A movie edited with a computer cannot be rewritten to the card and played back with the camera.

## Playback and Editing with a Computer (p.534)



The movie files recorded on the card can be transferred to a computer and played back or edited with pre-installed or general-purpose software compatible with the movie's recording format.



If you want to use commercially-available software to play back or edit the movies, be sure it is compatible with MOV or MP4 files. For details on commercially-available software, contact the software manufacturer.

## ▶ **Playing Movies**



### **1** Play back the image.

- Press the <▶> button to display an image.



### **2** Select a movie.

- Turn the <◉> dial to select the movie to be played.
- With the single-image display, the <SET ▶> icon displayed on the upper left indicates a movie.
- In the index display, perforations at the left edge of a thumbnail indicate a movie. **As movies cannot be played from the index display, press <SET> to switch to the single-image display.**



### **3** In the single-image display, press <SET>.

- ▶ The movie playback panel will appear at the bottom of the screen.







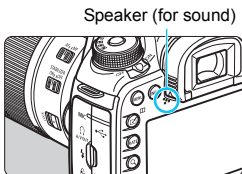





### **4** Play back the movie.

- Select [▶] (Play), then press <SET>.
- ▶ The movie will start playing.
- You can pause the movie playback by pressing <SET>.
- You can adjust the sound volume during movie playback by turning the <◉> dial.
- For more details on the playback procedure, see the next page.



- Before listening to a movie's sound through headphones, turn down the volume to prevent hurting your ears.
- The camera may not be able to play movies shot with another camera.

## Movie Playback Panel

Operation	Playback Description
 <b>Play</b>	Pressing <SET> toggles between play and stop.
 <b>Slow motion</b>	Adjust the slow motion speed by turning the <DIAL> dial. The slow motion speed is indicated on the upper right of the screen.
 <b>First frame</b>	Displays the movie's first frame.
 <b>Previous frame</b>	Each time you press <SET>, the previous frame is displayed. If you hold down <SET>, it will rewind the movie.
 <b>Next frame</b>	Each time you press <SET>, the movie will play frame-by-frame. If you hold down <SET>, it will fast forward the movie.
 <b>Last frame</b>	Displays the movie's last frame.
 <b>Edit</b>	Displays the editing screen (p.380).
	Playback position
<b>mm' ss"</b>	Playback time (minutes:seconds with [Movie play count: Rec time] set)
<b>hh:mm:ss.ff (DF)</b> <b>hh:mm:ss:ff (NDF)</b>	Time code (hours:minutes:seconds:frames with [Movie play count: Time code] set)
 <b>Volume</b>	Turn the <DIAL> dial to adjust the volume of the built-in speaker (p.378) or headphones.
	To return to the single-image display, press the <MENU> button.



- With a fully-charged Battery Pack LP-E6N, the continuous playback time at room temperature (23°C/73°F) will be approx. 3 hr. 20 min.
- By connecting commercially-available headphones equipped with a 3.5 mm diameter stereo mini plug to the camera's headphone terminal (p.23), you can listen to the movie's sound (p.337).
- If you connect the camera to a TV set to play back a movie (p.385), adjust the sound volume with the TV set. (Turning the <DIAL> dial will not change the sound volume.) If there is audio feedback, place the camera farther away from the TV set or turn down the TV sound volume.
- If you took a still photo while you shot the movie, the still photo will be displayed for approx. 1 sec. during the movie playback.

## ✂ Editing a Movie's First and Last Scenes

You can edit out the first and last scenes of a movie in approx. 1-sec. increments.



### 1 On the movie playback screen, select [✂].

- ▶ The movie editing panel will be displayed at the bottom of the screen.



### 2 Specify the part to be edited out.

- Select either [⏪] (Cut beginning) or [⏩] (Cut end), then press <SET>.
- Tilt <◀▶> to the left or right to see the previous or next frames. Holding down the key will fast forward or fast rewind the frames. Turn the <⌚> dial for frame-by-frame playback.
- After deciding which part to edit out, press <SET>. The portion highlighted in white on the top of the screen is what will remain.



### 3 Check the edited movie.

- Select [▶] and press <SET> to play back the edited movie.
- To change the editing, go back to step 2.
- To cancel the editing, press the <MENU> button, then select [OK] on the confirmation screen.

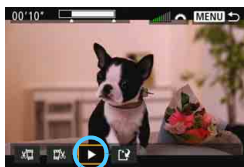



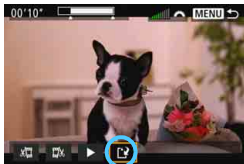

## 4 Save the edited movie.

- Select [**⏏**], then press < **Ⓢ** >.
- ▶ The save screen will appear.
- To save it as a new movie, select [**New file**]. To save it and overwrite the original movie file, select [**Overwrite**], then press < **Ⓢ** >.
- On the confirmation screen, select [**OK**] to save the edited movie and return to the movie playback screen.



- Since the editing is performed in approx. 1-sec. increments (position indicated by [**✂**] on the top of the screen), the actual position where the movie is edited may differ from the position you specified.
- If the card does not have enough free space, [**New file**] will not be available.
- When the battery level is low, movie editing is not possible. Use a fully-charged battery.
- Movies shot with another camera cannot be edited with this camera.

## MENU Slide Show (Auto Playback)

You can play back the images on the card as an automatic slide show.

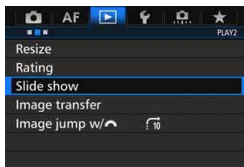

### 1 Select [Slide show].

- Under the [▶] 2 tab, select [Slide show], then press <SET>.

Number of images to be played

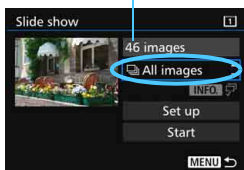

### 2 Select the images to be played.

- Select the desired option on the screen, then press <SET>.

#### All images/Movies/Stills/Protect

- Select one of the following: [All images] [Movies] [Stills] [Protect]. Then press <SET>.

#### Date/Folder/Rating

- Select one of the following: [Date] [Folder] [Rating].
- When <INFO > is highlighted, press the <INFO.> button.
- Select the desired setting, then press <SET>.

#### Date



#### Folder

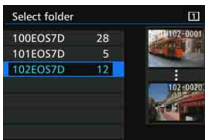

#### Rating

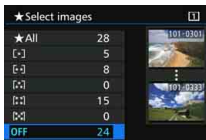

Item	Playback Description
All images	All the still photos and movies on the card will be played back.
Date	Still photos and movies taken on the selected shooting date will be played back.
Folder	Still photos and movies in the selected folder will be played back.
Movies	Only the movies on the card will be played back.
Stills	Only the still photos on the card will be played back.
Protected	Only the protected still photos and movies on the card will be played back.
Rating	Only the still photos and movies with the selected rating will be played back.

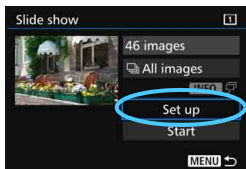

### 3 Configure [Set up] as desired.

- Select [Set up], then press <SET>.
- Set the [Display time] and [Repeat] settings for still photos.
- After completing the settings, press the <MENU> button.

#### Display time

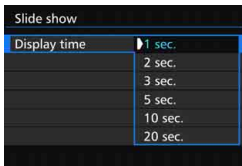

#### Repeat

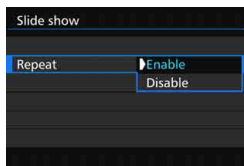

When [All images] is selected, the images on the card selected for [Record/play] or [Playback] under [1: Record func+card/folder sel.] will be played back.

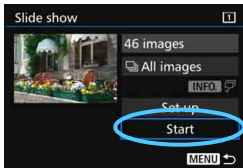

#### 4 Start the slide show.

- Select [**Start**], then press <SET>.
- ▶ After [**Loading image...**] is displayed, the slide show will start.

#### 5 Exit the slide show.

- To exit the slide show and return to the setting screen, press the <MENU> button.

- 
- To pause the slide show, press <SET>. During pause, [||] will be displayed on the upper left of the image. Press <SET> again to resume the slide show.
  - During auto playback, you can press the <INFO.> button to change the still photo display format (p.354).
  - During movie playback, you can adjust the sound volume by turning the <SOUND> dial.
  - During auto playback or pause, you can turn the <DISP> dial to view another image.
  - During auto playback, auto power off will not take effect.
  - The display time may vary depending on the image.
  - To view the slide show on a TV set, see page 385.

## Viewing Images on a TV Set

By connecting the camera to a TV set with an HDMI cable (sold separately), you can play the camera's still photos and movies on the TV set. For the HDMI cable, HDMI Cable HTC-100 (sold separately) is recommended.

If the picture does not appear on the TV screen, set the [**3: Video system**] correctly to [**For NTSC**] or [**For PAL**] (depending on the video standard of your TV set).

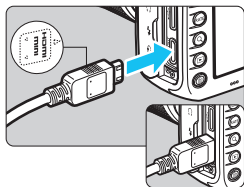

### 1 Connect the HDMI cable to the camera.

- With the plug's <▲HDMI MINI> logo facing the front of the camera, insert it into the <HDMI OUT> terminal.

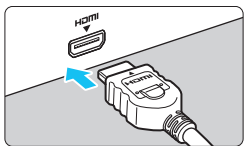

### 2 Connect the HDMI cable to the TV set.

- Connect the HDMI cable to the TV set's HDMI IN port.

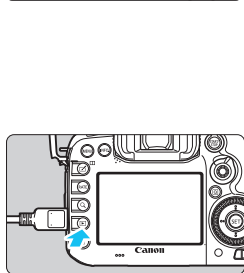

### 3 Turn on the TV set and switch the TV set's video input to select the connected port.

### 4 Set the camera's power switch to <ON>.

### 5 Press the <▶> button.

- ▶ The image will appear on the TV screen. (Nothing will be displayed on the camera's LCD monitor.)
- The images will automatically be displayed at the TV set's optimum resolution.
- By pressing the <INFO.> button, you can change the display format.
- To play back movies, see page 378.

- Adjust movie sound volume with the TV set. The sound volume cannot be adjusted with the camera.
- Before connecting or disconnecting the cable between the camera and TV set, turn off the camera and TV set.
- Depending on the TV set, part of the image displayed may be cut off.
- Do not connect any other device's output to the camera's <HDMI OUT> terminal. Doing so may cause a malfunction.
- Certain TV sets may not be able to display the captured movies.

### Using HDMI CEC TV Sets

If the TV set connected to the camera with an HDMI cable is compatible with HDMI CEC\*, you can use the TV set's remote control for playback operations.

\* An HDMI-standard function enabling HDMI devices to control each other so that you can control them with one remote control unit.

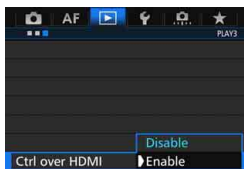

#### 1 Set [Ctrl over HDMI] to [Enable].

- Under the [▶3] tab, select [Ctrl over HDMI], then press <SET>.
- Select [Enable], then press <SET>.

#### 2 Connect the camera to a TV set.

- Use an HDMI cable to connect the camera to the TV set.
- ▶ The TV set's input will switch automatically to the HDMI port connected to the camera. If it does not switch automatically, use the TV set's remote control to select the HDMI IN port the cable is connected to.

### 3 Press the camera's <▶> button.

- ▶ An image will appear on the TV screen and you can use the TV set's remote control to play back images.

### 4 Select an image.

- Point the remote control toward the TV set and press the ←/→ button to select an image.

#### Still photo playback menu



#### Movie playback menu



- : Return
- : 9-image index
- : Play movie
- : Slide show
- INFO.** : Display shooting info
- : Rotate

### 5 Press the remote control's Enter button.

- ▶ The menu appears and you can perform the playback operations shown on the left.
- Press the remote control's ←/→ button to select the desired option, then press the Enter button. For a slide show, press the ↑/↓ button to select an option, then press the Enter button.
- If you select [**Return**] and press the Enter button, the menu will disappear and you can use the ←/→ button to select an image.

During the two-image display (p.366), playback with the TV's remote control is not possible. To use the TV's remote control for playback, first press the <▶> button to return to the single-image display.

- Some TV sets require you to first enable the HDMI CEC connection. For details, refer to the TV set's instruction manual.
- Certain TV sets, even those compatible with HDMI CEC, may not operate properly. In such a case, set [**▶3: Ctrl over HDMI**] to [**Disable**], and use the camera to control the playback operation.

## Copying Images

The images recorded on one card can be copied to another card.

### **MENU** Copying a Single Image

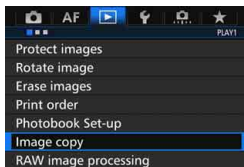

#### 1 Select [Image copy].

- Under the [▶] 1 tab, select [Image copy], then press <SET>.

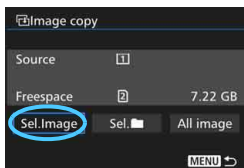

#### 2 Select [Sel. Image].

- Check the copy source and target cards' number, and remaining capacity.
- Select [Sel. Image], then press <SET>.



#### 3 Select the folder.

- Select the folder containing the image you want to copy, then press <SET>.
- Check the images displayed on the right to select the desired folder.
- ▶ The images in the selected folder will be displayed.

 The copy source is the card selected for [Record/play] or [Playback] under [▶1: Record func+card/folder sel.].



Total images selected



## 4 Select the images to be copied.

- Turn the <DISP> dial to select an image to be copied, then press <SET>.
- ▶ The [✓] icon will appear on the upper left of the screen.
- If you press the <Q> button and turn the <DISP> dial counterclockwise, you can select an image from a three-image display. To return to the single-image display, turn the <DISP> dial clockwise.
- To select other images to be copied, repeat step 4.

## 5 Press the <RATE> button.

- After selecting all the images to be copied, press the <RATE> button.

## 6 Select [OK].

- Check the card where the images will be copied to, then select [OK].

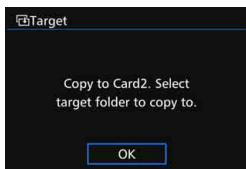

## 7 Select the target folder.

- Select the target folder to which you want to copy the images, then press <SET>.
- To create a new folder, select [Create folder].

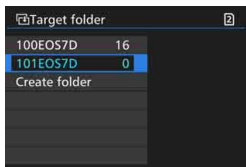

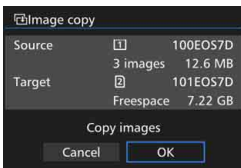

## 8 Select [OK].

- Check the information of the source card and target card, then select [OK].

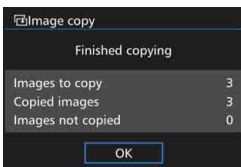

- ▶ The copying will start and the progress will be displayed.
- When the copying is completed, the result will be displayed. Select [OK] to return to the screen in step 2.

## MENU Copying All Images in a Folder or on a Card

You can copy all the images in a folder or on a card at once.

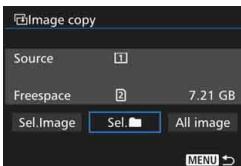

Under [**1: Image copy**], when you select [**Sel. [Folder icon]**] or [**All image**], you can copy all the images in the folder or on a card.



- The file name of the copied image will be the same as the source image's file name.
- If [**Sel.Image**] is set, you cannot copy images in multiple folders at once. Select images in each folder to copy them folder by folder.
- If an image is being copied to a target folder/card which has an image with the same file number, the following will be displayed: [**Skip image and continue**] [**Replace existing image**] [**Cancel copy**]. Select the copying method, then press <SET>.
  - [**Skip image and continue**]: Any images in the source folder having the same file number as images in the target folder will be skipped and not copied.
  - [**Replace existing image**]: Any images in the target folder having the same file number as the source images (including protected images) will be overwritten.

If an image with a print order (p.421) is overwritten, you will have to set the print order again.
- The image's print order information, image transfer information, and photo book order information will not be retained when the image is copied.
- Shooting is not possible during the copying operation. Select [**Cancel**] before shooting.

## Erasing Images

You can either select and erase unnecessary images one by one or erase them in one batch. Protected images (p.368) will not be erased.

- ⚠ **Once an image is erased, it cannot be recovered. Make sure you no longer need the image before erasing it. To prevent important images from being erased accidentally, protect them. Erasing a RAW+JPEG image will erase both the RAW and JPEG images.**

### Erasing a Single Image



1 Play back the image to be erased.



2 Press the  button.

- ▶ The Erase menu will appear.



3 Erase the image.

- Select [Erase], then press . The image displayed will be erased.



 Setting [ 4: Default Erase option] to [[Erase] selected] makes it faster to erase images (p.444).

### **MENU** Checkmarking Images to Be Erased in a Batch

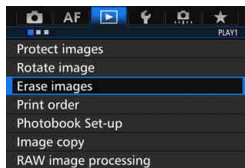
By appending checkmarks  to the images to be erased, you can erase multiple images at once.



1 Select [Erase images].

- Under the [ 1] tab, select [Erase images], then press .

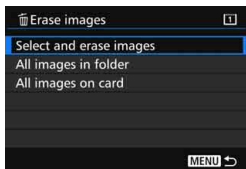

## 2 Select [Select and erase images].

- ▶ An image will be displayed.
- If you press the <Q> button and turn the <☺> dial counterclockwise, you can select an image from a three-image display. To return to the single-image display, turn the <☺> dial clockwise.



## 3 Select the images to be erased.

- Turn the <☺> dial to select the image to be erased, then press <(SET)>.
- ▶ A checkmark [✓] will be displayed on the upper left of the screen.
- To select other images to be erased, repeat step 3.

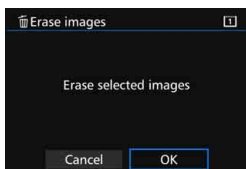

## 4 Erase the image.

- Press the <☒> button, then press [OK].
- ▶ The selected images will be erased in one batch.

### **MENU** Erasing All Images in a Folder or on a Card

You can erase all the images in a folder or on a card at once. When [▶ 1: Erase images] is set to [All images in folder] or [All images on card], all the images in the folder or on the card will be erased.



- To erase all images, including protected images, format the card (p.67).
- When [All images on card] is selected, the images on the card selected for [Record/play] or [Playback] under [▶ 1: Record func+card/folder sel.] will be erased.

# Changing Image Playback Settings

## MENU Adjusting the LCD Monitor Brightness

The LCD monitor's brightness is adjusted automatically for optimum viewing depending on the ambient light level. You can also set the automatic adjustment's brightness level (brighter or darker), or adjust the brightness manually.

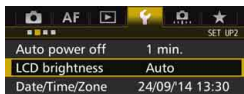

### 1 Select [LCD brightness].

- Under the [**Y**2] tab, select [**LCD brightness**], then press <SET>.

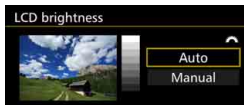

### 2 Select [Auto] or [Manual].

- Turn the <☀> dial to make the selection.

### 3 Adjust the brightness.

- While referring to the gray chart, turn the <☉> dial, then press <SET>.
- You can adjust [**Auto**] to one of three levels, and [**Manual**] to one of seven levels.

#### Automatic adjustment

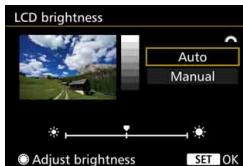

#### Manual adjustment

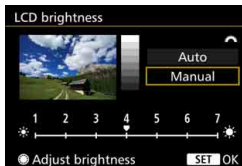

While [**Auto**] is set, be careful not to obstruct the round, ambient light sensor (p.24) on the lower left of the Quick Control Dial with your finger, etc.

- To check the image's exposure, looking at the histogram is recommended (p.360).
- During playback, pressing the <☉> button will display the screen in step 2.

**MENU** Auto Rotation of Vertical Images

Vertical images are rotated automatically so they are displayed vertically on the camera's LCD monitor and on the computer instead of horizontally. You can change the setting for this feature.

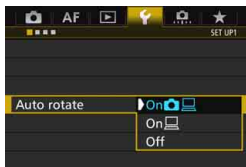
**1** Select [Auto rotate].

- Under the [**1**] tab, select [Auto rotate], then press <SET>.

**2** Set the auto rotation.

- Select the desired setting, then press <SET>.

- On**  

The vertical image is automatically rotated during playback on both the camera's LCD monitor and on the computer.

- On** 

The vertical image is automatically rotated only on the computer.

- Off**

The vertical image is not automatically rotated.



Auto rotation will not work with vertical images captured while auto rotation was [Off]. They will not rotate even if you later switch it to [On] for playback.



- The vertical image will not be automatically rotated for the image review just after shooting.
- If the vertical image is taken while the camera is pointed up or down, the image may not be rotated automatically for playback.
- If the vertical image is not automatically rotated on the computer screen, it means the software you are using is unable to rotate the image. Using the EOS software is recommended.





# 11

## Post-Processing Images

You can process RAW images with the camera or resize (reduce the resolution of) JPEG images.

- A ☆ icon at the upper right of a page title indicates a function that can be used only in these modes: <P> <Tv> <Av> <M> <B>.



- The camera may not be able to process images taken with another camera.
- Post-processing images as described in this chapter cannot be performed while the camera is connected to a computer via an interface cable.

## RAW/JPEG ↓ Processing RAW Images with the Camera ☆

You can process **RAW** images with the camera and save them as JPEG images. As the RAW image itself does not change, you can apply different processing conditions to create any number of JPEG images from it.

Note that **M RAW** and **S RAW** images cannot be processed with the camera. Use Digital Photo Professional (EOS software, p.534) to process those images.

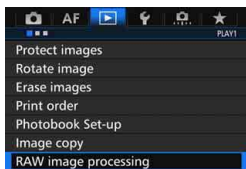

### 1 Select [RAW image processing].

- Under the [▶ 1] tab, select [**RAW image processing**], then press <SET>.
- RAW** images will be displayed.



### 2 Select an image.

- Turn the <◉> dial to select the image you want to process.
- If you press the <Q> button and turn the <☀> dial counterclockwise, you can select an image from the index display.



### 3 Process the image.

- Press <SET> to make the RAW-processing options appear (p.400).
- Use <☀> to select an option, then turn the <◉> dial to set it.
- The displayed image will reflect “Brightness adjustment”, “White balance”, and any other setting adjustments.
- To return to the image settings at the time of shooting, press the <INFO.> button.



## Displaying the setting screen

- Press <SET> to display the setting screen. Turn the <☀> or <☂> dial to change the setting. Press <SET> to finalize the setting and return to the previous screen.



## 4 Save the image.

- Select [] (Save), then press <SET>.
- Select [OK] to save the image.
- Check the destination folder and image file number, then select [OK].
- To process another image, repeat steps 2 to 4.

## Magnified View







You can magnify the image by pressing the <Q> button in step 3. The magnification will differ depending on the pixel count of **[Image quality]** set in **[RAW image processing]**. With <⬇>, you can scroll around the magnified image.

To cancel magnified view, press the <Q> button again.

## Images with Aspect Ratio Setting

Images shot with the aspect ratio (p.404) set to **[4:3]**, **[16:9]**, or **[1:1]** will be displayed with lines indicating the image area. JPEG images generated from RAW images will be saved in the set aspect ratio.

## RAW Image Processing Options

-  **Brightness adjustment**  
You can adjust the image brightness up to  $\pm 1$  stop in 1/3-stop increments. The displayed image will reflect the setting's effect.
-  **White balance** (p.168)  
You can select the white balance. If you select [**K**] and press the <INFO.> button, you can set the color temperature. The displayed image will reflect the setting's effect.
-  **Picture Style** (p.160)  
You can select the Picture Style. By pressing the <INFO.> button, you can adjust the sharpness and other parameters. The displayed image will reflect the setting's effect.
-  **Auto Lighting Optimizer** (p.175)  
You can set the Auto Lighting Optimizer. The displayed image will reflect the setting's effect.
-  **High ISO speed noise reduction** (p.176)  
You can set the noise reduction for high ISO speeds. The displayed image will reflect the setting's effect. If the effect is difficult to discern, magnify the image (p.399).
-  **Image quality** (p.149)  
You can set the image quality when generating an image in JPEG format.

- sRGB **Color space** (p.187)

You can select either sRGB or Adobe RGB. Since the camera's LCD monitor is not compatible with Adobe RGB, the image will not look very different when either color space is set.

- OFF **Peripheral illumination correction** (p.181)

If **[Enable]** is set, the corrected image will be displayed. If the effect is difficult to discern, magnify the image (p.399) and check the four corners. The peripheral illumination correction applied with the camera will be less pronounced than with Digital Photo Professional (EOS software) and may be less apparent. In such a case, use Digital Photo Professional to apply the peripheral illumination correction.

- OFF **Distortion correction** (p.182)

Image distortion due to lens characteristics can be corrected. If **[Enable]** is set, the corrected image will be displayed. The image periphery will be cropped in the corrected image.

Since the image resolution may look slightly lower, use the Picture Style's sharpness parameter to make adjustments as necessary.

- OFF **Chromatic aberration correction** (p.182)

Chromatic aberrations (color fringing along the subject's outline) due to the lens characteristics can be corrected. If **[Enable]** is set, the corrected image will be displayed. If the effect is difficult to discern, magnify the image (p.399).

## Peripheral Illumination Correction, Distortion Correction, and Chromatic Aberration Correction

To execute peripheral illumination correction, distortion correction, and chromatic aberration correction with the camera, the correction data of the lens used must be registered in the camera. If the lens correction data is not registered in the camera, use EOS Utility (EOS software, p.534) to register the lens correction data.

-  Processing RAW images in the camera will not produce the same results as processing RAW images with Digital Photo Professional.
- When processing images with **[Distortion]** set to **[Enable]**, AF point display information (p.359) and Dust Delete Data (p.407) will not be appended to the image.

## Resizing JPEG Images

You can resize a JPEG image to make the pixel count lower and save it as a new image. Resizing an image is possible only with JPEG **L/M/S1/S2** images. **JPEG S3 and RAW images cannot be resized.**

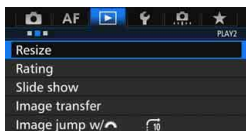

### 1 Select [Resize].

- Under the [**▶2**] tab, select [**Resize**], then press <SET>.
- ▶ An image will be displayed.



### 2 Select an image.

- Turn the <◉> dial to select the image you want to resize.
- If you press the <Q> button and turn the <◉> dial counterclockwise, you can select an image from the index display.



### 3 Select the desired image size.

- Press <SET> to display the image sizes.
- Select the desired image size, then press <SET>.

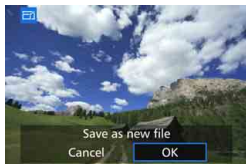

### 4 Save the image.

- Select [**OK**] to save the resized image.
- Check the destination folder and image file number, then select [**OK**].
- To resize another image, repeat steps 2 to 4.

## Resize Options by Original Image Size

Original Image Size	Available Resize Settings			
	M	S1	S2	S3
L	<input type="radio"/>	<input type="radio"/>	<input type="radio"/>	<input type="radio"/>
M		<input type="radio"/>	<input type="radio"/>	<input type="radio"/>
S1			<input type="radio"/>	<input type="radio"/>
S2				<input type="radio"/>

## Image Sizes

Image sizes by aspect ratio are shown in the table below. The image-recording quality figures marked with an asterisk do not exactly match the aspect ratio. The image will be cropped slightly.

Image Quality	Aspect Ratio and Pixel Count (Approx.)			
	3:2	4:3	16:9	1:1
M	3648x2432 (8.9 megapixels)	3248x2432* (7.9 megapixels)	3648x2048* (7.5 megapixels)	2432x2432 (5.9 megapixels)
S1	2736x1824 (5.0 megapixels)	2432x1824 (4.4 megapixels)	2736x1536* (4.2 megapixels)	1824x1824 (3.3 megapixels)
S2	1920x1280 (2.5 megapixels)	1696x1280* (2.2 megapixels)	1920x1080 (2.1 megapixels)	1280x1280 (1.6 megapixels)
S3	720x480 (350,000 pixels)	640x480 (310,000 pixels)	720x408* (290,000 pixels)	480x480 (230,000 pixels)



# 12

## Sensor Cleaning

The camera has a Self Cleaning Sensor Unit to automatically shake off dust adhered to the image sensor's front layer (low pass filter).

The Dust Delete Data can also be appended to the image so that the dust spots remaining can be deleted automatically by Digital Photo Professional (EOS software, p.534).

### **Smudges adhering to the front of the sensor**

Besides dust entering the camera from outside, in rare cases lubricant from the camera's internal parts may adhere to the front of the sensor. If visible spots still remain after the automatic sensor cleaning, having the sensor cleaned by a Canon Service Center is recommended.



Even while the Self Cleaning Sensor Unit is operating, you can press the shutter button halfway to interrupt the cleaning and start shooting immediately.

## Automatic Sensor Cleaning

Whenever you set the power switch to **<ON>** or **<OFF>**, the Self Cleaning Sensor Unit operates to automatically shake off the dust on the front of the sensor. Normally, you need not pay attention to this operation. However, you can choose to perform sensor cleaning manually, or disable it.

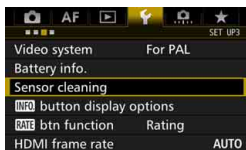

### Cleaning the Sensor Now

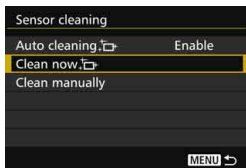

#### 1 Select [Sensor cleaning].

- Under the [**3**] tab, select [**Sensor cleaning**], then press **<SET>**.



- Select [**Clean now **

- For best results, perform the sensor cleaning with the camera placed upright and stable on a table or other flat surface.
- Even if you repeat the sensor cleaning, the result will not improve much. Immediately after the sensor cleaning is finished, the [**Clean now 

### Disabling Automatic Sensor Cleaning**

- In step 2, select [**Auto cleaning 

406**

## MENU Appending Dust Delete Data ☆

Normally, the Self Cleaning Sensor Unit will eliminate most of the dust that may be visible on captured images. However, in case visible dust still remains, you can append the Dust Delete Data to the image for erasing the dust spots later. The Dust Delete Data is used by Digital Photo Professional (EOS software, p.534) to erase the dust spots automatically.

### Preparation

- Prepare a solid white object such as a sheet of paper.
- Set the lens focal length to 50 mm or longer.
- Set the lens's focus mode switch to <MF> and set the focus to infinity ( $\infty$ ). If the lens has no distance scale, rotate the camera to face towards you and turn the focusing ring clockwise all the way.

### Obtaining the Dust Delete Data

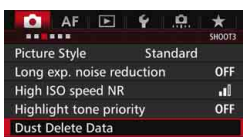

#### 1 Select [Dust Delete Data].

- Under the [CAMERA 3] tab, select [Dust Delete Data], then press <SET>.

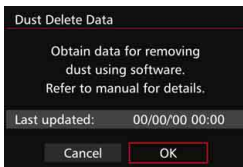

#### 2 Select [OK].

- ▶ After the automatic self-cleaning of the sensor is performed, a message will appear. Although there will be a shutter sound during the cleaning, no picture is taken.

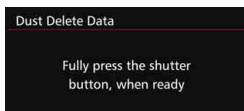
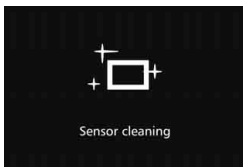



### 3 Shoot a solid-white object.

- At a distance of 20 cm - 30 cm (0.7 ft. - 1.0 ft.), fill the viewfinder with a patternless, solid-white object and take a picture.
- ▶ The picture will be taken in aperture-priority AE mode at an aperture of f/22.
- Since the image will not be saved, the data can still be obtained even if there is no card in the camera.
- ▶ When the picture is taken, the camera will start collecting the Dust Delete Data. When the Dust Delete Data is obtained, a message will appear.
- If the data is not obtained successfully, an error message will appear. Follow the "Preparation" procedure on the preceding page, then select [OK]. Take the picture again.

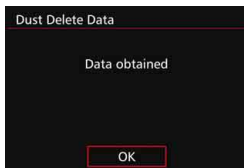

## Dust Delete Data

After the Dust Delete Data is obtained, it is appended to all the JPEG and RAW images captured thereafter. Before an important shoot, it is recommended that you update the Dust Delete Data by obtaining it again.

For details about using Digital Photo Professional (EOS software, p.534) to erase dust spots, refer to the Digital Photo Professional Instruction Manual.

The Dust Delete Data appended to the image is so small that it hardly affects the image file size.

 Be sure to use a solid-white object such as a new sheet of white paper. If the object has any pattern or design, it may be recognized as dust data and affect the accuracy of the dust deletion with the EOS software.

## MENU Manual Sensor Cleaning <sup>☆</sup>

Dust that could not be removed by the automatic sensor cleaning can be removed manually with a commercially-available blower, etc. Before cleaning the sensor, detach the lens from the camera.

**The image sensor is extremely delicate. If the sensor needs to be cleaned directly, having it done by a Canon Service Center is recommended.**

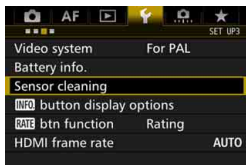

### 1 Select [Sensor cleaning].

- Under the [**3**] tab, select [**Sensor cleaning**], then press <SET>.



### 2 Select [Clean manually].



### 3 Select [OK].

- ▶ In a moment, the reflex mirror will lock up and the shutter will open.
- “CLn” will blink on the LCD panel.

### 4 Clean the sensor.

### 5 End the cleaning.

- Set the power switch to <OFF>.



- If you use a battery, make sure it is fully charged.
- If you use Battery Grip BG-E16 (sold separately) with size AA/LR6 batteries, manual sensor cleaning will not be possible.



For the power source, using the DC Coupler DR-E6 (sold separately) and AC Adapter AC-E6N (sold separately) is recommended.

- 
- **While cleaning the sensor, never do any of the following. If the power is cut off, the shutter will close and the shutter curtains and image sensor may get damaged.**
    - **Setting the power switch to <OFF>.**
    - **Removing or inserting the battery.**
  - The surface of the image sensor is extremely delicate. Clean the sensor with care.
  - Use a plain blower without any brush attached. A brush can scratch the sensor.
  - Do not insert the blower tip inside the camera beyond the lens mount. If the power is turned off, the shutter will close and the shutter curtains or reflex mirror may get damaged.
  - Never use pressurized air or gas to clean the sensor. The blowing force can damage the sensor, or the spray gas can freeze on the sensor and scratch it.
  - If the battery level becomes low while you clean the sensor, the beeper will sound as a warning. Stop cleaning the sensor.
  - If a smudge that cannot be removed with a blower remains, having the sensor cleaned by a Canon Service Center is recommended.

# 13

## Printing Images and Transferring Images to a Computer

- **Printing** (p.414)  
You can connect the camera directly to a printer and print out the images on the card. The camera is compliant with “PictBridge”, which is the standard for direct printing.
- **Digital Print Order Format (DPOF)** (p.421)  
DPOF (Digital Print Order Format) enables you to print images recorded on the card according to your printing instructions such as the image selection, quantity to print, etc. You can print multiple images in one batch or give the print order to a photofinisher.
- **Transferring Images to a Computer** (p.425)  
You can connect the camera to a computer and operate the camera to transfer images recorded on the card to the computer.
- **Specifying Images for a Photobook** (p.429)  
You can specify images on the card for printing in a photobook.

## Preparing to Print

The direct printing procedure can be performed entirely with the camera while you look at the camera's LCD monitor.

### Connecting the Camera to a Printer

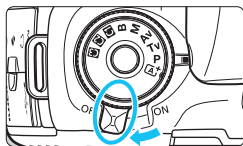

**1** Set the camera's power switch to **<OFF>**.

**2** Set up the printer.

- For details, refer to the printer's instruction manual.

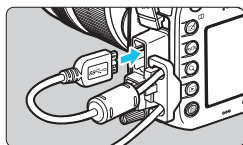

**3** Connect the camera to a printer.

- Use the interface cable provided with the camera.
- When connecting the cable to the camera, use the cable protector (p.34). Connect the cable to the digital terminal with the plug's **<SS<img alt="SS icon" data-bbox="495 505 515 525"/>>>** icon facing the back of the camera.
- To connect to the printer, refer to the printer's instruction manual.

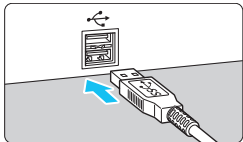

**4** Turn on the printer.

**5** Set the camera's power switch to **<ON>**.

- ▶ Some printers may make a beeping sound.

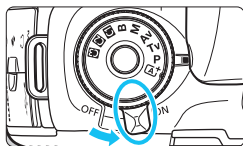





## 6 Play back the image.

- Press the <▶> button.
- ▶ The image will appear with the <🖨️> icon on the upper left of the screen to indicate that the camera is connected to a printer.



- Make sure the printer has a PictBridge connection port.
- Use the provided interface cable or one from Canon (p.478). When connecting the interface cable, use the provided cable protector (p.34).
- Movies cannot be printed.
- The camera cannot be used with printers conforming only to CP Direct or Bubble Jet Direct.
- If there is a long beeping sound in step 5, it indicates a problem with the printer. Resolve the problem displayed in the error message (p.420).
- Printing is not possible if Multi Shot Noise Reduction or the HDR Mode is set.



- You can also print RAW images taken with this camera.
- If you use a battery to power the camera, make sure it is fully charged. With a fully-charged battery, printing up to approx. 3 hr. is possible.
- Before disconnecting the cable, first turn off the camera and printer. Hold the plug (not the cord) to pull out the cable.
- For direct printing, using the DC Coupler DR-E6 (sold separately) and AC Adapter AC-E6N (sold separately) to power the camera is recommended.

# ☞ Printing

The screen display and setting options will differ depending on the printer. Some settings may not be available. For details, refer to the printer's instruction manual.

Printer-connected icon



## 1 Select the image to be printed.

- Check that the <☞> icon is displayed on the upper left of the LCD monitor.
- Turn the <⊙> dial to select the image to be printed.

## 2 Press <⊙(SET)>.

- ▶ The print setting screen will appear.

### Print setting screen

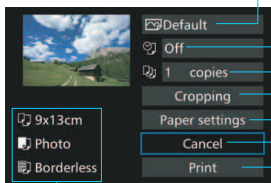

Sets printing effects (p.416).

Sets date or file number imprinting to on or off (p.417).

Sets quantity to be printed (p.417).

Sets print area (p.419).

Sets paper size, type, and layout (p.415).

Returns to the screen in step 1.

Starts printing.

The paper size, type, and layout you set are displayed.

\* Depending on the printer, certain settings such as the date and file number imprinting and cropping may not be selectable.

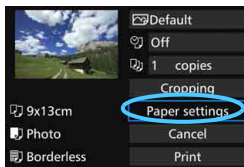

## 3 Select [Paper settings].

- ▶ The paper settings screen will appear.

## Setting the Paper Size

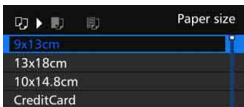

- Select the size of the paper loaded in the printer, then press **<SET>**.
- ▶ The paper type screen will appear.

## Setting the Paper Type

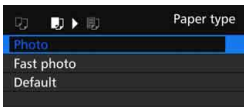

- Select the type of the paper loaded in the printer, then press **<SET>**.
- ▶ The page layout screen will appear.

## Setting the Page Layout

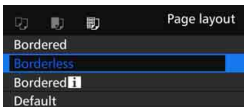

- Select the page layout, then press **<SET>**.
- ▶ The print setting screen will reappear.

<b>Bordered</b>	The print will have white borders along the edges.
<b>Borderless</b>	The print will have no borders. If your printer cannot print borderless prints, the print will have borders.
<b>Bordered [i]</b>	The shooting information* <sup>1</sup> will be imprinted on the border on 9x13 cm or larger prints.
<b>xx-up</b>	Option to print 2, 4, 8, 9, 16, or 20 images on one sheet.
<b>20-up [i]</b> <b>35-up [i]</b>	20 or 35 images will be printed as thumbnails on A4 or Letter size paper* <sup>2</sup> . • [20-up [i]] will have the shooting information* <sup>1</sup> imprinted.
<b>Default</b>	The page layout will vary depending on the printer model or its settings.

\*1: From the Exif data, the camera name, lens name, shooting mode, shutter speed, aperture, exposure compensation amount, ISO speed, white balance, etc., will be imprinted.

\*2: After ordering the prints with "Digital Print Order Format (DPOF)" (p.421), printing by following "Direct Printing of Print-Ordered Images" (p.424) is recommended.

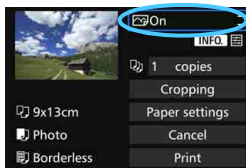

## 4 Set the printing effects.

- Set them if necessary. If you do not need to set any printing effects, go to step 5.
- **Contents displayed on the screen differ depending on the printer.**
- Select the setting, then press <SET>.
- Select the desired printing effect, then press <SET>.
- If the <INFO [INFO] > icons are displayed brightly, you can also adjust the printing effects (p.418).

Printing Effect	Description
On	The image will be printed using the printer's standard colors. The image's Exif data is used to make automatic corrections.
Off	No automatic correction will be applied.
VIVID	The image will be printed with higher saturation to produce more vivid blues and greens.
NR	Image noise is reduced before printing.
<b>B/W B/W</b>	Prints in black-and-white with true blacks.
<b>B/W Cool tone</b>	Prints in black-and-white with cool, bluish blacks.
<b>B/W Warm tone</b>	Prints in black-and-white with warm, yellowish blacks.
Natural	Prints the image in the actual colors and contrast. No automatic color adjustments are applied.
Natural M	Printing characteristics are the same as the "Natural" setting. However, this setting enables finer printing adjustments than with "Natural."
Default	Printing will differ depending on the printer. For details, refer to the printer's instruction manual.

\* When you change the printing effects, changes are reflected in the image displayed on the upper left of the screen. Note that the printed image may look slightly different from the displayed image, which is only an approximation. This also applies to [Brightness] and [Adjust levels] on page 418.

When making a large print of a RAW or RAW+JPEG image, printing a JPEG image created by processing a RAW image (p.398), or printing via Digital Photo Professional (EOS software, p.534) is recommended.

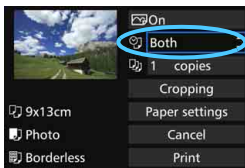

## 5 Set the date and file number imprinting.

- Set them if necessary.
- Select <📅>, then press <ⓈET>.
- Set the print settings as desired, then press <ⓈET>.



## 6 Set the number of copies.

- Set it if necessary.
- Select <📄>, then press <ⓈET>.
- Select the number of copies, then press <ⓈET>.

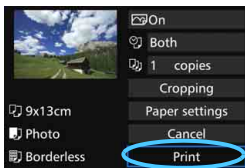

## 7 Start printing.

- Select [Print], then press <ⓈET>.



- The **[Default]** setting for printing effects and other options are the printer's own default settings as set by the printer's manufacturer. Refer to the printer's instruction manual to find out what the **[Default]** settings are.
- Depending on the image's file size and image-recording quality, it may take some time for the printing to start after you select **[Print]**.
- If image tilt correction (p.419) is applied, it may take longer to print the image.
- To stop the printing, press <ⓈET> while **[Stop]** is displayed, then select **[OK]**.
- If you execute **[F4: Clear all camera settings]** (p.70), all the settings will revert to their defaults.

## Adjusting Printing Effects

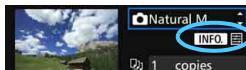

In step 4 on page 416, select the printing effect. When the <INFO> icons are displayed brightly, you can press the <INFO.> button. You can then adjust the printing effects. What can be adjusted or what is displayed will depend on the selection made in step 4.

- **Brightness**

The image brightness can be adjusted.

- **Adjust levels**

When you select [Manual], you can change the histogram's distribution and adjust the image's brightness and contrast. With the Adjust levels screen displayed, press the <INFO.> button to change the position of the <I>. Turn the <DIAL> dial to freely adjust the shadow level (0 - 127) or highlight level (128 - 255).



- **Brightener**

Effective in backlit conditions where the subject's face looks dark. When [On] is set, the face will be brightened for printing.

- **Red-eye corr.**

Effective in flash images where the subject has red eye. When [On] is set, the red eye will be corrected for printing.

- The [Brightener] and [Red-eye corr.] effects will not be reflected on the screen.
- When [Detail set.] is selected, you can adjust the [Contrast], [Saturation], [Color tone], and [Color balance]. To adjust the [Color balance], use <C>. B is for blue, A for amber, M for magenta, and G for green. The image's color balance will be corrected towards the selected color.
- If you select [Clear all], all the printing effect settings will be reverted to their defaults.

## Cropping the Image

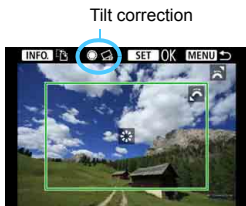

You can crop the image and print only an enlarged version of the cropped portion, as if the image is recomposed.

**Set the cropping right before printing.** If you change the print settings after setting the cropping, you may have to set the cropping again before printing.

**1 On the print setting screen, select [Cropping].**

**2 Set the cropping frame size, position, and aspect ratio.**

- The image area within the cropping frame will be printed. The cropping frame's aspect ratio can be changed with **[Paper settings]**.

### Changing the Cropping Frame Size

Turn the dial to change the cropping frame size. The smaller the cropping frame, the larger the image magnification will be for printing.

### Moving the Cropping Frame

Use to move the frame over the image vertically or horizontally. Move the cropping frame until it covers the desired image area.

### Switching the Orientations of the Cropping Frame

Pressing the **<INFO.>** button will toggle the cropping frame between the vertical and horizontal orientations. This enables you to create a vertically oriented print from a horizontal image.

### Image Tilt Correction

By turning the dial, you can tilt the image between -10 and +10 degrees in 0.5-degree increments. When you adjust the image tilt, the icon on the screen will turn blue.

**3 Press **<SET>** to exit the cropping.**

- ▶ The print setting screen will reappear.
- You can check the cropped image area on the upper left of the print setting screen.

- 
- If the image's aspect ratio is different from the printing paper's aspect ratio, the image may be cropped significantly when you print it as a borderless print. If the image is cropped, the print may look grainier due to the fewer number of pixels.
  - If you imprint shooting information on an image shot at an expanded ISO speed (H1 or H2), the correct ISO speed may not be imprinted.
  - Depending on the printer, the cropped image area may not be printed as you specified.
  - The smaller you make the cropping frame, the grainier the picture will look in the print.
  - Check the camera's LCD monitor while cropping the image. If you look at the image on a TV screen, the cropping frame may not be displayed accurately.



## Handling Printer Errors

If printing does not resume after you resolve a printer error (no ink, no paper, etc.) and select [**Continue**], operate the buttons on the printer to resume printing. For details on resuming the printing, refer to the printer's instruction manual.

### Error Messages

If a problem occurs during printing, an error message will appear on the camera's LCD monitor. Press <  > to stop printing. After fixing the problem, resume printing. For details on how to fix a printing problem, refer to the printer's instruction manual.

#### Paper Error

Check whether the paper is properly loaded in the printer.

#### Ink Error

Check the printer's ink level and the waste ink tank.

#### Hardware Error

Check for any printer problems other than paper and ink problems.

#### File Error

The selected image cannot be printed via PictBridge. Images taken with a different camera or images edited with a computer may not be printable.



# Digital Print Order Format (DPOF)

You can set the print type, date imprinting, and file number imprinting. The print settings will be applied to all print-ordered images. (They cannot be set individually for each image.)

## Setting the Printing Options

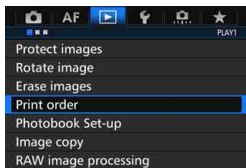

### 1 Select [Print order].

- Under the [▶ 1] tab, select [Print order], then press <SET>.

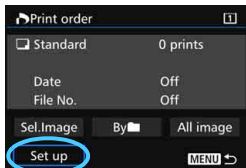

### 2 Select [Set up].

### 3 Set the options as desired.

- Set the [Print type], [Date], and [File No.].
- Select the option to be set, then press <SET>. Select the desired setting, then press <SET>.

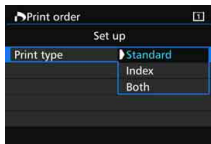



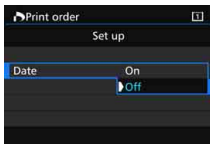

Print type

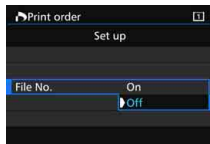

Date



File No.

Print type		Standard	Prints one image on one sheet.
		Index	Multiple thumbnail images are printed on one sheet.
	 	Both	Prints both the standard and index prints.
Date	On	[On] imprints the recorded date on the print.	
	Off		
File number	On	[On] imprints the file number on the print.	
	Off		

## 4 Exit the setting.

- Press the <MENU> button.
- ▶ The print order screen will reappear.
- Next, select [**Sel. Image**], [**By** ], or [**All image**] to order the images to be printed.

- RAW images and movies cannot be print ordered. You can print RAW images with PictBridge (p.411).
- Even if [**Date**] and [**File No.**] are set to [**On**], the date or file number may not be imprinted, depending on the print type setting and printer model.
- With [**Index**] prints, the [**Date**] and [**File No.**] cannot both be set to [**On**] at the same time.
- When printing with DPOF, use the card whose print order specifications are set. It will not work if you just extract images from the card and try to print them.
- Certain DPOF-compatible printers and photofinishers may not be able to print the images as you specified. Refer to the printer's instruction manual before printing, or check with your photofinisher about compatibility when ordering prints.
- Do not specify a new print order for a card containing images whose print order was set by a different camera. The print order may be overwritten. Also, the print order may not be possible, depending on the image type.

## Print Ordering

### Sel.Image

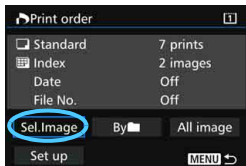

Quantity

Total images selected



Checkmark

Index icon

Select and order images one by one. If you press the <Q> button and turn the <☀> dial counterclockwise, you can select an image from a three-image display. To return to the single-image display, turn the <☀> dial clockwise. Press the <MENU> button to save the print order to the card.

#### Standard / Both

Press <SET>, and a print order for one copy of the displayed image will be placed. By turning the <☀> dial, you can set the number of copies to be printed up to 99.

#### Index

Press <SET> to add a checkmark to the box [✓]. The image will be included in the index print.

### By [Folder Icon]

Select [**Mark all in folder**] and select the folder. A print order for one copy of all the images in the folder will be placed. If you select [**Clear all in folder**] and select the folder, the print order for all the images in the folder will be canceled.

### All image

If you select [**Mark all on card**], one copy of all the images on the card will be set for printing. If you select [**Clear all on card**], the print order will be cleared for all the images on the card.



- Note that RAW images and movies will not be included in the print order even if you set [**By [Folder Icon]**] or [**All image**].
- When using a PictBridge printer, print no more than 400 images for one print order. If you specify more than this, all the images may not be printed.

## Direct Printing of Print-Ordered Images

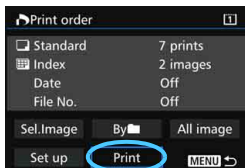

With a PictBridge printer, you can easily print images with DPOF.

### 1 Prepare to print.

- See page 412.

Follow the “Connecting the Camera to a Printer” procedure up to step 5.

### 2 Under the [▶ 1] tab, select [Print order].

### 3 Select [Print].

- [Print] will be displayed only if the camera is connected to a printer and printing is possible.

### 4 Set the [Paper settings] (p.414).

- Set the printing effects (p.416) if necessary.

### 5 Select [OK].

- Before printing, be sure to set the paper size.
- Certain printers cannot imprint the file number.
- If [Bordered] is set, certain printers may imprint the date on the border.
- Depending on the printer, the date may appear faint if it is imprinted on a bright background or on the border.
- Under [Adjust levels], [Manual] cannot be selected.

- If you stopped the printing and want to resume printing the remaining images, select [Resume]. Note that printing will not resume if any of the following are the case:
  - You changed the print order or deleted any of the print ordered images before resuming the printing.
  - When index is set, you changed the paper setting before resuming the printing.
  - The card's remaining capacity was low when you paused the printing.
- If a problem occurs during printing, see page 420.

## Transferring Images to a Computer

You can connect the camera to a computer and operate the camera to transfer images on the card to the computer. This is called direct image transfer.

**The direct image transfer can be performed with the camera while you look at the LCD monitor.**

The images transferred to the computer will be saved in the [Pictures] or [My Pictures] folder and organized in folders by shooting date.

 **Before connecting the camera to a computer, install the EOS Utility (p.534) on your computer.**

### Preparing Image Transfer

**1** Set the camera's power switch to <OFF>.

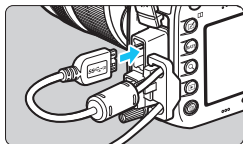

**2** Connect the camera to a computer.

- Use the interface cable provided with the camera.
- When connecting the cable to the camera, use the cable protector (p.34). Connect the cable to the digital terminal with the plug's <SS<img alt="SS icon" data-bbox="535 635 555 655"/> <img alt="SS icon" data-bbox="565 635 585 655"/>> icon facing the back of the camera.
- Connect the cord's plug to the computer's USB terminal.

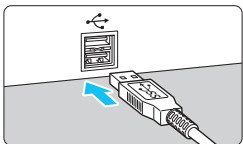

 Use the provided interface cable or one from Canon (p.478). When connecting the interface cable, use the provided cable protector (p.34).

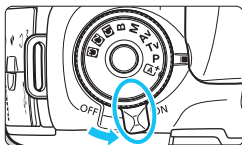

### 3 Set the camera's power switch to <ON>.

- When the computer displays a screen to select the program, select [**EOS Utility**].
- ▶ The EOS Utility screen will appear on the computer.

⚠ **After the EOS Utility screen appears, do not operate EOS Utility.** If any screen other than EOS Utility's main window is displayed, [**Direct transfer**] in step 5 on page 428 will not be displayed. (The image transfer function will not be available.)

- If the EOS Utility screen does not appear, refer to the EOS Utility Instruction Manual.
- Before disconnecting the cable, turn off the camera. Hold the plug (not the cord) to pull out the cable.

## **MENU** Transferring RAW+JPEG Images

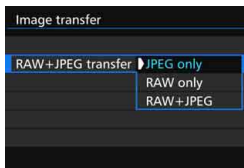

For RAW+JPEG images, you can specify which image to transfer.

On the next page in step 2, select [**RAW+JPEG transfer**], and select the image to be transferred: [**JPEG only**], [**RAW only**], or [**RAW+JPEG**].

## MENU Selecting the Images to be Transferred

### ● Sel.Image

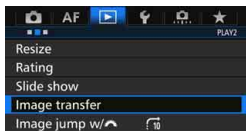

#### 1 Select [Image transfer].

- Under the [▶2] tab, select [Image transfer], then press <SET>.

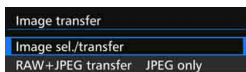

#### 2 Select [Image sel./transfer].

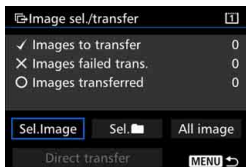

#### 3 Select [Sel.Image].

#### 4 Select the images to be transferred.

- Turn the <⦿> dial to select the image to be transferred, then press <SET>.
- Turn the <⦿> dial to display the [✓] on the screen's upper left, then press <SET>.
- If you press the <Q> button and turn the <☀> dial counterclockwise, you can select an image from a three-image display. To return to the single-image display, turn the <☀> dial clockwise.
- To select other images to be transferred, repeat step 4.



- When [Sel.Image] is selected, you can check the image's transfer status on the upper left of the screen: No mark: Not selected. ✓: Selected for transfer. ✗: Transfer failed. ○: Transfer succeeded.
- The procedures for [RAW+JPEG transfer] (p.426) and above steps 1 to 4 can also be performed while the camera is not connected to a computer.



## 5 Transfer the image.

- On the computer screen, check that EOS Utility's main window is displayed.
  - Select [**Direct transfer**], then press <SET>.
  - On the confirmation screen, select [**OK**], and the images will be transferred to the computer.
  - Images selected with [**Sel. [Folder]**] and [**All image**] can also be transferred in this way.
- **Sel. [Folder]**  
 Select [**Sel. [Folder]**] and select [**Folder images not transfer'd**]. When you select a folder, all the images in that folder not yet transferred to the computer will be selected.  
 Selecting [**Folder images failed transf.**] will select the selected folder's images that failed to transfer.  
 Selecting [**Clear folder transf. history**] will clear the transfer history of the images in the selected folder. After clearing the transfer history, you can select [**Folder images not transfer'd**] and again transfer all the images in the folder.
  - **All image**  
 If [**All image**] is selected and you select [**Card images not transferred**], all the images on the card not yet transferred to a computer will be selected.  
 For a description of [**Card images failed transfer**] and [**Clear card's transf. history**], see "**Sel. [Folder]**" above.

- If any screen other than EOS Utility's main window is displayed on the computer, [**Direct transfer**] is not displayed.
- During the image transfer, certain menu options cannot be used.

- You can also transfer movies.
- Shooting is possible during the image transfer.





## Specifying Images for a Photobook

You can specify up to 998 images to be printed in a photobook. When you use EOS Utility (EOS software) to transfer images to a computer, the specified images will be copied to a dedicated folder. This function is useful for ordering photobooks online.

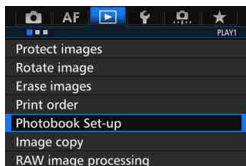
### Specifying One Image at a Time



#### 1 Select [Photobook Set-up].



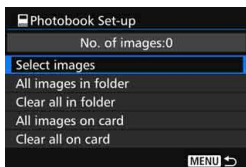

- Under the [ 1] tab, select [Photobook set-up], then press < >.



#### 2 Select [Select images].



#### 3 Select the image to be specified.

- Turn the < > dial to select the image to be specified, then press < >.
- If you press the <Q> button and turn the < > dial counterclockwise, you can select an image from a three-image display. To return to the single-image display, turn the < > dial clockwise.
- To select other images to be transferred, repeat step 3. The number of specified images will be displayed.

## Specifying All Images in a Folder or on a Card

You can specify all the images in a folder or on a card at once.

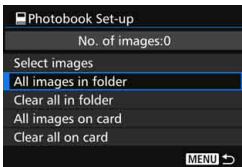

When [**▶ 1: Photobook Set-up**] is set to [**All images in folder**] or [**All images on card**], all the images in the folder or on the card will be specified.

To cancel the image protection, select [**Clear all in folder**] or [**Clear all on card**].

- ⓘ RAW images and movies cannot be specified.
- Do not specify images already specified for a photobook in another camera for another photobook with this camera. The photobook settings may be overwritten.

# 14

## Customizing the Camera

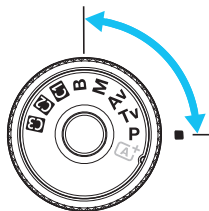

You can customize various camera functions to suit your picture-taking preferences with Custom Functions. Also, current camera settings can be saved under <C1> <C2> <C3> positions of the Mode Dial.

The features explained in this chapter can be set and used in the following shooting modes: <P> <Tv> <Av> <M> <B>.



# MENU Custom Functions ☆

## 🔍 1: Exposure



		 LV Shooting	 Movie Shooting
Exposure level increments	p.434	<input type="radio"/>	<input type="radio"/>
ISO speed setting increments		<input type="radio"/>	In <b>M</b>
Bracketing auto cancel		<input type="radio"/>	(Still photo, with WB bracketing)
Bracketing sequence	<input type="radio"/>		
Number of bracketed shots	p.435	<input type="radio"/>	
Safety shift	p.436	<input type="radio"/>	
Same exposure for new aperture	p.437	<input type="radio"/>	

## 🔍 2: Exposure/Drive

Set shutter speed range	p.438	<input type="radio"/>	<input type="radio"/>
Set aperture range		<input type="radio"/>	<input type="radio"/>
Continuous shooting speed	p.439	<input type="radio"/>	(Still photo)

 The shaded Custom Functions do not function during Live View (LV) shooting or movie shooting. (Settings are disabled.)

**[Fn] 3: Display/Operation**

		 LV Shooting	 Movie Shooting
Focusing screen	p.440		
Warnings  in viewfinder	p.441		
LV shooting area display		○	
Dial direction during Tv/Av	p.442	○	○
Multi function lock		○	○
Custom Controls		Depends on setting	

**[Fn] 4: Others**

Add cropping information	p.443	○	
Default Erase option	p.444	(During playback)	
Retract lens on power off		○	○

**[Fn] 5: Clear**

Selecting [**[Fn] 5: Clear all Custom Func. (C.Fn)**] will clear all the Custom Function settings.

 Even if [**[Fn] 5: Clear all Custom Func.(C.Fn)**] is executed, the settings for [**[Fn] 3: Focusing screen**] and [**[Fn] 3: Custom Controls**] will remain unchanged.

## MENU Setting Custom Functions ☆

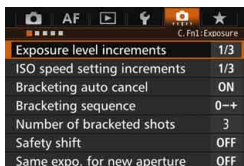

Exposure level increments	1/3
ISO speed setting increments	1/3
Bracketing auto cancel	ON
Bracketing sequence	0→+
Number of bracketed shots	3
Safety shift	OFF
Same expo. for new aperture	OFF

Under the [**...**] tab, you can customize various camera features to suit your picture-taking preferences. Any settings different from the default will be displayed in blue.

### C.Fn1: Exposure

#### Exposure level increments

##### 1/3: 1/3-stop

##### 1/2: 1/2-stop

Sets 1/2-stop increments for the shutter speed, aperture, exposure compensation, AEB, flash exposure compensation, etc. This is effective when you prefer to control the exposure in less fine increments than 1/3-stop.

When [**1/2-stop**] is set, the exposure level will be displayed as shown below.



#### ISO speed setting increments

##### 1/3: 1/3-stop

##### 1/1: 1-stop

Even when [**1-stop**] is set, you can set ISO 16000.

#### Bracketing auto cancel

##### ON: Enable

When you set the power switch to <**OFF**>, the AEB and white balance bracketing settings will be canceled. AEB will also be canceled when the flash is ready to fire or if you switch to movie shooting.

##### OFF: Disable

The AEB and white balance bracketing settings will not be canceled even if you set the power switch to <**OFF**>. (If the flash is ready to fire or if you switch to movie shooting, AEB will be canceled temporarily, but the AEB range will be retained.)

## Bracketing sequence

The AEB shooting sequence and white balance bracketing sequence can be changed.

**0-+:** 0, -, +

**-0+:** -, 0, +

**+0-:** +, 0, -

AEB	White Balance Bracketing	
	B/A Direction	M/G Direction
0 : Standard exposure	0 : Standard white balance	0 : Standard white balance
- : Decreased exposure	- : Blue bias	- : Magenta bias
+ : Increased exposure	+ : Amber bias	+ : Green bias

## Number of bracketed shots

The number of shots taken with AEB and white balance bracketing can be changed from the default, 3 shots, to 2, 5, or 7 shots.

When [**Bracketing sequence: 0, -, +**] is set, the bracketed shots will be taken as shown in the table below.

**3: 3 shots**

**2: 2 shots**

**5: 5 shots**

**7: 7 shots**

(1-stop increments)

	1st Shot	2nd Shot	3rd Shot	4th Shot	5th Shot	6th Shot	7th Shot
3: 3 shots	Standard (0)	-1	+1				
2: 2 shots	Standard (0)	±1					
5: 5 shots	Standard (0)	-2	-1	+1	+2		
7: 7 shots	Standard (0)	-3	-2	-1	+1	+2	+3



If [**2 shots**] is set, you can select the + or - side when setting the AEB range. Setting WB bracketing will result in a decreased exposure in the B/A or M/G direction.

## Safety shift

### OFF: Disable

#### Tv/Av: Shutter speed/Aperture

This takes effect in the shutter-priority AE (**Tv**) and aperture-priority AE (**Av**) modes. If the subject brightness changes and the standard exposure cannot be obtained within the autoexposure range, the camera will automatically change the manually-selected setting to obtain a standard exposure.

#### ISO: ISO speed

This works in the Program AE (**P**), shutter-priority AE (**Tv**), and aperture-priority AE (**Av**) modes. If the subject brightness changes and the standard exposure cannot be obtained within the autoexposure range, the camera will automatically change the manually set ISO speed to obtain a standard exposure.



- Under [**2: ISO speed settings**], even if [**ISO speed range**] or [**Min. shutter spd.**] is changed from the default setting, safety shift will override it if a standard exposure cannot be obtained.
- The minimum and maximum ISO speeds of the safety shift using the ISO speed will be determined by the [**Auto ISO range**] setting (p.158). However, if the manually set ISO speed exceeds the [**Auto ISO range**], the safety shift will take effect up or down to the manually set ISO speed.
- Safety shift will take effect if necessary even when flash is used.



## Same exposure for new aperture

If the **<M>** mode (manual exposure shooting) is set and the ISO speed is set manually (other than Auto ISO), the maximum aperture's f/number may change to a higher number (smaller aperture) if you do any of the following: 1. Change the lens, 2. Attach or detach an Extender, or 3. Use a zoom lens whose maximum aperture f/number changes. If you then shoot at the exposure setting as is, the image will be underexposed by the amount the maximum aperture f/number changes to a higher number. However, by changing the ISO speed or shutter speed (Tv) automatically, you can obtain the same exposure that would be obtained before you did 1, 2, or 3.

### OFF: Disable

Automatic changes in settings to maintain the specified exposure will not be applied. The ISO speed, shutter speed, and aperture already set will be used for shooting. If you do 1, 2, or 3 and the maximum aperture f/number increases, adjust the ISO speed and shutter speed before you shoot.

### ISO: ISO speed

If you do 1, 2, or 3, the ISO speed will automatically increase to compensate for the amount that the maximum aperture f/number increases by. The same exposure that would be obtained before you did 1, 2, or 3 is thereby obtained.

### Tv: Shutter speed

If you do 1, 2, or 3, a slower shutter speed will automatically be set to compensate for the amount that the maximum aperture f/number increases by. The same exposure that would be obtained before you did 1, 2, or 3 is thereby obtained.



- This function does not work with macro lenses whose actual aperture f/number changes when the magnification changes.
- This function does not work with movies.
- If **[ISO speed]** is set and the exposure cannot be maintained within the range set with **[ISO speed range]**, the ISO speed will be automatically switched within the specified range.
- If **[Shutter speed]** is set and the exposure cannot be maintained within the range set with **[2: Set shutter speed range]**, the shutter speed will be automatically switched within the specified range.
- If you do 1, 2, or 3 and the camera turns off (power switch is set to **<OFF>**, etc.) while the exposure is being maintained, the target exposure will be updated to the exposure at the moment the camera turns off.



- This function also works with changes in the highest f/number (minimum aperture).
- If you set **[ISO speed]** or **[Shutter speed]**, do 1, 2, or 3, and then undo 1, 2, or 3 without manually changing the ISO speed, shutter speed, or aperture, so that the camera is back to its original state, the original exposure setting will be restored.
- If **[ISO speed]** is set and the ISO speed increases to an expanded ISO speed, the shutter speed may change to maintain the exposure.

## C.Fn2: Exposure/Drive

### Set shutter speed range

You can set the shutter speed range. In the **<Tv> <M>** modes, you can set the shutter speed manually within the shutter speed range that you have set. In the **<P> <Av>** modes, the shutter speed will be set automatically within the shutter speed range that you have set.

#### Highest speed

You can set it from 1/8000 sec. to 15 sec.

#### Lowest speed

You can set it from 30 sec. to 1/4000 sec.

### Set aperture range

You can set the aperture range. In the **<Av> <M> <B>** modes, you can set the aperture manually within the aperture range that you have set. In the **<P> <Tv>** modes, the aperture will be set automatically within the aperture range that you have set.

#### Min. aperture (Max. f/)

You can set it from f/91 to f/1.4.

#### Max. aperture (Min. f/)

You can set it from f/1.0 to f/64.



The settable aperture range will differ depending on the lens's maximum and minimum apertures.

## Continuous shooting speed

You can set the continuous shooting speed for <[H]> high-speed continuous shooting, <[L]> low-speed continuous shooting, and <[S]> silent continuous shooting.

### High speed

You can set it from 2 to 10 frames per second (fps).

### Low speed

You can set it from 1 to 9 frames per second (fps).

### Silent continuous shooting

You can set it from 1 to 4 frames per second (fps).



If [4: Anti-flicker shoot.] (p.185) is set to [Enable] or EOS iTR AF (p.128) is set to [Enable], the camera may not be able to shoot at the continuous shooting speed that was set.

## C.Fn3: Display/Operation

### Focusing Screen

To suit your shooting needs, you can change to an optional focusing screen, sold separately.

**If you change the focusing screen, be sure to change this setting to match the focusing screen type. It is to obtain the correct exposure.**

**Std.:**  **Eh-A**

Standard screen provided with the camera. Precision Matte standard focusing screen.

**Eh-S:**  **Eh-S**

Super Precision Matte focusing screen makes it easier to distinguish the focus point than with the standard Precision Matte Eh-A focusing screen. It is ideal for fast lenses having a maximum aperture of f/2.8 or larger. Geared for manual focusing.



However, if the lens maximum aperture is smaller than f/2.8, the viewfinder will look darker than with the Eh-A focusing screen.



- The focusing screen setting will not be cleared even if you select [ **5: Clear all Custom Func. (C.Fn)**].
- To change the focusing screen, refer to the focusing screen's instruction manual. If the focusing screen does not come down with the holder, tilt the camera forward.

## Warnings in viewfinder

When any of the following functions are set, the  icon can be displayed in the viewfinder and on the LCD panel (p.26-27).

Select the function for which you want the warning icon to appear, and press  to append a . Then select [OK] to register the setting.

### When monochrome is set

If the Picture Style is set to [Monochrome] (p.162), the warning icon will appear.

### When WB is corrected

If white balance correction (p.172) is set, the warning icon will appear.

### When one-touch image quality is set

If you change the image-recording quality with the one-touch image quality function (p.456), the warning icon will appear.



### When is set

If [ 3: High ISO speed NR] is set to [Multi Shot Noise Reduction] (p.176), the warning icon will appear.

### When spot metering is set

If the metering mode is set to [Spot metering] (p.225), the warning icon will appear.



When you set any of the checkmarked  functions,  will also appear for the respective setting (except when Multi Shot Noise Reduction is set) on the shooting settings screen (p.60, 469).

## LV shooting area display

When the aspect ratio for Live View shooting (p.295) is set to [4:3], [16:9], or [1:1], you can set the display method for the shooting area.

 : Masked





 : Outlined

## Dial direction during Tv/Av





 : **Normal**

 : **Reverse direction**

Dial turning direction when setting the shutter speed and aperture can be reversed.

In the <M> shooting mode, the turning direction of the < > and < > dials will be reversed. In other shooting modes, the turning direction of only the < > dial will be reversed. The < > dial's turning direction in the <M> mode and the turning direction to set the exposure compensation in the <P>, <Tv>, and <Av> mode will be the same.

## Multi function lock

When the <LOCK▶> switch is set to the right, it can prevent the < >, < >, < >, and < > from accidentally changing a setting.



Select the camera control you want to lock, then press <SET> to append a checkmark [✓]. Select [OK] to register the setting.

 **Main Dial**

 **Quick Control Dial**

 **Multi-controller**

 **AF area selection lever**

- If the <LOCK▶> switch is set and you try to use one of the locked camera controls, <L> will be displayed in the viewfinder and on the LCD panel. Also, [LOCK] will be displayed in the shooting settings display (p.60).
- If you lock, the < > dial will be locked by default.
- Even if the < > dial is appended with a [✓] checkmark, you can still use the touch pad < >.

## Custom Controls

You can assign often-used functions to camera buttons or dials according to your preferences. For details, see page 445.

## C.Fn4: Others

### Add cropping information

If you set cropping information, vertical lines for the aspect ratio you have set will appear on the Live View image. You can then compose the shot as if you were shooting with a medium- or large-format camera (6x6 cm, 4x5 inch, etc.).

When you take a picture, the aspect ratio information for cropping the image with the EOS software will be appended to the image. (The image is recorded to the card without being cropped.)

After the image is transferred to a computer, you can use Digital Photo Professional (EOS software, p.534) to easily crop the image to the aspect ratio that was set.

**OFF : Off**

**6:6 : Aspect ratio 6:6**

**3:4 : Aspect ratio 3:4**

**4:5 : Aspect ratio 4:5**

**6:7 : Aspect ratio 6:7**

**5:6 : Aspect ratio 10:12**

**5:7 : Aspect ratio 5:7**



- If [**5: Aspect ratio**] is set to any setting other than [**3:2**], the cropping information will not be appended to the image.
- Cropping information will also be appended for viewfinder shooting. However, the cropping information will not be displayed.
- If cropping information is added to a RAW image, the image cannot be cropped with the camera's RAW image processing.

## Default Erase option

During image playback and image review after image capture, when you press the <  > button, the erase menu appears (p.392). You can set which option, [**Cancel**] or [**Erase**], is to be preselected on this screen.

If [**Erase**] is set, you can just press <  > to quickly erase the image.

 : [**Cancel**] selected

 : [**Erase**] selected



If [**Erase**] is set, be careful not to erase an image accidentally.

## Retract lens on power off

This is to set the lens retraction mechanism for when a gear-driven STM lens (such as EF40mm f/2.8 STM) is attached to the camera. You can set it to retract the extended lens automatically when the camera's power switch is set to < **OFF** >.

**ON: Enable**

**OFF: Disable**



- With auto power off, the lens will not retract regardless of the setting.
- Before detaching the lens, make sure that it is retracted.



When [**Enable**] is set, this function takes effect regardless of the lens's focus mode switch setting (AF or MF).



## 3: Custom Controls ☆

You can assign often-used functions to camera buttons or dials according to your preferences.

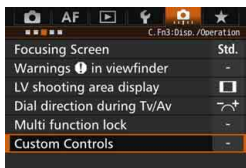

### 1 Select [3: Custom Controls].

- Under the [3] tab, select [Custom Controls], then press <SET>.
- ▶ The Custom Controls screen to select control buttons and dials will appear.



### 2 Select a camera button or dial.

- Select a camera button or dial, then press <SET>.
- ▶ The name of the camera control and the assignable functions will be displayed.

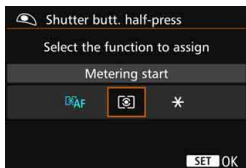

### 3 Assign a function.

- Select a function, then press <SET>.
- If the [INFO.] icon appears on the bottom left, you can press the <INFO.> button and set other related options.

















### 4 Exit the setting.





- When you press <SET> to exit the setting, the screen in step 2 will reappear.
- Press the <MENU> button to exit.



















With the screen in step 2 displayed, you can press the <MENU> button to revert the Custom Control settings to their defaults. Note that the [3: Custom Controls] settings will not be canceled even if you select [5: Clear all Custom Func. (C.Fn)].





## Assignable Functions to Camera Controls

Function		Page		AF-ON	☆
AF	 AF	Metering and AF start	450	○	○*1 ○*1
	AF-OFF	AF stop	452		○ ○
	AF↔	Switch to registered AF function			
	<small>ONE SHOT AI SERVO</small> ONE SHOT ↔ AI SERVO	ONE SHOT ↔ AI SERVO			○ ○
	 HP	Switch to registered AF point	453		
	 SEL  HP	Selected AF point ↔ Center/ Registered AF point			
		AF point direct selection			
		Direct AF point selection: Vertical			
	Direct AF area selection				
Exposure		Metering start	454	○	
	☆	AE lock			○ ○
	☆	AE lock (while button pressed)		○	
	☆H	AE lock (hold)			○ ○
	*AF-OFF	AE lock, AF stop			○ ○
	FEL	FE lock			○ ○
	ISO↓	Set ISO speed (hold button, turn  )	455		
	ISO↺	ISO (hold down lever, turn  )			
	ISO☉	Set ISO speed (  during meter)			
	 ↓	Exposure compensation (hold button, turn  )			
	 ↺	Exposure compensation (hold down lever, turn  )			
Tv	Shutter speed setting in M mode				
Av	Aperture setting in M mode	456			

	LENS*	M-Fn	SET				
	<input type="radio"/>						
<input type="radio"/>	<input type="radio"/>						
<input type="radio"/> *2	<input type="radio"/> *2						
<input type="radio"/>	<input type="radio"/>						
<input type="radio"/> *3	<input type="radio"/> *3						
							<input type="radio"/> *4
					<input type="radio"/>	<input type="radio"/> *5	
					<input type="radio"/>		
							<input type="radio"/>
<input type="radio"/>	<input type="radio"/>	<input type="radio"/>					<input type="radio"/>
<input type="radio"/>	<input type="radio"/>	<input type="radio"/>					<input type="radio"/>
<input type="radio"/>		<input type="radio"/>					
			<input type="radio"/>				
			<input type="radio"/>				
							<input type="radio"/>
				<input type="radio"/>	<input type="radio"/>		
				<input type="radio"/>	<input type="radio"/>		

\* The AF stop button (**LENS**) is provided only on super telephoto IS lenses.

Function		Page		AF-ON	
Images	 RAW JPEG	One-touch image quality setting	456		
	 RAW JPEG H	One-touch image quality (hold)			
		Image quality			
		Picture Style	457		
Operation		Depth-of-field preview	457		
		IS start			
	MENU	Menu display			
		Register/recall shooting function			○*7
		Image Playback	458		
		Magnify/Reduce (press SET, turn  )			
		Cycle:  • ISO/Drive • AF/WB • 			
	UNLOCK 	Unlock while button pressed			
		Flash function settings			
	OFF	No function (disabled)			○

	LENS <sup>*</sup>	M-Fn	SET				
<input type="radio"/> *G		<input type="radio"/> *G					
<input type="radio"/> *G		<input type="radio"/> *G					
			<input type="radio"/>				
			<input type="radio"/>				
<input type="radio"/>							
<input type="radio"/>	<input type="radio"/>						
			<input type="radio"/>				
			<input type="radio"/>				
			<input type="radio"/>				
		<input type="radio"/>					
<input type="radio"/>							
			<input type="radio"/>				
<input type="radio"/>			<input type="radio"/>	<input type="radio"/>	<input type="radio"/>	<input type="radio"/>	<input type="radio"/>

<sup>\*</sup> The AF stop button (**LENS**) is provided only on super telephoto IS lenses.

## AF: Metering and AF start

When you press the button assigned to this function, metering and AF are executed.

\*1: When assigned to the <AF-ON> or <★> button, pressing the <INFO.> button while the setting screen is displayed will enable you to set the detailed AF settings. When shooting, pressing the <AF-ON> or <★> button will execute AF as it was set.

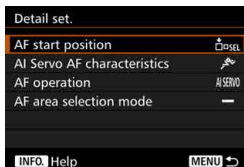

### ● AF start position

When [Registered AF point] is set, you can press the <AF-ON> or <★> button to switch to the registered AF point.

### Registering the AF Point

1. Set the AF area selection mode to one of the following: Single-point Spot AF (manual selection), Single-point AF (manual selection), AF point expansion (manual selection  $\square \square \square$ ), AF point expansion (manual selection, surrounding points), or 65-point automatic selection AF. Zone AF (manual selection of zone) and Large Zone AF (manual selection of zone) cannot be selected.
2. Select an AF point manually.
3. Hold down the <☐> button and press the <☒> button. A beep will sound and the AF point will be registered. If the AF area selection mode is set to any setting other than 65-point automatic selection AF, the registered AF point will blink.



- When the AF point is registered, the following will be displayed:
  - 65-point automatic selection AF: [ ] HP (HP: Home Position)
  - Spot AF, 1 pt AF, Expand AF Area: **SEL [ ]** (Center), **SEL HP** (Off center)
- When registered with **SEL [ ]** or **SEL HP**, the registered AF point will blink.
- To cancel the registered AF point, hold down the <☐> button and press the <☒-ISO> button. The registered AF point will also be canceled if you select [**4: Clear all camera settings**].

- **AI Servo AF characteristics** (p.108)  
Press the <AF-ON> or <✳> button to perform AF with the set case from [Case1] to [Case6].
- **AF operation** (p.86)  
Press the <AF-ON> or <✳> button to perform AF with the set AF operation.
- **AF area selection mode** (p.90)  
Press the <AF-ON> or <✳> button to perform AF with the set AF area selection mode.

If you want to keep using currently selected AF point when you press the <AF-ON> or <✳> button, set [AF start position] to [Manually selected AF point]. If you want to keep the currently set AI Servo AF characteristics, AF operation, and AF area selection mode, select [Maintain current setting].



- If [AF4: Orientation linked AF point] is set to [Separate AF pts: Area+pt] or [Separate AF pts: Pt only], you can register the AF points to be used separately for vertical (grip up or down) and horizontal shooting.
- If [AF start position: Registered AF point] and [AF area selection mode] are both set, [Registered AF point] will take effect.

### AF-OFF: AF stop

The AF will stop while you hold down the button assigned to this function. Convenient when you want to stop the AF during AI Servo AF.

### AF-: Switch to registered AF function

After setting and assigning this function to a button, you can apply the following settings by holding down the assigned button for AF: AF area selection mode (p.90), Tracking sensitivity (p.113), Acceleration/ deceleration tracking (p.114), AF point auto switching (p.115), Servo 1st image priority (p.117), and Servo 2nd image priority (p.118). Convenient when you want to change the AF characteristics during AI Servo AF.

\*2: On the setting screen, press the <INFO.> button to display the detailed settings screen. Turn the <☉> or <☺> dial to select the parameter to be registered, then press <SET> to append a checkmark [✓]. When you select a parameter and press <SET>, you can adjust the parameter. By pressing the <☰> button, you can revert the settings to their defaults.

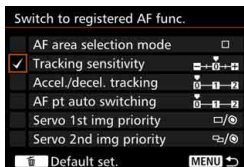

### ONESHOT AI SERVO: ONE SHOT ↔ AI SERVO

You can switch the AF operation. In One-Shot AF mode, when you hold down the button to which this function is assigned, the camera switches to AI Servo AF mode. In the AI Servo AF mode, the camera switches to One-Shot AF mode only while you hold down the button. Convenient when you need to keep switching between One-Shot AF and AI Servo AF for a subject that keeps moving and stopping.

### ☐ HP: Switch to registered AF point

During metering, when you press the button assigned to this function, the camera will switch to the registered AF point.

\*3: On the setting screen, when you press the <INFO.> button, you can select [**Switch only when btn is held**] or [**Switch each time btn is pressed**]. To register the AF point, see page 450.







** : Selected AF point ↔ Center/Registered AF point**

During metering, tilting < > to the right will switch between the current AF point and the center AF point or registered AF point.



\*4: On the setting screen, when you press the <INFO.> button, you can select [**Switch to center AF point**] or [**Switch to registered AF point**]. To register the AF point, see page 450.

** : Direct AF point selection**



During metering, you can select an AF point directly with the < > dial or < > without pressing the < > button. With the < > dial, you can select a left or right AF point. (Looping sequence for Zone AF and Large Zone AF.)





\*5: On the Multi-controller setting screen, when you press the <INFO.> button, you can press the center of < > to select [**Switch to center AF point**] or [**Switch to registered AF point**]. To register the AF point, see page 450.

** : Direct AF point selection: Vertical**

During metering, you can turn the < > dial to directly select an upper or lower AF point without pressing the < > button. (Looping sequence for Zone AF and Large Zone AF.)

** : Direct AF area selection**

During metering, you can use < > to directly select an AF area selection mode without pressing the < > button.

 If you change the aperture in <M> mode when [**Direct AF point selection**], [**Direct AF pt select: Vertical**], or [**Set ISO speed** ( during metering)] (p.455) is assigned to < >, turn the < > dial while holding down the < > button.

### : Metering start

When you press the shutter button halfway, only the exposure metering is performed.

### : AE lock

When you press the button assigned to this function, you can lock the exposure (AE lock) during metering. Convenient when you want to focus and meter the shot at different areas or when you want to take multiple shots at the same exposure setting.

### : AE lock (while button pressed)

The exposure will be locked (AE lock) while you press the shutter button.

### <sub>H</sub>: AE lock (hold)

When you press the button assigned to this function, you can lock the exposure (AE lock). The AE lock will be maintained until you press the button again. Convenient when you want to focus and meter the shot at different areas or when you want to take multiple shots at the same exposure setting.



### <sub>AF-OFF</sub>: AE lock, AF stop



When you press the button assigned to this function, you can lock the exposure (AE lock) and the AF will stop. Convenient during AI Servo AF if you want AE lock at the same time when AF stops.

### : FE lock

During flash photography, pressing the button assigned to this function will fire a preflash and record the required flash output (FE lock).



 If you assign [**AE lock (while button pressed)**] to the shutter button, any buttons assigned to [**AE lock**] or [**AE lock (hold)**] will also work as [**AE lock (while button pressed)**].



**ISO : Set ISO speed (hold button, turn )**



You can set the ISO speed by holding down < > and turning the < > dial.



If this control is used while Auto ISO is set, manual ISO speed setting will take effect. Auto ISO cannot be set. If you use this function in the <**M**> mode, you can adjust the exposure with the ISO speed while maintaining the current shutter speed and aperture.



**ISO : ISO (hold down lever, turn )**

You can set the ISO speed by tilting < > to the right and turning the < > dial. The settable range is the same as with ISO .



**ISO : Set ISO speed ( during metering)**

During metering, you can set the ISO speed by turning the < > dial. The settable range is the same as with ISO .



** : Exposure compensation (hold button, turn )**

You can set the exposure compensation by holding down < > and turning the < > dial. Convenient when you want to set exposure compensation while <**M**> manual exposure and Auto ISO are set.

** : Exposure compensation (hold down lever, turn )**

You can set exposure compensation by tilting < > to the right and turning the < > dial. Convenient when you want to set exposure compensation while <**M**> manual exposure and Auto ISO are set.

**Tv : Shutter speed setting in M mode**

In manual exposure <**M**>, you can set the shutter speed with the < > or < > dial.

### Av: Aperture setting in M mode

In manual exposure <M>, you can set the aperture with the <⊙> or <⊙> dial.

### RAW/JPEG: One-touch image quality setting

Pressing the button assigned to this function will switch to the image-recording quality set here. While this change is in effect, the image-recording quality (JPEG/RAW) will blink in the viewfinder (with [Show/hide in viewfinder]'s [Image quality] checkmarked). After the shooting ends, the One-touch image quality setting will be canceled and the image-recording quality will be switched back to the previous quality.

\*6: On the setting screen, by pressing the <INFO.> button, you can select the image-recording quality for this function.

### RAW/JPEG H: One-touch image quality (hold)

Pressing the button assigned to this function will switch to the image-recording quality set here. While this change is in effect, the image-recording quality (JPEG/RAW) will blink in the viewfinder (with [Show/hide in viewfinder]'s [Image quality] checkmarked). Even after shooting, the One-touch image quality setting will not be canceled. To revert to the previous image-recording quality setting, press the button assigned to this function again.

\*6: On the setting screen, by pressing the <INFO.> button, you can select the image-recording quality for this function.

### ⇐: Image quality

Press <SET> to display the image-recording quality setting screen (p.149) on the LCD monitor.

ⓘ If RAW or RAW+JPEG is set for the image-recording quality to be switched to with [One-touch image quality setting] and [One-touch image quality (hold)], [Multi Shot Noise Reduction] (p.176) will not work after the switch. For [3: High ISO speed noise reduct'n], [Standard] will be applied for shooting.

ⓘ During the switch to the One-touch image quality setting, you can display <ⓘ> in the viewfinder and on the LCD panel (p.441).

**📷: Picture Style**

Press <  > to display the Picture Style selection setting screen on the LCD monitor (p.160).

**🔍: Depth-of-field preview**

When you press the depth-of-field preview button, the aperture will stop down and you can check the depth of field (p.221).

**👉: IS start**





With the lens's IS switch set to < **ON** >, the lens's Image Stabilizer operates when you press the button assigned to this function (p.53).

**MENU: Menu display**

Press <  > will display the menu on the LCD monitor.

**📷: Register/recall shooting function**



You can manually set the main shooting functions such as the shutter speed, aperture, ISO speed, metering mode, AF area selection mode, and register them to the camera. Only while you hold down the button assigned to this function, you can summon and use the registered shooting function settings and shoot.

\*7: On the setting screen, press the < **INFO.** > button to display the detailed settings. Turn the <  > or <  > dial to select the function to be registered, then press <  > to append a checkmark [✓] to it. When you select a parameter and press <  >, you can adjust the parameter. By pressing the <  > button, you can revert the settings to their defaults. By selecting [**Register current settings**], the camera's current settings will be registered. To register the AF point, see page 450.







: **Image playback**

Pressing <SET> will play back images.



: **Magnify/Reduce (press SET, turn )**



Press <SET> to magnify or reduce the images recorded on the card. See page 364 for the operation procedure. During Live View or movie shooting (except +Tracking), you can also magnify the image (p.305, 308).

: **Cycle:  • ISO/Drive • AF/WB • **

Pressing the <M-Fn> button changes the settable function in this sequence:  • ISO → DRIVE • AF → WB • .

UNLOCK : **Unlock while button pressed**

Even when the <LOCK > switch is set to the right, only while you hold down the depth-of-field preview button, you can use the camera control buttons and dials restricted by [.3: **Multi function lock**].

/ : **Flash function settings**

Pressing <SET> will display the function setting screen for the built-in flash or external Speedlite.

OFF: **No function (disabled)**

Use this setting when you do not want to assign any function to the button.

## MENU Registering My Menu ☆

Under My Menu tab, you can register menu items and Custom Functions whose settings you change frequently. You can also name the registered menu tabs and press the <MENU> button to display the My Menu tab first.

### Adding My Menu Tab

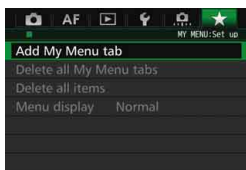

#### 1 Select [Add My Menu tab].

- Under the [★] tab, select [Add My Menu tab], then press <SET>.

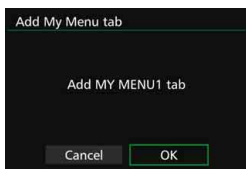

#### 2 Select [OK].

- ▶ The [MY MENU1] tab is created.
- You can create up to five menu tabs by repeating steps 1 and 2.

### Registering Menu Items under the My Menu Tab(s)

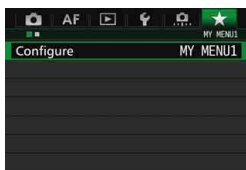

#### 1 Select [Configure: MY MENU\*].

- Turn the <☀> dial and select [Configure: MY MENU\*] (tab for registering menu items), then press <SET>.

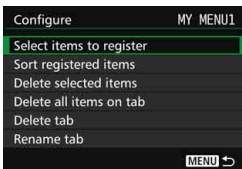

## 2 Select [Select items to register].

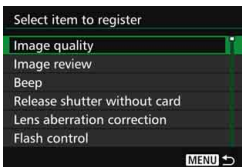

## 3 Register the desired items.

- Select the desired item, then press <SET>.
- Select [OK] on the confirmation dialog.
- You can register up to six items.
- To return to the screen in step 2, press the <MENU> button.

## My Menu Tab Settings

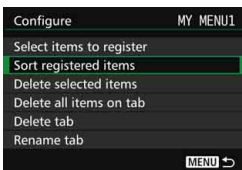

You can sort and delete items under the menu tab, and rename or delete the menu tab.

### • Sort registered items

You can change the order of the registered items in My Menu. Select [Sort registered items] and select the item whose order you want to change. Then press <SET>. With [◆] displayed, turn the <⦿> dial to change the order, then press <SET>.

### • Delete selected items / Delete all items on tab

You can delete any of the registered items. [Delete selected items] deletes one item at a time, and [Delete all items on tab] deletes all registered items.



- **Delete tab**

You can delete the My Menu tab currently displayed. Select [**Delete tab**] to delete the [**MY MENU\***] tab.

- **Rename tab**

You can rename the My Menu tab from [**MY MENU\***].

## 1 Select [**Rename tab**].



## 2 Enter text.

- Press the <[Delete]> button to delete any unnecessary characters.
- Press the <[Q]> button. The text palette will be highlighted with a color frame, and text can be entered.
- Operate the <[Dial]> or <[Cursor]> to move the cursor and select the desired character. Then press <[SET]> to enter it.
- You can enter up to 16 characters.

## 3 Exit the setting.

- After entering the text, press the <MENU> button, then select [**OK**].
- ▶ The name is saved.

## Deleting all My Menu tabs / Deleting all items

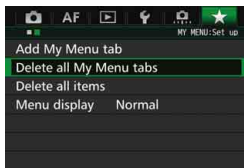

You can delete all My Menu tabs and delete all My Menu items.

- **Delete all My Menu tabs**

You can delete all My Menu tabs. When you select [**Delete all My Menu tabs**], all the tabs from [**MY MENU1**] to [**MY MENU5**] will be deleted and the [**★**] tab will revert to its default.

- **Delete all items**

You can delete all the items registered under the [**MY MENU1**] to [**MY MENU5**] tabs and keep the tabs. The menu tab(s) will remain. When [**Delete all items**] is selected, all the items registered under all the created tabs will be deleted.

ⓘ If you do [**Delete tab**] or [**Delete all My Menu tabs**], tab names renamed with [**Rename tab**] will also be deleted.

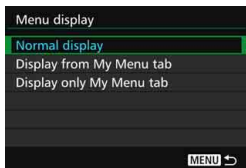

## Menu Display Settings



You can select [**Menu display**] to set the menu screen that is to appear first when you press the <MENU> button.



- **Normal display**  
Displays the last displayed menu screen.
- **Display from My Menu tab**  
Displays with the [★] tab selected.
- **Display only My Menu tab**  
Only the [★] tab is displayed. (The 📷, AF, ▶, 📷, and 📷 tabs will not be displayed.)

## : Registering Custom Shooting Modes ☆

You can register current camera settings, such as the shooting mode, menu functions, and Custom Function settings, as Custom shooting modes under the Mode Dial's , , and  positions.



### 1 Select [Custom shooting mode (C1-C3)].

- Under the [4] tab, select [**Custom shooting mode (C1-C3)**], then press .

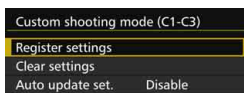

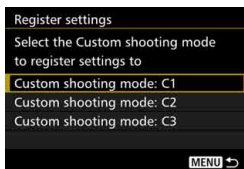

### 2 Select [Register settings].



### 3 Register the Custom shooting mode.

- Select the Custom shooting mode to be registered, then press .
- Select [**OK**] on the confirmation dialog.
- ▶ The current camera settings (p.465-466) will be registered under the Mode Dial's C\* position.

## Automatic Updating

If you change a setting while you shoot in the , , or  mode, the respective Custom shooting mode can be automatically updated to reflect the changes in settings. To enable this automatic update, in step 2, set [**Auto update set.**] to [**Enable**].

## Canceling Registered Custom Shooting Modes

In step 2, if you select [**Clear settings**], the camera will revert to the default settings with no Custom shooting modes registered.

## Settings Registered

- **Shooting functions**

Shooting mode, Shutter speed, Aperture, ISO speed, AF operation, AF area selection mode, AF point, Drive mode, Metering mode, Exposure compensation amount, Flash exposure compensation amount

- **Menu functions**

[1] Image quality, Image review time, Beep, Release shutter without card, Lens aberration correction, Flash firing, E-TTL II flash metering, Flash sync speed in Av mode

[2] Exposure compensation/AEB, ISO speed settings, Auto Lighting Optimizer, White balance, Custom White Balance, White balance Shift/Bracketing, Color space

[3] Picture Style, Long exposure noise reduction, High ISO speed noise reduction, Highlight tone priority, Multiple exposure (settings), HDR Mode (settings)

[4] Red-eye reduction, Interval timer, Bulb timer, Anti-flicker shooting, Mirror lockup

[5 (Live View shooting)]

Live View shooting, AF method, Continuous AF, Grid display, Aspect ratio, Exposure simulation

[6] Silent LV shooting, Metering timer

[4 (Movie)]

Movie Servo AF, AF method, Grid display, Movie recording quality, Sound recording, AF speed during Movie Servo AF, Movie Servo AF tracking sensitivity











[5 (Movie)]

Silent LV shooting, Metering timer, Movie recording count, Movie play count, Silent control,  button function, HDMI output +LCD

[AF1] Case 1, Case 2, Case 3, Case 4, Case 5, Case 6

[AF2] AI Servo 1st image priority, AI Servo 2nd image priority

[AF3] Lens electronic MF, AF-assist beam firing, One-Shot AF release priority

- [**AF4**] Lens drive when AF impossible, Selectable AF point, Select AF area selection mode, AF area selection method, Orientation linked AF point, Initial AF point (C) AI Servo AF, Auto AF point selection: EOS iTR AF
- [**AF5**] Manual AF point selection pattern, AF point display during focus, VF display illumination, AF status in viewfinder, AF Microadjustment
- [ **2**] Slide show (settings), Image jump with 
- [ **3**] Highlight alert, AF point display, Playback grid, Histogram display, Movie play count, Magnification (approx.)
- [ **1**] File numbering, Auto rotate, Eye-Fi settings
- [ **2**] Auto power off, LCD brightness, Viewfinder display
- [ **3**] Auto cleaning, **INFO** button display options, **RATE** button function, HDMI frame rate
- [ **1**] Exposure level increments, ISO speed setting increments, Bracketing auto cancel, Bracketing sequence, Number of bracketed shots, Safety shift, Same exposure for new aperture
- [ **2**] Set shutter speed range, Set aperture range, Continuous shooting speed
- [ **3**] Live View shooting area display, Dial direction during Tv/Av, Multi function lock, Custom Controls
- [ **4**] Add cropping information, Default Erase option, Retract lens on power off

 My Menu settings will not be registered under Custom shooting modes.

-  • Even when the Mode Dial is set to <**C1**>, <**C2**>, or <**C3**>, you can still change shooting function settings and menu settings.
- By pressing the <**INFO.**> button, you can check which shooting mode is registered under <**C1**>, <**C2**>, and <**C3**> (p.468-469).

# 15

## Reference

This chapter provides reference information for camera features, system accessories, etc.



### Certification Logo

Select [**F4: Certification Logo Display**] and press <SET> to display some of the logos of the camera's certifications. Other certification logos can be found in this Instruction Manual, on the camera body, and on the camera's package.

# INFO. Button Functions



If you press the <INFO.> button when the camera is ready to shoot, the screens for the [Displays camera settings], [Electronic level] (p.75), and [Displays shooting function] (p.469) will be displayed in sequence.

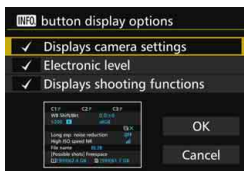

Under the [INFO] button display options, [INFO button display options] enables you to select the options displayed when the <INFO.> button is pressed.

- Select the desired display option and press <SET> to append a checkmark [✓].
- After completing the selections, select [OK].

- Note that you cannot remove the [✓] for all three display options.
- The [Displays camera settings] sample screen is displayed in English for all languages.
- Even if you uncheck the [Electronic level] so it does not appear, it will still appear for Live View shooting and movie shooting when you press the <INFO.> button.

## Camera Settings

Shooting mode registered under the Mode Dial's [1] [2] [3] (p.464)

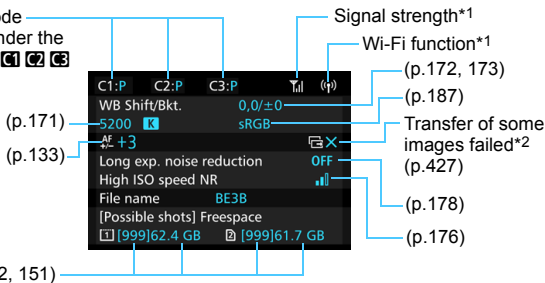

\*1: Refer to the Wi-Fi Adapter W-E1 Instruction Manual.

\*2: This icon is displayed when the transfer of some images failed.



## Shooting Function Settings

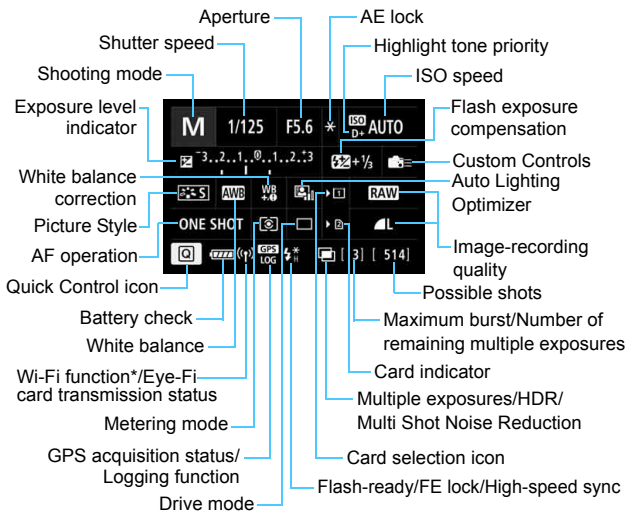

\* Refer to the Wi-Fi Adapter W-E1 Instruction Manual.

- Pressing the  $\langle Q \rangle$  button enables Quick Control of the shooting settings (p.61).
- When you press the  $\langle WB \cdot \text{AF} \rangle$ ,  $\langle DRIVE \cdot AF \rangle$ ,  $\langle \text{ISO} \rangle$ , or  $\langle \text{Flash} \rangle$  button, the setting screen appears and you can use  $\langle \text{Sun} \rangle$ ,  $\langle \text{Clock} \rangle$ ,  $\langle M-Fn \rangle$ , or  $\langle \text{Info} \rangle$  to set it.

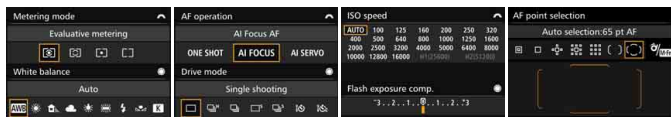

If you turn off the power while the “Shooting function settings” or “Electronic level” screen is displayed, the same screen will be displayed when you turn on the power again. To cancel this, press the  $\langle \text{INFO.} \rangle$  button to exit from “Shooting function settings” screen, then turn off the power switch.

## MENU Checking the Battery Information

You can check the battery's condition on the LCD monitor. Each Battery Pack LP-E6N/LP-E6 has a unique serial number, and you can register multiple battery packs to the camera. When you use this feature, you can check the registered battery pack's remaining capacity and operation history.



### Battery position

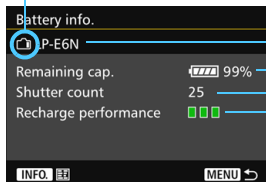

### Select [Battery info.].

- Under the [**F3**] tab, select [**Battery info.**], then press <SET>.
- The battery info. screen will appear.

Battery model or household power source being used.

The battery level icon (p.46) is displayed together with the remaining battery capacity shown in 1% increments.

The number of shots taken with the current battery. The number is reset when the battery is recharged.

Battery's recharge performance level is displayed in one of three levels.

■■■ (Green): Battery's recharge performance is fine.

■■□ (Green): Battery's recharge performance is slightly degraded.

■□□ (Red): Purchasing a new battery is recommended.



- Using a genuine Canon Battery Pack LP-E6N/LP-E6 is recommended. If you use batteries that are not genuine Canon products, the camera's full performance may not be attained or malfunction may result.
- If Battery Grip BG-E16 (sold separately) and Wireless File Transmitter WFT-E7 (Ver. 2, sold separately) are both attached to the camera, battery information only for the BG-E16 will be displayed. Battery information for the WFT-E7 (Ver. 2) will not be displayed.



- The shutter count is the number of still photos taken. (Movies are not counted.)
- The battery information will also be displayed for Battery Pack LP-E6N/LP-E6 inside Battery Grip BG-E16 (sold separately). If size-AA/LR6 batteries are used, only the battery level will be displayed.



If communication with the battery is not possible or irregular for some reason, **[Use this battery?]** will be displayed. If you select **[OK]**, you can continue shooting. However, depending on the battery, the battery info. screen may not be displayed or may not display battery info. correctly.

## Registering Batteries to the Camera

You can register up to six LP-E6N/LP-E6 battery packs to the camera. To register multiple battery packs to the camera, follow the procedure below for each battery pack.

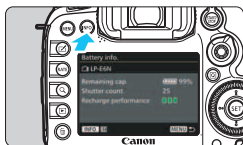

### 1 Press the **<INFO.>** button.

- With the battery info. screen displayed, press the **<INFO.>** button.
- ▶ The battery history screen will appear.
- ▶ If the battery is not registered, it will be grayed out.

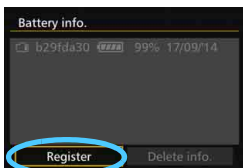

### 2 Select **[Register]**.

- ▶ The confirmation dialog will appear.

### 3 Select **[OK]**.

- ▶ The battery pack will be registered and the battery history screen will reappear.
- ▶ The grayed out battery number will now be displayed in white.
- Press the **<MENU>** button. The battery info. screen will reappear.



- The battery cannot be registered if Battery Grip BG-E16 (sold separately) using AA/LR6 batteries is attached or the camera is powered by the DC Coupler DR-E6 (sold separately) and AC Adapter AC-E6N (sold separately).
- If six battery packs are already registered, **[Register]** cannot be selected. To delete unnecessary battery information, see page 473.

## Labeling Serial Numbers on Batteries

It is convenient to label all registered Battery Pack LP-E6N/LP-E6 with their serial numbers, using commercially-available labels.

Serial number

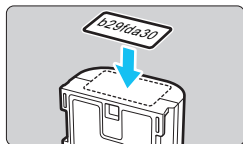
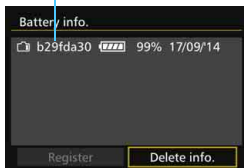

### 1 Write the serial number on a label.

- Write the serial number displayed on the battery history screen on a label approx. 25 mm x 15 mm / 1.0 in. x 0.6 in. in size.

### 2 Take out the battery and affix the label.

- Set the power switch to <OFF>.
- Open the battery compartment cover and remove the battery.
- Affix the label as shown in the illustration (on the side with no electrical contacts).
- Repeat this procedure for all of your battery packs so you can easily see the serial number.

- Do not affix the label on any part other than as shown in the illustration in step 2. Otherwise, the misplaced label may make it difficult to insert the battery or impossible to turn on the camera.
- If you use Battery Grip BG-E16 (sold separately), the label may peel off as you repeatedly insert and remove the battery pack. If it peels off, affix a new label.

## Checking the Remaining Capacity of a Registered Battery Pack

You can check the remaining capacity of any battery pack (even when not installed) and also when it was last used.

Serial number      Date last used

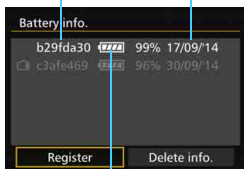

Remaining capacity

### Look for the serial number.

- Refer to the battery's serial number label and look for the battery's serial number on the battery history screen.
- ▶ You can check the respective battery pack's remaining capacity and the date when it was last used.

## Deleting the Registered Battery Pack Information

### 1 Select [Delete info.].

- Follow step 2 on page 471 to select [Delete info.], then press  $\langle \text{SET} \rangle$ .

### 2 Select the battery pack information to be deleted.

- Select the battery pack information to be deleted, then press  $\langle \text{SET} \rangle$ .
- ▶ [✓] will appear.
- To delete information for another battery pack, repeat this procedure.

### 3 Press the $\langle \text{trash} \rangle$ button.

- ▶ The confirmation dialog screen will appear.

### 4 Select [OK].

- ▶ The battery pack information will be deleted and the screen in step 1 will reappear.

## Using a Household Power Outlet

You can power the camera with a household power outlet by using the DC Coupler DR-E6 and AC Adapter AC-E6N (both sold separately).

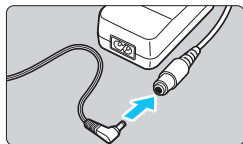

### 1 Connect the DC Coupler's plug.

- Connect the DC Coupler's plug to the AC Adapter's socket.

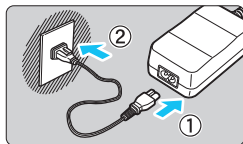

### 2 Connect the power cord.

- Connect the power cord as shown in the illustration.
- After using the camera, unplug the power plug from the power outlet.

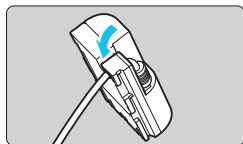

### 3 Place the cord in the groove.

- Insert the DC Coupler's cord carefully without damaging the cord.

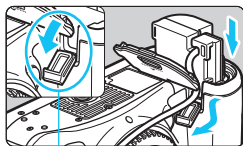

### 4 Insert the DC Coupler.

- Open the battery compartment cover and open the DC Coupler cord hole cover.
- Insert the DC Coupler securely until it locks and put the cord through the hole.
- Close the cover.

DC Coupler cord hole

**!** Do not connect or disconnect the power cord or DC Coupler while the camera's power switch is set to <ON>.

## Using Eye-Fi Cards

With a commercially-available Eye-Fi card already set up, you can automatically transfer captured images to a computer, or upload them to an online service via a wireless LAN.

The image transfer is a function of the Eye-Fi card. For instructions on how to set up and use the Eye-Fi card or to troubleshoot any image transfer problems, refer to the Eye-Fi card's instruction manual or contact the card manufacturer.

**⚠ The camera is not guaranteed to support Eye-Fi card functions (including wireless transfer). In case of a problem with an Eye-Fi card, please check with the card manufacturer. Also note that approval is required to use Eye-Fi cards in many countries or regions. Without approval, use of the card is not permitted. If it is unclear whether the card has been approved for use in your area, please check with the card manufacturer.**

### 1 Insert an Eye-Fi card (p.41).

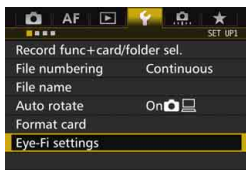

### 2 Select [Eye-Fi settings].

- Under the [**1**] tab, select [**Eye-Fi settings**], then press <SET>.
- This menu is displayed only when an Eye-Fi card is inserted into the camera.

### 3 Enable Eye-Fi transmission.

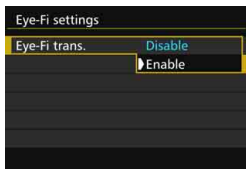

- Select [**Eye-Fi trans.**], then press <SET>.
- Select [**Enable**], then press <SET>.
- If you set [**Disable**], there will be no automatic transmission even with the Eye-Fi card inserted (transmission status icon ).

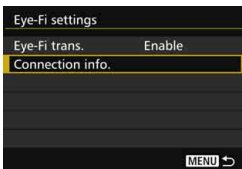

#### 4 Display the connection information.

- Select [**Connection info.**], then press <SET>.



#### 5 Check the [**Access point SSID:**].

- Check that an access point is displayed for [**Access point SSID:**].
- You can also check the Eye-Fi card's MAC address and firmware version.
- Press the <MENU> button to exit the menu.

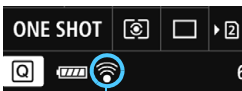

Transmission status icon



#### 6 Take the picture.

- ▶ The picture is transferred and the <Wi-Fi> icon switches from gray (not connected) to one of the icons below.
- For transferred images, [Q] is displayed in the shooting information display (p.357).

- 📶 (Gray) **Not connected** : No connection with access point.
- 📶 (Blinking) **Connecting...** : Connecting to access point.
- 📶 (Illuminated) **Connected** : Connection to access point established.
- 📶 (↑) **Transferring...** : Image transfer to access point in progress.



## Cautions for Using Eye-Fi Cards

- If “” is displayed, an error occurred while retrieving the card information. Turn the camera's power switch off, and on again.
- Even if [**Eye-Fi trans.**] is set to [**Disable**], it may still transmit a signal. In hospitals, airports, and other places where wireless transmissions are prohibited, remove the Eye-Fi card from the camera.
- If the image transfer does not function, check the Eye-Fi card and computer settings. For details, refer to the card's instruction manual.
- Depending on the wireless LAN's connection conditions, the image transfer may take longer or it may be interrupted.
- The Eye-Fi card may become hot as it transmits.
- The battery power will be consumed faster.
- During the image transfer, auto power off will not take effect.
- If you insert a wireless LAN card other than an Eye-Fi card, [**Eye-Fi settings**] will not appear. Also, the transmission status icon < > will not appear.

# System Map

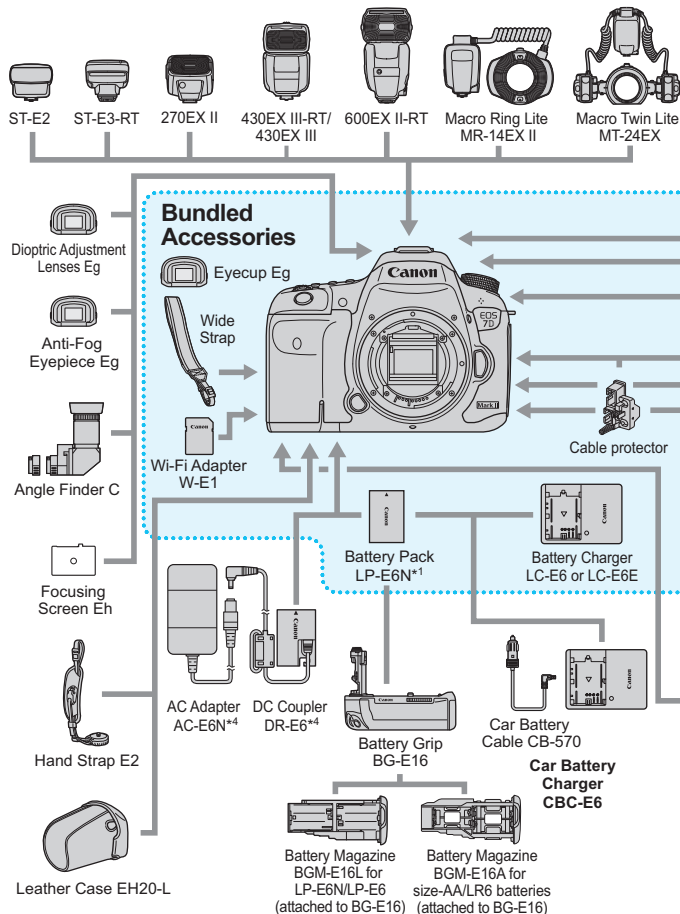

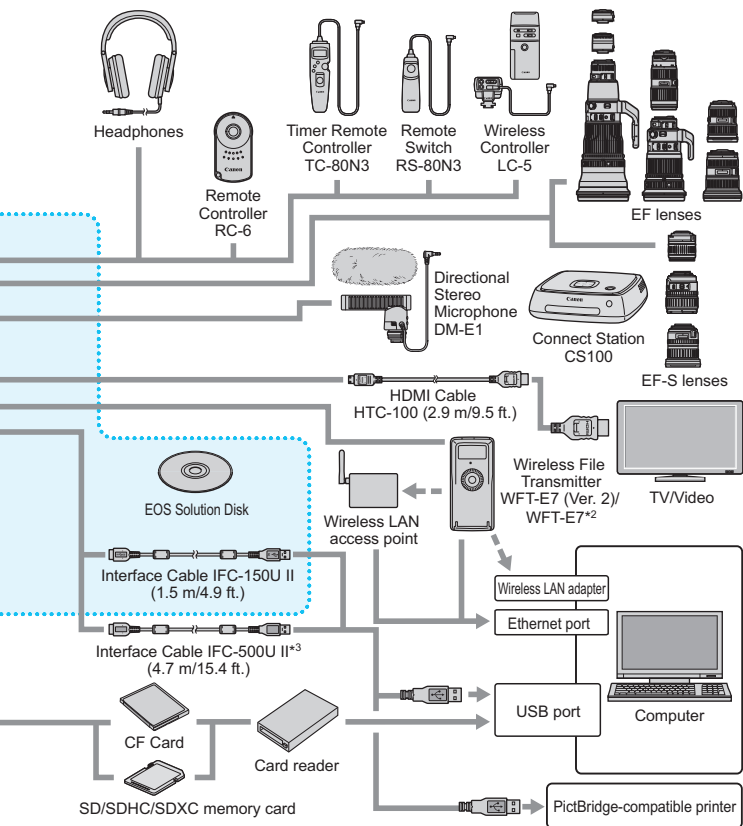

\*1: Battery Pack LP-E6 can also be used.

\*2: To use the older model WFT-E7 (not Version 2), the firmware must be updated and Interface Cable IFC-40AB II or IFC-150AB II must be used.

\*3: With IFC-500U II, the communication speed will be equivalent to Hi-Speed USB (USB 2.0).

\*4: AC Adapter Kit ACK-E6 can also be used.

\* All cable lengths given are approximate figures.

# Function Availability Table According to Shooting Mode

## Still Photo Shooting

● : Set automatically ○ : User selectable □ : Not selectable/Disabled

Function		A <sup>+</sup>	P	Tv	Av	M	B
All image quality settings selectable		○	○	○	○	○	○
ISO speed	Automatically set/Auto ISO	●	○	○	○	○	○
	Manually set	□	○	○	○	○	○
Picture Style	Automatically set/Auto	●	○	○	○	○	○
	Manual selection	□	○	○	○	○	○
White balance	Auto	●	○	○	○	○	○
	Preset	□	○	○	○	○	○
	Custom	□	○	○	○	○	○
	Color temperature setting	□	○	○	○	○	○
	Correction/Bracketing	□	○	○	○	○	○
Auto Lighting Optimizer		●	○	○	○	○	○
Long exposure noise reduction		□	○	○	○	○	○
High ISO speed noise reduction		●	○	○	○	○	○
Highlight tone priority		□	○	○	○	○	○
Lens aberration correction	Peripheral illumination correction	○	○	○	○	○	○
	Chromatic aberration correction	○	○	○	○	○	○
	Distortion correction	○	○	○	○	○	○
Anti-flicker shooting		●	○	○	○	○	○
Color space	sRGB	●	○	○	○	○	○
	Adobe RGB	□	○	○	○	○	○
AF	One-Shot AF	□	○	○	○	○	○
	AI Servo AF	□	○	○	○	○	○
	AI Focus AF	●	○	○	○	○	○
	AF area selection mode	□	○	○	○	○	○
	AF point	●	○	○	○	○	○
	Manual focusing (MF)	○	○	○	○	○	○
	AF-assist beam	● <sup>*1</sup>	○	○	○	○	○
	AF Microadjustment	□	○	○	○	○	○
	☺ (face)+Tracking <sup>*2</sup>	○	○	○	○	○	○
	FlexZone - Multi <sup>*2</sup>	○	○	○	○	○	○
	FlexZone - Single <sup>*2</sup>	○	○	○	○	○	○
	Continuous AF <sup>*2</sup>	○	○	○	○	○	○

Function			P	Tv	Av	M	B
Metering	Evaluative metering	●	○	○	○	○	○
	Partial metering		○	○	○	○	○
	Spot metering		○	○	○	○	○
	Center-weighted average metering		○	○	○	○	○
Exposure	Program shift		○				
	AE lock		○	○	○	*3	
	Exposure compensation		○	○	○	○*4	
	AEB		○	○	○	○	
	Depth-of-field preview		○	○	○	○	○
	HDR shooting		○	○	○	○	
	Multiple exposures		○	○	○	○	○
	Interval timer <sup>5</sup>	○	○	○	○	○	
Bulb timer						○	
Drive	Single shooting	○	○	○	○	○	○
	High-speed continuous shooting	○	○	○	○	○	○
	Low-speed continuous shooting	○	○	○	○	○	○
	Silent single shooting	○	○	○	○	○	○
	Silent continuous shooting	○	○	○	○	○	○
	10-sec. self-timer/Remote control	○	○	○	○	○	○
	2-sec. self-timer/Remote control	○	○	○	○	○	○
Built-in flash	Automatic firing	○					
	Flash on (Fires at all times)	○	○	○	○	○	○
	Flash off	○	○	○	○	○	○
	Red-eye reduction	○	○	○	○	○	○
	FE lock		○	○	○	○	○
	Flash exposure compensation		○	○	○	○	○
	Wireless control		○	○	○	○	○
External Speedlite	Function settings		○	○	○	○	○
	Custom Function settings		○	○	○	○	○
Live View shooting		○	○	○	○	○	○
Quick Control		○	○	○	○	○	○

\*1: If the built-in flash is set to , the AF-assist beam will not be emitted.

\*2: Settable only during Live View shooting.













\*3: With Auto ISO, you can set a fixed ISO speed.

\*4: Settable only when Auto ISO is set.

\*5: Settable only during viewfinder shooting.













## Movie Shooting

● : Set automatically ○ : User selectable □ : Not selectable/Disabled

Function		Movies					Still Photos  <sup>*1</sup>			
			P/B	Tv	Av	M		P/B/Tv/Av	M	
										
All image quality settings selectable (movie)		○	○	○	○	○				
All image quality settings selectable (still photos)						○	○			○
ISO speed	Automatically set/Auto ISO	●	●	●	●	○	●	●		○
	Manually set					○				○
Picture Style	Automatically set/Auto	●	○	○	○	○	●	○		○
	Manual selection		○	○	○	○		○		○
White balance	Auto	●	○	○	○	○	●	○		○
	Preset		○	○	○	○		○		○
	Custom		○	○	○	○		○		○
	Color temperature setting		○	○	○	○		○		○
	Correction		○	○	○	○		○		○
	Bracketing							○		○
Auto Lighting Optimizer		●	○	○	○	○	●	○		○
Long exposure noise reduction										
High ISO speed noise reduction <sup>*2</sup>		●	○	○	○	○	●	○		○
Highlight tone priority			○	○	○	○		○		○
Lens aberration correction	Peripheral illumination correction	○	○	○	○	○	○	○		○
	Chromatic aberration correction	○	○	○	○	○	○	○		○
	Distortion correction									
Color space	sRGB	●	●	●	●	●	●	○		○
	Adobe RGB							○		○
AF	⌂+Tracking	○	○	○	○	○	○	○		○
	FlexiZone - Multi	○	○	○	○	○	○	○		○
	FlexiZone - Single	○	○	○	○	○	○	○		○
	Manual focusing (MF)	○	○	○	○	○	○	○		○
	Movie Servo AF	○	○	○	○	○	○	○		○

\*1 : The  icon indicates still photo shooting during movie shooting.

\*2 : Multi Shot Noise Reduction cannot be set.

Function		Movies					Still Photos  <sup>*1</sup>				
			P/B	Tv	Av	M		P/B/Tv/Av			M
											
<b>Metering</b>		●	●	●	●	●	●	●			●
<b>Exposure</b>	Program shift										
	AE lock		○	○	○	*3		○			*3
	Exposure compensation		○	○	○	○ <sup>*4</sup>		○			○ <sup>*4</sup>
	AEB										
	Depth-of-field preview										
<b>Drive</b>	Single shooting						○	○			○
	High-speed continuous shooting						○	○			○
	Low-speed continuous shooting						○	○			○
	Silent single shooting						○	○			○
	Silent continuous shooting						○	○			○
	10-sec. self-timer/ Remote control <sup>*5</sup>						○	○			○
	2-sec. self-timer/Remote control <sup>*5</sup>						○	○			○
<b>Built-in flash/External Speedlite</b>											
<b>Sound recording</b>		○	○	○	○	○					
<b>Time code</b>		○	○	○	○	○					
<b>Quick Control</b>		○	○	○	○	○	○	○			○

\*3 : With Auto ISO, you can set a fixed ISO speed.

\*4 : With Auto ISO, you can set exposure compensation.







\*5 : Works only before you start shooting a movie.





# Menu Settings

## Viewfinder Shooting and Live View Shooting

: Shooting 1 (Red)

Page









Image quality	RAW / M RAW / S RAW	149
	 L /  L /  M /  M /  S1 /  S1 / S2 / S3	
Image review time	Off / 2 sec. / 4 sec. / 8 sec. / Hold	70
Beep	Enable / Disable	69
Release shutter without card	Enable / Disable	42
Lens aberration correction	Peripheral illumination: Enable / Disable	181
	Chromatic aberration: Enable / Disable	
	Distortion: Disable / Enable	
Flash control	Flash firing / E-TTL II metering / Flash sync. speed in Av mode / Built-in flash settings / External flash function settings / External flash C.Fn setting / Clear settings	262

-  Shaded menu options are not displayed in the <[A+]> mode.
- What is displayed under [ 1: Image quality] depends on the [Record func.] (p.146) setting under [ 1: Record func+card/folder sel.]. If [Rec. separately] is set, set the image quality for each card.
- With movie shooting, certain menu items are not displayed. Also, the [ 6] tab will not appear.











 **Shooting 2 (Red)**

Page

<b>Exposure compensation/ AEB setting*</b>	1/3- and 1/2-stop increments, $\pm 5$ stops (AEB $\pm 3$ stops)	226 227
<b>ISO speed settings</b>	ISO speed / ISO speed range / Auto ISO range / Minimum shutter speed	154
<b>Auto Lighting Optimizer</b>	Disable / Low / Standard / High	175
	Disabled in M or B modes	
<b>White balance</b>	 /  /  /  /  /  /  /  /  (Approx. 2500 - 10000)	168
<b>Custom White Balance</b>	Manual setting of white balance	169
<b>White balance shift/ bracketing</b>	White balance correction: B/A/M/G bias, 9 levels each White balance bracketing: B/A and M/G bias, single-level increments, $\pm 3$ levels	172
<b>Color space</b>	sRGB / Adobe RGB	187

\* During movie shooting, [Expo.comp./AEB] will be [Exposure comp.].

 **Shooting 3 (Red)**

<b>Picture Style</b>	 Auto /  Standard /  Portrait /  Landscape /  Neutral /  Faithful /  Monochrome /  User Def. 1-3	160
<b>Long exposure noise reduction</b>	Disable / Auto / Enable	178
<b>High ISO speed noise reduction</b>	Disable / Low / Standard / High / Multi Shot Noise Reduction	176
<b>Highlight tone priority</b>	Disable / Enable	180
<b>Dust Delete Data</b>	Obtain data to be used by EOS software to delete dust spots	407
<b>Multiple exposure</b>	Multiple exposure / Multiple exposure control / Number of exposures / Save source images / Continue multiple exposure	238
<b>HDR Mode</b>	Adjust dynamic range / Effect / Continuous HDR / Auto Image Align / Save source images	233

**📷: Shooting 4\* (Red)**

Page

<b>Red-eye reduction</b>	Disable / Enable	256
<b>Interval timer</b>	Disable / Enable (Interval / Number of shots)	250
<b>Bulb timer</b>	Disable / Enable (Exposure time)	231
<b>Anti-flicker shooting</b>	Disable / Enable	185
<b>Mirror lockup</b>	Disable / Enable	246

\* In the <[A]<sup>+</sup>> mode, these menu options are displayed under [📷2].

**📷: Shooting 5\* (Red)**

<b>Live View shooting</b>	Enable / Disable	287
<b>AF method</b>	☺+Tracking / FlexiZone - Multi / FlexiZone - Single	299
<b>Continuous AF</b>	Disable / Enable	294
<b>Grid display</b>	Off / 3x3 卍 / 6x4 卐 / 3x3+diag 卐*	295
<b>Aspect ratio</b>	3:2 / 4:3 / 16:9 / 1:1	295
<b>Exposure simulation</b>	Enable / During 📷 / Disable	296

\* In the <[A]<sup>+</sup>> mode, these menu options are displayed under [📷3].

**📷: Shooting 6 (Red)**

<b>Silent LV shooting</b>	Mode 1 / Mode 2 / Disable	297
<b>Metering timer</b>	4 sec. / 8 sec. / 16 sec. / 30 sec. / 1 min. / 10 min. / 30 min.	298

**AF: AF1 (Purple)**

Page

<b>Case 1</b>	Versatile multi purpose setting	109
<b>Case 2</b>	Continue to track the subjects, ignoring possible obstacles	109
<b>Case 3</b>	Instantly focus on subjects suddenly entering AF points	110
<b>Case 4</b>	For subjects that accelerate or decelerate quickly	110
<b>Case 5</b>	For erratic subjects moving quickly in any direction	111
<b>Case 6</b>	For subjects that change speed and move erratically	112

**AF: AF2 (Purple)**









<b>AI Servo 1st image priority</b>	Release priority / Equal priority / Focus priority	117
<b>AI Servo 2nd image priority</b>	Shooting speed priority / Equal priority / Focus priority	118

**AF: AF3 (Purple)**

<b>Lens electronic MF</b>	Enable after One-Shot AF / Disable after One-Shot AF / Disable in AF mode	119
<b>AF-assist beam firing</b>	Enable / Disable / Enable external flash only / IR AF assist beam only	120
<b>One-Shot AF release priority</b>	Release priority / Focus priority	121

**AF: AF4 (Purple)**

Page

<b>Lens drive when AF impossible</b>	Continue focus search / Stop focus search	122
<b>Selectable AF point</b>	65 points / 21 points / 9 points	123
<b>Select AF area selection mode</b>	Manual selection: Spot AF / Manual selection: 1 point AF / Expand AF area:  / Expand AF area: Surround / Manual selection: Zone AF / Manual selection: Large Zone AF / Auto selection: 65 point AF	124
<b>AF area selection method</b>	 → M-Fn button /  → Main Dial	125
<b>Orientation linked AF point</b>	Same for both vertical/horizontal / Separate AF points: Area+point / Separate AF points: Point only	125
<b>Initial AF point,  AI Servo AF</b>	Initial  AF point selected / Manual     AF point / Auto	127
<b>Auto AF point selection: EOS iTR AF</b>	Enable / Disable	128

**AF: AF5 (Purple)**

<b>Manual AF point selection pattern</b>	Stops at AF area edges / Continuous	129
<b>AF point display during focus</b>	Selected (constant) / All (constant) / Selected (pre-AF, focused) / Selected (focused) / Disable display	130
<b>VF display illumination</b>	Auto / Enable / Disable	131
	AF point during AI Servo AF: Non illuminated / Illuminated	
<b>AF status in viewfinder</b>	Show in field of view / Show outside view	132
<b>AF Microadjustment</b>	Disable / All by same amount / Adjust by lens	133

## ▶: Playback 1 (Blue)



Page

<b>Protect images</b>	Protect images	368
<b>Rotate image</b>	Rotate images	367
<b>Erase images</b>	Erase images	392
<b>Print order</b>	Specify images to be printed (DPOF)	424
<b>Photobook Set-up</b>	Specify images for a photobook	429
<b>Image copy</b>	Copy images between cards	388
<b>RAW image processing</b>	Process <b>RAW</b> images	398

## ▶: Playback 2 (Blue)

<b>Resize</b>	Downsize JPEG image's pixel count	403
<b>Rating</b>	[OFF] / [.] / [·] / [∴] / [∴∴] / [∴∴∴]	371
<b>Slide show</b>	Set Playback description / Display time / Repeat, and start auto playback	382
<b>Image transfer</b>	Image selection/transfer / RAW+JPEG transfer	427
<b>Image jump w/ </b>	1 image / 10 images / 100 images / Date / Folder / Movies / Stills / Protect / Rating	362



## ▶: Playback 3 (Blue)

<b>Highlight alert</b>	Disable / Enable	359
<b>AF point display</b>	Disable / Enable	359
<b>Playback grid</b>	Off / 3x3  / 6x4  / 3x3+diag 	355
<b>Histogram display</b>	Brightness / RGB	360
<b>Movie playback count*</b>	Rec time / Time code	340
<b>Magnification (approx.)</b>	1x (no magnification) / 2x (magnify from center) / 4x (magnify from center) / 8x (magnify from center) / 10x (magnify from center) / Actual size (from selected point) / Same as last magnification (from center)	365
<b>Control over HDMI</b>	Disable / Enable	386

\* The setting is linked to the [Time code]'s [Movie play count] under the [Movie] tab.

## ☛: Set-up 1 (Yellow)

Page



<b>Record function+card/ folder selection</b>	Record function: Standard / Auto switch card / Record separately / Record to multiple	146
	Record/playback / Playback: [1] / [2]	148
	Folder: Creating and selecting a folder	188
<b>File numbering</b>	Continuous / Auto reset / Manual reset	193
<b>File name</b>	Preset code / User setting 1 / User setting 2	190
<b>Auto rotate</b>	On   / On  / Off	395
<b>Format card</b>	Erase data on the card by formatting	67
<b>Eye-Fi settings</b>	Displayed when a commercially-available Eye-Fi card is inserted	475

## ☛: Set-up 2 (Yellow)

<b>Auto power off</b>	1 min. / 2 min. / 4 min. / 8 min. / 15 min. / 30 min. / Disable	69
<b>LCD brightness</b>	Auto: Adjustable to one of three brightness levels	394
	Manual: Adjustable to one of seven brightness levels	
<b>Date/Time/Zone</b>	Date (year, month, day) / Time (hr., min., sec.) / Daylight saving time / Time zone	47
<b>Language</b> 	Select the interface language	49
<b>Viewfinder display</b>	Viewfinder level: Hide / Show	75
	VF grid display: Disable / Enable	74
	Show/hide in viewfinder: Shooting mode / White balance / Drive mode / AF operation / Metering mode / Image quality / Flicker detection	77
<b>GPS/digital compass settings</b>	Set GPS and digital compass functions	197



### 🔧: Set-up 3 (Yellow)

Page

<b>Video system</b>	For NTSC / For PAL	330 385
<b>Battery information</b>	Power source / Remaining capacity / Shutter count / Recharge performance / Battery registration / Serial number / Battery history	470
<b>Sensor cleaning</b>	Auto cleaning  : Enable / Disable	406
	Clean now 	
	Clean manually	409
<b>INFO. button display options</b>	Displays camera settings / Electronic level / Displays shooting functions	468
<b>RATE button function</b>	Rating / Protect	371 370
<b>HDMI frame rate*</b>	Auto / 59.94i / 50.00i / 59.94p / 50.00p / 23.98p	350
<b>Communication settings</b>	Displayed when WFT-E7 (Ver. 2, sold separately) is attached.	-
<b>Wi-Fi function</b>	Displayed when W-E1 is in use.	-

\* Options displayed on the screen differ depending on the [Video system] setting.

### 🔧: Set-up 4 (Yellow)

<b>Custom shooting mode (C1-C3)</b>	Register current camera settings to the Mode Dial's  ,  , and  positions	464
<b>Clear all camera settings</b>	Resets the camera to the default settings	70
<b>Copyright information</b>	Display copyright information / Enter author's name / Enter copyright details / Delete copyright information	195
<b>Certification Logo Display</b>	Some of the camera's certification logos are displayed	467
<b>📷 firmware ver.</b>	Select to update the firmware of the camera, lens, Speedlite, or Wireless File Transmitter	-

 When using GPS function or a Wireless File Transmitter, be sure to check the countries and areas of use, and use the device in accordance with the laws and regulations of the country or region.

 **Custom Functions (Orange)**

Page

<b>C.Fn1: Exposure</b>	Customize camera functions as desired	434
<b>C.Fn2: Exposure/Drive</b>		438
<b>C.Fn3: Display/ Operation</b>		440
<b>C.Fn4: Others</b>		443
<b>C.Fn5: Clear</b>		Clear all Custom Function settings

 **My Menu (Green)**

<b>Add My Menu tab</b>	Add My Menu tabs 1-5	459
<b>Delete all My Menu tabs</b>	Delete all My Menu tabs	462
<b>Delete all items</b>	Delete all items under My Menu tabs 1-5	462
<b>Menu display</b>	Normal display / Display from My Menu tab / Display only My Menu tab	463



## Movie Shooting

### 📷: Shooting 4\*<sup>1</sup> (Movie) (Red)

Page











<b>Movie Servo AF</b>	Enable / Disable	342
<b>AF method</b>	┌+Tracking / FlexiZone - Multi / FlexiZone - Single	343
<b>Grid display</b>	Off / 3x3 田 / 6x4 田田 / 3x3+diag 田田	344
<b>Movie recording quality</b>	MOV / MP4	330
	Movie recording size: • 1920x1080 / 1280x720 / 640x480 • NTSC: 59.94p / 29.97p / 23.98p PAL: 50.00p / 25.00p • ALL-I (For editing) / IPB (Standard) / IPB (Light)	331
	24.00p: Disable / Enable	333
<b>Sound recording</b> * <sup>2</sup>	Sound recording: Auto / Manual / Disable	336
	Recording level	
	Wind filter: Disable / Enable	
	Attenuator: Disable / Enable	
<b>Movie Servo AF speed</b>	When active: Always on / During shooting	345
	AF speed: Slow (4, 3, 2, 1) / Standard	
<b>Movie Servo AF tracking sensitivity</b>	Locked on (-1, -2) / 0 / Responsive (+1, +2)	346

\* In the <[A]<sup>+</sup>> mode, these menu options are displayed under [📷2].

\* In the <[A]<sup>+</sup>> shooting mode, [Sound recording] settings will be [On] [Off].

 : Shooting 5\*<sup>1</sup> (Movie) (Red)

Page

<b>Silent LV shooting</b>	Mode 1 / Mode 2 / Disable	347
<b>Metering timer</b>	4 sec. / 8 sec. / 16 sec. / 30 sec. / 1 min. / 10 min. / 30 min.	347
<b>Time code</b>	Count up / Start time setting / Movie recording count / Movie play count <sup>2</sup> / HDMI / Drop frame <sup>3</sup>	339
<b>Silent Control</b>	Enable  / Disable 	338
<b>button function</b>	 /  /  /  /  /  /  / 	348
<b>HDMI output + LCD</b>	No mirroring / Mirroring	348

\*1: In the <[A+]> mode, these menu options are displayed under [CAMERA 3].

\*2: The setting is linked to [Movie play count] under the [PLAYBACK 3] tab.

\*3: Displayed when 59.94P (59.94 fps) or 29.97P (29.97 fps) is set.

# Troubleshooting Guide

If a problem occurs with the camera, first refer to this Troubleshooting Guide. If this Troubleshooting Guide does not resolve the problem, contact your dealer or nearest Canon Service Center.

## Power-Related Problems

### The battery pack does not recharge.

- If the battery's remaining capacity is 94% or higher, the battery will not be recharged (p.470).
- Do not use any battery pack other than genuine Battery Pack LP-E6N/LP-E6.

### The charger's lamp blinks at high speed.

- If (1) the battery charger or battery pack has a problem or (2) communication with the battery pack failed (with a non-Canon battery pack), the protection circuit will stop charging, and the charge lamp will blink in orange at a high speed. In the case of (1), unplug the charger's power plug from the power outlet. Detach and reattach the battery pack to the charger. Wait a few minutes, then reconnect the power plug to the power outlet. If the problem persists, contact your dealer or nearest Canon Service Center.

### The charger's lamp does not blink.

- If the internal temperature of the battery pack attached to the charger is high, the charger will not charge the battery for safety reasons (lamp off). During charging, if the battery's temperature becomes high for any reason, charging will stop automatically (lamp blinks). When the battery temperature goes down, charging will resume automatically.

### The camera does not operate even when the power switch is set to <ON>.

- Make sure the battery compartment cover is closed (p.40).
- Make sure the battery is installed properly in the camera (p.40).
- Recharge the battery (p.38).
- Make sure the card slot cover is closed (p.41).

### The access lamp still lights or blinks even when the power switch is <OFF>.

- If the power is turned off while an image is being recorded to the card, the access lamp will remain on or continue to blink for a few seconds. When the image recording is completed, the power will turn off automatically.

### [Cannot communicate with battery] is displayed.

- Do not use any battery pack other than a genuine Battery Pack LP-E6N/LP-E6.
- Remove and install the battery again (p.40).
- If the battery contacts are dirty, use a soft cloth to clean them.

### The battery becomes exhausted quickly.

- Use a fully-charged battery pack (p.38).
- The battery performance may have degraded. See [🔧3: Battery info.] to check the battery's recharge performance level (p.470). If the battery performance is poor, replace the battery pack with a new one.
- The number of possible shots will decrease with any of the following operations:
  - Pressing the shutter button halfway for a prolonged period.
  - Activating the AF frequently without taking a picture.
  - Using the lens's Image Stabilizer.
  - Using the LCD monitor frequently.
  - Continuing Live View shooting or movie shooting for a prolonged period.
  - Using GPS.
  - [GPS] is set to [Enable] even after the camera's power is turned off.
  - The Eye-Fi card's communication function is operating.

### The camera turns off by itself.

- Auto power off is in effect. If you do not want auto power off to take effect, set [🔧2: Auto power off] to [Disable] (p.69).
- Even if [🔧2: Auto power off] is set to [Disable], the LCD monitor will still turn off after the camera is left idle for 30 min. (The camera's power does not turn off.)

**Auto power off does not work.**

- During interval timer shooting, auto power off will not take effect (p.250).

**Shooting-Related Problems****The lens cannot be attached.**

- The camera cannot be used with EF-M lenses (p.50).

**The viewfinder is dark.**

- Install a recharged battery pack in the camera (p.38).

**No images can be shot or recorded.**

- Make sure the card is properly inserted (p.41).
- If you are using an SD card, slide the card's write-protect switch to the Write/Erase setting (p.41).
- If the card is full, replace the card or delete unnecessary images to make space (p.41, 392).
- If you try to focus in the One-Shot AF mode and the focus indicator <●> in the viewfinder blinks, a picture cannot be taken. Press the shutter button halfway again to refocus automatically, or focus manually (p.55, 140).

**The card cannot be used.**

- If a card error message is displayed, see page 44 or 510.

**I cannot lock the focus and recompose the shot.**

- Set the AF operation to One-Shot AF (p.87). Focus lock is not possible in the AI Servo AF, or when servo takes effect in AI Focus AF (p.83).

## I have to press the shutter button twice completely to take a picture.

- If [**4: Mirror lockup**] is set to [**Enable**], set it to [**Disable**].

## The image is out of focus.

- Set the lens's focus mode switch to **<AF>** (p.50).
- Press the shutter button gently to prevent camera shake (p.54-55).
- If the lens has an Image Stabilizer, set the IS switch to **<ON>**.
- In low light, the shutter speed may become slow. Use a faster shutter speed (p.218), set a higher ISO speed (p.154), use flash (p.254, 259), or use a tripod.

## There are fewer AF points.

- Depending on the attached lens, the number of usable AF points and patterns will differ. The lenses are categorized into seven groups from A to G. Check which group your lens belongs to. Using a lens in Groups E to G will have fewer usable AF points (p.102-103).

## The AF point is blinking or two AF points are displayed.

- The AF point at the registered area is blinking (p.94, 450).
- The manually-selected AF point (or zone) and the registered AF point are displayed (p.93, 450).

## The AF points do not light up in red.

- The AF points light up in red when focus is achieved in low-light conditions.
- In the **<P>**, **<Tv>**, **<Av>**, **<M>**, and **<B>** modes, you can set whether to have the AF points light in red when focus is achieved (p.131).

## AF speed changes depending on lenses used.

- During Live View shooting and movie shooting, the AF control method (phase-difference detection with the image sensor or contrast detection) switches automatically depending on the lens type and function used such as magnified view. The AF speed may therefore change greatly and focusing may take longer.

## Focusing takes a long time.

- If FlexiZone - Multi is set, it may take longer to focus on the subject depending on the shooting conditions. Use FlexiZone - Single or focus manually.
- If the movie recording size is set to **FHD 59.94P** (59.94 fps) or **50.00P** (50.00 fps), contrast detection will be used for the AF control.

## The continuous shooting speed is slow.

- Depending on the shutter speed, aperture, subject conditions, brightness, etc., the continuous shooting speed may become slower (p.142).
- When EOS iTR AF is operating (p.128), maximum continuous shooting speed set with **<[H]>** will be approx. 9.5 shots/sec. Also, under low-light conditions, the continuous shooting speed may decrease.
- If **[Anti-flicker shoot.]** is set to **[Enable]** and you shoot under flickering light, the continuous shooting speed may become slightly slower, or the continuous shooting interval may become irregular. Also, the time lag until shutter release may be slightly longer than usual (p.185).

## The maximum burst during continuous shooting is lower.

- If you shoot something that has fine detail such as a field of grass, the file size will be larger, and the actual maximum burst may be lower than the number mentioned on page 151.

### ISO 100 cannot be set. ISO speed expansion cannot be selected.

- If [**☑3: Highlight tone priority**] is set to [**Enable**], the settable ISO speed range will be ISO 200 - ISO 16000. Even if you expand the settable ISO speed range with [**ISO speed range**], you cannot select the H1 (equivalent to ISO 25600) or H2 (equivalent to ISO 51200). When [**☑3: Highlight tone priority**] is set to [**Disable**], ISO 100/125/160, H1, or H2 can be set (p.180).

### Even if I set a decreased exposure compensation, the image comes out bright.

- Set [**☑2: Auto Lighting Optimizer**] to [**Disable**]. When [**Low**], [**Standard**], or [**High**] is set, even if you set a decreased exposure compensation or flash exposure compensation, the image may come out bright (p.175).

### I cannot set the exposure compensation while both manual exposure and Auto ISO are set.

- See page 223 to set the exposure compensation.
- Even if an exposure compensation is performed, it will not be applied for flash photography.

### Multi Shot Noise Reduction cannot be set.

- If the image-recording quality is set to RAW or RAW+JPEG, [**Multi Shot Noise Reduction**] cannot be set.

### The Live View image or movie shooting image is not displayed during multiple-exposure shooting.

- If [**On:ContShtng**] is set, Live View display, image review after image capture, or image playback is not possible during shooting (p.238).



### The multiple-exposure image is shot in **RAW** quality.

- When the image-recording quality is set to **M RAW** or **S RAW**, the multiple-exposure image will be recorded in **RAW** quality (p.245).

### When I use the **<Av>** mode with flash, the shutter speed becomes slow.

- If you shoot at night when the background is dark, the shutter speed automatically becomes slow (slow-sync shooting) so that both the subject and background are properly exposed. To prevent a slow shutter speed, under [**1: Flash control**], set [**Flash sync. speed in Av mode**] to [**1/250-1/60sec. auto**] or [**1/250 sec. (fixed)**] (p.263).

### The built-in flash rises by itself.

- In the **<A<sup>+</sup>>** mode, the built-in flash will be raised automatically when necessary.

### The built-in flash fires continuous flashes and makes a sound.

- In low light, the built-in flash fires continuous flashes as an AF-assist beam (p.89) to make it easier to focus. It also makes a sound when it fires the flashes. This is normal and not a malfunction.

### The built-in flash does not fire.

- If you use the built-in flash too often in too short a period of time, the flash may stop firing for a while to protect the flash unit.

### The external flash does not fire.

- If you use a non-Canon flash unit with Live View shooting, set [**6: Silent LV shoot.**] to [**Disable**] (p.297).

### The external flash always fires at full output.

- If you use a flash unit other than an EX-series Speedlite, the flash will always be fired at full output (p.260).
- When the external Speedlite's Custom Function setting for [**Flash metering mode**] is set to [**TTL flash metering**] (autoflash), the flash will always be fired at full output (p.271).

### Flash exposure compensation cannot be set for the external Speedlite.

- If flash exposure compensation is already set with the external Speedlite, flash exposure compensation cannot be set with the camera. When the external Speedlite's flash exposure compensation is canceled (set to 0), flash exposure compensation can be set with the camera.

### High-speed sync cannot be set in the <Av> mode.

- Under [**1: Flash control**], set [**Flash sync. speed in Av mode**] to [**Auto**] (p.263).



### The camera makes a small noise when it is shaken.

- When the camera's internal components slightly move, a small sound may be heard.

### The shutter makes two shooting sounds during Live View shooting.

- If you use flash, the shutter will make two sounds each time you shoot (p.287).

### During Live View or movie shooting, a white or red icon is displayed.

- It indicates that the camera's internal temperature is high. If the white < > icon is displayed, the still photo's image quality may deteriorate. If the red < > icon is displayed, it indicates that the Live View or movie shooting will soon stop automatically (p.310, 351).

### Movie shooting stops by itself.

- If the card's writing speed is slow, movie shooting may stop automatically. For cards that can record movies, see page 5. To find out the card's writing speed, refer to the card manufacturer's website.
- If the movie shooting time reaches 29 min. 59 sec., the movie shooting will stop automatically.

### Movie Servo AF cannot be used.

- The movie recording size is set to **FHD 59.94P** (59.94 fps) or **50.00P** (50.00 fps).

### The ISO speed cannot be set for movie shooting.

- If the shooting mode is **<A+>**, **<P>**, **<Tv>**, **<Av>**, and **<B>**, the ISO speed will be set automatically. In the **<M>** mode, you can freely set the ISO speed (p.321).

### The manually set ISO speed changes when switching to movie shooting.

- If you shoot a movie with manual exposure set to H2 (equivalent to ISO 51200), the ISO speed setting will switch to H1 (equivalent to ISO 25600). Even if you switch back to still photo shooting, the ISO speed will not revert to the H2.

### The exposure changes during movie shooting.

- If you change the shutter speed or aperture during movie shooting, the changes in the exposure may be recorded.
- Zooming the lens during movie shooting can cause changes in the exposure regardless of whether the lens's maximum aperture changes or not. The changes in the exposure may be recorded as a result.

### **The image flickers or horizontal stripes appear during movie shooting.**

- Flickering, horizontal stripes (noise), or irregular exposures can be caused by fluorescent lighting, LED lighting, or other light sources during movie shooting. Also, changes in the exposure (brightness) or color tone may be recorded. In the <M> mode, a slow shutter speed may reduce the problem.

### **The subject looks distorted during movie shooting.**

- If you move the camera to the left or right quickly (high-speed panning) or shoot a moving subject, the image may look distorted.

### **Still photo shooting is not possible during movie shooting.**

- The movie recording size is set to **FHD 59.94P** (59.94 fps) or **50.00P** (50.00 fps).

### **When I shoot still photos during movie shooting, the movie shooting stops.**

- To shoot still photos during movie shooting, using a CF card capable of UDMA transfer or a UHS-I SD card is recommended.
- Setting a lower image quality for still photos or shooting fewer continuous still photos may resolve the problem.

### **Time code is off.**



- Shooting still photos during movie shooting will cause a discrepancy between the actual time and time code. When you want to edit a movie using time code, it is recommended not to shoot still photos during movie shooting.

### **Shot images cannot be saved.**

- When using the Wi-Fi Adapter W-E1, the images cannot be saved if there is no CF card in the CF card slot.

## Operation Problems

### I cannot change the setting with the

< > dial, < > dial, < >, or < >.



- Set the <LOCK▶> switch to the left (lock release, p.59).
- Check the [.3: Multi function lock] setting (p.442).

### A camera button or dial does not work as expected.

- Check the [.3: Custom Controls] setting (p.445).

## Display Problems

### The menu screen shows fewer tabs and options.

- In the < > mode, only certain menu tabs and options are displayed. Set the shooting mode to <P> <Tv> <Av> <M> <B> (p.64).
- Under the [] tab, [Menu display] is set to [Display only My Menu tab] (p.463).

### The file name's first character is an underscore (“\_”).

- Set the color space to sRGB. If Adobe RGB is set, the first character will be an underscore (p.187).

### The fourth character in the file name changes.

- With [1: File name], select the camera's unique file name or the file name registered under User setting 1 (p.190).

### The file numbering does not start from 0001.

- If the card already contains recorded images, the image number may not start from 0001 (p.193).

### **The shooting date and time displayed is incorrect.**

- Check that the correct date and time are set (p.47).
- Check the time zone and daylight saving time (p.47-48).

### **The date and time are not in the picture.**

- The shooting date and time do not appear in the picture. The date and time are recorded in the image data as shooting information. When printing, you can imprint the date and time in the picture, using the date and time recorded in the shooting information (p.417, 421).

### **[###] is displayed.**

- If the number of images recorded on the card exceeds the number the camera can display, [###] will be displayed (p.373).

### **In the viewfinder, the AF point display speed is slow.**

- In low temperatures, the display speed of the AF points may become slower due to the AF point display device's (liquid crystal) characteristics. The display speed will return to normal at room temperature.

### **The LCD monitor does not display a clear image.**

- If the LCD monitor is dirty, use a soft cloth to clean it.
- In low or high temperatures, the LCD monitor display may seem slow or may look black. It will return to normal at room temperature.

### **[Eye-Fi settings] does not appear.**

- [Eye-Fi settings] will appear only when an Eye-Fi card is inserted in the camera. If the Eye-Fi card has a write-protect switch set to the **LOCK** position, you will not be able to check the card's connection status or disable Eye-Fi transmission (p.475).

## Playback Problems

### Part of the image blinks in black.

- [▶3: Highlight alert] is set to [Enable] (p.359).

### A red box is displayed on the image.

- [▶3: AF point disp.] is set to [Enable] (p.359).

### The image cannot be erased.

- If the image is protected, it cannot be erased (p.368).

### The movie cannot be played back.

- Movies edited with a computer cannot be played back with the camera.

### Camera operation noise can be heard when the movie is played back.

- If you operate the camera's dials or lens during movie shooting, the operation noise will also be recorded. Using the Directional Stereo Microphone DM-E1 (sold separately) is recommended (p.337).

### The movie has still moments.

- During autoexposure movie shooting, if there is a drastic change in the exposure level, the recording will stop momentarily until the brightness stabilizes. In such cases, shoot in the <M> mode (p.320).

### No picture on the TV set.

- Set the [**Y3: Video system**] correctly to [**For NTSC**] or [**For PAL**].
- Check that the HDMI cable's plug is inserted all the way in (p.385).
- If [**Q5: HDMI output+LCD**] is set to [**Mirroring**], the movie will not appear on the TV set via HDMI output even during playback.

### There are multiple movie files for a single movie shoot.

- If the movie file size reaches 4 GB, another movie file will be created automatically (p.335).

### My card reader does not recognize the card.

- Depending on the card reader and computer OS used, large-capacity CF cards or SDXC cards may not be correctly recognized. In such a case, connect your camera to the computer with the interface cable, then transfer the images to your computer using EOS Utility (EOS software, p.534).

### I cannot process the RAW image.

- **M RAW** and **S RAW** images cannot be processed with the camera. Use the EOS software, Digital Photo Professional to process the image (p.534).

### I cannot resize the image.

- **S3** JPEG images and **RAW/M RAW/S RAW** images cannot be resized with the camera (p.403).



## Sensor Cleaning Problems

### The shutter makes a noise during sensor cleaning.

- If you selected [**Clean now** ], the shutter will make a noise, but no picture is taken (p.406).

### Automatic sensor cleaning does not work.

- If you repeatedly turn the power switch <**ON**> / <**OFF**> at a short interval, the < > icon may not be displayed (p.45).

## Printing-Related Problems

### There are fewer printing effects than listed in the instruction manual.

- Contents displayed on the screen vary depending on the printer. This instruction manual lists all the printing effects available (p.416).

## Computer Connection Problems

### I cannot transfer images to a computer.

- Install the EOS Utility on your computer (p.534).
- Check that EOS Utility's main window is displayed.

# Error Codes

Error number

If there is a problem with the camera, an error message will appear. Follow the on-screen instructions.

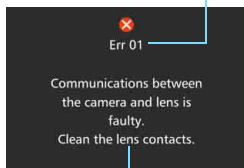

Cause and countermeasures

Number	Error Message and Solution
01	<b>Communications between the camera and lens is faulty. Clean the lens contacts.</b>
	→ Clean the electrical contacts on the camera and lens, use a Canon lens, or remove and install the battery pack again (p.21, 22, 40).
02	<b>Card* cannot be accessed. Reinsert/change card* or format card* with camera.</b>
	→ Remove and insert the card again, replace the card, or format the card (p.41, 67).
04	<b>Cannot save images because card* is full. Replace card*.</b>
	→ Replace the card, erase unnecessary images, or format the card (p.41, 67, 392).
05	<b>The built-in flash could not be raised. Turn the camera off and on again.</b>
	→ Operate the power switch (p.45).
06	<b>Sensor cleaning could not be performed. Turn the camera off and on again.</b>
	→ Operate the power switch (p.45).
10, 20 30, 40 50, 60 70, 80 99	<b>An error prevented shooting. Turn the camera off and on again or re-install the battery.</b>
	→ Operate the power switch, remove and install the battery pack again, or use a Canon lens (p.40, 45).

\* If the error still persists, write down the error number and contact your nearest Canon Service Center.

# Specifications

## • Type

Type:	Digital, single-lens reflex, AF/AE camera with built-in flash
Recording media:	CF cards (Type I, UDMA 7 supported) SD/SDHC*/SDXC* memory cards * UHS-I cards compatible.
Image sensor size:	Approx. 22.4 x 15.0 mm
Compatible lenses:	Canon EF lenses (including EF-S lenses) * Excluding EF-M lenses (35mm-equivalent focal length is approx. 1.6 times the focal length indicated on the lens)
Lens mount:	Canon EF mount

## • Image Sensor

Type:	CMOS sensor
Effective pixels:	Approx. 20.20 megapixels * Rounded off to the nearest 10,000th.
Aspect ratio:	3:2
Dust delete feature:	Auto/Manual, Appending Dust Delete Data

## • Recording System

Recording format:	Design rule for Camera File System (DCF) 2.0
Image type:	JPEG, RAW (14-bit Canon original), RAW+JPEG simultaneous recording possible
Pixels recorded:	L (Large) : Approx. 20.0 megapixels (5472 x 3648) M (Medium) : Approx. 8.90 megapixels (3648 x 2432) S1 (Small 1) : Approx. 5.0 megapixels (2736 x 1824) S2 (Small 2) : Approx. 2.50 megapixels (1920 x 1280) S3 (Small 3) : Approx. 350,000 pixels (720 x 480) RAW : Approx. 20.0 megapixels (5472 x 3648) M-RAW : Approx. 11.2 megapixels (4104 x 2736) S-RAW : Approx. 5.0 megapixels (2736 x 1824)
Record function:	Standard, Auto switch card, Record separately, Record to multiple
Create/select a folder:	Possible
File name:	Preset code / User setting 1 / User setting 2
File numbering:	Continuous, Auto reset, Manual reset

## • Image Processing During Shooting

Picture Style:	Auto, Standard, Portrait, Landscape, Neutral, Faithful, Monochrome, User Defined 1 - 3
----------------	--

## Specifications

White balance:	Auto, Preset (Daylight, Shade, Cloudy, Tungsten light, White fluorescent light, Flash), Custom, Color temperature setting (approx. 2500-10000 K), White balance correction, and White balance bracketing provided * Flash color temperature information transmission possible
Noise reduction:	Applicable to long exposures and high ISO speed shots
Automatic image brightness correction:	Auto Lighting Optimizer provided
Highlight tone priority:	Provided
Lens aberration correction:	Peripheral illumination correction, Chromatic aberration correction, Distortion correction
Anti-flicker:	Possible

### • Viewfinder

Type:	Eye-level pentaprism
Coverage:	Vertical/Horizontal approx. 100% (with Eye point approx. 22mm)
Magnification:	Approx. 1.00x (-1 m <sup>-1</sup> with 50mm lens at infinity)
Eye point:	Approx. 22mm (from eyepiece lens center at -1 m <sup>-1</sup> )
Built-in dioptic adjustment:	Approx. -3.0 - +1.0 m <sup>-1</sup> (dpt)
Focusing screen:	Eh-A standard screen, interchangeable
Grid display:	Provided
Electronic level:	Provided
Function setting display:	Shooting mode, White balance, Drive mode, AF operation, Metering mode, Image quality: JPEG/RAW, Flicker detection, Warning symbol !, AF status
Mirror:	Quick-return type
Depth-of-field preview:	Provided

### • Autofocus

Type:	TTL secondary image-registration, phase-difference detection with the dedicated AF sensor
AF points:	65 (Cross-type AF point: Max. 65 points) * Number of available AF points, cross-type points, and Dual cross-type points vary depending on the lens. * Dual cross-type focusing at f/2.8 with center AF point. (Excluding some lenses with f/2.8 or larger maximum aperture)
Focusing brightness range:	EV -3 - 18 (Conditions: f/2.8-sensitive center AF point, One-Shot AF, room temperature, ISO 100)
Focus operation:	One-Shot AF, AI Servo AF, AI Focus AF, Manual focusing (MF)

AF area selection mode:	Single-point Spot AF (manual selection), Single-point AF (manual selection), AF point expansion (manual selection: up, down, left, and right), AF point expansion (manual selection: surround), Zone AF (manual selection of zone), Large Zone AF (manual selection of zone), 65-point automatic selection AF
AF point automatic selection conditions:	Based on EOS iTR AF setting (Enables AF incorporating human face/color information) * iTR: Intelligent Tracking and Recognition
AF Configuration Tool:	Case 1 - 6
AI Servo AF characteristics:	Tracking sensitivity, Acceleration/deceleration tracking, AF point auto switching
AF Custom Functions:	17 functions
AF fine adjustment:	AF Microadjustment (All lenses by same amount or Adjust by lens)
AF-assist beam:	Small series of flashes fired by built-in flash

## • Exposure Control

Metering modes:	Approx. 150,000-pixel RGB+IR metering sensor and 252-zone TTL metering at max. aperture EOS iSA (Intelligent Subject Analysis) system <ul style="list-style-type: none"> <li>• Evaluative metering (linked to all AF points)</li> <li>• Partial metering (approx. 6% of viewfinder at center)</li> <li>• Spot metering (approx. 1.8% of viewfinder at center)</li> <li>• Center-weighted average metering</li> </ul>
Brightness metering range:	EV 0 - 20 (at room temperature, ISO 100)
Exposure control:	Program AE (Scene Intelligent Auto, Program), Shutter-priority AE, Aperture-priority AE, Manual exposure, Bulb exposure
ISO speed: (Recommended exposure index)	Scene Intelligent Auto: ISO 100 - ISO 6400 set automatically P, Tv, Av, M, B: Auto ISO, ISO 100 - ISO 16000 (in 1/3- or whole-stop increments), or ISO expansion to H1 (equivalent to ISO 25600) or H2 (equivalent to ISO 51200)
ISO speed settings:	ISO speed range, Auto ISO range, and Auto ISO minimum shutter speed settable
Exposure compensation:	Manual: $\pm 5$ stops in 1/3- or 1/2-stop increments AEB: $\pm 3$ stops in 1/3- or 1/2-stop increments (can be combined with manual exposure compensation)

AE lock:	Auto: Applied in One-Shot AF mode with evaluative metering when focus is achieved Manual: By AE lock button
Interval timer:	Shooting interval and shot count settable
Bulb timer:	Bulb exposure time settable

### • HDR Shooting

Dynamic range adjustment:	Auto, $\pm 1$ , $\pm 2$ , $\pm 3$
Effects:	Natural, Art standard, Art vivid, Art bold, Art embossed
Auto image align:	Provided

### • Multiple Exposures

Shooting methods:	Function/control priority, Continuous shooting priority
Number of multiple exposures:	2 to 9 exposures
Multiple-exposure control:	Additive, Average, Bright, Dark

### • Shutter

Type:	Electronically-controlled, focal-plane shutter
Shutter speeds:	1/8000 sec. to 30 sec. (total shutter speed range; available range varies by shooting mode), Bulb, X-sync at 1/250 sec.

### • Drive System

Drive modes:	Single shooting, High-speed continuous shooting, Low-speed continuous shooting, Silent single shooting, Silent continuous shooting, 10-sec. self-timer/remote control, 2-sec. self-timer/remote control
Continuous shooting speed:	High-speed continuous shooting: Max. approx. 10.0 shots/sec. (settable to 10 to 2 shots/sec.) * Max. approx. 9.5 shots/sec. with EOS iTR AF. Low-speed continuous shooting: Approx. 3.0 shots/sec. (settable to 9 to 1 shots/sec.) Silent continuous shooting: Approx. 4.0 shots/sec. (settable to 4 to 1 shots/sec.)
Max. burst:	JPEG Large/Fine: Approx. 130 shots (approx. 1090 shots) RAW: Approx. 24 shots (approx. 31 shots) RAW+JPEG Large/Fine: Approx. 18 shots (approx. 19 shots) * Figures are based on Canon's testing standards (Aspect ratio: 3 x 2, ISO 100 and Standard Picture Style) and an 8 GB CF card. * Figures in parentheses apply to an UDMA mode 7, CF card based on Canon's testing standards.

## • Flash

Built-in flash:	Retractable, auto pop-up flash Guide number: Approx. 11/36.1 (ISO 100, in meters/feet) Flash coverage: Approx. 15mm lens angle of view Recycling time: Approx. 3 sec.
External Speedlite:	Compatible with EX-series Speedlites
Flash metering:	E-TTL II autoflash
Flash exposure compensation:	±3 stops in 1/3- or 1/2-stop increments
FE lock:	Provided
PC terminal:	Provided
Flash control:	Built-in flash function settings, External Speedlite function settings, External Speedlite Custom Function settings Wireless flash control via optical transmission possible

## • Live View Shooting

Focus methods:	Dual Pixel CMOS AF system/Contrast-detection AF system (Face+Tracking, FlexiZone-Multi, FlexiZone-Single), Manual focus (approx. 5x and 10x magnified view possible for focus check)
Continuous AF:	Provided
Focusing brightness range:	EV 0 - 18 (at room temperature, ISO 100)
Metering modes:	Evaluative metering (315 zones), Partial metering (approx. 10% of Live View screen), Spot metering (approx. 2.6% of Live View screen), Center-weighted average metering
Brightness metering range:	EV 0 - 20 (at room temperature, ISO 100)
Aspect ratio:	3:2, 4:3, 16:9, 1:1
Silent shooting:	Provided (Mode 1 and 2)
Grid display:	3 types

## • Movie Shooting

Recording format:	MOV/MP4
Movie:	MPEG-4 AVC / H.264 Variable (average) bit rate
Audio:	MOV: Linear PCM, MP4: AAC
Recording size and frame rate:	Full HD (1920x1080): 59.94p/50.00p/29.97p/25.00p/ 24.00p/23.98p HD (1280x720) : 59.94p/50.00p/29.97p/25.00p SD (640x480) : 29.97p/25.00p

## Specifications

- Compression method: ALL-I (For editing/I-only), IPB (Standard), IPB (Light)  
\* IPB (Light) is for MP4 only.
- File size: [MOV]
- Full HD (59.94p/50.00p)/IPB (Standard)  
: Approx. 440 MB/min.
  - Full HD (29.97p/25.00p/24.00p/23.98p)/ALL-I  
: Approx. 654 MB/min.
  - Full HD (29.97p/25.00p/24.00p/23.98p)/IPB (Standard)  
: Approx. 225 MB/min.
  - HD (59.94p/50.00p)/ALL-I : Approx. 583 MB/min.
  - HD (59.94p/50.00p)/IPB (Standard)  
: Approx. 196 MB/min.
  - SD (29.97p/25.00p)/IPB (Standard)  
: Approx. 75 MB/min.
- [MP4]
- Full HD (59.94p/50.00p)/IPB (Standard)  
: Approx. 431 MB/min.
  - Full HD (29.97p/25.00p/24.00p/23.98p)/ALL-I  
: Approx. 645 MB/min.
  - Full HD (29.97p/25.00p/24.00p/23.98p)/IPB (Standard)  
: Approx. 216 MB/min.
  - Full HD (29.97p/25.00p)/IPB (Light)  
: Approx. 87 MB/min.
  - HD (59.94p/50.00p)/ALL-I : Approx. 574 MB/min.
  - HD (59.94p/50.00p)/IPB (Standard)  
: Approx. 187 MB/min.
  - HD (29.97p/25.00p)/IPB (Light)  
: Approx. 30 MB/min.
  - SD (29.97p/25.00p)/IPB (Standard)  
: Approx. 66 MB/min.
  - SD (29.97p/25.00p)/IPB (Light)  
: Approx. 23 MB/min.
- Card requirements: [CF card]  
(Writing/reading speed) ALL-I: 30 MB/sec. or faster  
IPB (Standard), Full HD 59.94p/50.00p: 30 MB/sec. or faster  
IPB (Standard), other than above: 10 MB/sec. or faster  
IPB (Light): 10 MB/sec. or faster (MP4 only)



	[SD card]
	ALL-I: 20 MB/sec. or faster
	IPB (Standard), Full HD 59.94p/50.00p: 20 MB/sec. or faster
	IPB (Standard), other than above: 6 MB/sec. or faster
	IPB (Light): 4 MB/sec. or faster (MP4 only)
Focus methods:	Same as focusing with Live View shooting
	Movie Servo AF customizable
Metering modes:	Center-weighted average and Evaluative metering with the image sensor
	* Automatically set by the focus method.
Brightness metering range:	EV 0 - 20 (at room temperature, ISO 100)
Exposure control:	Autoexposure shooting (Program AE for movie shooting), Shutter-priority AE, Aperture-priority AE, Manual exposure
Exposure compensation:	±3 stops in 1/3-stop or 1/2-stop increments
ISO speed:	Scene Intelligent Auto, Tv: Automatically set within ISO 100 - ISO 16000
(Recommended exposure index)	P, Av, B: Automatically set within ISO 100 - ISO 16000, expandable to H1 (equivalent to ISO 25600)
	M: Auto ISO (automatically set within ISO 100 - ISO 16000), ISO 100 - ISO 16000 set manually (in 1/3- or whole-stop increments), expandable to H1 (equivalent to ISO 25600)
Time code:	Supported
Drop frames:	Compatible with 59.94p/29.97p
Sound recording:	Built-in monaural microphone, external stereo microphone terminal provided
	Sound-recording level adjustable, wind filter provided, attenuator provided
Headphones:	Headphone socket provided and volume adjustment possible
Grid display:	3 types
Still photo shooting:	Possible
	* Except when set to Full HD 59.94p/50.00p
2-screen display:	LCD monitor and HDMI output movie displayable simultaneously
HDMI output:	Movie without information display can also be output.
	* Auto/59.94i/50.00i/59.94p/50.00p/23.98p selectable

### • LCD Monitor

Type:	TFT color, liquid-crystal monitor
Monitor size and dots:	Wide 7.7 cm (3.0-in) (3:2) with approx. 1.04 million dots
Brightness adjustment:	Auto (Dark, Standard, Bright), Manual (7 levels)
Electronic level:	Provided
Interface languages:	25
Help display:	Possible

### • Playback

Image display formats:	Single-image display (without shooting information), Single-image display (with simple information), Single-image display (Shooting information displayed: Detailed information, Lens/histogram, White balance, Picture Style, Color space/noise reduction, Lens aberration correction, GPS), Index display (4/9/36/100 images), Two-image display
Highlight alert:	Overexposed highlights blink
AF point display:	Provided
Grid display:	3 types
Magnified view:	Approx. 1.5x-10x, initial magnification and position settable
Image browsing methods:	Single image, Jump by 10 or 100 images, By shooting date, By folder, By movies, By stills, By protected images, By rating
Image rotation:	Provided
Rating:	Provided
Movie playback:	Enabled (LCD monitor, HDMI) Built-in speaker
Slide show:	All images, By date, By folder, By movies, By stills, By protected images, By rating
Image protection:	Possible
Copying images:	Possible

### • Post-Processing of Images

In-camera RAW image processing:	Brightness correction, White balance, Picture Style, Auto Lighting Optimizer, High ISO speed noise reduction, JPEG image-recording quality, Color space, Peripheral illumination correction, Distortion correction, Chromatic aberration correction
Resize:	Provided

### • Direct Printing

Compatible printers:	PictBridge-compatible printers
Printable images:	JPEG and RAW images
Print ordering:	DPOF Version 1.1 compliant

### • Image Transfer

Transferrable files:	Still photos (JPEG, RAW, RAW+JPEG images), Movies
----------------------	---

### • GPS Function

Compatible satellites:	GPS satellites (USA), GLONASS satellites (Russia), Quasi-Zenith Satellite System (QZSS) "MICHIBIKI" (Japan)
Geotag information appended to image:	Latitude, Longitude, Elevation, Direction, Coordinated Universal Time (UTC), satellite signal condition
Geotag updating interval:	1 sec., 5 sec., 10 sec., 15 sec., 30 sec., 1 min., 2 min., 5 min.
Time setting:	GPS time data set to camera
Digital compass:	Three-axis geomagnetic sensor and three-axis accelerometer sensor used for orientation sensing
Log data:	One file per day, NMEA format * Changing the time zone creates another file. * The log data saved in internal memory as a log file can be transferred to a card or downloaded to a computer.
Log data deletion:	Possible

### • Custom Functions

Custom Functions:	19
My Menu:	Up to 5 screens can be registered
Custom shooting modes:	Register under Mode Dial's C1, C2, or C3
Copyright information:	Text entry and inclusion enabled

### • Interface

DIGITAL terminal:	SuperSpeed USB (USB 3.0) Computer communication, direct printing, Wireless File Transmitter WFT-E7 (Ver. 2) connection
HDMI mini OUT terminal:	Type C (Auto switching of resolution), CEC-compatible
External microphone IN terminal:	3.5 mm diameter stereo mini-jack
Headphone terminal:	3.5 mm diameter stereo mini-jack
Remote control terminal:	For N3-type remote control units
Wireless remote control:	Compatible with Remote Controller RC-6
Eye-Fi card:	Supported

## • Power

Battery:	Battery Pack LP-E6N/LP-E6, quantity 1 * AC power usable with household power outlet accessories. * With Battery Grip BG-E16 attached, size-AA/LR6 batteries can be used.
Battery information:	Remaining capacity, Shutter count, Recharge performance, and Battery registration possible
Number of possible shots (Based on CIPA testing standards):	With viewfinder shooting: Approx. 670 shots at 23°C/73°F, approx. 640 shots at 0°C/32°F With Live View shooting: Approx. 250 shots at 23°C/73°F, approx. 240 shots at 0°C/32°F
Movie shooting time:	Approx. 1 hr. 40 min. at 23°C/73°F Approx. 1 hr. 30 min. at 0°C/32°F * With a fully-charged Battery Pack LP-E6N.

## • Dimensions and Weight

Dimensions (W x H x D):	Approx. 148.6 x 112.4 x 78.2 mm / 5.85 x 4.43 x 3.08 in.
Weight:	Approx. 910 g / 32.10 oz. (Including battery, CF card, SD memory card) Approx. 820 g / 28.92 oz. (Body only)

## • Operation Environment

Working temperature range:	0°C - 40°C / 32°F - 104°F
Working humidity:	85% or less

- For the specifications of the Wi-Fi Adapter W-E1, refer to “Wi-Fi Adapter W-E1 Preliminary Notes and Legal Information” (p.4).
- All the data above is based on Canon’s testing standards and CIPA (Camera & Imaging Products Association) testing standards and guidelines.
- Dimensions, maximum diameter, length and weight listed above are based on CIPA Guidelines (except weight for camera body only).
- Product specifications and the exterior are subject to change without notice.
- If a problem occurs with a non-Canon lens attached to the camera, consult the respective lens manufacturer.





## Trademarks

- Adobe is a trademark of Adobe Systems Incorporated.
- Microsoft and Windows are trademarks or registered trademarks of Microsoft Corporation in the United States and/or other countries.
- Macintosh and Mac OS are trademarks of Apple Inc., registered in the U.S. and other countries.
- CompactFlash is a trademark of SanDisk Corporation.
- SDXC logo is a trademark of SD-3C, LLC.
- HDMI, HDMI logo, and High-Definition Multimedia Interface are trademarks or registered trademarks of HDMI Licensing LLC.
- Google™, Google Maps™, and Google Earth™ are trademarks of Google Inc.
- Map Utility uses Google Maps™ to display images and routes traveled on a map.
- All other trademarks are the property of their respective owners.

## About MPEG-4 Licensing

"This product is licensed under AT&T patents for the MPEG-4 standard and may be used for encoding MPEG-4 compliant video and/or decoding MPEG-4 compliant video that was encoded only (1) for a personal and non-commercial purpose or (2) by a video provider licensed under the AT&T patents to provide MPEG-4 compliant video. No license is granted or implied for any other use for MPEG-4 standard."

\* Notice displayed in English as required.

## Use of Genuine Canon Accessories Is Recommended

This product is designed to achieve excellent performance when used with genuine Canon accessories.

Canon shall not be liable for any damage to this product and/or accidents such as fire, etc., caused by the malfunction of non-genuine Canon accessories (e.g., a leakage and/or explosion of a battery pack). Please note that this warranty does not apply to repairs arising out of the malfunction of non-genuine Canon accessories, although you may request such repairs on a chargeable basis.

-  Battery Pack LP-E6N/LP-E6 is dedicated to Canon products only. Using it with an incompatible battery charger or product may result in malfunction or accidents for which Canon cannot be held liable.



# Safety Precautions

The following precautions are provided to prevent harm or injury to yourself and others. Make sure to thoroughly understand and follow these precautions before using the product.

**If you experience any malfunctions, problems, or damage to the product, contact the nearest Canon Service Center or the dealer from whom you purchased the product.**



**Warnings:** Follow the warnings below. Otherwise, death or serious injuries may result.

- To prevent fire, excessive heat, chemical leakage, explosions, and electrical shock, follow the safeguards below:
  - Do not use any batteries, power sources, or accessories not specified in the Instruction Manual. Do not use any home-made or modified batteries.
  - Do not short-circuit, disassemble, or modify the battery. Do not apply heat or solder to the battery. Do not expose the battery to fire or water. Do not subject the battery to strong physical shock.
  - Do not insert the battery's plus and minus ends incorrectly.
  - Do not recharge the battery in temperatures outside the allowable ambient temperature range. Also, do not exceed the recharging time indicated in the Instruction Manual.
  - Do not insert any foreign metallic objects into the electrical contacts of the camera, accessories, connecting cables, etc.
- When disposing of a battery, insulate the electrical contacts with tape to prevent contact with other metallic objects or batteries. This is to prevent a fire or an explosion.
- If excessive heat, smoke, or fumes are emitted when recharging the battery, immediately unplug the battery charger from the power outlet to stop recharging. Otherwise, it may cause a fire, heat damage, or electrical shock.
- If the battery leaks, changes color, deforms, or emits smoke or fumes, remove it immediately. Be careful not to get burned in the process. It may cause a fire, electrical shock or skin burn if you keep using it.
- Prevent any battery leakage from contacting your eyes, skin, and clothing. It can cause blindness or skin problems. If the battery leakage contacts your eyes, skin, or clothing, flush the affected area with lots of clean water without rubbing it. See a physician immediately.
- Do not leave any cords near a heat source. It can deform the cord or melt the insulation and cause a fire or electrical shock.
- Do not hold the camera in the same position for long periods of time. Even if the camera does not feel too hot, prolonged contact with the same body part may cause skin redness, blistering or low-temperature contact burns. Using a tripod is recommended for people with circulation problems or very sensitive skin, or when using the camera in very hot places.
- Do not fire the flash at anyone driving a car or other vehicle. It may cause an accident.

- When the camera or accessories are not in use, make sure to remove the battery and disconnect the power plug from the equipment before storing. This is to prevent electrical shock, excessive heat, fire, or corrosion.
- Do not use the equipment where there is flammable gas. This is to prevent an explosion or a fire.
- If you drop the equipment and the casing breaks open to expose the internal parts, do not touch the internal parts. There is a possibility of an electrical shock.
- Do not disassemble or modify the equipment. High-voltage internal parts can cause electrical shock.
- Do not look at the sun or an extremely bright light source through the camera or lens. Doing so may damage your vision.
- Keep equipment out of the reach of children and infants, including when in use. Straps or cords may accidentally cause choking, electrical shock, or injury. Choking or injury may also occur if a child or infant accidentally swallows a camera part or accessory. If a child or infant swallows a part or accessory, consult a physician immediately.
- Do not use or store the equipment in dusty or humid places. Likewise, store the battery with its protective cover attached to prevent short-circuit. This is to prevent a fire, excessive heat, electrical shock, or burn.
- Before using the camera inside an airplane or hospital, check if it is allowed. Electromagnetic waves emitted by the camera may interfere with the plane's instruments or the hospital's medical equipment.
- To prevent a fire and electrical shock, follow the safeguards below:
  - Always insert the power plug all the way in.
  - Do not handle a power plug with wet hands.
  - When unplugging a power plug, grasp and pull the plug instead of the cord.
  - Do not scratch, cut, or excessively bend the cord or put a heavy object on the cord. Also do not twist or tie the cords.
  - Do not connect too many power plugs to the same power outlet.
  - Do not use a cord whose wire is broken or insulation is damaged.
- Unplug the power plug periodically and clean off the dust around the power outlet with a dry cloth. If the surrounding is dusty, humid, or oily, the dust on the power outlet may become moist and short-circuit the outlet, causing a fire.
- Do not connect the battery directly to an electrical outlet or a car's cigarette lighter outlet. The battery may leak, generate excessive heat or explode, causing a fire, burns or injuries.
- A thorough explanation of how to use the product by an adult is required when the product is used by children. Supervise children while they are using the product. Incorrect usage may result in electrical shock or injury.
- Do not leave a lens or lens-attached camera in the sun without the lens cap attached. Otherwise, the lens may concentrate the sun's rays and cause a fire.
- Do not cover or wrap the product with a cloth. Doing so may trap heat within and cause the casing to deform or catch fire.
- Be careful not to get the camera wet. If you drop the product in the water or if water or metal get inside the product, promptly remove the battery. This is to prevent a fire and an electrical shock.
- Do not use paint thinner, benzene, or other organic solvents to clean the product. Doing so may cause fire or a health hazard.

**Cautions:** Follow the cautions below. Otherwise, physical injury or property damage may result.

- Do not use or store the product inside a car under the hot sun or near a heat source. The product may become hot and cause skin burns. Doing so may also cause battery leakage or explosion, which will degrade the performance or shorten the life of the product.
- Do not carry the camera around when it is attached to a tripod. Doing so may cause injury. Also make sure the tripod is sturdy enough to support the camera and lens.
- Do not leave the product in a low-temperature environment for an extended period of time. The product will become cold and may cause injury when touched.
- Do not fire the flash near the eyes. It may hurt the eyes.
- Never play the provided CD-ROM in a drive that is not compatible with the CD-ROM. If you use it in a music CD player, you may damage the speakers and other components. When using headphones, there is also a risk of injury to your ears from excessively loud volume.



**Only for European Union and EEA (Norway, Iceland and Liechtenstein)**

These symbols indicate that this product is not to be disposed of with your household waste, according to the WEEE Directive (2012/19/EU), the Battery Directive (2006/66/EC) and/or national legislation implementing those Directives.

If a chemical symbol is printed beneath the symbol shown above, in accordance with the Battery

Directive, this indicates that a heavy metal (Hg = Mercury, Cd = Cadmium, Pb = Lead) is present in this battery or accumulator at a concentration above an applicable threshold specified in the Battery Directive.

This product should be handed over to a designated collection point, e.g., on an authorized one-for-one basis when you buy a new similar product or to an authorized collection site for recycling waste electrical and electronic equipment (EEE) and batteries and accumulators. Improper handling of this type of waste could have a possible impact on the environment and human health due to potentially hazardous substances that are generally associated with EEE. Your cooperation in the correct disposal of this product will contribute to the effective usage of natural resources.

For more information about the recycling of this product, please contact your local city office, waste authority, approved scheme or your household waste disposal service or visit [www.canon-europe.com/weee](http://www.canon-europe.com/weee), or [www.canon-europe.com/battery](http://www.canon-europe.com/battery).

**CAUTION**

RISK OF EXPLOSION IF BATTERY IS REPLACED BY AN INCORRECT TYPE.  
DISPOSE OF USED BATTERIES ACCORDING TO LOCAL REGULATION.

# Handling Precautions

## LCD Panel and LCD Monitor

- Although the LCD monitor is manufactured with very high precision technology with over 99.99% effective pixels, there may be a few dead pixels displaying only black or red, etc. among the remaining 0.01% or less pixels. Dead pixels are not a malfunction. They do not affect the images recorded.
- If the LCD monitor is left on for a prolonged period, screen burn-in may occur where you see remnants of what was displayed. However, this is only temporary and will disappear when the camera is left unused for a few days.
- The LCD monitor display may seem slow in low temperatures, or look black in high temperatures. It will return to normal at room temperature.

## Cards

To protect the card and its recorded data, note the following:

- Do not drop, bend, or wet the card. Do not subject it to excessive force, physical shock, or vibration.
- Do not touch the card's electronic contacts with your fingers or anything metallic.
- Do not affix any stickers, etc., on the card.
- Do not store or use the card near anything that has a strong magnetic field, such as a TV set, speakers, or magnet. Also avoid places prone to having static electricity.
- Do not leave the card in direct sunlight or near a heat source.
- Store the card in a case.
- Do not store the card in hot, dusty, or humid locations.

## Lens

After detaching the lens from the camera, put down the lens with the rear end up and attach the lens caps to avoid scratching the lens surface and electrical contacts.

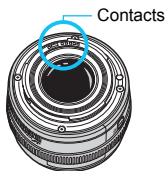



# 16

## Downloading Images to a Computer / Software

This chapter explains how to transfer images from the camera to a computer, gives an overview of the software on the EOS Solution Disk (CD-ROM), and explains how to install the software on a computer.



**EOS Solution Disk**  
(Software)

# Downloading Images to a Computer

You can use EOS software to download the images in the camera to your computer. There are two ways to do this.

## Downloading by Connecting the Camera to the Computer

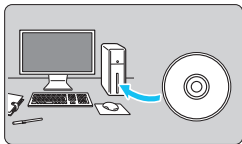

### 1 Install the software (p.536).

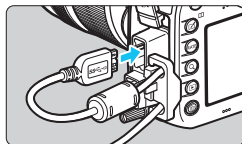

### 2 Use the provided interface cable to connect the camera to your computer.

- Use the interface cable provided with the camera.
- When connecting the cable to the camera, use the cable protector (p.34). Connect the cable to the digital terminal with the plug's <math>\langle SS \leftarrow \rightarrow \infty \rangle</math> icon facing the back of the camera.
- Connect the cord's plug to the computer's USB terminal.

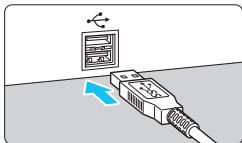

### 3 Use EOS Utility to transfer the images.

- For details, refer to the EOS Utility Instruction Manual.

 Use the provided interface cable or one from Canon (p.478). When connecting the interface cable, use the provided cable protector (p.34).



## Downloading Images with a Card Reader

You can use a card reader to download images to your computer.

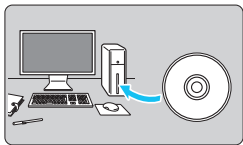

**1** Install the software (p.536).

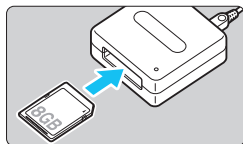

**2** Insert the card into the card reader.

**3** Use Digital Photo Professional to download the images.

- For details, refer to the Digital Photo Professional Instruction Manual.



When downloading images from the camera to your computer with a card reader without using EOS software, copy the DCIM folder on the card to your computer.

# About the Software



## EOS Solution Disk

This disk contains various software for EOS cameras.

Note that the software provided with previous cameras might not support still photos and movie files shot with this camera. Please use the software provided with this camera.

### 1 EOS Utility

Communication Software for the Camera and Computer

- You can download images (still images/movies) you have shot with the camera to your computer.
- You can set the various settings of the camera from your computer.
- You can shoot photos remotely by connecting the camera to your computer.

### 2 Digital Photo Professional

Image Viewing and Editing Software

- You can edit images with originals remaining unchanged.
  - Can be used by a wide range of users from amateurs to professionals. It is especially recommended for users who mainly shoot RAW images.
- \* Certain functions differ between the version to be installed on a 64-bit computer and that to be installed on a 32-bit computer.

### 3 Picture Style Editor

Picture Style File Creating Software

- This software is aimed at advanced users who are experienced in image processing.
- You can edit Picture Style to your unique image characteristics and create/save an original Picture Style file.

### 4 Map Utility

Shooting locations can be displayed on a map on a computer screen by using the geotag location information recorded. Note that Internet connection is required to install and use Map Utility.

- **Downloading from the Canon website**

You can download the following software and Software Instruction Manuals from the Canon website.

**[www.canon.com/icpd](http://www.canon.com/icpd)**

### **EOS MOVIE Utility**

This software enables you to play back the movies you shot, consecutively play back movie files that were split up, and merge the split movie files and save it as a single file. You can also grab movie frames and save them as still photos.

# Installing the Software

## Installing the Software on Windows

Compatible OS

Windows 8.1

Windows 8

Windows 7

-  **Do not connect the camera to your computer before you install the software. The software will not be installed correctly.**
- If there is a previous version of the software already installed on your computer, follow the procedure below to install the latest version. (The previous version will be overwritten.)

- 1 Insert the EOS Solution Disk into the computer.
- 2 Click [**Easy Installation**] and follow the on-screen instructions to install.
- 3 After the software is installed, remove the CD-ROM.

## Installing the Software on the Macintosh

Compatible OS

MAC OS X 10.8 - 10.9



- **Do not connect the camera to your computer before you install the software. The software will not be installed correctly.**
- If there is a previous version of the software already installed on your computer, follow the procedure below to install the latest version. (The previous version will be overwritten.)

1

Insert the EOS Solution Disk into the computer.

- On your computer's desktop, double-click and open the CD-ROM icon, and then double-click **[setup]**.

2

Click **[Easy Installation]** and follow the on-screen instructions to install.

3

After the software is installed, remove the CD-ROM.

# Index

<b>Numerics</b>	
10- or 2-sec. self-timer.....	143
1280x720 (movie).....	331
1920x1080 (movie).....	331
24.00p.....	333
640x480 (movie).....	331
65-point automatic selection AF ...	91, 97
<b>A</b>	
 (Scene Intelligent Auto).....	80
AC Adapter .....	474
Acceleration/deceleration tracking .....	114
Access lamp .....	43, 44
Accessories .....	3
Adobe RGB.....	187
AE lock.....	229
AEB (Auto Exposure Bracketing)....	227, 434
AF .....	85
AF area selection lever.....	58
AF area selection mode .....	90, 92
AF-assist beam .....	89, 120
AF Configuration Tool.....	108
AF group.....	100
AF method.....	299, 343
AF Microadjustment .....	133
AF-ON (AF start) button .....	55, 446, 448
AF operation.....	86
AF point.....	90, 93, 95, 99
AF point expansion.....	90, 95
AF point registration .....	450
AF point selection.....	93, 453
Beeper.....	69
Color information .....	128
Customization.....	117
f/8 AF.....	99, 103
Facial information .....	128
Manual focusing (MF).....	140, 308
Out of focus .....	53, 54, 498
Recomposing .....	83
Subjects difficult to focus .....	139, 306
AI FOCUS (AI Focus AF).....	88
AI SERVO (AI Servo AF) .....	88
Acceleration/deceleration tracking .....	114
AF Operation indicator.....	89, 131
AF point auto switching.....	115
AF points light up in red .....	89, 131
AF sensor .....	99
Tracking sensitivity.....	113
ALL-I (For editing/I-only) .....	332
Ambient light sensor.....	24, 394
Anti-flicker shooting.....	185
Aperture-priority AE.....	220, 316
Area AF frame .....	91, 97
Aspect ratio .....	295
Attenuator.....	336
Audio/video output .....	385
Auto Lighting Optimizer.....	79, 175
Auto playback.....	382
Auto power off.....	45, 69
Auto reset.....	194
Auto rotation.....	395
Auto switch card.....	147
Auto time setting .....	209
Autofocus → AF Automatic selection (AF).....	91, 97
Av (Aperture-priority AE) .....	220, 316
A/V OUT (Audio/video output).....	376
<b>B</b>	
B (Bulb) .....	230, 314
Battery.....	38, 40, 46, 470
Battery Grip .....	46, 478
Beeper.....	69
Black-and-white images .....	162, 165
Bracketing .....	173, 227
Bulb exposures .....	230
Bulb timer.....	231
BUSY .....	153

**C**

 (Custom shooting) .....	464
Cable .....	3, 385, 412, 425, 478, 532
Protector .....	34
Camera	
Camera shake .....	53, 54, 246
Clearing the camera settings .....	70
Holding the camera .....	54
Settings display .....	468
Cards .....	5, 41, 67, 529
Card reminder .....	42
Formatting .....	67
Low-level formatting .....	68
Troubleshooting .....	44, 68
Write protection .....	41
Case .....	108
Center-weighted average metering .....	225
CF card → Cards	
Charger .....	32, 38
Chromatic aberration correction .....	182
Cleaning (image sensor) .....	405
Clearing the camera settings .....	70
CLn .....	409
Color space .....	187
Color temperature .....	168, 171
Color tone .....	164
Continuous AF .....	294
Continuous file numbering .....	193
Continuous shooting .....	141
Contrast .....	164, 175
Coordinated Universal Time .....	198
Copyright information .....	195
Creative photo .....	160, 233, 238
★ (Creative Zone) icon .....	8
Cropping (for printing) .....	419
Cropping information .....	443
Cross-type focusing .....	99
Custom Controls .....	62, 445
Custom shooting mode .....	464

Custom WB .....	169
-----------------	-----

**D**

D+ .....	180
Date/time .....	47
Daylight saving time .....	48
Depth-of-field preview .....	221
Detailed information .....	357
Dials	
Main Dial .....	56
Quick Control Dial .....	57
Digital compass .....	206
Calibration .....	207
Digital terminal .....	23, 34, 412, 425, 532
Dimmed menu items .....	66
Dioptric adjustment .....	54
Direct printing .....	412
Direct selection of AF point .....	453
Direction .....	204, 206
Distortion correction .....	182
Downloading images (to a computer) .....	532
DPOF (Digital Print Order Format) .....	421
Drive mode .....	141
Dual cross-type focusing .....	99
Dust Delete Data .....	407

**E**

Electronic level .....	75
Erasing images .....	392
Err .....	25, 510
Error codes .....	510
Evaluative metering .....	224
ExFAT .....	68
Exposure compensation .....	226
Exposure compensation with Auto ISO .....	223
Exposure level increments .....	434
Exposure level indicator .....	26, 27, 288, 323



- Exposure simulation .....296
- External Speedlite → Flash
- Eyecup.....247
- Eye-Fi cards.....475
- Eyepiece cover .....33, 247
- F**
- FE lock.....258, 259
- Feature guide.....78
- FEB.....269
- File extension.....192
- File name .....190
- File size.....151, 334, 357
- Filter effects .....165
- Final image simulation .....291, 326
- Fine (image-recording quality) .....149, 151
- Firmware version .....491
- First-curtain synchronization.....269
- Flash (Speedlite).....253
  - Built-in flash.....254
  - Custom Functions .....271
  - Effective range .....255
  - External flash.....259
  - FE lock .....258, 259
  - Flash control.....262
  - Flash exposure compensation .....257, 259, 269
  - Flash mode.....267
  - Flash sync contacts.....22
  - Flash sync speed .....260, 263
  - Flash sync. speed in Av mode .....263
  - Manual flash.....267, 283
  - Red-eye reduction .....256
  - Shutter synchronization (1st/2nd curtain) .....269
  - Wireless.....268, 272
- Focus indicator .....80
- Focus lock.....83
- Focus mode switch.....50, 140, 308
- Focusing → AF, Manual Focusing (MF)
- Focusing screen.....440, 478
- Folder creation/selection .....188
- For editing (ALL-I) .....332
- Formatting (card initialization).....67
- Frame rate.....331, 350
- Free run.....339
- Full Auto mode .....80
- Full High-Definition (Full HD).....313, 331
- Function availability by shooting mode.....480
- G**
- GPS.....197
- Grid .....74, 295, 344, 355
- H**
- HD .....331
- HDMI .....34, 341, 348, 350, 385
- HDMI CEC .....386
- HDR .....233
- Headphones .....337
- Help.....78
- High ISO speed noise reduction ...176
- High-Definition (HD) movies.....331
- Highlight alert .....359
- Highlight detail loss .....359
- Highlight tone priority .....180
- High-speed continuous shooting ...141
- Histogram (Brightness/RGB).....360
- Hot shoe .....22, 259
- Household power .....474
- I**
- ICC profile .....187
- Icon .....8
- Illumination (AF point) .....131
- Illumination (LCD panel).....60
- Image conversion factor.....50



- Image dust prevention .....405
  - Image-recording quality ..... 149, 330
  - Image review time .....70
  - Image Stabilizer (lens) .....53
  - Images
    - AF point display .....359
    - Auto playback .....382
    - Auto rotation .....395
    - Copying .....388
    - Downloading images
      - (to a computer) .....532
    - Erase .....392
    - Highlight alert.....359
    - Histogram .....360
    - Index.....361
    - Jump display
      - (image browsing).....362
    - Magnification .....364
    - Manual rotation.....367
    - Numbering .....193
    - Playback .....353
    - Protection .....368
    - Rating .....371
    - Shooting information.....356
    - Size..... 151, 334, 357
    - Slide show .....382
    - Transfer .....425
    - Two-image display.....366
    - Viewing on a TV set.....376, 385
  - Index display .....361
  - INFO. button ...60, 288, 323, 354, 468
  - Initial AF Point.....127
  - Interval timer .....250
  - IPB (Light/Standard).....332
  - ISO speed ..... 154, 317, 321
    - Automatic setting (Auto) .....156
    - Automatic setting range.....158
    - ISO expansion .....157
    - Manual setting range .....157
    - Minimum shutter speed .....159
    - Setting increments.....434
  - ITR AF.....128
- J**
- JPEG ..... 149, 151
  - Jump display ..... 362
- L**
- Language ..... 49
  - Large (image-recording quality) ... 151
  - Large Zone AF ..... 91, 97
  - LCD monitor ..... 529
    - Brightness adjustment ..... 394
    - Electronic level..... 75
    - Image playback..... 353
    - Menu display..... 64, 484
    - Shooting function settings ... 60, 469
  - LCD panel ..... 25
  - Lens..... 30, 50
    - Chromatic aberration
      - correction ..... 182
    - Distortion correction ..... 182
    - Image Stabilizer ..... 53
    - Lock release..... 51
    - Peripheral illumination
      - correction ..... 181
  - Lens group ..... 100
  - Lens hood..... 52
  - Light (IPB) ..... 332
  - Live View shooting ..... 84, 285
    - Aspect ratio ..... 295
    - Exposure simulation..... 296
    - Face+Tracking ..... 300
    - FlexiZone - Multi ..... 302
    - FlexiZone - Single ..... 304
    - Grid display..... 295
    - Information display..... 288
    - Manual focusing (MF) ..... 308
    - Metering timer ..... 298
    - Possible shots ..... 287
    - Quick Control ..... 293
    - Silent shooting ..... 297
  - LOCK..... 59
  - LOG ..... 210
  - Logging..... 210

- Log data ..... 211
- Long exposure noise reduction..... 178
- Long exposures ..... 230
- Low-speed continuous shooting ... 141
- M**
- M (Manual exposure)..... 222, 320
- Magnification..... 305, 308, 364
  - Start position..... 365
- Main Dial..... 56
- Malfunction ..... 495
- Manual exposure ..... 222, 320
- Manual focusing (MF) ..... 140, 308
- Manual reset..... 194
- Manual selection (AF)..... 90, 93, 95
- Maximum burst ..... 151, 153
- Medium
  - (image-recording quality) ..... 151, 403
- Memory cards → Cards
- Menu..... 64
  - My Menu..... 459
    - Setting procedure ..... 65
    - Settings ..... 484
- MENU** icon ..... 8
- Metering mode ..... 224
- Metering timer..... 55, 298, 347
- M-Fn ..... 92, 125, 258
- Microadjustment ..... 133
- Microphone ..... 314, 337
- Mirror lockup ..... 246
- Mode Dial..... 29, 56
- Monochrome images ..... 162, 165
- MOV..... 330
- Movies ..... 313
  - AE lock ..... 318
  - AF method..... 343
  - AF mode..... 329
  - AI SERVO (AI Servo AF)..... 342
  - Aperture-priority AE..... 316
  - Attenuator..... 336
  - Autoexposure shooting..... 314
  - Compression method..... 332
  - Drop frame..... 341
  - Editing out first and last
    - scenes ..... 380
  - Enjoying movies..... 376
  - File size..... 334, 335
  - Frame rate ..... 331
  - Free run ..... 339
  - Grid ..... 344
  - HDMI output..... 348
  - Headphones ..... 337
  - Information display..... 323
  - Manual exposure shooting..... 320
  - Metering timer ..... 347
  - Microphone ..... 314, 337
  - Movie recording size..... 331
  - Movie Servo AF speed ..... 345
  - Movie Servo AF tracking
    - sensitivity ..... 346
  - Movie shooting button..... 348
  - Playback ..... 376, 378
  - Quick Control ..... 329
  - Rec run ..... 339
  - Record command ..... 341
  - Recording time..... 334
  - Recording/playback count ..... 340
  - Shutter-priority AE ..... 315
  - Silent control ..... 338
  - Silent shooting ..... 347
  - Sound recording ..... 336
  - Stills ..... 327
  - Time code ..... 339
  - Viewing on a TV set..... 376, 385
  - Wind filter ..... 336
- MP4..... 330
- M-RAW
  - (Medium RAW)..... 149, 151, 152
- Multi function lock..... 59, 442
- Multi Shot Noise Reduction ..... 176
- Multi-controller..... 58
- Multiple exposures ..... 238
- My Menu ..... 459

- N**
- Noise reduction
    - High ISO speed .....176
    - Long exposures .....178
  - Nomenclature.....22
  - Non-Canon flash units .....260
  - Normal
    - (image-recording quality) .....149, 151
  - NTSC .....331, 385, 491
- O**
- ONE SHOT (One-Shot AF).....87
  - One-Shot AF .....87
  - One-touch image
    - quality setting .....153, 456
- P**
- P (Program AE).....216, 314
  - PAL .....331, 385, 491
  - Partial metering.....224
  - PC terminal .....260
  - Peripheral illumination correction ...181
  - Personal white balance.....171
  - Photobook set-up.....429
  - PictBridge.....411
  - Picture Style.....160, 163, 166
  - Pixels .....149, 151
  - Playback .....353
  - Possible shots .....46, 151, 287
  - Power.....45
    - Auto power off .....45, 69
    - Battery check.....46, 470
    - Battery information .....470
    - Household power.....474
    - Possible shots .....46, 151, 287
    - Recharge performance .....470
    - Recharging .....38
  - Pressing completely.....55
  - Pressing halfway.....55
  - Printing.....411
    - Cropping.....419
    - Page layout.....415
  - Paper settings .....415
  - Photobook set-up.....429
  - Print order (DPOF).....421
  - Printing effects .....416
  - Tilt correction.....419
  - Program AE.....216, 314
    - Program shift.....217
  - Protecting images.....368
- Q**
-  (Quick Control)...61, 293, 329, 374
  - Quick Control Dial .....57
- R**
- Rating mark .....371
  - RAW .....149, 151, 152
  - RAW image processing .....398
  - RAW+JPEG.....149, 151
  - Rec run.....339
  - Recharging.....38
  - Record function .....146
  - Record separately .....147
  - Record to multiple .....147
  - Recording level.....336
  - Red-eye reduction .....256
  - Reduced display.....361
  - Release shutter without card.....42
  - Remote control shooting .....248
  - Remote switch.....248
  - Resizing.....403
  - Rotation (image).....367, 395, 419
- S**
- Safety precautions.....525
  - Safety shift.....436
  - Saturation .....164
  - Scene icons .....290, 319
  - Scene Intelligent Auto .....80
  - SD, SDHC, SDXC cards → Cards
  - Second-curtain synchronization ...269
  - Self-timer .....143, 249
  - Sensor cleaning.....405

Sepia (Monochrome) ..... 165  
 Sharpness ..... 164  
 Shooting function settings ..... 60, 469  
 Shooting information display ..... 356  
 Shooting modes ..... 29, 60  
   Av (Aperture-priority AE) ..... 220  
   B (Bulb) ..... 230  
    (Custom shooting) ..... 464  
   M (Manual exposure) ..... 222  
   P (Program AE) ..... 216  
   Tv (Shutter-priority AE) ..... 218  
    (Scene Intelligent Auto) ..... 80  
 Shooting orientation registration ..... 125  
 Shutter button ..... 55  
 Shutter synchronization ..... 269  
 Shutter-priority AE ..... 218, 315  
 Silent shooting  
   Silent continuous shooting ..... 141  
   Silent LV shooting ..... 297, 347  
   Silent single shooting ..... 141  
 Single shooting ..... 141  
 Single-image display ..... 354  
 Single-point AF ..... 90, 95  
 Single-point Spot AF ..... 90, 95  
 Slide show ..... 382  
 Small  
 (image-recording quality) ..... 151, 403  
 Software ..... 534  
 Speaker ..... 24, 378  
 Spot AF ..... 90, 95  
 Spot metering ..... 225  
 S-RAW (Small RAW) ..... 149, 151, 152  
 SRGB ..... 187  
 Standard (IPB) ..... 332  
 Strap ..... 33  
 System map ..... 478

**T**

Temperature warning ..... 310, 351  
 Time code ..... 339  
 Time zone ..... 47

Tone priority ..... 180  
 Toning effect (Monochrome) ..... 165  
 Touch pad ..... 59, 338  
 Tracking sensitivity ..... 108  
 Tripod socket ..... 24  
 Tv (Shutter-priority AE) ..... 218, 315  
 Two-image display ..... 366

**U**

Ultra DMA (UDMA) ..... 42  
 Underscore " \_ " ..... 187, 192  
 USB (DIGITAL)  
   terminal ..... 412, 425, 532  
 UTC ..... 198

**V**

Video system ..... 330  
 Viewfinder ..... 27  
   Dioptic adjustment ..... 54  
   Electronic level ..... 76  
   Grid ..... 74  
   Information display ..... 77  
 Viewing on a TV set ..... 376, 385  
 Volume (movie playback) ..... 379

**W**

Warning icon ..... 441  
 White balance (WB) ..... 168  
   Bracketing ..... 173  
   Color temperature setting ..... 171  
   Correction ..... 172  
   Custom ..... 169  
   Personal ..... 170  
 Wi-Fi Adapter W-E1 ..... 3, 4, 19, 36  
 Wind filter ..... 336  
 Wireless flash shooting ..... 272

**Z**

Zone AF ..... 91, 96





**CANON INC.**

30-2 Shimomaruko 3-chome, Ohta-ku, Tokyo 146-8501, Japan

*Europe, Africa & Middle East*

**CANON EUROPA N.V.**

Bovenkerkerweg 59, 1185 XB Amstelveen, The Netherlands

---

For your local Canon office, please refer to your warranty card or to [www.canon-europe.com/Support](http://www.canon-europe.com/Support)

The product and associated warranty are provided in European countries by Canon Europa N.V.

The descriptions in this Instruction Manual are current as of February 2017. For information on the compatibility with any products introduced after this date, contact any Canon Service Center. For the latest version Instruction Manual, refer to the Canon website.