

Canon

EOS-1D X Mark III



Advanced User Guide

E

Contents

Introduction.	8
Package Contents.	9
Instruction Manuals.	11
Quick Start Guide.	12
About This Guide.	15
Compatible Cards.	17
Safety Instructions.	18
Handling Precautions.	21
Part Names.	24
Software.	47
Preparation and Basic Operations.	51
Charging the Battery.	52
Inserting/Removing Batteries.	56
Inserting/Removing Cards.	59
Turning on the Power.	64
Attaching/Detaching Lenses.	68
Basic Operations.	72
Menu Operations and Settings.	90
Quick Control.	95
Touch-Screen Operation.	98
Shooting Mode.	101
P: Program AE.	102
Tv: Shutter-priority AE.	106
Av: Aperture-priority AE.	109
M: Manual Exposure.	113
bulb: Long (Bulb) Exposures.	116
Shooting and Recording.	118
Still Photo Shooting.	119
Tab Menus: Still Photo Shooting (Viewfinder Shooting).	120
White Balance.	123

Custom White Balance.	129
White Balance Correction.	139
Color Space.	143
Picture Style Selection.	144
Picture Style Customization.	148
Picture Style Registration.	152
Clarity.	155
Lens Aberration Correction.	156
Image Quality.	162
ISO Speed Settings for Still Photos.	171
Auto Lighting Optimizer.	179
Long Exposure Noise Reduction.	181
High ISO Speed Noise Reduction.	183
Highlight Tone Priority.	184
Image Review.	185
Shutter Release Without Card.	186
Mirror Lockup.	187
Dust Delete Data Acquisition.	189
Shooting With Speedlites.	193
Flash Function Settings.	198
Anti-Flicker Shooting.	211
Multiple Exposures.	213
HDR PQ Settings.	223
Metering Mode Selection.	226
Manual Exposure Compensation.	229
Auto Exposure Bracketing (AEB).	231
Exposure Lock (AE Lock).	234
Using the Eyepiece Shutter.	236
Using a Remote Switch.	237
Still Photo Shooting (Live View Shooting).	238
Tab Menus: Still Photo Shooting (Live View Shooting).	239
Live View Shooting.	242
Shutter Mode.	245

Exposure Simulation	247
Metering Timer	248
General Live View Shooting Precautions	249
Movie Recording	251
Tab Menus: Movie Recording	252
Movie Recording	254
Movie Recording Quality	272
Sound Recording	283
Time Code	287
Canon Log Settings	294
Movie Digital IS	300
Other Menu Functions	302
General Movie Recording Precautions	307
AF/Drive	309
Tab Menus: AF Tab (Viewfinder Shooting)	310
Tab Menus: AF Tab (Live View Shooting)	313
Tab Menus: AF Tab (Movie Recording)	316
AF Operation	318
Selecting the AF Area and AF Point (Viewfinder Shooting)	323
AF Area Selection Modes (Viewfinder Shooting)	331
Selecting the AF Method (Live View Shooting)	340
AI Servo AF/Servo AF Characteristics	359
Customizing AF Functions	370
AF Microadjustment	393
Manual Focus	402
Selecting the Drive Mode	410
Using the Self-Timer	413
Playback	415
Tab Menus: Playback	417
Image Playback	419
Magnified Image Display	424
Index Display (Multiple-Image Display)	427

Voice Memo Recording and Playback.	430
Movie Playback.	435
Editing a Movie's First and Last Scenes.	438
4K Movie Frame Grab.	441
Playback on a TV Set.	443
Protecting Images.	445
Rotating Images.	451
Erasing Images.	453
Print Ordering (DPOF).	460
Copying Images.	466
Converting HEIF to JPEG.	474
RAW Image Processing.	476
Cropping JPEG Images.	484
Resizing JPEG Images.	487
Rating Images.	489
Slide Show.	495
Setting Image Search Conditions.	498
Browsing Images with the Main Dial.	502
Customizing Playback Information Display.	504
Displaying the Highlight Alert.	508
AF Point Display.	509
Playback Grid.	510
HDMI HDR Output.	511
Communication Functions.	512
Tab Menus: Communication Functions Tab.	513
Available Communication Functions.	514
Camera Connect Communication from Smartphones.	516
Wi-Fi Connections with a Computer Using EOS Utility.	552
Basic Communication Settings.	559
Image Transfer to FTP Servers.	597
Remote Control (EOS Utility).	624
Controlling the Camera with Browser Remote.	639
Ending Connections or Reconnecting.	666

Checking and Editing Network Settings.	669
Syncing Time Between Cameras.	691
GPS Features.	697
Reference.	705
Troubleshooting.	712
Resetting Communication Settings.	728
Set-up.	729
Tab Menus: Set-up.	730
Selecting Cards for Recording/Playback.	734
Folder Settings.	740
File Numbering.	744
File Naming.	749
Auto Rotate.	752
Formatting.	754
Display Brightness.	757
Display Color Tone.	758
Auto Power Off.	759
Date/Time/Zone.	760
Language.	764
Viewfinder Information Display.	765
<INFO> Button Display Options.	771
Custom Quick Control.	775
Shooting Information Display.	782
Shutter Button Function for Movies.	787
UI Magnification.	789
Help.	790
Video System.	793
Touch Control.	794
Beeps.	796
Battery Information.	797
Sensor Cleaning.	799
HDMI Resolution.	804
Save/Load Settings on Card.	805

Custom Shooting Mode (C1-C3).....	808
Resetting Camera.....	811
Copyright Information.....	813
System Status Display.....	816
Other Information.....	820
Custom Functions/My Menu.....	821
Tab Menus: Customization.....	822
Custom Function Setting Items.....	828
Custom Controls.....	853
Tab Menus: My Menu.....	875
Registering My Menu.....	876
Reference.....	883
Importing Images to a Computer.....	884
Troubleshooting Guide.....	888
Error Codes.....	903
Compatible Lenses and Autofocusing (Viewfinder Shooting).....	904
System Map.....	923
Performance Data.....	925
Information Display.....	931
Specifications.....	944
Trademarks and Licensing.....	959

Introduction

Before starting to shoot, be sure to read the following

To avoid shooting problems and accidents, first read the [Safety Instructions](#) and [Handling Precautions](#). Also read this Advanced User Guide carefully to ensure that you use the camera correctly.

Take some test shots, and understand about product liability

After shooting, play images back and check whether they have been properly recorded. If the camera or memory card is faulty and the images cannot be recorded or downloaded to a computer, Canon cannot be held liable for any loss or inconvenience caused.

Copyrights

Unauthorized public use of images captured with the camera that include copyrighted subjects may be prohibited by law. Also be aware that certain public performances, exhibitions, etc. may prohibit photography even for private enjoyment.

Firmware version

Outdated firmware will prevent you from using Browser Remote. In this case, download the latest version from the Canon website and update the firmware.

Connecting other devices

Use the included interface cable or a Canon cable when connecting the camera to a computer or other device. When connecting an interface cable, also use the included cable protector (🔒).

- [Package Contents](#)
- [Instruction Manuals](#)
- [Quick Start Guide](#)
- [About This Guide](#)
- [Compatible Cards](#)
- [Safety Instructions](#)
- [Handling Precautions](#)
- [Part Names](#)
- [Software](#)

Package Contents

Before use, make sure the following items are included in the package. If anything is missing, contact your dealer.

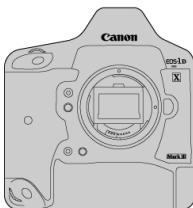

Camera

(with body cap and battery compartment cap)



Eyecup Eg



Battery Pack LP-E19

(with protective cover)



Battery Charger LC-E19

(with protective cover)

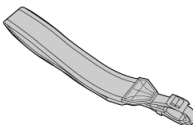

Strap

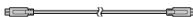

Interface Cable



Cable Protector

- The camera does not come with a memory card (📁) or HDMI cable.
- Attach Eyecup Eg to the viewfinder eyepiece.
- Be careful not to lose any of these items.
- No software CD-ROM is included. Software (📁) can be downloaded from the Canon website.

⚠ Caution

- The transmission rate when the included interface cable is used is equivalent to SuperSpeed USB (USB 3.1 Gen 1).

Instruction Manuals



The Instruction Manual included with the camera describes camera features and provides instructions up to turning the camera on.

- **Advanced User Guide**

Complete instructions are provided in this Advanced User Guide. For the latest Advanced User Guide, refer to the following website.

<https://cam.start.canon/C001/>



- **Lens/Software Instruction Manual**

Download from the following website.

<https://cam.start.canon/>



 **Note**

- Select [: **Manual/software URL**] to display the QR code on the camera screen.

Quick Start Guide

1. Insert the battery (🔋).

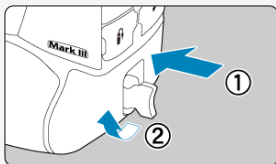

- Upon purchase, charge the battery to start using (🔋).

2. Insert the card (💳).

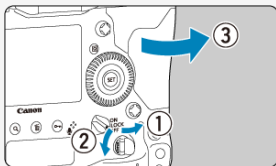

- You can insert two cards.

3. Attach the lens (🔍).

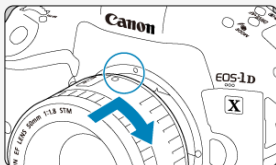

- Align the red mount index on the lens with the red mount index on the camera to attach the lens.

4. Set the lens's focus mode switch to < AF > (🔗).

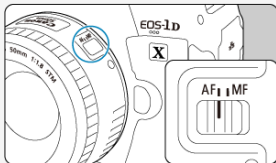

5. Set the power switch to < ON > (🔗).

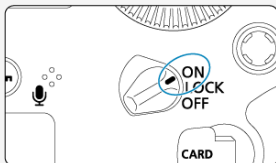

6. Set the shooting mode to < P > (🔗).



- Press the < MODE > button.
- Look at the top LCD panel and turn the < ⚙️ > or < 🔄 > dial to select < P >.

7. Focus on the subject (📷).



- Look through the viewfinder and center the subject on the screen.
- Press the shutter button halfway, and the camera will focus on the subject.

8. Take the picture (📷).

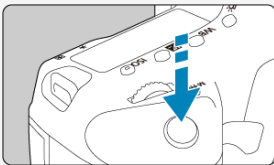

- Press the shutter button completely to take the picture.

9. Review the picture.



- The image just captured will be displayed for approx. 2 sec. on the screen.
- To display the image again, press the <▶> button (📷).







- To shoot while looking at the screen, see [Live View Shooting](#).

About This Guide





 [Icons in This Guide](#)

 [Basic Assumptions for Operational Instructions and Sample Photos](#)

Icons in This Guide

	Indicates the Main dial.
	Indicates the Quick control dial.
	Indicates the Multi-controller.
	Indicates the Smart controller.
	Indicates the Set button.
	Indicates the duration (in * seconds) of the operation for the button you pressed, as timed after you release the button.

- In addition to the above, the icons and symbols used on the camera's buttons and displayed on the screen are also used in this guide when discussing relevant operations and functionality.

	Links to pages with related topics.
	Warning to prevent shooting problems.
	Supplemental information.
	Tips or advice for better shooting.
	Troubleshooting advice.

Basic Assumptions for Operational Instructions and Sample Photos

- Before following any instructions, make sure the power switch is set to < ON > (🔌).
- It is assumed that all the menu settings and Custom Functions are set to their defaults.
- Screen shots in this guide show the default menu settings for NTSC regions (North America, Japan, South Korea, Mexico, etc.) as an example. Default menu settings for Europe, Russia, China, Australia, etc. will be for PAL.
- Illustrations in this guide show the camera with the EF 50mm f/1.8 STM lens attached as an example.
- Sample photos in this guide are only for illustration.

Compatible Cards

The following cards can be used with the camera regardless of capacity. **If the card is new or was previously formatted (initialized) by another camera or computer, format the card with this camera** (🔗).

- **CFexpress cards**

* Type B compatible

Cards That Can Record Movies

When recording movies, use a card with ample performance (fast enough writing and reading speeds) for the movie recording quality (🔗).

In this guide, "card" refers to CFexpress cards.

*** A card is not included.** Please purchase it separately.

Safety Instructions

Be sure to read these instructions in order to operate the product safely.
Follow these instructions to prevent injury or harm to the operator of the product or others.



WARNING: Denotes the risk of serious injury or death.

- Keep the product out of the reach of young children.

A strap wrapped around a person's neck may result in strangulation.

The parts or provided items of cameras or accessories are dangerous if swallowed. If swallowed, seek immediate medical assistance.

The battery is dangerous if swallowed. If swallowed, seek immediate medical assistance.

- Use only power sources specified in this instruction manual for use with the product.
- Do not disassemble or modify the product.
- Do not expose the product to strong shocks or vibration.
- Do not touch any exposed internal parts.
- Stop using the product in any case of unusual circumstances such as the presence of smoke or a strange smell.
- Do not use organic solvents such as alcohol, benzene or paint thinner to clean the product.
- Do not get the product wet. Do not insert foreign objects or liquids into the product.
- Do not use the product where flammable gases may be present.

This may cause electric shock, explosion or fire.

- Do not leave a lens or a camera/camcorder with a lens attached, exposed without the lens cap attached.

The lens may concentrate the light and cause fire.

- For products featuring a viewfinder, do not look through the viewfinder at strong light sources such as the sun on a bright day or lasers and other strong artificial light sources.

This may harm your vision.

- Do not touch the product connected to a power outlet during lightning storms.

This may cause electric shock.

- Observe the following instructions when using commercially available batteries or provided battery packs.
 - Use batteries/battery packs only with their specified product.
 - Do not heat batteries/battery packs or expose them to fire.
 - Do not charge batteries/battery packs using non-authorized battery chargers.
 - Do not expose the terminals to dirt or let them come into contact with metallic pins or other metal objects.
 - Do not use leaking batteries/battery packs.
 - When disposing of batteries/battery packs, insulate the terminals with tape or other means.

This may cause electric shock, explosion or fire.

If a battery/battery pack leaks and the material contacts your skin or clothing, flush the exposed area thoroughly with running water. In case of eye contact, flush thoroughly with copious amounts of clean running water and seek immediate medical assistance.

- Observe the following instructions when using a battery charger.
 - Periodically remove any dust buildup from the power plug and power outlet using a dry cloth.
 - Do not plug in or unplug the product with wet hands.
 - Do not use the product if the power plug is not fully inserted into the power outlet.
 - Do not expose the power plug and terminals to dirt or let them come into contact with metallic pins or other metal objects.
- Do not place heavy objects on the power cord. Do not damage, break or modify the power cord.
- Do not wrap the product in cloth or other materials when in use or shortly after use when the product is still warm in temperature.
- Do not unplug the product by pulling the power cord.
- Do not leave the product connected to a power source for long periods of time.
- Do not charge batteries/battery packs at temperatures outside the range of 5 - 40 °C (41 - 104 °F).

This may cause electric shock, explosion or fire.

- Do not allow the product to maintain contact with the same area of skin for extended periods of time during use.

This may result in low-temperature contact burns, including skin redness and blistering, even if the product does not feel hot. The use of a tripod or similar equipment is recommended when using the product in hot places and for people with circulation problems or less sensitive skin.

- Follow any indications to turn off the product in places where its use is forbidden.

Not doing so may cause other equipment to malfunction due to the effect of electromagnetic waves and even result in accidents.



CAUTION:

Denotes the risk of injury.

- Do not fire the flash near the eyes.

It may hurt the eyes.

- Do not look at the screen or through the viewfinder for prolonged periods of time.

This may induce symptoms similar to motion sickness. In such a case, stop using the product immediately and rest for a while before resuming use.

- Flash emits high temperatures when fired. Keep fingers, any other part of your body, and objects away from the flash unit while taking pictures.

This may cause burns or malfunction of the flash.

- Do not leave the product in places exposed to extremely high or low temperatures.

The product may become extremely hot/cold and cause burns or injury when touched.

- Strap is intended for use on the body only. Hanging the strap with any product attached on a hook or other object may damage the product. Also, do not shake the product or expose the product to strong impacts.

- Do not apply strong pressure on the lens or allow an object to hit it.

This may cause injury or damage to the product.

- Only mount the product on a tripod that is sufficiently sturdy.

- Do not carry the product when it is mounted on a tripod.

This may cause injury or may result in an accident.

- Do not touch any parts inside the product.

This may cause injury.

- If any abnormal skin reaction or irritation occurs during or following the use of this product, refrain from further use and get medical advice/attention.

Handling Precautions

Camera care

- This camera is a precision instrument. Do not drop it or subject it to physical shock.
- The camera is not waterproof and cannot be used underwater.
- To maximize the camera's dust- and drip- resistance, keep the terminal cover, battery release handle, card slot cover, and all other covers firmly closed.
- This camera is designed to be dust- and drip- resistant, in order to help prevent sand, dust, dirt, or water that falls on it unexpectedly from getting inside, but it is impossible to prevent dirt, dust, water, or salt from getting inside at all. As far as possible, do not allow dirt, dust, water, or salt to get on the camera.
- If water gets on the camera, wipe it off with a dry and clean cloth. If dirt, dust, or salt gets on the camera, wipe it off with a clean, well-wrung wet cloth.
- Using the camera in dusty or dirty locations may lead to damage.
- Cleaning the camera after use is recommended. Allowing dirt, dust, water, or salt to remain on the camera may cause a malfunction.
- If you accidentally drop the camera into water or are concerned that moisture (water), dirt, dust, or salt may have gotten inside it, promptly consult the nearest Canon Service Center.
- Never leave the camera near anything having a strong magnetic field such as a magnet or electric motor. Also, avoid using or leaving the camera near anything emitting strong radio waves, such as a large antenna. Strong magnetic fields can cause camera malfunction or destroy image data.
- Do not leave the camera in excessive heat, such as in a car in direct sunlight. High temperatures can cause the camera to malfunction.
- The camera contains precision electronic circuitry. Never attempt to disassemble the camera yourself.
- Do not block the mirror operation with your finger, etc. Doing so may cause a malfunction.
- Use only a commercially available blower to blow away dust when it adheres to the lens, viewfinder, mirror, focusing screen, etc. Do not use cleaners that contain organic solvents to clean the camera body or lens. For stubborn dirt, take the camera to the nearest Canon Service Center.
- Do not touch the camera's electrical contacts with your fingers. This is to prevent the contacts from corroding. Corroded contacts can cause camera malfunction.
- If the camera is suddenly brought in from the cold into a warm room, condensation may form on the camera and internal parts. To prevent condensation, first put the camera in a sealed plastic bag and let it adjust to the warmer temperature before taking it out of the bag.
- If condensation forms on the camera, to avoid damage, do not use the camera or remove the lens, card, or battery. Turn the camera off and wait until the moisture has fully evaporated before resuming use. Even after the camera is completely dry, if it is still internally cold, do not remove the lens, card, or battery until the camera has adjusted to the ambient temperature.
- If the camera will not be used for an extended period, remove the battery and store the camera in a cool, dry, well-ventilated location. Even while the camera is in storage, press the shutter button a few times once in a while to check that the camera is still working.

- Avoid storing the camera where there are chemicals that result in rust and corrosion such as in a chemical lab.
- If the camera has not been used for an extended period, test all its functions before using it. If you have not used the camera for some time or if there is an important shoot such as a foreign trip coming up, have the camera checked by your nearest Canon Service Center or check the camera yourself and make sure it is working properly.
- The camera may become hot after repeated continuous shooting, Live View shooting, or movie shooting over an extended period. This is not a malfunction.
- If there is a bright light source inside or outside the image area, ghosting may occur.

Screen and LCD panels

- Although the screen is manufactured with very high precision technology with over 99.99% effective pixels, 0.01% or fewer of the pixels may be dead, and there may also be spots of black, red, or other colors. This is not a malfunction. They do not affect the images recorded.
- If the screen is left on for a prolonged period, screen burn-in may occur where you see remnants of what was displayed. However, this is only temporary and will disappear when the camera is left unused for a few days.
- The screen display may seem slightly slow in low temperatures or may look black in high temperatures. It will return to normal at room temperature.

Cards

To protect the card and its recorded data, note the following:

- Do not drop, bend, or wet the card. Do not subject it to excessive force, physical shock, or vibration.
- Keep dust and foreign material out of the card opening.
- Do not affix any stickers, etc. on the card.
- Do not store or use the card near anything that has a strong magnetic field, such as a television, speakers, or magnets. Also avoid places prone to having static electricity.
- Do not leave the card in direct sunlight or near a heat source.
- Store the card in a case.
- Do not store the card in hot, dusty, or humid locations.

Lens

- After detaching the lens from the camera, put down the lens with the rear end up and attach the rear lens cap to avoid scratching the lens surface and electrical contacts (1).



Smudges on the image sensor

Besides dust entering the camera from outside, in rare cases, lubricant from the camera's internal parts may adhere to the front of the sensor. If smudges are visible on images, have the sensor cleaned by a nearest Canon Service Center.

Part Names





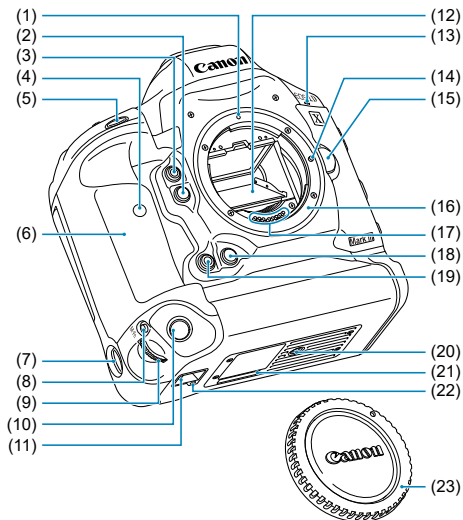



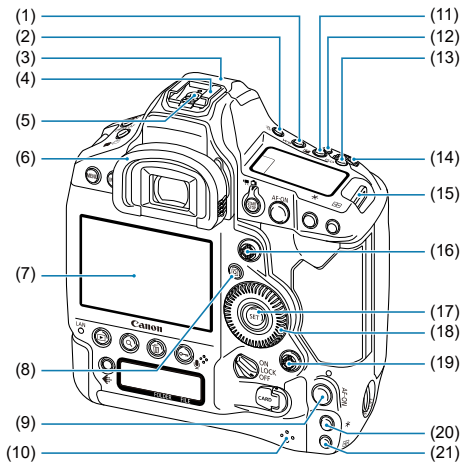

[Attaching the Strap](#)

[Using the Cable Protector](#)









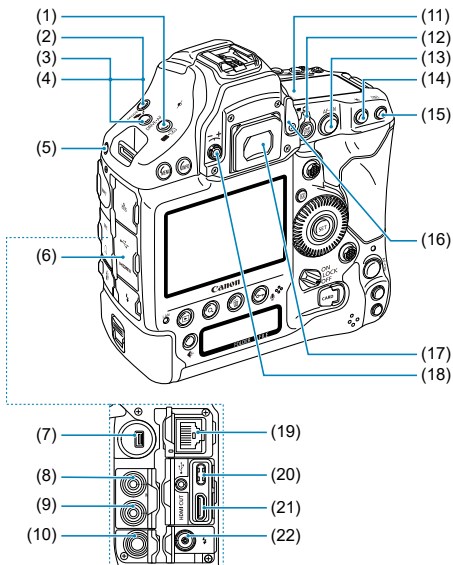





(1)	Lens mount index
(2)	Depth-of-field preview button
(3)	Multi-function button 2
(4)	Self-timer lamp
(5)	Shutter button
(6)	Grip
(7)	Vertical-grip On/Off switch
(8)	<M-Fn> Vertical-grip AF area selection/ Vertical-grip AF method selection/ Vertical-grip multi-function/ Vertical-grip FE lock/ Vertical-grip multi-spot metering button
(9)	Vertical-grip main dial
(10)	Vertical-grip shutter button
(11)	Hand strap mount
(12)	Mirror
(13)	Movie shooting microphone
(14)	Lens lock pin
(15)	Lens release button
(16)	Lens mount
(17)	Contacts
(18)	Vertical-grip depth-of-field preview button
(19)	Vertical-grip Multi-function button 2
(20)	Tripod socket
(21)	Serial number
(22)	Accessory positioning hole
(23)	Body cap







-
- (1) < WB > White balance selection button
-
- (2) <  > LCD panel illumination button
-
- (3) GPS antenna
-
- (4) Hot shoe
-
- (5) Flash sync contacts
-
- (6) Eyecup
-
- (7) Screen
-
- (8) <  > Quick Control button
-
- (9) < AF-ON > Vertical-grip AF start button/
Vertical-grip smart controller
-
- (10) Speaker
-
- (11) <  > Exposure compensation/
Aperture value setting button
-
- (12) < M-Fn > AF area selection/
AF method/
Multi-function/
FE lock/
Multi-spot metering button
-
- (13) < ISO > ISO speed setting/Time display button
-
- (14) <  > Main dial
-
- (15) Strap mount
-
- (16) <  > Multi-controller
-
- (17) <  > Setting button
-
- (18) <  > Quick control dial
-
- (19) <  > Vertical-grip Multi-controller
-
- (20) <  > Vertical-grip AE lock button
-
- (21) <  > Vertical-grip AF point selection button
-

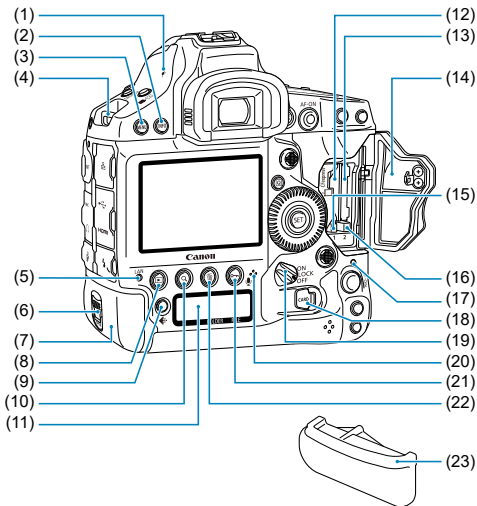







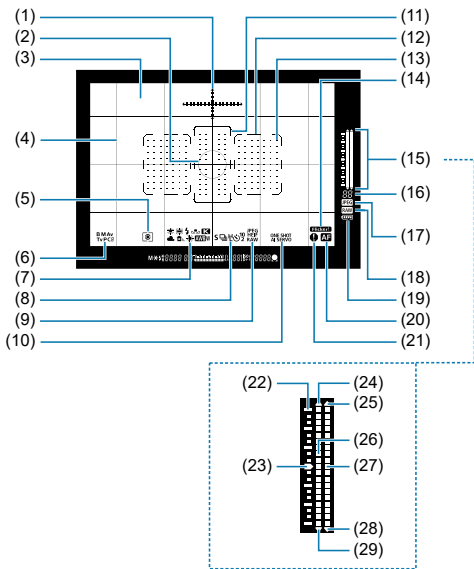

-
- (1) <  <  > Flash exposure compensation/
Metering mode selection button
-
- (2) < **MODE** > Shooting mode selection button
-
- (3) < **DRIVE** • **AF** > Drive mode/
AF operation selection button
-
- (4) <  > AEB setting button
-
- (5) System extension mounting hole
-
- (6) Terminal cover
-
- (7) System extension terminal
-
- (8) < **MIC** > External microphone IN/
Line input terminal
-
- (9) <  > Headphone terminal
-
- (10) <  > Remote control terminal (N3 type)
-
- (11) Top LCD panel
-
- (12) <  > Live View shooting/
<  > Movie shooting switch
<  > Start/Stop button
-
- (13) < **AF-ON** > AF start button/
Smart controller
-
- (14) <  > AE lock button
-
- (15) <  > AF point selection button
-
- (16) Eyepiece shutter lever
-
- (17) Viewfinder eyepiece
-
- (18) Dioptic adjustment knob
-
- (19) <  > Ethernet RJ-45 terminal
-
- (20) <  > Digital terminal
-
- (21) < **HDMI OUT** > HDMI mini OUT terminal
-
- (22) <  > PC terminal
-



-
- (1) <  > Focal plane mark
 - (2) < INFO > Info button
 - (3) < MENU > Menu button
 - (4) Strap mount
 - (5) < LAN > Network lamp
 - (6) Battery release handle
 - (7) Battery
 - (8) <  > Playback button
 - (9) <  > Card/Image size selection button
 - (10) < Q > Index/Magnify/Reduce button
 - (11) Rear LCD panel
 - (12) Card slot 1
 - (13) Card slot 2
 - (14) Card slot cover
 - (15) Card 1 eject button
 - (16) Card 2 eject button
 - (17) Access lamp
 - (18) Card slot cover release handle
 - (19) Power/Multi-function lock switch
 - (20) Voice memo microphone
 - (21) <  > Protect/Voice memo button
 - (22) <  > Erase button
 - (23) Battery compartment cap
-

Viewfinder information display



(1)	Electronic level
(2)	Spot metering circle
(3)	Focusing screen
(4)	Grid
(5)	Metering mode
(6)	Shooting mode
(7)	White balance
(8)	Drive mode
(9)	Image type
(10)	AF operation
(11)	Large Zone AF frame
(12)	Area AF frame
(13)	<  > AF point <  > Spot AF point
(14)	Flicker detection
(15)	Exposure level indicator (metering/flash exposure levels)
(16)	Maximum burst Number of remaining multiple exposures
(17)	<  > JPEG icon
(18)	<  > RAW icon
(19)	<  > Battery level
(20)	<  > AF status indicator
(21)	<  > Warning icon
(22)	Exposure level scale ■: 1-stop ■: 1/3-stop
(23)	Standard exposure index
(24)	Overexposure
(25)	Flash overexposure
(26)	Exposure level
(27)	Flash exposure level Flash exposure compensation amount Multi-spot metering amount
(28)	Flash underexposure
(29)	Underexposure

* The display will show only the settings currently applied.



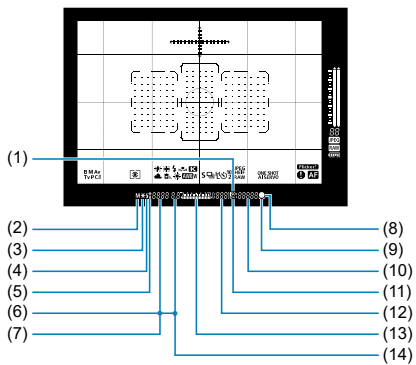



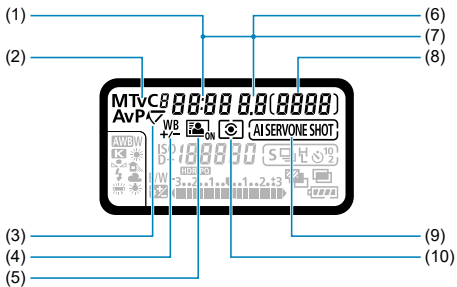

* AF points light up in red.



(1)	<ISO> ISO speed
(2)	Manual exposure
(3)	<✳> AE lock AEB in progress Multi-spot metering
(4)	<⚡> Flash ready FE lock out-of-range warning
(5)	<⚡* > FE lock FEB in progress <⚡H> High-speed sync
(6)	AF point selection ([] AF, SEL [], SEL AF) AF point registration ([] HP, SEL [], SEL HP) Current time Card warning (Card 1/2/1,2)
(7)	Shutter speed Bulb (buLb) FE lock (FEL) Busy (buSY) Multi-function lock warning (L) No card warning (Card) Error codes (Err)
(8)	<●> Focus indicator
(9)	<▲> AF status indicator
(10)	ISO speed Dust Delete Data acquisition (- - - -)
(11)	<D+> Highlight tone priority
(12)	Number of available shots Card full warning (Full) Card error warning (Err) Error number
(13)	Exposure level indicator (setting value) Exposure compensation amount AEB range
(14)	Aperture value AI Bounce mode active (AI_b) AEB amount Dust Delete Data acquisition (- -)









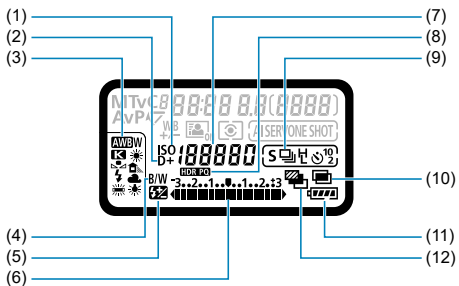













Top LCD panel



-
- (1) Shutter speed
 Bulb (**buLb**)
 Bulb exposure time (min.:sec.)
 FE lock (**FEL**)
 Busy (**buSY**)
 Multi-function lock warning (**L**)
 Cleaning image sensor (**CLn**)
 AI Bounce mode active (**AI_b**)
 No-card warning (**Card**)
 Error codes (**Err**)
-
- (2) Shooting mode
P Program AE
Av Aperture-priority AE
M Manual exposure
Tv Shutter-priority AE
C1/C2/C3 Custom shooting mode
-
- (3) <  > Mirror lockup
-
- (4) <  > White balance correction
-
- (5) <  > Auto Lighting Optimizer
-
- (6) Aperture value
 AEB amount
 Dust Delete Data acquisition (- -)
-
- (7) AF point selection
 ([] AF, SEL [], SEL AF)
 AF point registration
 ([] HP, SEL [], SEL HP)
 Card warning (**Card 1/2/1,2**)
-
- (8) Number of available shots
 Self-timer countdown
 Bulb exposure time (hours)
 Custom white balance acquisition display ([*]) 
 Card full warning (**Full**)
 Card error warning (**Err**)
 Error number
 Remaining images to record
-
- (9) AF operation
ONE SHOT One-Shot AF
AI SERVO AI Servo AF
-
- (10) Metering mode
 Evaluative metering
 Partial metering
 Spot metering
 Center-weighted average metering
-

* The display will show only the settings currently applied.



-
- (1) < ISO > ISO speed
-
- (2) < D+ > Highlight tone priority
-
- (3) White balance
 Auto (Ambience priority)
 Auto (White priority)
 Daylight
 Shade
 Cloudy
 Tungsten light
 White fluorescent light
 Flash
 Custom
 Color temperature/Personal white balance
-
- (4) < B/W > Monochrome shooting
-
- (5) <  > Flash exposure compensation
-
- (6) Exposure level indicator (setting value)
 Exposure compensation amount
 AEB range
 Flash exposure compensation amount
-
- (7) ISO speed
 Color temperature
 Custom white balance number
 Personal white balance (PC-*)
 Dust Delete Data acquisition (- - - -)
-
- (8) <  > HDR PQ
-
- (9) Drive mode
 Single shooting
 High-speed continuous shooting
 Medium-speed continuous shooting
 Low-speed continuous shooting
 Single Soft shooting
 Soft continuous shooting
 Soft low-speed continuous shooting
 Self-timer: 10 sec.
 Self-timer: 2 sec.
-
- (10) <  > Multiple exposure shooting
-
- (11) Battery level
-
- (12) <  > AEB
-

Rear LCD panel

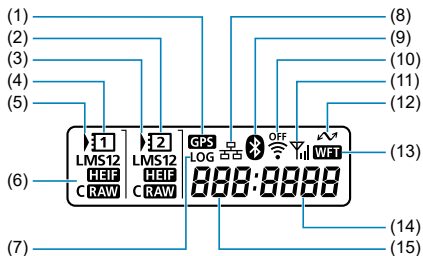

(1) < **GPS** > GPS acquisition status*1

(2) < **2** > Card 2 indicator

(3) < **<** > Card 2 selection icon

(4) < **1** > Card 1 indicator

(5) < **>** > Card 1 selection icon

(6) Image size

L Large

M1 Medium1

M2 Medium2

S Small

HEIF HEIF

RAW RAW

CRAW Compact RAW

(7) < **LOG** > Logging function

(8) < **LAN** > Wired LAN connection*2

(9) < **Bluetooth** > Paired via Bluetooth

(10) < **Wi-Fi** > Wi-Fi function

(11) < **Signal** > Wireless signal strength

(12) < **WFT** > Data transfer icon*3

(13) < **WFT** > Connected to WFT

(14) File number

(15) Folder number

* 1: Appears when built-in GPS features are used.

* 2: Appears when connected to a wired LAN.

* 3: Appears when connected to a computer or smartphone.

* The display will show only the settings currently applied.

Battery Pack LP-E19

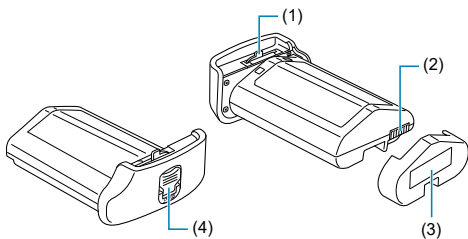

(1) Battery lock lever

(2) Contacts

(3) Protective cover

(4) Battery release handle

Battery Charger LC-E19

Charger for Battery Pack LP-E19 (☑).

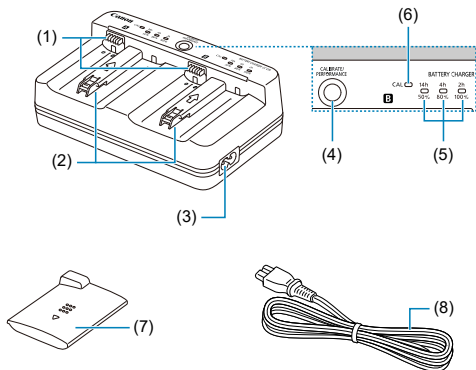

-
- | | |
|-----|---|
| (1) | Contacts |
| (2) | Battery slots |
| (3) | Power cord socket |
| (4) | Recharge performance check button/Calibration button |
| (5) | Charge lamp/Recharge performance check lamp/Discharge time lamp |
| (6) | Calibration (discharge) lamp |
| (7) | Protective cover (two included) |
| (8) | Power cord |
-

Attaching the Strap

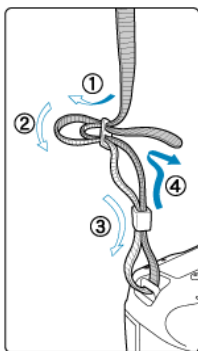

Pass the end of the strap through the strap mount from the bottom, then pass it through the strap buckle as shown. Pull the strap to take up any slack and make sure the strap will not loosen from the buckle.

Using the Cable Protector

When connecting the camera to a computer, use the included interface cable or a Canon cable.

When connecting an interface cable, also use the included cable protector. Using the cable protector helps prevent accidental disconnection and terminal damage.

Using the included interface cable and a Canon HDMI cable (sold separately)

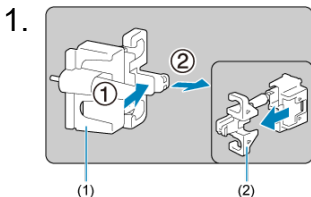

- (1) Cable protector
(2) Clamp

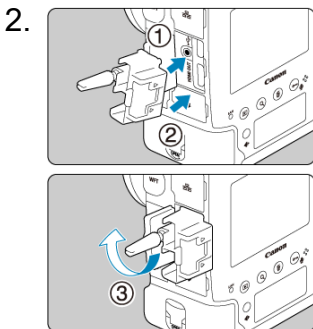

3.

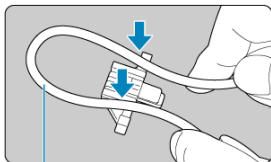

(3)

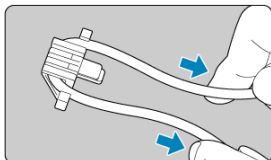

(3) Included interface cable

4.

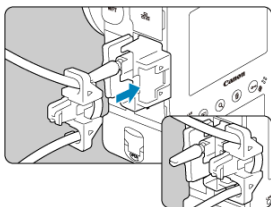

5.

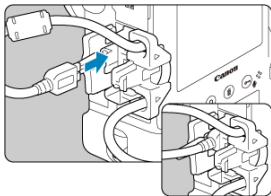

6.

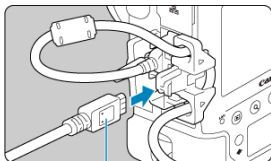

(4)

(4) HDMI cable (sold separately)

Using an optional Canon interface cable

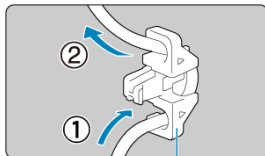

(5)

When using an optional Canon interface cable, pass the cable through the clamp (5) as shown before attaching the clamp to the cable protector.



Caution

- Using the camera when the interface cable is connected without the cable protector may damage the digital terminal.
- Make sure the interface cable is securely connected to the digital terminal.



Note

- HDMI Cable HTC-100 is recommended when connecting the camera to a television. Also consider using the cable protector when connecting an HDMI cable.

Software

- [✔ Software Overview](#)
- [✔ Downloading and Installing EOS Software or Other Dedicated Software](#)
- [✔ Downloading the Software Instruction Manual](#)

Software Overview

This section summarizes software used with EOS cameras. Note that downloading and installing the software requires an internet connection. The software cannot be downloaded or installed in environments without an internet connection.

EOS Utility

Enables you to transfer your captured still photos and movies from the camera to a connected computer, set various camera settings from the computer, and shoot remotely from the computer.

Digital Photo Professional

Software recommended for users who shoot RAW images. Enables image viewing, editing, printing, and more. Also enables RAW movie playback and editing.

Picture Style Editor

Enables you to edit existing Picture Styles or create and save original Picture Style files. This software is for users who are familiar with image processing.

GPS Log File Utility

Utility for converting GPS log files (.LOG) to KMZ format.

Downloading and Installing EOS Software or Other Dedicated Software

Always install the latest version of the software.

Update any previous versions that are installed by overwriting them with the latest version.

Caution

- Do not connect the camera to a computer before you install the software. The software will not be installed correctly.
- The software cannot be installed unless the computer is connected to the internet.
- Previous versions cannot display images from this camera correctly. Also, processing RAW images from this camera is not possible.

1. Download the software.

- Connect to the internet from a computer and access the following Canon website.

<https://cam.start.canon/>



- Select your country or region of residence and download the software.
- Depending on the software, you may need to enter the camera's serial number. The serial number is on the bottom of the camera.
- Decompress it on the computer.

- **For Windows**

Click the displayed installer file to start the installer.

- **For macOS**

A dmg file will be created and displayed. Follow the steps below to startup the installer.

1. Double-click the dmg file.

- A drive icon and installer file will appear on the desktop. If the installer file does not appear, double-click the drive icon to display it.

2. Double-click the installer file.

- The installer starts.

2. Follow the on-screen instructions to install the software.

Downloading the Software Instruction Manual

Software Instruction Manuals (PDF files) can be downloaded from the Canon website to your computer, etc.

- **Software Instruction Manual download site**

<https://cam.start.canon/>



Preparation and Basic Operations

This chapter describes preparatory steps before you start shooting and the basic camera operations.

- [Charging the Battery](#)
- [Inserting/Removing Batteries](#)
- [Inserting/Removing Cards](#)
- [Turning on the Power](#)
- [Attaching/Detaching Lenses](#)
- [Basic Operations](#)
- [Menu Operations and Settings](#)
- [Quick Control](#)
- [Touch-Screen Operation](#)

Charging the Battery

1. Connect and plug in the battery charger.

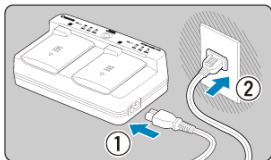

- Connect the power cord to the charger and plug the other end into a power outlet.
- All indicator lamps are off when no batteries are loaded.

2. Remove the protective cover.

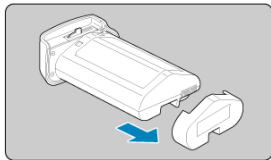
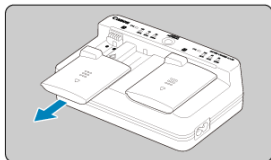

- Remove the included protective covers from the charger and battery.

3. Charge the battery.

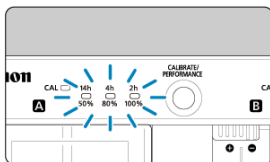
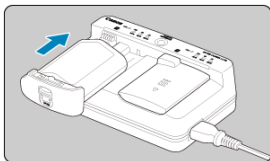

- Slide the battery in (in the opposite direction from protective cover removal) and make sure it is securely attached to the charger.
 - You can load a battery into either slot **A** or slot **B**.
 - Charging begins, and the charge lamp blinks or lights up in green.
 - **Charging is finished when all three charge lamps (50%/80%/100%) are lit in green.**
-
- **Charging takes approx. 2 hr. and 50 min. at room temperature (23°C/73°F) per depleted battery.** The time required to charge the battery will vary greatly depending on the ambient temperature and the battery's remaining capacity.
 - For safety reasons, charging in low temperatures (5–10°C/41–50°F) will take longer (up to approx. 5 hr.).

Caution

- Use Battery Charger LC-E19 to charge Battery Pack LP-E19 (both included). This battery cannot be charged with Battery Charger LC-E4N/LC-E4.
- Depending on the condition of the battery, charging to 100% capacity may not be possible.

Note

- If you load two batteries, they are charged one after another in the order you load them.
-
- **Upon purchase, the battery is not fully charged.**
Charge the battery before use.

- **Charge the battery on the day before or on the day it is to be used.**
Charged batteries gradually lose their charge, even when they are not used.
- **After charging the battery, remove it and disconnect the charger from the power outlet.**
When not using the battery or charger, reattach the included protective covers.
- **Use the battery in an ambient temperature range of 0–45°C/32–113°F.**
For optimal battery performance, use batteries where the ambient temperature is 10–30°C/50–86°F. Lower temperatures may temporarily lower battery performance and reduce battery life.
- **When not using the camera, remove the battery.**
If the battery is left in the camera for a prolonged period, a small amount of power current will keep being released, resulting in excess discharge and shorter battery life. Store the battery with the protective cover attached. Storing the battery when it is fully charged may lower the battery performance.
- **The battery charger can also be used in foreign countries.**
The battery charger is compatible with a 100 V AC to 240 V AC 50/60 Hz power source. If necessary, attach a commercially available plug adapter for the respective country or region. To avoid damage, do not connect to portable voltage transformers.
- **Check battery recharge performance, as needed.**
Press the charger's < PERFORMANCE > button during charging to check battery recharge performance, as indicated by how many of the three lamps are lit in green.
 - ● ●: Battery's recharge performance is good.
 - ● ○: Battery's recharge performance is slightly degraded.
 - ○ ○: Purchasing a new battery is recommended.
- **If the battery becomes exhausted quickly even after having been fully charged, the battery has reached the end of its service life.**
Check the battery's recharge performance (🔋) and purchase a new battery.

? The <CAL> lamp blinks.

- This display advises you to calibrate (discharge) the battery, which will enable accurate charging capacity determination and battery level display on the camera.
- When the <CAL> lamp blinks in green, calibration is recommended. To charge the battery at this time, wait approx. 10 sec., and charging will begin automatically.
- To perform calibration, press the <CALIBRATE> button while the <CAL> lamp is blinking in green. The <CAL> lamp now remains lit in green, and discharging begins.
- Charging begins automatically after discharging, but note that the more fully charged the battery is, the longer discharging will take. Estimated time required for discharging is indicated by the <14h>, <4h>, and <2h> lamp, with a blinking green <14h> lamp indicating a discharge time of approx. 4–16 hours.
- Calibration drains the remaining battery level, and after this, charging the battery will take approx. 2 hr. 50 min. To cancel calibration in progress and start charging, remove and reload the battery in the charger.

Caution

- Multiple cycles of charging and use without calibration may result in inaccurate battery level display (🔋).
- One battery can be charged while another is calibrated, but two batteries cannot be charged or calibrated at the same time.
- When performing calibration, consider using a battery that is nearly depleted. Calibrating and then charging Battery Pack LP-E19 when it is fully charged takes approx. 18 hr. 50 min.

? Only the <100%> lamp is lit immediately after a battery is loaded.

- Illumination of only the <100%> lamp in green immediately after charging begins indicates that the internal battery temperature is out of range. Charging begins automatically when the internal temperature returns to 5–40°C/41–104°F.
- With two batteries loaded, illumination of only the <100%> lamp in green on the side of the second battery indicates standby status.

? All three lamps are blinking.

- Charging is not possible when batteries other than Battery Pack LP-E19 are loaded in the charger. In this case, the three charge lamps and <CAL> lamp blink in green.
- If the three charge lamps blink in green consecutively during charging (with or without blinking of the <CAL> lamp in green), remove the battery and contact your dealer or the nearest Canon Service Center.
- If the three charge lamps blink during calibration, remove the battery and contact your dealer or the nearest Canon Service Center.

Inserting/Removing Batteries

 [Insertion](#)

 [Removal](#)

Insert a fully charged Battery Pack LP-E19 into the camera.

Viewfinder brightness increases when a battery is inserted and decreases after removal.

Insertion

1. Remove the battery compartment cap.

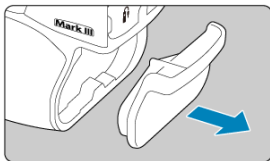

2. Insert the battery.

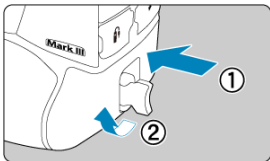

- Insert the battery firmly, all the way in, then turn the battery release handle as shown by the arrow.

Caution

- There may be a slight delay before the camera turns on when a battery is used in the camera for the first time.
- You cannot use batteries other than the Battery Pack LP-E19.

Note

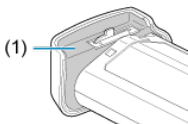

- Wipe away any dirt on the battery's water-repellent rubber lining (1) with a moistened cotton swab.

1. Turn the battery release handle and remove the battery.

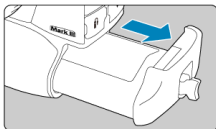
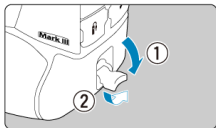

- Make sure the power switch is set to <OFF> (☑).
- Flip out the battery release handle, turn it as shown by the arrow, and remove the battery.
- To prevent short-circuits, always attach the included protective cover (☑) to the battery.
- When not using the camera, attach the battery compartment cap (☑).

Inserting/Removing Cards

 [Insertion](#)

 [Removal](#)

This camera accepts two cards. **Recording is possible as long as there is at least one card in the camera.**

With two cards inserted, you can select one card to record to, or you can record the same image to both cards at once ().

Insertion

1. Open the cover.

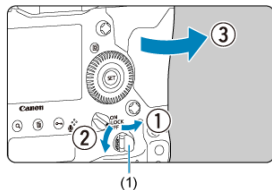

- Flip out the card slot cover release handle (1) and turn it as shown by the arrow to open the cover.

2. Insert the card.

Card 1

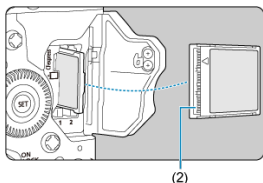

Card 2

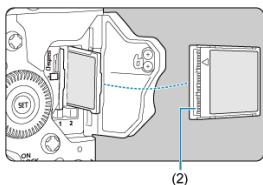

- The card in the left card slot is **[1]**, and the card on the right is **[2]**.
- With the card label facing you, insert the open side of the card (2) into the card slot. **Inserting cards the wrong way may damage the camera.**
- The gray card-eject button pops out.

3. Close the cover.

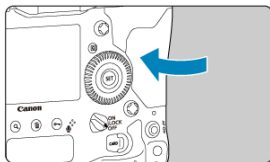

- Press the cover until it snaps shut.

4. Set the power switch to <ON> (☑).

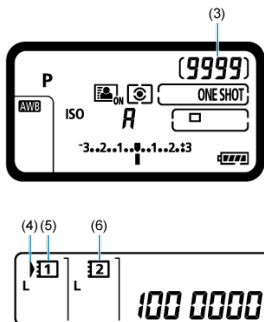

(3) Number of available shots

(4) Card selection icon

(5) Card 1

(6) Card 2

- The top LCD panel shows how many shots are available.
- The rear LCD panel shows which cards are loaded.
Cards labeled with < > are selected for recording.

Caution

- Only CFexpress cards can be used.

Note

- The number of shots available varies depending on remaining card capacity and settings such as image quality and ISO speed.
- Setting [📷: **Release shutter without card**] to [Disable] will prevent you from forgetting to insert a card (☑).

1. Open the cover.

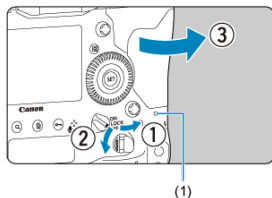

- Set the power switch to < OFF >.
- Check that the access lamp (1) is off, then open the cover.
- If [Saving...] is displayed on the screen, close the cover.

2. Remove the card.

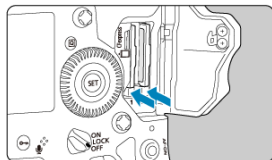

- Press the card eject button to eject the card.
- Pull the card straight out, then close the cover.

Caution

Do not remove cards immediately after display of a red  icon in Live View shooting or movie recording. Cards may be hot, due to high internal camera temperature. Set the power switch to < OFF > and stop shooting for a while before removing cards. Removing hot cards immediately after shooting may cause you to drop and damage them. Be careful when removing cards.

 **Caution**

- **When the access lamp is lit or blinking, it indicates that images are being written to, read from, or erased from the card, or data is being transferred. Do not open the card slot cover during this time. To avoid corrupting image data or damaging cards or the camera, never do any of the following while the access lamp is lit or blinking.**
 - **Removing the card.**
 - **Removing the battery.**
 - **Shaking or striking the camera.**
 - **Unplugging or plugging in a power cord**
(when using optional household power outlet accessories).
- If the card already contains recorded images, the image number may not start from 0001 (🔗).
- If a card-related error message is displayed on the screen, remove and reinsert the card. If the error persists, use a different card.
If you can transfer images on the card to a computer, transfer all the images and then format the card with the camera (🔗). The card may then return to normal.

Turning on the Power

[Setting the Date, Time, and Time Zone](#)

[Changing the Interface Language](#)

[Automatic Sensor Cleaning](#)

[Battery Level Indicator](#)

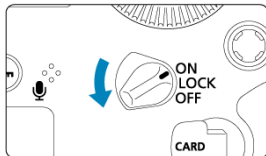

- **<ON>**
The camera turns on.
- **<LOCK>**
The camera turns on. Multi-function locking is engaged ().
- **<OFF>**
The camera is turned off and does not function. Set the power switch to this position when not using the camera.

Note

- If you set the power switch to **<OFF>** while an image is being recorded to the card, **[Saving...]** will be displayed and the power will turn off after the recording finishes.



Setting the Date, Time, and Time Zone

If you turn on the camera and the date/time/zone setting screen appears, see [Date/Time/Zone](#) to set the date/time/zone.

Changing the Interface Language

To change the interface language, see [Language](#).

Automatic Sensor Cleaning

- Whenever the power switch is set to < **ON/LOCK** > or < **OFF** >, the sensor is cleaned automatically (which may make a faint sound). During the sensor cleaning, the screen will display <  >.
- Even during sensor cleaning, you can stop cleaning and shoot immediately by pressing the shutter button halfway ().
- If you repeatedly turn the power switch to < **ON/LOCK** > or < **OFF** > within a short time period, the <  > icon may not be displayed, but this does not indicate the camera is malfunctioning.

Battery Level Indicator

When the power switch is set to < ON >, the battery level will be indicated.



Display						
Level (%)	100–70	69–50	49–20	19–10	9–1	0

Note

- Doing any of the following will exhaust the battery faster:
 - Pressing the shutter button halfway for a prolonged period.
 - Activating the AF frequently without taking a picture.
 - Using the lens's Image Stabilizer.
 - Using the Wi-Fi function or Bluetooth function.
 - Using the screen frequently.
- The number of available shots may decrease depending on the actual shooting conditions.
- Lens operations are powered by the camera's battery. Certain lenses may exhaust the battery faster than others.
- See [: **Battery info.**] to check the battery status ().

Attaching/Detaching Lenses

 [Attaching a Lens](#)

 [Detaching a Lens](#)

All EF lenses can be used. **The camera cannot be used with RF, EF-S, or EF-M lenses.**

Caution

- Do not look at the sun directly through any lens. Doing so may cause loss of vision.
- When attaching or detaching a lens, set the camera's power switch to < **OFF** >.
- If the front part (focusing ring) of the lens rotates during autofocus, do not touch the rotating part.

Tips for avoiding smudges and dust

- When changing lenses, do it quickly in a place with minimal dust.
- When storing the camera without a lens attached, be sure to attach the body cap to the camera.
- Remove smudges and dust on the body cap before attaching it.

Attaching a Lens

1. Remove the caps.

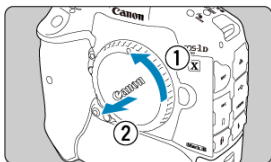
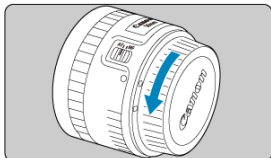

- Remove the rear lens cap and the body cap by turning them as shown by the arrows.

2. Attach the lens.

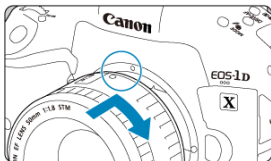

- Align the red mount index on the lens with the red mount index on the camera and turn the lens as shown by the arrow until it clicks in place.

3. Set the lens's focus mode switch to <AF>.

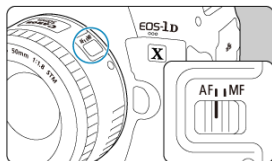

- <AF> stands for autofocus.
- <MF> stands for manual focus. Autofocus will not operate.

4. Remove the front lens cap.





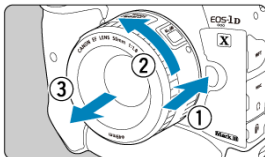

Detaching a Lens

While pressing the lens release button, turn the lens as shown by the arrow.



- Turn the lens until it stops, then detach it.
- Attach lens caps to the lens you removed.

Basic Operations

- [Adjusting the Viewfinder](#)
- [Holding the Camera](#)
- [Shutter Button](#)
-  [Main Dial](#)
-  [Quick Control Dial](#)
-  [Multi-Controller](#)
-  [Multi-Function Button](#)
-  [AF Start Button/Smart Controller](#)
-  [Multi-Function Lock](#)
-  [LCD Panel Illumination](#)
- [Vertical Shooting](#)
- [Time Display](#)
- [Button Backlighting](#)
-  [Button](#)

1. Detach the eyecup.

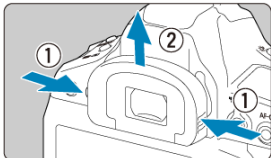

- Grasp the eyecup on both sides and slide it up to detach it.

2. Make the adjustment.

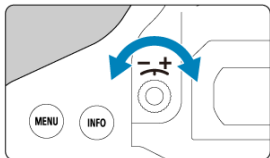

- Turn the knob left or right to make the AF points in the viewfinder look sharp.
- Attach the eyecup.

Note

- If the camera's dioptic adjustment still cannot provide a sharp viewfinder image, using Dioptic Adjustment Lenses Eg series (sold separately) is recommended.

Holding the Camera

To obtain sharp images, hold the camera still to minimize camera shake.

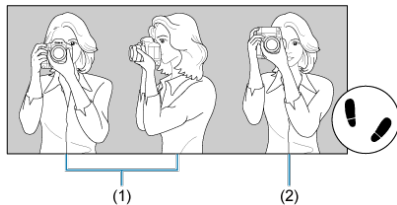

(1) Horizontal shooting

(2) Vertical shooting

1. With your right hand, hold the camera firmly by the camera grip.
2. With your left hand, support the lens from below.
3. Rest your right index finger lightly on the shutter button.
4. Rest your arms and elbows lightly against the front of your body.
5. To maintain a stable stance, place one foot slightly ahead of the other.
6. Hold the camera near your face and look through the viewfinder.

Note

- To shoot while looking at the screen, see [Live View Shooting](#).

Shutter Button

The shutter button has two steps. You can press the shutter button halfway. Then you can further press the shutter button completely.

Pressing halfway

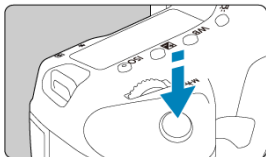

This activates autofocus and the automatic exposure system that sets the shutter speed and aperture value. The exposure value (shutter speed and aperture value) is displayed in the viewfinder and on the top LCD panel for approx. 6 sec. (metering timer/)6).

Pressing completely

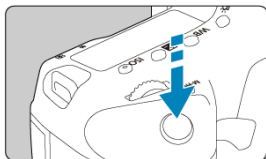

This releases the shutter and takes the picture.

● Preventing camera shake

Hand-held camera movement during the moment of exposure is called camera shake. It can cause blurred pictures. To prevent camera shake, note the following:

- Hold the camera still, as shown in [Holding the Camera](#).
- Press the shutter button halfway to autofocus, then slowly press the shutter button completely.





Note

- The camera will still pause before taking a picture if you press the shutter button completely without pressing it halfway first, or if you press the shutter button halfway and immediately press it completely.
- Even during menu display or image playback, you can return to shooting standby by pressing the shutter button halfway.

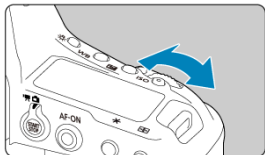
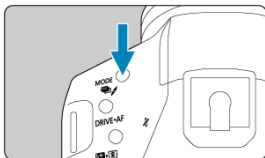
(1) After pressing a button, turn the <  > dial.





When you press a button such as < **MODE** > < **DRIVE•AF** > <  •  >, or < **ISO** >, the respective function remains selectable for approx. 6 sec. (Ⓜ6). During this time, you can turn the <  > dial to change the setting.

When the timer ends or if you press the shutter button halfway, the camera will go back to shooting standby.

- Used for operations such as selection of the shooting mode, AF operation, metering mode, AF point, ISO speed, exposure compensation (when the <  > button is pressed), or card.

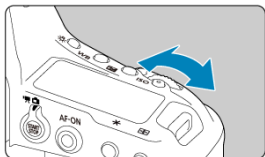
(2) Turn only the <  > dial.



While looking at the viewfinder display or top LCD panel, turn the <  > dial.

- Use this dial to set the shutter speed, aperture value, etc.



 **Note**

- The operations in (1) can be performed even when the power switch is set to <LOCK> .

< > Quick Control Dial

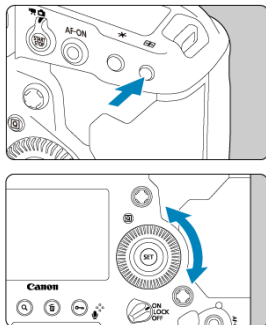
(1) After pressing a button, turn the <  > dial.





When you press a button such as < **MODE** > < **DRIVE•AF** > <  •  >, or < **ISO** >, the respective function remains selectable for approx. 6 sec. (Ⓜ6). During this time, you can turn the <  > dial to change the setting.

When the timer ends or if you press the shutter button halfway, the camera will go back to shooting standby.

- Used for operations such as selection of the shooting mode, drive mode, flash exposure compensation, AF point, ISO speed, exposure compensation (when the <  > button is pressed), white balance, or image size.

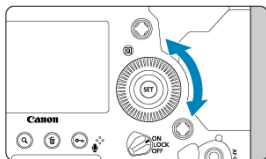
(2) Turn only the <  > dial.



While looking at the viewfinder display or top LCD panel, turn the <  > dial.

- Use this dial to set the exposure compensation amount, the aperture value setting for manual exposures, etc.

 **Note**

- The operations in (1) can be performed even when the power switch is set to <LOCK> .

< > Multi-Controller

<  > is an eight-direction key with center button. To use it, press lightly with the tip of your thumb.

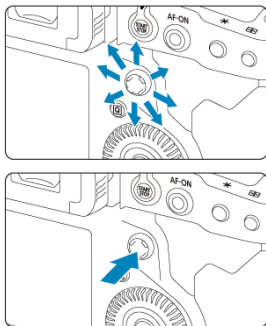

- Used for operations such as AF point selection, white balance correction, AF point/magnifying frame movement in Live View shooting or movie recording, magnifying frame movement during playback, or Quick Control settings.
- Can also be used to select or set menu items.

<M-Fn>: Multi-Function Button

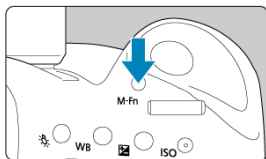

The <M-Fn> button is used for operations such as selection of the AF area selection mode (☑)/AF method (☑), FE lock (☑), or multi-spot metering (☑).

To select the AF area or AF method, press the <☐☐☐> button (⌚6), then press the <M-Fn> button.

< AF-ON >: AF Start Button/Smart Controller

On this control, you can press the center or drag with your finger.

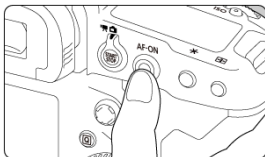
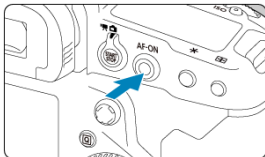

- Pressing the < AF-ON > button activates autofocus. This is equivalent to pressing the shutter button halfway.
- You can move the AF point by dragging on the smart controller after pressing the < AF-ON > button. You can also adjust the sensitivity—the amount the AF point moves in response to dragging (AF-ON/AF-ON).
- **[Direct AF point selection]** can be assigned to this control by selecting **[Smart controller]** in **[Custom Controls]**. Assigning this function enables you to select an AF point directly by dragging on the smart controller during metering, without pressing the < AF-ON > button, and then pressing the < AF-ON > button to focus.

! Caution

Precautions when using the smart controller

- In case of poor responsiveness if you are wearing gloves, use this control without wearing the gloves.
- The camera may not respond to touch operations with wet fingers.

<LOCK>: Multi-Function Lock

With [6: Multi function lock] configured (☑) and the power switch set to <LOCK>, you can prevent the settings from being changed by accidentally touching the Main dial, Quick control dial, Multi-controller, smart controller, or touch-screen panel.

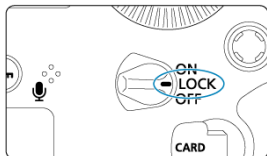



Note

- Attempting to use any locked camera controls when the power switch is set to <LOCK> will cause <L> to appear in the viewfinder and on the top LCD panel and [LOCK] on the Quick Control screen (☑).
- By default, the <☉> dial is locked when the power switch is set to <LOCK>.

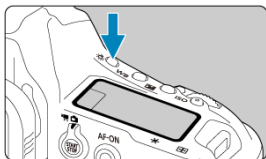
< > LCD Panel Illumination



You can illuminate the top LCD panel and rear LCD panel by pressing the <  > button. Each press of the <  > button switches illumination on () and off. During a bulb exposure, pressing the shutter button completely will turn off the LCD panel illumination.

Vertical Shooting

Buttons, dial, and a Multi-controller for vertical shooting are arranged near the bottom of the camera (📷).

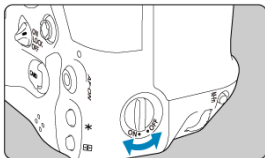

- When using the controls for vertical shooting, set the vertical-grip On/Off switch to **< ON >**.
- When you are not using these controls, set to **< OFF >** to prevent unintended operations.

Note

- Vertical-grip Multi-function button 2 and the vertical-grip depth-of-field preview button (📷) can also be used with the vertical-grip On/Off switch set to **< OFF >**.

Time Display



Press the <ISO> button when you are looking through the viewfinder to display the time (⌚6).

Button Backlighting

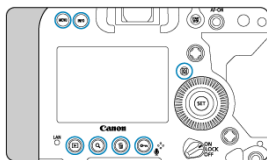

< MENU >, < INFO >, < Q >, < ▶ >, < Q >, < ⌵ >, and < On / Off > button backlighting is activated when the LCD panels are illuminated, or during menu or Quick Control screen display or image playback. This makes it easier to see the button layout in low-light locations. Button backlighting is deactivated when the metering timer starts, which is triggered by pressing the shutter button halfway, for example.

<INFO> Button

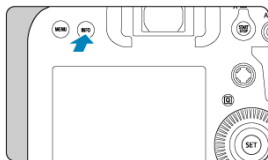

Each press of the <INFO> button changes the information shown. The following sample screens are for still photos.

Electronic level

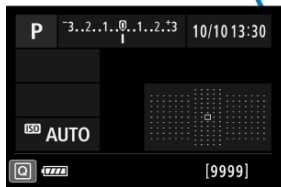
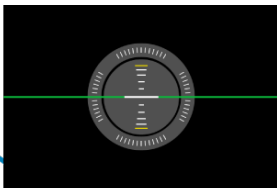
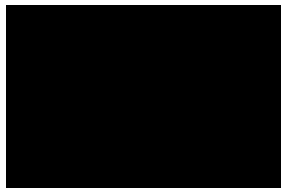

Custom Quick Control screen

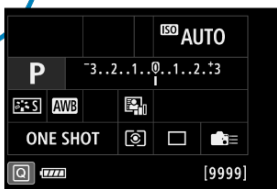

Quick Control screen

Menu Operations and Settings

[Menu Screen](#)

[Menu Setting Procedure](#)

[Dimmed Menu Items](#)

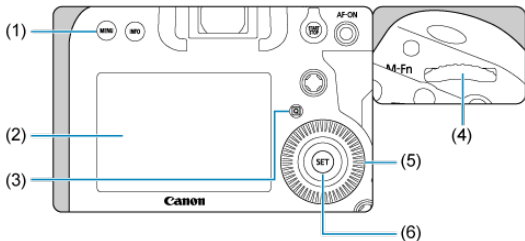

(1) <MENU> button

(2) Screen

(3) <Q> button

(4) <Main dial> Main dial

(5) <Quick control dial> Quick control dial

(6) <SET> button

Menu Screen

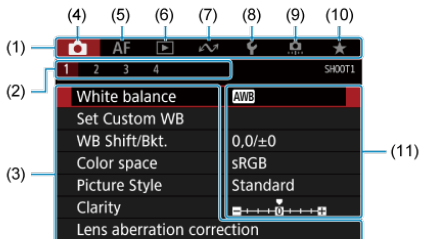

-
- (1) Main tabs
 - (2) Secondary tabs
 - (3) Menu items
 - (4) : Shooting
 - (5) **AF**: Autofocus
 - (6) : Playback
 - (7) : Communication features
 - (8) : Set-up
 - (9) : Custom Functions
 - (10) : My Menu
 - (11) Menu settings
-

1. Display the menu screen.

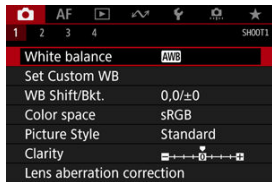

- Press the < MENU > button to display the menu screen.

2. Select a tab.

- Each time you press the < Q > button, the main tab (group of functions) will switch.
- Turn the <  > dial to select a secondary tab.

3. Select an item.

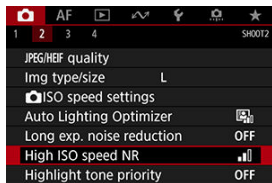

- Turn the <  > dial to select an item, then press <  >.

4. Select an option.



- Turn the <  > dial to select an option.
- The current setting is indicated in blue.

5. Set an option.

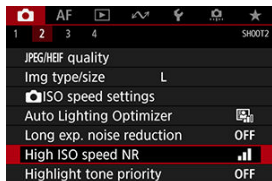

- Press <  > to set it.

6. Exit the setting.

- Press the < **MENU** > button to return to shooting standby.

Note

- The description of menu functions hereafter assumes that you have pressed the < **MENU** > button to display the menu screen.
- Menu operations are also possible by tapping on the menu screen or using <  >.
- To cancel the operation, press the < **MENU** > button.

Dimmed Menu Items

Example: When Highlight tone priority has been set

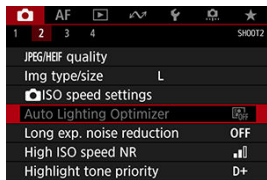

Dimmed menu items cannot be set. The menu item is dimmed if another function setting is overriding it.

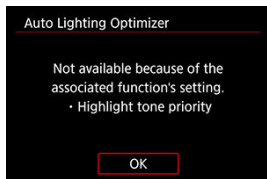

You can see the overriding function by selecting the dimmed menu item and pressing < (SET) >.

If you cancel the overriding function's setting, the dimmed menu item will become settable.

Caution

- You may not be able to see the overriding function for certain dimmed menu items.

Note

- In [**Reset camera**], you can reset menu functions to the default settings by selecting [**Basic settings**] in [**Reset individual settings**] (🔗).

Quick Control

You can directly and intuitively select and set the settings displayed.
Basic operations are the same for the Quick Control screen and Custom Quick Control screen (🔍).

1. Press the < Q > button (🔍10).

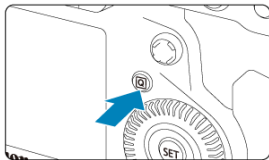

2. Select a setting item.

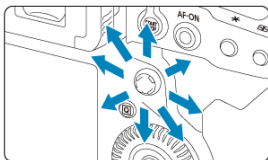

- Select with <  >.





- Example of a screen in viewfinder shooting

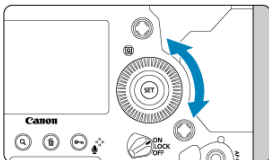
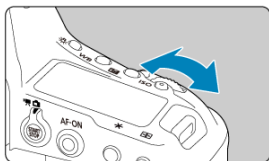

- Example of a screen in Live View shooting

3. Select an option.



- Turn the <  > or <  > dial to adjust the setting. Some items are set by pressing a button after this.

Touch-Screen Operation

[Tapping](#)

[Dragging](#)





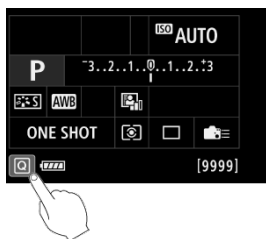

Tapping

Sample screen (Quick Control)



- Use your finger to tap (touch briefly and then remove your finger from) the screen.
- For example, when you tap [Q], the Quick Control screen appears. By tapping on [↶], you can return to the preceding screen.

 **Note**

- If [: **Beep**] is set to [**Touch** , the beep will not sound for touch operations ().
- Responsiveness to touch operations can be adjusted in [: **Touch control**] ().
- Touching the screen does not change settings (touch control is disabled) when [ **(VF shoot) Safety lock**] is selected in [: **Touch control**] and you have specified button operations (except for menu-based function setup) for the following functions. This enables you to avoid changing settings accidentally by touching the screen with your nose.
 - White balance
 - Exposure compensation
 - ISO speed
 - Shooting mode
 - AF operation/drive mode
 - Flash exposure compensation/Metering mode
 - AEB setting
 - AF point selection

Dragging

Sample screen (Menu screen)

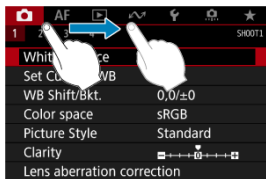

- Slide your finger while touching the screen.

Shooting Mode

You can shoot in a variety of ways by setting your preferred shutter speed, aperture value, exposure, and more.

Note

- Set the power switch to < ON > in advance.



- [P: Program AE](#)
- [Tv: Shutter-Priority AE](#)
- [Av: Aperture-Priority AE](#)
- [M: Manual Exposure](#)
- [bulb: Long \(Bulb\) Exposures](#)

P: Program AE

The camera automatically sets the shutter speed and aperture value to suit the subject's brightness.

* <P> stands for Program.

* AE stands for Auto Exposure.

1. Set the shooting mode to <P>.

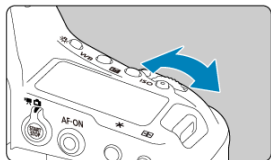

- Press the <MODE> button and turn the <⚙️> or <⦿> dial to select <P>.

2. Focus on the subject.



- As you look through the viewfinder, aim the AF point over the subject, then press the shutter button halfway.
- After the camera focuses, the focus indicator < ● > in the lower right of the viewfinder lights up (in One-Shot AF mode).
- The shutter speed and aperture value are set automatically and displayed in the viewfinder and on the top LCD panel.

3. Check the display.

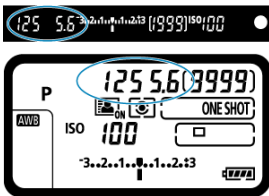

- Standard exposure is available unless the shutter speed and aperture value are blinking.

4. Take the picture.

- Compose the shot and press the shutter button completely.

Caution



- If the "30" shutter speed and the lowest aperture value blink, it indicates underexposure. Increase the ISO speed or use flash.



- If the "8000" shutter speed and the highest aperture value blink, it indicates overexposure. Lower the ISO speed or use an ND filter (sold separately) to reduce the amount of light entering the lens.

Note

Program shift

- With Program AE, you can freely change the combination (program) of shutter speed and aperture value set by the camera while maintaining the same exposure. This is called Program shift.
- With Program shift, you can press the shutter button halfway, then turn the <  > dial until the desired shutter speed or aperture value is displayed.
- Program shift will be canceled automatically when the metering timer (⌚6) ends (exposure setting display turns off).
- Program shift cannot be used with flash.

Minimizing blurred photos

- Effective options include Single Soft shooting (🔗) and mirror lockup (🔗).
- Effective options for continuous shooting include Soft continuous shooting and Soft low speed continuous shooting (🔗).
- Use a sturdy tripod that can bear the weight of the shooting equipment. Attach the camera securely to the tripod.
- Using a remote switch or similar accessory is recommended (🔗).

? FAQ

- **The focus indicator < ● > blinks, and the camera cannot focus.**
Aim the Area AF frame over an area with good contrast, then press the shutter button halfway. If you are too close to the subject, move away and shoot again.
- **Multiple AF points are displayed simultaneously.**
Focus has been achieved at all those points. It is fine to shoot, as long as at least one of the AF points is on the subject.
- **The focus indicator < ● > does not light up.**
In this state, the camera focuses continuously with AI Servo AF, so the AF status indicator < AF > is displayed, but not the focus indicator < ● >. Note that with AI Servo AF, shooting with the focus locked (🔗) is not possible.
- **Pressing the shutter button halfway does not focus on the subject.**
If the lens focus mode switch is set to < MF > (manual focus), set it to < AF > (autofocus).
- **The shutter speed and aperture value are blinking.**
Since it is too dark, taking the picture may result in a blurred subject due to camera shake. Using a tripod or a Canon EL/EX series Speedlite (sold separately, 🔗) is recommended.
- **The bottom of pictures taken with flash is unnaturally dark.**
If a hood is attached to the lens, it may obstruct light from the flash. If the subject is close, detach the hood before taking the picture with flash.

Tv: Shutter-Priority AE

In this mode, you set the shutter speed and the camera automatically sets the aperture value to obtain the standard exposure matching the brightness of the subject. A faster shutter speed can freeze the action of a moving subject. A slower shutter speed can create a blurred effect, giving the impression of motion.

* < **Tv** > stands for Time value.





Blurred motion
(Slow speed: 1/30 sec.)



Frozen motion
(Fast speed: 1/2000 sec.)

-
1. Set the shooting mode to < **Tv** >.



- Press the < **MODE** > button and turn the <  > or <  > dial to select < **Tv** >.

2. Set the desired shutter speed.

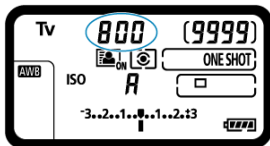

- Watch the top LCD panel as you turn the <  > dial.

3. Focus on the subject.

- Press the shutter button halfway.
- The aperture value is set automatically.

4. Check the display and shoot.



- As long as the aperture value is not blinking, the standard exposure will be obtained.

 Caution



- If the lowest aperture value blinks, it indicates underexposure. Turn the  dial to set a slower shutter speed until the aperture value stops blinking or set a higher ISO speed.



- If the highest aperture value blinks, it indicates overexposure. Turn the  dial to set a faster shutter speed until the aperture value stops blinking, or set a lower ISO speed.

 Note

Shutter speed display

- Shutter speeds from **8000** to **4** indicate the denominator of the fractional shutter speed. For example, **125** indicates 1/125 sec. Additionally, **0"5** indicates 0.5 sec. and **15"**, 15 sec.

Av: Aperture-Priority AE

[Depth-of-Field Preview](#)

In this mode, you set the desired aperture value and the camera sets the shutter speed automatically to obtain the standard exposure matching the subject brightness. A higher f/number (smaller aperture hole) will make more of the foreground and background fall within acceptable focus. On the other hand, a lower f/number (larger aperture hole) will make less of the foreground and background fall within acceptable focus.

* < **Av** > stands for Aperture value (aperture opening).



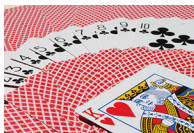

Blurred background
(With a low aperture value: f/5.6)



Sharp foreground and background
(With a high aperture value: f/32)

1. Set the shooting mode to < **Av** >.



- Press the < **MODE** > button and turn the <  > or <  > dial to select < **Av** >.

2. Set the desired aperture value.

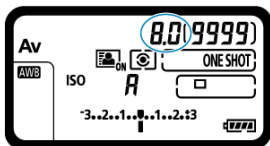

- Watch the top LCD panel as you turn the <  > dial.

3. Focus on the subject.

- Press the shutter button halfway.
- The shutter speed is set automatically.

4. Check the display and shoot.

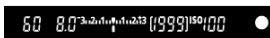

- As long as the shutter speed is not blinking, the standard exposure will be obtained.

Caution



- If the "30''" shutter speed blinks, it indicates underexposure. Turn the <  > dial to decrease the aperture value (open the aperture) until the shutter speed blinking stops or set a higher ISO speed.



- If the "8000" shutter speed blinks, it indicates overexposure. Turn the <  > dial to increase aperture value (close the aperture) until the shutter speed blinking stops or set a lower ISO speed.

Note

Aperture value display

- The higher the value, the smaller the aperture opening will be. The aperture value displayed varies depending on the lens. If no lens is attached to the camera, "00" will be displayed for the aperture.

Depth-of-Field Preview

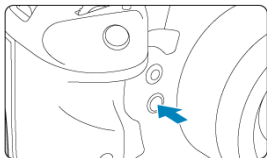

Press the depth-of-field preview button to stop down the lens to the current aperture setting and check the area in focus (depth of field).

Note

- The larger the aperture value, the wider the area (from the foreground to the background) in focus, but the darker the viewfinder display.
- The depth-of-field effect is readily apparent on the Live View image as you change the aperture value and press the depth-of-field preview button (📷).
- Exposure is locked (AE lock) as you hold down the depth-of-field preview button.
- Pressing the depth-of-field preview button when a Speedlite 470EX-AI is attached with the < **AI.B** > switch set to < **F** > (full-auto) starts AI.B full-auto distance measurement.

M: Manual Exposure



[Exposure Compensation with ISO Auto](#)

In this mode, you set both the shutter speed and aperture value as desired. To determine the exposure, refer to the exposure level indicator in the viewfinder or use a commercially available exposure meter.

* < **M** > stands for Manual.

1. Set the shooting mode to < **M** >.





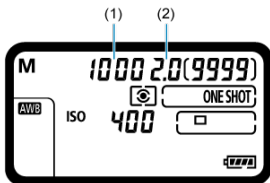

- Press the < **MODE** > button and turn the <  > or <  > dial to select < **M** >.

2. Set the ISO speed ().

3. Set the shutter speed and aperture value.



- To set the shutter speed (1), turn the <  > dial, and to set the aperture value (2), turn the <  > dial.
- If these settings cannot be set, set the power switch to < **ON** >, then turn the <  > or <  > dial.

4. Focus on the subject.

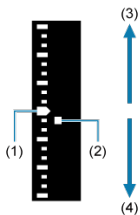
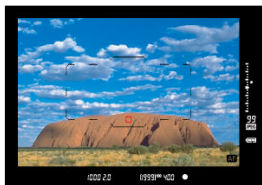

- (1) Standard exposure index
- (2) Exposure level mark
- (3) Brighter (+)
- (4) Darker (-)

- Press the shutter button halfway.
- The exposure value is displayed in the viewfinder and on the top LCD panel.
- To see how far the current exposure level < ■ > is from standard exposure < ■ >, check the exposure level indicator at right in the viewfinder.

5. Set the exposure and take the picture.

- Check the exposure level indicator and set the desired shutter speed and aperture value.
- < ▲ > or < ▼ > is shown at the ends of the exposure level indicator if the exposure level exceeds ± 3 stops from standard exposure.

Exposure Compensation with ISO Auto

If the ISO speed is set to "A" (AUTO) for manual exposure shooting, you can set exposure compensation (☒) as follows:

- With [☒] : Expo comp (hold btn, turn - Quick Control screen

⚠ Caution

- Exposure may not be as expected when ISO Auto is set, because the ISO speed is adjusted to ensure standard exposure for your specified shutter speed and aperture value. In this case, set the exposure compensation.
- Exposure compensation is not applied in flash photography with ISO Auto, even if you have set an exposure compensation amount.

📄 Note



- In < M > mode with ISO Auto, < [☒] > (Evaluative metering), and [☒, 2: AE lock meter. mode after focus] set to the default setting (☒), holding down the shutter button halfway will lock the ISO speed after focus is achieved with One-Shot AF.
- When ISO Auto is set, you can press the < * > button to lock the ISO speed.
- If you press the < * > button and recompose the shot, you can see the exposure level difference on the exposure level indicator compared to when the < * > button was pressed.
- Any existing exposure compensation amount is maintained if you switch to < M > mode with ISO Auto after using exposure compensation in < P >, < Tv >, or < Av > mode (☒).
- To coordinate exposure compensation in 1/2-stop increments with ISO speed set in 1/3-stop increments when [☒, 1: Exposure level increments] is set to [1/2-stop, Exp comp 1/2-stop] and used with ISO Auto, exposure compensation is further adjusted by adjusting shutter speed. However, the shutter speed displayed will not change.

bulb: Long (Bulb) Exposures

In this mode, the shutter stays open as long as you hold down the shutter button completely, and closes when you let go of the shutter button. Use bulb exposures for night scenes, fireworks, astrophotography, and other subjects requiring long exposures.



1. Set the shooting mode to < buLb >.

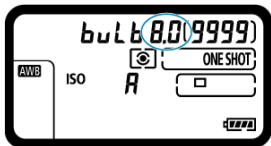

- Press the < MODE > button and turn the <  > or <  > dial to select < buLb >.

2. Set the desired aperture value.



- Watch the top LCD panel as you turn the <  > or <  > dial.

3. Take the picture.

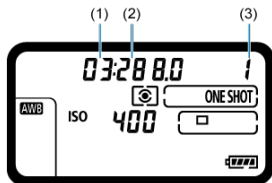





- (1) Minutes
- (2) Seconds
- (3) Hours

- The exposure will continue for as long as you keep the shutter button pressed completely.
- Elapsed exposure time is displayed on the top LCD panel.

Caution

- Do not point the camera toward an intense light source, such as the sun or an intense artificial light source. Doing so may damage the image sensor or the camera's internal components.
- Long bulb exposures produce more noise in the image than usual.
- If ISO Auto is set, ISO 400 will be set.
- When shooting bulb exposures with both the self-timer and mirror lockup instead of the bulb timer, keep pressing the shutter button completely (until the self-timer and bulb exposure time have elapsed). No shot will be taken if you release the shutter button during self-timer countdown, although a shutter-release sound will be played.

Note

- You can reduce the noise generated during long exposures by using [ **Long exp. noise reduction**] ().
- Using a tripod is recommended for bulb exposures. You can also use mirror lockup ().
- You can use Remote Switch RS-80N3 or Timer Remote Controller TC-80N3 (both sold separately) for bulb exposures ().

Shooting and Recording

This chapter describes shooting and introduces menu settings on the shooting () tab.

- [Still Photo Shooting](#)
- [Still Photo Shooting \(Live View Shooting\)](#)
- [Movie Recording](#)

Still Photo Shooting

- [Tab Menus: Still Photo Shooting \(Viewfinder Shooting\)](#)
- [White Balance](#)
- [Custom White Balance](#)
- [White Balance Correction](#)
- [Color Space](#)
- [Picture Style Selection](#)
- [Picture Style Customization](#)
- [Picture Style Registration](#)
- [Clarity](#)
- [Lens Aberration Correction](#)
- [Image Quality](#)
- [ISO Speed Settings for Still Photos](#)
- [Auto Lighting Optimizer](#)
- [Long Exposure Noise Reduction](#)
- [High ISO Speed Noise Reduction](#)
- [Highlight Tone Priority](#)
- [Image Review](#)
- [Shutter Release Without Card](#)
- [Mirror Lockup](#)
- [Dust Delete Data Acquisition](#)
- [Shooting With Speedlites](#)
- [Flash Function Settings](#)
- [Anti-Flicker Shooting](#)
- [Multiple Exposures](#)
- [HDR PQ Settings](#)
- [Metering Mode Selection](#)
- [Manual Exposure Compensation](#)
- [Auto Exposure Bracketing \(AEB\)](#)
- [Exposure Lock \(AE Lock\)](#)
- [Using the Eyepiece Shutter](#)
- [Using a Remote Switch](#)

Tab Menus: Still Photo Shooting (Viewfinder Shooting)

● Shooting 1

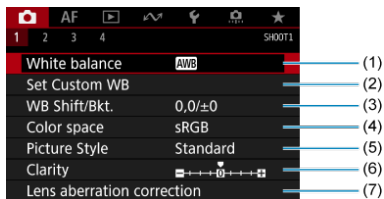

- (1) [White balance](#)
- (2) [Set Custom WB](#)
- (3) [WB Shift/Bkt.](#)
- (4) [Color space](#)
- (5) Picture Style
 - [Picture Style Selection](#)
 - [Picture Style Customization](#)
 - [Picture Style Registration](#)
- (6) [Clarity](#)
- (7) [Lens aberration correction](#)

● Shooting 2

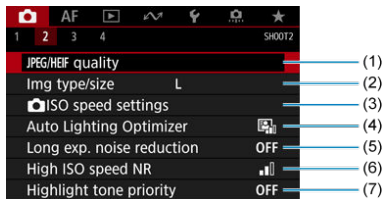

- (1) [JPEG/HEIF quality](#)
- (2) [Img type/size](#)
- (3) [ISO speed settings](#)
- (4) [Auto Lighting Optimizer](#)
- (5) [Long exp. noise reduction](#)
- (6) [High ISO speed NR](#)
- (7) [Highlight tone priority](#)

● Shooting 3

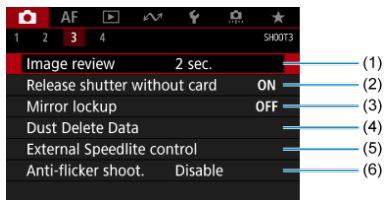

- (1) [Image review](#)
- (2) [Release shutter without card](#)
- (3) [Mirror lockup](#)
- (4) [Dust Delete Data](#)
- (5) [External Speedlite control](#)
- (6) [Anti-flicker shoot.](#)

● Shooting 4

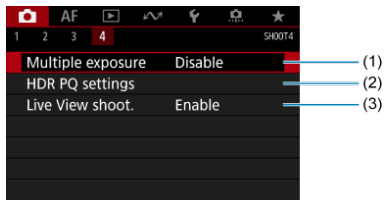

- (1) [Multiple exposure](#)
- (2) [HDR PQ settings](#)
- (3) [Live View shoot.](#)

White Balance

☑ [White Balance](#)

☑ [\[AWB\] Auto White Balance](#)

☑ [\[K\] Color Temperature](#)

White balance (WB) is for making the white areas look white. Normally, the Auto **[AWB]** (Ambience priority) or **[AWBW]** (White priority) setting will obtain the correct white balance. If natural-looking colors cannot be obtained with Auto, you can select the white balance to match the light source or set it manually by shooting a white object.

1. Press the **<WB>** button (ⓘ6).

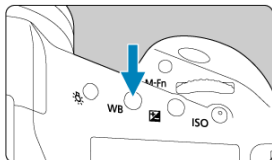



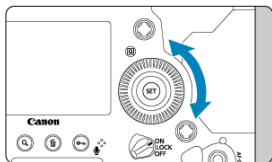







2. Select a white balance setting.



- Watch the top LCD panel or look through the viewfinder as you turn the **<SET>** dial.

(Approx.)

Display	Mode	Color Temperature (K: Kelvin)
	Auto: Ambience priority	3000–7000
	Auto: White priority	
	Daylight	5200
	Shade	7000
	Cloudy, twilight, sunset	6000
	Tungsten light	3200
	White fluorescent light	4000
	When using Flash	Automatically set*
	Custom	2000–10000
	Color temperature	2500–10000

* Applicable with Speedlites having a color temperature transmission function. Otherwise, it will be fixed to approx. 6000K.

Note

- To set a personal white balance, select [**K**: PC-*] in step 2. For instructions on registering a personal white balance to the camera, refer to the EOS Utility Instruction Manual. Up to five personal white balances can be registered using EOS Utility. Register separate ones for still photos and movies, as needed.

White Balance

The human eye adapts to changes in lighting so that white objects look white under all kinds of lighting. Digital cameras determine white from the color temperature of lighting and, based on this, apply image processing to make color tones look natural in your shots.

[AWB] Auto White Balance

With [AWB], you can slightly increase the intensity of the image's warm color cast when shooting a tungsten-light scene.

If you select [AWBW], you can reduce the intensity of the image's warm color cast.

1. Select [📷: White balance].

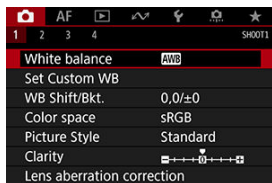

2. Select [AWB].

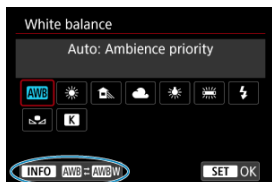

- With [AWB] selected, press the <INFO> button.

3. Select an option.

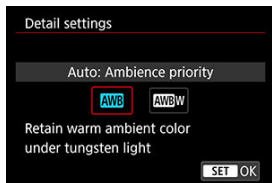

 Caution

Precautions when set to [AWBW] (White priority)

- The warm color cast of subjects may fade.
- When multiple light sources are included in the scene, the warm color cast of the picture may not be reduced.
- When using flash, the color tone will be the same as with [AWB] (Ambience priority).

[K] Color Temperature

1. Press the < WB > button (⦿6).

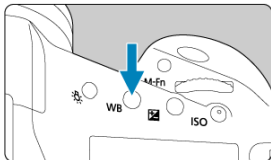

2. Select < K >.



- Watch the top LCD panel as you turn the < ⦿ > dial to select < K >.

3. Set the value.



- Turn the < ⦿ > dial to set the value.
- The color temperature can be set from approx. 2500K to 10000K in 100K increments.

 Caution

- When setting the color temperature for an artificial light source, set the white balance correction (magenta or green bias) as necessary.
- When setting <  > to a value measured with a commercially available color temperature meter, take some test shots in advance and adjust the setting as needed to compensate for any difference between the color temperature meter and the camera.

Custom White Balance

[☑ Registering Custom White Balances](#)

[☑ Selecting and Shooting with Custom White Balances](#)

[☑ Naming Custom White Balances](#)

With custom white balance, you can manually set the white balance for the specific light source of the shooting location. Make sure to perform this procedure under the light source at the actual location of the shoot.

Up to five custom white balances can be registered to the camera. You can also add a name (caption) to registered custom white balances. Register separate ones for still photos and movies, as needed.

Registering Custom White Balances

To register custom white balances, you can either register a picture taken during this process or register an image recorded on a card.



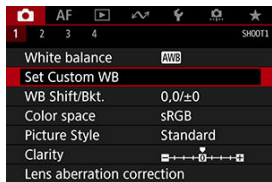

Shooting and registering white balances

1. Select [: Set Custom WB].

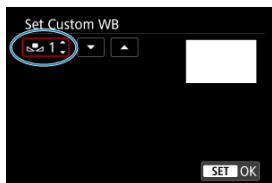

2. Select a custom white balance number to be registered.



- Press <  >.
- Turn the <  > dial to select a number from 1 to 5 for <  * >, then press <  >. The custom white balance will be registered to the selected number.

3. Select [Record and register WB].

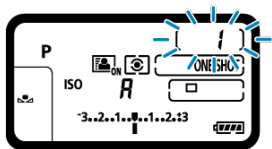
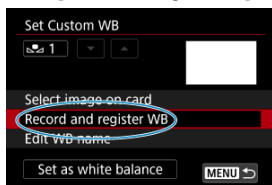

- The screen now turns off, and the selected number blinks on the top LCD panel.

4. Shoot a plain white object.

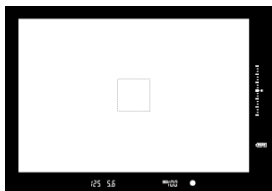

- Look through the viewfinder and aim the outlined area over a plain white object, so that white fills the area.
- Focus manually and shoot with the standard exposure set for the white object.
- You can use any of the white balance settings.



- The custom white balance is registered to the camera.
- To shoot with the registered custom white balance, see [Selecting and Shooting with Custom White Balances](#).

! Caution

- If the exposure obtained in step 4 differs greatly from the standard exposure, a correct white balance may not be obtained.

Note

- Custom white balances can also be registered as follows.
 1. Press the < WB > button, then turn the < [] > dial to select < [] > ([]).
 2. Next, turn the < [] > dial to select a number to register the custom white balance to.
 3. Press the < [] > button.
 - The number selected in step 2 blinks on the top LCD panel.
 4. Shoot a plain white object as described in step 4.
 - The custom white balance will be registered to the selected number.
- If [**Correct WB may not be obtained with the selected image**] is displayed in step 4, return to step 1 and shoot again.
- Your shot in step 4 is not recorded to a card.
- More accurate white balance can be obtained by shooting a commercially available gray card or standard 18% gray reflector instead of a white object.

Selecting an image recorded on a card

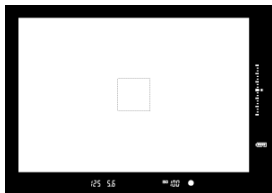

1. Shoot a plain white object.

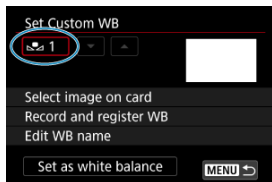

- Shoot a plain white object as described in step 4 in [Shooting and registering white balances](#).
2. On the [] tab, select [Set Custom WB].

3. Select a custom white balance number to be registered.



- Press < SET >.
- Turn the <  > dial to select a number from 1 to 5 for <  * >, then press < SET >. The custom white balance will be registered to the selected number.

4. Select [Select image on card].

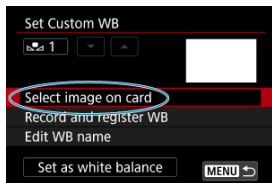

- Images recorded on the card are displayed.

5. Select an image to register as the custom white balance.



- Turn the <  > dial to select the image captured in step 1, then press < SET >.

6. Select [OK].

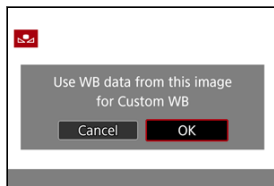

- The custom white balance will be registered to the camera.
- Check the message and select [**OK**] to return to the screen in step 3.

Caution

- These images cannot be selected in step 5: Images captured with the Picture Style set to [**Monochrome**], multiple-exposure images, HDR images, Frame Grab images from 4K movies, and images shot with another camera.

Note

- To shoot with a registered custom white balance, first select the number of the registered custom white balance.

1. Select the custom white balance number.

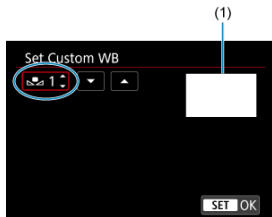

(1) Registered image

- On the **[Set Custom WB]** screen, select the number of the registered custom white balance.

2. Select **[Set as white balance]**.

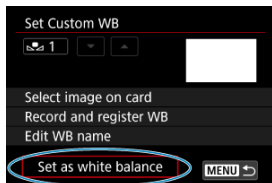



- The white balance setting changes to $\langle \text{WB} \ast \rangle$.

3. Take the picture.

- The picture is taken with the $\langle \text{WB} \ast \rangle$ setting applied.



Note

- You can also select registered custom white balance numbers while viewing the top LCD panel. To do this, press the < WB > button, then turn the <  > dial to select <  >. Next, turn the <  > dial to select a registered custom white balance number.

Naming Custom White Balances

You can add a name (caption) to the five registered custom white balances (custom white balance nos. 1–5).

1. Select the custom white balance number.

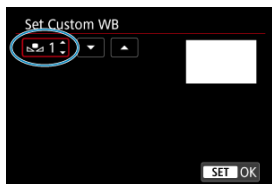

- On the **[Set Custom WB]** screen, select the number of the registered custom white balance to add a name to.

2. Select [Edit WB name].

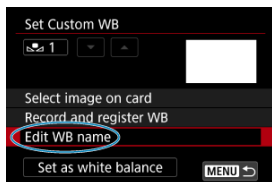

3. Enter text.



- Use the < [DIAL] > or < [DIAL] > dial to select a character, then press < [SET] > to enter it.
- By selecting [[DIAL]], you can change the input mode.
- To delete single characters, select [[X]] or press the < [DELETE] > button.

4. Exit the setting.

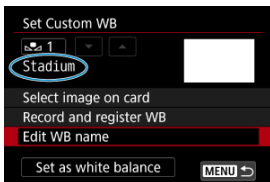

- Press the < [MENU] > button, then press [OK].
- The information is saved, and display returns to the screen in step 2.
- The entered name is displayed below < [DIAL] * >.

Note

- As names, it may be helpful to enter the names of places where you registered the custom white balances, or the names of the light sources.

White Balance Correction

[White Balance Correction](#)

[White Balance Auto Bracketing](#)

You can correct the white balance that is set. This adjustment will have the same effect as using a commercially available color temperature conversion filter or color compensating filter.

White Balance Correction

1. Select [: WB Shift/Bkt.].

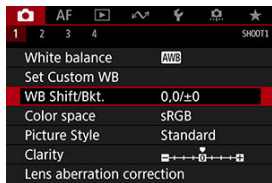

2. Set the white balance correction.

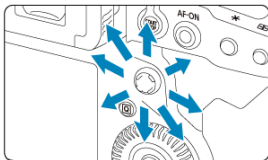

Sample setting: A2, G1

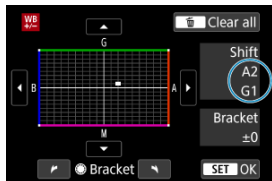

- Use $\leftarrow \rightarrow$ to move the "■" mark on the screen to your preferred position.
- B is for blue, A for amber, M for magenta, and G for green. White balance is corrected in the direction you move the mark.
- On the right of the screen, **[Shift]** indicates the direction and correction amount, respectively.
- Pressing the $\leftarrow \rightarrow$ button will cancel all the **[WB Shift/Bkt.]** settings.
- Press $\leftarrow \text{SET}$ to exit the setting.

Note

- $\leftarrow \text{WB}$ is displayed on the top LCD panel during white balance correction.
- You can set the camera to display $\leftarrow \text{WB}$ in the viewfinder to notify you if white balance has been corrected (✔).
- One level of the blue/amber correction is equivalent to approx. 5 mireds of a color temperature conversion filter. (Mired: Unit of measure for color temperature used to indicate values such as the density of a color temperature conversion filter.)

White Balance Auto Bracketing

White balance bracketing (WB Bkt.) enables you to capture three images at once with different color tones.

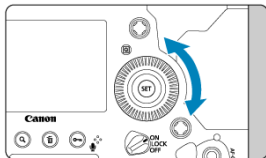

Setting the white balance bracketing amount

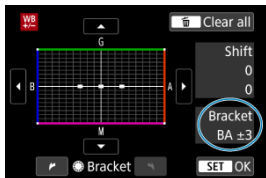

- In step 2 for “[White Balance Correction](#)”, when you turn the  dial, the “■” mark on the screen will change to “■ ■ ■” (3 points). Turning the dial clockwise sets the B/A bracketing, and turning it counterclockwise sets the M/G bracketing.

B/A bias ± 3 levels



- On the right of the screen, **[Bracket]** indicates the bracketing direction and correction amount.
- Pressing the  button will cancel all the **[WB Shift/Bkt.]** settings.
- Press  to exit the setting.



Bracketing sequence

The images will be bracketed in the following sequence: 1. Standard white balance, 2. Blue (B) bias, and 3. Amber (A) bias, or 1. Standard white balance, 2. Magenta (M) bias, and 3. Green (G) bias.

Caution

- During white balance bracketing, the maximum burst for continuous shooting will be lower.
- Since three images are recorded for one shot, it takes longer to record the image to the card.

Note

- You can also set white balance correction and AEB together with white balance bracketing. If you set AEB in combination with white balance bracketing, a total of nine images will be recorded for a single shot.
- The white balance icon blinks to indicate that white balance bracketing has been set.
- You can change the bracketing sequence  and number of shots  for the white balance bracketing.
- **Bracket** stands for bracketing.

Color Space

[Adobe RGB](#)

The range of reproducible colors is called the “color space.” For normal shooting, sRGB is recommended.

1. Select [: Color space].
2. Set a color space option.

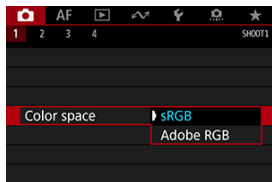

- Select [**sRGB**] or [**Adobe RGB**], then press <  >.

Adobe RGB

This color space is mainly used for commercial printing and other professional applications. Recommended when using equipment such as Adobe RGB-compatible monitors or DCF 2.0 (Exif 2.21 or later) compatible printers.

Note

- File names of still photos shot in the Adobe RGB color space begin with “_”.
- The ICC profile is not appended. For the descriptions about the ICC profile, refer to the Digital Photo Professional Instruction Manual (EOS software).

Picture Style Selection

[Picture Style Characteristics](#)

[Symbols](#)

Just by selecting a preset Picture Style, you can obtain image characteristics effectively matching your photographic expression or the subject.

1. Select [📷: Picture Style].

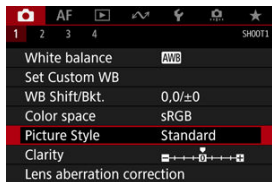

2. Select a Picture Style.



Picture Style Characteristics

-  **Auto**

The color tone will be adjusted automatically to suit the scene. The colors will look vivid for blue skies, greenery and sunsets, particularly in nature, outdoor, and sunset scenes.

 **Note**

- If the desired color tone is not obtained with **[Auto]**, use another Picture Style.

-  **Standard**

The image looks vivid, sharp, and crisp. Suitable for most scenes.

-  **Portrait**

For smooth skin tones, with slightly less sharpness. Suited for close-up portraits. Skin tone can be adjusted by changing **[Color tone]** as described in [Settings and Effects](#).

-  **Landscape**

For vivid blues and greens, and very sharp and crisp images. Effective for impressive landscapes.

-  **Fine Detail**

For detailed rendering of fine subject contours and subtle textures. The colors will be slightly vivid.

-  **Neutral**

For retouching later on a computer. Makes images subdued, with lower contrast and natural color tones.

-  **Faithful**

For retouching later on a computer. Faithfully reproduces the actual colors of subjects as measured in daylight with a color temperature of 5200K. Makes images subdued, with lower contrast.



-  **Monochrome**

Creates black-and-white images.

 **Caution**

- Color images cannot be recovered from JPEG images shot with the **[Monochrome]** Picture Style.

 **Note**

- < **B/W** > is displayed on the top LCD panel when **[Monochrome]** is set. You can also set the camera to display <  > in the viewfinder ().

-  **User Def. 1–3**

You can add a new style based on presets such as **[Portrait]** or **[Landscape]** or a Picture Style file, then adjust it as needed (). With any User Defined Picture Style that has not yet been registered, pictures will be taken with the same characteristics settings as with the default settings of **[Standard]**.

Symbols

Icons on the Picture Style selection screen represent [Strength], [Fineness], and [Threshold] for [Sharpness] as well as [Contrast] and other parameters. The numbers indicate the values for these settings specified for the respective Picture Style.

Picture Style	Sharpness	Picture Style	Sharpness
Auto	4, 2, 3, 0, 0, 0	Fine Detail	4, 1, 1, 0, 0, 0
Standard	4, 2, 3, 0, 0, 0	Neutral	0, 2, 2, 0, 0, 0
Portrait	3, 2, 4, 0, 0, 0	Faithful	0, 2, 2, 0, 0, 0
Landscape	5, 2, 3, 0, 0, 0	Monochrome	4, 2, 3, 0, N, N
Fine Detail	4, 1, 1, 0, 0, 0	User Def. 1	Standard
Neutral	0, 2, 2, 0, 0, 0	User Def. 2	Standard

	Sharpness	
		Strength
		Fineness
		Threshold
	Contrast	
	Saturation	
	Color tone	
	Filter effect (Monochrome)	
	Toning effect (Monochrome)	

⚠ Caution

- For movie recording, "**" is indicated for the [Fineness] and [Threshold] parameters of [Sharpness]. [Fineness] and [Threshold] cannot be set for movie recording.

Picture Style Customization

 [Settings and Effects](#)

  [Monochrome Adjustment](#)

You can customize any Picture Style by changing it from the default settings. For details on customizing **[Monochrome]**, see  [Monochrome Adjustment](#).

1. Select : Picture Style.

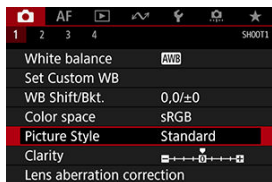

2. Select a Picture Style.



- Select the Picture Style to adjust, then press the < **INFO** > button.

3. Select an item.

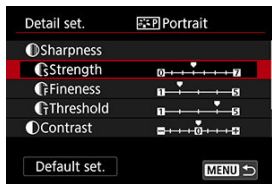

- For details on settings and effects, see [Settings and Effects](#).

4. Set the effect level.

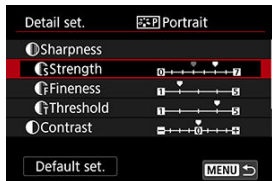







- Press the < MENU > button to save the adjusted setting and return to the Picture Style selection screen.
- Any settings you change from default values are displayed in blue.

Note

- For movie recording, [Fineness] and [Threshold] for [Sharpness] cannot be set (not displayed).
- By selecting [Default set.] in step 3, you can restore the parameter settings of the respective Picture Style to the defaults.
- To shoot with the Picture Style you adjusted, first select the adjusted Picture Style, then shoot.

Settings and Effects

	Sharpness		
	 Strength	0: Weak outline emphasis	7: Strong outline emphasis
	 Fineness^{*1}	1: Fine	5: Grainy
	 Threshold^{*2}	1: Low	5: High
	Contrast	-4: Low contrast	+4: High contrast
	Saturation	-4: Low saturation	+4: High saturation
	Color tone	-4: Reddish skin tone	+4: Yellowish skin tone

* 1: Indicates the edge thinness that enhancement applies to. The smaller the number, the finer the outlines that can be emphasized.

* 2: Contrast threshold between edges and surrounding image areas, which determines edge enhancement. The smaller the number, the more the outline will be emphasized when the contrast difference is low. However, noise tends to be more noticeable when the number is smaller.

Filter effect

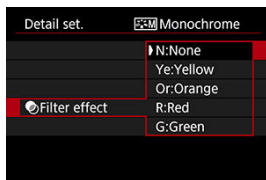

With a filter effect applied to a monochrome image, you can make white clouds or green trees stand out more.

Filter	Sample Effects
N:None	Normal black-and-white image with no filter effects.
Ye:Yellow	Blue sky will look more natural, and white clouds will look crisper.
Or:Orange	The blue sky will look slightly darker. The sunset will look more brilliant.
R:Red	The blue sky will look quite dark. Fall leaves will look crisper and brighter.
G:Green	Skin tones and lips will appear muted. Green tree leaves will look crisper and brighter.

Note

- Increasing **[Contrast]** will make the filter effect more pronounced.

Toning effect

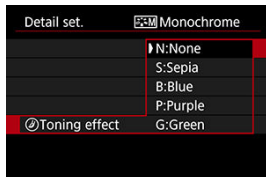

By applying a toning effect, you can create a monochrome image in the selected color. Effective when you want to create memorable images.

Picture Style Registration

You can select a base Picture Style such as **[Portrait]** or **[Landscape]**, adjust it as desired, and register it under **[User Def. 1]** – **[User Def. 3]**. Useful when creating several Picture Styles with different settings.

Picture Styles that you have registered on the camera using EOS Utility (EOS software, [🔗](#)) can also be modified here.

1. Select **[📷: Picture Style]**.

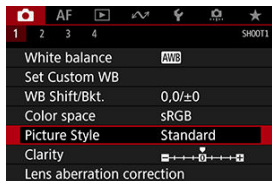

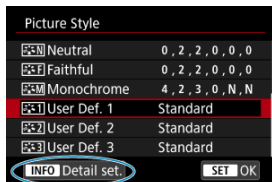

2. Select **[User Def.]**.

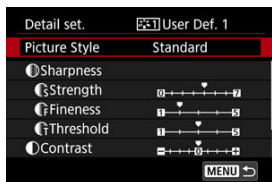

- Select **[User Def. *]**, then press the **<INFO>** button.

3. Press < >.



- With [Picture Style] selected, press <  >.

4. Select a base Picture Style.

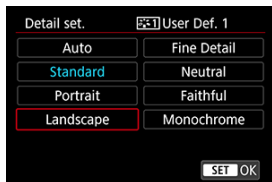

- Select the base Picture Style.
- Also select styles this way when adjusting styles registered to the camera with EOS Utility (EOS software).

5. Select an item.

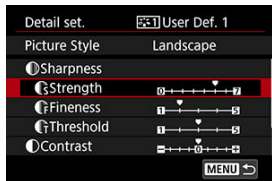

6. Set the effect level.

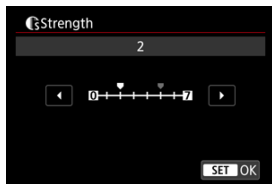

- For details, see [Picture Style Customization](#).

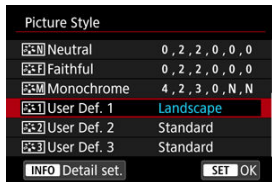

- Press the <MENU> button to save the adjusted setting and return to the Picture Style selection screen.
- The base Picture Style will be indicated on the right of [User Def. *].
- Blue style names in [User Def. *] have been changed from default values.

Caution

- If a Picture Style is already registered under [User Def. *], changing the base Picture Style will clear the parameter settings of the previously registered User Defined Picture Style.
- Up to three Picture Styles can be registered using EOS Utility. Register separate ones for still photos and movies, as needed.
- You can restore the default [User Def. *] style and settings by selecting [Basic settings] for [Reset individual settings] in [🔧: Reset camera].

Note

- To shoot with a registered Picture Style, select the registered [User Def. *], then shoot.
- Regarding the procedure to register a Picture Style file to the camera, refer to the EOS Utility Instruction Manual.

Clarity

You can adjust image clarity, as determined by the contrast of image edges. Set toward the negative end to make images look softer or toward the positive end for a sharper appearance.

1. Select [📷: Clarity].

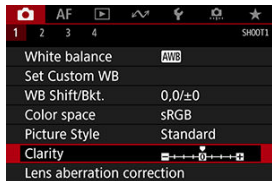

2. Set the effect level.



! Caution

- Setting clarity may darken or lighten the areas around boundaries in high-contrast images.
- The effect of this setting is not shown in Live View images.

Lens Aberration Correction

- [Peripheral Illumination Correction](#)
- [Distortion Correction](#)
- [Digital Lens Optimizer](#)
- [Chromatic Aberration Correction](#)
- [Diffraction Correction](#)

Vignetting, image distortion, and other issues may be caused by lens optical characteristics. The camera can compensate for these phenomena by using **[Lens aberration correction]**.

1. Select **[: Lens aberration correction]**.

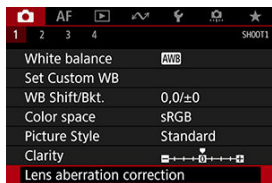

2. Select an item.

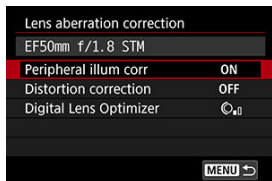

3. Select [Enable].

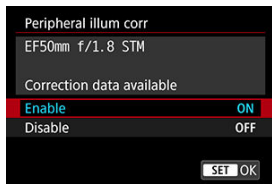

- Confirm that the name of the attached lens and (except for diffraction correction) [**Correction data available**] are displayed.
- If [**Correction data not available**] or [] is displayed, see [Digital Lens Optimizer](#).

Peripheral Illumination Correction

Vignetting (dark image corners) can be corrected.

Caution

- Depending on shooting conditions, noise may appear on the image periphery.
- The higher the ISO speed, the lower the amount of correction will be.

Note

- The amount of correction applied will be lower than the maximum correction amount applied with Digital Photo Professional (EOS software).

Distortion Correction

Distortion (image warping) can be corrected.

⚠ Caution

- To correct distortion, the camera captures a narrower image area than the area seen in viewfinder shooting, which crops the image a little and slightly lowers the apparent resolution.
- For movie recording, **[Distortion correction]** will not appear. (Correction is not possible.)
- In Live View shooting, applying distortion correction may change the angle of view slightly.
- Areas outside the recording area may be displayed if you magnify edges of the screen in Live View shooting.
- Images with distortion correction applied will not have the Dust Delete Data (Ⓢ) appended. Also, the AF point may be displayed out of position, relative to the time of shooting.
- Magnifying the periphery of the image may display parts of the image that will not be recorded.

Digital Lens Optimizer

Various aberrations from lens optical characteristics can be corrected, along with diffraction and low-pass filter-induced loss of resolution.

If [**Correction data not available**] or  is displayed by [**Digital Lens Optimizer**], you can use EOS Utility to add the lens correction data to the camera. For details, refer to the EOS Utility Instruction Manual.

Caution

- Depending on shooting conditions, noise may be intensified together with the effects of correction. Image edges may also be emphasized. Adjust Picture Style sharpness or set [**Digital Lens Optimizer**] to [**Disable**] as needed before shooting.
- The higher the ISO speed, the lower the amount of correction will be.
- For movie recording, [**Digital Lens Optimizer**] will not appear. (Correction is not possible.)

Note

- With [**Digital Lens Optimizer**] set to [**Enable(Std)**], [**Chromatic aberr corr**] and [**Diffraction correction**] are not displayed, but they are both set to [**Enable**] for shooting.

Chromatic Aberration Correction

Chromatic aberration (color fringing around subjects) can be corrected.



Note

- [Chromatic aberr corr] is not displayed when [Digital Lens Optimizer] is set to [Enable(Std)].

Diffraction Correction

Diffraction (loss of sharpness caused by the aperture) can be corrected.

Caution

- Depending on shooting conditions, noise may be intensified together with the effects of correction.
- The higher the ISO speed, the lower the amount of correction will be.

Note

- "Diffraction correction" corrects degraded resolution not only from diffraction but also from the low-pass filter and other factors. Thus, correction is also effective for exposures with the aperture wide open.
- **[Diffraction correction]** is not displayed when **[Digital Lens Optimizer]** is set to **[Enable(Std)]**.

Caution

General precautions for lens aberration correction

- Lens aberration correction cannot be applied to existing JPEG images.
- When using a non-Canon lens, setting the corrections to **[Disable]** is recommended even if **[Correction data available]** is displayed.
- The amount of correction (except diffraction correction) is less for lenses that do not provide distance information.

Note

General notes for lens aberration correction

- Effects of lens aberration correction vary by lens and shooting conditions. Also, the effect may be difficult to discern depending on the lens used, shooting conditions, etc.
- If the correction is difficult to discern, magnifying and checking the image after shooting is recommended.
- Corrections are applied even when an extender or life-size converter is attached.
- If the correction data for the attached lens is not registered to the camera, the result will be the same as when the correction is set to **[Disable]** (except for diffraction correction).
- If necessary, refer to the EOS Utility Instruction Manual as well.

Image Quality

- ☑ [◀ Image Size Selection](#)
- ☑ [RAW Images](#)
- ☑ [Guide to Image Quality Settings](#)
- ☑ [Maximum Burst for Continuous Shooting](#)
- ☑ [JPEG/HEIF Quality](#)

◀ Image Size Selection

You can specify **L**, **M1**, **M2**, or **S** for JPEG images, **L** for HEIF images, and **RAW** or **CRAW** for RAW images. Image size can be set in either of the following ways.

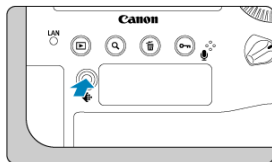

Setting size via the rear LCD panel

1. Press the <◀> button (🔍).



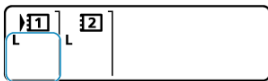





2. Select the desired image size.



- Turn the <  > dial to select the image size.
- Both RAW and JPEG images will be captured when **RAW/CRAW** and **L/M1/M2/S** are displayed together.
- Both RAW and HEIF images will be captured when **RAW/CRAW** and **L/HEIF** are displayed together.
- Turn the <  > dial to select the card for recording and playback ().



Note

- To set separate image sizes for each card when [ **Record func.**] in [: **Record func+card/folder sel.**] is set to [**Rec. separately**] (), turn the <  > dial, select a card, and set the image size.
- "Image quality" in this guide refers to both image size and JPEG/HEIF quality ().
- HEIF can be specified when [**HDR shooting HDR PQ**] in [: **HDR PQ settings**] is set to [**Enable**]. You can convert these images to JPEG images after shooting ().

Setting size via the menu

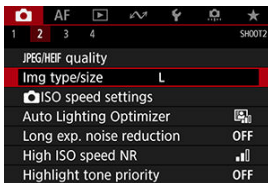
1. Select [: **Img type/size**].



- The screen displayed varies depending on [ **Record func.**] settings in [: **Record func+card/folder sel.**].

2. Set the image size.

Standard/Auto switch card/Record to multiple

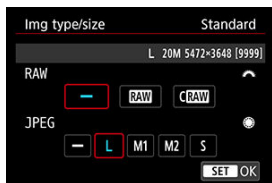

- For RAW images, turn the < > dial, and for JPEG images, turn the < > dial.
- Press < > to set it.

Record separately



- When [Record func.] in [Record func+card/folder sel.] is set to [Rec. separately], turn the < > dial to select () or (), then press < >. Note that recording separately to RAW and CRAW is not available for RAW images.



- Select an image size on the screen displayed, then press < >.

 **Note**

- In the viewfinder, maximum display of the number of shots available is 1999.
- **L** is set automatically if you set both RAW and JPEG/HEIF to [—].
- Two versions of each shot are recorded at your specified image quality when you have selected both RAW and JPEG/HEIF. Both images have the same file number but each has a different file extension, with .JPG for JPEG, .HIF for HEIF and .CR3 for RAW.
- < **JPEG** > / < **RAW** > appears at the right in the viewfinder based on your JPEG/RAW selection.
- Meanings of image size icons are as follows: **RAW**: RAW, **CRRAW**: Compact RAW, JPEG: JPEG, HEIF: HEIF, **L**: Large, **M1**: Medium 1, **M2**: Medium 2, **S**: Small.

RAW Images

RAW images are raw data from the image sensor that are recorded to the card digitally as **RAW** or **CRAW**, based on your selection. **CRAW** produces RAW images with smaller file sizes than **RAW**.

RAW images can be processed using [▶: **RAW image processing**] (🔗) to save them as JPEG or HEIF images. As the RAW image itself does not change, you can process the RAW image to create any number of JPEG or HEIF images with various processing conditions.

You can use Digital Photo Professional (EOS software) to process RAW images. You can make various adjustments to images depending upon how they will be used and can generate JPEG, HEIF, or other types of images reflecting the effects of those adjustments.

Note

- To display RAW images on a computer, using Digital Photo Professional (EOS software, hereafter DPP) is recommended.
- Older versions of DPP Ver. 4.x do not support display, processing, editing, or other operations with RAW images captured by this camera. If a previous version of DPP Ver. 4.x is installed on your computer, obtain and install the latest version of DPP from the Canon website to update it (🔗), which will overwrite the previous version. Similarly, DPP Ver. 3.x or earlier does not support display, processing, editing, or other operations with RAW images captured by this camera.
- Commercially available software may not be able to display RAW images captured by this camera. For compatibility information, contact the software manufacturer.

Guide to Image Quality Settings

See [Performance Data](#) for details on file size, number of shots available, maximum burst, and other estimated values.

Maximum Burst for Continuous Shooting

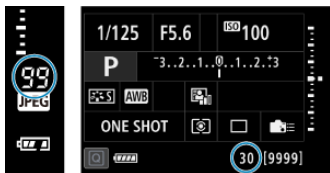

Approximate maximum burst is shown at the right in the viewfinder, on the Quick Control screen, and at the bottom of the Custom Quick Control screen.

Caution

- Maximum burst is shown even without a card in the camera, so make sure a card is inserted before shooting.

Note

- If the maximum burst is displayed as "99", it indicates that you can shoot 99 or more shots continuously. Fewer shots are available for a value of 98 or lower, and when [buSY] is displayed in the viewfinder and on the top LCD panel, internal memory is full and shooting will stop temporarily. If you stop continuous shooting, the maximum burst will increase. After all captured images have been written to a card, you can once again shoot at the maximum burst listed in [Performance Data](#).

1. Select [📷: JPEG/HEIF quality].

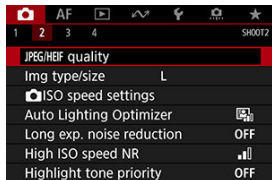

2. Select the desired image size.



- Select the image size, then press <ⓈET>.

3. Set the desired quality (compression).



- Select the number, then press <ⓈET>.
- Higher numbers offer higher quality (lower compression).
- Quality of 6–10 is indicated by <▴>, and 1–5, by <▾>.



Note

- The higher the quality, the fewer shots will be available. In contrast, the lower the quality, the more shots will be available.

ISO Speed Settings for Still Photos

[ISO Speed Range When Set Manually](#)

[ISO Speed Range Used With ISO Auto](#)

[Minimum Shutter Speed for ISO Auto](#)

Set the ISO speed (image sensor's sensitivity to light) to suit the ambient light level.

For details on ISO speed when recording movies, see [ISO Speed in < M >, < TV >, and < Av > Modes](#) and [ISO Speed in < M > Mode](#).

1. Press the <ISO> button (ⓘ).

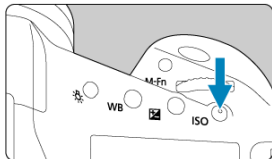

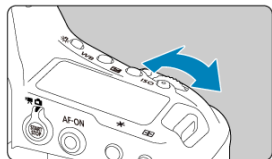

2. Set the ISO speed.



- Watch the top LCD panel or look through the viewfinder as you turn the < ISO > or < ISO > dial.
- "A" indicates ISO Auto. ISO speed is set automatically.

Caution

- Image noise (dots of light or banding) and irregular colors may increase and apparent resolution may decrease at H1, H2, or H3 (equivalent to ISO 204800, 409600, and 819200, respectively), because these are expanded ISO speeds.
- Because L (equivalent to ISO 50) is an expanded ISO speed setting, the dynamic range will be somewhat narrower compared to the standard setting.
- Setting the ISO speed to L (equivalent to ISO 50) may result in loss of gradation in highlights of your shots, even if gradation is visible in Live View image highlights.
- Setting [: **Highlight tone priority**] to [**Enable**] [**Enhanced**] () will prevent you from selecting L (equivalent to ISO 50), ISO 100/125/160, H1, H2, or H3 (equivalent to ISO 204800, 409600, and 819200, respectively).
- When shooting with a high ISO speed, high temperature, long exposure, or multiple exposure, image noise (graininess, dots of light, banding, etc.), irregular colors, or color shift may become noticeable.
- When shooting in conditions that produce an extreme amount of noise, such as a combination of high ISO speed, high temperature, and long exposure, images may not be recorded properly.
- If you use a high ISO speed and flash to shoot a close subject, overexposure may result.

Note

- Low ISO speeds reduce image noise but may increase the risk of camera/subject shake or reduce the area in focus (shallower depth of field), in some shooting conditions.
- High ISO speeds enable low-light shooting, a larger area in focus (deeper depth of field), and longer flash range but may increase image noise.
- Can also be set on the [**ISO speed**] screen in [: **ISO speed settings**].
- Shutter sounds after the camera shoots may vary depending on the ISO speed setting.

ISO Speed Range When Set Manually

You can set the manual ISO speed setting range (minimum and maximum limits). You can set the minimum limit within L (equivalent to ISO 50) to H2 (equivalent to ISO 409600), and the maximum limit within ISO 100 to H3 (equivalent to ISO 819200).

1. Select [: ISO speed settings].

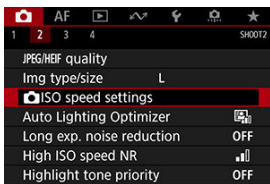

2. Select [ISO speed range].

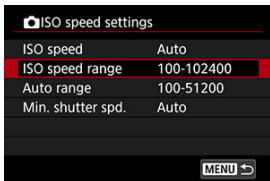

3. Set [Minimum].

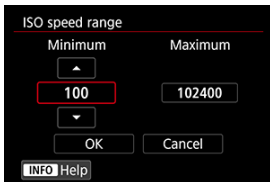

- Select the [Minimum] box, then press < >.
- Select the ISO speed, then press < >.

4. Set [Maximum].

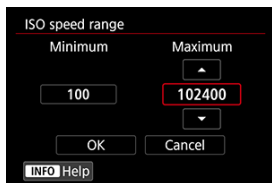

- Select the [Maximum] box, then press < (SET) >.
- Select the ISO speed, then press < (SET) >.

5. Select [OK].

ISO Speed Range Used With ISO Auto

You can set the automatic ISO speed range for ISO Auto within ISO 100–102400. The minimum can be set within ISO 100–51200 and the maximum within ISO 200–102400, in 1-stop increments.

1. Select [Auto range].

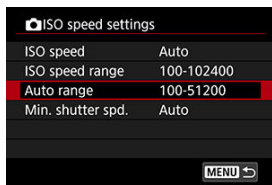

2. Set [Minimum].

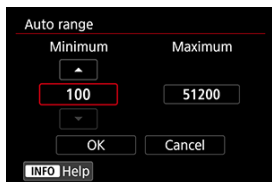

- Select the [Minimum] box, then press < (SET) >.
- Select the ISO speed, then press < (SET) >.

3. Set [Maximum].

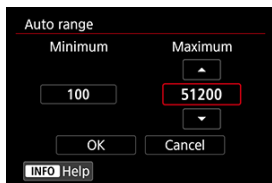

- Select the **[Maximum]** box, then press < **SET** >.
- Select the ISO speed, then press < **SET** >.

4. Select [OK].

Note

- The **[Minimum]** and **[Maximum]** settings will also function as the minimum and maximum speeds for ISO speed safety shift ().

Minimum Shutter Speed for ISO Auto

To prevent shutter speeds from being set too low automatically, you can set the minimum shutter speed for ISO Auto.

This is effective in < **P** > or < **Av** > mode when shooting subjects in motion with a wide-angle lens, or when using a telephoto lens. It can also reduce camera shake and blurred subjects.

1. Select [Min. shutter spd.].

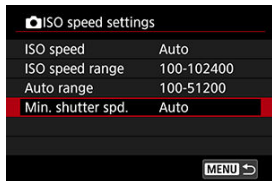

2. Set the desired minimum shutter speed.

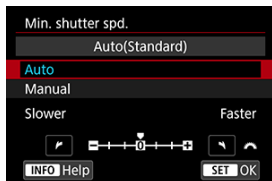

Automatically set

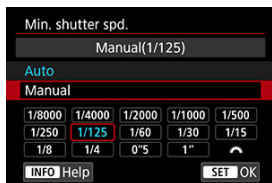

- If you select **[Auto]**, turn the <  > dial to set the difference relative to standard speed (toward **Slower** or **Faster**), then press <  >.

Manually set



- If you select **[Manual]**, turn the <  > dial to select the shutter speed, then press <  >.

Caution

- If a correct exposure cannot be obtained with the maximum ISO speed limit set with **[Auto range]**, a shutter speed slower than the **[Min. shutter spd.]** will be set to obtain the standard exposure.
- This function will not be applied to flash photography.

Note

- When **[Auto(Standard)]** is set, the minimum shutter speed will be the reciprocal of the lens focal length. A single step from **[Slower]** to **[Faster]** is equivalent to a single stop of the shutter speed.

Auto Lighting Optimizer

Brightness and contrast can be corrected automatically if shots look dark or contrast is too low or high.

1. Select [: Auto Lighting Optimizer].

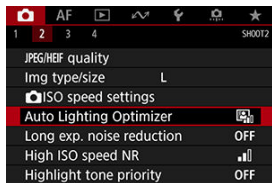

2. Set a correction option.

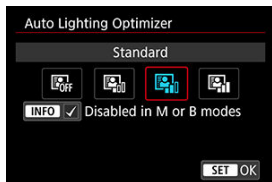

Caution

- Noise may increase and apparent resolution may change, under some shooting conditions.
- If the effect of Auto Lighting Optimizer is too strong and results are not at your preferred brightness, set to [**Low**] or [**Disable**].
- If a setting other than [**Disable**] is set and you use exposure compensation or flash exposure compensation to darken the exposure, the image may still come out bright. If you want a darker exposure, set this function to [**Disable**].



Note

- To enable [: **Auto Lighting Optimizer**] to be set even in < **M** > and < **buLb** > modes, press the < **INFO** > button in step 2 to clear the checkmark [✓] for [**Disabled in M or B modes**].

Long Exposure Noise Reduction

Noise that tends to occur in long exposures at shutter speeds of one sec. or slower can be reduced.

1. Select [**Ⓜ**: Long exp. noise reduction].

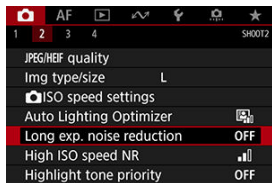

2. Set a reduction option.

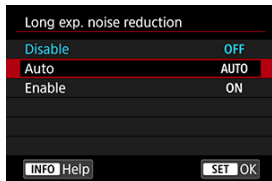

- **Auto**
For images exposed for 1 sec. or longer, noise reduction is performed automatically if noise typical of long exposures is detected. This setting is effective enough in most cases.
- **Enable**
Noise reduction is performed for all images exposed for 1 sec. or longer. The [**Enable**] setting may reduce noise that cannot be detected with the [**Auto**] setting.

 Caution

- With **[Auto]** or **[Enable]** set, noise reduction after you shoot may take as long as exposure for the shot.
- Images may look grainier with the **[Enable]** setting than with the **[Disable]** or **[Auto]** setting.
- “**buSY**” is displayed as noise is reduced, and no Live View image is displayed until processing is finished, when you can shoot again.

High ISO Speed Noise Reduction

You can reduce the image noise generated. This function is especially effective when shooting at high ISO speeds. When shooting at low ISO speeds, the noise in the darker parts of the image (shadow areas) can further be reduced.

1. Select [📷: High ISO speed NR].

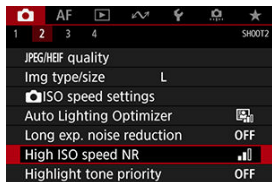

2. Set the level.

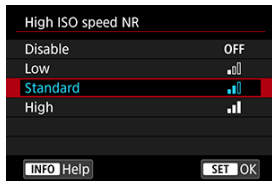

Highlight Tone Priority

You can reduce overexposed, clipped highlights.

1. Select [📷: Highlight tone priority].

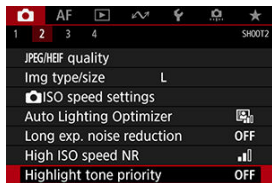

2. Set an option.



- **[Enable]**: Improves gradation in highlights. The gradation between the grays and highlights becomes smoother.
- **[Enhanced]**: Reduces overexposed highlights even more than **[Enable]**, under some shooting conditions.

⚠ Caution

- Noise may increase slightly.
- The available ISO range starts at ISO 200. Expanded ISO speeds cannot be set.
- With **[Enhanced]**, results in some scenes may not look as expected.

Image Review

To keep the image displayed immediately after you shoot, set to **[Hold]**, and if you prefer not to have the image displayed, set to **[Off]**.

1. Select [: Image review].

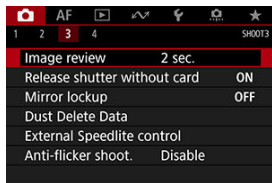

2. Set a time option.

Note

- When **[Hold]** is set, images are displayed as long as the time set in [: Auto power off].

Shutter Release Without Card

You can set the camera not to shoot unless there is a card in the camera. The default setting is **[Enable]**.

1. Select [: Release shutter without card].

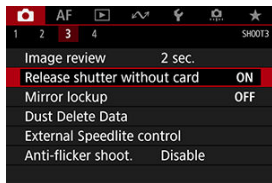

2. Select **[Disable]**.

Mirror Lockup

Mirror lockup keeps the mirror up in viewfinder shooting to reduce blur from mirror movement. Useful when shooting close-ups (macro photography), using a super telephoto lens, shooting at slow shutter speeds, etc.

1. Select [CAMERA]: Mirror lockup.

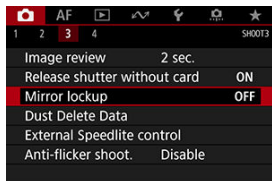

2. Select an item.

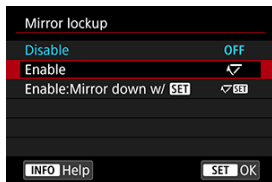

- Select [Enable] or [Enable:Mirror down w/ SET], then press < [SET] >.

3. Focus on the subject, then press the shutter button completely.



- The mirror will swing up.

4. Press the shutter button completely again.

- The camera shoots.
- When set to **[Enable]**, the mirror is lowered after shooting.
- When set to **[Enable:Mirror down w/ SET]**, the mirror remains up after shooting. To lower the mirror, press <  >.

Caution

- Do not point the camera toward an intense light source, such as the sun or an intense artificial light source. Doing so may damage the image sensor or the camera's internal components.
- In very bright light, such as at the beach or a ski slope on a sunny day, take the picture promptly after mirror lockup is stabilized.
- During mirror lockup, shooting function settings and menu operations are disabled.

Note

- Single shooting drive mode is used when this function is enabled. When set to **[Enable:Mirror down w/ SET]**, the camera shoots using the current drive mode.
- You can also use the self-timer with mirror lockup.
- If approx. 30 sec. elapse after the mirror has locked up, it will go back down automatically. Pressing the shutter button completely locks up the mirror again.
- Use of a tripod and Remote Switch RS-80N3 or Timer Remote Controller TC-80N3 (both sold separately) is recommended ().

Dust Delete Data Acquisition

 [Preparation](#)

 [Dust Delete Data Appending](#)

Dust Delete Data used to erase dust spots can be appended to images in case sensor cleaning leaves dust on the sensor. The Dust Delete Data is used by Digital Photo Professional (EOS software) to erase the dust spots automatically.

Preparation

- Prepare a solid white object such as a sheet of paper.
- Set the lens focal length to 50 mm or longer.
- Set the lens's focus mode switch to <MF> and set the focus to infinity (∞). If the lens has no distance scale, rotate the camera to face toward you and turn the focusing ring clockwise all the way.

1. Select [: Dust Delete Data].

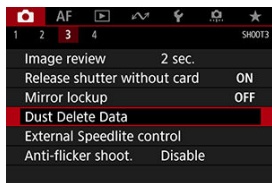

2. Select [OK].

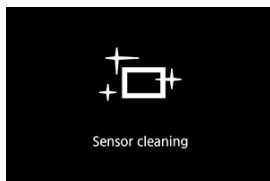
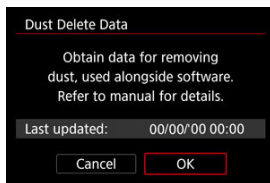

- After the automatic self-cleaning of the sensor is performed, a message will appear. Although there will be a mechanical sound of the shutter during the cleaning, no picture is taken.

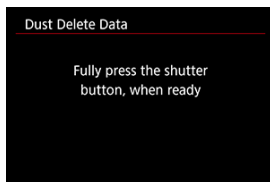

3. Shoot a plain white object.

- Shoot with a plain white object (such as a new sheet of white paper) filling the screen, at a distance of 20–30 cm (0.7–1.0 ft.).
- Since the image will not be saved, the data can still be obtained even if there is no card in the camera.

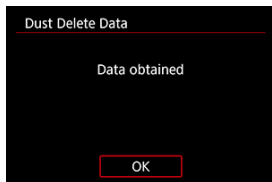

- When the picture is taken, the camera will start collecting the Dust Delete Data. When the Dust Delete Data is obtained, a message will appear.
- If the data is not obtained successfully, an error message will appear. Check the information in [Preparation](#), select **[OK]**, and shoot again.

Dust Delete Data Appending

The camera will append the Dust Delete Data obtained to all shots from now on. Acquiring Dust Delete Data before shooting is recommended.

For details about using Digital Photo Professional (EOS software) to erase dust spots automatically, refer to the Digital Photo Professional Instruction Manual.

File size is essentially unaffected by Dust Delete Data appended to images.

Caution

- If the object has any pattern or design, it may be recognized as dust data and affect the accuracy of the dust deletion with the Digital Photo Professional (EOS software).

Shooting With Speedlites



- [✔ EL/EX Series Speedlites for EOS Cameras](#)
- [✔ Canon Speedlites Other Than the EL/EX Series](#)
- [✔ Non-Canon Flash Units](#)

EL/EX Series Speedlites for EOS Cameras

Features of EL/EX series Speedlites (sold separately) can be used in flash photography with the camera.

For instructions, refer to the EL/EX series Speedlite's Instruction Manual.





● Flash exposure compensation

You can adjust flash output (flash exposure compensation). Press the  button, then turn the  dial while looking at the viewfinder or top LCD panel.

● FE lock



This enables you to obtain appropriate flash exposure for a specific part of the subject. Aim the viewfinder center over the subject, press the camera's  button, then compose the shot and take the picture.

Caution

- Setting : **Auto Lighting Optimizer**  to an option other than **[Disable]** may still cause images to look bright even if you set lower flash exposure compensation for darker images.
- When using flash in Live View shooting, set : **Shutter mode** to an option other than **[Electronic]** .
- No AF-assist beam is fired from external flash units in Live View shooting. However, when needed, an AF-assist beam is fired from the LED light of EX series Speedlites equipped with these lights.
- The Auto flash feature of Speedlite EL-100 is not supported. The flash always fires, even when set to  mode. Also note that linkage of flash power status with camera power status is not supported.



Note

- You can also set flash exposure compensation on the Quick Control screen  or in the **[Flash function settings]** setting of : **External Speedlite control** .

Canon Speedlites Other Than the EL/EX Series

- With an EZ/E/EG/ML/TL series Speedlite set to A-TTL or TTL autoflash mode, the flash can be fired at full output only.
Set the camera's shooting mode to < **M** > or < **Av** > and adjust the aperture value before shooting.
- When using a Speedlite that has manual flash mode, shoot in the manual flash mode.

Non-Canon Flash Units

● Sync speed

The camera can synchronize with non-Canon compact flash units at up to 1/250 sec. With large studio flash units, the flash duration is longer than that of a compact flash unit and varies depending on the model. Before shooting, confirm that flash sync is performed correctly by taking some test shots at a sync speed of approx. 1/60 sec. to 1/30 sec.

● PC terminal

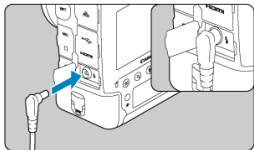

- The PC terminal enables you to use flash units with a sync cord. The terminal has locking threads to prevent accidental cord detachment.
- The PC terminal has no polarity. Sync cords can be connected regardless of polarity.

Caution

- Using the camera with a dedicated flash unit or flash accessory for cameras of other manufacturers poses a risk of malfunction and even damage.
- Do not connect flash units with an output voltage of 250 V or more to the camera's PC terminal.
- Do not attach a high-voltage flash unit to the camera's hot shoe. It may not fire.

Note

- You can use one flash unit attached to the camera's hot shoe and another connected to the PC terminal at the same time.

 **Note**

Metered manual flash exposure

This feature enables you to set the flash exposure level manually for close-up shots. Using a Speedlite with manual flash mode and a standard 18% gray card, follow these steps.

1. Configure the camera and Speedlite settings.

- On the camera, set the shooting mode to < **M** > or < **Av** >.
- On the Speedlite, set the firing mode to Manual flash.

2. Focus on the subject.

3. Set up the standard 18% gray card.

- Place the card at the position of the subject.
- Place the card so that it fills the entire spot metering circle in the viewfinder or on the screen.

4. Press the < M-Fn > button ()

5. Set the flash exposure level.

- Adjust the Speedlite's manual flash level and the camera's aperture value to align the flash exposure level with the standard exposure index.

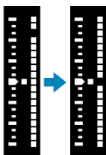

6. Take the picture.

- Remove the card and shoot.

Flash Function Settings

- [Flash Firing](#)
- [E-TTL Balance](#)
- [E-TTL II Flash Metering](#)
- [Continuous Flash Control](#)
- [Flash Sync Speed in Av Mode](#)
- [Flash Function Settings](#)
- [Flash Custom Function Settings](#)
- [Clearing Flash Function Settings/Clearing All Speedlite Custom Functions](#)

Functions of EL/EX Series Speedlites compatible with flash function settings can be set via a camera menu screen. Attach the Speedlite to the camera and turn on the Speedlite before setting the flash functions.

For details on the Speedlite's functions, refer to the Speedlite's Instruction Manual.

1. Select [: External Speedlite control].

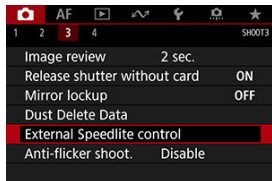

2. Select an item.

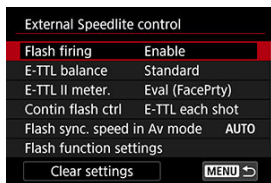

Flash Firing

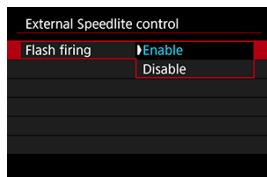

To enable flash photography, set to **[Enable]**. To enable only the AF-assist beam of the Speedlite, set to **[Disable]**.

E-TTL Balance

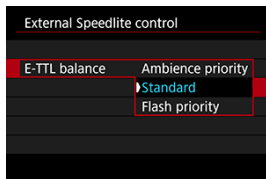

You can set your preferred appearance (balance) for flash shots. This setting enables you to adjust the ratio of ambient light to Speedlite light output.

- Set the balance to **[Ambience priority]** to lower the proportion of flash output and uses ambient light to produce lifelike shots with a natural mood. Especially useful when shooting dark scenes (indoors, for example). After switching to < **Av** > mode, consider setting **[Flash sync. speed in Av mode]** in **[External Speedlite control]** to **[Auto]** and using slow-sync shooting.
- Set the balance to **[Flash priority]** to make the flash the main source of light. Useful for reducing shadows on subjects and in the background from ambient light.

⚠ Caution

- Although **[Ambience priority]** is effective in dark scenes, there may be no difference from results with **[Standard]** in some scenes.

E-TTL II Flash Metering

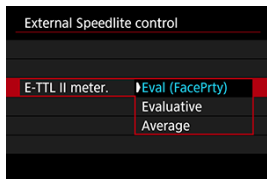

- Set to **[Eval (FacePrty)]** for flash metering suitable for shots of people. The continuous shooting speed for high-speed continuous shooting is slower than when **[Evaluative]** or **[Average]** is selected.
- Set to **[Evaluative]** for flash metering that emphasizes firing in continuous shooting.
- If **[Average]** is set, the flash exposure will be averaged for the entire metered scene.

Note

- Depending on the scene, flash exposure compensation may be necessary.

Caution

- Even when **[Eval (FacePrty)]** is set, some subjects and shooting conditions may prevent you from obtaining the expected result.

Continuous Flash Control

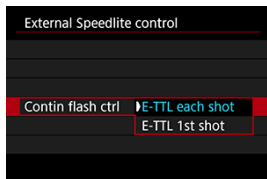

Set to **[E-TTL each shot]** to perform flash metering for each shot. Set to **[E-TTL 1st shot]** to perform flash metering for only the first shot before continuous shooting. The flash output level for the first shot is applied to all subsequent shots. Useful when prioritizing continuous shooting speed without recomposing shots.

⚠ Caution

- Any subject movement in continuous shooting may cause exposure problems.

Flash Sync Speed in Av Mode

You can set the flash-sync speed for flash photography in < **Av** > mode.

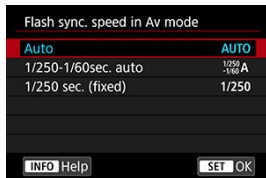

- **AUTO: Auto**

The shutter speed is set automatically within a range of 1/250 sec. to 30 sec. to suit the brightness. High-speed sync is also possible.

- ^{1/250}/_{-1/60} **A: 1/250-1/60sec. auto**

Prevents a slow shutter speed from being set automatically in low-light conditions. It is effective for preventing subject blur and camera shake. Light from the flash provides standard exposure for subjects, but note that backgrounds may be dark.

- **1/250: 1/250 sec. (fixed)**

The shutter speed is fixed at 1/250 sec., which is more effective in preventing subject blur and camera shake than with [**1/250-1/60sec. auto**]. However, in low light, the subject's background will come out darker than with [**1/250-1/60sec. auto**].

⚠ Caution

- High-speed sync is not available in < **Av** > mode when set to [**1/250-1/60sec. auto**] or [**1/250 sec. (fixed)**].

Flash Function Settings

The information displayed on the screen, position of display, and available options vary depending on the Speedlite model, its Custom Function settings, the flash mode, and other factors. For details on the Speedlite's functions, refer to the Speedlite's Instruction Manual.

Sample display

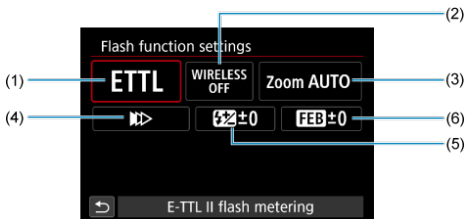

- (1) Flash mode
- (2) Wireless functions/
Firing ratio control (RATIO)
- (3) Flash zoom (flash coverage)
- (4) Shutter synchronization
- (5) Flash exposure compensation
- (6) Flash exposure bracketing



Caution

- Functions are limited when using EX series Speedlites that are not compatible with flash function settings.

Flash mode

You can select the flash mode to suit your desired flash photography.

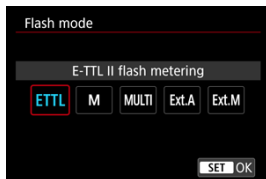

- **[E-TTL II flash metering]** is the standard mode of EL/EX series Speedlites for automatic flash photography.
- **[Manual flash]** is for setting the Speedlite's **[Flash output level]** yourself.
- **[CSP]** (Continuous shooting priority mode) is available when using a compatible external Speedlite. This mode automatically reduces flash output by one stop and increases ISO speed by one stop. Useful in continuous shooting, and helps conserve flash battery power.
- Regarding other flash modes, refer to the Instruction Manual of a Speedlite compatible with the respective flash mode.

⚠ Caution

- Adjust exposure compensation (☒) as needed in case of overexposure from flash photography with **[CSP]** in **<Tv>** or **<M>** mode.

📄 Note

- With **[CSP]**, ISO speed is automatically set to **[Auto]**.

Wireless functions

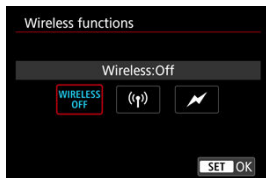

You can use radio or optical wireless transmission to shoot with wireless multiple-flash lighting.

For details on wireless flash, refer to the Instruction Manual of a Speedlite compatible with wireless flash photography.

Firing ratio control (RATIO)

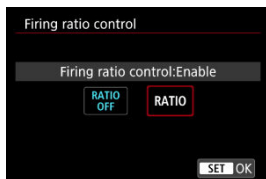

With a macro flash, you can set the firing ratio control.

For details on firing ratio control, refer to the Instruction Manual of the macro flash.

Flash zoom (flash coverage)

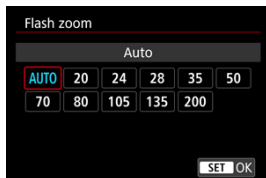

With Speedlites having a zooming flash head, you can set the flash coverage.

Shutter synchronization

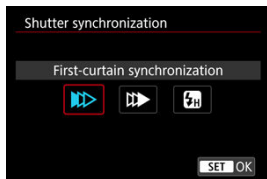

Normally, set this to [**First-curtain synchronization**] so that the flash fires immediately after the shooting starts.

Set to [**Second-curtain synchronization**] and use low shutter speeds for natural-looking shots of subject motion trails, such as car headlights.

Set to [**High-speed synchronization**] for flash photography at higher shutter speeds than the maximum flash sync shutter speed. This is effective when shooting with an open aperture in < **Av** > mode to blur the background behind subjects outdoors in daylight, for example.

Caution

- When using second-curtain synchronization, set the shutter speed to 1/50 sec. or slower. If the shutter speed is 1/60 sec. or faster, first-curtain synchronization will be applied automatically even if [**Second-curtain synchronization**] is set.

Flash exposure compensation

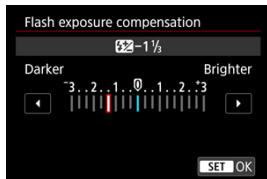

Just as exposure compensation is adjustable, you can also adjust flash output.

Note

- If flash exposure compensation is set with the Speedlite, you cannot set the flash exposure compensation with the camera. If it is set with both the camera and Speedlite, the Speedlite's setting overrides the camera's.

Flash exposure bracketing

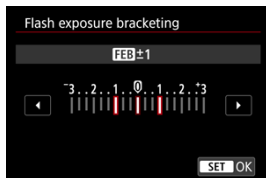

Speedlites equipped with flash exposure bracketing (FEB) can change the external flash output automatically as three shots are taken at once.

Flash Custom Function Settings

For details on the Speedlite's Custom Functions, refer to the Instruction Manual of the Speedlite.

1. Select [Flash C.Fn settings].

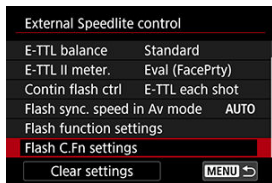

2. Set the desired functions.

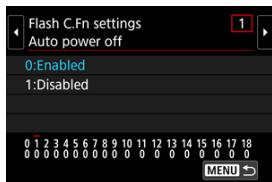

- Select the number.
- Select an item.

⚠ Caution

- With an EX series Speedlite, the Speedlite will always fire at full output if the [Flash metering mode] Custom Function is set to [TTL flash metering] (autoflash).
- The Speedlite's Personal Function (P.Fn) cannot be set or canceled from the camera's [📷: External Speedlite control] screen. Set it directly on the Speedlite.

Clearing Flash Function Settings/Clearing All Speedlite Custom Functions

1. Select [Clear settings].

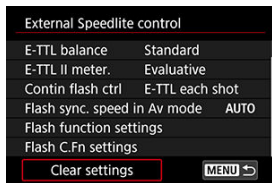

2. Select the settings to be cleared.

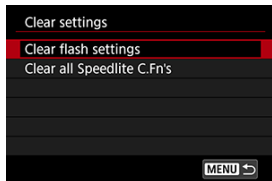

- Select [Clear flash settings] or [Clear all Speedlite C.Fn's].
- Select [OK] on the confirmation screen to clear all flash settings or Custom Function settings.

Anti-Flicker Shooting

Uneven exposure and color may result if you shoot at fast shutter speeds under flickering light sources such as fluorescent lights, due to uneven vertical exposure. Anti-flicker shooting enables viewfinder shooting at moments when exposure and colors are less affected by flickering.

1. Select [: Anti-flicker shoot.].

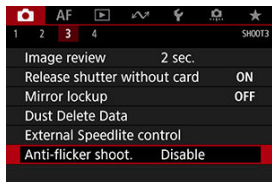

2. Select [Enable].

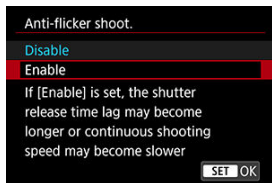

3. Take the picture.

Caution

- When **[Enable]** is set and you shoot under a flickering light source, the shutter-release time lag may become longer. Also, the continuous shooting speed may become slower, and the shooting interval may become irregular.
- Not applied to mirror lockup shots, Live View shooting, or movie recording.
- Flicker at a frequency other than 100 Hz or 120 Hz cannot be detected. Also, if the flickering frequency of the light source changes during continuous shooting, effects of the flicker cannot be reduced.
- In the **< P >** or **< Av >** mode, if the shutter speed changes during continuous shooting or if you shoot multiple shots of the same scene at different shutter speeds, the color tone may become inconsistent. To avoid inconsistent color tone, shoot in **< M >** or **< Tv >** mode at a fixed shutter speed.
- Color tone of captured images may vary between **[Enable]** and **[Disable]**.
- Shutter speed, aperture value, and ISO speed may change when you start shooting with AE lock.
- If the subject is against a dark background or if there is a bright light in the image, flicker may not be properly detected.
- Flicker reduction may not be possible under special lighting.
- Depending on the light source, flicker may not be detected properly.
- Depending on the light sources or shooting conditions, the expected result may not be obtained even if you use this function.

Note

- Taking test shots in advance is recommended.
- When you shoot with flicker reduction, **< Flicker! >** will light up. If **< Flicker! >** is not displayed in the viewfinder, add a checkmark **[√]** to **[Flicker detection]** in **[Show/hide in viewfinder]** in **[Viewfinder display]** (). Under a light source that does not flicker or with no flicker detected, **< Flicker! >** will not be displayed.
- **< Flicker! >** will blink in the viewfinder as a warning when metering under flickering light sources with a checkmark **[√]** in **[Flicker detection]** and with **[Camera: Anti-flicker shoot.]** set to **[Disable]**.
- The expected result may not be obtained for wireless flash photography.

Multiple Exposures

[☑ Merging Multiple Exposures with a RAW Image Recorded on the Card](#)

[☑ Checking and Deleting Multiple Exposures During Shooting](#)

You can shoot multiple (2–9) exposures to merge into a single image. In Live View shooting, you can see in real time how the exposures are merged when you shoot multiple-exposure images.

1. Select [📷: Multiple exposure].

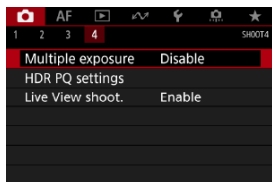

2. Set [Multiple exposure].

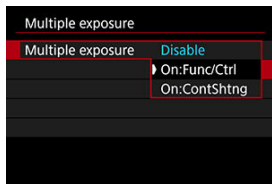

- Select an option, then press < (SET) >.
- To exit shooting multiple exposures, select **[Disable]**.

- **On:Func/Ctrl**
Convenient when shooting multiple exposures gradually as you check the results. During continuous shooting, the continuous shooting speed will decrease greatly.

- **On:ContShtng**
Used for continuous multiple exposures of moving subjects. Continuous shooting is possible, but the following operations are disabled during shooting: menu screen viewing, image review after capture, image playback, and undo last image (⌫).
Note that the single exposures used for merging are discarded, and only the multiple-exposure image is saved.

3. Set [Multi-expos ctrl].

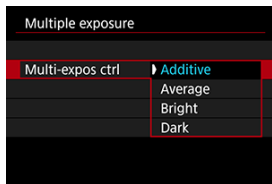

- Select a merging option, then press < (SET) >.

- **Additive**

The exposure of each single image captured is added cumulatively. Based on [**No. of exposures**], set negative exposure compensation. Follow these basic guidelines to set the exposure compensation amount.

Exposure compensation setting guidelines, by number of exposures

Two exposures: -1 stop, three exposures: -1.5 stops, four exposures: -2 stops

- **Average**

Based on the [**No. of exposures**], negative exposure compensation is set automatically as you shoot multiple exposures. If you shoot multiple exposures of the same scene, the exposure of the subject's background will be automatically controlled to obtain the standard exposure.

- **Bright/Dark**

Brightness (or darkness) of the base image and added images is compared at the same position, and bright (or dark) portions are retained. Some overlapping colors may be mixed, depending on the relative brightness (or darkness) of the images.

4. Set [No. of exposures].



- Select the number of exposures, then press < **SET** >.

5. Specify the images to save.

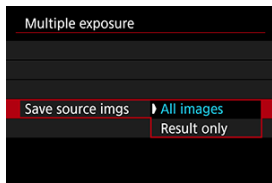

- To save all single exposures and the multiple-exposure image, select [**All images**] and press < **SET** >.
- To save only the multiple-exposure image, select [**Result only**] and press < **SET** >.

6. Set [Continue Mult-exp].

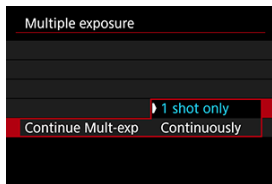

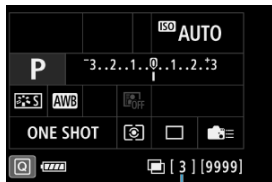

- Select an option, then press < **SET** >.
- With **[1 shot only]**, multiple-exposure shooting will be canceled automatically after the shooting ends.
- With **[Continuously]**, multiple-exposure shooting continues until the setting in step 2 is set to **[Disable]**.

7. Shoot the first exposure.





(1)

- When **[On:Func/Ctrl]** is set, the captured image will be displayed.
- The <  > icon blinks.
- You can check the number of remaining exposures, as displayed at right in the viewfinder or on the screen (1).
- Pressing the <  > button enables you to view the captured image ().

8. Shoot the next exposures.

- Images captured so far are displayed merged in Live View shooting. For only Live View image display, press the < **INFO** > button repeatedly.
- To view the multiple-exposure image so far, check exposure, and see how the images will be merged, hold down the depth-of-field preview button (or the button assigned to [**Depth-of-field preview**] in [**6: Custom Controls**]) in Live View shooting.
- Multiple-exposure shooting will end when the set number of exposures are taken.

Note

- With [**On:Func/Ctrl**], you can press the <  > button to view the multiple-exposure image so far or delete the previous single exposure ().
- As shooting information, the multiple-exposure image has information captured for the last shot.

Caution

- The image quality, ISO speed, Picture Style, high ISO speed noise reduction, color space, etc. set for the first single exposure will also be set for the subsequent exposures.
- If [: **Picture Style**] is set to [**Auto**], [**Standard**] will be applied for shooting.
- With [**On:Func/Ctrl**] and [**Additive**] set, any noise, irregular colors, banding, or similar issues affecting images displayed as you shoot may look different in the final multiple-exposure image.
- With multiple exposures, the more exposures there are, the more noticeable the noise, irregular colors, and banding will be.
- Image processing after you finish shooting multiple exposures takes longer when [**Additive**] is set (which causes the access lamp to be illuminated longer).
- Brightness and noise of the multiple-exposure image captured in step 8 will be different in the resulting multiple-exposure image.
- Multiple-exposure shooting is canceled if you set the power switch to < **OFF** >, replace batteries or cards, or switch to movie recording.
- Switching to < **C1** >, < **C2** >, or < **C3** > shooting mode ends multiple-exposure shooting in progress.
- If you connect the camera to a computer, multiple-exposure shooting will not be possible. If you connect the camera to a computer during shooting, multiple-exposure shooting will end.



Merging Multiple Exposures with a RAW Image Recorded on the Card

You can select a RAW image recorded on the card as the first single exposure. The selected RAW image will remain intact.

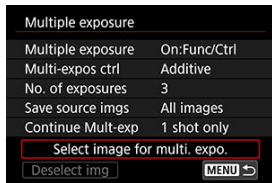
1. Select [Select image for multi. expo.].





2. Select the first image.

- Turn the <  > dial to select the first image, then press <  >.
- Select [OK].
- The file number of the selected image will be displayed at the bottom of the screen.

3. Take the picture.

- When you select the first image, the number of remaining exposures as set with [No. of exposures] will decrease by 1.

Caution

- JPEG/HEIF images cannot be selected.
- These images cannot be selected as the first single exposure: images shot with : **Highlight tone priority** set to **[Enable]** or **[Enhanced]**, or images with cropping information.
- **[Disable]** is applied for : **Lens aberration correction** and : **Auto Lighting Optimizer**, regardless of the settings of the image selected as the first single exposure.
- The ISO speed, Picture Style, high ISO speed noise reduction, color space, etc. set for the first image will also be applied for the subsequent images.
- If Picture Style is **[Auto]** for the image selected as the first image, **[Standard]** will be applied for shooting.
- You cannot select an image taken with another camera.
- Images that cannot be merged may be displayed.

Note



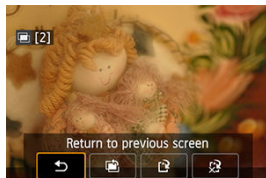

- You can also select a RAW image used in multiple-exposure shooting.
- Select **[Deselect img]** to cancel image selection.

Checking and Deleting Multiple Exposures During Shooting



To view the multiple-exposure image so far, check exposure, and see how the images are layered, you can press the <  > button before you finish shooting your specified number of exposures (when [On:Func/Ctrl] is set, but not with [On:ContShtn]).

Pressing the <  > button will display the operations possible during multiple-exposure shooting.

Operation	Description
 Return to previous screen	The screen before you pressed the <  > button will reappear.
 Undo last image	Deletes the last image you shot (enabling you to replace it by shooting again). The number of remaining exposures will increase by 1.
 Save and exit	With [Save source imgs: All images], saves all single exposures and the multiple-exposure image created so far and exits multiple-exposure shooting. With [Save source imgs: Result only], saves only the multiple-exposure image created so far and exits multiple-exposure shooting.
 Exit without saving	Exits the multiple-exposure shooting without saving the image.

Caution

- During multiple-exposure shooting, you can only play back multiple-exposure images.

? FAQ

- **Are there any restrictions on the image quality?**

All single exposures and the multiple-exposure image are captured at your specified image quality.

- **Can I merge images recorded on the card?**

With [**Select image for multi. expo.**], you can select the first single exposure from the images recorded on the card (🔗). Note that you cannot merge multiple images already recorded on the card.

- **How are multiple-exposure files numbered?**

With the camera set to save all images, multiple-exposure image files are named with the next number after the number of the last single exposure used to create them.

- **Will auto power off take effect during multiple-exposure shooting?**

During multiple-exposure shooting, auto power off will not take effect. Note that before you start multiple-exposure shooting, auto power off automatically takes effect at the time set in [**🔗: Auto power off**], which will cancel multiple-exposure shooting.

HDR PQ Settings

PQ in HDR PQ refers to the gamma curve of the input signal for displaying HDR images. HDR PQ settings enable the camera to produce HDR images conforming to the PQ specification defined in ITU-R BT.2100 and SMPTE ST.2084 (with actual display depending on monitor performance).

Shots are captured as HEIF or RAW images.

* HDR stands for High Dynamic Range.

* PQ stands for Perceptual Quantization.

1. Select [: HDR PQ settings].

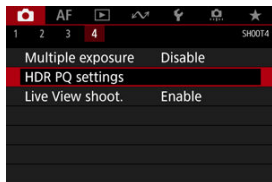

2. Select [HDR shooting **HDR PQ**].

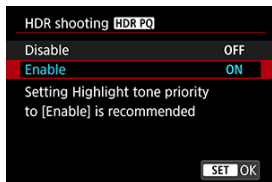

- Select [**Enable**].

3. Set [HDR assist disp: shooting].

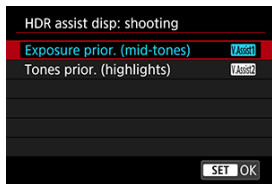

- Converted images are displayed on the screen in Live View shooting, giving an impression similar to how they would appear on an HDR display device.
- Select [**Exposure prior. (mid-tones)**] or [**Tones prior. (highlights)**].
- [**V.Assist1**] **Exposure prior. (mid-tones)**
Provides reference display that emphasizes exposure of subjects (such as people) with intermediate brightness.
- [**V.Assist2**] **Tones prior. (highlights)**
Provides reference display that emphasizes gradation of bright subjects (such as the sky).

4. Set [HDR assist disp: playback].

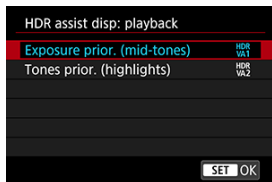

- Converted images are displayed on the screen for playback, giving an impression similar to how they would appear on an HDR display device.
- Select [**Exposure prior. (mid-tones)**] or [**Tones prior. (highlights)**].
- [**HDR_{VA1}**] **Exposure prior. (mid-tones)**
Provides reference display that emphasizes exposure of subjects (such as people) with intermediate brightness.
- [**HDR_{VA2}**] **Tones prior. (highlights)**
Provides reference display that emphasizes gradation of bright subjects (such as the sky).

5. Set the image quality.

- For details, see [Image Quality](#).

Note

- Settings for [**HDR assist disp: shooting**] also apply to images displayed on the screen immediately after you shoot.

Caution

- HEIF images are captured at L size.
- Expanded ISO speeds (L, H1, H2, H3) are not available in HDR shooting.
- Some scenes may look different from how they appear on an HDR display device.
- Histograms of images captured with [**HDR shooting HDR PQ**] set to [**Enable**] are not based on images as converted for HDR assist display. Image areas shown in gray in the histogram roughly indicate signal values that are not used.

Metering Mode Selection

[Multi-Spot Metering](#)

You can select one of four methods to measure the subject brightness.

1. Press the   button (⓪6).

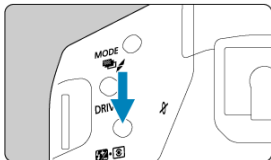

2. Select the metering mode.

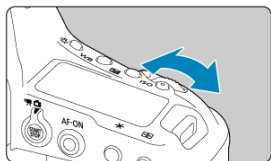
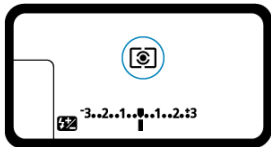

- Watch the top LCD panel or look through the viewfinder as you turn the  dial.

Evaluative metering

General-purpose metering mode suited even for backlit subjects. The camera adjusts the exposure automatically to suit the scene.

Partial metering

Effective where there are much brighter lights around the subject due to backlight, etc.









Spot metering

Effective when metering a specific part of the subject. The spot metering circle will be displayed in the viewfinder.

Center-weighted average

Metering over the entire area is averaged, with the center of the viewfinder weighted more heavily.

Note

- By default, the camera will set the exposure as follows.
With <  >, holding down the shutter button halfway locks the exposure value (AE lock) after the camera focuses with One-Shot AF. With <  > / <  > / <  >, the exposure value is set at the moment the picture is taken (without locking the exposure value when the shutter button is pressed halfway).
- You can link spot metering to all AF points by setting [:1: **Spot meter. linked to AF pt**] to [**Linked to active AF point**] ().
- With [:2: **AE lock meter. mode after focus**] (), you can set whether or not to lock the exposure (AE lock) when focus is achieved with One-Shot AF.

Multi-Spot Metering

By specifying multiple areas for spot metering, you can determine an overall exposure level based on the average of your selected areas. Multi-spot metering is available in < **P** >, < **Tv** >, and < **Av** > modes.

1. Set the metering mode to <  > (spot metering).





2. Press the < **M-Fn** > button (Ⓜ16).

- Aim the spot metering circle over each area for exposure comparison, one after another, and press the < **M-Fn** > button in each area.
- Relative exposure levels of each spot metering area are displayed at right in the viewfinder. These levels are averaged to obtain the current exposure level.



- While referring to the three points on the exposure level indicator, you can set exposure compensation in this state and determine the final exposure level for the desired result.

Note

- Spot metering with up to eight points is possible.
- Stored exposure values are cleared in the following cases.
 - When the metering timer elapses after the last spot metering (Ⓜ16)
 - When you press any of these buttons: < **MODE** >, < **DRIVE•AF** >, <  >, < **ISO** >, <  >, <  >, or < **WB** >
- Multi-spot metering is available even when [ 1: Spot meter. linked to AF pt] is set to [Linked to active AF point] ().

Manual Exposure Compensation

Exposure compensation can brighten (increased exposure) or darken (decreased exposure) the standard exposure set by the camera.

For details on exposure compensation when <M> mode and ISO Auto are both set, see [M: Manual Exposure](#).

1. Check the exposure.

- Press the shutter button halfway (ⓘ6) and check the exposure level indicator.

2. Set the compensation amount.

Increased exposure, to brighten images





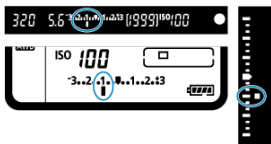

Decreased exposure, to darken images





- Turn the <ⓘ> dial while looking at the viewfinder or top LCD panel.
- If the setting cannot be set, move the power switch to <ON>, then turn the <ⓘ> dial.
- The exposure compensation range is ± 5 stops in viewfinder shooting and ± 3 stops in Live View shooting.
- The exposure compensation range shown in the viewfinder and on the top LCD panel is up to ± 3 stops. To specify more than ± 3 stops, use the [Quick Control](#).







3. Take the picture.

- To cancel exposure compensation, set the exposure level <  /  > to the standard exposure index (<  /  >).

Caution

- If [: **Auto Lighting Optimizer**] () is set to any setting other than [**Disable**], the image may still look bright even if decreased exposure compensation is set to darken images.

Note

- Can also be set by pressing the <  > button and turning the <  > or <  > dial.
- The exposure compensation amount will remain in effect even after you set the power switch to < **OFF** >.
- To prevent accidental changes to the exposure compensation amount after setting it, set the power switch to < **LOCK** >.
- If the exposure compensation amount exceeds ± 3 stops, the end of the exposure level indicator will display <  /  > or <  /  >.

Auto Exposure Bracketing (AEB)

In exposure bracketing, three consecutive images are captured at different exposures within your specified range of up to ± 3 stops (in 1/3-stop increments) by automatically adjusting the shutter speed or aperture value. This is called AEB.

* AEB stands for Auto Exposure Bracketing.

1. Press the **<MODE>** and **<DRIVE•AF>** button simultaneously (6).

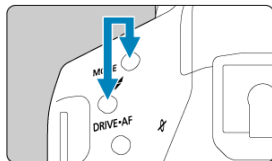

- **< [AEB icon] >** and **<0.0>** appear on the top LCD panel.

2. Set the AEB range.

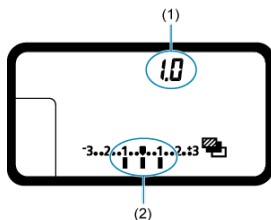

- (1) AEB amount
- (2) AEB range

- Turn the or dial to set the AEB range.

3. Take the picture.



Standard exposure















Decreased exposure



Increased exposure

- Three bracketed shots are taken, according to the specified drive mode, in this sequence: Standard exposure, decreased exposure, and increased exposure.
- AEB will not be automatically canceled. To cancel AEB, follow step 2 to set the AEB amount to "0.0."

 **Note**

- During AEB shooting, the < * > icon in the viewfinder and the <  > icon on the top LCD panel blink.
- If the drive mode is set to <  / S >, press the shutter button three times for each shot.
In <  H /  M /  S /  S > modes, holding down the shutter button completely captures three images, one after another, before the camera automatically stops shooting. When <  10 or  2 > is set, three consecutive shots are captured after a delay of approx. 10 or 2 sec.
- You can set AEB in combination with exposure compensation.
- Ends of the exposure level indicator are displayed as <  /  > or <  /  > when the AEB range exceeds ± 3 stops.
- AEB is not available in flash photography or bulb exposures.
- AEB will be canceled automatically if you do any of the following: Setting the power switch to < OFF > or when the flash is fully charged.

Exposure Lock (AE Lock)

[AE Lock Effects](#)

You can lock the exposure when you want to set the focus and exposure separately or when you will take multiple shots at the same exposure setting. Press the < * > button to lock the exposure, then recompose and take the picture. This is called AE lock. It is effective for shooting backlit subjects, etc.

1. Focus on the subject.

- Press the shutter button halfway.
- The exposure value will be displayed.

2. Press the < * > button (ⓘ6).

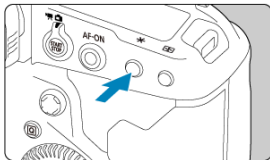

- A < * > icon is displayed in the viewfinder, indicating that the exposure is locked (AE lock).
- Each time you press the < * > button, the current exposure setting is locked.

3. Recompose and take the picture.



- The AE lock exposure value and current exposure value are shown in real time at right in the viewfinder.
- When you are to take more pictures while maintaining the AE lock, keep holding down the < * > button and press the shutter button to take another picture.



Note

- AE lock is not possible with bulb exposures.

AE Lock Effects

Metering Mode Selection	Selecting the AF Area and AF Point	
	Automatic Selection	Manual Selection
	Exposure value centered on the AF point in focus is locked.	Exposure value centered on the selected AF point is locked.
	AE lock is applied at the center AF point.	

* When the < > is set and the lens's focus mode switch is set to < MF >, AE lock is applied with the exposure value weighted on the center AF point.

Using the Eyepiece Shutter

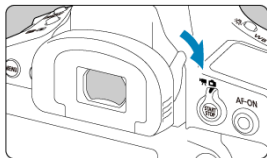

Light that enters the viewfinder if you shoot without looking through it (in self-timer shooting, bulb exposures, or remote switch shooting) may cause shots to be underexposed. To prevent this, slide the eyepiece shutter lever as shown by the arrow to cover the viewfinder eyepiece.

Note that covering the viewfinder eyepiece is not necessary in Live View shooting or movie recording.

Using a Remote Switch

You can connect Remote Switch RS-80N3, Timer Remote Controller TC-80N3 (both sold separately), or other optional EOS shooting accessories equipped with an N3-type terminal (☑).

For operating instructions, refer to the Instruction Manual of the accessory.

1. Open the terminal cover.
2. Connect the plug to the remote control terminal.

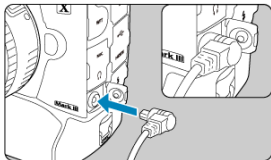

- Connect as shown.
- To disconnect, hold the silver part of the plug and pull it out.

Still Photo Shooting (Live View Shooting)

- You can shoot while viewing live images on the camera screen. This is called “Live View shooting.”
 - [Tab Menus: Still Photo Shooting \(Live View Shooting\)](#)
 - [Live View Shooting](#)
 - [Shutter Mode](#)
 - [Exposure Simulation](#)
 - [Metering Timer](#)
 - [General Live View Shooting Precautions](#)

Tab Menus: Still Photo Shooting (Live View Shooting)

● Shooting 1



- (1) [White balance](#)
- (2) [Set Custom WB](#)
- (3) [WB Shift/Bkt.](#)
- (4) [Color space](#)
- (5) Picture Style
 - [Picture Style Selection](#)
 - [Picture Style Customization](#)
 - [Picture Style Registration](#)
- (6) [Clarity](#)
- (7) [Lens aberration correction](#)

● Shooting 2

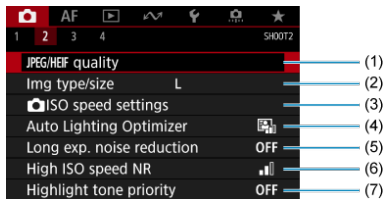

- (1) [JPEG/HEIF quality](#)
- (2) [Img type/size](#)
- (3) [ISO speed settings](#)
- (4) [Auto Lighting Optimizer](#)
- (5) [Long exp. noise reduction](#)
- (6) [High ISO speed NR](#)
- (7) [Highlight tone priority](#)

● Shooting 3

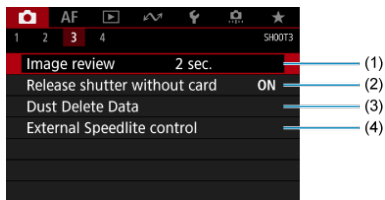

- (1) [Image review](#)
- (2) [Release shutter without card](#)
- (3) [Dust Delete Data](#)
- (4) [External Speedlite control](#)

● Shooting 4

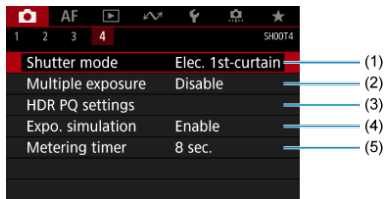

- (1) [Shutter mode](#)
- (2) [Multiple exposure](#)
- (3) [HDR PQ settings](#)
- (4) [Expo. simulation](#)
- (5) [Metering timer](#)

Live View Shooting

1. Set the Live View shooting/Movie shooting switch to .

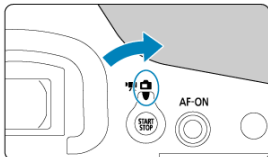

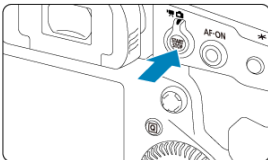

2. Display the Live View image.



- Press the  button.
- Live View images are displayed nearly as bright as your shots.

3. Select a shooting mode.



- Press the  and turn the  or  dial to select the shooting mode.

4. Focus on the subject.



- When you press the shutter button halfway, the camera will focus with the current AF method (☑).
- You can also tap the screen to select the face or subject.

5. Take the picture.

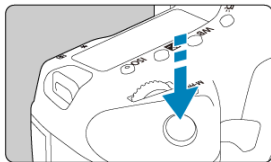



- Press the shutter button completely.
- Press the < START STOP > button to exit Live View shooting.

⚠ Caution

- Live View images viewed outdoors on a sunny day may look different from the actual brightness and mood of your shots. For image display unaffected by ambient light, set the brightness in [☑: Disp. brightness] to level 4.

 **Note**

- The field of view is approx. 100% (with image size set to JPEG/L).
- The camera will turn off automatically if left idle for the time set in [**⚙**: **Auto power off**] () . When the setting is set to [**Disable**], the camera exits Live View shooting automatically in approx. 30 min. and remains on.
- With HDMI Cable HTC-100, you can display Live View images on a television () . Note that no sound will be output.
- You can view a histogram when [**📷**: **Expo. simulation**] is set to [**Enable**] () by pressing the < **INFO** > button repeatedly.
- White display of the [**Exp.SIM**] icon indicates that brightness of Live View images will closely match the brightness of your shots.
- If the [**Exp.SIM**] icon is blinking, it indicates that the image is displayed at a brightness that differs from the actual shooting result because of low- or bright-light conditions. However, the actual image recorded will reflect the exposure setting. Note that the noise may be more noticeable than the actual image recorded.
- Exposure simulation may not be performed under some shooting settings. The [**Exp.SIM**] icon and histogram will be displayed in gray. The image will be displayed on the screen at the standard brightness. The histogram may not be properly displayed in low- or bright-light conditions.

Shutter Mode

You can choose the method of shutter release.

1. Select [CAMERA]: Shutter mode].

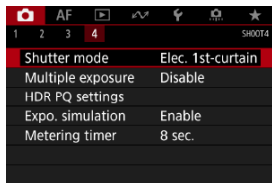

2. Select an option.

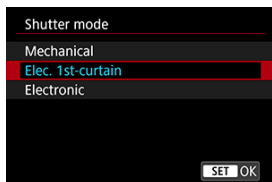

- **Mechanical**

Shooting activates the mechanical shutter. Recommended when shooting with the aperture of a bright lens wide open.

- **Elec. 1st-curtain**

Shooting only activates the second-curtain shutter. The shutter is quieter than with [Mechanical].

- **Electronic**

Enables you to shoot without a shutter sound.

In continuous shooting, the camera always shoots at high speed (up to approx. 20 shots/sec.). Also during continuous shooting, the white frame is displayed repeatedly.

Caution

- Defocused image areas may be incomplete when shooting near maximum aperture at high shutter speeds, depending on shooting conditions. If you dislike the appearance of defocused image areas, shooting as follows may give better results.
 - Shoot with an option other than **[Elec. 1st-curtain]**.
 - Lower the shutter speed.
 - Increase the aperture value.

Precautions when set to **[Electronic]**

- Be responsible when using electronic shutter, and respect subject privacy and portrait rights.
- Some restrictions on shutter speed apply. Shutter speeds slower than 0.5 sec. are not available.
- The continuous shooting speed may become slower depending on the shooting conditions.
- In shots of fast-moving subjects, the subject may be distorted, or in continuous shooting with Servo AF, shots may be out of focus.
- With some lenses and under some shooting conditions, lens focusing and aperture adjustment may be audible.
- Bands of light may be displayed and captured images may be affected by light and dark banding if you shoot with electronic shutter during flash firing by other cameras or under fluorescent lighting or other flickering light sources.
- Zooming during continuous shooting may cause changes in exposure even at the same f/number. For details, refer to the Canon website.
- **[Elec. 1st-curtain]** is used for bulb exposures.
- AEB shooting and flash photography are not available.
- Some functions will be restricted, but you can return to shooting with previous settings by switching to a setting other than **[Electronic]** or switching to viewfinder shooting.

Exposure Simulation

With exposure simulation, image brightness more closely matches the actual brightness (exposure) of your shots.

1. Select [📷: Expo. simulation].

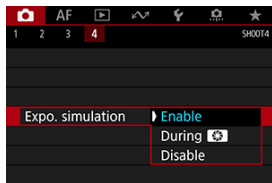

2. Set an option.

- **Enable** (Exp.SIM)

The displayed image brightness will be close to the actual brightness (exposure) of the resulting image. If you set exposure compensation, the image brightness will change accordingly.

- **During** (📷)

Normally, Live View images are displayed at standard brightness, so they are easy to see (📷DISP). Only when you hold down the depth-of-field preview button will image brightness resemble actual brightness (exposure) of the resulting image (Exp.SIM).

- **Disable** (📷DISP)

Live View images are displayed at standard brightness, so they are easy to see. Even if you set exposure compensation, the image is displayed at the standard brightness.

Metering Timer

You can set how long the metering timer runs (which determines the duration of exposure display/AE lock) after it is triggered by an action such as pressing the shutter button halfway.

1. Select [📷: Metering timer].

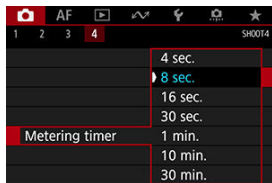

2. Set a time option.

General Live View Shooting Precautions









Caution

- Do not point the camera toward an intense light source, such as the sun or an intense artificial light source. Doing so may damage the image sensor or the camera's internal components.

Image quality

- When you shoot at high ISO speeds, noise (such as dots of light and banding) may become noticeable.
- Shooting in high temperatures may cause noise and irregular colors in the image.
- Live View shooting over an extended period may cause high internal temperatures and affect image quality. Exit Live View shooting when you are not shooting.
- If you shoot a long exposure while the camera's internal temperature is high, image quality may decline. Exit Live View shooting and wait a few minutes before shooting again.

White and red internal temperature warning icons

- White  or red  icons indicate high internal camera temperature, caused by factors such as extended Live View shooting or Live View shooting in hot environments.
- The white  icon indicates that the image quality of still photos will decline. Stop Live View shooting for a while and allow the camera to cool down.
- Shooting at low ISO speeds instead of high speeds is recommended when the white  icon is displayed.
- The red  icon indicates that Live View shooting will soon stop automatically. Shooting will not be possible again until the camera cools down internally, so stop Live View shooting temporarily or turn off the camera and let it cool down a while.
- Live View shooting in hot environments over extended periods will cause the white  or red  icon to appear sooner. When you are not shooting, always turn off the camera.
- If the camera's internal temperature is high, the quality of images shot with a high ISO speed or long exposure may decline even before the white  icon is displayed.

Shooting results

- In magnified view, the shutter speed and aperture value will be displayed in red. If you take the picture in magnified view, the exposure may not come out as desired. Return to the normal view before taking the picture.
- Even if you take the picture in magnified view, the image will be captured with the image area of the normal view.

Live View image

- Under low- or bright-light conditions, the displayed image may not reflect the brightness of the captured image.
- Although noise may be noticeable in Live View images under low light (even at low ISO speeds), there will be less noise in your shots, due to differences in image quality between Live View images and captured images.
- The screen may flicker if the light source (lighting) changes. In this case, stop Live View shooting temporarily before you continue shooting under the light source you will use.
- Pointing the camera at different direction may momentarily prevent correct display of brightness. Wait until the brightness level stabilizes before shooting.
- If there is a very bright light source in the image, the bright area may appear black on the screen. However, the actual captured image will correctly show the bright area.
- Under low light, bright [: **Disp. brightness**] settings may cause noise or irregular colors in Live View images. However, the noise or irregular colors will not be recorded in the captured image.
- When you magnify the image, the image sharpness may look more pronounced than in the actual image.

Custom Functions

- Some Custom Functions are not available in Live View shooting (some settings have no effect).

Lens and flash

- If the attached lens has an Image Stabilizer and you set the Image Stabilizer switch to **< ON >**, the Image Stabilizer will operate at all times even if you do not press the shutter button halfway. The Image Stabilizer consumes battery power and may decrease the number of available shots depending on the shooting conditions. When the Image Stabilizer is not necessary, such as when using a tripod, it is recommended that you set the Image Stabilizer switch to **< OFF >**.
- Focus preset is available in Live View shooting only when using (super) telephoto lenses equipped with this function released in and after the second half of 2011.
- Modeling flash is not available when a Speedlite is used.

Movie Recording



For movie recording, set the Live View shooting/Movie shooting switch to <  >.

Caution

- When switching from still photo shooting to movie recording, check the camera settings again before recording movies.

- [Tab Menus: Movie Recording](#)
- [Movie Recording](#)
- [Movie Recording Quality](#)
- [Sound Recording](#)
- [Time Code](#)
- [Canon Log Settings](#)
- [Movie Digital IS](#)
- [Other Menu Functions](#)
- [General Movie Recording Precautions](#)

Tab Menus: Movie Recording

● Shooting 1

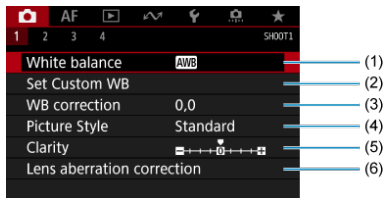

- (1) [White balance](#)
- (2) [Set Custom WB](#)
- (3) [WB correction](#)
- (4) Picture Style
 - [Picture Style Selection](#)
 - [Picture Style Customization](#)
 - [Picture Style Registration](#)
- (5) [Clarity](#)
- (6) [Lens aberration correction](#)

● Shooting 2

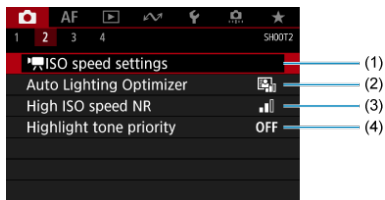

- (1) [ISO speed settings](#)
 - ISO Speed in < [\[ISO\]](#) >, < [\[TV\]](#) >, and < [\[Av\]](#) > Modes
 - ISO Speed in < [\[M\]](#) > Mode
- (2) [Auto Lighting Optimizer](#)
- (3) [High ISO speed NR](#)
- (4) [Highlight tone priority](#)

● Shooting 3

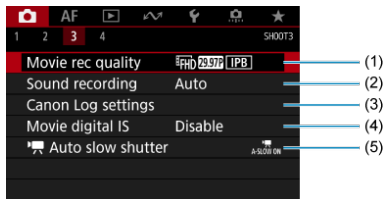

- (1) [Movie rec quality](#)
- (2) [Sound recording](#)
- (3) [Canon Log settings](#)
- (4) [Movie digital IS](#)
- (5) [Auto slow shutter](#)

● Shooting 4

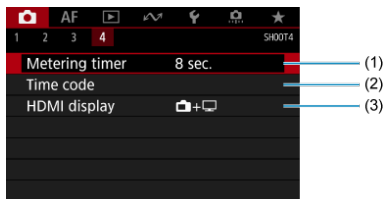

- (1) [Metering timer](#)
- (2) [Time code](#)
- (3) [HDMI display](#)

Movie Recording

- [☑ !\[\]\(849840539e55921a3851a4ff96d7400d_img.jpg\) Program AE](#)
- [☑ !\[\]\(c176e0b06f6c5dd85a4598b214d1ebba_img.jpg\) Tv Shutter-Priority AE](#)
- [☑ !\[\]\(66a18e26647fc145bd9198dd182dd107_img.jpg\) Av Aperture-Priority AE](#)
- [☑ ISO Speed in !\[\]\(572bcf30fdd4de64673b94584b7c6eca_img.jpg\), !\[\]\(ba6dc7fecffbf82e7fd414c1c97a1ece_img.jpg\), and !\[\]\(7b0c59a8d567ae8f4c94e1b0dfc0504e_img.jpg\) Modes](#)
- [☑ !\[\]\(6e7b00b003bc1efbd5a833fe586c1576_img.jpg\) Manual Exposure Recording](#)
- [☑ ISO Speed in !\[\]\(f2e2aef7ad678fd5527dfd3a24e78b6d_img.jpg\) Mode](#)
- [☑ Shutter Speed](#)
- [☑ Still Photo Shooting](#)
- [☑ Information Display \(Movie Recording\)](#)

Program AE

In  recording mode, exposure is controlled automatically to suit the brightness.

1. Set the Live View shooting/Movie shooting switch to .

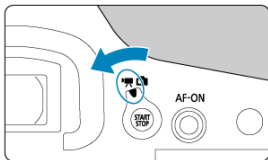

2. Set the recording mode to < [Movie] >.

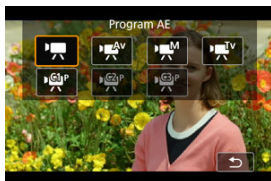

- Press the < **MODE** > button, then turn the < [Mode Dial] > or < [Mode Dial] > dial for selection.

3. Focus on the subject.

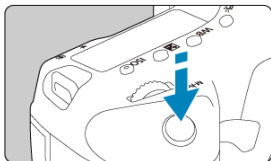

- Before recording a movie, focus with AF (AF) or manual focus (MF).
- By default, [**AF: Movie Servo AF**] is set to [**Enable**] so that the camera always keeps focusing (AF).
- When you press the shutter button halfway, the camera will focus with the current AF method.

4. Record the movie.

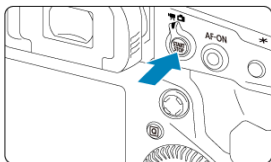

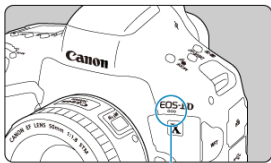

- Press the < START/STOP > button to start recording a movie.
- While the movie is being recorded, the [●REC] icon (1) will be displayed in the upper right of the screen.





- Sound is recorded with the movie microphone (2).
- To stop recording the movie, press the < START/STOP > button again.

Shutter-Priority AE

<  > recording mode enables you to set your preferred shutter speed for movies. ISO speed and aperture values are set automatically to suit the brightness and obtain standard exposure.

1. Set the Live View shooting/Movie shooting switch to <  >.
2. Set the recording mode to <  >.



- Press the < **MODE** > button, then turn the <  > or <  > dial for selection.

3. Set the shutter speed (1).

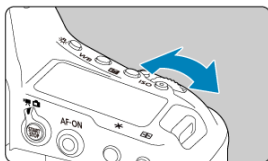

(1)

- Turn the <  > dial to set it.
- The available shutter speeds vary depending on the frame rate.

4. Focus and record the movie.





- The procedure is the same as steps 3 and 4 for [Program AE](#).

 **Caution**



- Avoid adjusting shutter speed while recording movies, which will record changes in exposure.
- When recording a movie of a moving subject, a shutter speed of approx. 1/25 sec. to 1/125 sec. is recommended. The faster the shutter speed, the less smooth the subject's movement will look.
- If you change the shutter speed while recording under fluorescent or LED lighting, image flicker may be recorded.

Aperture-Priority AE

<  > recording mode enables you to set your preferred aperture value for movies. ISO speed and shutter speed are set automatically to suit the brightness and obtain standard exposure.

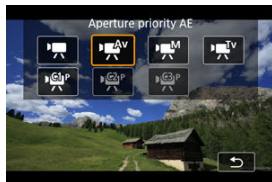
1. Set the Live View shooting/Movie shooting switch to <  >.
2. Set the recording mode to <  >.



- Press the < **MODE** > button, then turn the <  > or <  > dial for selection.

3. Set the aperture value (1).

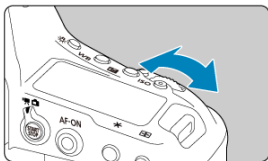

(1)

- Turn the <  > dial to set it.

4. Focus and record the movie.











- The procedure is the same as steps 3 and 4 for [Program AE](#).

Caution

- Avoid adjusting the aperture value while recording movies, which will record changes in exposure caused by aperture adjustment.

 **Note**

Notes for <  >, <  >, and <  > modes



- You can lock the exposure (AE lock) by pressing the <  > button. After applying AE lock during movie recording, you can cancel it by pressing the <  > button. (AE lock setting is retained until you press the <  > button.)
- Exposure compensation can be set in a range of up to ± 3 stops by turning the <  > dial.
- In <  > mode, the ISO speed, shutter speed, and aperture value are not recorded in movie Exif information.
- The camera is compatible with Speedlite functionality to activate the LED light automatically under low light when recording movies in <  >, <  >, and <  > modes. For details, refer to the Instruction Manual of the EX series Speedlite equipped with an LED light.

ISO Speed in , , and Modes



ISO speed is set automatically. See [ISO Speed in Movie Recording](#).

Manual Exposure Recording

You can manually set the shutter speed, aperture value, and ISO speed for movie recording.

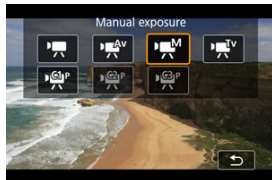

1. Set the Live View shooting/Movie shooting switch to .
2. Set the recording mode to .

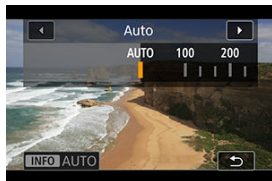

- Press the **< MODE >** button, then turn the  or  dial for selection.

3. Set the ISO speed.



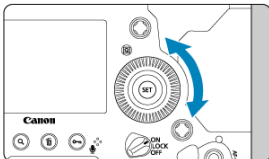
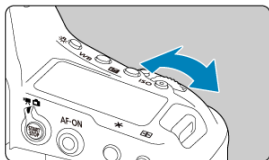

- Press the **< ISO >** button.
- Turn the  or  dial to set it.

4. Set the shutter speed (1) and aperture value (2).



(1)

(2)

- Press the shutter button halfway and check the exposure level indicator.
- To set the shutter speed, turn the <  > dial. To set the aperture value, turn the <  > dial.
- The available shutter speeds vary depending on the frame rate.











5. Focus and record the movie.

- The procedure is the same as steps 3 and 4 for [Program AE](#).

Caution

- ISO speed cannot be expanded to L, H2, or H3 (equivalent to ISO 50, ISO 409600, and ISO 819200, respectively) in movie recording.
- During movie recording, avoid changing the shutter speed, aperture value, or ISO speed, which may record changes in the exposure or create more noise at high ISO speeds.
- When recording a movie of a moving subject, a shutter speed of approx. 1/25 sec. to 1/125 sec. is recommended. The faster the shutter speed, the less smooth the subject's movement will look.
- If you change the shutter speed while recording under fluorescent or LED lighting, image flicker may be recorded.



Note

- Exposure compensation with ISO Auto can be set in a range of ± 3 stops when [ **6: Custom Controls**] is set to [ **Expo comp (hold btn, turn )**] ().
- When ISO Auto is set, you can press the <  > button to lock the ISO speed. After locking the ISO speed during movie recording, you can cancel it by pressing the <  > button. (ISO speed lock is maintained until you press the <  > button.)
- If you press the <  > button and recompose the shot, you can see the exposure level difference on the exposure level indicator () compared to when the <  > button was pressed.

ISO Speed in <M> Mode

You can set the ISO speed manually or select [AUTO] to set it automatically. For details on ISO speed, see [ISO Speed in Movie Recording](#).

Shutter Speed

Available shutter speeds in <  TV > and <  M > mode vary depending on the frame rate of your specified movie recording quality.

Frame Rate	Shutter Speed (Sec.)	
	Normal Movie Recording	High Frame Rate Movie Recording
119.9P	-	1/4000-1/125
100.0P		1/4000-1/100
59.94P	1/4000-1/8	-
50.00P		
29.97P		
25.00P		
24.00P		
23.98P		

Still Photo Shooting

Still photos cannot be taken during movie recording. To take still photos, stop the movie recording and perform viewfinder shooting or Live View shooting.

Information Display (Movie Recording)





For details on the icons on the movie recording screen, see [Information Display](#).

Caution

Precautions for movie recording

- Do not point the camera toward an intense light source, such as the sun or an intense artificial light source. Doing so may damage the image sensor or the camera's internal components.
- If you record something that has fine detail, moire or false colors may result.
- If < **AWB** > or < **AWBW** > set and the ISO speed or aperture value changes during movie recording, the white balance may also change.
- If you record a movie under fluorescent or LED lighting, the movie image may flicker.
- If you perform AF with a USM lens during movie recording in low light, horizontal banding noise may be recorded in the movie. The same type of noise may occur if you focus manually with certain lenses equipped with an electronic focusing ring.
- Recording a few test movies is recommended if you intend to perform zooming during movie recording. Zooming as you record movies may cause exposure changes or lens sounds to be recorded, an uneven audio level, inaccurate lens aberration correction, or loss of focus.
- Large aperture values may delay or prevent accurate focusing.
- Performing AF during movie recording may cause the following kinds of issues: significant temporary loss of focus, recording of changes in movie brightness, temporary stopping of movie recording, or recording of mechanical lens sounds.
- Avoid covering the built-in movie microphone with your fingers or other objects.
- Connecting or disconnecting an HDMI cable during movie recording will end recording.
- Also see [General Movie Recording Precautions](#).
- Also see [General Live View Shooting Precautions](#), as needed.

 **Note****Notes for movie recording**

- Each time you record a movie, a new movie file is created on the card.
- Field of view (coverage) is approx. 100%.
- Focusing is also possible by pressing the < **AF-ON** > button.
- To enable starting/stopping movie recording by pressing the shutter button completely, set [**Fully-press**] for [: **Shutter btn function for movies**] to [**Start/stop mov rec**] () .
- Monaural sound is recorded with the built-in microphone for movie recording () .
- Stereo sound can be recorded by connecting an external microphone such as Directional Stereo Microphone DM-E1 (sold separately) to the camera's external microphone IN terminal, which will be used instead of the built-in microphone () .
- Most external microphones equipped with a 3.5 mm mini-jack can be used.
- Focus preset during movie recording is available when using (super) telephoto lenses equipped with this function released in and after the second half of 2011.

Movie Recording Quality

- ✔ [Movie Recording Size](#)
- ✔ [4K Movie Recording](#)
- ✔ [Image Area](#)
- ✔ [Cards That Can Record Movies](#)
- ✔ [High Frame Rate](#)
- ✔ [Movie Files Exceeding 4 GB](#)
- ✔ [Total Movie Recording Time and File Size Per Minute](#)
- ✔ [Movie Recording Time Limit](#)

You can set the image size, frame rate, compression method, and recording format in the [Movie rec. size] menu of [📷: Movie rec quality].

The frame rate displayed on the [Movie rec. size] screen switches automatically depending on the [🔧: Video system] setting (🔗).



- A different screen is displayed when [🔊 Rec options] in [🔧: Record func+card/folder sel.] is set to [1 RAW, 2 MP4].

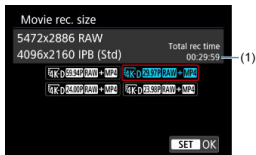

- (1) The recording time of the card with less available time is displayed.
- Movies in RAW format are recorded at 5472×2886 and movies in MP4 format at 4096×2160 IPB (Standard).

Caution

- The card's writing/reading speeds required for recording movies (card performance requirements) vary depending on the movie recording quality. Before recording movies, see [Cards that can record movies](#) to check card performance requirements.

Movie Recording Size

Image size

	Image Size	Aspect Ratio
4K-D	5472×2886	17:9
	4096×2160	17:9
4K-D* Crop	4096×2160	17:9
4K-U	3840×2160	16:9
FHD	1920×1080	16:9

* Movies can be cropped around the center of the image, as if recorded with a telephoto lens.



Caution

- If you change the [🔧: Video system] setting, also set [📷: Movie rec quality] again.
- Other devices may not play movies such as 4K, FHD 59.94P/50.00P, and High Frame Rate movies normally, because playback is processing-intensive.
- Apparent resolution and noise vary slightly depending on movie recording quality and settings for the lens used.

Note

- To obtain better performance with the card, formatting the card with the camera before recording movies is recommended (🔗).
- Movies cannot be recorded in HD or VGA quality.

4K Movie Recording

- Recording 4K movies requires a stable card with a fast writing speed. For details, see [Cards That Can Record Movies](#).
- 4K or High Frame Rate movie recording greatly increases the processing load, which may increase the internal camera temperature faster or higher than for regular movies. **If a red  icon appears during movie recording, the card may be hot, so stop recording the movie and let the camera cool down before removing the card. (Do not remove the card immediately.)**
- From a 4K movie, you can select any frame to save to the card as a JPEG still image ()

Caution



- AF is not used to focus when  or  is set. No AF points are displayed. Also note that the focus guide is not displayed, even with the lens's focus mode switch set to <MF>.

Image Area

The movie image area varies depending on factors such as movie recording quality settings and the lens used.

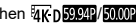

- (1) Still images (5472×3648) (JPEG L)
- (2) FHD (1920×1080)
- (3) RAW movies (5472×2886)/4K-D (4096×2160)
- (4) 4K-U (3840×2160)
- (5) 4K-Crop (4096×2160)

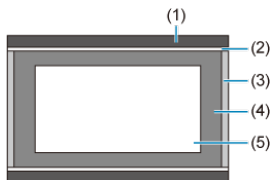
Caution

- Recording with Movie digital IS (📷) further crops the image around the center of the screen.

Frame rate (fps: frames per second)

- [119.9P] 119.9fps/[59.94P] 59.94fps/[29.97P] 29.97fps
For areas where the TV system is NTSC (North America, Japan, South Korea, Mexico, etc.). For [119.9P], see [High Frame Rate](#).
- [100.0P] 100.00fps/[50.00P] 50.00fps/[25.00P] 25.00fps
For areas where the TV system is PAL (Europe, Russia, China, Australia, etc.). For [100.0P], see [High Frame Rate](#).
- [23.98P] 23.98fps/[24.00P] 24.00fps
Mainly for motion pictures. [23.98P] (23.98 fps) is available when [📷: Video system] is set to [For NTSC].

Compression method

- **[ALL-I]** **ALL-I** (For editing/I-only)
Compresses each frame, one at a time, for recording. Although file sizes are larger than with IPB (Standard), movies are more suitable for editing.
- **[IPB]** **IPB** (Standard)
Compresses multiple frames at a time efficiently for recording. File sizes are smaller than with ALL-I (For editing), which enables movie recording over longer periods (with a card of the same capacity).
- **[IPB]** **IPB** (Light)
Since the movie is recorded at a bit rate lower than with IPB (Standard), the file size will be smaller than with IPB (Standard) and the playback compatibility will be higher. This will make the available recording time longer than with IPB (Standard) (with a card having the same capacity).

Movie recording format

- **[RAW]** **RAW**
When **[RAW]** is selected, movies are recorded as RAW movie files (file extension “.CRM”).
- **[MP4]** **MP4**
When **[ALL-I]**, **[IPB]**, or **[IPB]** is selected, movies are recorded as MP4 movie files (file extension “.MP4”). This file format provides higher compatibility for playback than with MOV.

RAW movies

RAW movies are raw, unprocessed data from the image sensor that are recorded to the card digitally.

You can use Digital Photo Professional (EOS software) to process RAW movies. You can make various adjustments to images depending upon how they will be used and can generate JPEG, HEIF, or other types of images reflecting the effects of those adjustments.

Caution

- RAW movies cannot be processed with **[▶]**: **RAW image processing**.

 **Note**

- To display RAW movies on a computer, using Digital Photo Professional (EOS software, hereafter DPP) is recommended.
- Older versions of DPP Ver.4.x do not support display, processing, editing, or other operations with RAW movies recorded by this camera. If a previous version of DPP Ver.4.x is installed on your computer, obtain and install the latest version of DPP from the Canon website to update it (). (The previous version will be overwritten.) Similarly, DPP Ver.3.x or earlier does not support display, processing, editing, or other operations with RAW movies recorded by this camera.
- Commercially available software may not be able to display RAW movies recorded by this camera. For compatibility information, contact the software manufacturer.
- To prioritize gradation in highlights, set Canon Log to **[On]**. For RAW movies, consider setting the color matrix to CINEMA EOS Original.

Cards That Can Record Movies

For details on cards that can record at each level of movie recording quality, check the Canon website.

Test cards by recording a few movies to make sure they can record correctly at your specified size (🔗).

Caution

- Before recording 4K movies, format cards by selecting [**Low level format**] in [**Format card**] (🔗).
- If you use a slow-writing card when recording movies, the movie may not be recorded properly. Also, if you play back a movie on a card with a slow reading speed, the movie may not be played back properly.
- When recording movies, use high-performance cards with a writing speed sufficiently higher than the bit rate.
- When movies cannot be recorded properly, format the card and try again. If formatting the card does not resolve the problem, refer to the card manufacturer's website, etc.

Note

- To obtain better performance with the card, formatting the card with the camera before recording movies is recommended (🔗).

High Frame Rate

You can record Full HD movies at a high frame rate of 119.9 fps or 100.0 fps. This is ideal for recording movies that will be played back in slow motion. The maximum recording time per movie is 7 min. 29 sec.

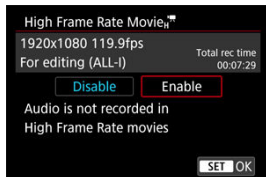

- Movies are recorded in **FHD 119.9P [ALL-I]** or **FHD 100.0P [ALL-I]** quality.
- Sound is not recorded in High Frame Rate movies.
- Time code display during movie recording advances 4 sec. per second.
- Because High Frame Rate movies are recorded as 29.97 fps/25.00 fps movie files, they are played in slow motion at 1/4 speed.

Caution

Precautions when set to [High Frame Rate: Enable]

- Time codes are not recorded when [Count up] is set to [Free run] in [📷: Time code] (🔍).
- Check the [Movie rec. size] setting if you return this setting to [Disable].
- The screen may flicker if you record High Frame Rate movies under fluorescent or LED lighting.
- For a moment when you start or stop recording High Frame Rate movies, the movie is not updated, and the frame stops momentarily. Be aware of this when recording movies to external devices via HDMI.
- Movie frame rates shown on the screen as you record High Frame Rate movies do not correspond to the frame rate of the movie recorded.
- Headphones cannot be used (no sound is audible).

Movie Files Exceeding 4 GB

Even if you record a movie exceeding 4 GB, you can keep recording without interruption.

Caution

- When importing movie files exceeding 4 GB to a computer, use either EOS Utility or a card reader (🔗). It may not be possible to save movie files exceeding 4 GB if you attempt this using standard features of the computer's operating system.

Total Movie Recording Time and File Size Per Minute

See [Total movie recording time and file size per minute](#).

Movie Recording Time Limit

- **When recording non-High Frame Rate movies**

The maximum recording time per movie is 29 min. 59 sec. Once 29 min. 59 sec. is reached, recording automatically stops. You can start recording a movie again by pressing the < $\begin{matrix} \text{START} \\ \text{STOP} \end{matrix}$ > button (which records the movie as a new file).

- **When recording High Frame Rate movies**

The maximum recording time per movie is 7 min. 29 sec. Once 7 min. 29 sec. is reached, recording automatically stops. You can start recording a High Frame Rate movie again by pressing the < $\begin{matrix} \text{START} \\ \text{STOP} \end{matrix}$ > button (which records the movie as a new file).

Sound Recording

[☑ Sound Recording/Sound-Recording Level](#)

[☑ Wind Filter](#)

[☑ Attenuator](#)

You can record movies while recording sound with the built-in monaural microphone or an external stereo microphone. You can also freely adjust the sound-recording level.

Use **[CAMERA] : Sound recording** to set sound recording functions.

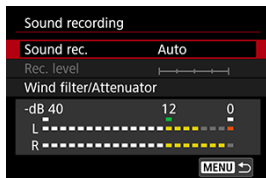

⚠ Caution

- Sounds from Wi-Fi operations may be captured with built-in or external microphones. During sound recording, using the wireless communication function is not recommended.
- When connecting an external microphone or headphones to the camera, be sure to insert the plug all the way in.
- If AF operations are performed or you control the camera or lens during movie recording, the camera's built-in microphone may also record mechanical sounds of the lens or sounds of camera/lens operations. In this case, using an external microphone may reduce these sounds. If the sounds are still distracting with an external microphone, it may be more effective to remove the external microphone from the camera and position it away from the camera and lens.
- Line input up to +6 dBV is supported, but levels higher than the standard input level of -8 dBV may cause worse distortion. Taking test shots in advance is recommended.
- For line input, always set **[Sound rec.]** to **[Line input]**. Supplying audio when it is not set to **[Line input]** may damage the camera.
- Setting the sound recording option to **[Line input]** disables recording by the built-in movie microphone. Additionally, **[Wind filter]** and **[Attenuator]** are not available.
- Noise reduction is not applied to the audio played through headphones. Thus, the audio recorded with the movie will be different.
- Do not change the **[Manual]** or **[Line input]** settings when listening with headphones. This may cause sudden loud output that may hurt your ears.

 **Note**

- Audio is also output when the camera is connected to televisions via HDMI, except when **[Sound rec.]** is set to **[Disable]**. In case of feedback from television audio output, move the camera away from the television or turn down the volume.
- The sound volume balance between L (left) and R (right) cannot be adjusted.
- Sound is recorded at a 48 kHz/16-bit sampling rate.

Sound Recording/Sound-Recording Level

- **Auto**

The sound-recording level is adjusted automatically. Auto level control will take effect automatically in response to the sound level.

- **Manual**

You can adjust the sound-recording level as needed. Select **[Rec. level]** and turn the <  > dial while looking at the level meter to adjust the sound-recording level. Look at the peak hold indicator, and adjust so that the level meter sometimes lights up on the right of the "12" (-12 dB) mark for the loudest sounds. If it exceeds "0", the sound will be distorted.

- **Line input**

Line input can be used as the audio source. Audio supplied this way is combined with video to record movies. You can adjust the recording level to one of 64 levels. The adjustment method is the same as for **[Manual]**.

- **Disable**

Sound will not be recorded.

Wind Filter

Set to **[Enable]** to reduce wind noise when there is wind outdoors. Only activated when the camera's built-in microphone is used. When the wind filter function takes effect, part of the low bass sounds will also be reduced.

Attenuator

Automatically suppresses sound distortion caused by loud noises. Even if **[Sound rec.]** is set to **[Auto]** or **[Manual]** for recording, sound distortion may still result if there is a very loud sound. In this case, setting it to **[Enable]** is recommended.

● Microphone

Normally, monaural sound is recorded with the built-in movie microphone. Stereo sound can be recorded by connecting an external microphone with a 3.5 mm mini-jack to the camera's external microphone IN terminal (🔊), which the camera will use instead. Using an external microphone such as Directional Stereo Microphone DM-E1 (sold separately) is recommended.

● Line input

Direct input is supported for line-out stereo sound from mixers or other devices. Audio from a 3.5 mm mini-jack connected to the camera's line input terminal (🔊) is combined with video to record movies with stereo sound. The standard input level is -8 dBV. Adjust the audio recording level to suit the line-out level.

● Headphones

By connecting commercially available headphones with a 3.5 mm mini-jack to the headphone terminal (🎧), you can listen to the sound as movies are recorded. You can listen in stereo to audio from an external stereo microphone. To adjust headphone volume, press the < [Q] > button, select < 🔊 >, then turn the < 🔄 > dial for adjustment (🔊).

You can also use headphones during movie playback.

Time Code

- [Count Up](#)
- [Start Time Setting](#)
- [Movie Recording Count](#)
- [Movie Play Count](#)
- [HDMI](#)
- [Drop Frame](#)

Time codes record the time automatically as movies are recorded. Time codes always record elapsed hours, minutes, seconds, and frames. They are mainly used when movies are edited.

To set up the time code, use [: **Time code**].

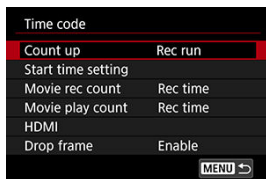

Caution

- Time codes may not be displayed correctly if your movies are played back on devices other than the camera.

Count Up

- **Rec run**
The time code advances only during movie recording. Time codes in each movie file recorded continue from the last time code in the previous file.
- **Free run**
The time code keeps advancing, even when you are not recording.

Caution

- When set to **[Free run]**, time codes are not added to High Frame Rate movies that you record.
- When set to **[Free run]**, time codes will be affected by any changes to settings for time, zone, or daylight saving time (🕒).

Start Time Setting

You can set the initial time of the time code.

- **Manual input setting**
Enables you to set any starting hour, minute, second, and frame.
- **Reset**
Resets the time set with **[Manual input setting]** or **[Set to camera time]** to "00:00:00." or "00:00:00:" (⌚).
- **Set to camera time**
Matches the hour, minute, and second set as the time on the camera. Sets the frame value to "00."

Movie Recording Count

You can select how time is displayed on the movie recording screen.

- **Rec time**
Displays the elapsed time since movie recording began.
- **Time code**
Displays the time code during movie recording.



Movie Play Count

You can select how time is displayed on the movie playback screen.

- **Rec time**
Displays the recording or playback time during movie playback.
- **Time code**
Displays the time code during movie playback.



Note

- Time codes are always recorded to movie files (except for High Frame Rate movies set to **[Free run]**), regardless of the **[Movie rec count]** setting.
- The **[Movie play count]** setting in **[Camera: Time code]** is linked to the **[Play button]: Movie play count**, so that these settings always match.
- The “frame” count is not displayed during movie recording or playback.

HDMI

● Time code

Time codes can be added to movies as you record them to an external device via HDMI.

• Off

No time code is added to HDMI video output.

• On

Time codes are added to HDMI video output. When **[On]** is set, **[Rec Command]** is displayed.

● Rec Command

For HDMI video output recorded by an external device, you can synchronize recording to when you start and stop recording movies on the camera.

• Off

Recording is started and stopped by the external device.

• On

Recording by an external device is synchronized to starting/stopping recording on the camera.



Caution

- Time codes are not added to HDMI video output when you record High Frame Rate movies with **[Count up]** in **[Time code]** set to **[Free run]**.
- To determine compatibility of external recording devices with **[Time code]** and **[Rec Command]** functions, check with the device manufacturer.
- Even with **[Time code]** set to **[Off]**, external recording devices may add time codes to movies, depending on their specifications. For details on device specifications relevant to adding time code to HDMI input, check with the device manufacturer.

Drop Frame

The time code's frame count will cause a discrepancy between the actual time and the time code if the frame rate is set to **119.9P** (119.9 fps), **59.94P** (59.94 fps), or **29.97P** (29.97 fps). The discrepancy is corrected automatically when **[Enable]** is set. This correction function is called "drop frame."

- **Enable**

Corrects the discrepancy automatically by skipping time code numbers (DF: drop frame).

- **Disable**

The discrepancy is not corrected (NDF: non-drop frame). Time codes are displayed as follows.

- **Enable (DF)**

00:00:00. (Playback: 00:00:00.00)

- **Disable (NDF)**

00:00:00. (Playback: 00:00:00.00)



Note

- Drop frame is not used for **100.0P** (100.0 fps), **50.00P** (50.00 fps), **25.00P** (25.00 fps), **24.00P** (24.00 fps), or **23.98P** (23.98 fps) frame rates. (The **[Drop frame]** setting item is not displayed when **100.0P/50.00P/25.00P/24.00P/23.98P** is set, or when **[Video system]** is set to **[For PAL]**.)

Canon Log Settings

[Shooting Settings](#)

[Canon Log Image Quality](#)

Canon Log gamma curve takes full advantage of image sensor characteristics to ensure wide dynamic range for movies that will be processed in postproduction. With minimal loss of detail in shadows and highlights, movies retain more visual information across the dynamic range.

To work with Canon Log movies in postproduction, you can apply look-up tables (LUTs). LUT data can be downloaded from the Canon website.

1. Select [CAMERA]: Canon Log settings].

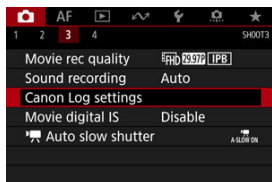

2. Select [Canon Log].

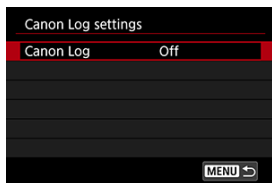

3. Select [On] (🔍).



4. Set the options as desired.

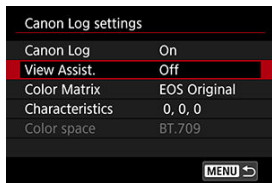

- Set [\[View Assist.\]](#), [\[Color Matrix\]](#), [\[Characteristics\]](#), and [\[Color space\]](#).

Canon Log



- **On**
Enables 10-bit recording of Canon Log movies to the card. Movies can also be recorded to an external device that supports 10-bit recording.

View Assist.

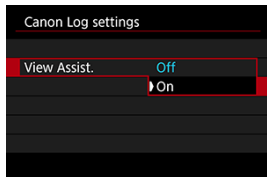

When played on the camera, these movies may look darker and have lower contrast than movies recorded with a Picture Style applied, due to Canon Log image characteristics, which are intended to ensure a wide dynamic range. For clearer display that makes it easier to check details, set **[View Assist.]** to **[On]**.

- Setting this feature to **[On]** does not affect movies recorded to the card, which are recorded using Canon Log. Similarly, HDMI video output has Canon Log characteristics, and View Assist is not used for it.

Note

- **[V.Assist]** is shown on the information display screen during movie recording with View Assist.
- When set to **[On]**, View Assist is also used with magnified display.

Color Matrix

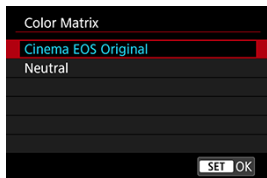

Using a color matrix, you can specify how colors are reproduced, to plan for postproduction processing.

- **Cinema EOS Original**
Reproduces colors equivalent to those of the EOS-1D C.
- **Neutral**
Reproduces colors similar to actual subject colors.

Characteristics

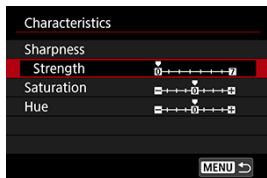

Adjust as needed. Select an item ([**Sharpness: Strength**], [**Saturation**], or [**Hue**]), adjust the effect level, then press < (SET) >.

Sharpness: Strength		0: Weak outline emphasis	7: Strong outline emphasis
Saturation		-4: Low	+4: High
Hue*	Reds	-4: Toward magenta	+4: Toward yellow
	Greens	-4: Toward yellow	+4: Toward cyan
	Blues	-4: Toward cyan	+4: Toward magenta

* Reds, greens, and blues cannot be adjusted separately.

Color space

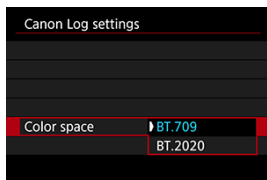

[**Color space**] can be set when [**Canon Log**] is set to [**On**] and [**Color Matrix**] to [**Neutral**]. Choose [**BT.709**] or [**BT.2020**] as the color space for HDMI output.

Shooting Settings

- Manually setting the ISO speed to 100–320 will make the dynamic range narrower.
- Canon Log offers a dynamic range of approx. 800% at ISO 400 or higher.
- ISO 100, 125, 160, 200, 250, and 320 are expanded ISO speeds. [L] is displayed when an ISO speed is set.

Canon Log Image Quality

- Noise may increase slightly.
-

Caution

General Canon Log shooting precautions

- With Canon Log, autofocusing may be more difficult for subjects under low light, or for low-contrast subjects.
- Canon Log 2 and Canon Log 3 are not supported.

Note

Playing movies recorded with Canon Log

- View Assist is not used during movie playback.

Movie Digital IS

The camera's Movie digital IS feature reduces camera shake as movies are recorded. Movie digital IS can provide effective stabilization even when your lens is not equipped with Image Stabilizer. When using a lens equipped with Image Stabilizer, set the lens's Image Stabilizer switch to < ON >.

1. Select [📷: Movie digital IS].

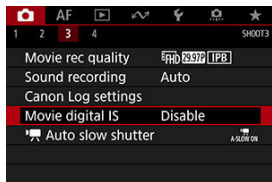

2. Select an option.

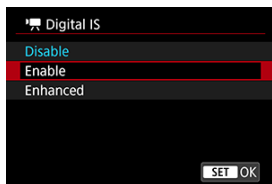

- **Disable** (📷 OFF)
Image stabilization with Movie digital IS is disabled.
- **Enable** (📷 ON)
Camera shake will be corrected. The image will be slightly magnified.
- **Enhanced** (📷 ON)
Compared to when [Enable] is set, stronger camera shake can be corrected. The image will be more magnified.

 Caution

- Movie digital IS will not function when the lens's optical Image Stabilizer switch is set to < OFF >.
- Although movies can also be recorded with Movie digital IS when [F_{Crop}^{4K/D}] is set, the image area is further reduced.
- With a lens whose focal length is longer than 800 mm, Movie digital IS will not function.
- Stabilization by Movie digital IS may be less effective at some movie recording sizes.
- The wider the angle of view (wide angle), the more effective the image stabilization will be. The narrower the angle of view (telephoto), the less effective the image stabilization will be.
- When using a tripod, setting Movie digital IS to [Disable] is recommended.
- Depending on the subject and shooting conditions, the subject may blur noticeably (the subject momentarily looks out of focus) due to the effects of the Movie digital IS.
- When using a TS-E lens, fish-eye lens, or non-Canon lens, setting Movie digital IS to [Disable] is recommended.
- Since Movie digital IS magnifies the image, the image looks more grainy. Noise, dots of light, etc. may also become noticeable.

Other Menu Functions



- **Lens aberration correction**

Peripheral illumination, chromatic aberration, and diffraction can be corrected as you record movies. For details on lens aberration correction, see [Lens Aberration Correction](#).

● 📷 ISO speed settings

• ISO speed

In < 📷M > mode, you can set the ISO speed manually. You can also select ISO Auto.

• ISO speed range

For < 📷M > mode, you can set the manual ISO speed setting range (minimum and maximum limits).

• Max for Auto

You can set the maximum limit for ISO Auto in movie recording in < 📷M > / < 📷TV > / < 📷AV > mode or in < 📷M > mode with ISO Auto.



● Highlight tone priority

You can reduce overexposed, clipped highlights as you record movies. For details on Highlight tone priority, see [Highlight Tone Priority](#).

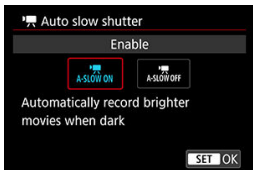
-  **Auto slow shutter**



You can choose whether to record movies that are brighter and less affected by image noise than when set to **[Disable]** by automatically slowing the shutter speed under low light.

Available in <  > or <  > recording mode. Applies when the frame rate of the movie recording size is **59.94P** or **50.00P**.

- **Disable**

Enables you to record movies with smoother, more natural movement, less affected by subject shake than when set to **[Enable]**. Note that under low light, movies may be darker than when set to **[Enable]**.

- **Enable**

Enables you to record brighter movies than when set to **[Disable]** by automatically reducing the shutter speed to 1/30 sec. (NTSC) or 1/25 sec. (PAL) under low light.

 **Note**

- Setting to **[Disable]** is recommended when recording moving subjects under low light, or when afterimages such as trails may occur.

● HDMI display

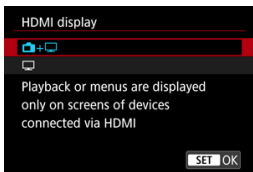

You can specify how movies are displayed as they are recorded via HDMI to an external device. Movie output itself is either 4K or Full HD, depending on the **[Movie rec. size]** setting.

The default setting is [📷+📺].





● 📷+📺

- Enables movie display both on the camera screen and on the other device, via HDMI output.
- Camera operations such as image playback or menu display are shown on the other device via HDMI, not on the camera.

● 📺

- Deactivates the camera screen during output via HDMI, so that the screen is blank.
- Shooting information, AF points, and other information is shown on the external device via HDMI, but you can stop output of this information by pressing the **<INFO>** button.
- Before recording movies externally, confirm that no information is being sent by the camera by making sure no shooting information, AF points, and so on is displayed on external monitors or other devices.

? For longer HDMI output

To continue HDMI output for longer than 30 min., select +, then set : **Auto power off** to **[Disable]** .

Caution

- HDMI output without information prevents display of warnings about the card space, battery level, or high internal temperature  via HDMI.
- During HDMI output, display of the next image may take some time if you switch between movies of different recording qualities or frame rates.
- Avoid operating the camera when recording movies to external devices, which may cause information to be displayed in the HDMI video output.
- Brightness and color of movies recorded with the camera may look different from that of HDMI video output recorded by external devices, depending on the viewing environment.





Note

- By pressing < **INFO** > the button, you can change the information displayed.
- Time codes can be added to HDMI video output .
- Audio is also output via HDMI, except when **[Sound rec.]** is set to **[Disable]**.

General Movie Recording Precautions

⚠ Caution

Red < > internal temperature warning icon

- If the camera's internal temperature increases due to prolonged movie recording or under a high ambient temperature, a red <  > icon will appear.
- The red <  > icon indicates that movie recording will soon be terminated automatically. If this happens, you will not be able to shoot again until the camera's internal temperature decreases, so turn off the power and let the camera cool down a while. Note that the time until movie recording stops automatically when the red <  > icon is displayed varies depending on shooting conditions.
- Recording a movie at a high temperature for a prolonged period will cause the red <  > icon to appear earlier. When you are not recording, always turn off the camera.

Recording and image quality

- If the attached lens has an Image Stabilizer and you set the Image Stabilizer switch to < ON >, the Image Stabilizer will operate at all times even if you do not press the shutter button halfway. This will consume battery power, and it may reduce the total movie recording time. When the Image Stabilizer is not necessary, such as when using a tripod, it is recommended that you set the Image Stabilizer switch to < OFF >.
- If the brightness changes as you record a movie with Program AE or shutter priority AE, the movie may appear to stop momentarily. In this case, record movies with manual exposure.
- If there is a very bright light source in the image, the bright area may appear black on the screen. Movies are recorded almost exactly as they appear on the screen.
- Image noise or irregular colors may occur when shooting at high ISO speeds, high temperatures, slow shutter speeds, or under low light. Movies are recorded essentially as they appear on the screen, except with Canon Log View Assist.
- Video and audio quality of recorded movies may be worse on other devices, and playback may not be possible, even if the devices support the camera's recording formats.
- If you use a card with a slow writing speed, an indicator may appear on the right of the screen during movie recording. The indicator shows how much data has not yet been written to the card (remaining capacity of the internal buffer memory), and it increases more quickly the slower the card is. If the indicator (1) becomes full, movie recording will stop automatically.



(1)

- If the card has a fast writing speed, the indicator will not appear or the level (if displayed) will not increase much. First, record a few test movies to see if the card can write fast enough.
- If the indicator shows that the card is full, and movie recording stops automatically, the sound near the end of the movie may not be recorded properly.
- If the card's writing speed is slow (due to fragmentation) and the indicator appears, formatting the card may make the writing speed faster.

Audio restrictions

- Note that the following restrictions apply with **[Movie rec. size]** compression set to **[IPB]** or **[IPB]** or **[.7: Audio compression]** set to **[Enable]**.
 - Sound will not be recorded for approx. the last two frames.
 - When you play back movies in Windows, movie images and sound may become slightly out of synchronization.

AF/Drive

This chapter describes autofocus operation and drive modes and introduces menu settings on the [**AF**: AF] tab.

Caution

- < **AF** > stands for autofocus. < **MF** > stands for manual focus.

- [Tab Menu: AF Tab \(Viewfinder Shooting\)](#)
- [Tab Menu: AF Tab \(Live View Shooting\)](#)
- [Tab Menu: AF Tab \(Movie Recording\)](#)
- [AF Operation](#)
- [Selecting the AF Area and AF Point \(Viewfinder Shooting\)](#)
- [AF Area Selection Modes \(Viewfinder Shooting\)](#)
- [Selecting the AF Method \(Live View Shooting\)](#)
- [AI Servo AF/Servo AF Characteristics](#)
- [Customizing AF Functions](#)
- [AF Microadjustment](#)
- [Manual Focus](#)
- [Selecting the Drive Mode](#)
- [Using the Self-Timer](#)

Tab Menus: AF Tab (Viewfinder Shooting)

● AF1



- (1) [Case 1](#)
- (2) [Case 2](#)
- (3) [Case 3](#)
- (4) [Case 4](#)
- (5) [Case A](#)
- (6) [Tracking sensitivity](#)
- (7) [Accel./decel. tracking](#)

● AF2

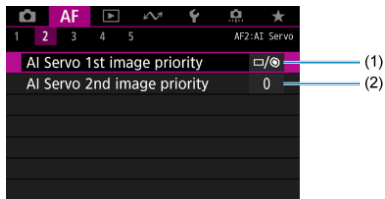

- (1) [AI Servo 1st image priority](#)
- (2) [AI Servo 2nd image priority](#)

● AF3

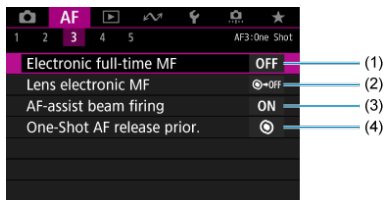

- (1) [Electronic full-time MF](#)
- (2) [Lens electronic MF](#)
- (3) [AF-assist beam firing](#)
- (4) [One-Shot AF release prior.](#)

● AF4

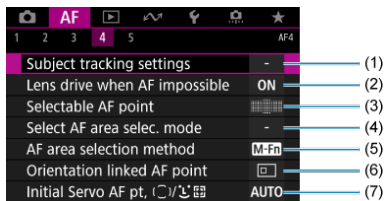

- (1) [Subject tracking settings](#)
- (2) [Lens drive when AF impossible](#)
- (3) [Selectable AF point](#)
- (4) [Select AF area selec. mode](#)
- (5) [AF area selection method](#)
- (6) [Orientation linked AF point](#)
- (7) [Initial Servo AF pt. \(☐\) \(☐\) \(☐\)](#)

● AF5

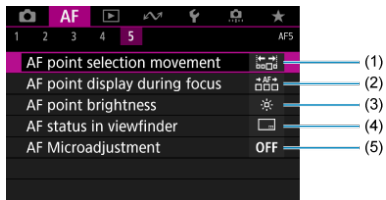

- (1) [AF point selection movement](#)
- (2) [AF point display during focus](#)
- (3) [AF point brightness](#)
- (4) [AF status in viewfinder](#)
- (5) [AF Microadjustment](#)

Tab Menus: AF Tab (Live View Shooting)

● AF1

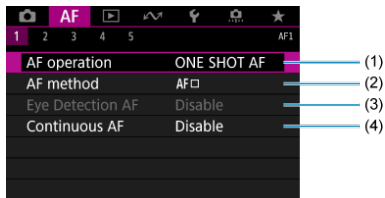

- (1) [AF operation](#)
- (2) [AF method](#)
- (3) [Eye Detection AF](#)
- (4) [Continuous AF](#)

● AF2

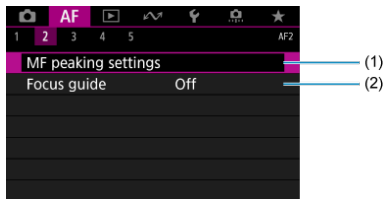

- (1) [MF peaking settings](#)
- (2) [Focus guide](#)

● AF3



- (1) [Case 1](#)
- (2) [Case 2](#)
- (3) [Case 3](#)
- (4) [Case 4](#)
- (5) [Case A](#)
- (6) [Tracking sensitivity](#)
- (7) [Accel./decel. tracking](#)

● AF4

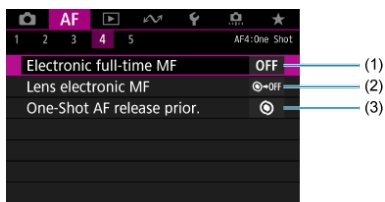

- (1) [Electronic full-time MF](#)
- (2) [Lens electronic MF](#)
- (3) [One-Shot AF release prior.](#)

● AF5

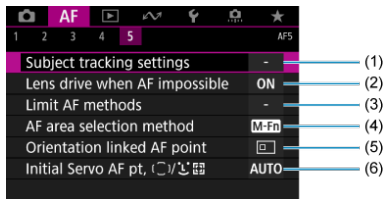

- (1) [Subject tracking settings](#)
- (2) [Lens drive when AF impossible](#)
- (3) [Limit AF methods](#)
- (4) [AF area selection method](#)
- (5) [Orientation linked AF point](#)
- (6) [Initial Servo AF pt.](#) [Icon]

Tab Menus: AF Tab (Movie Recording)

● AF1



- (1) [AF method](#)
- (2) [Movie Servo AF](#)
- (3) [Eye Detection AF](#)

● AF2

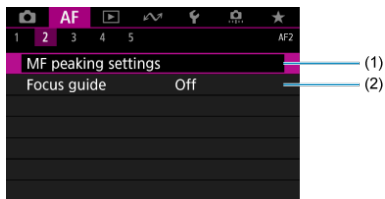

- (1) [MF peaking settings](#)
- (2) [Focus guide](#)

● AF3

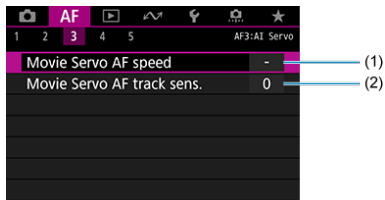

- (1) [Movie Servo AF speed](#)
- (2) [Movie Servo AF track sens.](#)

● AF4

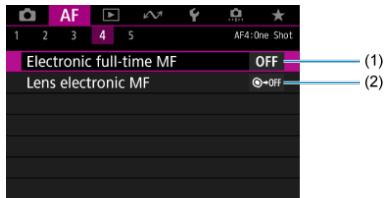

- (1) [Electronic full-time MF](#)
- (2) [Lens electronic MF](#)

● AF5

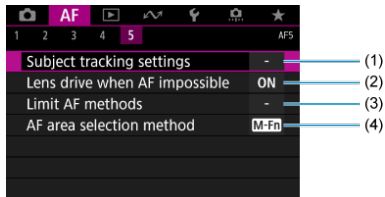

- (1) [Subject tracking settings](#)
- (2) [Lens drive when AF impossible](#)
- (3) [Limit AF methods](#)
- (4) [AF area selection method](#)

AF Operation

- [One-Shot AF for Still Subjects](#)
- [AI Servo AF/Servo AF for Moving Subjects](#)
- [AF Status Indicator \(Viewfinder Shooting\)](#)

You can select the AF operation characteristics to suit the shooting conditions or subject.

1. Set the lens's focus mode switch to <AF>.

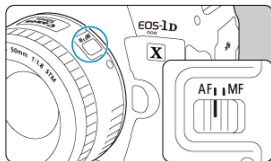

2. Press the <DRIVE•AF> button (6).

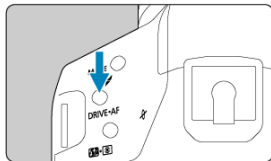

3. Select the AF operation.

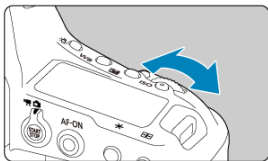

- While looking at the top LCD panel or viewfinder, turn the <  > dial.

ONE SHOT: One-Shot AF

AI SERVO: AI Servo AF



- In Live View shooting, turn the <  > dial.

ONE SHOT: One-Shot AF

SERVO: Servo AF

Note

- AF is also possible by pressing the < **AF-ON** > button.
- In Live View shooting, AF operation can also be selected from [**AF**: AF operation].

One-Shot AF for Still Subjects

This AF operation is suited for still subjects. When you press the shutter button halfway, the camera will focus only once.

● **Viewfinder shooting**

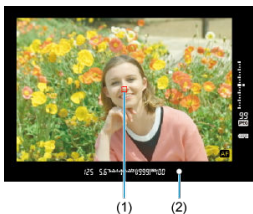

- Once a subject is in focus, the focusing AF point (1) flashes in red, the focus indicator (2) < ● > in the viewfinder lights up, and the camera beeps. The focus indicator < ● > blinks if the camera cannot focus.

● **Live View shooting**

- Once a subject is in focus, the focusing AF point turns green and the camera beeps. If focus is not achieved, the AF point will turn orange.



Note

- If [**Beep**] is set to [**Disable**], the beeper will not sound when focus is achieved.
- The focus remains locked while you hold down the shutter button halfway, allowing you to recompose the image before taking the picture. This is called "focus lock."
- See [Lens electronic MF](#) when using a lens that supports electronic manual focusing.

AI Servo AF/Servo AF for Moving Subjects

This AF operation is suited for moving subjects. While you hold down the shutter button halfway, the camera will keep focusing on the subject continuously.

● Viewfinder shooting (AI Servo)

- Once a subject is in focus, the focusing AF point is displayed. The focus indicator < ● > in the viewfinder does not light up when subjects are in focus.
- The beeper will not sound even when focus is achieved.
- The exposure is set at the moment the picture is taken.

● Live View shooting (Servo AF)

- Once a subject is in focus, the focusing AF point turns blue.
- The beeper will not sound even when focus is achieved.
- The exposure is set at the moment the picture is taken.

⚠ Caution

- Depending on the lens used, the distance to the subject and the subject's speed, the camera may not be able to achieve correct focus.
- Zooming during continuous shooting may throw off the focus. Zoom first, then recompose and shoot.

AF Status Indicator (Viewfinder Shooting)



< **AF** > appears in the lower right of the viewfinder's field of view as the camera continues autofocusing while you press the shutter button halfway.

In One-Shot AF mode, the icon also appears while you press the shutter button halfway after the camera has focused on a subject.



Note

- You can change the display position of the AF status indicator to outside the viewfinder's field of view (📷).

Selecting the AF Area and AF Point (Viewfinder Shooting)

- [AF Area Selection Mode](#)
- [Selecting the AF Area Selection Mode](#)
- [Selecting the AF Point or Zone Manually](#)
- [Meaning of Lit or Blinking AF Points](#)
- [Registering AF Points](#)

The number of available AF points, the focusing patterns, and the Area AF frame shape vary by lens. For details, refer to [Compatible Lenses and Autofocusing \(Viewfinder Shooting\)](#).

AF Area Selection Mode

Seven AF area selection modes are available. For instructions on choosing a mode, see [Selecting the AF Area Selection Mode](#).

Spot AF (manual selection)

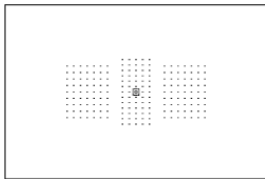

For pinpoint focusing.

1-point AF (manual selection)

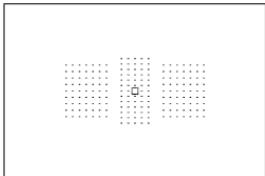

Select one AF point for focusing.

AF point expansion (manual selection \square)

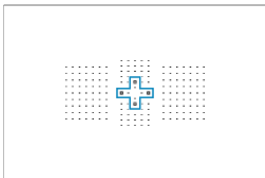

Focuses using your manually selected AF point \square and AF points outlined here in blue.

AF point expansion (manual selection: surround)

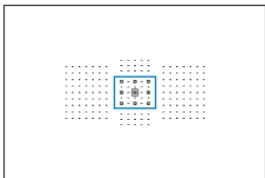

Focuses using your manually selected AF point \square and AF points outlined here in blue.

Zone AF (manual selection of zone)

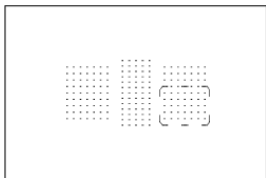

The AF area is divided into nine focusing zones for focusing.

Large Zone AF (manual selection of zone)

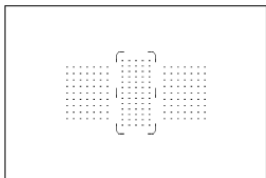

The AF area is divided into three focusing zones (left, center, and right) for focusing.

Automatic selection AF

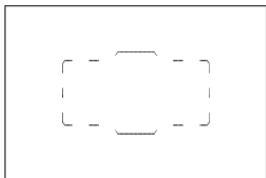

The Area AF frame (entire AF area) is used to focus.

Selecting the AF Area Selection Mode

1. Press the **< AF-ON >** button (ⓘ6).

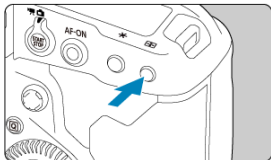

2. Press the **< M-Fn >** button.

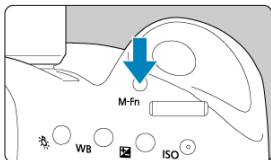

- Look through the viewfinder and press the **< M-Fn >** button.
- Each time you press the **< M-Fn >** button, the AF area selection mode changes.

Note

- With [**AF: Select AF area selec. mode**], you can limit the selectable AF area selection modes to only those you want to use (ⓘ6).
- If you set [**AF: AF area selection method**] to [**AF-ON → Main Dial**], you can select the AF area selection mode by pressing the **< AF-ON >** button, then turning the **< Main Dial >** dial (ⓘ6).

Selecting the AF Point or Zone Manually



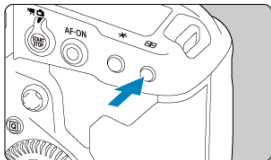

1. Press the button (Ⓞ6).



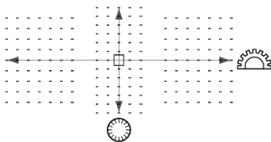
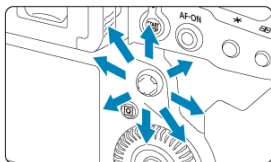

- AF points are displayed in the viewfinder.
- With AF area expansion, surrounding AF points are also displayed.
- With Zone AF or Large Zone AF, your selected zone is displayed.

2. Select an AF point or zone.



- Tilt  toward an AF point to select it. To select the center AF point or zone, press  straight in.
- You can also select an AF point by dragging on the smart controller.
- To select AF points horizontally and vertically, you can also turn the  dial and  dial, respectively.
- Turning the  dial switches zones (or cycles through Zone AF zones) in Zone AF and Large Zone AF modes.

 **Note**

- Using these selection methods, you can manually select the initial AI Servo AF position when **[AF: Initial Servo AF pt, ()/AF]** is set to **[Initial AF pt set for ()/AF]** ().
- Pressing the <  > button displays following information on the top LCD panel.
 - Zone AF, Large Zone AF, and Automatic selection AF: **[]AF**
 - Spot AF, 1-point AF, AF point expansion: **SEL [] (Center)/SEL AF (Off center)**

Meaning of Lit or Blinking AF Points

Pressing the <  > button lights up the AF points that are cross-type AF points for high-precision autofocusing. The blinking AF points are horizontal-line or vertical-line sensitive.

Registering AF Points

You can register the position of a frequently used AF point. For instant switching from the current AF point to your registered AF point, you can use a button you assign on advanced setting screens for **[Metering and AF start]**, **[Switch to registered AF point]**, **[Direct AF point selection]**, or **[Register/recall shooting func]**, in **[M6: Custom Controls]** (🔗). For instructions on registering AF points, see [Custom Controls](#).



AF Area Selection Modes (Viewfinder Shooting)

- [Spot AF \(Manual Selection\)](#)
- [1-Point AF \(Manual Selection\)](#)
- [AF Point Expansion \(Manual Selection\)](#)
- [AF Point Expansion \(Manual Selection: Surround\)](#)
- [Zone AF \(Manual Selection of Zone\)](#)
- [Large Zone AF \(Manual Selection of Zone\)](#)
- [Automatic Selection AF](#)
- [Shooting Conditions That Make Focusing Difficult](#)

Caution

- The camera continues to switch the active AF point  to track subjects when Automatic selection AF, Large Zone AF, or Zone AF is set to AI Servo AF, but tracking may not be possible under some shooting conditions, such as when subjects are small.
- Focusing with the AF-assist beam of a Speedlite may be difficult when using Spot AF.
- Focusing with the AF-assist beam of a Speedlite may be difficult when using a peripheral AF point or a wide-angle or telephoto lens. In such a case, use the center AF point or an AF point close to the center.
- Wearing polarized sunglasses or similar eyewear may make it difficult to see AF points in the viewfinder.

Note

- With [**AF: Orientation linked AF point**], you can set the AF area selection mode + AF point or only the AF point separately for the horizontal and vertical orientations ().
- With [**AF: Selectable AF point**], you can change the number of AF points available for manual selection (.

Spot AF (Manual Selection)

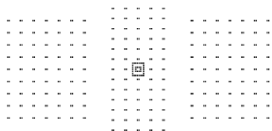

The camera focuses in a narrower area than 1-point AF. Select one AF point <  > for focusing.

Effective for pinpoint focusing or focusing on overlapping subjects such as an animal in a cage.

Note that the small Spot AF area may make focusing difficult in handheld shooting or for moving subjects.

1-Point AF (Manual Selection)

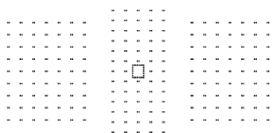

Select one AF point <  > for focusing.

AF Point Expansion (Manual Selection)

Focuses using your manually selected AF point < [] > and surrounding AF points. Effective for moving subjects, which are difficult to track with 1-point AF.

Although with AI Servo AF, the camera must be able to focus on your initially selected AF point < [] >, this mode makes it easier to focus on targeted subjects than with Zone AF.

With One-Shot AF, after the camera focuses with expanded AF points, those AF points < [] > are displayed with your manually selected AF point < [] >.

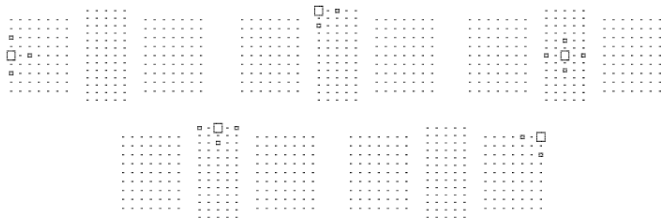



AF Point Expansion (Manual Selection: Surround)

Focuses using your manually selected AF point <□> and surrounding AF points. Enables focusing over a wider area than AF point expansion (manual selection □□□). Effective for moving subjects, which are difficult to track with 1-point AF.

AI Servo AF and One-Shot AF operation is the same as in AF point expansion (manual selection □□□) (☑).

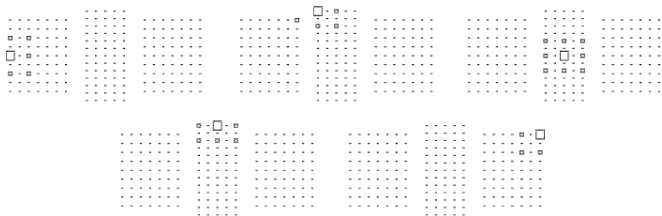

☐ Zone AF (Manual Selection of Zone)

The AF area is divided into nine focusing zones for focusing. All AF points in your selected zone are used for automatic selection AF, which makes focusing easier than with 1-point AF or AF point expansion and effective for moving subjects.

Focusing areas are determined not only based on the nearest subject but also based on a variety of other conditions such as faces, subject motion, or subject distance. Note that faces of any people in the Zone AF frame are given priority in focusing.

AF points in focus are displayed with <☐>.

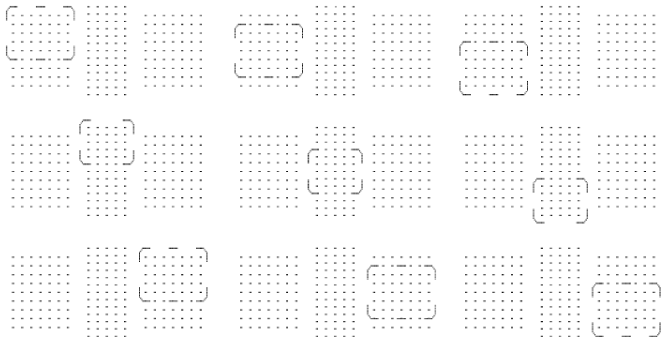

Large Zone AF (Manual Selection of Zone)

The AF area is divided into three focusing zones (left, center, and right) for focusing. Covers a larger area than Zone AF, using all AF points in your selected zone for automatic selection AF, which makes focusing easier than with 1-point AF or AF point expansion and effective for moving subjects.

Focusing areas are determined not only based on the nearest subject but also based on a variety of other conditions such as faces, subject motion, or subject distance. Note that faces of any people in the Zone AF frame are given priority in focusing.

AF points in focus are displayed with <  >.

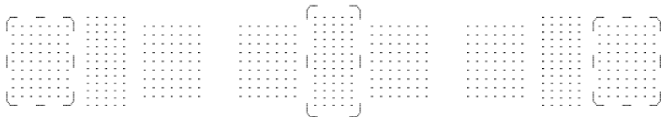



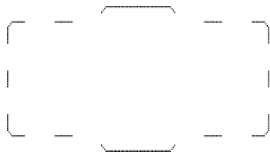

Automatic Selection AF

The Area AF frame (entire AF area) is used to focus. AF points in focus are displayed with .

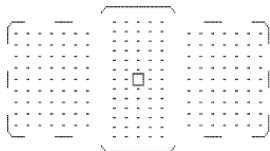

With One-Shot AF, pressing the shutter button halfway displays the AF points  that are focusing on the subject. Display of multiple AF points indicates that each point is in focus. Focusing areas are determined not only based on the nearest subject but also based on a variety of other conditions such as faces and subject distance.



With AI Servo AF, you can set the initial position for AI Servo AF in **[AF: Initial Servo AF pt.]** (, , ). As long as the Area AF frame can track the subject during shooting, focusing will continue. Focusing areas are determined not only based on the nearest subject but also based on a variety of other conditions such as faces, subject motion, or subject distance.

Shooting Conditions That Make Focusing Difficult

- Subjects with very low contrast.
(Example: Blue skies, solid-color flat surfaces, etc.)
- Subjects in very low light.
- Strongly backlit or reflective subjects.
(Example: Cars with highly reflective surfaces, etc.)
- Near and distant subjects positioned close to an AF point.
(Example: Animals in cages, etc.)
- Light source such as dots of light positioned close to an AF point.
(Example: Night scenes, etc.)
- Subjects with repetitive patterns.
(Example: Skyscraper windows, computer keyboards, etc.)
- Subjects with finer patterns than an AF point.
(Example: Faces or flowers as small as or smaller than an AF point, etc.)

In such cases, focus in either of the following two ways.

1. With One-Shot AF, focus on an object at the same distance as the subject and lock the focus, then recompose the shot (📷).
2. Set the lens's focus mode switch to <MF> and focus manually (📷).

Note

- Depending on the subject, focus may be achieved by slightly recomposing the shot and performing AF operation again.

Selecting the AF Method (Live View Shooting)

- [AF Method](#)
- [Selecting the AF Method](#)
- [!\[\]\(a22ba4e13c745edbf29e51af246c4c12_img.jpg\) \(Face\)+Tracking: !\[\]\(33b18af9a4b997eb52666cfeb3c44157_img.jpg\) !\[\]\(262b158440b847a82f89a14cab8644ec_img.jpg\) !\[\]\(f51929fecf7b0dc947ac13f4c4835e8f_img.jpg\)](#)
- [Spot AF / 1-Point AF / AF Point Expansion \(!\[\]\(dfbf0e54bcca114319aa65c906feb8d0_img.jpg\)\) / AF Point Expansion: Around / Zone AF / Large Zone AF: Vertical / Large Zone AF: Horizontal](#)
- [Magnified View](#)
- [AF Shooting Tips](#)
- [Shooting Conditions That Make Focusing Difficult](#)
- [AF Range](#)

AF Method

: **Face+Tracking**

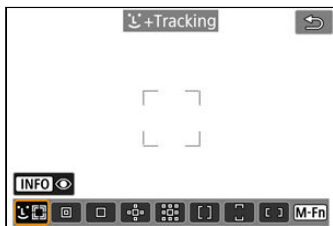

The camera detects and focuses on people's faces. An AF point  appears over any face detected, which is then tracked.

When no face is detected, focusing areas are determined not only based on the nearest subject but also based on a variety of other conditions such as subject motion and distance. With Servo AF, you can set the initial position for Servo AF (). As long as the Area AF frame can track the subject during shooting, focusing will continue.

Spot AF

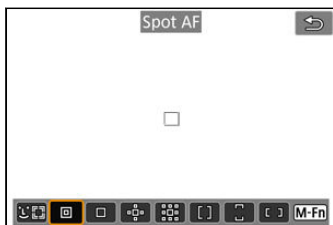

The camera focuses in a narrower area than 1-point AF.
Effective for pinpoint focusing or focusing on overlapping subjects such as an animal in a cage.

Note that the small Spot AF area may make focusing difficult in handheld shooting or for moving subjects.

1-point AF

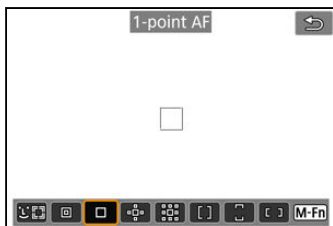

The camera focuses using a single AF point <  >.

Expand AF area:

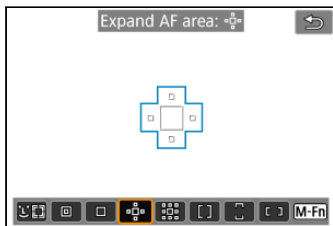





Focuses using one AF point <  > and AF points outlined here in blue. Effective for moving subjects, which are difficult to track with 1-point AF.

Focusing on your preferred subject is easier than with Zone AF.

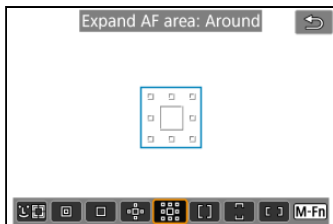
When Servo AF is used, first you will focus using an AF point <  >.

Expand AF area: Around



Focuses using one AF point <  > and surrounding AF points outlined here in blue, which makes it easier to focus on moving subjects than with AF point expansion (). Servo AF operation is the same as for AF point expansion ().

[]: Zone AF

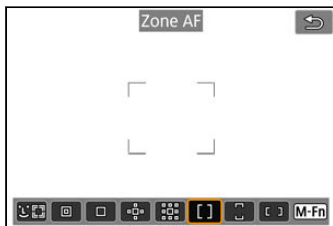

Uses auto selection AF in Zone AF frames to cover a larger area than AF point expansion, which makes focusing easier than with AF point expansion.

Focusing areas are determined not only based on the nearest subject but also based on a variety of other conditions such as faces, subject motion, or subject distance.

AF points in focus are displayed with < □ >.

[]: Large Zone AF: Vertical

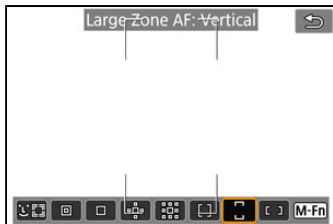

Uses auto selection AF in a vertical Large Zone AF frame to cover a larger area than Zone AF, which makes focusing easier than with 1-point AF/AF point expansion and also effective for moving subjects.

Focusing areas are determined not only based on the nearest subject but also based on a variety of other conditions such as faces, subject motion, or subject distance.

AF points in focus are displayed with < □ >.

Large Zone AF: Horizontal

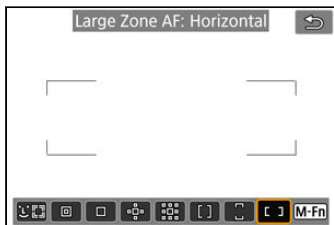

Uses auto selection AF in a horizontal Large Zone AF frame to cover a larger area than Zone AF, which makes focusing easier than with 1-point AF/AF point expansion and also effective for moving subjects.

Focusing areas are determined not only based on the nearest subject but also based on a variety of other conditions such as faces, subject motion, or subject distance.

AF points in focus are displayed with <  >.

Selecting the AF Method

1. Press the **< AF-ON >** button.

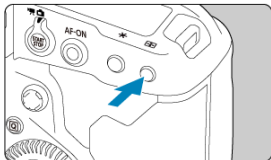

2. Select the AF method.

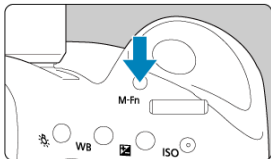

- Each time you press the **<M-Fn>** button, the AF method changes.



Note

- You can also make your selection from **[AF: AF method]**.
- The following descriptions apply to the camera with AF operation set to **[One-Shot AF]** (📷). With **[Servo AF]** (📷) set, the AF point will turn blue when focus is achieved.

The camera detects and focuses on people's faces. If a face moves, the AF point < [] > also moves to track the face.

You can set [**AF: Eye Detection AF**] to [**Enable**] to shoot with the subject's eyes in focus (☑).

1. Check the AF point.



- An AF point < [] > appears over any face detected.
- If < [] > is displayed, you can use < ☺ > to choose a face to focus on.
- Press < ☺ > to move the AF point to the center of the screen.

2. Focus and take the picture.

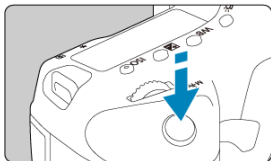

- Once you press the shutter button halfway and the subject is in focus, the AF point turns green and the camera beeps. An orange Area AF frame indicates that the camera could not focus on subjects.

AF point display

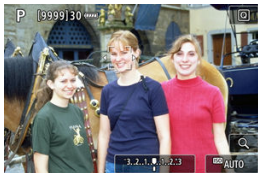

After automatic face detection by the camera
(single frame)



After manual face selection
(double frame)

Note

- Selecting a face manually by tapping the screen or using $\langle \text{AF-ON} \rangle$ locks onto that subject for tracking, and the camera tracks the subject even if it moves within the screen. To release locked tracking, tap $[\text{AF OFF}]$.

Caution

- Tapping the screen to focus will focus with **[One-Shot AF]**, regardless of the AF operation setting.
- If the subject's face is significantly out of focus, face detection will not be possible. Adjust the focus manually (AF-ON) so that the face can be detected, then perform AF.
- An object other than a human face may be detected as a face.
- Face detection will not work if the face is very small or large in the picture, too bright or too dark, or partially hidden.
- AF may not detect subjects or people's faces at the edges of the screen. Recompose the shot to center the subject or bring the subject closer to the center.
- The camera will keep moving the active AF point to track subjects when Servo AF is set, but under some shooting conditions (such as when subjects are small), it may not be possible to track the subject.



Note

- The active <math>[\]> may cover only a part of the face, not the whole face.
- The size of the AF point changes depending on the subject.

Eye Detection AF

With the AF method set to [+Tracking], you can shoot with the subject's eyes in focus.

1. Select [: Eye Detection AF].

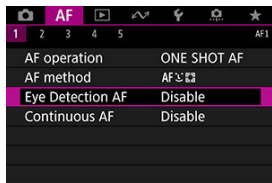

2. Select [Enable].

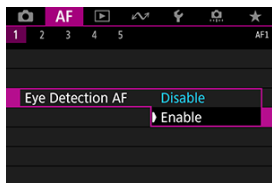

3. Aim the camera at the subject.



- An AF point is displayed around their eye.
- You can tap the screen to select an eye for focus. Note that if your selected eye is not detected, an eye to focus on is selected automatically.
- When multiple eyes are detected, you can use < > to select an eye for focus.

4. Take the picture.

Caution

- Subject eyes may not be detected correctly, depending on the subject and shooting conditions.

Note

- To switch to **[Eye Detection AF: Disable]** without using menu operations, press the <  > button and then the < **INFO** > button. To switch to **[Eye Detection AF: Enable]**, press the < **INFO** > button again.

Setting the initial Servo AF position

You can manually set the initial Servo AF position when [AF: Initial Servo AF pt, ()] is set to [Initial AF pt set for ()] ().

1. Set the AF method to [L+Tracking] ().
2. Set AF operation to [Servo AF] ().
3. Set the AF point.



(1)

- To move the AF point (1), use < [] > or tap the screen.
- To return the AF point to the center of the screen, press < [] > or the < [SET] > or < [] > button.

Spot AF / 1-Point AF / AF Point Expansion ($\text{e}\frac{\text{O}}{\text{O}}$) / AF Point Expansion: Around / Zone AF / Large Zone AF: Vertical / Large Zone AF: Horizontal

You can manually set the AF point or Zone AF frame. Here, 1-point AF screens are used as an example.

1. Check the AF point.



(1)

- The AF point (1) will appear.
- With AF point expansion ($\text{e}\frac{\text{O}}{\text{O}}$) or AF point expansion: Around, adjacent AF points are also displayed.
- With Zone AF, Large Zone AF: Vertical, or Large Zone AF: Horizontal, the specified Zone AF frame is displayed.

2. Move the AF point.



- Use $\leftarrow \rightarrow$ to move the AF point into position for focusing (but note that with some lenses, it may not move to the edge of the screen).
- You can also focus by tapping a position on the screen.
- To center the AF point or Zone AF frame, press $\leftarrow \rightarrow$ or the $\langle \text{SET} \rangle$ or $\langle \text{MENU} \rangle$ button.

3. Focus and take the picture.

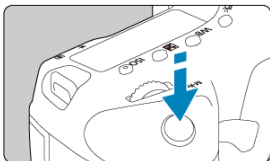



- Aim the AF point over the subject and press the shutter button halfway.
- When focus is achieved, the AF point will turn green and the beeper will sound.
- If the camera cannot focus, the AF point or Zone AF frame turns orange.

⚠ Caution

- The camera continues to switch the active AF point <  > to track subjects when Zone AF or Large Zone AF (vertical or horizontal) is set to Servo AF, but tracking may not be possible under some shooting conditions, such as when subjects are small.
- Focusing may be difficult when using a peripheral AF point. In this case, select an AF point in the center.
- Tapping the screen to focus will focus with [One-Shot AF], regardless of the AF operation setting.

📄 Note

- With [: Orientation linked AF point], you can set separate AF points for vertical and horizontal shooting ().

Magnified View

To check the focus when the AF method is other than [**L**+Tracking], magnify display by approx. 5× or 10× by pressing the <Q> button (or tapping <Q>).

- Magnification is centered on the AF point for [**Spot AF**], [**1-point AF**], [**Expand AF area: $\frac{1}{4}$**], and [**Expand AF area: Around**] and on the Zone AF frame for [**Zone AF**], [**Large Zone AF: Vertical**], and [**Large Zone AF: Horizontal**].
- Autofocusing is performed with magnified display if you press the shutter button halfway when set to [**Spot AF**], and [**1-point AF**]. When set to AF methods other than [**Spot AF**] and [**1-point AF**], autofocusing is performed after restoring normal display.
- With Servo AF, if you press the shutter button halfway in the magnified view, the camera will return to the normal view for focusing.

Caution

- If focusing is difficult in the magnified view, return to the normal view and perform AF.
- If you perform AF in the normal view and then use the magnified view, accurate focus may not be achieved.
- AF speed differs between the normal view and magnified view.
- Continuous AF and Movie Servo AF are not available when display is magnified.
- With the magnified view, achieving focus becomes more difficult due to camera shake. Using a tripod is recommended.

AF Shooting Tips

- Even when focus is achieved, pressing the shutter button halfway will focus again.
- Image brightness may change during autofocusing.
- Depending on the subject and shooting conditions, it may take longer to focus, or the continuous shooting speed may decrease.
- If the light source changes as you shoot, the screen may flicker, and focusing may be difficult. In this case, restart the camera and resume shooting with AF under the light source you will use.
- If focusing is not possible with AF, focus manually (☑).
- For subjects at the edge of the screen that are slightly out of focus, try centering the subject (or AF point, or Zone AF frame) to bring them into focus, then recompose the shot before shooting.
- With certain lenses, it may take more time to achieve focus with autofocus, or accurate focusing may not be achieved.

Shooting Conditions That Make Focusing Difficult

- Subject with low-contrast such as the blue sky, solid-color flat surfaces or when highlight or shadow details are clipped.
- Subjects in low light.
- Stripes and other patterns where there is contrast only in the horizontal direction.
- Subjects with repetitive patterns (Example: Skyscraper windows, computer keyboards, etc.).
- Fine lines and subject outlines.
- Under light sources with constantly changing brightness, colors, or patterns.
- Night scenes or points of light.
- The image flickers under fluorescent or LED lighting.
- Extremely small subjects.
- Subjects at the edge of the screen.
- Strongly backlit or reflective subjects (Example: Car with a highly reflective surfaces, etc.).
- Near and distant subjects covered by an AF point (Example: Animal in a cage, etc.).
- Subjects that keep moving within the AF point and will not stay still due to camera shake or subject blur.
- Performing AF when the subject is very far out of focus.
- Soft focus effect is applied with a soft focus lens.
- A special effect filter is used.
- Noise (dots of light, banding, etc.) appears on the screen during AF.

AF Range

The available autofocus range varies depending on the lens used and settings such as recording size and Movie digital IS.

AI Servo AF/Servo AF Characteristics

- [Case Details](#)
- [Case 1: Versatile Multi-Purpose Setting](#)
- [Case 2: Continue to Track Subjects, Ignoring Possible Obstacles](#)
- [Case 3: Instantly Focus on Subjects Suddenly Entering AF Points](#)
- [Case 4: For Subjects That Accelerate or Decelerate Quickly](#)
- [Case A: Tracking Automatically Adapts to Subject Movement](#)
- [Parameters](#)
- [Adjusting Case Parameters](#)



Shooting with AI Servo AF/Servo AF can be easily tailored to your subjects or shooting situations by selecting a Case option. This feature is called the “AF Configuration Tool.”

1. Select the [AF1] tab.







- In Live View shooting, select the [AF3] tab.

2. Select a case.

- Turn the <  > dial to select a case icon, then press <  >.
- Your selected case is now set. Selected cases are displayed in blue.

Case Details

Cases 1 to A are five combinations of settings for "[Tracking sensitivity](#)" and "[Accel./decel. tracking](#)." Referring to the following table, select the case for your subject and shooting situation.

Case	Icon	Description	Examples of Shooting Situations
Case 1		Versatile multi purpose setting	Moving subjects in general
Case 2		Continue to track subjects, ignoring possible obstacles	Tennis, freestyle skiing
Case 3		Instantly focus on subjects suddenly entering AF points	Start of a cycling race, downhill skiing
Case 4		For subjects that accelerate or decelerate quickly	Soccer, rhythmic gymnastics, motorsports, basketball
Case A		Tracking automatically adapts to subject movement	Moving subjects in general, especially in dynamic shooting situations

Case 1: Versatile Multi-Purpose Setting

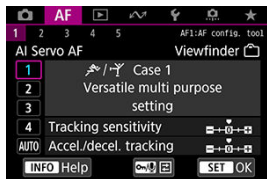

Default

- Tracking sensitivity: 0
- Accel./decel. tracking: 0

Standard setting suited to moving subjects in general. Suitable for many kinds of subjects and scenes.

In the following situations, select [Case 2] to [Case 4] instead: non-subjects moving across AF points, elusive subjects, or subjects that suddenly appear or change speed.

Case 2: Continue to Track Subjects, Ignoring Possible Obstacles

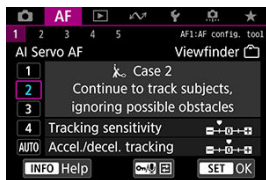

Default

- **Tracking sensitivity: Locked on:** -1
- **Accel./decel. tracking:** 0

Setting to continue focusing on the subject even if non-subjects move across AF points, or if the subject strays from AF points. Effective if you prefer the focus not to switch to non-subjects or the background.

Note

- Try setting [**Tracking sensitivity**] to [-2] if non-subjects tend to steal the focus or AF points tend to stray from the subject much of the time, preventing the camera from tracking the target subject under default settings (🔗).

Case 3: Instantly Focus on Subjects Suddenly Entering AF Points

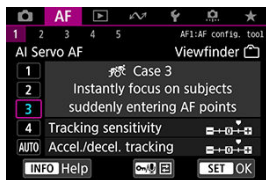

Default

- **Tracking sensitivity: Responsive: +1**
- **Accel./decel. tracking: +1**

Setting to focus on a series of subjects at different distances in the AF points, one after another. Focus switches to any new subject that appears in front of the target subject. Also effective when you want to always focus on the closest subject.

Note

- Try setting [**Tracking sensitivity**] to [**+2**] if you prefer focusing that immediately switches to new subjects that appear suddenly (👉).

Case 4: For Subjects That Accelerate or Decelerate Quickly

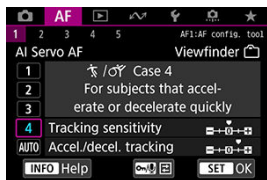

Default

- Tracking sensitivity: Responsive: 0
- Accel./decel. tracking: +1

Setting to keep tracking and focusing on subjects even if they suddenly change speed. Effective for subjects having sudden movements, sudden acceleration/deceleration, or sudden stops.

Note

- Try setting [**Accel./decel. tracking**] to [**+2**] to keep up with subjects that change speed significantly from moment to moment (🔗).

Case A: Tracking Automatically Adapts to Subject Movement

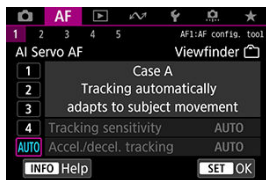

Useful when you prefer to shoot with parameters set automatically, based on how subjects change.

Tracking sensitivity and acceleration/deceleration tracking are set automatically.

Tracking sensitivity

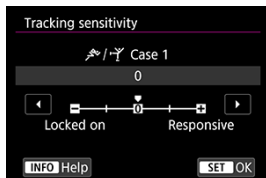

Setting for AI Servo AF/Servo AF subject-tracking sensitivity in response to non-subjects moving across AF points or subjects straying from AF points.

- **0**
Standard setting. Suitable for moving subjects in general.
- **Locked on: -2 / Locked on: -1**
The camera will try to continue focusing on the subject even if non-subjects move across AF points or if the subject strays from the AF points. The -2 setting makes the camera keep tracking the target subject longer than the -1 setting. However, if the camera focuses on a wrong subject, it may take slightly longer to switch and focus on the target subject.
- **Responsive: +2 / Responsive: +1**
The camera can focus consecutively on subjects at different distances that are covered by the AF points. Also effective when you want to always focus on the closest subject. The +2 setting is more responsive than the +1 setting when focusing on the next subject. However, the camera will be more prone to focus on an unintended subject.

Accel./decel. tracking

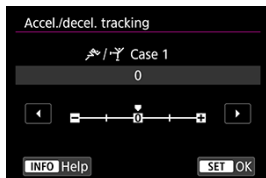

Setting for AI Servo AF/Servo AF subject-tracking sensitivity in response to sudden, significant changes in speed, as when subjects suddenly start or stop moving.

- **0**
Suited for subjects that move at a steady speed (minor changes in moving speed).
- **-2 / -1**
Suited for subjects that move at a steady speed (minor changes in moving speed). Effective when a setting of 0 makes focus unstable, due to slight subject movement or an obstruction in front of the subject.
- **+2 / +1**
Effective for subjects having sudden movements, sudden acceleration/deceleration, or sudden stops. Even if the moving subject's speed suddenly changes significantly, the camera continues to focus on the target subject. For example, the camera is less likely to focus behind a subject that suddenly starts approaching you, or in front of an approaching subject that suddenly stops moving. Setting +2 can track dramatic changes in the moving subject's speed better than with +1.
However, since the camera will be sensitive to even slight movements of the subject, focusing may become unstable for short periods.

Adjusting Case Parameters

You can manually adjust the parameters ((1) Tracking sensitivity and (2) Acceleration/ deceleration tracking) for cases 1 to 4.

1. Select a case.



- Turn the <  > dial to select the number of a case to adjust.

2. Press the < / > button.

- The selected parameter is outlined in purple.

3. Select a parameter to adjust.

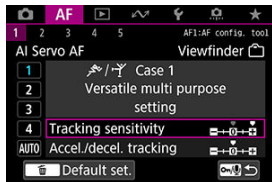

4. Make the adjustment.

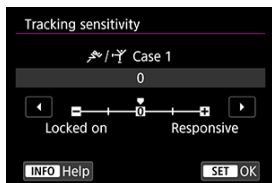

- Default settings are indicated by a light gray [] icon.
- To confirm the adjustment, press < SET >.
- To return to the screen in step 1, press the < On / > button.

Note

- To restore default parameter settings for (1) and (2) to each case, press the < On / > button in step 2, then press the < > button.
- You can also register (1) and (2) parameter settings to My Menu (). This enables you to adjust settings for the selected case.
- To shoot with a case you have adjusted, first select the adjusted case, then shoot.

Customizing AF Functions

[Viewfinder Shooting](#)

[Other Menu Functions](#)

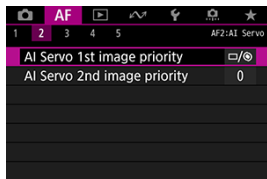

You can configure AF functions in detail to suit your shooting style or subject.

[AF2]

AI Servo 1st image priority

You can set the AF operation characteristics and shutter-release timing for the first shot with AI Servo AF.

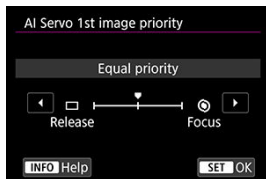

- **[□/⊙] Equal priority**
Equal priority is given to focusing and shutter-release timing.
- **[□] Release**
Pressing the shutter button takes the picture immediately even if focus has not been achieved. Useful when you want to give priority to capturing the decisive moment rather than achieving focus.
- **[⊙] Focus**
Pressing the shutter button does not take the picture until focus is achieved. Useful when you want to achieve focus before taking the picture.

AI Servo 2nd image priority

With AI Servo AF for continuous shooting, you can preset the AF operation characteristics and shutter-release timing for the subsequent shots after the first shot in continuous shooting.

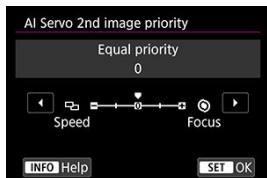

- **[0] Equal priority**

Equal priority is given to focusing and continuous shooting speed. In low light or with low-contrast subjects, continuous shooting speed may slow down.

- **[-2]/[-1] Shooting speed priority** 

Priority is given to the continuous shooting speed instead of achieving focus. -2 maintains fast continuous shooting better than -1.

- **[+2]/[+1] Focus** 

Priority is given to achieving focus instead of the continuous shooting speed. The picture will not be taken until focus is achieved. +2 enables easier focusing than +1 in low-light conditions, but continuous shooting may be slower under these conditions.

Caution

- Even if [-1] or [-2] is set, shooting conditions that activate flicker reduction  may cause slower continuous shooting or an inconsistent interval between shots.

Note

- If the camera cannot focus in low-light conditions when set to **[0: Equal priority]**, try setting to **[+1]** or **[+2]**.

[AF3]

Electronic full-time MF

Operation of manual focus adjustment using the electronic focusing ring when certain lenses are attached is customizable. Check the Canon website for compatible lenses.



- **Disable**
Operation of manual focus adjustment corresponds to the **[Lens electronic MF]** setting.
- **Enable**
Manual focus adjustment is available whenever camera operations are possible (full-time manual focus).

Lens electronic MF

For EF lenses equipped with electronic manual focusing, you can specify how manual focus adjustment is used with One-Shot AF.

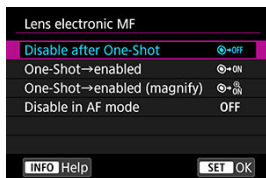

- **[CAMERA] OFF] Disable after One-Shot**
After the AF operation, manual focusing adjustment is disabled.
- **[CAMERA] ON] One-Shot→enabled**
You can manually adjust the focus after the AF operation if you keep holding down the shutter button halfway.

- **[ ON] One-Shot→enabled (magnify)**

You can manually adjust the focus after the AF operation if you keep holding down the shutter button halfway. You can magnify the area in focus and adjust the focus manually by turning the lens focusing ring in Live View shooting.

- **[OFF] Disable in AF mode**

Manual focus adjustment is disabled when the lens's focus mode switch is set to < AF >.

 **Caution**

- With [**One-Shot→enabled (magnify)**], display may not be magnified even if you turn the lens focusing ring while pressing the shutter button halfway immediately after shooting. If so, you can magnify display by releasing the shutter button, waiting for < Q > display, then pressing the shutter button halfway as you turn the lens focusing ring.

 **Note**

- For details on your lens's manual focus specifications, refer to the Lens Instruction Manual.

AF-assist beam firing

You can enable or disable the AF-assist beam of a Speedlite for EOS cameras.

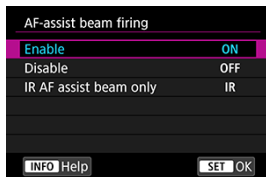

- **[ON] Enable**
Enables firing of the AF-assist beam, when needed.
- **[OFF] Disable**
Disables firing of the AF-assist beam. Set if you prefer not to fire the AF-assist beam.
- **[IR] IR AF assist beam only**
Enables infrared AF-assist beam firing by external Speedlites equipped with this feature, when these flash units are attached.

Caution

- If a Speedlite's **[AF-assist beam firing]** Custom Function is set to **[Disable]**, the AF-assist beam will not be emitted.

One-Shot AF release prior.

You can set the AF operation characteristics and shutter-release timing for One-Shot AF.

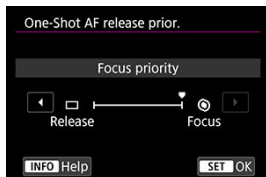

- **[◎] Focus**

The picture will not be taken until focus is achieved. Useful when you want to achieve focus before capturing the image.

- **[□] Release**

Prioritizes shutter release over focus. Useful when capturing the decisive moment is most important.

Note that the camera shoots whether or not the subject is in focus.

[AF4]

Subject tracking settings

You can specify conditions for automatic selection of the main subject to track, as well as ease of AF point switching to track other subjects.

Applies to Zone AF/Large Zone AF/Auto selection AF area selection modes in viewfinder shooting, and to +Tracking/Zone AF/Large Zone AF (vertical or horizontal) AF methods in Live View shooting.

- **AF priority (People)**

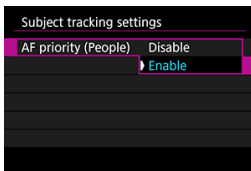

- **Disable**

Main subjects to track are determined based on subject information.

- **Enable**

Prioritizes people's faces or heads as the main subjects to track, which are determined based on subject information.

When a person's face or head is not detected, the camera may track other body parts.

● Subject switching

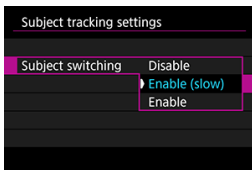

• **Disable**

Tracks the subject initially determined for AF, to the extent possible.

• **Enable (slow)**

Generally tracks the subject initially determined for AF. May switch to other subjects if the current subject is no longer suitable for AF.

• **Enable**

Switches to track other subjects in response to shooting conditions.

! Caution

● **Precautions when set to [Disable]**

The camera may not be able to continue tracking subjects under some subject conditions.

- If subjects move vigorously
- If subjects face a different direction or change their posture
- If AF points stray from subjects, or if subjects are hidden behind obstructions and you can no longer see them

With **[AF priority (People)]** set to **[Enable]**, the camera may switch to the face or head, depending on subject conditions.

- Subjects selected by touch will be tracked to the extent possible regardless of the option set in **[Subject tracking settings]**.

Lens drive when AF impossible

You can specify lens operation that applies when autofocusing on a subject is not possible.

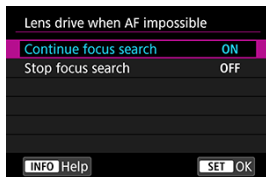

- **[ON] Continue focus search**

If focus cannot be achieved with autofocus, the lens is driven to search for the precise focus.

- **[OFF] Stop focus search**

If autofocus starts and the focus is far off or if focus cannot be achieved, the lens drive will not be performed. This prevents the lens from becoming grossly out of focus due to the focus search drive.





! Caution

- **[Stop focus search]** is recommended for super telephoto lenses or other lenses that are driven over a large focus area, to avoid significant delay from focus search drive if the lens becomes greatly out of focus.

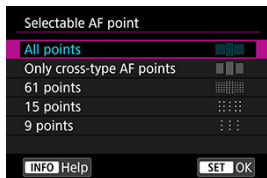
Selectable AF point

You can change the number of AF points available for manual selection. Note that regardless of the [Selectable AF point] setting, autofocus for Zone AF, Large Zone AF, or Automatic selection AF uses the corresponding AF area selection mode.





-  **All points**
All AF points are available for manual selection.
-  **Only cross-type AF points**
Only cross-type AF points are available for manual selection. The number of AF points varies depending on the lens used.
-  **61 points**
The main 61 AF points are available for manual selection.
-  **15 points**
The main 15 AF points are available for manual selection.
-  **9 points**
The main 9 AF points are available for manual selection.

Caution

- With some lenses, fewer AF points can be manually selected.

Note

- Even settings other than [All points] can be used with AF point expansion (Manual selection=) or AF point expansion (manual selection: surround), Zone AF, and Large Zone AF.
- AF points not available for manual selection are not shown in the viewfinder when you press the < > button.

Select AF area selec. mode

You can limit the selectable AF area selection modes to suit your shooting preferences.

Select the desired AF area selection mode and press < **SET** > to add a checkmark [✓]. Select [OK] to register the setting. The AF area selection modes are described on [AF Area Selection Modes \(Viewfinder Shooting\)](#).

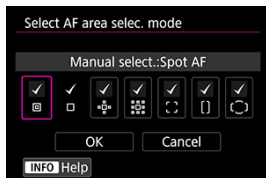

Caution

- The [✓] mark cannot be removed from [Manual selection:1 pt AF].
- Even if you add a checkmark [✓] in [Select AF area selec. mode], some AF area selection modes are not available with certain lenses.

AF area selection method

You can set the method for switching AF area/AF method selection modes.

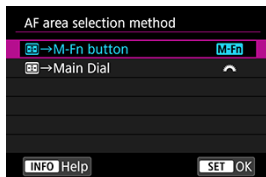

- **[M-Fn] [M-Fn] → M-Fn button**

After you press the < [M-Fn] > button, pressing the < M-Fn > button will change the AF area/AF method selection mode.

- **[Main Dial] [Main Dial] → Main Dial**

After you press the < [Main Dial] > button, turning the < Main Dial > dial will change the AF area/AF method selection mode.

Note

- When **[Main Dial] → Main Dial** is set, use < [Main Dial] > to move the AF point horizontally.

Orientation linked AF point

You can set separate AF points to use in vertical and horizontal shooting, or you can set both separate AF points and separate AF area selection modes.

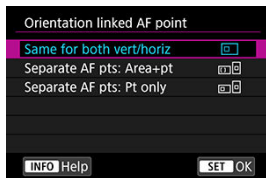

-  **Same for both vert/horiz**

The same AF area selection mode and manually selected AF point (or zone) are used in both vertical and horizontal shooting.

-  **Separate AF pts: Area+pt**

Separate AF area selection modes and AF points (or zones) can be set for each camera orientation ((1) Horizontal, (2) Vertical with the grip up, (3) Vertical with the grip down). When you manually select the AF area selection mode and AF point (or zone) for each of the three camera orientations, they will be registered for the respective orientation. Whenever you change camera orientations during shooting, the camera switches to the corresponding AF area selection mode and manually selected AF point (or zone). Note that in Live View shooting, operation is the same as for **[Separate AF pts: Pt only]**.

-  **Separate AF pts: Pt only**

Separate AF point (or zone) positions can be set for each camera orientation ((1) Horizontal, (2) Vertical with the grip up, (3) Vertical with the grip down). Useful for switching to AF points (or zones) in other positions automatically based on camera orientation.

AF points (or zones) you assign to each of the three camera orientations are retained.

Caution

- The default setting of **[Same for both vert/horiz]** is restored if, in **[Reset camera]**, you select **[Basic settings]** in **[Reset individual settings]** . Settings for orientations (1)–(3) are cleared, and the camera is set to use the center AF point in 1-point AF.
- The setting may be cleared if you switch lenses.

Initial Servo AF pt, ()/L^{AF} 3

You can set the initial AF point for AI Servo AF/Servo AF when the AF area selection mode is set to **[Auto selection AF]**, or when the AF method is set to **[L^{AF}+Tracking]**.

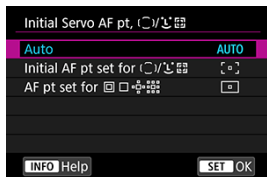

- **AUTO: Auto**

The initial AF point for AI Servo AF/Servo AF is set automatically to suit the shooting conditions.

- **[()] Initial AF pt set for ()/L^{AF} 3**

AI Servo AF/Servo AF starts from the manually selected AF point when the AF area selection mode is set to **[Auto selection AF]**, or when the AF method is set to **[L^{AF}+Tracking]**.

- **[[]] AF pt set for [] [] [] [] [] [] [] [] [] []**

AI Servo AF/Servo AF starts from the AF point that was set manually before switching from Spot AF, 1-point AF, or AF point expansion (Manual selection: **[] []**) or AF point expansion (manual selection: surround) to **[Auto selection AF]** or **[L^{AF}+Tracking]**. Useful for starting AI Servo AF/Servo AF from the AF point set before switching to **[Auto selection AF]** or **[L^{AF}+Tracking]**.

Note



- When **[AF pt set for [] [] [] [] [] [] [] [] [] []]** is set, AI Servo AF/Servo AF starts from a zone corresponding to your manually selected AF point even if you switch the AF area selection mode to Zone AF or Large Zone AF, or switch the AF method to Zone AF or Large Zone AF (vertical or horizontal).

[AF5]

AF point selection movement

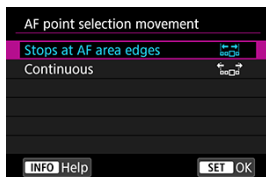
When AF points are selected, you can set whether selection stops at the outermost AF point or continues to the first AF point on the opposite side.



-  **Stops at AF area edges**
Useful if you often use the outermost AF point.
-  **Continuous**
Instead of stopping at the outer edge, the selection of AF point continues to the opposite side.

Note

- Also applies when the initial AF point for AI Servo AF is selected with **[AF: Initial Servo AF pt, ()/L^{RF}]** set to **[Initial Servo AF pt, ()/L^{RF}]**.

AF point display during focus

You can set whether AF points are displayed throughout autofocusing: when AF begins and is in progress, when subjects are in focus, and after this, while the metering timer is active.

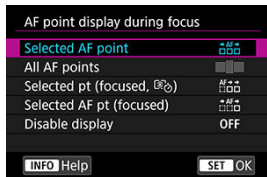

○: Displayed, ×: Not displayed

AF point display during focus	AF point selected	Before AF starts (shooting standby)	At AF start
Selected AF point	○	×	○
All AF points	○	×	○
Selected pt (focused, [AF-ON] icon)	○	×	○
Selected AF pt (focused)	○	×	○
Disable display	○	×	×

AF point display during focus	During AF	Focus achieved	After focusing, during the metering timer
Selected AF point	○	○	○
All AF points	○	○	○
Selected pt (focused, [AF-ON] icon)	×	○	○
Selected AF pt (focused)	×	○	×
Disable display	×	×	×

⚠ Caution

- Display of AF points is different for Zone AF, Large Zone AF, and Automatic selection AF, which show a Zone AF frame, Large Zone AF frame, or Area AF frame.

AF point brightness

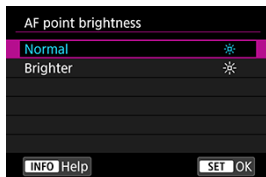

AF point brightness in the viewfinder is adjustable.

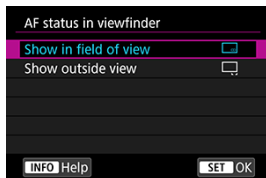

AF status in viewfinder

You can select whether to show the AF status indicator inside or outside of the viewfinder's field of view.



-  **Show in field of view**
< **AF** > is displayed in the lower right within the viewfinder's field of view.
-  **Show outside view**
<  > is displayed below the focus indicator < ● >, outside the viewfinder's field of view.

Note

- For AF status indicator details, see [AF Status Indicator \(Viewfinder Shooting\)](#).

AF Microadjustment

You can make fine adjustments for the AF's point of focus. For details, see [AF Microadjustment](#).

Live View shooting

These descriptions apply to menus only available in Live View Shooting.

[AF1]

Continuous AF

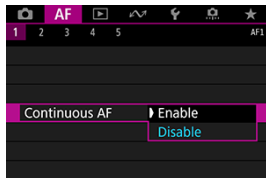

This function keeps subjects generally in focus. The camera is ready to focus immediately when you press the shutter button halfway. Note that fewer shots are available when set to [Enable], because the lens is driven continuously and battery power is consumed.

[AF5]

Limit AF methods

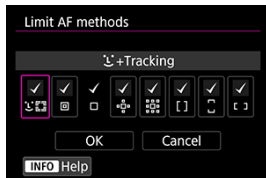

You can limit the AF methods available to those that you will use. Select AF methods and press <SET> to add a checkmark [✓] and make them available. Select [OK] to register the setting. For details on AF methods, see [Selecting the AF Method \(Live View Shooting\)](#).

⚠ Caution

- The [✓] mark cannot be removed from [1-point AF].

Movie recording

These descriptions apply to menus only available in movie recording.



[AF1]

Movie Servo AF

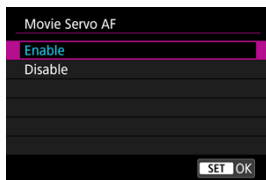
With this function enabled, the camera focuses on the subject continuously during movie recording.



● [Enable]

- The camera focuses on the subject continuously even when you are not pressing the shutter button halfway.
- To keep the focus at a specific position, or if you prefer not to record mechanical sounds from the lens, you can temporarily stop Movie Servo AF by tapping [**L_{SERVOAF}**] in the lower left of the screen.
- Movie Servo AF stops when you press the button assigned to [**Pause Movie Servo AF**] () in [**6: Custom Controls**]. Movie Servo AF resumes when you press the button again.
- Movie Servo AF stops while you hold down the button assigned to [**AF stop**] (). Movie Servo AF resumes when you release the button.
- When Movie Servo AF is paused, if you return to movie recording after operations such as pressing the < **MENU** > or <  > button or changing the AF method, Movie Servo AF will resume.

● [Disable]

Press the shutter button halfway or press the < **AF-ON** > button to focus.

 Caution

When set to [Movie Servo AF: Enable]

- **Shooting conditions that make focusing difficult**
 - A fast-moving subject approaching or moving away from the camera.
 - A subject moving at a close distance to the camera.
 - When shooting with a higher aperture value.
 - Also see [Shooting Conditions That Make Focusing Difficult](#) in the section on AF area selection modes (for viewfinder shooting).
- Since the lens is driven continuously and the battery power is consumed, the possible movie recording time (🕒) will be shortened.
- If AF operations are performed or you control the camera or lens during movie recording, the camera's built-in microphone may also record mechanical sounds of the lens or sounds of camera/lens operations. In this case, using an external microphone may reduce these sounds. If the sounds are still distracting with an external microphone, it may be more effective to remove the external microphone from the camera and position it away from the camera and lens.
- Movie Servo AF will pause during zooming or magnified view.
- During movie recording, if a subject approaches or moves away or if the camera is moved vertically or horizontally (panning), the recorded movie image may momentarily expand or contract (change in image magnification).

[AF3]

Movie Servo AF speed

You can set the Movie Servo AF's AF speed and its operation conditions. The function is enabled when using a lens supporting slow focus transition during movie recording.*

- **When active**

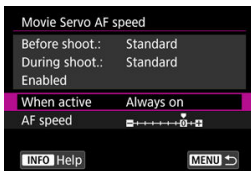

You can set [**Always on**] to have the AF speed take effect at all times for movie recording (before and during movie recording) or set [**During shooting**] to have the AF speed take effect only during movie recording.

- **AF speed**

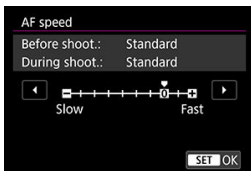

You can adjust the AF speed (focus transition speed) from the standard speed (0) to slow (one of seven levels) or fast (one of two levels) to obtain the desired effect for the movie creation.

* Lenses supporting slow focus transition during movie recording

USM and STM lenses released in and after 2009 are compatible. For details, refer to the Canon website.

! Caution

- With certain lenses, even if you adjust the AF speed, the speed may not change.

Note

- Available when **[AF: Movie Servo AF]** is set to **[Enable]** and **[AF: AF method]** is set to **[Spot AF]** or **[1-point AF]**.
- Operation when **[AF: AF method]** is set to an option other than **[Spot AF]** or **[1-point AF]** is equivalent to setting **[AF speed]** to **[Standard(0)]**.
- An asterisk "*" to the right of **[AF: Movie Servo AF speed]** indicates that the default setting has been modified.

Movie Servo AF track sens.

You can adjust the tracking sensitivity (to one of seven levels), which affects responsiveness if the subject strays from the AF point during Movie Servo AF, as when interfering objects move across AF points or when you pan.

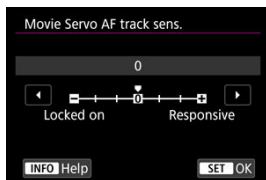

- **Locked on: -3/-2/-1**

With this setting, the camera is less likely to track a different subject if the main subject strays from the AF point. The closer the setting is to the minus (-) symbol, the less the camera is inclined to track a different subject. It is effective when you want to prevent the AF points from rapidly tracking something that is not the intended subject during panning or when an obstacle cuts across the AF points.

- **Responsive: +1/+2/+3**

This makes the camera more responsive when tracking a subject that covers the AF point. The closer the setting is to the plus (+) symbol, the more responsive the camera is. It is effective when you want to keep tracking a moving subject as its distance from the camera changes or to rapidly focus on another subject.

Note

- Available when **[AF: Movie Servo AF]** is set to **[Enable]** and **[AF: AF method]** is set to **[Spot AF]** or **[1-point AF]**.
- With **[AF: AF method]** set to an option other than **[Spot AF]** or **[1-point AF]**, operation is equivalent to a setting of **[0]**.

AF Microadjustment

[☑ Adjusting for All Lenses by the Same Amount](#)

[☑ Adjusting for Individual Lenses](#)

[☑ Clearing All AF Microadjustments](#)

Fine adjustment of the point of focus is possible when autofocusing in viewfinder shooting. Before adjustment, also refer to [Precautions for AF Microadjustment](#) and [Notes for AF Microadjustment](#).

⚠ Caution

- **Normally there is no need to adjust the position of focus. Perform this adjustment only if necessary. Make sure to note that performing this adjustment may prevent accurate focusing from being achieved.**

Adjusting for All Lenses by the Same Amount

Keep adjusting, shooting, and checking the results to set the adjustment amount manually. During AF, regardless of the lens used, the point of focus will always be shifted by the adjustment amount.

1. Select [**AF**: AF Microadjustment].

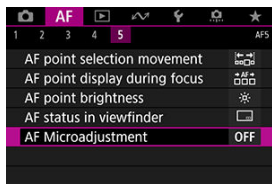

2. Select [All by same amount].

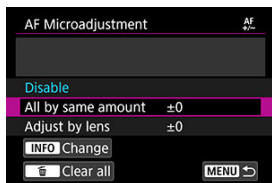

3. Press the < INFO > button.

4. Make the adjustment.

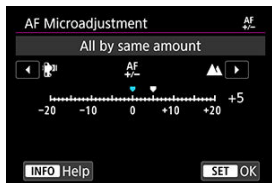

- Set the adjustment amount. The adjustment range is ± 20 steps.
- Setting it toward “-: ” will shift the point of focus in front of the standard point of focus.
- Setting it toward “+: ” will shift the point of focus to behind the standard point of focus.
- After making the adjustment, press < SET >.
- Select [All by same amount], then press < SET >.

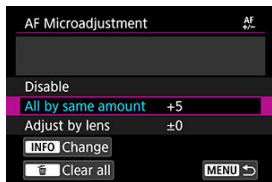

5. Check the result of the adjustment.

- Take a picture and view it (📷) to check the results of adjustment.
- Adjust toward "+: ▲" to correct focusing in front of your targeted position, and adjust toward "-: 📷" to correct focusing behind it.
- Repeat the adjustment as necessary.



Caution

- If **[All by same amount]** is selected, separate AF adjustment will not be possible for the wide-angle and telephoto ends of zoom lenses.

Adjusting for Individual Lenses

You can make the adjustment for each lens and register the adjustment in the camera. You can register the adjustment for up to 40 lenses. When you autofocus with a lens whose adjustment is registered, the point of focus will always be shifted by the adjustment amount. Keep adjusting, shooting, and checking the results to set the adjustment amount manually. If you use a zoom lens, make the adjustment for the wide-angle (W) and telephoto (T) ends.

1. Select [Adjust by lens].

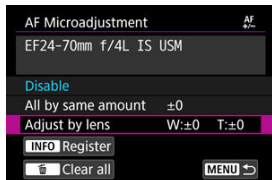

2. Press the <INFO> button.

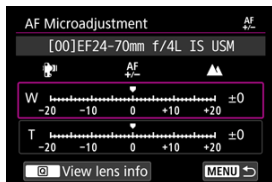

3. Check and change the lens information.

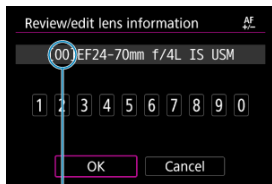

(1)

(1) Registered number

Displaying lens information

- Press the < Q > button.
- The lens name is displayed with a 10-digit serial number. When the serial number is displayed, select [OK] and go to step 4.
- "0000000000" is displayed if the lens serial number is not recognized, and in this case, enter the number manually.
- For details on the asterisk "*" preceding some lens numbers, see [Lens serial numbers](#).

Entering serial numbers

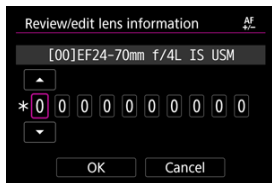

- Select the digit to be entered, then press < SET > so < SET > is displayed.
- Enter the number, then press < SET >.
- After entering all the digits, select [OK].

Lens serial numbers

- In step 3, if the asterisk “*” appears in front of the 10-digit lens serial number, you can register only one unit of the same lens model. Even if you enter the serial number, the asterisk “*” will remain displayed.
- The serial number on the lens may differ from the serial number displayed on the screen in step 3. This is not a malfunction.
- If the lens serial number includes letters, enter only the numbers.
- If the lens serial number is eleven digits or longer, enter only the last ten digits.
- The location of the serial number varies depending on the lens.
- Certain lenses may not have a serial number inscribed. To register a lens that has no serial number inscribed, enter any serial number.



Note

- If **[Adjust by lens]** is selected and an extender is used, the adjustment will be registered for the lens and extender combination.
- If 40 lenses have already been registered, a message will appear. After you select a lens whose registration is to be erased (overwritten), you can register another lens.

4. Make the adjustment.

Single focal length lens

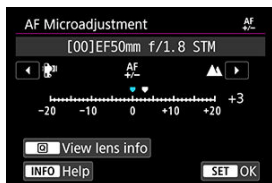

Zoom lens

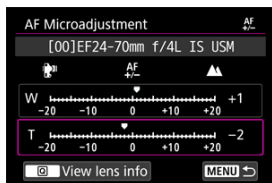

- For a zoom lens, select the wide-angle (W) or telephoto (T) end. Pressing <SET> clears the purple frame and enables adjustment.
- Set the adjustment amount, then press <SET>. The adjustment range is ± 20 steps.
- Setting it toward "-: will shift the point of focus in front of the standard point of focus.
- Setting it toward "+: will shift the point of focus to behind the standard point of focus.
- For a zoom lens, repeat this procedure and adjust it for the wide-angle (W) and telephoto (T) ends.
- After completing the adjustment, press the <MENU> button to return to the screen in step 1.

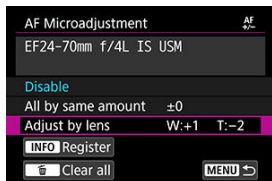

- Select [**Adjust by lens**], then press < (SET) >.

5. Check the result of the adjustment.



- Take a picture and view it (📷) to check the results of adjustment.
- Adjust toward "+: ▲" to correct focusing in front of your targeted position, and adjust toward "-: ▼" to correct focusing behind it.
- Repeat the adjustment as necessary.



Note

- When shooting with the intermediate range (focal length) of a zoom lens, the AF's point of focus is corrected automatically relative to the adjustments made for the wide-angle and telephoto ends. Even if only the wide-angle or telephoto end is adjusted, a correction will be made automatically for the intermediate range.

Clearing All AF Microadjustments

When  **Clear all** appears at the bottom of the screen, pressing the  > button will clear all the adjustments made for **[All by same amount]** and **[Adjust by lens]**.

Caution

Precautions for AF Microadjustment

- The AF's point of focus will vary slightly depending on the subject conditions, brightness, zoom position, and other shooting conditions. Therefore, even if you perform AF Microadjustment, focus may still not be achieved at the suitable position.
- The adjustment amount of one step varies depending on the maximum aperture value of the lens. Keep adjusting, shooting, and checking the results until you are satisfied.
- The adjustment will not be applied to AF in Live View shooting or movie recording.
- When checking the results of adjustment, set to One-Shot AF and set **[AF: One-Shot AF release prior.]** to **[Focus]** before focusing.

Note

Notes for AF Microadjustment

- It is best to make the adjustment at the actual location where you will shoot. This will make the adjustment more precise.
- Using a tripod when making the adjustment is recommended.
- When you will check the results of adjustment, consider shooting with image size set to JPEG  (Large) and JPEG/HEIF quality (compression) set to 8 or higher.

Manual Focus

 [Viewfinder Shooting](#)

 [Live View Shooting](#)

If focus cannot be achieved with autofocus, follow the procedure below to focus manually.

Viewfinder Shooting

1. Set the lens's focus mode switch to <MF>.

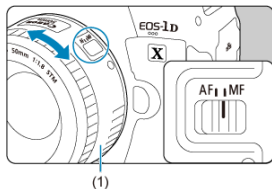

2. Focus on the subject.

- Turn the lens focusing ring (1) until the subject looks sharp in the viewfinder.

Note

- The focus indicator < ● > is lit when subjects are in focus as you press the shutter button halfway in manual focusing.
- With Automatic selection AF, when the center AF point achieves focus, the focus indicator < ● > will light up.

Live View Shooting

You can magnify the image when focusing.

1. Set the lens's focus mode switch to <MF>.

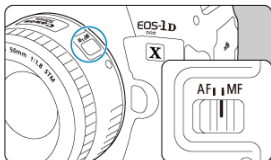

- Turn the lens focusing ring to set the approximate focus.

2. Magnify the image.

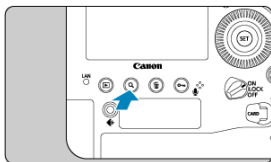



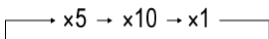

- Each press of the <Q> button changes the magnification ratio, as follows.



3. Move the magnified area.



- Use <  > to move the magnified area into position for focusing.
- To return the magnified area to the center of the screen, press <  > straight in or press the <  > or <  > button.

4. Focus manually.

- While looking at the magnified image, turn the lens focusing ring to focus.
- After achieving focus, press the <  > button to return to the normal view.

Note

- In magnified view, the exposure is locked.

Setting MF peaking (outline emphasis)

In Live View shooting, edges of subjects in focus can be displayed in color to make focusing easier. You can set the outline color and adjust the sensitivity (level) of edge detection.

1. Select **[AF: MF peaking settings]**.

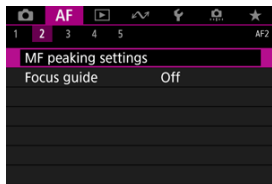

2. Select **[Peaking]**.

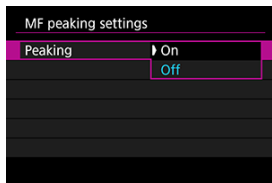

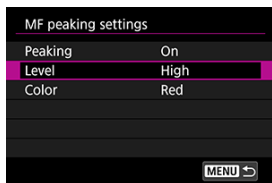

- Select **[On]**.

3. Set the level and color.



- Set it as necessary.

Caution

- In magnified view, peaking display is not shown.
- During HDMI output, peaking display is not shown on equipment connected via HDMI. Note that peaking display is shown on the camera screen when [: **HDMI display**] is set to [].
- MF peaking may be hard to discern at high ISO speeds, especially when ISO expansion is set. If necessary, lower the ISO speed or set [**Peaking**] to [**Off**].

Note

- Peaking display shown on the screen is not recorded in images.
- MF peaking may be hard to discern when Canon Log is set. If necessary, set [**View Assist.**] to [**On**].

Focus guide



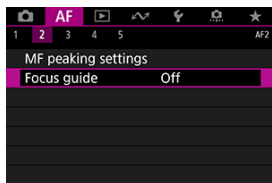

Setting **[Focus guide]** to **[On]** in Live View shooting provides a guide frame that shows which direction to adjust focus and the extent of adjustment needed. The guide frame is displayed near any eyes that are detected for the main subject when **[AF: AF method]** is set to **[L+Tracking]** and **[AF: Eye Detection AF]** is set to **[Enable]**.

1. Select **[AF: Focus guide]**.

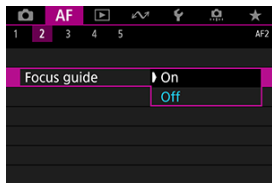

2. Select **[On]**.



- You can use <  > to move the guide frame in the direction you press.
- You can also tap the screen to move the guide frame.
- To return the guide frame to the center of the screen, press <  > straight in or press the <  > or <  > button.

The guide frame indicates the current position in focus and adjustment amount as follows.

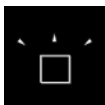

Significantly out of focus toward infinity

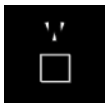

Slightly out of focus toward infinity

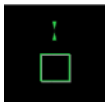

In focus

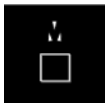

Slightly out of focus toward close range

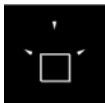

Significantly out of focus toward close range

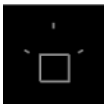

Adjustment information not detected

! Caution

- Under difficult shooting conditions for AF (AF-ON), the guide frame may not be displayed correctly.
- No AF points are displayed while the guide frame is displayed.
- No adjustment information is detected for apertures darker than f/8 when MP-E 65mm f/2.8 1-5× Macro Photo is used or darker than f/11 for other lenses, as indicated by the Focus Guide appearance.
- The guide frame is not displayed in these situations.
 - When the lens's focus mode switch is set to < AF >
 - When display is magnified
- The guide frame is not displayed correctly during shifting or tilting of TS-E lenses.

📄 Note

- The camera's auto power off counter does not count time spent adjusting the focus with a lens's electronic focusing ring.

Selecting the Drive Mode

1. Press the <DRIVE•AF> button (ⓘ6).

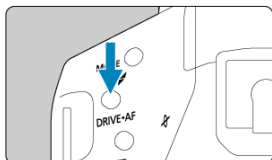

2. Select the drive mode.

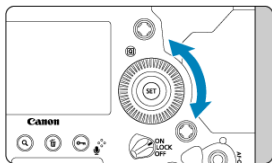
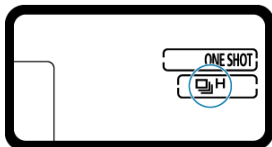

- While looking at the top LCD panel or viewfinder, turn the <ⓘ6> dial.

- **[□] Single shooting**













When you hold down the shutter button completely, only one shot will be taken.

- **[H] High-speed continuous shooting**





When you hold down the shutter button completely, you can shoot continuously at **max. approx. 16 shots/sec. (Live View shooting: 20 shots/sec.)** while you keep holding it down, using LP-E19 or using DR-E19 and AC-E19.

- **[H] Medium-speed continuous shooting**

When you hold down the shutter button completely, you can shoot continuously at **max. approx. 10 shots/sec. (Live View shooting with [Shutter mode] set to [Mechanical]: 8.0 shots/sec.)** while you keep holding it down.

- **[] Low-speed continuous shooting**
When you hold down the shutter button completely, you can shoot continuously at **max. approx. 3.0 shots/sec.** while you keep holding it down.
- **[S ()] Single Soft shooting**
Enables slower mirror movement and shutter cocking in viewfinder shooting than in normal shooting.* No mechanical operation is performed until the shutter button returns to the halfway-pressed position.
* Mechanical sounds are essentially the same as in normal shooting.
- **[S  ()] Soft continuous shooting**
In viewfinder shooting, enables slower mirror movement and shutter cocking than when set to <  >.* **You can shoot continuously at max. approx. 8.0 shots/sec. (Live View shooting: max. approx. 10 shots/sec., or with [: Shutter mode] set to [Mechanical], max. approx. 8.0 shots/sec.).**
* Mechanical sounds are essentially the same as in normal shooting.
- **[S  ()] Soft low-speed continuous shooting**
In viewfinder shooting, enables slower mirror movement and shutter cocking than when set to <  >.* You can shoot continuously at **max. approx. 3.0 shots/sec.**
* Mechanical sounds are essentially the same as in normal shooting.
- **[] () Self-timer: 10 sec.**
[] () Self-timer: 2 sec.
For details on self-timer shooting, see [Using the Self-Timer](#).

Caution

- Maximum high-speed continuous shooting speed is available when shooting with a fully charged battery at a 1/1000 sec. or faster shutter speed and maximum aperture (which varies by lens*) at room temperature (23°C/73°F) with flicker reduction disabled.
* For details, refer to the Canon website.
- Using a Speedlite will decrease the maximum continuous shooting speed.
- Setting the drive mode to < S >, < S  >, or < S  L > has essentially no effect on mechanical sounds in Live View shooting or with [Enable:Mirror down w/ SET] set for mirror lockup.
- <  H > High-speed continuous shooting may be slower depending on the type of power used, the ambient temperature, ISO speed, flicker reduction, shutter speed, aperture value, subject conditions, brightness, type of lens, use of flash, shooting settings, and other conditions.
- With [📷: Anti-flicker shoot.] set to [Enable] (🔒), shooting under flickering light may decrease the maximum continuous shooting speed. Also, the continuous shooting interval may become irregular and the release time lag may become longer.
- With AI Servo AF/Servo AF, the maximum continuous shooting speed may become slower depending on the subject conditions and the lens used.
- Maximum continuous shooting speed may be slower in low-light conditions.
- Maximum continuous shooting speed is slower when the camera's internal temperature is high and the drive mode icon is blinking, in order to prevent internal damage to the camera. Even higher internal temperature from continued shooting may cause significantly slower maximum continuous shooting speed, and the camera may be temporarily unable to shoot until it cools down. If the drive mode icon is blinking, allowing the camera to cool down with the power switch set to < OFF > is recommended.
- Low temperatures may cause the battery itself to become very cold, and the drive mode icon may blink, in which case maximum continuous shooting speed is lower.
- There is a longer time lag than usual with < S >, < S  >, or < S  L > until the shutter is released after you press the shutter button completely.
- When internal memory becomes full during continuous shooting, the continuous shooting speed may drop off because shooting will be temporarily disabled (🔒).

Note

- Continuous shooting speed indicated for each drive mode is the speed under default camera settings. You can set the continuous shooting speed for each drive mode in [📷:4: Continuous shooting speed] (🔒).

Using the Self-Timer

1. Press the <DRIVE•AF> button (ⓘ6).



2. Select the self-timer.

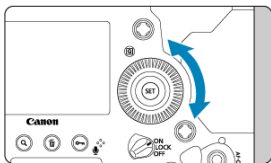
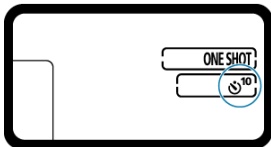

- While looking at the top LCD panel or viewfinder, turn the <SET> dial.
 - ⓘ¹⁰: Shoot in 10 sec.
 - ⓘ²: Shoot in 2 sec.

3. Take the picture.

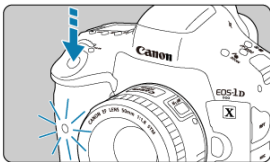

- Look through the viewfinder, focus, then press the shutter button completely.
- You can check self-timer operation by watching the blinking of the self-timer lamp and the countdown display (in seconds) on the top LCD panel.
- The self-timer lamp blinks faster approx. 2 sec. before the shot.

! Caution

- If you will not look through the viewfinder when pressing the shutter button, close the eyepiece shutter before shooting (🔒). Light that enters the viewfinder may prevent suitable exposure.

📄 Note

- < 📷 2 > can be used to start shooting without touching the camera and avoid camera shake when it is mounted on a tripod for still-life or long exposure shots.
- After taking self-timer shots, playing back the image (🔍) to check focus and exposure is recommended.
- When using the self-timer to shoot yourself, use focus lock (🔒) on an object at the same distance as where you will stand.
- The camera does not beep during self-timer shots, even if [🔊: Beep] is set to [Enable].
- To cancel self-timer shooting in progress, set the power switch to < OFF >.

Playback

This chapter covers topics related to playback—playing back captured still photos and movies—and introduces menu settings on the Playback ([▶]) tab.

Caution

- Normal display or selection on this camera may not be possible for images captured on other cameras, or images from this camera that have been edited or renamed on a computer.
- Images that cannot be used with playback functions may be displayed.

Note

- You can set **[Disp. brightness]** () during playback by pressing the <  > button.

- [Tab Menus: Playback](#)
- [Image Playback](#)
- [Magnified Image Display](#)
- [Index Display \(Multiple-Image Display\)](#)
- [Voice Memo Recording and Playback](#)
- [Movie Playback](#)
- [Editing a Movie's First and Last Scenes](#)
- [4K Movie Frame Grab](#)
- [Playback on a TV Set](#)
- [Protecting Images](#)
- [Rotating Images](#)
- [Erasing Images](#)
- [Print Ordering \(DPOF\)](#)
- [Copying Images](#)
- [Converting HEIF to JPEG](#)
- [RAW Image Processing](#)
- [Cropping JPEG Images](#)
- [Resizing JPEG Images](#)
- [Rating Images](#)
- [Slide Show](#)
- [Setting Image Search Conditions](#)
- [Browsing Images with the Main Dial](#)
- [Customizing Playback Information Display](#)

- [Displaying the Highlight Alert](#)
- [AF Point Display](#)
- [Playback Grid](#)
- [HDMI HDR Output](#)

Tab Menus: Playback

● Playback 1

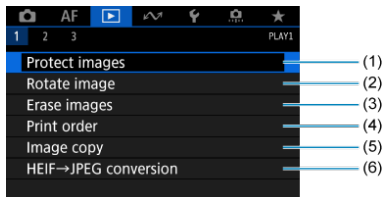

- (1) [Protect images](#)
- (2) [Rotate image](#)
- (3) [Erase images](#)
- (4) [Print order](#)
- (5) [Image copy](#)
- (6) [HEIF→JPEG conversion](#)

● Playback 2

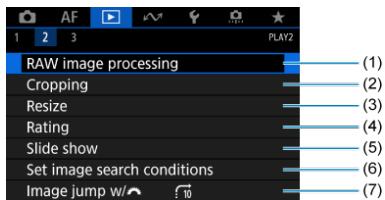

- (1) [RAW image processing](#)
- (2) [Cropping](#)
- (3) [Resize](#)
- (4) [Rating](#)
- (5) [Slide show](#)
- (6) [Set image search conditions](#)
- (7) [Image jump w/ !\[\]\(b1b781be830eb908d845c527ab08d5f8_img.jpg\)](#)

● Playback 3

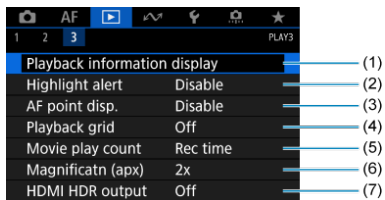

- (1) [Playback information display](#)
- (2) [Highlight alert](#)
- (3) [AF point disp.](#)
- (4) [Playback grid](#)
- (5) [Movie play count](#)
- (6) [Magnificatn \(apx\)](#)
- (7) [HDMI HDR output](#)

Image Playback

[Single-Image Display](#)

[Shooting Information Display](#)

[Touch Playback](#)

Single-Image Display

1. Switch to playback.



- Press the <  > button.
- The last image captured or played back is displayed.

2. Browse images.

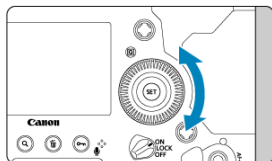

- To play back images starting with your most recent shot, turn the <  > dial counterclockwise. To play back images starting with the first captured image, turn the dial clockwise.
- Each time you press the < **INFO** > button, the display will change.

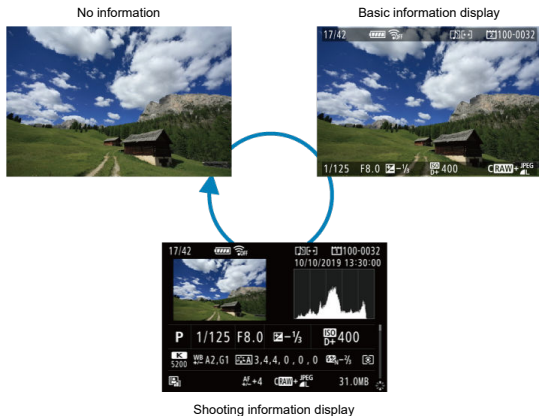

⚠ Caution

- When played back, images captured with [**7: Add cropping information**] set to an option other than [**Off (aspect ratio 3:2)**] () are displayed with lines indicating the image area.

3. Exit image playback.

- Press the <  > button to exit image playback and return to shooting standby.

Shooting Information Display

With the shooting information screen displayed (📷), you can press < ⏪ > up or down to view other information. You can also customize the information displayed, in [▶]: **Playback information display** (📷).

Touch Playback

The camera features a touch-screen panel that you can touch to control playback. Supported touch operations are like those used with smartphones and similar devices. First, press the <  > button to prepare for touch playback.

Browse images



Jump display

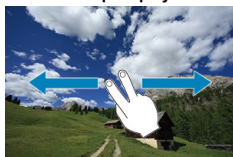

Index display

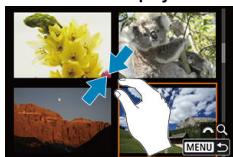

Magnified view



Note

- You can also magnify display by double-tapping with one finger.





Magnified Image Display

[Setting the Initial Magnification Ratio and Position](#)

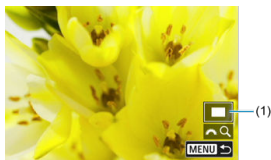
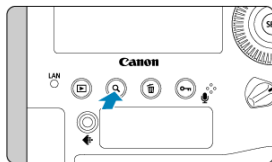
You can magnify captured images by approx. 1.5× to 10×.



1. Magnify the image.

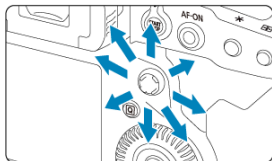

- Magnification is possible at these times: 1. During image playback (single-image display), 2. During image review after shooting, and 3. When the camera is ready to shoot.
- Press the  button.
- The magnified view will appear. The position of the magnified area (1) is displayed in the lower right of the screen, along with .
- To magnify images, turn the  dial clockwise. You can magnify images up to approx. 10×.
- To reduce magnification, turn the  dial counterclockwise. Index display () can be accessed by turning the dial further (at the times of 1. and 3. only).

2. Scroll the image.



- Use <  > to scroll around the magnified image.
- With the Smart controller, you can also move the magnified area itself.
- Press the <  > or <  > button to exit magnified view.

Note

- To switch to other images while maintaining magnified view, turn the <  > dial (at the times of 1. and 3. only).
- Magnification is not available for movies.

Setting the Initial Magnification Ratio and Position

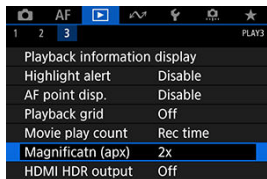

You can set the initial magnification ratio and magnified position by selecting [▶]: **Magnificatn (apx)**.

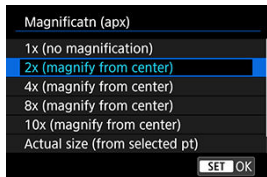

- **1x (no magnification)**

The image is not magnified. The magnified view will start with the single-image display.

- **2x, 4x, 8x, 10x (magnify from center)**

The magnified view starts at the image center at the selected magnification ratio.

- **Actual size (from selected pt)**

The recorded image's pixels will be displayed at approx. 100%. The magnified view starts at the AF point that achieved focus. If the photo is taken with manual focus, the magnified view starts at the image center.

- **Same as last magnif. (from ctr)**

The magnification will be the same as the last time you exited the magnified view with the <▶> or <Q> button. The magnified view starts at the image center.

Index Display (Multiple-Image Display)

1. Press the <Q> button.

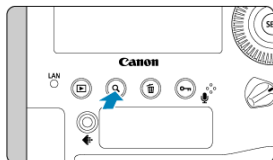

- During image playback, press the <Q> button.
- [☀️ Q] will be displayed in the lower right of the screen.

2. Switch to the index display.

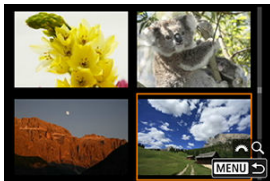



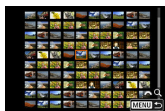
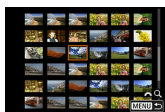



- Turn the <☀️> dial counterclockwise.
- The 4-image index display will appear. The selected image is highlighted with an orange frame.
- Turning the <☀️> dial further counterclockwise will switch the display from 9 to 36 to 100 images. Turning the dial clockwise cycles through 100, 36, 9, 4, and single-image display.



3. Browse images.



- Use <  > or the <  > dial to move the orange frame for image selection.
- To display images on the next or previous screen, press the <  > button to clear the [ ] icon, then turn the <  > dial.
- Press <  > in the index display to display the selected image in the single-image display.

Voice Memo Recording and Playback

 [Recording Voice Memos](#)

 [Playing Voice Memos](#)

You can add (record) voice memos to your shots. Voice memos are recorded as WAV audio files with the same file number as the image. They can be played back by the camera or a computer.

Recording Voice Memos

1. Switch to playback.
2. Select an image to add a voice memo to.
 - Turn the <  > dial to select an image to add a voice memo to.

3. Record a voice memo.

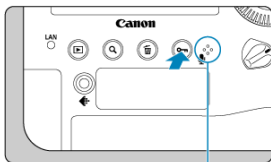

(1)

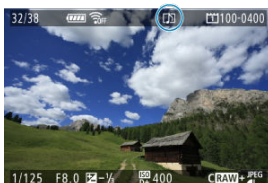

- Hold down the $\langle \text{mic} \rangle$ button for approx. 2 sec.
- Keep holding down the button after **[Recording memo...]** appears, and speak into the voice memo microphone (1). Each recording can be up to approx. 30 sec.
- To end the voice memo, release the button.
- A $\langle \text{mic} \rangle$ icon is displayed at the top of the screen.



Caution

- Voice memos cannot be added to movies or protected images.
- Voice memos cannot be recorded with an external microphone.



Note

- Audio quality of voice memo recording can be changed in [], 7: **Memo audio quality**.
- To record voice memos longer than 30 sec., repeat step 2.
- You can record a single voice memo during image review (immediately after shooting) by following step 2.
- Even during transfer to an FTP server, you can add a voice memo to images from the playback screen. However, voice memos cannot be added to the image currently being transferred.

1. Select [6: button function].

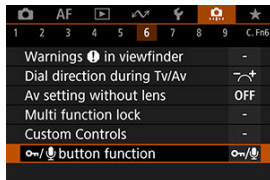

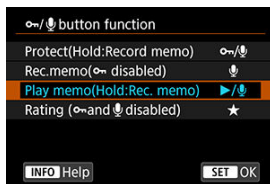

2. Select [Play memo(Hold:Rec. memo)].



3. Select an image for voice memo playback.



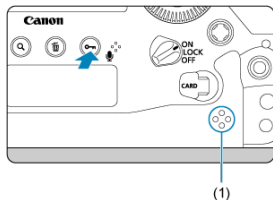

- Press the <  > button to switch to image playback.
- Turn the <  > dial to select an image labeled with a [] icon at the top of the screen.

4. Play back the voice memo.



(1) Speaker

- Press the <  > button to play back the voice memo.
- You can adjust the sound volume by turning the <  > dial.
- Press the <  > button to stop playback.

Note

- Multiple voice memos added to an image are played back consecutively.
- Added voice memos cannot be erased by themselves using the camera.
- Erasing images () also erases any voice memos added to the images.



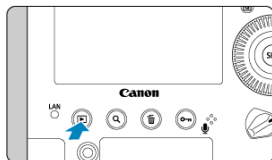

1. Switch to playback.

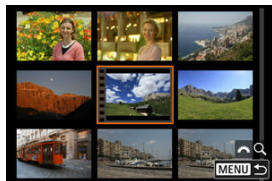

- Press the <  > button.

2. Select a movie.



- Turn the <  > dial to select a movie to play.
- In single-image display, the <   > icon displayed in the upper left of the screen indicates a movie.
- In index display, perforations at the left edge of a thumbnail indicate a movie. Movies cannot be played back from index display, so press <  > to switch to single-image display.

3. In the single-image display, tap < ▶ > or press < SET >.

4. Press < SET > to play back the movie.

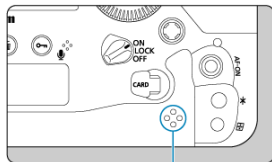

(1)

(1) Speaker

- The movie will start playing back.
- You can pause playback and display the movie playback panel by pressing < SET >. Press it again to resume the playback.
- Turn the <  > dial to adjust the volume (even during playback).

Movie playback panel

Item	Playback Operations
Playback	Pressing < > toggles between playback and stop.
Slow motion	Adjust the slow motion speed by turning the < > dial. The slow motion speed is indicated in the upper right of the screen.
Skip backward	Skips backward approx. 4 sec. each time you press < >.
Previous frame	Displays the previous frame each time you press < >. Holding < > down will rewind the movie.
Next frame	Plays the movie frame-by-frame each time you press < >. Holding < > down will fast forward the movie.
Skip forward	Skips forward approx. 4 sec. each time you press < >.
Edit	Displays the editing screen ().
Frame Grab	Available when you play 4K movies. Enables you to extract the current frame and save it as a JPEG still image ().
	Playback position
mm' ss"	Playback time (minutes:seconds, when [Movie play count] is set to [Rec time])
hh:mm:ss.ff (DF) hh:mm:ss.ff (NDF)	Time code (hours:minutes:seconds:frames, when [Movie play count] is set to [Time code])
Volume	Turn the < > dial to adjust the volume of the built-in speaker () or headphones.
	Press the < MENU > button to return to single-image display.

Caution

- Adjust the volume using television controls when the camera is connected to a television for movie playback () , because volume cannot be adjusted by turning the < > dial.
- Movie playback may stop if the card's read speed is too slow or movie files have corrupted frames.
- High internal camera temperature may prevent movie playback. Movie playback may also stop if the camera becomes hot during playback.

Editing a Movie's First and Last Scenes

You can edit out the first and last scenes of a movie in approx. 1-sec. increments.

1. In single-image display, press **[SET]**.

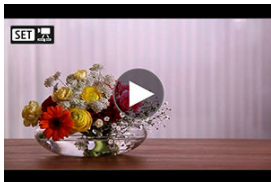

2. On the movie playback panel, select **[F6]**.



3. Specify the part to be edited out.

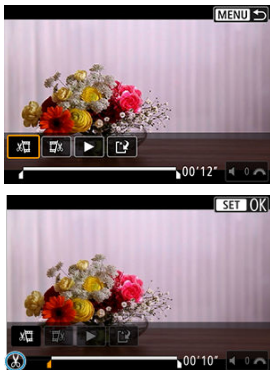

- Select either [X] (Cut beginning) or [X] (Cut end).
- Press < ⏮ > left or right to go back or forward one frame. Keep pressing the multi-controller to fast rewind or fast forward frames. Each turn of the < ⏪ > dial goes back or forward one frame.
- After deciding which part to edit out, press < SET >. The portion indicated by a line at the bottom of the screen will remain.

4. Check the edited movie.



- Select [▶] to play back the edited movie.
- To change the edited part, go back to step 3.
- To cancel the editing, press the < MENU > button.

5. Save the image.



(1)

- Select **[]** (1).
- The save screen will appear.
- To save it as a new file, select **[New file]**, or to save it and overwrite the original movie file, select **[Overwrite]**.
- On the confirmation screen, select **[OK]** to save the edited movie and return to the movie playback screen.

Caution



- Because editing is performed in approx. 1 sec. increments (at the position indicated by **[X]** at the bottom of the screen), the actual position where movies are trimmed may differ from your specified position.
- Movies recorded with another camera and RAW movies cannot be edited with this camera.
- You cannot edit a movie when the camera is connected to a computer.

4K Movie Frame Grab

From 4K movies, you can select individual frames to save as JPEG still images. This function is called “Frame Grab (4K frame capture)”.

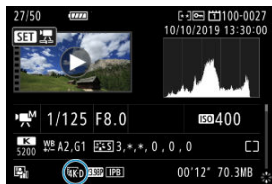
1. Select a 4K movie.



- Turn the <  > dial to select a 4K quality movie.
- On the shooting information screen () , 4K movies are labeled with [4K-D], [4K-P], and [4K-U] icons.
- In index display, press <  > to switch to single-image display.

2. In the single-image display, press < >.

- The movie playback panel will appear.

3. Select a frame to grab.



- Use the movie playback panel to select the frame to grab as a still image.
- For movie playback panel instructions, see [Movie playback panel](#).

4. Select [Frame Grab].



5. Save the image.

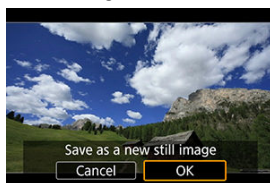

- Select [OK] to save the current frame as a JPEG still image.
- Check the destination folder and image file number.

6. Select the image to display.

- Select [View original movie] or [View extracted still image].

 Caution

- Frame grabbing is not possible from the following 4K movies.
 - RAW movies
 - Movies recorded with [📷: Canon Log settings] set to [On]
 - Movies recorded with other cameras
- Frame grabbing is not possible while the camera is connected to a computer.

Playback on a TV Set

By connecting the camera to a television with an HDMI cable, you can play back the captured still photos and movies on the television. Using the HDMI Cable HTC-100 (sold separately) is recommended.

If the image does not appear on the TV screen, confirm that [**Video system**] is correctly set to [**For NTSC**] or [**For PAL**] (depending on the video system of your television).

1. Connect the HDMI cable to the camera.

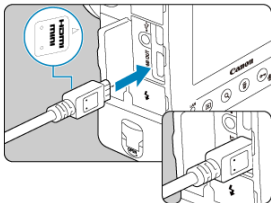

- With the plug's < ▲ **HDMI MINI**> logo facing the front of the camera, insert it into the < **HDMI OUT**> terminal.

2. Connect the HDMI cable to the television.

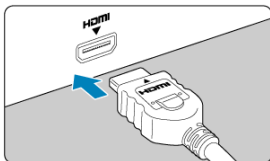

- Connect the HDMI cable to the television's HDMI IN port.

3. Turn on the television and switch the television's video input to select the connected port.

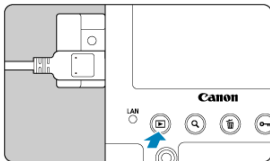

4. Set the camera's power switch to < ON >.

5. Press the <  > button.



- Images are now displayed on the television, with nothing displayed on the camera screen.
- The images will automatically be displayed at the optimum resolution matching the connected television.

 **Caution**

- Adjust movie sound volume with the television. The sound volume cannot be adjusted with the camera.
- Before connecting or disconnecting the cable between the camera and television, turn off the camera and television.
- Depending on the television, part of the image displayed may be cut off.
- Do not connect any other device's output to the camera's < **HDMI OUT** > terminal. Doing so may cause a malfunction.
- Certain televisions may not display the images due to incompatibility.
- It may take some time before images are displayed. To avoid delay, set [: **HDMI resolution**] to [1080p] ().
- Touch-screen operations are not supported while the camera is connected to a television.

Protecting Images

 [Protecting Individual Images with the < !\[\]\(e640e0608cc7d5ca49cf1ad6b9b82bbd_img.jpg\) / !\[\]\(92b03d1f12d69c4f54507e4fc2d5d7f3_img.jpg\) > Button](#)

 [Protecting Individual Images via the Menu](#)

 [Specifying the Range of Images to Protect](#)

 [Protecting All Images in a Folder or on a Card](#)

You can protect important images from being accidentally erased.

Caution

- If you format the card () , the protected images will also be erased.

Note

- Once an image is protected, it cannot be erased by the camera's erase function. To erase a protected image, you must first cancel the protection.
- If you erase all the images () , only the protected images will remain. This is convenient when you want to erase all unneeded images at once.

Protecting Individual Images with the < / > Button

1. Select the image to protect.

- Turn the <  > dial to select an image to protect.

2. Protect the image.



- Press the $\langle \text{On} / \text{U} \rangle$ button to protect the image, after which it will be labeled with a $\langle \text{On} \rangle$ icon (1) at the top of the screen.
- To cancel protection and clear the $\langle \text{On} \rangle$ icon, press the $\langle \text{On} / \text{U} \rangle$ button again.
- To protect another image, repeat steps 1 and 2.

Protecting Individual Images via the Menu

1. Select [: Protect images].

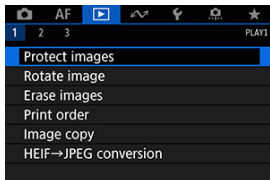

2. Select [Select images].

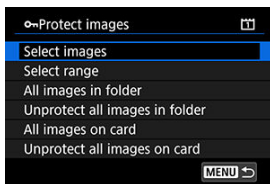

3. Select the image to protect.

- Turn the < > dial to select an image to protect.

4. Protect the image.



- Press < SET > to protect the selected image, after which it will be labeled with a < On > icon (1) at the top of the screen.
- To cancel protection and clear the < On > icon, press < SET > again.
- To protect another image, repeat steps 3 and 4.

Specifying the Range of Images to Protect

While looking at the images in the index display, you can specify the first and last images for a range to protect all the specified images at once.

1. Select [Select range].

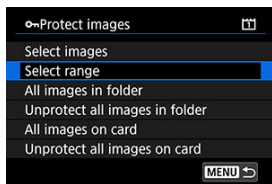

2. Specify the range of images.

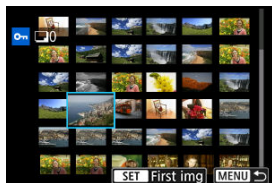

- Select the first image (start point).
- Next, select the last image (end point). The images in the specified range will be protected and the < Protect > icon will appear.
- To select another image to protect, repeat step 2.

Protecting All Images in a Folder or on a Card

You can protect all the images in a folder or on a card at once.

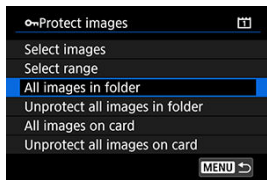

- When you select **[All images in folder]** or **[All images on card]** in **[]: Protect images**, all the images in the folder or on the card will be protected.
- To cancel protection, select **[Unprotect all images in folder]** or **[Unprotect all images on card]**.
- If the search conditions are set with **[]: Set image search conditions** (), the display will change to **[All found images]** and **[Unprotect all found]**.

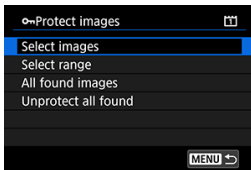

- If you select **[All found images]**, all the images filtered by the search conditions will be protected.
- If you select **[Unprotect all found]**, the protection of all the filtered images will be canceled.

Note

- Protecting or unprotecting images by selecting **[All images on card]** or **[Unprotect all images on card]** applies to the card selected in **[]: Record func+card/folder sel.** (in either **[] Record/play**/**[] Record/play** or **[] Play**/**[] Play**).

Rotating Images

You can use this feature to rotate the displayed image to the desired orientation.

1. Select []: Rotate image].

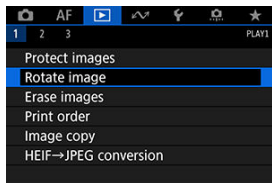

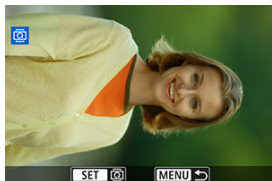

2. Select an image to rotate.



- Turn the <  > dial to select the image.

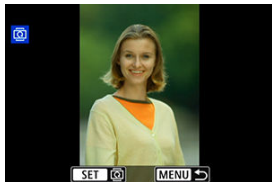



3. Rotate the image.



- Each time you press <  >, the image will rotate clockwise as follows: 90°→270°→0°.
- To rotate another image, repeat steps 2 and 3.



Note

- If you set [**⚙**: **Auto rotate**] to [**On**] () before taking pictures, you need not rotate the image with this function.
- If the rotated image is not displayed in the rotated orientation during image playback, set [**⚙**: **Auto rotate**] to [**On**].
- Movies cannot be rotated.

Erasing Images

- [Erasing Images Individually](#)
- [Selecting \(\[✓\]\) Multiple Images to Erase Together](#)
- [Specifying the Range of Images to Erase](#)
- [Erasing All Images in a Folder or on a Card](#)

You can either select and erase unnecessary images individually or erase them in one batch. Protected images (🔒) will not be erased.

⚠ Caution

- **Once an image is erased, it cannot be recovered. Make sure you no longer need the image before erasing it. To prevent important images from being erased accidentally, protect them.**

Erasing Images Individually

1. Press the < ▶ > button.
2. Select the image to be erased.
 - Turn the < ⦿ > dial to select the image to erase.
3. Press the < 🗑 > button.

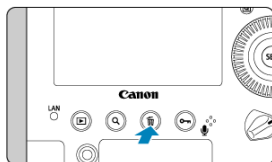

4. Erase the images.

JPEG/HEIF/RAW images or movies

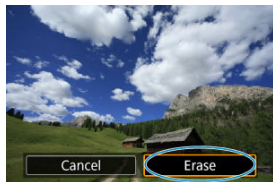

- Select [Erase].

RAW+JPEG/RAW+HEIF images



- Select an item.

Selecting ([✓]) Multiple Images to Erase Together

By adding checkmarks to the images to be erased, you can erase all those images at once.

1. Select [Erase images].

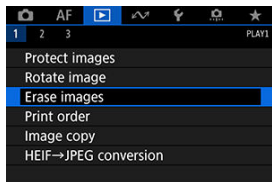

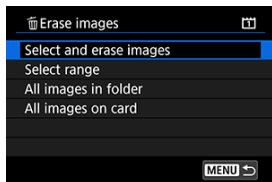

2. Select [Select and erase images].





3. Select an image.

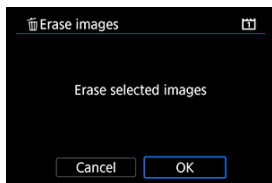

- Turn the <  > dial to select an image to erase, then press <  >.
- To select another image to be erased, repeat step 3.

4. Erase the images.



- Press the <  > button, then press **[OK]**.

Specifying the Range of Images to Erase

While looking at the images in the index display, you can specify the first and last images for a range to erase all the specified images at once.

1. Select [Select range].

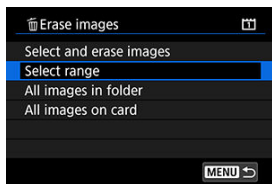

2. Specify the range of images.



- Select the first image (start point).
- Next, select the last image (end point).
- To select another image to be erased, repeat step 2.

3. Press the < > button.

4. Erase the images.

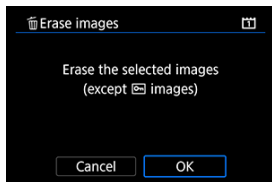

- Select [OK].

Erasing All Images in a Folder or on a Card

You can erase all the images in a folder or on a card at once.

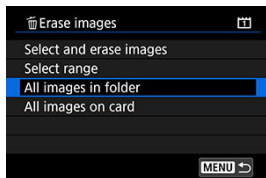

- When you select **[All images in folder]** or **[All images on card]** in **[▶]: Erase images**, all the images in the folder or on the card will be erased.
- If the search conditions are set with **[▶]: Set image search conditions** (🔍), the display will change to **[All found images]**.

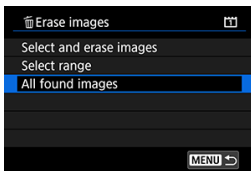

- If you select **[All found images]**, all the images filtered by the search conditions will be erased.

Note

- To erase all the images including protected images, format the card (🔗).
- Erasing images by selecting **[All images on card]** applies to the card selected in **[🔍: Record func+card/folder sel.]** (in either **[📷 Record/play]/[📷] Record/play** or **[📷 Play]/[📷] Play**).

Print Ordering (DPOF)

 [Setting Print Options](#)

 [Selecting Images for Printing](#)

DPOF (Digital Print Order Format) enables you to print images recorded on the card according to your printing instructions such as the image selection, quantity to print, etc. You can print multiple images in one batch or create a print order for a photofinisher.

You can set the print settings such as print type, date imprinting, file number imprinting, etc. The print settings will be applied to all the images specified for printing. (They cannot be set individually for each image.)

Setting Print Options

1. Select [: Print order].

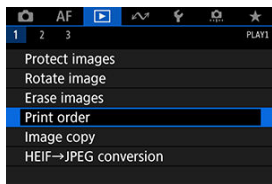

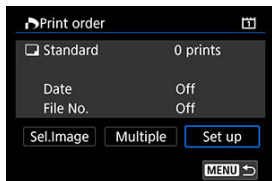

2. Select [Set up].



3. Set the options as desired.

- Set **[Print type]**, **[Date]**, and **[File No.]** options.

Print type	 Standard	Prints one image on one sheet.
	 Index	Multiple thumbnail images are printed on one sheet.
	 Both	Prints both the standard and index prints.
Date	On	[On] imprints the recorded date of the captured image.
	Off	
File No.	On	[On] imprints the file number.
	Off	

4. Exit the setting.

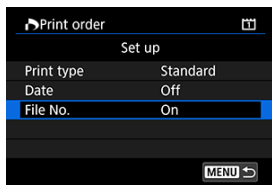

- Press the < **MENU** > button.
- Next, select **[Sel.Image]** or **[Multiple]** to specify the images to be printed.

 **Caution**

- If you print an image with a large image size using the **[Index]** or **[Both]** setting (📄), the index print may not be printed with certain printers. In this case, resize the image (📏), then print the index print.
- Even if **[Date]** and **[File No.]** are set to **[On]**, the date or file number may not be imprinted, depending on the print type setting and printer.
- With **[Index]** prints, the **[Date]** and **[File No.]** cannot both be set to **[On]** at the same time.
- When printing with DPOF, use the card for which print order specifications are set. You cannot print in the specified print order if you extract just the images from the card for printing.
- Certain DPOF-compliant printers and photofinishers may not be able to print the images as you specified. When using a printer, refer to the printer's instruction manual. When requesting service from a photofinisher, ask in advance.
- Do not use this camera to configure print settings for images with DPOF settings set up on another camera. All the print orders may be overwritten inadvertently. Also, the print order may not be possible, depending on the image type.

Selecting Images for Printing

Sel.Image

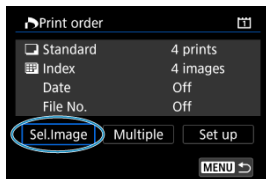

Select and specify the images individually.

Press the < MENU > button to save the print order to the card.

● Standard/Both



Press < SET > to print a copy of the displayed image. By turning the < DIAL >, you can set a print quantity of up to 99 copies.

● Index

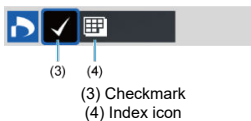

Press < SET > to add a checkmark to the box [✓]. The image will be included in the index print.

Multiple

- **Select range**

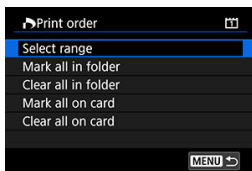

Select **[Select range]** in **[Multiple]**. Selecting the first and last images of the range marks all the images in the range with a checkmark [✓], and one copy of each image will be specified for printing.

- **All images in a folder**

Select **[Mark all in folder]** and select the folder. A print order for one copy of all the images in the folder will be specified.

If you select **[Clear all in folder]** and select the folder, the print order for all the images in the folder will be canceled.

- **All images on a card**

If you select **[Mark all on card]**, one copy of all the images on the card will be specified for printing.

If you select **[Clear all on card]**, the print order will be cleared for all the images on the card.

If the search conditions are set with **[▶]: Set image search conditions** (🔍) and you select **[Multiple]**, the display will change to **[Mark all found images]** and **[Clear all found images]**.

- **All found images**

If you select **[Mark all found images]**, one copy of all the images filtered by the search conditions will be specified for printing.

If you select **[Clear all found images]**, all the print order of the filtered images will be cleared.

 **Caution**

- RAW images or movies cannot be specified for printing. Note that RAW images or movies will not be specified for printing even if you specify all images with **[Multiple]**.
- When using a PictBridge-compatible printer, do not specify more than 400 images for one print order. If you specify more than this, not all images may be printed.

Copying Images



 [Copying Individual Images](#)

 [Copying a Range of Images](#)





 [Copying All Images in a Folder or on a Card](#)

You can copy the images on one card to the other card to save duplicates.
All images in a folder or on a card can also be copied at the same time.

Caution

- If the target folder or card already has an image with the same file number, [**Skip image and continue**], [**Replace existing image**], and [**Cancel copy**] are displayed. Select a copying method, then press <  >.
 - [**Skip image and continue**]: Any images with the same file number are skipped and not copied.
 - [**Replace existing image**]: Any images with the same file number (including protected images) are overwritten.Overwriting images that had print order information () will require you to set the print order information again.
- Print order and image transfer information is not included in copies of images.
- Shooting is not possible during the copying process. Select [**Cancel**] before shooting.

Note

- Images are copied from the card selected in [ **Record func+card/folder sel.**] (in either [ **Record/play**]/[ **Record/play**] or [ **Play**]/[ **Play**]).
- Copies of images have the same file name as the original image.
- With [**Sel.Image**], images in multiple folders cannot be copied at the same time. Select images to copy from one folder at a time.
- Any voice memos added to images are also copied.

Copying Individual Images

1. Select [**▶**]: Image copy].

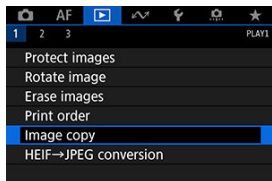

2. Select [**Sel.Image**].

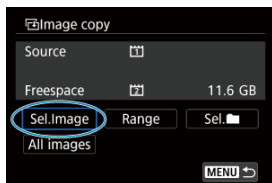

- Check the source and target card numbers and the free space on the target card.
- Select [**Sel.Image**], then press < **SET** >.

3. Select the folder.

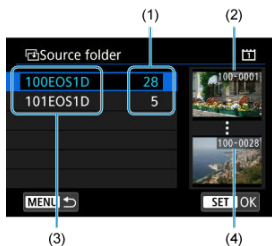

- (1) Number of images in folder
- (2) Lowest file number
- (3) Folder name
- (4) Highest file number



- Select the source folder, then press $\langle \text{SET} \rangle$.
- When selecting the folder, refer to the images displayed at right of the screen.



4. Select an image to copy.



- (1) Total images selected

- Turn the $\langle \text{DIAL} \rangle$ dial to select an image to copy, then press $\langle \text{SET} \rangle$.
- To select another image to copy, repeat step 4.

5. Press the <  /  > button.

- After selecting all images to copy, press the <  /  > button.

6. Select [OK].

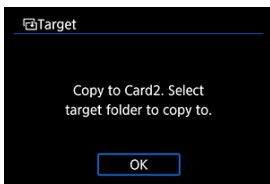

- Check the target card, then select [OK].

7. Select the target folder.

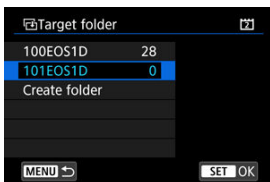

- Select the folder to copy the image to, then press <  >.
- To create a new folder, select [Create folder].

8. Select [OK].

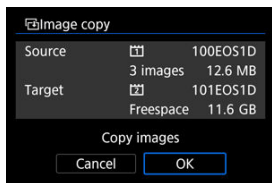

- Check the information about the source and target card, then select [OK].

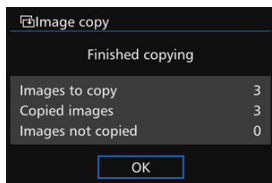

- Results are displayed after copying is finished. Select [OK] to return to the screen in step 2.

Copying a Range of Images

You can copy all specified images at once by selecting the first and last images in a range as you look at images in the index display.

1. Select [Range].

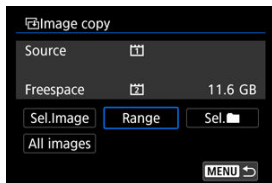

2. Select the folder.

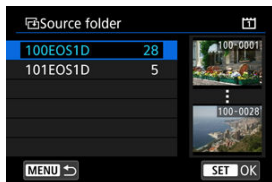

- Select the source folder, then press < (SET) >.
- When selecting the folder, refer to the images displayed at right of the screen.



3. Specify the range of images.



- Select the first image (start point).
- Next, select the last image (end point). A checkmark [✓] will be appended to all the images within the range between first and last images.
- To select another image to copy, repeat step 3.

Copying All Images in a Folder or on a Card

You can copy all the images in a folder or on a card at once.

Selecting [Sel. ] or [All images] in [: Image copy] copies all the images it contains.

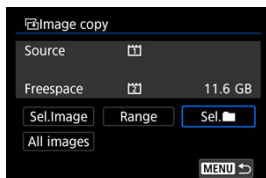

Converting HEIF to JPEG

You can convert HEIF images captured in HDR shooting and save them as JPEG images. Converted JPEGs resemble how the original HEIF image appears on an HDR display device.

1. Select []: HEIF→JPEG conversion].

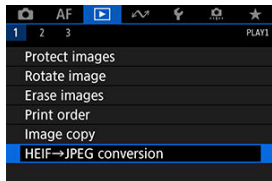

2. Select an image.

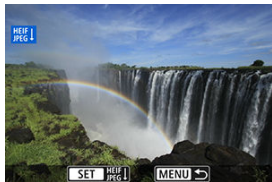

- Turn the < > dial to select an HEIF image to convert to JPEG.
- Press < > to convert to JPEG.

3. Save the image.

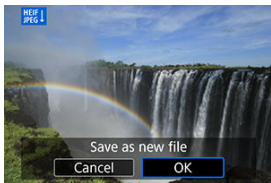

- Select **[OK]** to save the JPEG image.
 - Check the destination folder and image file number, then select **[OK]**.
 - To convert another image, repeat steps 2 and 3.

Note

- Some scenes may look different after conversion if the original and converted images are compared.

RAW Image Processing

[☑ Magnified View](#)

[☑ RAW Image Processing Options](#)

You can process **RAW** or **CRAW** images with the camera to create JPEG or HEIF images. RAW images are not affected, so different conditions can be applied to create JPEG or HEIF images.

You can also use Digital Photo Professional (EOS software) to process RAW images.

⚠ Caution

- Processing into HEIF is not available for **RAW** or **CRAW** images captured with multiple exposure, expanded ISO speed (L or H), or electronic shutter selected.

1. Select [**▶**]: RAW image processing].

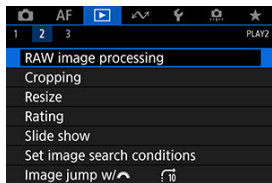

2. Select an item, then select images.

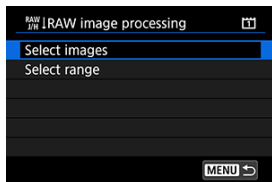

- You can select multiple images to process at once.

Selecting images



- Turn the $\langle \odot \rangle$ dial to select images to process, then press $\langle \text{SET} \rangle$.
- Press the $\langle \text{Q} \rangle$ button.

Selecting range

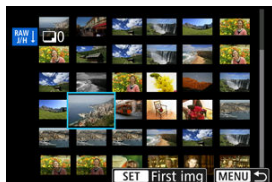

- Select the first image (start point).
- Next, select the last image (end point).
- Press the $\langle \text{Q} \rangle$ button.
- To process other images, repeat this step.

3. Set the desired processing conditions.

Use shot settings

- Images are processed using image settings at the time of capture.
- RAW images captured in HDR shooting are processed to create HEIF images, and other RAW images are processed to create JPEGs.

Set up processing → JPEG/Set up processing → HEIF





- Turn the < > dial to select an item.
- Turn the < > or < > dial to switch the setting.
- Press < > to access the function setting screen.
- To return to the image settings at the time of shooting, press the < > button.

Comparison screen

- You can switch between the **[After change]** and **[Shot settings]** screens by pressing the < **INFO** > button and turning the < > dial.
- Items in orange on the **[After change]** screen have been modified since the time of capture.
- Press the < **MENU** > button.

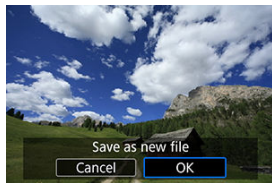
4. Save the image.



- When using [Set up processing→JPEG] or [Set up processing→HEIF], select [] (Save).
- Read the message and select [OK].
- To process other images, select [Yes] and repeat steps 2–4.

5. Select the image to display.



- Select [Original image] or [Processed img.].

Magnified View

You can magnify images displayed for **[Set up processing→JPEG]** or **[Set up processing→HEIF]** by pressing the <Q> button. The magnification ratio varies depending on the **[Image quality]** setting. With <⏏>, you can scroll around the magnified image. To cancel the magnified view, press the <Q> button again.

⚠ Caution

- Results of processing with **[Digital Lens Optimizer]** set to **[High]** are only applied in magnified view. Results are not applied in normal display.

RAW Image Processing Options

-  **Brightness adjustment**

You can adjust the image brightness up to ± 1 stop in 1/3-stop increments.

-  **White balance** 

You can select the white balance. Selecting **[AWB]** enables you to select **[Auto: Ambience priority]** or **[Auto: White priority]**. If you select **[K]**, you can set the color temperature.

-  **Picture Style** 

You can select the Picture Style. You can adjust the sharpness, contrast, and other parameters.

* **[s:~A]**, **[s:~1]**, **[s:~2]**, and **[s:~3]** are not available when **[Set up processing→HEIF]** is set.

-  **Clarity** 



You can adjust clarity in a range of -4 to $+4$.

* Not available when **[Set up processing→HEIF]** is set.



-  **Auto Lighting Optimizer** 

You can set the Auto Lighting Optimizer.

* Not available when **[Set up processing→HEIF]** is set.

-  **High ISO speed NR** 

You can set the noise reduction processing for high ISO speeds. If the effect is difficult to discern, magnify the image .

-  **Image quality** 

You can set the image quality (image size and JPEG quality) when creating a JPEG image. Press  up or down to select the image size and JPEG quality.

When creating an HEIF image, you can only set the HEIF quality.



-  **sRGB Color space** 

You can select either sRGB or Adobe RGB. Since the camera screen is not compatible with Adobe RGB, the difference in the image will hardly be perceptible when either color space is set.

* **[HDR PQ]** is displayed when **[Set up processing→HEIF]** is set but is not an option for selection.

● Lens aberr correction

• OFF **Peripheral illum corr**

A phenomenon that makes the image corners look darker due to the lens characteristics can be corrected. If **[Enable]** is set, the corrected image will be displayed. If the effect is difficult to discern, magnify the image  and check the four corners. Less correction is applied than for maximum correction with Digital Photo Professional (EOS software, ). If the effects of correction are not apparent, use Digital Photo Professional to apply the peripheral illumination correction.

• OFF **Distortion correction**

Image distortion due to lens characteristics can be corrected. If **[Enable]** is set, the corrected image will be displayed. The image periphery will be trimmed in the corrected image.

Since the image resolution may look slightly lower, adjust the sharpness with the Picture Style's sharpness parameter setting as necessary.

• OFF **Digital Lens Optimizer**

Correct lens aberration, diffraction, and low-pass filter-induced loss of resolution by applying optical design values. To check the effect of setting this option to **[High]** or **[Standard]**, use magnified view . Without magnification, the effect when Digital Lens Optimizer is set to **[High]** is not applied. Selecting **[High]** or **[Standard]** corrects both chromatic aberration and diffraction, although these options are not displayed.

• OFF **Chromatic aberr corr**

Chromatic aberrations (color fringing along the subject's outline) due to the lens characteristics can be corrected. If **[Enable]** is set, the corrected image will be displayed. If the effect is difficult to discern, magnify the image .

• OFF **Diffraction correction**

The diffraction by the lens aperture degrading the image sharpness can be corrected. If **[Enable]** is set, the corrected image will be displayed. If the effect is difficult to discern, magnify the image .

Caution

- Processing RAW images in the camera will not produce exactly the same results as processing RAW images with Digital Photo Professional (EOS software).
- If you perform [**Brightness adjustment**], noise, banding, etc. may be intensified with the effects of adjustment.
- When [**Digital Lens Optimizer**] is set, noise may be intensified together with the effects of correction.
- When [**Digital Lens Optimizer**] is set, image edges may be emphasized, under some shooting conditions. Adjust sharpness of the Picture Style as needed.
- Processing with [**Digital Lens Optimizer**] set to [**High**] may take some time.
- Dust Delete Data () is not added to images when processing is performed with [**Distortion correction**] set to [**Enable**].

Note

- Lens correction data for lenses compatible with this feature is registered (stored) on the camera.
- Effects of lens aberration correction vary by lens and shooting conditions. Also, the effect may be difficult to discern depending on the lens used, shooting conditions, etc.
- For details on the correction data used with Digital Lens Optimizer, see [Digital Lens Optimizer](#).
- RAW movies cannot be processed. Process them with Digital Photo Professional (EOS software).

Cropping JPEG Images

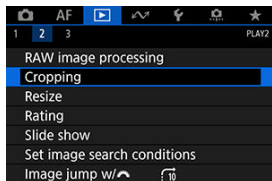

You can crop a captured JPEG image and save it as another image. Cropping an image is possible only with JPEG images. Cropping is not available for HEIF or RAW images, or for frame-grab images from 4K movies.

1. Select []: Cropping].







2. Select an image.



- Turn the <  > dial to select the image to crop.
- Press <  > to display the cropping frame.

3. Set the cropping frame.



- The image area within the cropping frame will be cropped.
- **Resizing the cropping frame size**
Turn the <  > dial to resize the cropping frame size. The smaller the cropping frame, the more magnified the cropped image will look.
- **Changing the cropping frame aspect ratio and orientation**
Turn the <  > dial to change the cropping frame aspect ratio and orientation.
- **Moving the cropping frame**
Use <  > to move the cropping frame vertically or horizontally.
- **Correcting tilt**
You can correct image tilt by $\pm 10^\circ$. Press the < INFO > button. While checking tilt relative to the grid, turn the <  > dial (in 0.1° increments) or tap the left or right arrow (in 0.5° increments) in the upper left of the screen to correct tilt. After completing the tilt correction, press <  >.

4. Check the image area to be cropped.





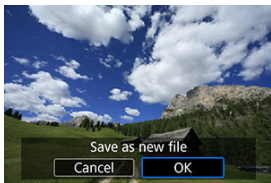

- Press the <  > button. The image area to crop is displayed.

5. Save the image.



- Press < **SET** > and select [**OK**] to save the cropped image.
- Check the destination folder and image file number, then select [**OK**].
- To crop another image, repeat steps 2 to 5.

Caution

- The position and size of the cropping frame may change depending on the angle set for tilt correction.
- Once a cropped image is saved, it cannot be cropped again or resized.
- AF point display information () and Dust Delete Data () will not be appended to the cropped images.
- Available aspect ratios vary depending on whether you use []: **Cropping**] or []: **Add cropping information**].

Resizing JPEG Images

You can resize a JPEG image to make the pixel count lower and save it as a new image. Resizing an image is possible only with JPEG **L/M1/M2** images. Resizing is not available for JPEG **S**, HEIF, or RAW images, or for frame-grab images from 4K movies.

1. Select []: Resize].

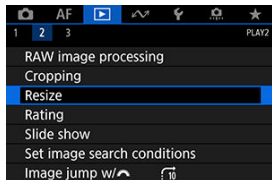

2. Select an image.



- Turn the <  > dial to select the image to resize.

3. Select the desired image size.

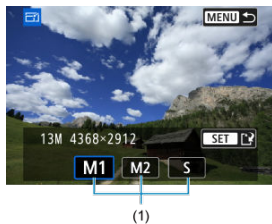

- Press < **SET** > to display the image sizes.
- Select the desired image size (1).

4. Save the image.

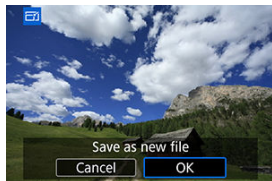

- Select [**OK**] to save the resized image.
- Check the destination folder and image file number, then select [**OK**].
- To resize another image, repeat steps 2 to 4.

Rating Images

- [Rating Individual Images](#)
- [Rating by Specifying the Range](#)
- [Rating All Images in a Folder or on a Card](#)

You can rate images on a scale of 1–5 ([*]/[* *]/[* * *]/[* * * *]/[* * * * *]). This function is called rating.
* Rating images can help you organize them.

Rating Individual Images

1. Select [▶]: Rating].

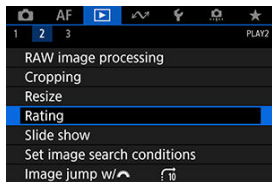

2. Select [Select images].

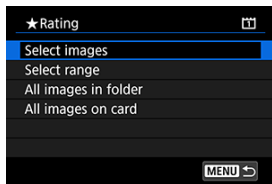



3. Select the image to be rated.





- Turn the <  > dial to select the image to be rated.

4. Rate the image.



- Press <  >, and a blue highlight frame will appear as shown in the screen shown above.
- Turn the <  > dial to select a rating mark, then press <  >.
- When you append a rating mark to the image, the number beside the set rating will increase by one.
- To rate another image, repeat steps 3 and 4.

Note

- By pressing the <  > button, you can also rate images during playback ().

Rating by Specifying the Range

While looking at the images in the index display, you can specify the first and last images for a range to rate all the specified images at once.

1. Select [Select range].

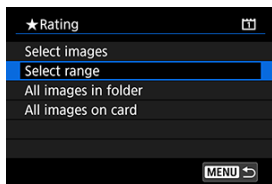

2. Specify the range of images.

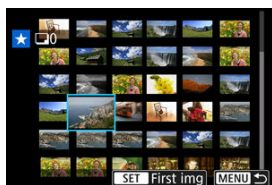

- Select the first image (start point).
- Next, select the last image (end point).
A checkmark [✓] will be appended to all the images within the range between first and last images.

3. Press the < [Q] > button.

4. Rate the images.



- Turn the <  > dial to select a rating mark, then select [OK]. All the images in the specified range will be rated (same rating) at once.

Rating All Images in a Folder or on a Card

You can rate all the images in a folder or on a card at once.

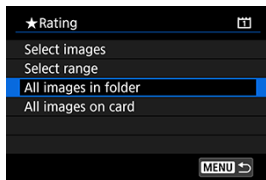

- Under **[▶]: Rating**, when you select **[All images in folder]** or **[All images on card]**, all the images in the folder or on the card will be rated.

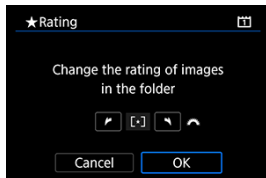

- Turn the **< [Sun] >** dial to select a rating, then select **[OK]**.
- When you are not rating images or canceling the rating, select **[OFF]**.
- If the search conditions are set with **[▶]: Set image search conditions** **[🔍]**, the display will change to **[All found images]**.

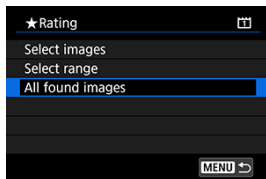

- If you select **[All found images]**, all the images filtered by the search conditions will be rated as specified.



Note

- Values next to ratings are displayed as [###] if more than 1,000 images have that rating.
- With [▶]: **Set image search conditions**] and [▶]: **Image jump w/🌅**], you can display only the images given a specific rating.

Slide Show

You can play back the images on the card as an automatic slide show.

1. Specify the images to be played back.

- To play back all the images on the card, go to step 2.
- If you want to specify the images to be played back in the slide show, filter the images with [▶]: **Set image search conditions** (🔍).

2. Select [▶]: **Slide show**.

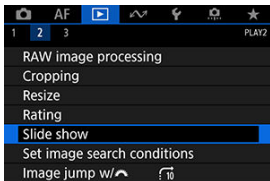

3. Set the playback as desired.

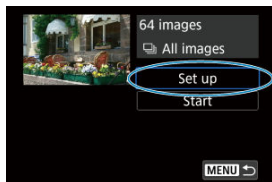

- Select [**Set up**].
- Set the [**Display time**] and [**Repeat**] (repeated playback) settings for the still photos.
- After completing the settings, press the <MENU> button.

Display time

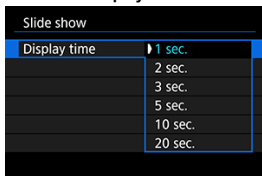

Repeat

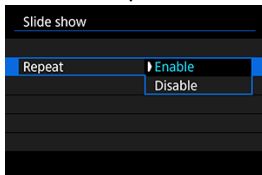

4. Start the slide show.

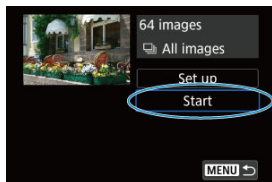







- Select [**Start**].
- After [**Loading image...**] is displayed, the slide show will start.

5. Exit the slide show.

- To exit the slide show and return to the setting screen, press the < **MENU** > button.

Note

- To pause the slide show, press <  >. During pause,  will be displayed in the upper left of the screen. Press <  > again to resume the slide show.
- During the automatic playback of still photos, you can press the < **INFO** > button to switch the display format ().
- During movie playback, you can adjust the sound volume by turning the <  > dial.
- During auto playback or when playback is paused, you can turn the <  > dial to view another image.
- During auto playback, auto power off will not take effect.
- The display time may differ depending on the image.

Setting Image Search Conditions

[Clearing the Search Conditions](#)

You can filter image display according to your search conditions. After setting the image search conditions, you can play back and display only the found images. You can also protect, rate, play a slide show, erase, and apply other operations to filtered images.

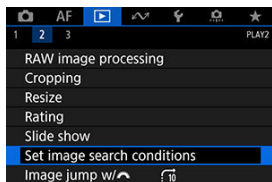

1. Select [: Set image search conditions].





2. Set the search conditions.





(1)

- Turn the <  > dial to select an item.
- Turn the <  > dial to set the option.
- A checkmark [✓] (1) is appended to the left of the item. (Specified as the search condition.)
- If you select the item and press the < INFO > button, the checkmark [✓] will be removed (which cancels the search condition).

Item	Description
★ Rating	Displays images with the selected (rating) condition.
☑ Date	Displays images taken on the selected shooting date.
■ Folder	Displays images in the selected folder.
🔒 Protect	Displays images with the selected (protect) condition.
 Type of file (1)	Displays images of the selected file type.
 Type of file (2)	

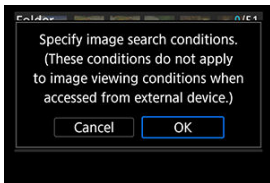
3. Apply the search conditions.



- Press <  > and read the message displayed.
- Select [**OK**].
The search condition is applied.

4. Display the found images.



(2)

- Press the <  > button.
Only the images that match the set conditions (filtered) will be played back.
When the images are filtered for display, the screen will have an outer yellow frame (2).

Caution

- If no images match the search conditions, <  > cannot be pressed in step 3.



Note

- Search conditions may be cleared after operations involving camera power or card changes and editing, adding, or erasing images.
- Auto power off time may be extended while the [▶]: **Set image search conditions**] screen is displayed.

Clearing the Search Conditions

Access the screen in step 2, then press the <  > button to clear all the search conditions.

Browsing Images with the Main Dial

In single-image display, you can turn the <  > dial to jump through the images forward or backward according to the jump method set.

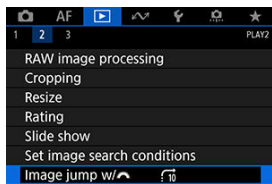

1. Select [: Image jump w/].

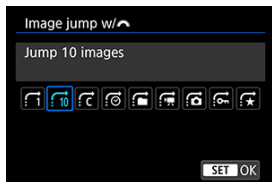

2. Select the jump method.





Note

- With [**Jump images by the specified number**], you can turn the <  > dial to select the number of images to jump by.
- When you select [**Display by image rating**], turn the <  > dial to specify the rating (). If you browse images with ★ selected, all the rated images will be displayed.

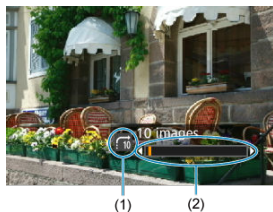
3. Browse by jumping.



- (1) Jump method
- (2) Playback position

- Press the <  > button.
- In single-image display, turn the <  > dial.
You can browse by the jump method set.

Customizing Playback Information Display

[Histogram](#)

You can specify screens and accompanying information displayed during image playback.

1. Select [: Playback information display].

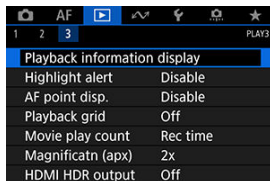

2. Add a checkmark [✓] next to the number of screens to display.

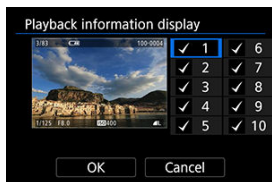

- Select numbers with the < > dial.
- Press < > to add a checkmark [✓].
- Repeat these steps to add a checkmark [✓] to the number of each screen to display, then select [OK].
- Your selected information can be accessed by pressing the < > button during playback, or by using < > when shooting information is displayed.

Histogram

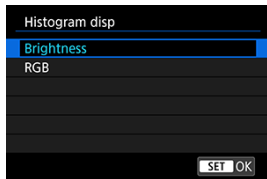

The histograms show signal levels across the tonal range. Brightness display (for checking the general exposure level and overall gradation) and RGB display (for checking saturation and gradation of red, green, and blue) are available. You can switch the histogram displayed by pressing the < > button when [INFO] is displayed in the lower left of the [▶]: **Playback information display** screen.

- **[Brightness] display**

This histogram is a graph showing the distribution of the image's brightness level, with the horizontal axis indicating the brightness level (darker on the left and brighter on the right) and the vertical axis indicating the pixel count at each brightness level. The more pixels there are toward the left, the darker the image, and the more pixels there are toward the right, the brighter the image. If there are too many pixels on the left, detail in shadows will be lost, and if there are too many pixels on the right, detail in highlights will be lost. The gradation in-between will be reproduced. By checking the image and its brightness histogram, you can see the exposure level inclination and the overall gradation.

Sample histograms



Dark image



Normal brightness



Bright image

- **[RGB] display**

This histogram is a graph showing the distribution of each primary color's brightness level in the image (RGB or red, green, and blue), with the horizontal axis indicating the color's brightness level (darker on the left and brighter on the right) and the vertical axis indicating the pixel count at each color brightness level. The more pixels there are toward the left, the darker and less prominent the color, and the more pixels there are toward the right, the brighter and denser the color. If there are too many pixels on the left, the corresponding color information will be lacking, and if there are too many pixels on the right, the color will be too saturated, without gradation. By checking the image's RGB histogram, you can see the color's saturation and gradation conditions, as well as the white balance bias.

Displaying the Highlight Alert

You can specify blinking display of overexposed highlights on the playback screen. To obtain more detailed gradation in the blinking areas where you want the gradation to be faithfully reproduced, set the exposure compensation to a negative amount and shoot again for a better result.

1. Select [: Highlight alert].

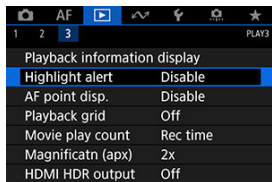

2. Select [Enable].

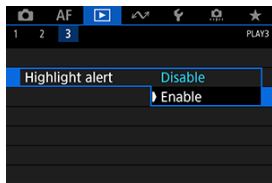

AF Point Display

You can display the AF points that were used to focus, which will be outlined in red on the playback screen. If automatic AF point selection is set, multiple AF points may be displayed.

1. Select [▶]: AF point disp.].

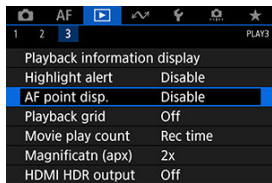

2. Select [Enable].

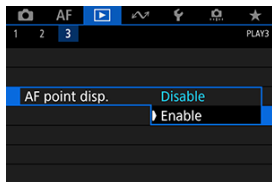

Playback Grid

You can display a grid over still photos shown in single-image display on the playback screen. This function is convenient for checking the image's vertical or horizontal tilt as well as composition.

1. Select [▶]: Playback grid].

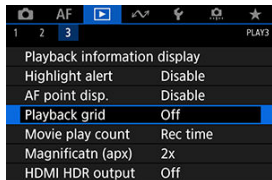

2. Select an item.

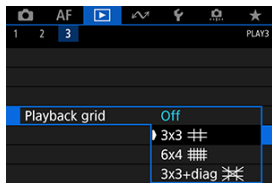

HDMI HDR Output

You can view RAW or HEIF images in HDR by connecting the camera to an HDR TV.

1. Select [▶]: HDMI HDR output].

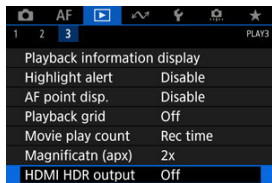

2. Select [On].

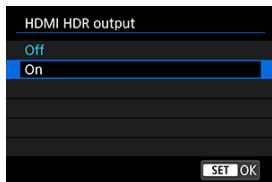

Caution

- HDR display in HDMI output is not available for RAW images captured with [HDR PQ settings] set to [Disable].

Note

- Make sure the HDR TV is set up for HDR input. For details on how to switch inputs on the TV, refer to the TV manual.
- Depending on the TV used, images may not look as expected.
- On HDR TVs, some information may not be displayed.
- Quick Control RAW processing of displayed images is recommended if you will process RAW images while viewing HDMI HDR output.

Communication Functions

This chapter describes how communication functions are used to connect the camera to a smartphone or computer over Wi-Fi or a wired LAN and send images, control the camera remotely, or perform other operations.

Caution

Important

- Note that Canon cannot be held liable for any loss or damage caused by erroneous network settings when using the camera. In addition, Canon cannot be held liable for any other loss or damage caused by use of the camera.
Take security measures that you deem necessary when using a network, at your discretion. Canon cannot be held liable for any loss or damage caused by unauthorized access or other security breaches.

- [Tab Menus: Communication Functions Tab](#)
- [Available Communication Functions](#)
- [Camera Connect Communication from Smartphones](#)
- [Wi-Fi Connections with a Computer Using EOS Utility](#)
- [Basic Communication Settings](#)
- [Image Transfer to FTP Servers](#)
- [Remote Control \(EOS Utility\)](#)
- [Controlling the Camera with Browser Remote](#)
- [Ending Connections or Reconnecting](#)
- [Checking and Editing Network Settings](#)
- [Syncing Time Between Cameras](#)
- [GPS Features](#)
- [Reference](#)
- [Troubleshooting](#)
- [Resetting Communication Settings](#)

Tab Menus: Communication Functions Tab

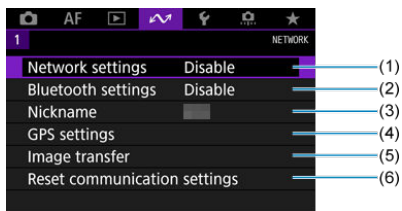

- (1) [Network settings](#)
- (2) [Bluetooth settings](#)
- (3) [Nickname](#)
- (4) [GPS settings](#)
- (5) [Image transfer](#)
- (6) [Reset communication settings](#)

⚠ Caution

- Wi-Fi connections are not possible while the camera is connected to a computer or other device via an interface cable.
- Other devices, such as computers, cannot be used with the camera by connecting them with an interface cable while the camera is connected to devices via Wi-Fi.
- Network connections are terminated if you switch camera to < OFF > or open the card slot cover.
- Auto power off is not activated while connected to a network.

Available Communication Functions

Smartphone (🔗)

Using the dedicated Camera Connect app on smartphones or tablets (hereafter, collectively referred to as “smartphones”), you can browse images on the camera, shoot remotely, and perform other operations. After pairing the camera with a smartphone supporting Bluetooth low energy technology (hereafter, “Bluetooth”), you only need to use the smartphone to connect via Wi-Fi.

EOS Utility

Using EOS Utility (EOS software installed on a computer), you can import images from the camera, shoot remotely, and perform other operations.

- See [Wi-Fi Connections with a Computer Using EOS Utility](#) for instructions on joining a Wi-Fi network via an access point compatible with WPS (PBC mode) to connect the camera to a computer.
- See instructions starting with [Basic Communication Settings](#) for other ways to connect the camera to a computer wirelessly or over a wired LAN connection.

FTP transfer (🔗)

Your shots can be transferred to an FTP server.

Besides automatically transferring images as you shoot, you can manually select and transfer images later.

Browser Remote (🔗)

From a computer or smartphone browser, connecting to the camera is like accessing a webpage, and you can shoot remotely, browse camera images, or configure FTP transfer settings.

Syncing time between cameras (🔗)

The time on multiple EOS-1D X Mark III cameras can be synchronized over a wired LAN connection.

Wireless File Transmitter

By attaching an optional Wireless File Transmitter WFT-E9, you can use wireless LAN features. For details, refer to the WFT-E9 Instruction Manual.

Note that Camera Connect cannot be used to access the camera from smartphones over a wireless LAN connection established by WFT-E9.

GPS (🔗)

Built-in GPS features can be used to geotag images, log routes traveled with the camera, and more.

Available communication functions and connection methods (besides GPS)

Available Features	Connection Method		
	Wired LAN	Wi-Fi (Built-In)	Wireless LAN (Wireless File Transmitter WFT-E9)
Camera Connect communication from smartphones		○	
Using EOS Utility	○	○	○
Image transfer to FTP servers	○	○	○
Using Browser Remote	○		○
Syncing time between cameras	○		○

Camera Connect Communication from Smartphones

- [✔ Connecting to a Bluetooth-compatible Smartphone via Wi-Fi](#)
- [✔ Camera Connect Functions](#)
- [✔ Canceling the Pairing](#)
- [✔ Wi-Fi Connection Without Using Bluetooth](#)
- [✔ Automatic Image Transfer as You Shoot](#)
- [✔ Sending Images to a Smartphone from the Camera](#)
- [✔ Settings to Make Images Viewable from Smartphones](#)
- [✔ General Precautions on Camera Connect Communication from Smartphones](#)

By using the dedicated Camera Connect app installed on a smartphone or tablet (collectively referred to hereafter as "smartphones"), you can pair the camera and smartphone via Bluetooth or establish a Wi-Fi connection between the devices.

Features available over a Bluetooth connection

- You can establish a Wi-Fi connection using only a smartphone.
- You can shoot still photos or record movies by using your smartphone as a remote control.

Features available over a Wi-Fi connection

- You can use a smartphone to browse images on the camera and save them to the smartphone.
- You can control the camera remotely from a smartphone.
- You can use the camera to send images to a smartphone.
- The dedicated app Camera Connect (free of charge) must be installed on the smartphone on which Android or iOS is installed. Camera Connect can be installed from Google Play or App Store.

Caution

- Use the latest version of the smartphone OS.

 **Note**

- You can also access Google Play or App Store from QR codes displayed when you pair the smartphone and camera.
- For the operating system versions supported by Camera Connect, refer to the download site of Camera Connect.
- Sample screens and other details in this guide may not match the actual user interface elements after camera firmware updates or updates to Camera Connect, Android, or iOS.

Connecting to a Bluetooth-compatible Smartphone via Wi-Fi

These instructions describe how to establish a Wi-Fi connection with a Bluetooth enabled smartphone and use Camera Connect to control the camera.

 **Caution**

- Bluetooth pairing with a smartphone is not possible while the camera is connected to other devices via Wi-Fi or connected to a wireless LAN by means of a WFT. End the Wi-Fi or wireless LAN connection by selecting [**Connection settings**] in [**Network settings**], then selecting [**Disconnect**].

Steps on the smartphone (1)

Turn on Bluetooth and Wi-Fi from the smartphone settings screen. Note that pairing with the camera is not possible from the smartphone's Bluetooth settings screen.

Steps on the camera (1)

1. On the camera, press the <MENU> button.

2. Select [**W**]: Network settings].

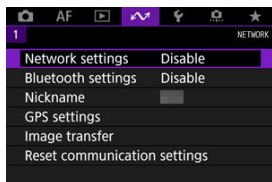

3. Select [Enable].

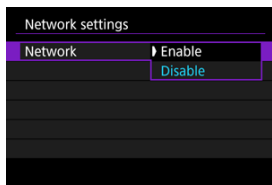

4. Select [Bluetooth settings].

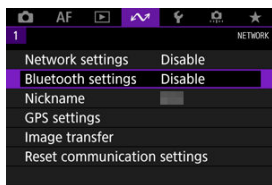

5. Set [Bluetooth] to [Enable].

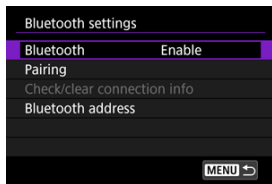

6. Select [Pairing].

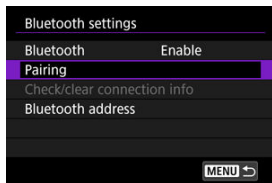

7. Select an option.

- If Camera Connect is already installed, select [**Do not display**].
- If Camera Connect is not installed, select [**Android**] or [**iOS**], scan the displayed QR code with the smartphone to access Google Play or App Store and install Camera Connect.

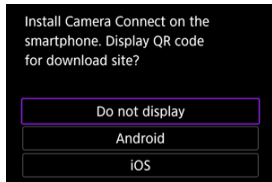

Steps on the smartphone (2)

8. Start Camera Connect.



9. Tap the camera for pairing.

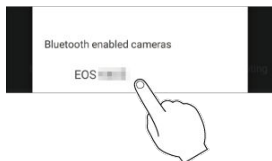

- If you are using an Android smartphone, go to step 11.

10. Tap [Pair] (iOS only).

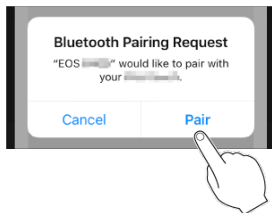

Steps on the camera (2)

11. Select [OK].



12. Press the <SET> button.



- Pairing is now complete, and the camera is connected to the smartphone via Bluetooth.
- A Bluetooth icon appears on the main Camera Connect screen.

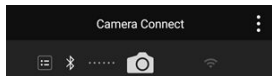

! Caution

- Bluetooth connection consumes battery power even after the camera's auto power off is activated. Therefore, the battery level may be low when you use the camera.
- The camera can be paired with one smartphone. Before pairing with a different smartphone, clear the information about the currently paired smartphone (🗑).
- Keeping pairing records for previously paired cameras on your smartphone will prevent it from pairing with this camera. Before you try pairing again, remove pairing records for previously paired cameras from your smartphone's Bluetooth settings screen.



Note

- When paired via Bluetooth, tap [**Bluetooth remote controller**] in Camera Connect to control the camera remotely from the smartphone.
- From an Android device, you can control the camera to send images to the smartphone (📷).

Steps on the smartphone (3)

13. Tap a Camera Connect function.

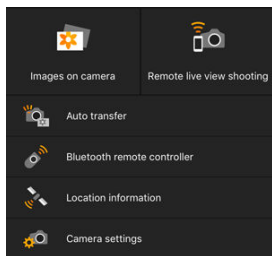

- In iOS, tap **[Join]** when a message is displayed to confirm camera connection.
- After the devices are connected via Wi-Fi, a screen for the selected function is displayed on the smartphone.
- The Bluetooth and Wi-Fi icons are now displayed on the main Camera Connect screen, after you return to that screen.

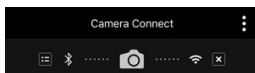

- The camera's <LAN> lamp is lit in green.

Terminating Wi-Fi connections

- Disconnect by tapping **[X]** on the Camera Connect screen.

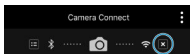

- Terminating the Wi-Fi connection will switch the camera to the Bluetooth connection.

Reconnecting

- To reconnect via Wi-Fi, start Camera Connect and tap the function you will use.

Images on camera

- Images can be browsed, deleted, or rated.
- Images can be saved on a smartphone.

Remote live view shooting

- Enables remote shooting as you view a live image on the smartphone.

Auto transfer

- Enables camera and app setting adjustment for automatic transfer of your shots (📷).

Bluetooth remote controller

- Enables remote control of the camera from a smartphone paired via Bluetooth. (Not available when connected via Wi-Fi.)
- Auto power off is disabled while you are using the Bluetooth remote controller feature.

Location information

- Not supported on this camera.

Camera settings

- Camera settings can be changed.

Canceling the Pairing

Cancel pairing with a smartphone as follows.

1. Select [Check/clear connection info].

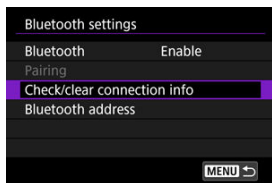

2. Press the <INFO> button.

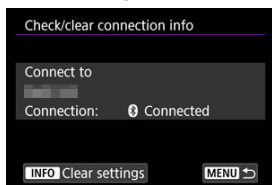

3. Select [OK].

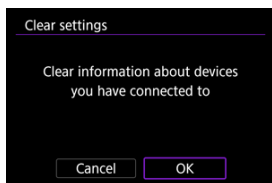

4. Clear the camera information on the smartphone.

- In the smartphone's Bluetooth setting menu, clear the camera information registered on the smartphone.



Note

- To check the camera's Bluetooth address, select **[Bluetooth address]**.

Wi-Fi Connection Without Using Bluetooth

These instructions describe how to establish a direct Wi-Fi connection with a smartphone and use Camera Connect to control the camera.

Steps on the camera (1)

1. On the camera, press the <MENU> button.

2. Select [NETWORK: Network settings].

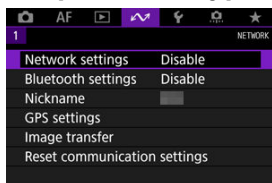

3. Select [Enable].

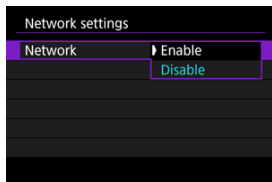

4. Select [Connection settings].

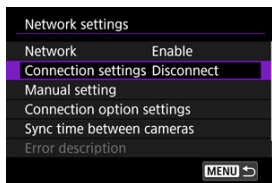

5. Select [SET* Unspecified].

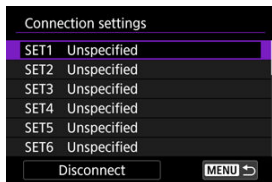

6. Select [Create with wizard].

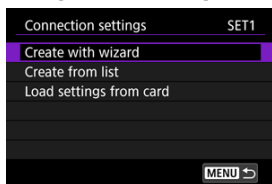

7. Select [Configure online].

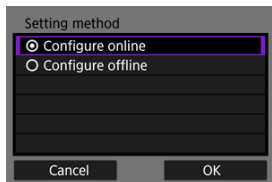

- Select [OK].

8. Select [Smartphone].

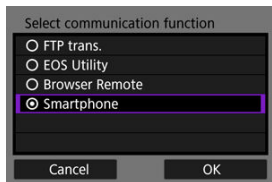

- Select [OK].

9. Press the <SET> button.

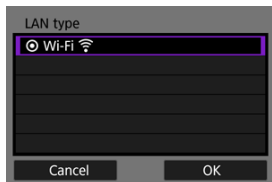

- Select [OK].

10. Select [New settings].

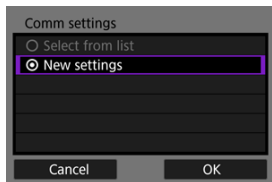

- Select [OK].

11. Select [Camera access point mode].

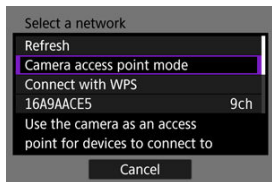

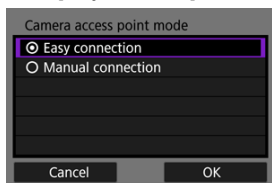

12. Select [Easy connection].

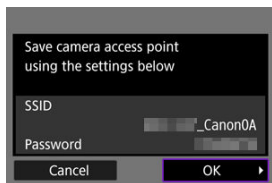

- Select [OK].

13. Select [OK].



14. Press the <  > button.

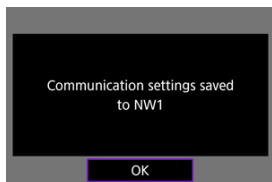

15. Select [New settings].

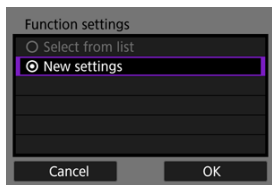

- Select [OK].

16. Check the SSID (network name) and password.

- Check the SSID (1) and password (2) displayed on the camera screen.

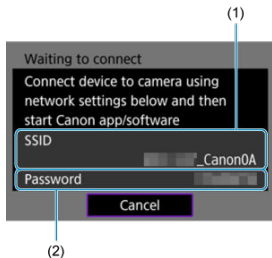

Steps on the smartphone

17. Operate the smartphone to establish a Wi-Fi connection.

- Activate the smartphone's Wi-Fi function, then tap the SSID (network name) you checked in step 16.
- In the password field, enter the password you checked in step 16, then tap [Join].

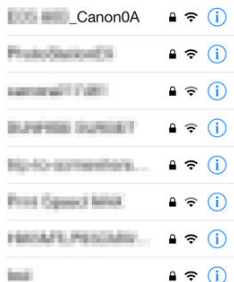

18. Start Camera Connect and tap the camera to connect to via Wi-Fi.

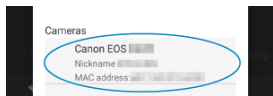

Steps on the camera (2)

19. Select [OK].

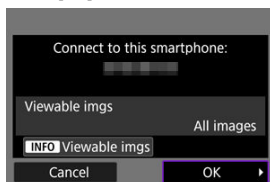

- To specify viewable images, press the <INFO> button. For details on conditions that enable image viewing, see [Settings to Make Images Viewable from Smartphones](#).

20. Press <SET>.

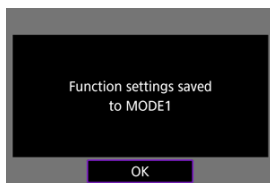

21. Press <SET>.

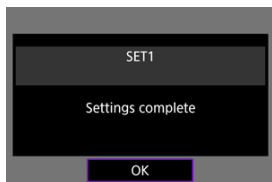

- The main window of Camera Connect will be displayed on the smartphone.
- The camera's <LAN> lamp is lit in green.
The Wi-Fi connection to a smartphone is now complete.

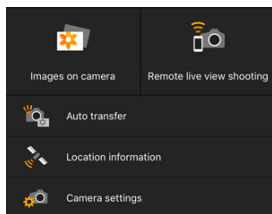

- Operate the camera using Camera Connect (🔗).
- When connected via Wi-Fi, you can send images to a smartphone from the Quick Control screen during playback (🔗).

Terminating Wi-Fi connections (🔗)

Reconnecting (🔗)

Automatic Image Transfer as You Shoot

Your shots can be automatically sent to a smartphone. Before following these steps, make sure the camera and smartphone are connected via Wi-Fi.

1. Select [: Network settings].

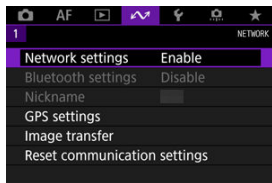

2. Select [Connection option settings].

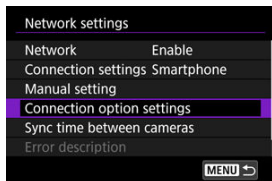

3. Select [Smartphone settings].

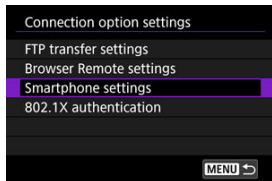

4. Set [Auto send] to [Enable].

- If necessary, specify [Size to send].

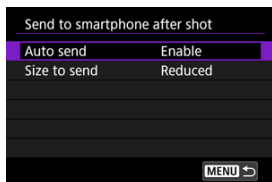

Sending Images to a Smartphone from the Camera

You can use the camera to send images to a smartphone paired via Bluetooth (Android devices only) or connected via Wi-Fi.

1. Switch to playback.



2. Press the < Q > button.

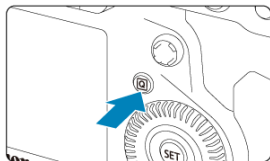

3. Select [Send images to smartphone].

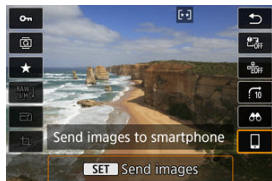





- If you perform this step while connected via Bluetooth, a message is displayed, and the connection switches to a Wi-Fi connection.

4. Select sending options and send the images.

Sending images individually

1. Select an image to send.



- Turn the <  > dial to select an image to send, then press <  >.
- You can press the <  > button and turn the <  > dial counterclockwise to select the image using the index display.

2. Select [Send img shown].



- In [**Size to send**], you can select the image sending size.

Sending multiple selected images

1. Press < >.



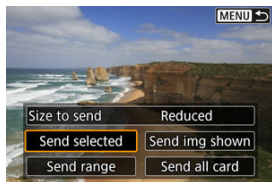

2. Select [Send selected].



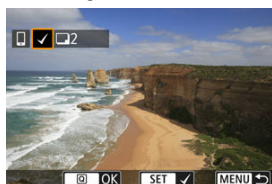



3. Select images to send.

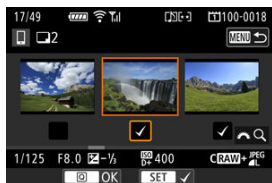

- Turn the <  > dial to select images to send, then press <  >.



- To switch to three-image display for image selection, press the <  > button and turn the <  > dial counterclockwise. To return to the single-image display, press the <  > button.
- After selecting the images to send, press the <  > button.

4. Select [Size to send].

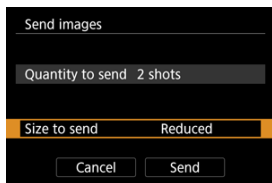

- On the displayed screen, select an image size.

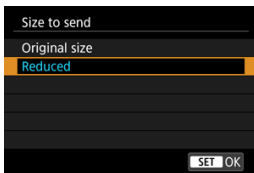

5. Select [Send].

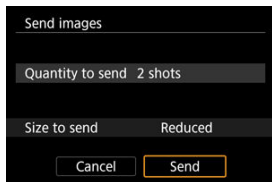

Sending a specified range of images

1. Press < **SET** >.



2. Select [Send range].

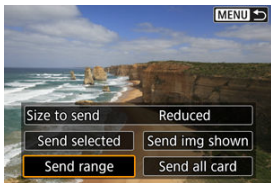

3. Specify the range of images.

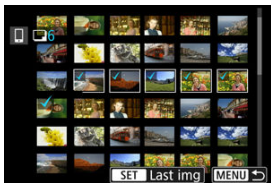

- Select the first image (start point).
- Select the last image (end point).
- To cancel the selection, repeat this step.
- To change the number of images in index display, press the < **Q** > button, then turn the < **Q** > dial.

4. Confirm the range.

- Press the < [Q] > button.

5. Select [Size to send].

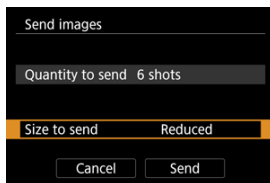

- On the displayed screen, select an image size.

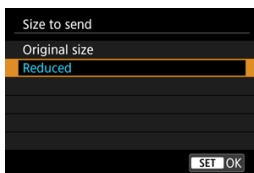

6. Select [Send].

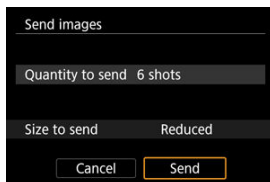

Sending all images on the card

1. Press <SET>.



2. Select [Send all card].

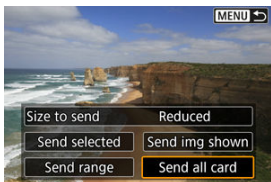

3. Select [Size to send].

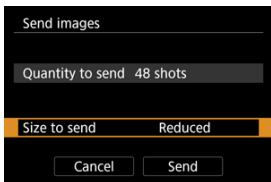

- On the displayed screen, select an image size.

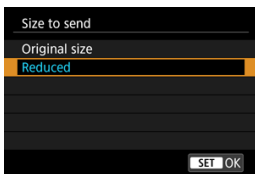

4. Select [Send].

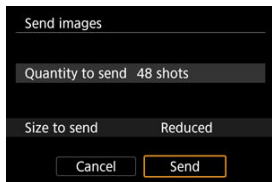

Sending images that match the search conditions

Send all the images that match the search conditions set in [Set image search conditions] at once. For details on [Set image search conditions], see [Setting Image Search Conditions](#).

1. Press <SET>.



2. Select [Send all found].

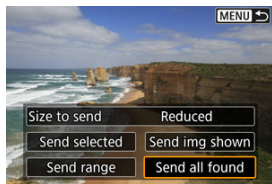

3. Select [Size to send].

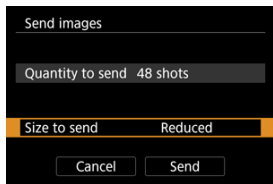

- On the displayed screen, select an image size.

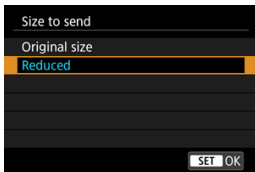

4. Select [Send].

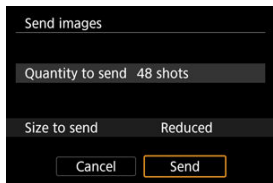

Ending image transfer (🔒)

⚠ Caution

- During the image transfer operation, a picture cannot be taken even if the camera's shutter button is pressed.



Note

- You can cancel the image transfer by selecting **[Cancel]** during the transfer.
- You can select up to 999 files at a time.
- With a Wi-Fi connection established, disabling the smartphone's power saving function is recommended.
- Selecting the reduced size for still photos applies to all still photos sent at that time. Note that **S** size still photos are not reduced.
- When you use a battery to power the camera, make sure it is fully charged.

Settings to Make Images Viewable from Smartphones

Images can be specified after the Wi-Fi connection is terminated.

1. Select [Network settings].

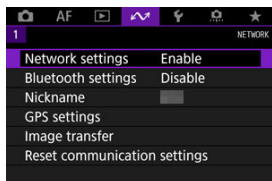

2. Select [Manual setting].

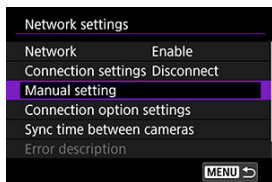

3. Select [Function settings].

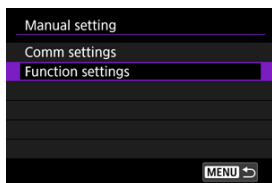

4. Select [Smartphone].

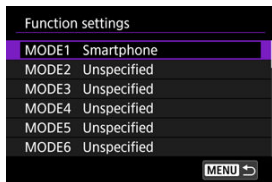

5. Select [Change].

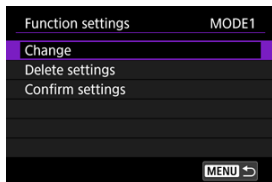

6. Select [Viewable imgs].

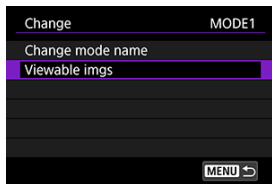

7. Select an option.

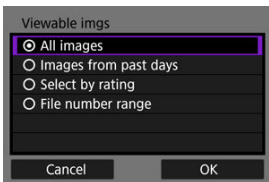

- Select **[OK]** to access the setting screen.

[All images]

All images stored on the card become viewable.

[Images from past days]

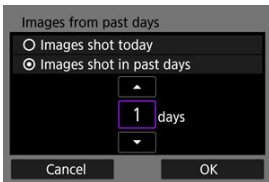

Specify viewable images on the shooting-date basis. Images shot up to nine days ago can be specified.

- When **[Images shot in past days]** is selected, images shot up to the specified number of days before the current date become viewable. Use the **<▲>** **<▼>** keys to specify the number of days, then press **<SET>** to confirm the selection.
- Once you select **[OK]**, the viewable images are set.

! Caution

- If **[Viewable imgs]** is set to any setting other than **[All images]**, remote shooting is not possible.

[Select by rating]

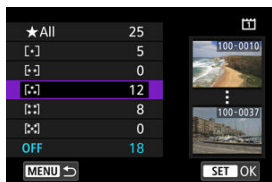

Specify viewable images depending on whether a rating is appended (or not appended) or by the type of rating.

- Once you select the type of rating, the viewable images are set.

[File number range] (Select range)

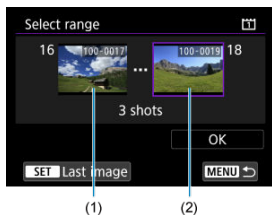



Select the first and last images from images arranged by the file number to specify the viewable images.

1. Press $\langle \text{SET} \rangle$ to display the image selection screen.
Use the $\langle \text{DIAL} \rangle$ dial to select images.
You can press the $\langle \text{Q} \rangle$ button and turn the $\langle \text{DIAL} \rangle$ dial counterclockwise to select the image using the index display.
2. Select an image as the starting point (1).
3. Use the $\langle \text{DIAL} \rangle$ dial to select an image as the ending point (2).
4. Select [OK].

General Precautions on Camera Connect Communication from Smartphones

Caution

- If the Wi-Fi connection is terminated while recording a movie with remote shooting, the following will occur.
 - If the Live View shooting/Movie shooting switch is set to <  >, movie recording will continue.
 - If the Live View shooting/Movie shooting switch is set to <  >, movie recording will stop.
- With a Wi-Fi connection to a smartphone established, certain functions are unavailable.
- In remote shooting, the AF speed may become slower.
- Depending on the communication status, image display or shutter release timing may be delayed.
- When saving images to a smartphone, you cannot take a picture even if you press the camera's shutter button. Also, the camera screen may turn off.

Note

- With a Wi-Fi connection established, disabling the smartphone's power saving function is recommended.

Wi-Fi Connections with a Computer Using EOS Utility

[Connecting to a Computer via Wi-Fi](#)

Using EOS Utility, you can browse images on the camera and save them to the computer. Also in EOS Utility, you can shoot by controlling the camera remotely and change camera settings.

- Install EOS Utility on the computer before connecting via Wi-Fi ().

Connecting to a Computer via Wi-Fi

This section describes how to prepare for camera operations in EOS Utility by connecting the camera and a computer via Wi-Fi using a WPS (PBC mode) compatible access point.

- First, check the position of the WPS button and how long to press it.
- It may take approx. 1 min. to establish a Wi-Fi connection.
- For computer operating instructions, refer to the computer user manual.
- See the instructions starting in [Basic Communication Settings](#) for details on connecting the camera to a wired LAN or using non-WPS (PBC mode) access points.

Steps on the camera (1)

1. On the camera, press the <MENU> button.
2. Select []: Network settings].

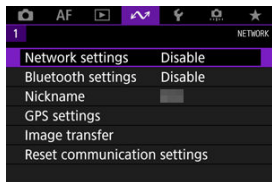

3. Select [Enable].

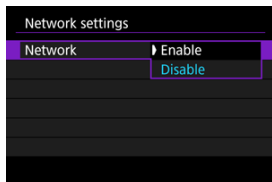

4. Select [Connection settings].

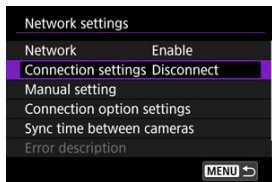

5. Select [SET* Unspecified].

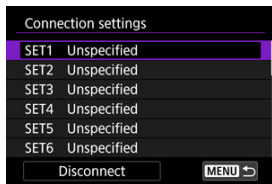

6. Select [Create with wizard].

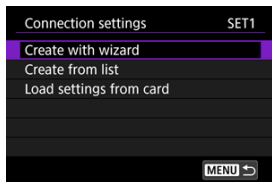

7. Select [Configure online].

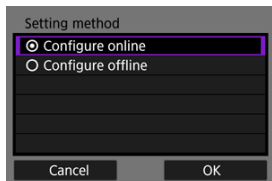

- Select [OK].

8. Select [EOS Utility].

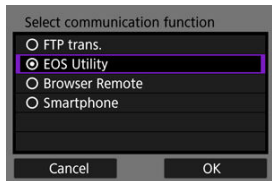

- Select [OK].

9. Select [Wi-Fi].

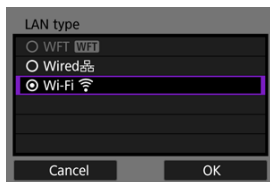

- Select [OK].

10. Select [New settings].

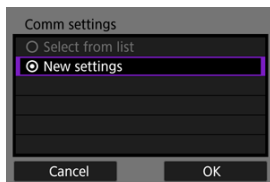

- Select [OK].

11. Select [Connect with WPS].

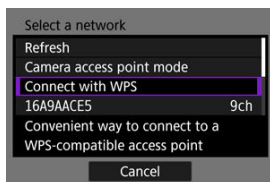

12. Select [WPS (PBC mode)].

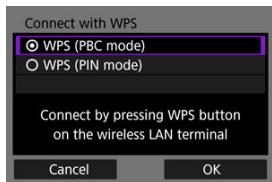

- Select [OK].

Steps on the access point

13. Connect to the access point via Wi-Fi.

- Press the access point's WPS button.

Steps on the camera (2)

14. Select [OK].

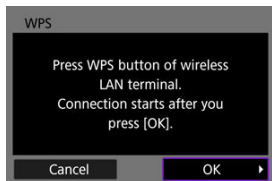

15. Select [Auto setting].

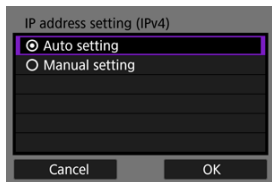

- Select [OK].

16. Select [Disable].

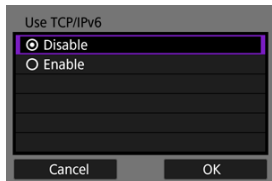

- Select [OK].

17. Press <  >.

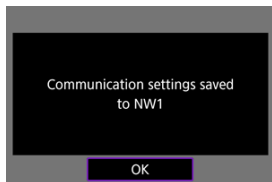

18. Select [New settings].

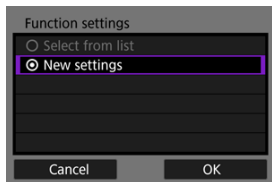

- Select [OK].

For details on subsequent operations, see [Configuring EOS Utility Connection Settings](#).

Terminating Wi-Fi connections (🔗)

Reconnecting (🔗)

Basic Communication Settings

- [Preparation](#)
- [Displaying the Connection Wizard](#)
- [Checking the Type of Access Point](#)
- [Connecting via WPS \(PBC Mode\)](#)
- [Connecting via WPS \(PIN Mode\)](#)
- [Connecting Manually to Detected Networks](#)
- [Connecting Manually by Specifying Networks](#)
- [Connecting in Infrastructure Mode](#)
- [Connecting in Camera Access Point Mode](#)
- [Setting the IP Address](#)
- [Configuring Communication Function Settings](#)

Before using the following camera communication functions, configure camera and computer settings as described starting in the preparation section.

- Image transfer to FTP servers
- Remote control (EOS Utility)
- Controlling the camera with Browser Remote

Caution

- Regarding settings for multiple networks, only infrastructure settings are available when you connect wirelessly. Multiple network settings are not available for wired LAN or camera access point settings.

Preparation

● [FTP trans.]

A computer running one of the following OSes is required. The computer must also be set up in advance to function as an FTP server.

- Windows 10 (ver. 1607 or later)
- Windows 8.1, Windows 8.1 Pro
- Windows 7 (Professional/Enterprise/Ultimate for 32/64-bit systems, SP1 or later)

For instructions on setting up the computer to function as an FTP server, refer to documentation for your computer.

Note that FTP transfer is not possible with the following OS, which does not include FTP server functionality.

- Windows 7 Home Premium

● [EOS Utility]

A computer with EOS Utility (EOS software) installed is required. For EOS Utility installation instructions, visit the Canon website.

● [Browser Remote]

Use of [Browser Remote] requires a computer with one of the following browsers installed.

- iOS13 : Safari 13
- iPadOS13 : Safari 13
- Android 8, 9, 10 : Chrome
- macOS : Safari 13
- Windows 10 : Chrome
- Windows 10 : Edge

* Operation in these browsers is not ensured on all computers.

* Cannot be used unless cookies are enabled in the browser.

* Cannot be used unless JavaScript is enabled in the browser.

* Movie playback is not available unless the browser supports HTML5.

● Sync time between cameras

See [Syncing Time Between Cameras.](#)

● GPS

See [GPS Features.](#)

When connecting via Wi-Fi

Connect the computer for the Wi-Fi connection to the access point in advance.

Caution

Transferring movies

- Each movie file is large, and transferring large files over Wi-Fi may take some time. Referring to [Communication Function Precautions](#), arrange your network environment for stable communication between devices and the access point.

When connecting via wired LAN

Before using the following features over a wired LAN connection, connect a LAN cable to the Ethernet terminal of the camera and the computer or access point.

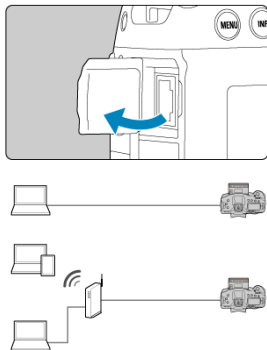

- Image transfer to FTP servers
- Using EOS Utility
- Using Browser Remote

Use a highly shielded Category 5e or higher STP (Shielded Twisted Pair) Gigabit Ethernet cable.



Displaying the Connection Wizard

This section describes the process of following the connection wizard instructions to add connection settings. If an error is displayed, see [Troubleshooting](#) and check the settings.

- Be careful not to press the shutter button or other controls (which will close the connection wizard) until configuration is complete.
- [: **Network settings**] is only available when [: **Multiple exposure**] is set to **[Disable]**.

1. On the camera, press the <MENU> button.

2. Select [: **Network settings**].

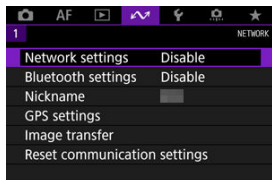

3. Select **[Enable]**.

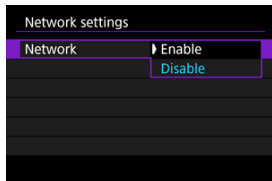

4. Select [Connection settings].

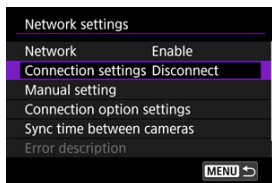

5. Select [SET*].

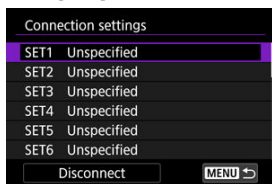

6. Select [Create with wizard].

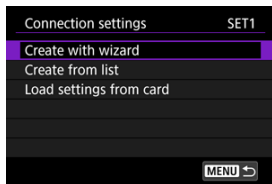

- Selecting [**Create from list**] when multiple communication and function settings are registered on the camera enables you to combine registered settings to add new connection settings.
- You can also add new connection settings by using connection settings saved to a card. Configure settings this way by selecting [**Load settings from card**] (🔗).

7. Select a setting method.

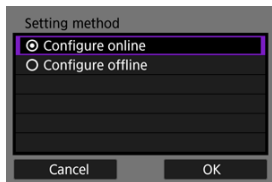

- Select an option and then **[OK]** to go to the next screen.
- Select **[Configure online]** to configure connection settings and then join the network.
- Select **[Configure offline]** if you only wish to configure **[FTP trans.]** and **[Browser Remote]** connection settings.

8. Select a communication function.

[Configure online] options

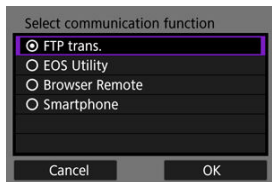

[Configure offline] options

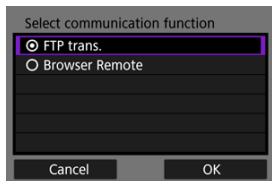

- Referring to [Preparation](#), select a communication function.
- Select an option and then **[OK]** to go to the next screen.

9. Select an item.

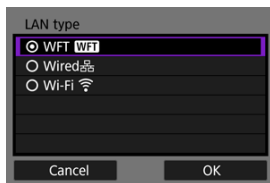

- The options displayed vary depending on the [**Select communication function**] setting.
- Select [**OK**].

10. Select [**New settings**].

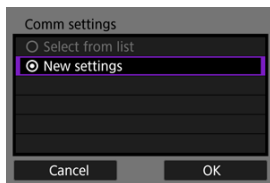

- Select [**OK**].
- By selecting [**Select from list**] when communication settings are already registered on the camera, you can apply the registered settings.

[Configure online] options

If you selected **[Wired]** in step 9, configure the setting as follows.

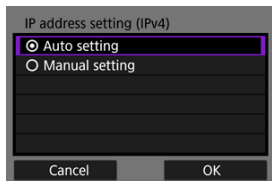

- Select an option, then select **[OK]**.
- For details on IP address settings, see [Setting the IP Address](#).

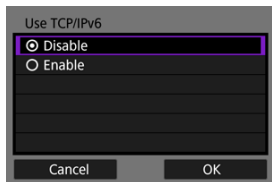

- Select an option, then select **[OK]**.
- For details on IPv6 address settings, see [Setting the IP Address](#).

If you selected **[Wi-Fi]** in step 9, configure the setting as follows.

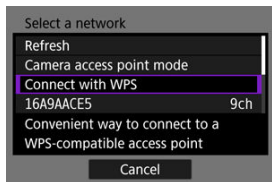

- For details on connections with other devices via an access point, see [Checking the Type of Access Point](#).
- For details on direct connections with other devices, see [Connecting in Camera Access Point Mode](#).

[Configure offline] options

If you selected **[Wired]** in step 9, configure the setting as follows.

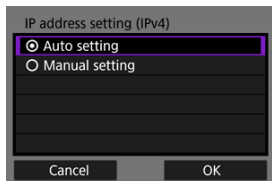

- Select an option, then select **[OK]**.
- For details on IP address settings, see [Setting the IP Address](#).

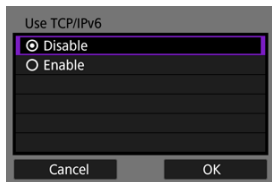

- Select an option, then select **[OK]**.
- For details on IPv6 address settings, see [Setting the IP Address](#).

If you selected **[Wi-Fi]** in step 9, configure the setting as follows.

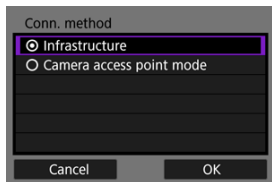

- For details on Wi-Fi connections with other devices via an access point, see [Connecting in Infrastructure Mode](#).
- For details on direct Wi-Fi connections with other devices, see [Connecting in Camera Access Point Mode](#).

Checking the Type of Access Point



When connecting via an access point, check whether the access point supports WPS*, which simplifies connections between Wi-Fi devices.

If you are unsure about WPS compatibility, refer to the access point user manual or other documentation.



* Stands for Wi-Fi Protected Setup.

● When WPS is supported

Two connection methods are available, as follows. You can connect more easily via WPS in PBC mode.

- Connecting via WPS (PBC Mode) 
- Connecting via WPS (PIN Mode) 

● When WPS is not supported

- Connecting manually to detected networks 
- Connecting manually by specifying networks 

Access point encryption

The camera supports the following options for **[Authentication]** and **[Encryption settings]**. For this reason, the encryption used by the access point must be set to one of the following when you will connect to detected networks manually.

- **[Authentication]**: Open system, shared key, or WPA/WPA2-PSK
- **[Encryption settings]**: WEP, TKIP, or AES

Caution

- **Connections may not be possible when access point stealth functions are enabled. Deactivate stealth functions.**
- Ask any network administrator in charge of networks you will join for setting details.

Note

- If MAC address filtering is used on networks you will join, add the camera's MAC address to the access point. The MAC address can be checked on the **[MAC address]** screen .

Connecting via WPS (PBC Mode)

Instructions in this section are continued from [Checking the Type of Access Point](#).

This is a connection method used with access points compatible with WPS. In pushbutton connection mode (PBC mode), the camera and access point can be connected simply by pressing the WPS button on the access point.

- Connecting may be more difficult if multiple access points are active nearby. If so, try to connect with **[WPS (PIN mode)]**.
- Check the position of the WPS button on the access point in advance.
- It may take approx. 1 min. to establish a connection.

1. Select **[Connect with WPS]**.

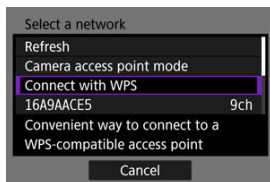

2. Select **[WPS (PBC mode)]**.

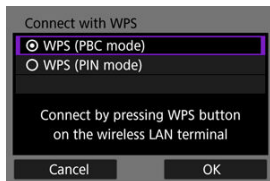

- Select **[OK]**.

3. Connect to the access point.

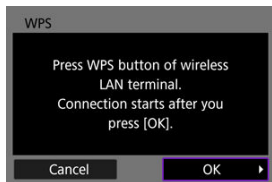

- Press the access point's WPS button. For details on where the button is and how long to press it, refer to the access point user manual.
- Select **[OK]** to initiate connection with the access point.
- The following screen is displayed once the camera is connected to the access point.

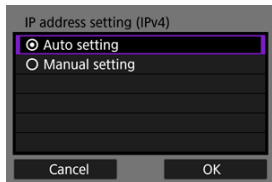

Go to [Setting the IP Address](#).

Connecting via WPS (PIN Mode)

Instructions in this section are continued from [Checking the Type of Access Point](#).

This is a connection method used with access points compatible with WPS. In PIN code connection mode (PIN mode), an 8-digit identification number indicated on the camera is entered on the access point to establish a connection.

- Even if multiple access points are active nearby, connecting by using this shared identification number is relatively reliable.
- It may take approx. 1 min. to establish a connection.

1. Select [Connect with WPS].

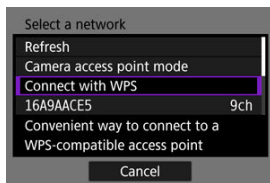

2. Select [WPS (PIN mode)].

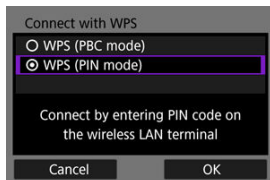

- Select [OK].

3. Enter the PIN code.

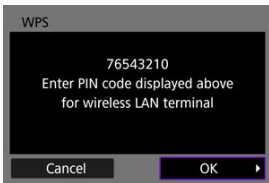

- On the access point, enter the 8-digit PIN code displayed on the camera screen.
- For instructions on entering PIN codes on the access point, refer to the access point's Instruction Manual.
- After entering the PIN code, select **[OK]** on the camera.

4. Connect to the access point.

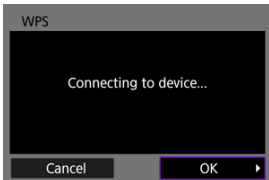

- Select **[OK]** to initiate connection with the access point.
- The following screen is displayed once the camera is connected to the access point.

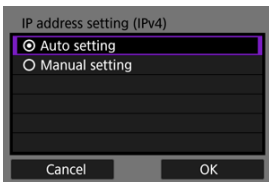

Go to [Setting the IP Address](#).

Connecting Manually to Detected Networks

Instructions in this section are continued from [Checking the Type of Access Point](#).

Connect to an access point by selecting its SSID (or ESS-ID) in a list of active access points nearby.

Selecting the access point

1. Select an access point.

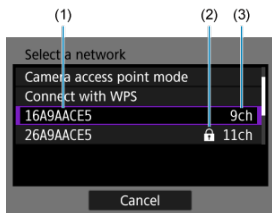

(1) SSID

(2) Security icon (only for encrypted access points)

(3) Channel used

- Turn the <  > dial to select the access point to connect to in the list of access points.

Note

[Refresh]

- To display **[Refresh]**, scroll down the screen in step 1.
- Select **[Refresh]** to search for access points again.

Entering the access point encryption key

- Enter the encryption key (password) set on the access point. For details on the encryption key that has been set, refer to the access point's user manual.
- The screens displayed in steps 2–3 vary depending on the authentication and encryption set on the access point.
- Go to [Setting the IP Address](#) if the **[IP address set.]** screen is displayed instead of the screens shown for steps 2–3.

2. Select a key index.

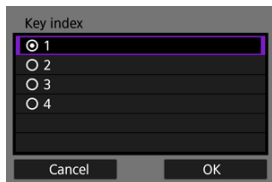

- The **[Key index]** screen is displayed for WEP-encrypted access points.
- Select the key index number set on the access point.
- Select **[OK]**.

3. Enter the encryption key.

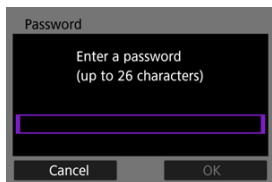

- Press < **SET** > to access the virtual keyboard (), then enter the encryption key.
- Select **[OK]** to initiate connection with the access point.
- The following screen is displayed once the camera is connected to the access point.

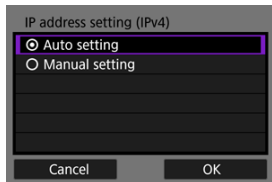

Go to [Setting the IP Address](#).

Connecting Manually by Specifying Networks

Instructions in this section are continued from [Checking the Type of Access Point](#). Connect to an access point by entering its SSID (or ESS-ID).

Entering the SSID

1. Select [Manual settings].

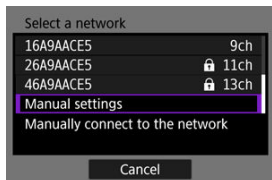

2. Enter the SSID (network name).

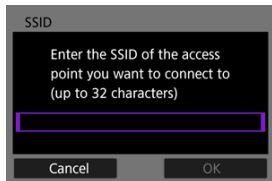

- Press <SET> to access the virtual keyboard (⌨), then enter the encryption key.
- Select [OK].

3. Select the authentication method.

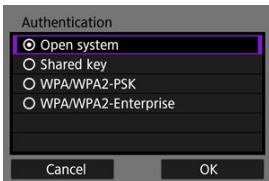

- Select an option and then **[OK]** to go to the next screen.
- On the **[Encryption settings]** screen displayed if **[Open system]** is selected, select **[Disable]** or **[WEP]**.

Entering the access point encryption key

- Enter the encryption key (password) set on the access point. For details on the password that has been set, refer to the access point's user manual.
- The screens displayed in steps 4–5 vary depending on the authentication and encryption set on the access point.
- Go to [Setting the IP Address](#) if the **[IP address set.]** screen is displayed instead of the screens shown for steps 4–5.

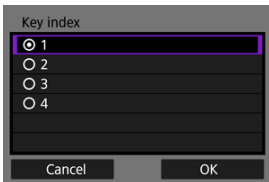

4. Select a key index.

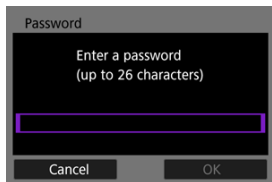

- The **[Key index]** screen is displayed if you have selected **[Shared Key]** or **[WEP]** in step 3.
- Select the key index number set on the access point.
- Select **[OK]**.

5. Enter the encryption key.



- Press <  > to access the virtual keyboard (), then enter the encryption key.
- Select [**OK**] to initiate connection with the access point.
- The following screen is displayed once the camera is connected to the access point.

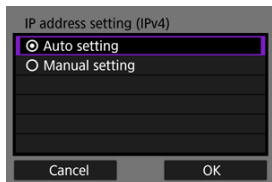

Go to [Setting the IP Address.](#)

Connecting in Infrastructure Mode

Instructions in this section are continued from [Displaying the Connection Wizard](#). Connect to an access point by entering its SSID (or ESS-ID).

Entering the SSID

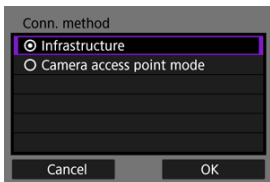

1. Select [Infrastructure].

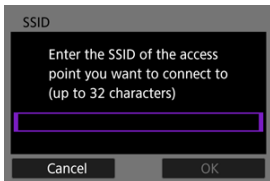

- Select [OK].

2. Enter the SSID (network name).



- Press <  > to access the virtual keyboard (), then enter the encryption key.
- Select [OK].

3. Select the authentication method.

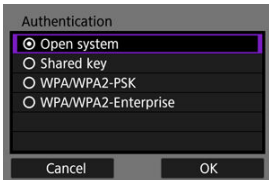

- Select an option and then **[OK]** to go to the next screen.
- On the **[Encryption settings]** screen displayed if **[Open system]** is selected, select **[Disable]** or **[WEP]**.

Entering the access point encryption key

- Enter the encryption key (password) set on the access point. For details on the encryption key that has been set, refer to the access point's user manual.
- The screens displayed in steps 4–5 vary depending on the authentication and encryption set on the access point.
- Go to [Setting the IP Address](#) if the **[IP address set.]** screen is displayed instead of the screens shown for steps 4–5.

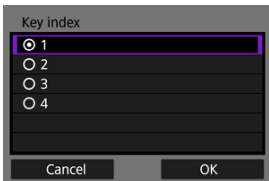

4. Select a key index.

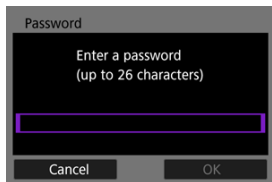

- The **[Key index]** screen is displayed if you have selected **[Shared Key]** or **[WEP]** in step 3.
- Select the key index number set on the access point.
- Select **[OK]**.

5. Enter the encryption key.



- Press <  > to access the virtual keyboard (), then enter the encryption key.
- Select [**OK**] to initiate connection with the access point.
- The following screen is displayed once the camera is connected to the access point.

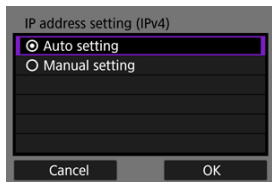

Go to [Setting the IP Address](#).

Connecting in Camera Access Point Mode

Instructions in this section are continued from [Displaying the Connection Wizard](#). Camera access point mode is a connection method for directly connecting the camera and other devices via Wi-Fi without using an access point. Two connection methods are available, as follows.

Connecting with Easy connection

Network settings for camera access point mode are configured automatically.

- Establishing a connection also requires operations on the other device (computer or smartphone). For details, refer to the device user manual.

1. Select [Camera access point mode].

[Configure online] options

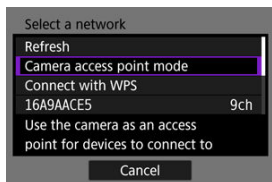

[Configure offline] options

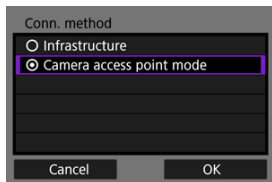

- Select [OK] on the [Conn. method] to go to the next screen.

2. Select [Easy connection].

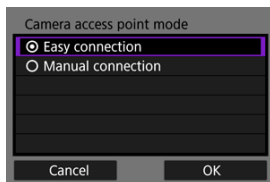

- Select [OK].

3. Select [OK].

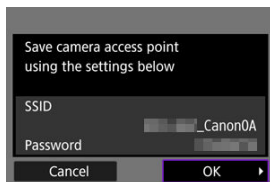

- The next screen is displayed.

4. Select [OK].

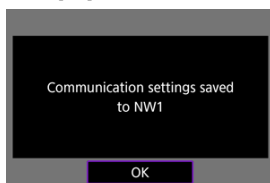

- The next screen is displayed.

5. Select [New settings].

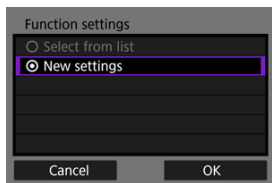

- Select [OK].
- For [Configure online], go to step 6.
- For [Configure offline], go to step 2 in [Configuring Communication Function Settings](#).
- By selecting [Select from list] when communication function settings are already registered on the camera, you can apply the registered settings.

6. Use the other device to connect to the camera.

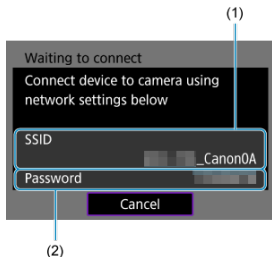

(1) SSID (network name)

(2) Encryption key (password)

Computer's screen (sample)

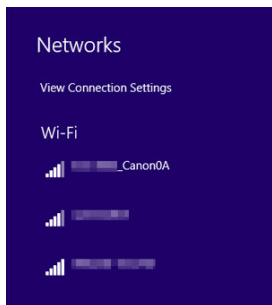

Smartphone's screen (sample)

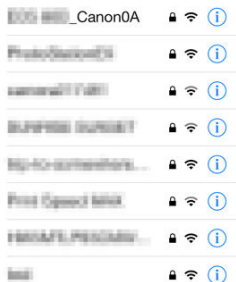

- Activate Wi-Fi on the other device, then select the SSID (network name) shown on the camera screen.
- For the password, enter the encryption key (password) shown on the camera screen.
- Once a connection is established, the settings screen for the communication function is displayed.

Go to step 2 in [Configuring Communication Function Settings](#).

Note

- When you are connecting by selecting [**Easy connection**], the SSID ends with “_Canon0A.”

Connecting with Manual connection

Network settings for camera access point mode are configured manually. Set **[SSID]**, **[Channel setting]**, and **[Encryption settings]** on each screen displayed.

1. Select **[Manual connection]**.

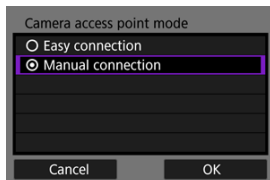

- Select **[OK]**.

2. Enter the SSID (network name).

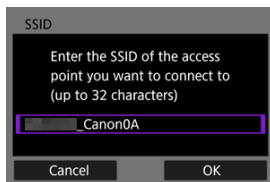

- Press **<SET>** to access the virtual keyboard (📄), then enter the SSID. After input, press **<MENU>**.
- Select **[OK]**.

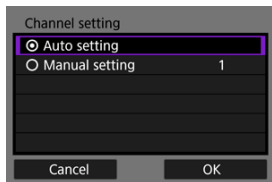

3. Select a channel setting option.

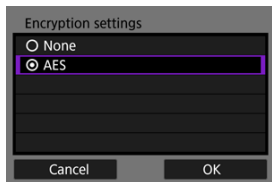

- To specify the settings manually, select [**Manual setting**], then turn the <  > dial.
- Select [**OK**] to initiate connection with the access point.

4. Select an encryption setting option.



- For encryption, select [**AES**].
- Select [**OK**].
- When [**AES**] is selected, the [**Password**] screen is displayed. Press <  > to access the virtual keyboard () , then enter the encryption key. After input, press the < **MENU** > button.

5. Select [Auto setting].

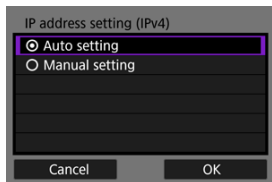

- Select [OK].
- If an error is displayed for [Auto setting], set the IP address manually (🔗).

6. Select [OK].

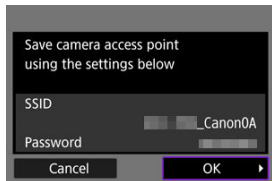

- The next screen is displayed.

7. Select [OK].

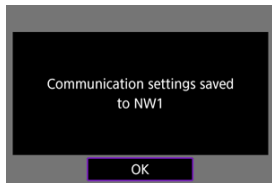

- The next screen is displayed.

8. Select [New settings].

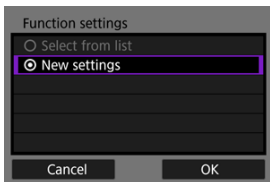

- Select [OK].
- For [Configure online], go to step 9.
- For [Configure offline], go to step 2 in [Configuring Communication Function Settings](#).
- By selecting [Select from list] when communication function settings are already registered on the camera, you can apply the registered settings.

9. Use the other device to connect to the camera.

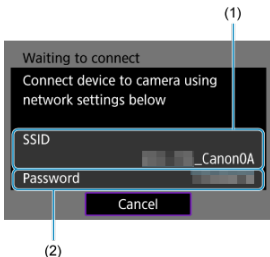

(1) SSID (network name)

(2) Encryption key (password)

Computer's screen (sample)

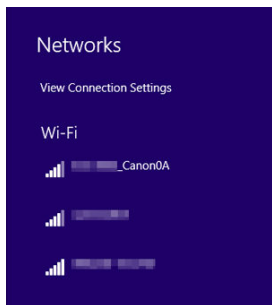

Smartphone's screen (sample)

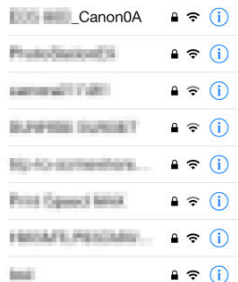

- Activate Wi-Fi on the other device, then select the SSID (network name) shown on the camera screen.
- For the password, enter the encryption key (password) shown on the camera screen.
- Once a connection is established, the settings screen for the communication function is displayed.

Go to step 2 in [Configuring Communication Function Settings](#).

Setting the IP Address

Instructions in this section are continued from [settings used for access point connections](#). Select a method of setting the IP address, and then set the IP address on the camera. When IPv6 is used, the camera only connects via IPv6. IPv4 connections are disabled.

Setting the IP address automatically

Set up the IP address settings automatically.

1. Select [Auto setting].

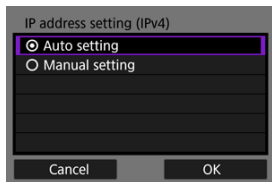

- Select [OK].
- If an error is displayed for [Auto setting], set the IP address manually (🔗).

2. Select an IPv6 option.

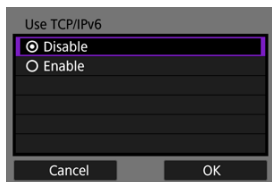

- Select an option and then [OK] to go to the next screen.
- When selecting [Enable], configure IPv6 settings after all settings are complete (🔗).
- The next screen is displayed after settings are complete.

3. Select [OK].

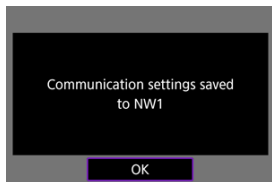

- The next screen is displayed.

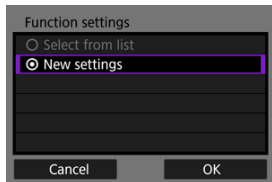

Go to [Configuring Communication Function Settings](#).

Setting the IP address manually

Set up the IP address settings manually. Note that the items displayed vary depending on the communication function.

1. Select [Manual setting].

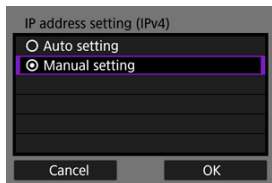

- Select [OK].

2. Select an option to configure.

IP address setting (IPv4)

IP address	192.168.1.2
Subnet mask	255.255.255.0
Gateway	Disable
DNS address	Disable

Cancel OK

- Select an option to access the screen for numerical input.
- To use a gateway or DNS address, select [**Enable**], then select [**Address**].

Gateway

Enable
 Disable

Address

0.0.0.0

Cancel OK

3. Enter the number.

IP address SET1

192 . 168 . 1 . 2

0 1 2 3 4 5 6 7 8 9

INFO Cancel MENU OK

- Turn the < > dial to switch to other input fields at the top of the screen, and turn the < > dial to select numbers to enter. Press < > to enter the selected number.
- To set the entered numbers and return to the screen for step 2, press the < **MENU** > button.

4. Select [OK].

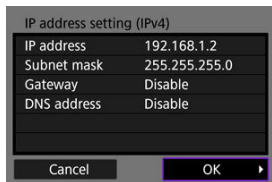

- When you have completed setting the necessary items, select [OK]. The next screen is displayed.
- If you are unsure what to enter, see [Checking Network Settings](#) or ask the network administrator or other person in charge of the network.

5. Select an IPv6 option.

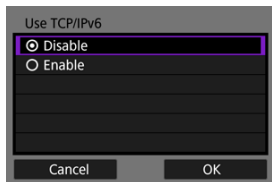

- Select an option and then [OK] to go to the next screen.
- When selecting [Enable], configure IPv6 settings after all settings are complete ([?/](#)).
- The next screen is displayed after settings are complete.

6. Select [OK].

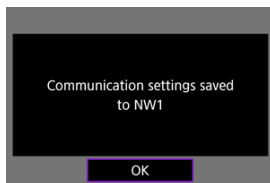

- The next screen is displayed.

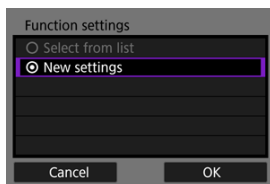

Go to [Configuring Communication Function Settings](#).

Configuring Communication Function Settings

The following instructions are for settings that vary depending on the communication function. Refer to the page that introduces your selected communication function.

1. Select [New settings].

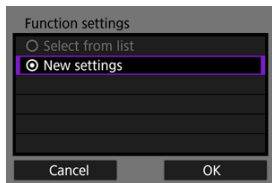

- Select [**OK**] to go to the next screen.
- By selecting [**Select from list**] when communication function settings are already registered on the camera, you can apply the registered settings.

2. Complete connection settings for the communication function.

FTP transfer (🔗)

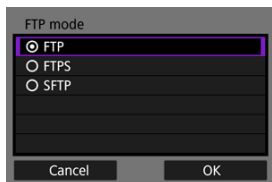

EOS Utility (🔗)

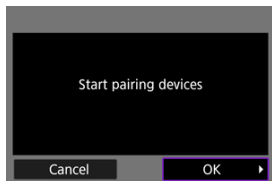

Browser Remote (🔗)

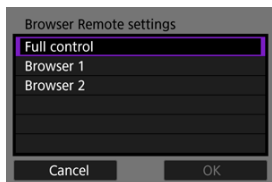

Image Transfer to FTP Servers

- [✔ Configuring FTP Server Connection Settings](#)
- [✔ Transferring Images Individually](#)
- [✔ Transferring Multiple Images at Once](#)
- [✔ Adding a Caption Before Transfer](#)
- [✔ Auto Retry If Transfer Fails](#)
- [✔ Viewing Transferred Images](#)

By connecting to an FTP server, you can send images on the camera to a computer. With FTP transfer, you can automatically transfer each image to the FTP server as you shoot or transfer a set of images together.

Configuring FTP Server Connection Settings

These instructions are continued from [Configuring Communication Function Settings](#).

1. Select an FTP mode.

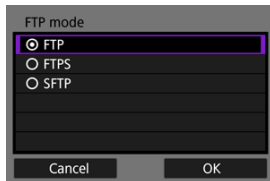

- [SFTP] is not displayed when the camera will connect via Wi-Fi.
- For secure FTP transfer using a root certificate, select [FTPS]. For details on root certificate settings, see [Importing a root certificate for FTPS](#).
- For secure FTP transfer over an SSH connection, select [SFTP]. Login settings are configured in step 5.
- Select [OK] to go to the next screen.

2. Select [Address setting].

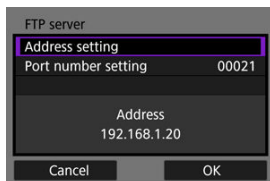

- Select [OK] to go to the next screen.
- The virtual keyboard is displayed if you have specified [Auto setting] for the IP address or [Manual setting] for the DNS address.
- A screen for numerical input is displayed if you have specified [Disable] for the DNS address.

3. Enter the FTP server IP address.

Virtual keyboard



- Use the virtual keyboard (🖱️) to enter the IP address. If DNS is used, enter the domain name.
- To set the entered values and return to the screen for step 2, press the < MENU > button.

Numerical input screen

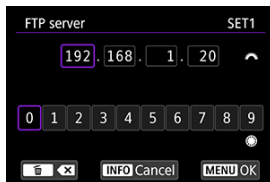

- Turn the < 🔄 > dial to switch to other input fields at the top of the screen, and turn the < 🕒 > dial to select numbers to enter. Press < SET > to enter the selected number.
- To set the entered values and return to the screen for step 2, press the < MENU > button.

4. Configure the port number.

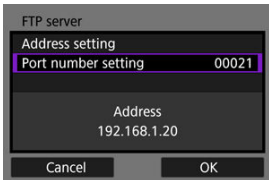

- Normally, set [**Port number setting**] to 00021 (for FTP/FTPS) or 00022 (for SFTP).
- Select [**OK**] to go to the next screen.
- Go to step 6 if you selected [**FTP**] or [**FTPS**] in step 1. Go to step 5 if you selected [**SFTP**].

5. Configure the SSH login authentication settings.

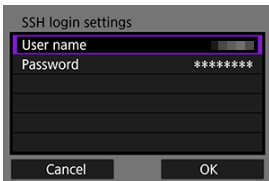

- Select [**User name**] and [**Password**] to access the virtual keyboard (📄) and enter the user name and password for SSH password authentication.
- Select [**OK**] to go to the next screen.

6. Configure the passive mode setting.

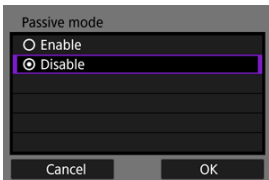

- Not displayed if you selected [**SFTP**] in step 1.
- Select [**OK**] to go to the next screen.
- If an Error 41 (Cannot connect to FTP server) is displayed in step 9, setting [**Passive mode**] to [**Enable**] may resolve it.

7. Configure proxy server settings.

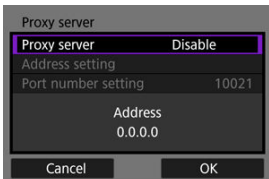

- Not displayed if you selected [FTPS] or [SFTP] in step 1.
- Select [OK] to go to the next screen.

8. Configure the login method.

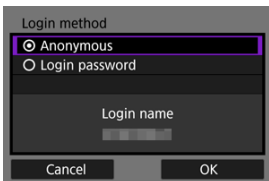

- Not displayed if you selected [SFTP] in step 1.
- Select [OK] to go to the next screen.

9. Specify a target folder.

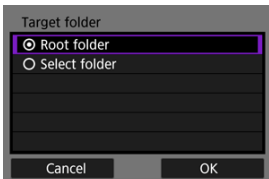

- Select [**Root folder**] to have images saved in the root folder, as specified in FTP server settings (🔗).
- Select [**Select folder**] to specify a target folder in the root folder. If the folder does not exist, it is created automatically.
- Select [**OK**] to go to the next screen.
- The camera's <LAN> lamp is lit in green.
- When the following message appears, select [**OK**] to trust the target server.

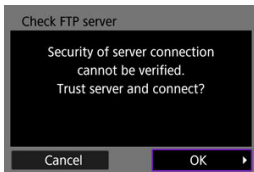

10. Select [OK].

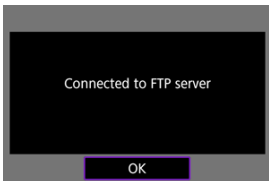

- Not displayed in offline configuration.

11. Select [OK].

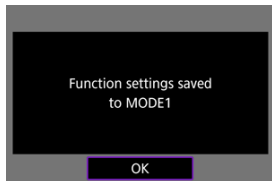

12. Select [OK].

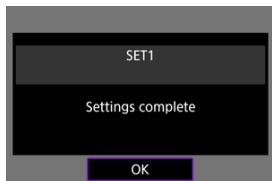

- Display returns to the [Network settings] screen.

Connection settings for FTP transfer are now complete.
During image transfer, the camera's <LAN> lamp blinks in green.

Importing a root certificate for FTPS

If you specified [FTPS] FTP mode when configuring connection settings, the root certificate used by the FTP server must be imported to the camera.

- Only the root certificate with a file name of "ROOT.CER," "ROOT.CRT," or "ROOT.PEM" can be imported to the camera.
- Only one root certificate file can be imported to the camera. Insert a card containing the root certificate file in advance.
- The priority card selected for [Record/play] or [Playback] in [☛: Record func+card/ folder sel.] is used to import a certificate.
- It may not be possible to trust servers you try to connect to in FTPS connections with a self-signed certificate.

1. Select [☛: Network settings].

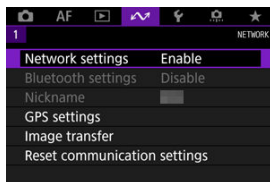

2. Select [Connection option settings].

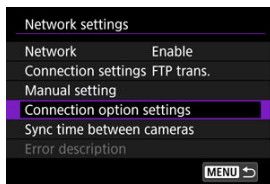

3. Select [FTP transfer settings].

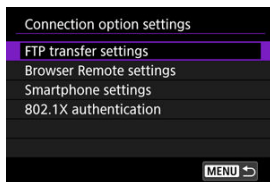

4. Select [Set root certif].

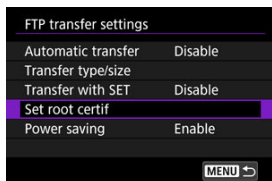

5. Select [Load root certif from card].

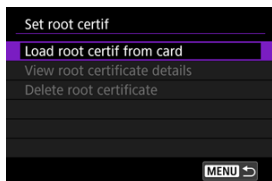

6. Select [OK].



- The root certificate is imported.
- Select [OK] on the confirmation screen to return to the [Set root certif] screen.

 **Note**

- To delete the root certificate imported to the camera, select [**Delete root certificate**] on the screen in step 5. To check who it was issued to and issued by, the period of validity, and other information, select [**View root certificate details**].

Transferring Images Individually

- ✔ [Automatic transfer after each shot](#)
 - ✔ [Transferring the current image](#)
 - ✔ [Specifying sizes or types of images to transfer](#)
-

Automatic transfer after each shot

Each image can be immediately transferred to the FTP server automatically after your shot. You can continue shooting still photos as usual while images are being transferred.

- Before shooting, make sure a card is in the camera. If you shoot without recording images, they cannot be transferred.
- Automatic transfer of movies during recording is not supported. After recording, transfer movies as described in [Transferring Multiple Images at Once](#) or [Adding a Caption Before Transfer](#).

1. Select [: Network settings].

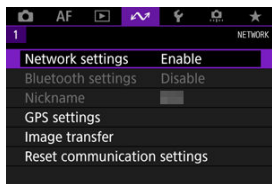

2. Select [**Connection option settings**].

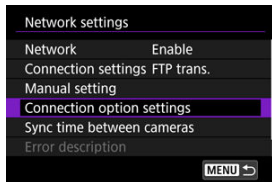

3. Select [FTP transfer settings].

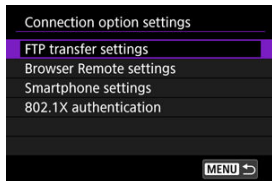

4. Select [Automatic transfer].

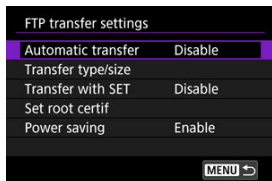

5. Select [Enable].

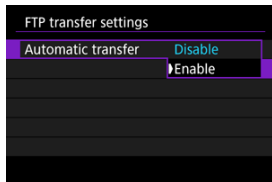

6. Take the picture.

- The captured image is transferred to the FTP server.

 Caution

- Images cannot be erased during image transfer.
- No voice memo can be added when [Automatic transfer] is set to [Enable].

 **Note**

- During continuous shooting, images are transferred to the FTP server in the order they are captured.
- Captured images are also stored on the card.
- Any images for which transfer fails or is interrupted will be transferred automatically when the connection is recovered (🔄). These images can also be transferred together manually at a later time (🔄).
- Any changes to network settings (such as FTP server settings) before automatic FTP transfer begins will prevent automatic transfer.

Transferring the current image

Enables you to transfer the image you are viewing simply by pressing <  >. You can continue shooting still photos as usual while images are being transferred.

1. Access the [FTP transfer settings] screen.

- Follow steps 1–3 in [Automatic transfer after each shot](#).

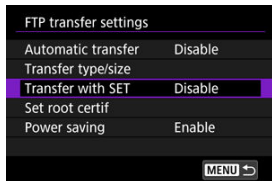

2. Select [Transfer with SET].

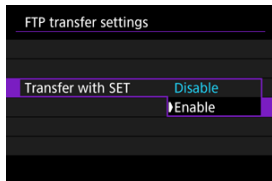

3. Select [Enable].



4. Select an image.

- On the camera, press the <  > button.
- Select an image to transfer, then press <  > to transfer the image.
- You can add a voice memo to the current image before transfer. For details, see [Recording Voice Memos](#).
- Movies cannot be transferred this way. Selecting a movie and pressing <  > will display the movie playback panel.

Specifying sizes or types of images to transfer

You can specify which images to transfer when recording images of different sizes to the CFexpress cards, or when shooting RAW+JPEG or RAW+HEIF images.

1. Access the [FTP transfer settings] screen.

- Follow steps 1–3 in [Automatic transfer after each shot](#).

2. Select [Transfer type/size].

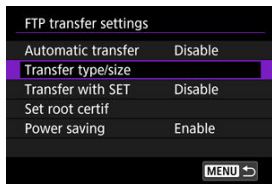

3. Select the size of images to transfer.

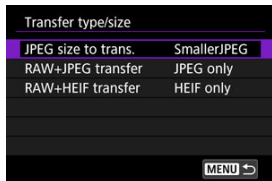

- Select [**JPEG size to trans.**], then select [**Larger JPEG**] or [**SmallerJPEG**].

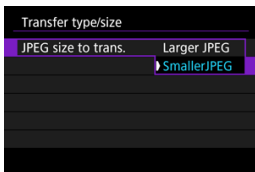

- To transfer smaller JPEGs when the camera is set to record larger JPEGs to one CFexpress card and smaller JPEGs to the other, set [**JPEG size to trans.**] to [**SmallerJPEG**].

4. Select the type of images to transfer.

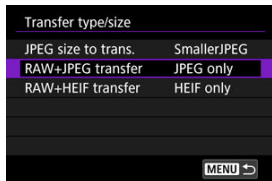

● RAW+JPEG transfer

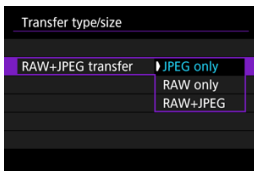

- Select **[RAW+JPEG transfer]**, then select **[JPEG only]**, **[RAW only]**, or **[RAW+JPEG]**.

● RAW+HEIF transfer

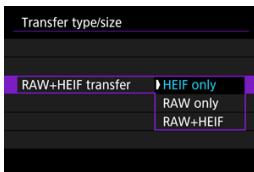

- Select **[RAW+HEIF transfer]**, then select **[HEIF only]**, **[RAW only]**, or **[RAW+HEIF]**.



Note



- When the camera is set to record RAW images to one CFexpress card and JPEGs or HEIFs to the other, specify which images to transfer in the [**RAW+JPEG transfer**] or [**RAW+HEIF transfer**] setting. Similarly, specify your transfer preference when RAW+JPEG images or RAW+HEIF images are simultaneously recorded to a single card.
- Captured images are also stored on the card.
- When images of the same size are recorded to both cards simultaneously, images recorded to the card selected for [**Record/play**] or [**Play**] in [: **Record func+card/folder sel.**] are given priority for transfer.

Transferring Multiple Images at Once

- ☑ [Selecting images to transfer](#)
- ☑ [Selecting multiple images](#)
- ☑ [Transferring RAW+JPEG or RAW+HEIF images](#)

After shooting, you can select multiple images and transfer them all at once, or you can transfer unsent images or images that could not be sent previously. You can continue shooting still photos as usual during transfer.

! Caution

- Image transfer in progress is paused while the Live View shooting/movie shooting switch is set to <  >. To resume image transfer, set it to <  >.

Selecting images to transfer

1. Select [: Image transfer].

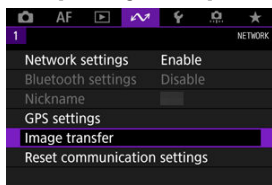

2. Select [Image sel./transfer].

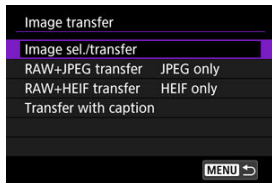

3. Select [FTP transfer].









4. Select [Sel.Image].



5. Select the images to transfer.



- Use the <  > dial to select an image to transfer, then press <  >.
- Use the <  > dial to add a [✓] in the upper left, then press <  >.
- For three-image display, press the <  > button and turn the <  > dial left. To return to single-image display, turn the <  > dial right.
- To select other images to transfer, repeat step 5.
- After image selection, press the < **MENU** > button.

6. Select [FTP transfer].



7. Select [OK].



- The selected images are transferred to the FTP server.

Selecting multiple images

Multiple images can be transferred at once after you choose a selection method. You can continue shooting still photos as usual while images are being transferred.

1. Access the [Image sel./transfer] screen.

- Follow steps 1–3 in [Selecting images to transfer](#).

2. Select [Multiple].



3. Select a selection method to use.

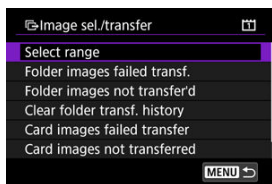

- **Select range**



- Select [**Select range**]. Selecting the first and last images of the range marks all the images in the range with a checkmark [✓], and one copy of each image will be sent.

● In a folder

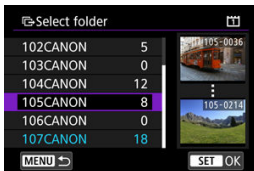

- Selecting [**Folder images failed transf.**] selects all images in the selected folder for which transfer failed.
- Selecting [**Folder images not transfer'd**] selects all unsend images in the selected folder.
- Selecting [**Clear folder transf. history**] clears the transfer history of images in the selected folder. After clearing the transfer history, you can select [**Folder images not transfer'd**] and transfer all images in the folder again.

● In a card



- Selecting [**Card images failed transfer**] selects all images in the selected card for which transfer failed.
- Selecting [**Card images not transferred**] selects all unsend images in the selected card.
- Selecting [**Clear card's transf. history**] clears the transfer history of images in the selected card. After clearing the transfer history, you can select [**Card images not transferred**] and transfer all images in the card again.

4. Select [**FTP transfer**].



5. Select [OK].



- The selected images are transferred to the FTP server.

Transferring RAW+JPEG or RAW+HEIF images

For RAW+JPEG or RAW+HEIF images, you can specify which image to transfer.

1. Select [MENU]: Image transfer].

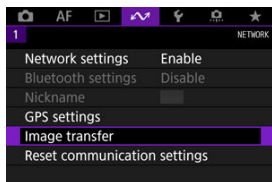

2. Select the type of images to transfer.

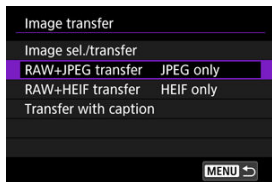

- **RAW+JPEG transfer**

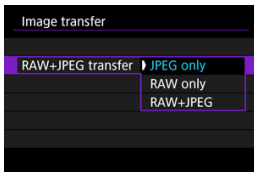

- Select [**RAW+JPEG transfer**], then select [**JPEG only**], [**RAW only**], or [**RAW+JPEG**].

- **RAW+HEIF transfer**

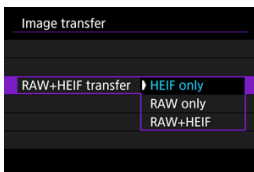

- Select [**RAW+HEIF transfer**], then select [**HEIF only**], [**RAW only**], or [**RAW+HEIF**].

 **Caution**

- Some menu items are not available during image transfer.

 **Note**

- This setting is linked to [**RAW+JPEG transfer**] and [**RAW+HEIF transfer**] settings on the [**Transfer type/size**] screen ().

Adding a Caption Before Transfer

You can add a registered caption to each image before transfer. This is convenient if you want to inform the recipient of the printing quantity, for example. Captions are also added to images saved to the camera.

- You can check captions added to images by examining the Exif information, in the user comments.
- Captions can be created and registered with EOS Utility (🔗) or Browser Remote (🔗).

1. Select [MENU: Image transfer].

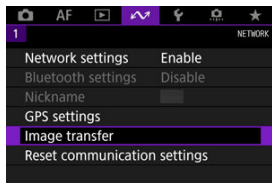

2. Select [Transfer with caption].

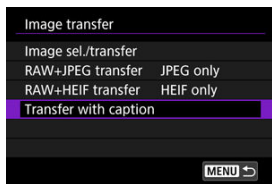

- The last image viewed is displayed.

3. Specify the caption.

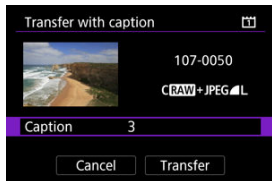

- Select [**Caption**], and on the screen displayed, select the content of the caption.

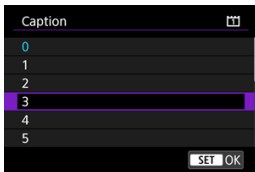

4. Select [Transfer].

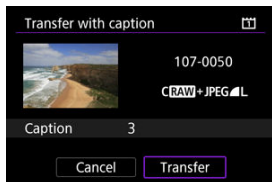

- The image is transferred with the caption. After transfer, display returns to the [**Image transfer**] screen.

Caution

- Other images cannot be selected from the [**Transfer with caption**] screen. To select another image for transfer with a caption, view that image before following these steps.

Auto Retry If Transfer Fails



If transfer fails, the camera's <LAN> lamp blinks in red. In this case, the following screen is displayed after you press the <MENU> button and select [**↵**: **Network settings**]. To resolve the error displayed, see [Troubleshooting](#).



Once you have resolved the issue, the images that could not be sent initially will be transferred automatically. With this option activated, transfer is attempted again automatically after failure, whether automatic transfer is used or captured images are transferred manually via FTP. Note that if you cancel transfer or turn the camera off, auto retry is not attempted.

See [Transferring Multiple Images at Once](#) and transfer images as needed.

Note

- To automatically log off and disconnect from the LAN after transfer, you can configure power-saving on the [**FTP transfer settings**] screen (.
- If you prefer not to disconnect from the LAN, set [**Power saving**] on the [**FTP transfer settings**] screen () to [**Disable**].

Viewing Transferred Images

Images transferred to the FTP server are stored in the following folder as specified in the FTP server settings.

Target folder of the FTP server

- Under the default settings of the FTP server, images are stored in [C drive] → [Inetpub] folder → [ftproot] folder, or in a subfolder of this folder.
- If the root folder of the transfer destination has been changed in the FTP server settings, ask the FTP server administrator where images are transferred.

Remote Control (EOS Utility)

[✔ Configuring EOS Utility Connection Settings](#)

[✔ Using EOS Utility](#)

[✔ Direct Transfer](#)

[✔ Creating and Registering Captions](#)

Using EOS Utility, you can browse images on the camera and save them to the computer. Also in EOS Utility, you can shoot by controlling the camera remotely and change camera settings.

- Install EOS Utility on the computer before setting up a connection ([✔](#)).
- See [Wi-Fi Connections with a Computer Using EOS Utility](#) for instructions on preparing for camera operations in EOS Utility by connecting the camera to a computer by joining a Wi-Fi network via an access point compatible with WPS (PBC mode).

Configuring EOS Utility Connection Settings

These instructions are continued from [Configuring Communication Function Settings](#).

- Establishing a connection also requires operations on the computer. For details, refer to the computer documentation.
-

Steps on the camera (1)

1. Select [OK].

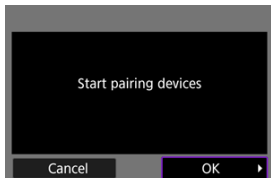

- The following message is displayed.

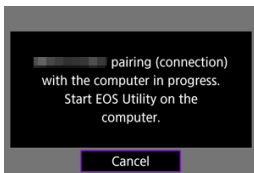

Steps on the computer

2. Start EOS Utility on the computer.
3. In EOS Utility, click [Pairing over Wi-Fi/LAN].

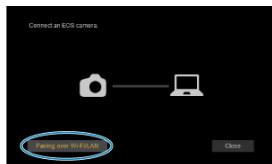

- If a firewall-related message is displayed, select [Yes].

4. Click [Connect] on the computer.

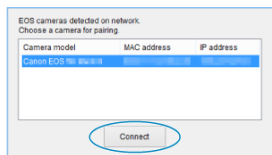

- Select the camera to connect to, then click [Connect].
- If multiple cameras are listed, identify the camera to connect to by MAC address, as shown on the camera screen.
- The camera MAC address can be checked on the [MAC address] screen (🔍).

Steps on the camera (2)

5. Select [OK].

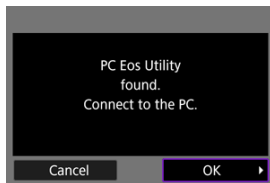

- This message is displayed after the camera detects the computer where you clicked [**Connect**] in step 4.
- Select [**OK**].

6. Select [OK].

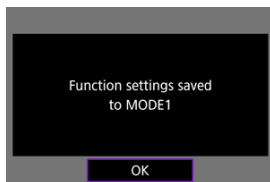

7. Select [OK].

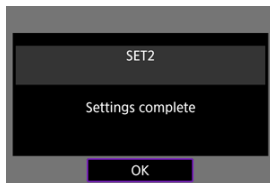

- Display returns to the [**Network settings**] screen.
- The camera's <LAN> lamp is lit in green.
- Setting information is stored on the camera.

Connection settings for EOS Utility are now complete.

- Manually pairing the camera and computer after this is no longer necessary, as long as you do not change the settings after you have paired the devices once.

Using EOS Utility

For EOS Utility instructions, refer to the EOS Utility Instruction Manual. Remote shooting is only one of the many camera operations available.

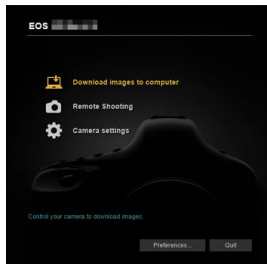



Caution

- Some menu items are not available when the camera is connected to a network.
- In remote shooting, the AF speed may become slower.
- Depending on the communication status, image display or shutter release timing may be delayed.
- In Remote Live View shooting, the rate of image transmission is slower compared to a connection via an interface cable. Therefore, moving subjects cannot be displayed smoothly.

Direct Transfer

With the camera connected to EOS Utility and the main EOS Utility window displayed, you can use the camera to transfer images to computer.

Caution

- Image transfer via FTP in progress is paused while the Live View shooting/movie shooting switch is set to <  >. To resume image transfer, set it to <  >.

Selecting images to transfer

1. Select [: Image transfer].

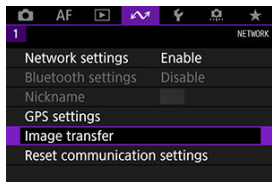

2. Select [Image sel./transfer].

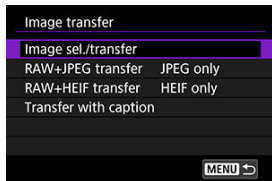

3. Select [Direct transfer].

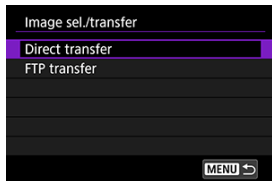







4. Select [Sel.Image].



5. Select an image to transfer.



- Use the <  > dial to select an image to transfer, then press <  >.
- Use the <  > dial to add a [✓] in the upper left of the screen, then press <  >.
- For three-image display, press the <  > button and turn the <  > dial left. To return to single-image display, turn the <  > dial right.
- To select other images to transfer, repeat step 5.
- After image selection, press the < **MENU** > button.

6. Select [Direct transfer].



7. Select [OK].



- The selected images are transferred to the computer.

Selecting multiple images

Multiple images can be transferred at once after you choose a selection method.

1. Access the [Image sel./transfer] screen.

- Follow steps 1–3 in [Selecting images to transfer](#).

2. Select [Multiple].

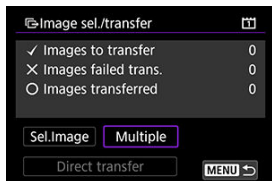

3. Select a selection method to use.

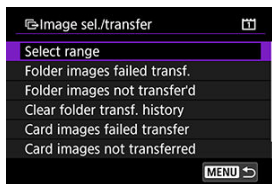

- **Select range**



- Select [**Select range**]. Selecting the first and last images of the range marks all the images in the range with a checkmark [✓], and one copy of each image will be sent.

● In a folder

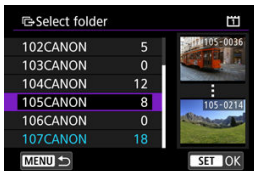

- Selecting [**Folder images failed transf.**] selects all images in the selected folder for which transfer failed.
- Selecting [**Folder images not transfer'd**] selects all unsend images in the selected folder.
- Selecting [**Clear folder transf. history**] clears the transfer history of images in the selected folder. After clearing the transfer history, you can select [**Folder images not transfer'd**] and transfer all images in the folder again.

● In a card



- Selecting [**Card images failed transfer**] selects all images in the selected card for which transfer failed.
- Selecting [**Card images not transferred**] selects all unsend images in the selected card.
- Selecting [**Clear card's transf. history**] clears the transfer history of images in the selected card. After clearing the transfer history, you can select [**Card images not transferred**] and transfer all images in the card again.

4. Select [**Direct transfer**].



5. Select [OK].



- The selected images are transferred to the computer.

Transferring RAW+JPEG or RAW+HEIF images

For RAW+JPEG or RAW+HEIF images, you can specify which image to transfer.

1. Select [M]: Image transfer].

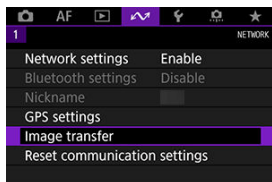

2. Select the type of images to transfer.

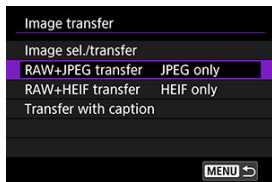

- **RAW+JPEG transfer**

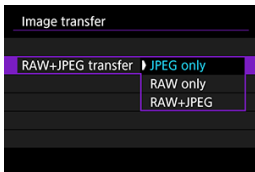

- Select **[RAW+JPEG transfer]**, then select **[JPEG only]**, **[RAW only]**, or **[RAW+JPEG]**.

- **RAW+HEIF transfer**

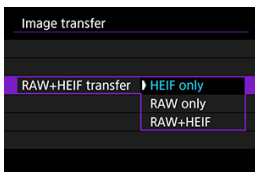

- Select **[RAW+HEIF transfer]**, then select **[HEIF only]**, **[RAW only]**, or **[RAW+HEIF]**.

Caution

- Some menu items are not available during image transfer.

Note

- This setting is linked to **[RAW+JPEG transfer]** and **[RAW+HEIF transfer]** settings on the **[Transfer type/size]** screen (🔗).
- Image transfer in progress is paused while the Live View shooting/movie shooting switch is set to < 📹 >.

Creating and Registering Captions

You can create captions and register them on the camera to use them as described in [Adding a Caption Before Transfer](#).

1. Start EOS Utility and select [Camera settings].

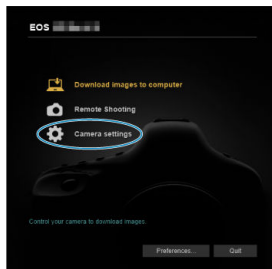

2. Select [WFT Captions].

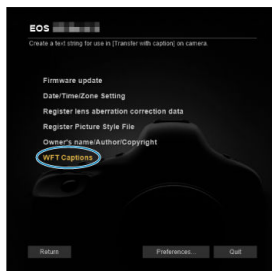

3. Enter the caption or captions.

Register text to use with
[Transfer with caption] feature.

1	<input type="text" value="Canon"/>
2	<input type="text" value="1"/>
3	<input type="text" value="2"/>
4	<input type="text" value="3"/>

- Enter up to 31 characters (in ASCII format).
- To acquire caption data stored on the camera, select [Load settings].

4. Set the captions on the camera.

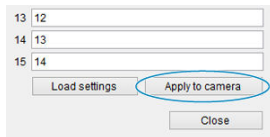

A screenshot of a camera settings dialog box. It features three input fields with the following values: 13 12, 14 13, and 15 14. Below the input fields are three buttons: 'Load settings', 'Apply to camera', and 'Close'. The 'Apply to camera' button is circled in blue.

- Select [**Apply to camera**] to set your new captions on the camera.

Controlling the Camera with Browser Remote

- ☑ [Configuring Browser Remote Connection settings](#)
- ☑ [Displaying Browser Remote](#)
- ☑ [Browsing Images](#)
- ☑ [Shooting Remotely](#)
- ☑ [Registering IPTC Information](#)
- ☑ [Configuring FTP Server Settings](#)
- ☑ [Creating and Registering Captions](#)

Using a browser, you can browse and save camera images, shoot remotely, and perform other operations on a computer or smartphone.

Configuring Browser Remote Connection settings

These instructions are continued from [Configuring Communication Function Settings](#). Specify a login name and password for accessing the camera from a computer. The login name and password you specify here are used when connecting to the camera.

1. Select **[Full control]** or **[Browser *]**.

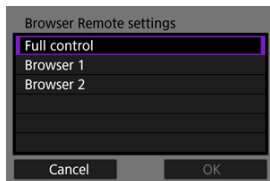

- Browser Remote enables camera access by users at up to three computers at once.
- The **[Full control]** account can use all Browser Remote features. This account is only available on one computer.
- The **[Browser *]** account is limited to browsing images on the camera and saving them to the computer. This account is available on up to two computers.

2. Configure the [Login name] or [Password].

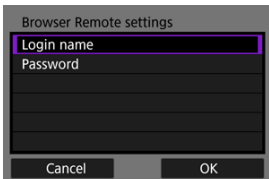

- Select [**Login name**] and [**Password**] to access the virtual keyboard (🗂) and enter the login name and password.
- Select [**OK**] to return to the screen in step 1. Follow steps 1–2 for each account to be used.

3. Select [OK].

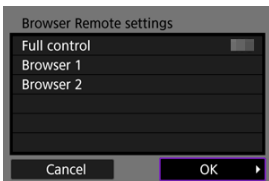

4. Select [OK].

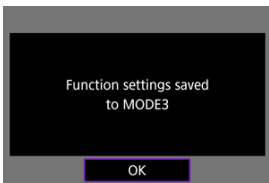

5. Select [OK].

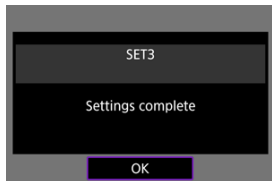

- Display returns to the **[Network settings]** screen.
- Setting information is stored on the camera.

Connection settings for Browser Remote are now complete.

Note

- You can change WFT account settings on the **[WFT account]** screen () , accessed by selecting **[Browser Remote settings]** in **[Connection option settings]**. The port number setting can also be changed on the **[Browser Remote settings]** screen by selecting **[Port no. (HTTP)]** or **[Port no. (HTTPS)]**. Note that there is normally no need to change the port number (80 for HTTP, 443 for HTTPS).

Displaying Browser Remote

From a browser, log in to the Browser Remote page on the camera. Make sure the camera and computer are already connected via a wired LAN connection.

Checking the camera's IP address

The camera's IP address, as displayed in step 5, must be entered in the browser address bar to access the camera from a browser.

1. Select [**W**: Network settings].

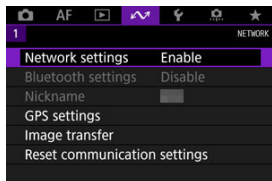

2. Select [**C**: Connection settings].

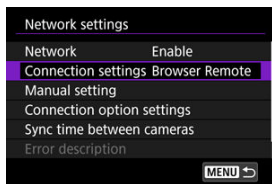

3. Select [**S**: Browser Remote].

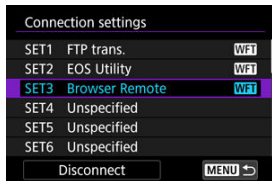

4. Select [Confirm settings].

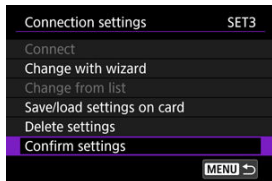

- Setting details are displayed.

5. Check the settings.

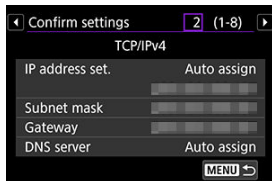

- Turn the <⦿> dial to access other pages.
- Write down the IP address.
- After checking, press the <MENU> button to close the confirmation screen.

Logging in to Browser Remote

6. Start a browser.

- Start a browser on the computer.

7. Enter the URL.



- In the address bar, enter the IP address you noted in step 5.
- Press the <Enter> key.

8. Enter the information for [Login name] and [Password].

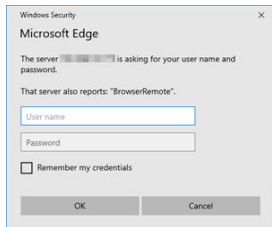

- In **[Login name]** (user name) and **[Password]**, enter the information you specified in [Configuring Browser Remote Connection settings](#).
- Select **[OK]** to display the top Browser Remote menu screen.

9. Configure default settings as needed.

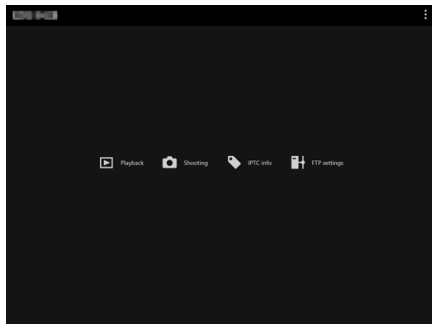

- Select **[☰]** to display the menu.

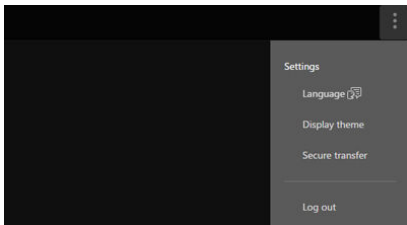

- **Language**

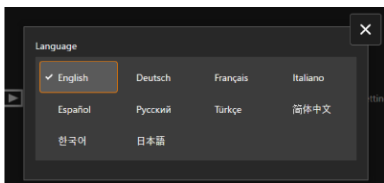

Enables you to select the display language.

- **Display theme**

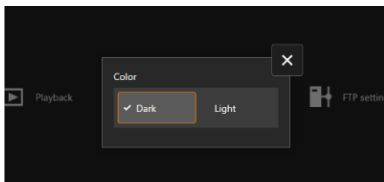

You can set the Browser Remote background color. Select [**Dark**] or [**Light**].

- **AF for still photo shooting**

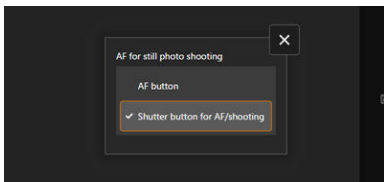

Displayed if you select [**Shooting**] in step 9.
Enables you to configure autofocus operation for still photo shooting. Select [**AF button**] or [**Shutter button for AF/shooting**].

- **Secure transfer**

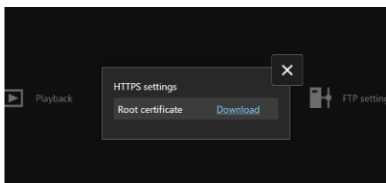

Enables you to download a root certificate and access an FTP server, when you will connect to the FTP server via HTTPS.

- **Log out**

Select to end the Browser Remote connection.

Caution

- Browser Remote is not available unless the browser support JavaScript.
- Some menu items are not available when connected to the camera.

Browsing Images

Enables you to browse images on cards in the camera.

1. Select [Playback].

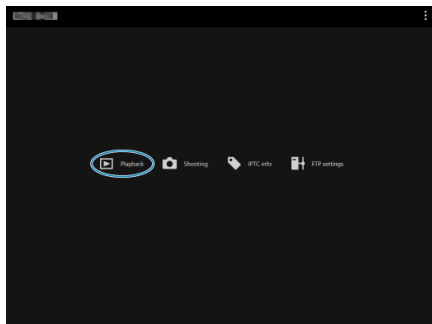

- The image browsing screen is displayed.

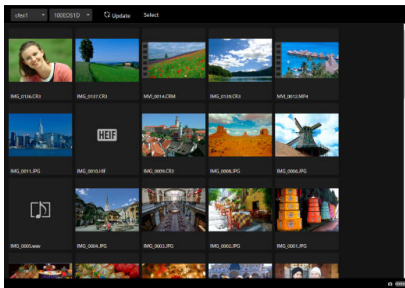

2. Select a card and folder.

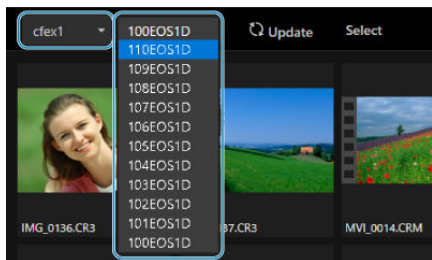

- Select a card in the pull-down list at left.
- Select a folder in the pull-down list at right.

3. Perform image operations as needed.

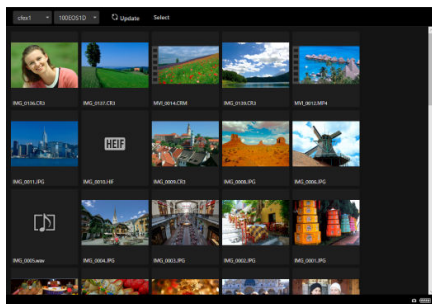

- Selecting **[Update]** displays any images that have been added.

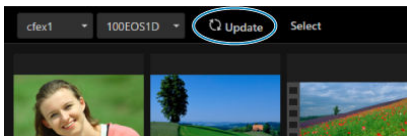

- With **[Select]** selected, you can select multiple images.

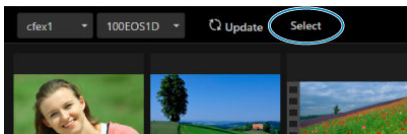

Selecting individual thumbnails selects each image separately.
Selecting thumbnails again clears the selection.
Selecting **[Select all]** marks all images on the browsing screen as selected.
Selecting **[Clear all]** clears selection of all images.

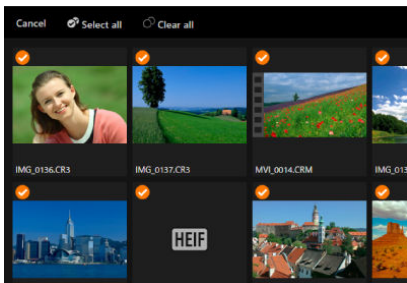

Selecting **[Cancel]** returns to the browsing screen.

- Selecting a thumbnail switches to the playback screen and shows the image enlarged.

Still photo playback screen

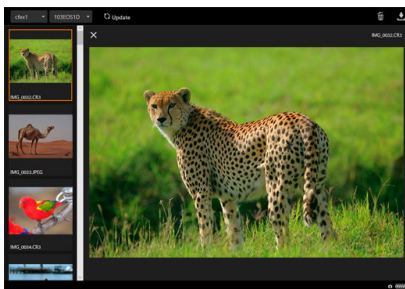

Movie playback screen

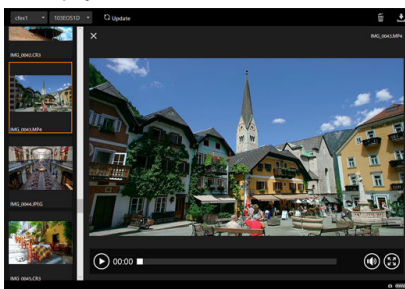

Audio playback screen

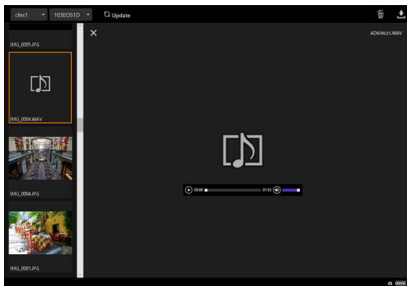

- Selecting an image and then the  button erases the image.

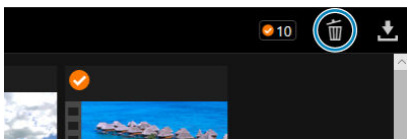

- Selecting an image and then the  button downloads the image to the computer.

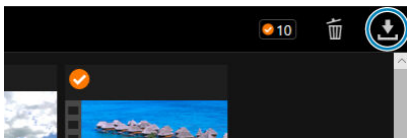

Note

- Computer performance and the browser used may prevent or delay image display or prevent image downloading.

Shooting Remotely

You can use Browser Remote to shoot remotely.

Shooting still photos

1. Select [Shooting].

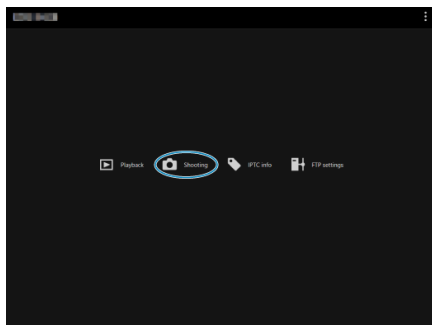

- The remote shooting screen is displayed.

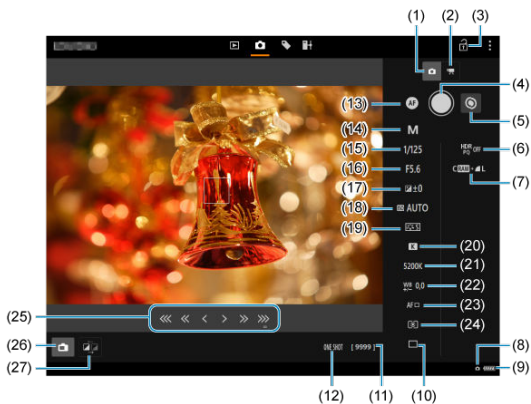

-
- (1) Still photo shooting button
 - (2) Movie shooting button
 - (3) Multi-function lock icon
 - (4) Shutter button
 - (5) MF toggle button
 - (6) HDR shooting
 - (7) Image quality
 - (8) Browser Remote connection
 - (9) Battery level
 - (10) Drive mode
 - (11) Available shots
 - (12) AF operation
 - (13) AF button
 - (14) Shooting mode
 - (15) Shutter speed
 - (16) Aperture value
 - (17) Exposure compensation
 - (18) ISO speed
 - (19) Picture Style
 - (20) White balance
 - (21) Color temperature
 - (22) White balance correction
 - (23) AF method
 - (24) Metering mode
 - (25) MF button
 - (26) Live View shooting button
 - (27) Live View image quality toggle button
-

2. Select (1) Still photo shooting button.

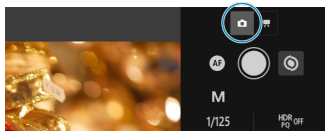

3. Set the lens's focus mode switch to < AF >.

4. Display the Live View image.

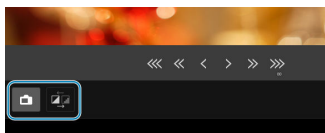

- To activate or deactivate Live View, select (26) Live View shooting button.
- For more responsive Live View image display, select (27) Live View image quality toggle button, which will reduce Live View image quality to improve responsiveness. Select it again to restore the original image quality.

5. Set up shooting.

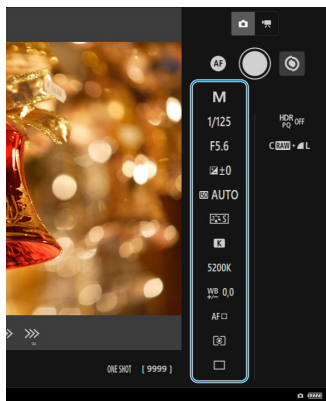

- Select setting items (such as image quality) to view the setting details, which you can configure.
- Configure the settings as needed.

6. Focus on the subject.

When using autofocus

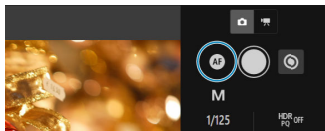

- To start AF with **[AF button]** selected in the **[AF for still photo shooting]** menu, select the (13) AF button.
- To start AF with **[Shutter button for AF/shooting]** selected in the **[AF for still photo shooting]** menu, select and release (4) Shutter button.

When focusing manually

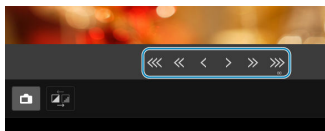
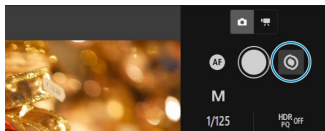

- To show/hide (25) MF button display, select (5) MF toggle button.
- Select (25) MF button, then focus manually. To adjust focus toward the foreground, use [**<<< << <**], and to adjust focus toward the background, use [**> >> >>>**].
- Three levels of focus adjustment are available.
 - [**<<< >>>**]: Coarse
 - [**<< >>**]: Intermediate
 - [**< >**]: Fine

7. Take the picture.

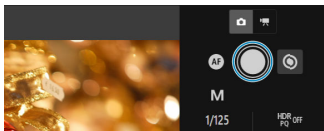

- Select (4) Shutter button, and when you release the button, the camera shoots.
- Captured images are saved to the card in the camera.
- To browse and download images, see [Browsing Images](#).

Caution

- Depending on the communication status, image display or shutter release timing may be delayed.
- Still photo shooting is not possible with the camera's Live View shooting/movie shooting switch set to <  >.

Recording movies

1. Select [Shooting].

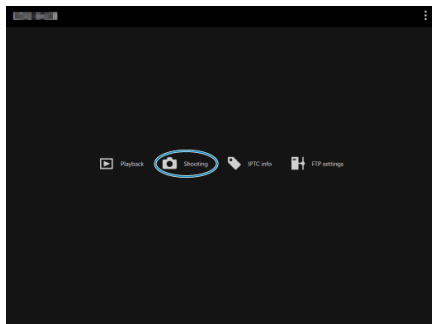

- The remote shooting screen is displayed.

2. Select (2) Movie shooting button.

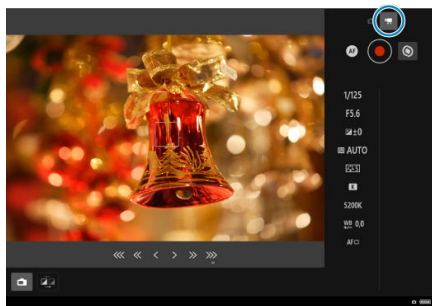

3. Configure settings as needed.

- Follow steps 3–6 in [Shooting still photos](#).

4. Record the movie.

Movie recording standby

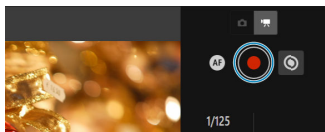

Movie recording in progress

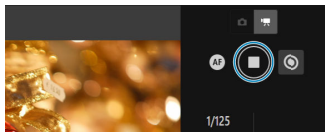

- Select (4) Shutter button, and when you release the button, movie recording begins.
- During movie recording, the red [○] on (4) Shutter button changes to a white [□].
- To stop movie recording, select (4) Shutter button again and release the button.

Registering IPTC Information

Enables you to edit and register IPTC* information (comments on images, such as captions, credits, and shooting locations) on the camera. Images can be tagged with IPTC information registered on the camera.

* International Press Telecommunications Council

1. Select [IPTC info].

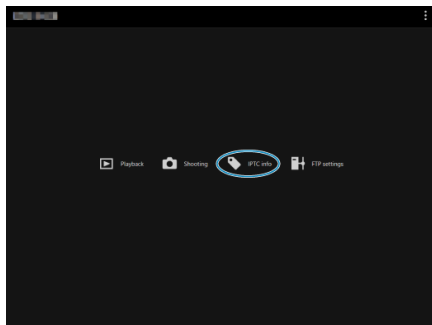

- A screen for editing IPTC information is displayed.

A screenshot of the IPTC information editing screen. It is divided into two main sections: 'Image Content' and 'Image Rights'.
Image Content:
- Description/Caption: [Text input field]
- Descriptive Words: [Text input field]
- Headline: [Text input field]
- Keywords: [Text input field]
- Persons shown: [Text input field]
- Featured Obj. Name: [Text input field]
- Featured Obj. Code: [Text input field]
- IPTC Scene: [Text input field]
Image Rights:
- Creator/Photographer: [Text input field]
- Creator's Job Title: [Text input field]
- Copyright: [Text input field]
- Credit: [Text input field]
- Source: [Text input field]
- Copyright URL: [Text input field]
- Rights Usage Terms: [Text input field]

2. Select [Load from file].



- Selecting [**Load from file**] enables you to load IPTC information (in XMP format) that was saved using EOS Utility.

3. Edit and register information as needed.

- Selecting [**Add to camera**] to applies the edited IPTC information to the camera.

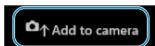

This also sets the camera's Custom Function [**Fn8: Add IPTC information**] option to [**ON**].

- Selecting [**Clear camera info**] deletes all IPTC information registered on the camera.

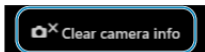

This also sets the camera's Custom Function [**Fn8: Add IPTC information**] option to [**OFF**].

- Selecting [**Clear**] clears all IPTC information.

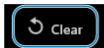

Configuring FTP Server Settings

If you will use FTP transfer for images captured remotely, you can use the camera's connection settings (🔗) to change the target FTP server.

1. Select [FTP settings].

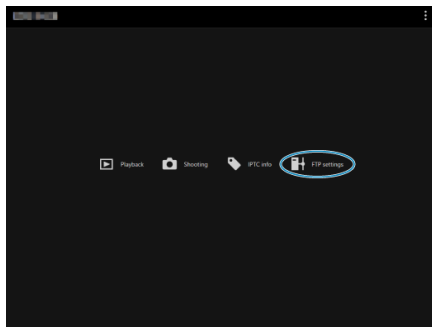

- The FTP setting screen is displayed.

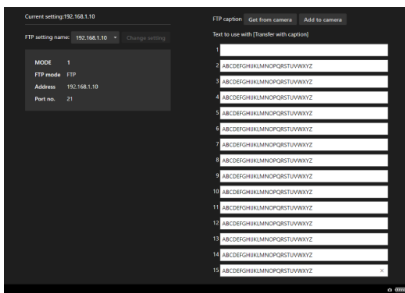

2. Select registered connection settings of the FTP server to use.

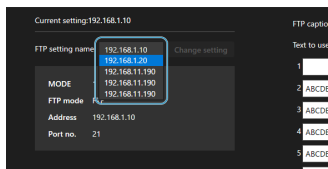

3. Select [Change setting].

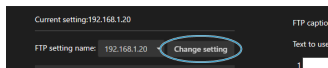

- The camera's connection settings are changed to your selected settings.

Creating and Registering Captions

You can create captions and register them on the camera to use them as described in [Adding a Caption Before Transfer](#).

1. Select [FTP settings].

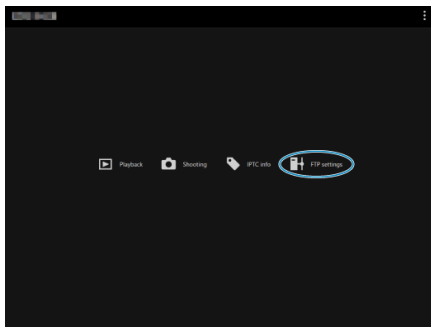

- The FTP setting screen is displayed.

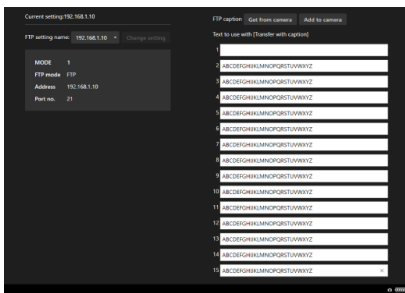

2. Enter the caption or captions.



- Enter up to 31 characters (in ASCII format).
- To acquire caption data stored on the camera, select [**Get from camera**].

3. Set the captions on the camera.

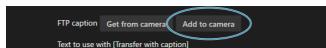

- Select [**Add to camera**] to set your new captions on the camera.

Ending Connections or Reconnecting

[Ending Connections](#)

[Reconnecting](#)

Ending Connections

1. Select [: Network settings].

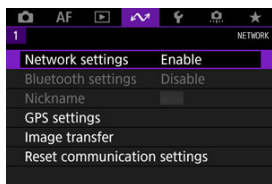

2. Select [Connection settings].

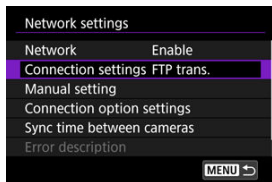

3. Select [Disconnect].

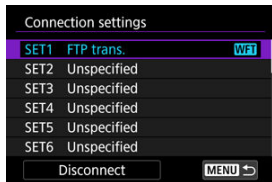

- The devices are disconnected.

1. Select [**Network settings**].

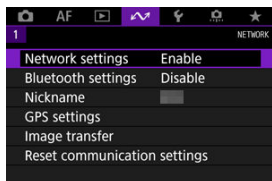

2. Select [**Connection settings**].

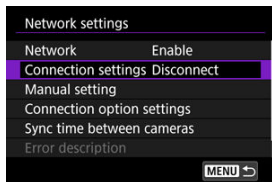

3. Select [**SET***].

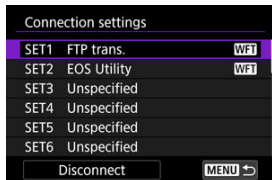

- In the saved settings, select settings to use for the connection.

4. Select [**Connect**].

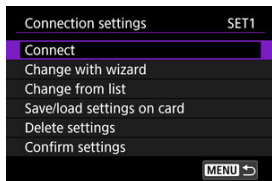

5. Select [OK].

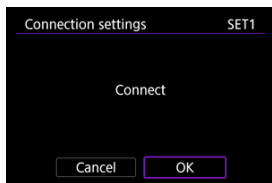

- The devices are connected again.
- If settings were changed on the target device, restore the previous settings to enable connections by the camera.

Checking and Editing Network Settings

- [☑ Checking and Editing Connection Settings](#)
- [☑ Manually Editing Connection Settings](#)
- [☑ Specifying Connection Options](#)
- [☑ Checking the MAC Address](#)

Checking and Editing Connection Settings

You can check, change, or delete connection settings saved on the camera.

1. Select [: Network settings].

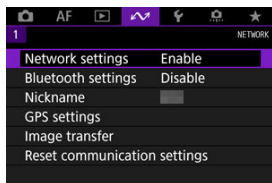

2. Select [Connection settings].

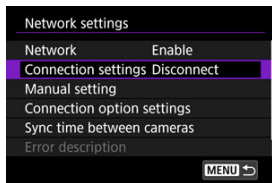

3. Select [SET*].

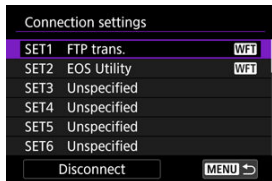

- In the saved settings, select settings to use for the connection.

4. Check or change the settings.

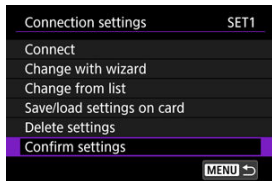

- **Connect**

- Select to re-establish a connection (🔗).

- **Change with wizard/Change from list**

- Change connection settings (🔗).

- **Save/load settings on card**

- Save connection settings to a card, or load saved connection settings from a card into the camera (🔗).

- **Delete settings**

- Select to delete connection settings.

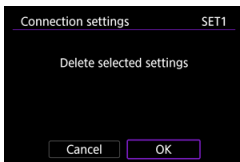

- Selecting [OK] deletes the settings.

- **Confirm settings**

- Select to check connection settings.

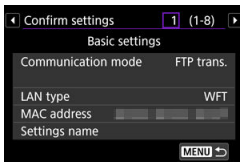

Changing connection settings

Settings originally completed using the connection wizard can be changed as follows.

Change with wizard

You can use the connection wizard to change connection settings saved on the camera.

1. Access the [Connection settings] screen.
 - Follow steps 1–3 in [Checking and Editing Connection Settings](#).
2. Select [Change with wizard].

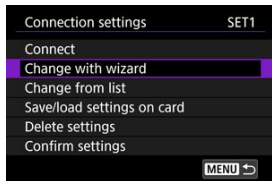

3. Use the connection wizard to change connection settings.

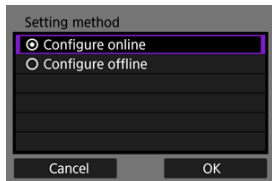

- See instructions starting with [Displaying the Connection Wizard](#).

Change from list

You can use communication and function settings saved on the camera to change connection settings saved on the camera. You can also register settings names.

1. Access the [Connection settings] screen.

- Follow steps 1–3 in [Checking and Editing Connection Settings](#).

2. Select [Change from list].

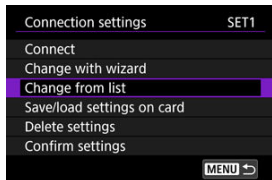

3. Select an item and change setting details as needed.

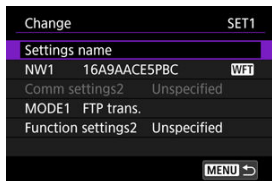

● Settings name

- Select to name sets of settings. Use the virtual keyboard (⌨) to enter text.

● **NW*/Comm settings***

- Select to change, add, or clear communication settings.

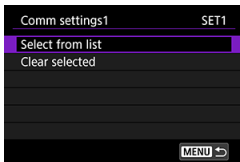

- Selecting [**Select from list**] lists communication settings saved on the camera. Select the communication settings to use.
- Selecting [**Clear selected**] clears communication settings with registered connection settings. Select [**OK**] on the confirmation screen.

● **MODE*/Function settings***

- Select to change, add, or clear function settings.

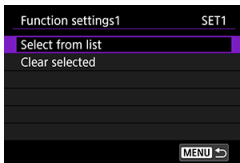

- Selecting [**Select from list**] lists function settings saved on the camera. Select the function settings to use.
- Selecting [**Clear selected**] clears function settings with registered connection settings. Select [**OK**] on the confirmation screen.



Note

- You can register two sets of communication and function settings to a single set of connection settings.
- Clearing all function settings also clears communication settings, and the connection settings will be labeled [**Unspecified**].

Saving and loading settings

Connection settings can be saved on a card and applied to other cameras. Connection settings configured on other cameras can also be applied to the camera you will use.

Note

- [🔑: **Save/load cam settings on card**] enables you to save all communication settings on the camera to a card or load all communication settings for another camera from a card.

Saving settings

1. Access the [Connection settings] screen.
 - Follow steps 1–3 in [Checking and Editing Connection Settings](#).
2. Select [Save/load settings on card].

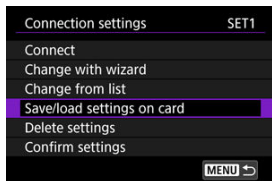

3. Select [Save settings to card].

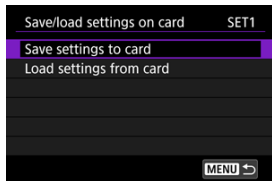

4. Select [OK].

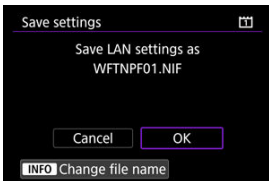

- The file name is determined automatically by the camera: WFTNPF, followed by a number (01 to 40) and the extension NIF. To rename the file as desired, press the <INFO> button.
- The settings are saved to the card.
- The settings file is saved to an area of the card shown when the card is opened (in the root directory).

⚠ Caution

- 40 settings files can be saved on one card from the camera. To save more than 41, use another card.

1. Access the [Connection settings] screen.
 - Follow steps 1–3 in [Checking and Editing Connection Settings](#).

2. Select [Save/load settings on card].

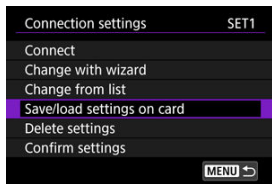

3. Select [Load settings from card].

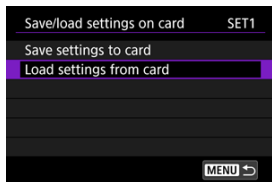

4. Select a settings file.

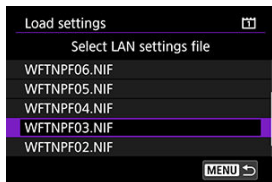

- Select a settings file that matches your network environment.

5. Select [OK].

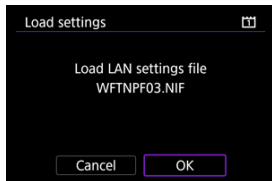

- Information from the settings file is loaded into the selected settings number.

Caution

- Even if a computer or other device is used to save more than 41 settings files on a card, only 40 are displayed on the camera's screen for loading settings. To load more than 41 settings files, load 40 from one card, then load remaining files from another card.

Note

- **[ Save/load cam settings on card]** enables you to save all communication settings on the camera to a card or load all communication settings for another camera from a card.

Manually Editing Connection Settings

You can add, change, or delete communication and function settings saved on the camera. You can also configure settings that are not set using the connection wizard, such as a setting that determines what happens if files with the same name as existing files are sent to the FTP server.

Editing communication settings

1. Select [**W**]: Network settings].

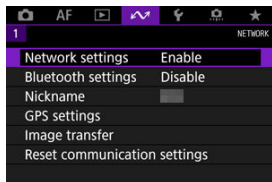

2. Select [Manual setting].

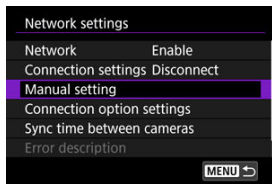

3. Select [Comm settings].

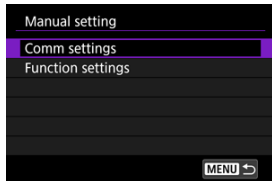

4. Select [NW*].

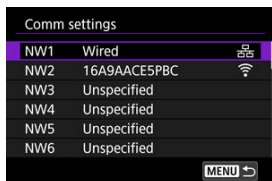

- Select settings labeled [Unspecified] or other saved settings to edit.

5. Change, delete, or check the settings as needed.

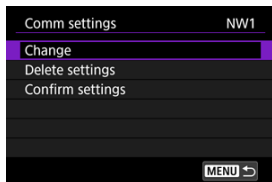

● Change

- Select to change individual settings in sets of communication settings.

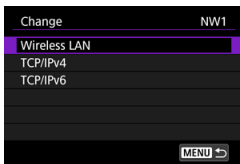

- Selecting [**Wireless LAN**] enables you to change the target SSID, for example.
- Selecting [**TCP/IPv4**] enables you to configure network-related settings such as the IP address.
- Selecting [**TCP/IPv6**] enables you to configure settings used for IPv6 (🔗).
- Depending on the communication setting, not all items may be displayed.

● Delete settings

- Select to delete communication settings.

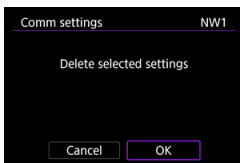

- Selecting [**OK**] deletes the settings.

● Confirm settings

- Select to check communication settings.

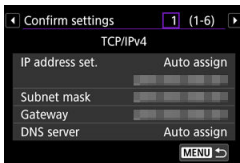

Editing function settings

1. Select [**Network settings**].

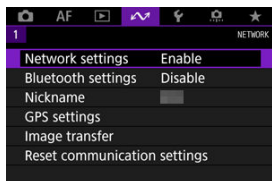

2. Select [**Manual setting**].

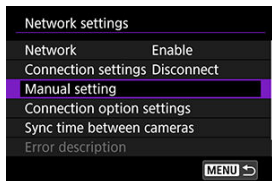

3. Select [**Function settings**].

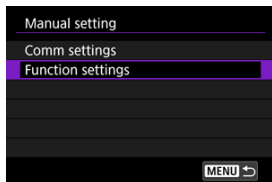

4. Select [**MODE***].

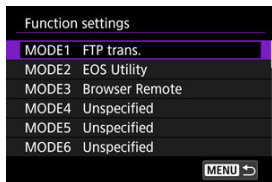

- Select settings labeled [**Unspecified**] or other saved settings to edit.

5. Change, delete, or check the settings as needed.

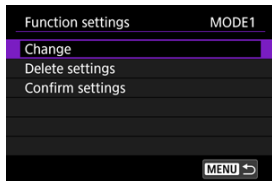

● Change

- Only available when editing FTP transfer settings.
- Selecting **[FTP server]** enables you to configure settings related to the FTP server.

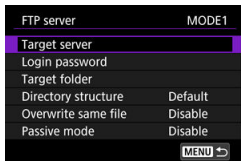

[Directory structure of the target folder](#)

[Overwriting files of the same name](#)

[Passive mode](#)

[Trusting target servers](#)

● Delete settings

- Select to delete function settings.

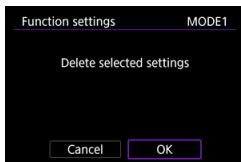

- Selecting **[OK]** deletes the settings.

● **Confirm settings**

- Select to check function settings.

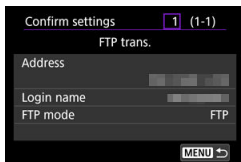

Directory structure of the target folder

Configured in **[FTP server]** → **[Directory structure]**.

With **[Default]**, the root folder is used for image storage. If you have created a subfolder in the root folder by changing the **[Target folder]** setting, images are saved in that folder. Selecting **[Camera]** automatically creates a folder structure matching that of the camera's (such as A/DCIM/100EOS1D) in the server's root folder for image storage. If you have created a subfolder in the root folder by changing the **[Target folder]** setting, a folder structure such as A/DCIM/100EOS1D is automatically created in that folder for image storage.

Overwriting files of the same name

Configured in **[FTP server]** → **[Overwrite same file]**.

With [Overwrite same file] set to [Disable]

If there is already a file with the same name in the target folder on the FTP server, the new file is saved with an extension consisting of an underscore and a number, as in IMG_0003_1.JPG.

When you resend images if initial transfer fails

Even if the camera is configured to overwrite files of the same name, if you resend an image file that could not be transferred initially, the existing file may not be overwritten in some cases. If this happens, the new file is saved with an extension consisting of an underscore, a letter, and a numeral, as in IMG_0003_a1.JPG.

Passive mode

Configured in **[FTP server]** → **[Passive mode]**.

Enable this setting in network environments protected by a firewall. If an Error 41 occurs (Cannot connect to FTP server), setting passive mode to **[Enable]** may enable access to the FTP server.

Trusting target servers

Configured in **[FTP server]** → **[Trust target server]**.

Set to **[Enable]** if you prefer to connect to FTP servers even when trust cannot be established based on the root certificate used. In this case, take suitable security measures.

Specifying Connection Options

You can configure settings used for FTP transfer and Browser Remote. Settings are also available for authentication information used in LAN environments with 802.1X authentication.

1. Select []: Network settings].

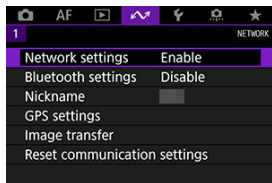

2. Select [Connection option settings].

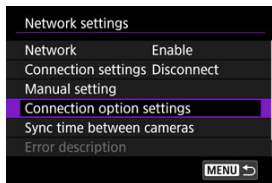

3. Select an item to configure.

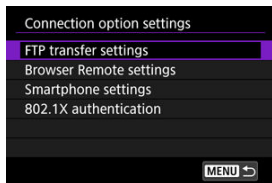

- [FTP transfer settings](#)
- [Browser Remote settings](#)
- [802.1X authentication](#)

FTP transfer settings

Selecting **[FTP transfer settings]** enables you to configure settings related to FTP transfer and power saving.

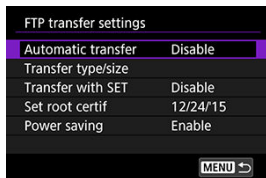

- **Automatic transfer/Transfer type/size/Transfer with SET/Set root certif**
 - For details, see [Image Transfer to FTP Servers](#).
- **Power saving**
 - When **[Enable]** is set and no image is transferred for a certain period, the camera will log off from the FTP server and disconnect from the LAN. The connection is re-established automatically when the camera is ready for image transfer again. If you prefer not to disconnect from the LAN, set to **[Disable]**.

Browser Remote settings

Selecting **[Browser Remote settings]** enables you to set the account used for Browser Remote access and configure HTTP/HTTPS communication settings.

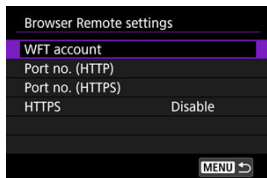

- **WFT account**

- For details, see [Configuring Browser Remote Connection settings](#).

- **Port no. (HTTP)/Port no. (HTTPS)**

- You can change the port number used for HTTP/HTTPS communication. There is normally no need to change the port number (80 for HTTP, 443 for HTTPS).

- **HTTPS**

- Selecting **[Enable]** enables HTTPS communication for Browser Remote access.

802.1X authentication

Selecting **[802.1X authentication]** enables you to set, check, or delete 802.1X authentication settings, using a setup wizard.

Configure these settings when connecting to networks that require 802.1X authentication.

First, save the certificate for the type of 802.1X authentication used to a card in the camera. File types and names that can be loaded using this function are as follows.

Type	File Name
Root certificate	8021X_R.CER
	8021X_R.CRT
	8021X_R.PEM
Client certificate	8021X_C.CER
	8021X_C.CRT
	8021X_C.PEM
Private key	8021X_C.KEY

Note that the camera supports following protocols.

Protocol	Supported Authentication
EAP-TLS	X.509
EAP-TTLS	MSCHAPv2
PEAP	MSCHAPv2

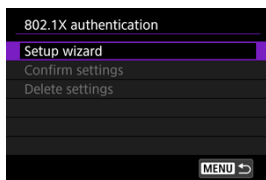

- **Setup wizard**

- Follow the wizard to configure the authentication settings.

- **Confirm settings**

- Select to check authentication settings.

- **Delete settings**

- Select to delete authentication settings. Selecting **[OK]** on the screen displayed deletes the settings.

Checking the MAC Address

You can check the camera's MAC address.

1. Select [**Network settings**].

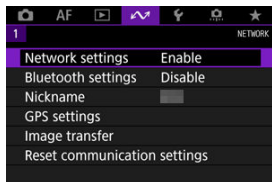

2. Select [**MAC address**].

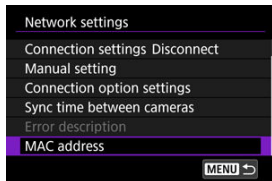

3. Check the MAC address.

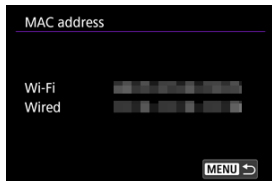

- The MAC addresses for [**Wi-Fi**] and [**Wired**] are displayed.

Syncing Time Between Cameras

 [Preparing for Time Syncing](#)

 [Syncing the Time](#)

You can set the sender camera time on up to 10 receiver cameras. Note that even after synchronization, a slight margin of error applies between sender and receiver camera time (of ± 0.05 seconds, at most).

Caution

- Always use cameras of the same model to sync the time. Synchronizing the time on receiver cameras is not possible with different models of the sender and receiver cameras.
- This feature will not be available after 2038.

Preparing for Time Syncing

When using a single receiver camera, connect a LAN cable to the Ethernet terminal of the sender and receiver cameras.

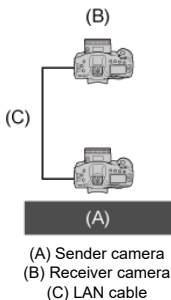
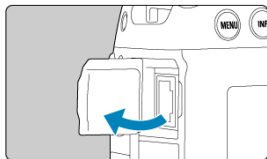

- (A) Sender camera
- (B) Receiver camera
- (C) LAN cable

When using multiple receiver cameras, connect a LAN cable from the Ethernet terminal of the sender and receiver cameras to a hub. Up to 10 receiver cameras can be connected.

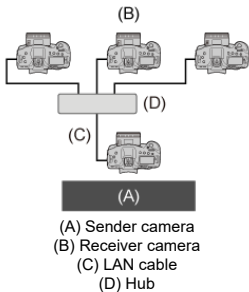

- (A) Sender camera
- (B) Receiver camera
- (C) LAN cable
- (D) Hub

Use a highly shielded Category 5e or higher STP (Shielded Twisted Pair) Gigabit Ethernet cable.

Syncing the Time

Preparing the sender camera

First, set up the camera to use as a sender.

1. On the camera, press the <MENU> button.
2. Select [: Network settings].

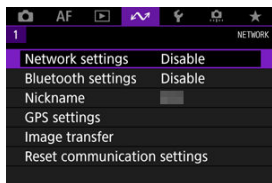

3. Select [Enable].

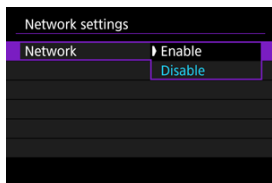

4. Select [Sync time between cameras].

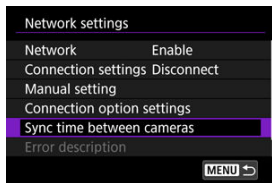

- If the camera is already connected to another device, [Set [Connection settings] to [Disconnect]] is displayed. Select [OK] to end the connection.

5. Select **[OK]**.

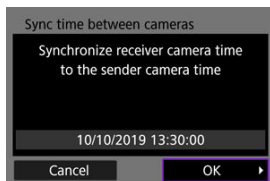

6. Select **[OK]**.

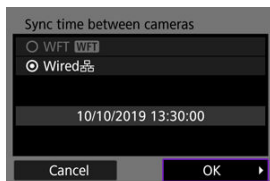

7. Select **[Sender]**.

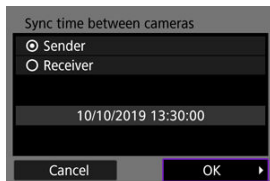

- Select **[OK]** to go to the next screen.
- After the screen is displayed, the camera is ready.

Preparing receiver cameras

Set up cameras to use as receivers.

1. Follow steps 1–6 in **Preparing the Sender Camera**.
2. Select **[Receiver]**.

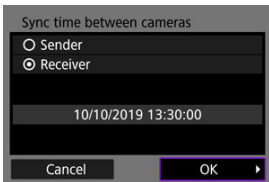

- Select **[OK]** to go to the next screen.

3. Select **[OK]**.

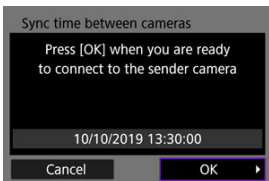

- The following screen is displayed.

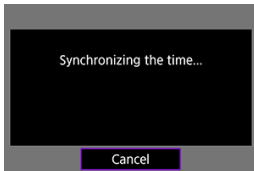

- To set the time on multiple receiver cameras, follow steps 1–2 on each receiver camera.
- The number of receiver cameras detected is displayed on the sender camera screen.

Syncing time between sender and receiver cameras

Sync the time on the sender and receiver cameras as follows.

1. Follow steps 1–6 in **Preparing the sender camera** and steps 1–3 in **Preparing receiver cameras**.
2. On the sender camera, select **[OK]**.

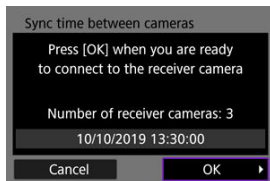

- Check the number of receiver cameras, then select **[OK]**.
- After the time is synchronized, the next screen is displayed.

3. Select **[OK]** on all of the cameras.

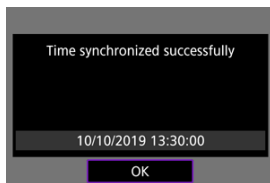

GPS Features

 [GPS Settings](#)

 [GPS Precautions](#)

GPS features of the camera can be used to geotag images, set the time, and more. The camera can receive signals from GPS satellites (USA), GLONASS satellites (Russia), and the Quasi-Zenith Satellite System "Michibiki" (Japan).

Caution

- Geotag information may not be recorded or inaccurate information may be recorded where GPS signal coverage is poor, such as in the following places.
 - Indoors, underground, near or between buildings, in tunnels or forests
 - Near high-voltage power lines or mobile phones operating on the 1.5 GHz band
 - When the camera is carried in a bag or other container
 - When traveling long distances
 - When traveling through different environments
 - Even in conditions other than these, GPS satellite movement over time may interfere with geotagging and cause missing or inaccurate geotag information. The information may also indicate that the camera was used along a route even if it was used at one location.
- Elevation is not as accurate as latitude or longitude, due to the nature of GPS.
- Inside the camera, the GPS antenna is near the front of the hot shoe. Although GPS signals can also be acquired with a Speedlite attached, acquisition sensitivity will be slightly lower.
- When carrying the camera in a bag or other container, make sure it is face-up with nothing covering it.
- Set the camera time and date as accurately as possible. Also set the correct time zone and daylight saving time for the shooting location.
- Fewer shots are available in locations with poor signal coverage.
- Remaining battery capacity may be lower when GPS features are used. Charge the battery as needed, or consider purchasing a spare battery (sold separately).
- Others may be able to locate or identify you by using information in your geotagged still photos or movies. Be careful when sharing these images with others, as when posting images online where many people can view them.

1. Select [📶]: GPS settings].

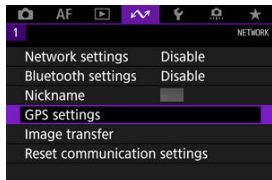

2. Configure GPS details.

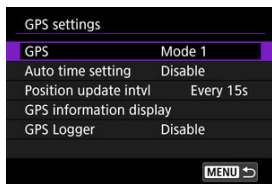

[GPS]

Specify the GPS operating mode.

- In **[Mode 1]**, the camera continues to acquire GPS signals at regular intervals with the power switch set to < **ON** > or even < **OFF** >.
- In **[Mode 2]**, the camera acquires GPS signals with the power switch set to < **ON** >. Setting the power switch to < **OFF** > also deactivates GPS features. Note that after auto power off is activated, the camera continues to receive GPS signals at regular intervals.

When acquiring GPS signals, use the camera outdoors where the sky is unobstructed and aim it up, keeping your hand and other objects off the top. Signal acquisition under favorable conditions takes approx. 30–60 sec., and then **[GPS]** is lit on the rear LCD panel or screen. Shots taken when **[GPS]** is lit are geotagged.



⚠ Caution

- When **[Mode 1]** is set, the camera continues to acquire GPS signals at regular intervals even with the power switch set to < **OFF** >, which drains the battery faster and reduces the number of shots available. Set to **[Disable]** if you will not use the camera for some time.
- If auto power off continues for an extended period in **[Mode 2]**, the battery will be drained faster and fewer shots will be available. Set the power switch to < **OFF** > if you will not use the camera for some time.

[Auto time setting]

Time information acquired from GPS signals can be set on the camera. The margin of error is approx. ± 0.02 sec. Selecting **[Auto update]** will update the time when GPS signals are received while the camera is on.

Caution

- The time cannot be automatically updated unless signals from at least five GPS satellites can be acquired. **[Set now]** will be grayed-out and unavailable.
- Even if **[Set now]** can be selected, time adjustment may not be possible, depending on the timing of GPS signal acquisition.
- Setting **[Auto time setting]** to **[Auto update]** prevents the date or time from being manually set with **[📌: Date/Time/Zone]** ()
- If you have performed **[Sync time between cameras]** and prefer not to have the time adjusted, set **[Auto time setting]** to **[Disable]**.

[Position update intvl]

You can set the positioning interval (time) for updating geotag information. Although tagging is more accurate when the geotag information is updated at shorter intervals, this reduces the number of shots available because it drains the battery faster.

Caution

- Some inconsistency in positioning intervals is inevitable, due to the nature of GPS.

[GPS information display]

Shows acquired GPS information.

The <  > icon indicates signal conditions. When [3D] is displayed, elevation is also recorded. Note that elevation is not recorded when [2D] is displayed.

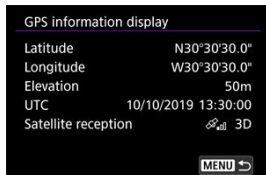

You can check geotag information by displaying a shot, pressing the < INFO > button to access the shooting information screen, and then pressing <  >.



- (1) Latitude
- (2) Longitude
- (3) Elevation
- (4) Coordinated Universal Time (UTC)

Note

- Movies are tagged with the geotag information acquired when you start recording. Note that signal reception conditions are not recorded.
- Coordinated Universal Time, abbreviated as UTC, is essentially the same as Greenwich Mean Time.

GPS Logger

By setting [**Log GPS position**] to [**Enable**], you can automatically record geotag information at specific intervals along the route that the camera travels. Geotag information is recorded at the interval set in [**Position update intvl**] as log data saved in the camera's internal memory by date. You can also view the route traveled on a map displayed on a computer.

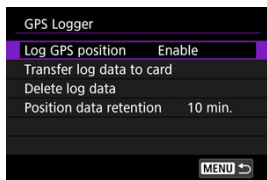

Position update intervals and log data capacity (in days) are as follows.

(Approx.)

Update Interval	Log Data	Update Interval	Log Data
Every sec.	4.1 days	Every 30 sec.	100 days
Every 5 sec.	20 days	Every min.	100 days
Every 10 sec.	41 days	Every 2 min.	100 days
Every 15 sec.	61 days	Every 5 min.	100 days

* With one day being equivalent to eight hours of log data

- Names of daily log files consist of the date and number (such as 19101000). New log file are created if the camera enters a new time zone (🌐).
- When the camera's internal memory becomes full, old log data is overwritten with new data.

⚠ Caution

- In [**Mode 1**], GPS logging continues even with the power switch set to <OFF>.
- In [**Mode 2**], setting the power switch to <OFF> deactivates GPS logging. However, GPS logging continues during auto power off.
- Geotag information added to images may be inaccurate under some traveling conditions, in some locations, or under some GPS settings.

Transferring log data to a card

You can transfer recorded log data to a card selected in [**Transfer log data to card**].

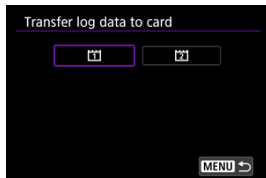

- Transferring log data to a card erases the data from the camera's internal memory.
- Log files transferred to a card are stored in the "GPS" folder within the "MISC" folder. They are saved with a ".LOG" file extension.
- Log files (.LOG) can be converted to KMZ format with GPS Log File Utility ([🔗](#)).

Deleting log data

To delete log data in internal memory, select [**Delete log data**], then select [**OK**]. It may take approx. 1 min. to delete the data.

Position data retention

To continue geotagging images even where satellite coverage is poor (if you go indoors, for example) by using geotag information in log data, setting [**Position data retention**] to [**Unlimited**] is recommended. The most recently acquired geotag information is added to log data until new information can be acquired.

When a time such as [**10 min.**] is set, after geotag information cannot be acquired, the most recent geotag information is added to log data for the specified period.

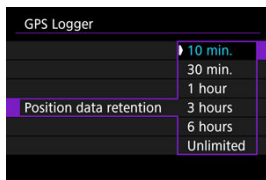

Countries/regions permitting use of GPS functions

Use of GPS features is restricted in some countries and regions, and illegal use may be punishable under national or local regulations. To avoid violating GPS regulations, visit the Canon website to check where use is allowed.

Note that Canon cannot be held liable for any problems arising from use of GPS functions in other countries and regions.

Model number

EOS-1D X Mark III: DS126631 (GPS module model: ES300)

- Because the use of GPS may be restricted in some countries and regions, follow local laws and regulations where you will use the camera. Be particularly careful about using GPS functions outside your home country.
- Be careful about using GPS functions where the operation of electronic devices is restricted.
- Others may be able to locate or identify you by using location data in your geotagged still images or movies. Be careful when sharing these geotagged still images, movies, or GPS log files with others, such as when posting them online where many people can view them.
- GPS signal reception may take a longer time in some cases.

Reference

- ☑ [Changing the Camera Nickname](#)
- ☑ [Virtual Keyboard Operations](#)
- ☑ [Configuring IPv6](#)

Changing the Camera Nickname

You can change the nickname of this camera (displayed on connected devices) as desired.

1. Select [: Nickname].

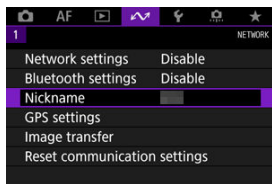

2. Enter text using the [virtual keyboard](#).

- When you finish entering characters, press the < MENU > button.

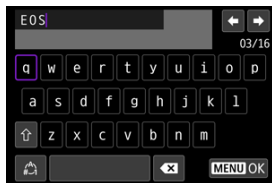



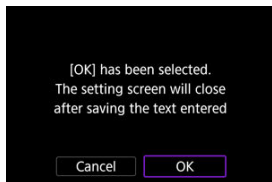

3. Select [OK].

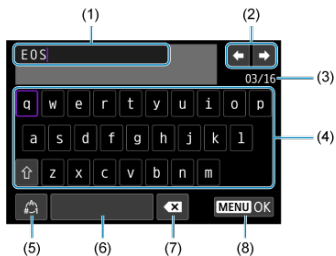

Virtual Keyboard Operations



-
- (1) Input area, for entering text
 - (2) Cursor keys, for moving in the input area
 - (3) Current no. of characters/no. available
 - (4) Keyboard
 - (5) Switch input modes
 - (6) Space
 - (7) Delete a character in the input area
 - (8) Finish the text entry
-

Use <  > or the <  > or <  > dial to move within (2) and (4)–(7).
Press <  > to confirm input or when switching input modes.

Configuring IPv6

To use IPv6, configure the settings manually.

Note

- If you are unsure what to enter, ask the network administrator or other person in charge of the network.

1. Select [: Network settings].

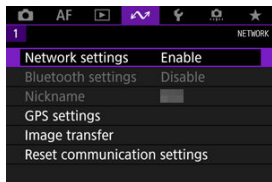

2. Select [Manual setting].

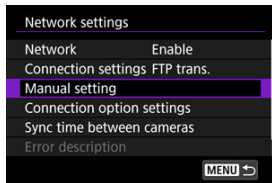

3. Select [Comm settings].

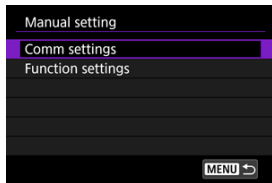

4. Select the communication settings that will use IPv6.

Comm settings		
NW1	16A9AAACE5PBC	WIFI
NW2	Unspecified	
NW3	Unspecified	
NW4	Unspecified	
NW5	Unspecified	
NW6	Unspecified	

MENU →

5. Select [Change].

Comm settings		NW1
Change		
Delete settings		
Confirm settings		

MENU →

6. Select [TCP/IPv6].

Change		NW1
Wireless LAN		
TCP/IPv4		
TCP/IPv6		

MENU →

7. Select an item to configure.

TCP/IPv6		NW1
Use TCP/IPv6	Disable	
Manual setting	Disable	
DNS server	Auto assign	
DNS address		
Manual address		
Prefix length	64	

MENU →

● Use TCP/IPv6

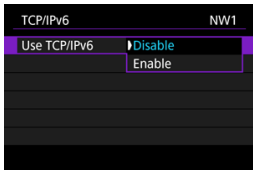

- Select **[Enable]** or **[Disable]** for IPv6.

● Manual setting

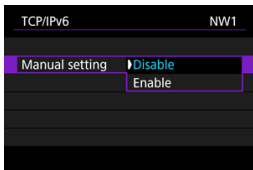

- To set the IP address manually, select **[Enable]**. **[DNS server]** is set to **[Manual setting]**, and you can configure **[DNS address]**, **[Manual address]**, **[Prefix length]**, and **[Gateway]**.

● DNS server

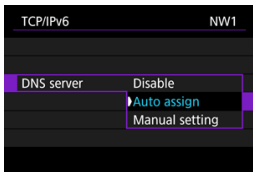

- To set the DNS server IP address manually, select **[Manual setting]**.
- Select **[Disable]** if you will not use a DNS server.
- If the setting is currently **[Auto assign]**, setting **[Manual setting]** to **[Enable]** changes it to **[Manual setting]**.

- **DNS address/Manual address/Gateway**

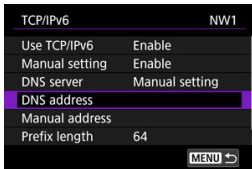

- Select an item and enter the IP address.



- **Prefix length**



- To set the prefix length, turn the <  > dial to select a value (1–128).

Troubleshooting

- [☑ Responding to Error Messages](#)
- [☑ Troubleshooting Guide](#)
- [☑ Communication Function Precautions](#)
- [☑ Security](#)
- [☑ Checking Network Settings](#)

Responding to Error Messages

Resolve any errors displayed on the camera screen by referring to these examples of corrective actions. When errors occur, the <LAN> lamp on the camera blinks and the error number is shown on the LCD panel. You can also check error details by accessing [: **Network settings**] → [**Error description**].

Click the following error numbers to jump to the corresponding section.

11	12						
21	22	23					
41	43	44	45	46	47	48	
61	63	64	65	66	67	68	69
71	72	73					
81	83						
91							

11: Connection target not found

- **In the case of [Smartphone], is Camera Connect running?**
 - Establish a connection using Camera Connect (🔗).
- **In the case of [EOS Utility], is EOS Utility running?**
 - Start EOS Utility and try to connect again (🔗).
- **Are the camera and the access point set to use the same encryption key for authentication?**
 - This error occurs if the encryption keys do not match when the authentication method for encryption is **[Open system]**.
Check upper- and lower-case letters, and make sure the correct encryption key for authentication is set on the camera (🔗).

12: Connection target not found

- **Are the target device and access point turned on?**
 - Turn on the target device and access point, then wait a while. If a connection still cannot be established, perform the procedures to establish the connection again.

21: No address assigned by DHCP server

What to check on the camera

- **On the camera, the IP address is set to [Auto setting]. Is this the correct setting?**
 - If no DHCP server is used, configure the setting after setting the IP address to **[Manual setting]** on the camera (🔗).

What to check on the DHCP server

- **Is the power of the DHCP server on?**
 - Turn on the DHCP server.
- **Are there enough addresses for assignment by the DHCP server?**
 - Increase the number of addresses assigned by the DHCP server.
 - Remove devices assigned addresses by the DHCP server from the network to reduce the number of addresses in use.
- **Is the DHCP server working correctly?**
 - Check the DHCP server settings to make sure it is working correctly as a DHCP server.
 - If applicable, ask your network administrator to ensure the DHCP server is available.

What to check on the network as a whole

- **Does your network include a router or similar device that serves as a gateway?**
 - If applicable, ask your network administrator for the network gateway address and set it on the camera (🔗, 🔗).
 - Make sure that the gateway address setting is correctly entered on all network devices including the camera.

Note

Responding to error messages 21–23

- Also check the following points when responding to errors numbered 21–23.
Are the camera and the access point set to use the same password for authentication?
 - This error occurs if the passwords do not match when the authentication method for encryption is set to **[Open system]**. Check upper- and lower-case letters, and make sure the correct password for authentication is set on the camera (🔗).

22: No response from DNS server

What to check on the camera

- **On the camera, the DNS address is set to [Manual setting]. Is this the correct setting?**
 - If no DNS server is used, set the camera's DNS address setting to [Disable] (🔗).
- **On the camera, does the DNS server's IP address setting match the server's actual address?**
 - Configure the IP address on the camera to match the actual DNS server address (🔗, 🔗).

What to check on the DNS server

- **Is the power of the DNS server on?**
 - Turn on the DNS server.
- **Are the DNS server settings for IP addresses and the corresponding names correct?**
 - On the DNS server, make sure IP addresses and the corresponding names are entered correctly.
- **Is the DNS server working correctly?**
 - Check the DNS server settings to make sure it is working correctly as a DNS server.
 - If applicable, ask your network administrator to ensure the DNS server is available.

What to check on the network as a whole

- **Does your network include a router or similar device that serves as a gateway?**
 - If applicable, ask your network administrator for the network gateway address and set it on the camera (🔗, 🔗).
 - Make sure that the gateway address setting is correctly entered on all network devices including the camera.

23: Device with same IP address exists on selected network

- **Is another device on the camera network using the same IP address as the camera?**
 - Change the camera's IP address to avoid using the same address as another device on the network. Otherwise, change the IP address of the device that has a duplicate address.
 - If the camera's IP address is set to [Manual setting] in network environments using a DHCP server, change the setting to [Auto setting] (🔗).

What to check on the camera

- **The camera's proxy server setting is [Enable]. Is this the correct setting?**
 - If no proxy server is used, set the camera's proxy server setting to [Disable] (🔗).
- **Do the camera's [Address setting] and [Port No.] settings match those of the proxy server?**
 - Configure the camera's proxy server address and port number to match those of the proxy server (🔗).
- **Are the camera's proxy server settings correctly set on the DNS server?**
 - Make sure the proxy server's [Address] is correctly set on the DNS server.
- **On the camera, does the FTP server's IP address setting match the server's actual address?**
 - Configure the IP address on the camera to match the actual FTP server address (🔗).
- **Are the camera and the access point set to use the same encryption key for authentication?**
 - This error occurs if the encryption keys do not match when the authentication method for encryption is [Open system].
Check upper- and lower-case letters, and make sure the correct encryption key for authentication is set on the camera (🔗).
- **On the camera, does the [Port number setting] for the FTP server match the actual port number of the FTP server?**
 - Configure the same port number (usually 21 for FTP/FTPS or 22 for SFTP) on the camera and FTP server. Configure the port number on the camera to match the actual FTP server port number (🔗).
- **Are the camera's FTP server settings correctly set on the DNS server?**
 - Make sure the FTP server's [Server name] is correctly set on the DNS server. Make sure the [Server name] for the FTP server is correctly set on the camera (🔗).

What to check on the FTP server

- **Is the FTP server working correctly?**
 - Configure the computer correctly to function as an FTP server.
 - If applicable, ask your network administrator for the FTP server address and port number, then set them on the camera.
- **Is the FTP server on?**
 - Turn on the FTP server. The server may have been turned off because of an energy-saving mode.

- **On the camera, does the FTP server's IP address setting (in [Address]) match the server's actual address?**
 - Configure the IP address on the camera to match the actual FTP server address (🔗).
- **Is the FTP server configured to restrict access to only some IP addresses?**
 - Check the camera's IP address in [Confirm settings] (🔗) and change the FTP server settings.
- **Is a firewall or other security software enabled?**
 - Some security software uses a firewall to restrict access to the FTP server. Change the firewall settings to allow access to the FTP server.
 - You may be able to access the FTP server by setting [Passive mode] to [Enable] on the camera (🔗).
- **Are you connecting to the FTP server via a broadband router?**
 - Some broadband routers use a firewall to restrict access to the FTP server. Change the firewall settings to allow access to the FTP server.
 - You may be able to access the FTP server by setting [Passive mode] to [Enable] on the camera (🔗).

What to check on the proxy server

- **Is the proxy server on?**
 - Turn on the proxy server.
- **Is the proxy server working correctly?**
 - Check the proxy server settings to make sure the server is working correctly as a proxy server.
 - If applicable, ask your network administrator for the proxy server's address setting and port number, then set them on the camera.

What to check on the network as a whole

- **Does your network include a router or similar device that serves as a gateway?**
 - If applicable, ask your network administrator for the network gateway address and set it on the camera (🔗, 🔗).
 - Make sure that the gateway address setting is correctly entered on all network devices including the camera.

43: Cannot connect to FTP server. Error code received from server.

What to check on the proxy server

- **Is the proxy server on?**
 - Turn on the proxy server.
- **Is the proxy server working correctly?**
 - Check the proxy server settings to make sure the server is working correctly as a proxy server.
 - If applicable, ask your network administrator for the proxy server's address setting and port number, then set them on the camera.

What to check on the network as a whole

- **Does your network include a router or similar device that serves as a gateway?**
 - If applicable, ask your network administrator for the network gateway address and set it on the camera (🌐, 🌐).
 - Make sure that the gateway address setting is correctly entered on all network devices including the camera.

What to check on the FTP server

- **Have you exceeded the maximum number of FTP server connections?**
 - Disconnect some network devices from the FTP server or increase the maximum number of connections.

44: Cannot disconnect FTP server. Error code received from server.

- **This error occurs from a failure to disconnect from the FTP server for some reason.**
 - Restart the FTP server and camera.

45: Cannot login to FTP server. Error code received from server.

What to check on the camera

- **On the camera, is the [Login name] set correctly?**
 - Check the login name for accessing the FTP server. Check upper- and lower-case letters, and make sure the correct login name is set on the camera (🔗).
- **On the camera, is the [Login password] set correctly?**
 - Check upper- and lower-case letters, and make sure the correct login password is set on the camera (🔗).

What to check on the FTP server

- **Do the user rights for the FTP server allow reading, writing, and log access?**
 - Configure the FTP server's user rights to allow reading, writing, and log access.
- **Is the folder specified as the transfer destination on the FTP server named with ASCII characters?**
 - Use ASCII characters for the folder name.

46: For the data session, error code received from FTP server

What to check on the FTP server

- **The connection was terminated by the FTP server.**
 - Restart the FTP server.
- **Do the user rights for the FTP server allow reading, writing, and log access?**
 - Configure the FTP server's user rights to allow reading, writing, and log access.
- **Do user rights allow access to the target folder on the FTP server?**
 - Configure the user rights for access to the target folder on the FTP server to allow saving images from the camera.
- **Is the FTP server on?**
 - Turn on the FTP server. The server may have been turned off because of an energy-saving mode.
- **Is the hard disk of the FTP server full?**
 - Increase available space on the hard disk.

47: Image file transfer completion not confirmed by FTP server

- **This error occurs from a failure to receive confirmation from the FTP server that image file transfer is complete for some reason.**
 - Restart the FTP server and camera and send the images again.

48: Security of the connection to the target server cannot be verified. If you trust this server and connect, set [Trust target server] to [Enable].

- **This error occurs from a failure to confirm security of the target server connection when connecting via FTPS.**
 - Confirm that the certificate is set correctly.
 - Change [Trust target server] to [Enable] if you prefer to trust target servers regardless of certificate settings.

61: Selected SSID wireless LAN network not found

- **Are any obstacles blocking the line of sight between the camera and the antenna of the access point?**
 - Move the antenna of the access point to a position clearly visible from the point of view of the camera.

What to check on the camera

- **Does the SSID set on the camera match that of the access point?**
 - Check the SSID at the access point, then set the same SSID on the camera (🔗).

What to check at the access point

- **Is the access point turned on?**
 - Turn on the power of the access point.
- **If filtering by MAC address is active, is the MAC address of the camera in use registered at the access point?**
 - Register the MAC address of the camera used to the access point (🔗).

63: Wireless LAN authentication failed

- **Are the camera and the access point set to use the same encryption key for authentication?**
 - Check upper- and lower-case letters, and make sure the correct encryption key for authentication is set on the camera (🔗).
- **If filtering by MAC address is active, is the MAC address of the camera in use registered at the access point?**
 - Register the MAC address of the camera at the access point. The MAC address can be checked on the [MAC address] screen (🔗).

64: Cannot connect to wireless LAN terminal

- **Are the camera and the access point set to use the same encryption method?**
 - The camera supports the following encryption methods: WEP, TKIP, and AES (🔗).
- **If filtering by MAC address is active, is the MAC address of the camera in use registered at the access point?**
 - Register the MAC address of the camera used to the access point. The MAC address can be checked on the [MAC address] screen (🔗).

65: Wireless LAN connection lost

- **Are any obstacles blocking the line of sight between the camera and the antenna of the access point?**
 - Move the antenna of the access point to a position clearly visible from the point of view of the camera.
- **The wireless LAN connection was lost, for some reason, and the connection cannot be restored.**
 - The following are possible reasons: excessive access to the access point from another device, a microwave oven or similar appliance in use nearby (interfering with IEEE 802.11n/g/b (2.4 GHz band)), or influence of rain or high humidity.

66: Incorrect wireless LAN password

- **Are the camera and the access point set to use the same encryption key for authentication?**
 - Check upper- and lower-case letters, and make sure the correct encryption key for authentication is set on the camera and access point (🔗).
Note that if the encryption authentication method is [Open system], an Error 41 is displayed (🔗).

67: Incorrect wireless LAN encryption method

- **Are the camera and the access point set to use the same encryption method?**
 - The camera supports the following encryption methods: WEP, TKIP, and AES (🔒).
- **If filtering by MAC address is active, is the MAC address of the camera in use registered at the access point?**
 - Register the MAC address of the camera used to the access point. The MAC address can be checked on the [MAC address] screen (🔒).

68: Cannot connect to wireless LAN terminal. Retry from the beginning.

- **Did you hold down the access point's WPS (Wi-Fi Protected Setup) button for the specified period of time?**
 - Hold down the WPS button for the period of time specified in the access point's instruction manual.
- **Are you trying to establish a connection near the access point?**
 - Try establishing the connection when both devices are within reach of each other.

69: Multiple wireless LAN terminals have been found. Cannot connect. Retry from the beginning.

- **Connection is in progress by other access points in Pushbutton Connection mode (PBC mode) of WPS (Wi-Fi Protected Setup).**
 - Wait a while before trying to establish the connection, or try to establish a connection in PIN code connection mode (PIN mode, (🔒)).

71: Cannot connect to receiver camera

- **Are you following the correct procedure to establish the connection with receiver cameras?**
 - Operate receiver cameras by following the correct instructions.
- **Are the receiver cameras too far from the sender camera?**
 - Bring the receiver cameras closer to the sender camera.

72: Cannot connect to sender camera

- **Are you following the correct procedure to establish the connection with the sender camera?**
 - Operate the sender camera by following the correct instructions.
- **Is the sender camera too far from the receiver cameras?**
 - Bring the sender camera closer to the receiver cameras.

73: Could not synchronize the time

- **Are you following the correct procedure to establish a connection between the sender and receiver camera?**
 - Operate the sender and receiver cameras by following the correct instructions (🔗).
- **Is the sender camera too far from the receiver cameras?**
 - Bring the sender and receiver cameras closer together.

81: Wired LAN connection lost

- **Is the LAN cable securely connected?**
 - Reconnect the LAN cable between the camera and server. Because the cable may be severed, try using another cable to connect the devices.
- **Is the hub or router on?**
 - Turn on the hub or router.
- **Is the server on?**
 - Turn on the server. The server may have been turned off because of an energy-saving mode.

83: Network connection terminated due to overheating

- **Communication has temporarily stopped due to high internal camera temperature, and the camera has ended the wired LAN connection.**
 - Allow the camera to cool down, as by shading it from direct sunlight. Once the camera has cooled down, the connection will be restored automatically.



91: Other error

- **A problem other than error code number 11 to 83 occurred.**
 - Turn the camera's power switch off and on.



Troubleshooting Guide

Troubleshoot camera issues by checking the camera and connected devices as described in this section. If troubleshooting does not resolve the problem, contact a Canon Service Center for product information and advice on product handling.

Cannot transfer images to an FTP server.

- Set the Live View shooting/movie recording switch to <  > if you will transfer images to an FTP server after shooting. Image transfer is not possible with the Live View shooting/movie shooting switch set to <  >.

Cannot perform linked shooting.

- When performing linked shooting, set the Live View shooting/movie shooting switch to <  >. Linked shooting is not possible with the Live View shooting/movie shooting switch set to <  >.

The camera heats up, and the transmission rate drops.

- Continuous wireless operation over an extended period in high temperatures may cause the camera's internal temperature to rise and slow down transfers. Error 83 may be displayed if the camera becomes hotter, and wireless operation may stop ().

Communication Function Precautions

In case of slower transmission, lost connections, choppy image display, or other problems when using communication functions, try the following corrective actions.

Access point and antenna installation location

- When using the camera indoors, install the access point in the same room where you are shooting.
- Install the device where people or objects do not come between the device and the camera.
- Install the device higher than the camera.
- Install the device as close as possible to the camera. In particular, note that during outdoor use in poor weather, rain may absorb radio waves and disrupt the connection.

Nearby electronic devices

If the wireless LAN transmission rate drops due to interference from the following electronic devices, stop using them or establish a connection away from them. Otherwise, switching to a wired LAN can resolve the issue.

- In IEEE 802.11b/g/n wireless networks, the camera communicates on the 2.4 GHz band. For this reason, the wireless LAN transmission rate may drop if there are nearby Bluetooth devices, microwave ovens, cordless telephones, microphones, smartphones, or similar devices operating on the same frequency band.

If security settings have not been properly set, the following problems may occur.

- **Transmission monitoring**
Third parties with malicious intent may monitor wireless LAN transmissions and attempt to acquire the data you are sending.
- **Unauthorized network access**
Third parties with malicious intent may gain unauthorized access to the network you are using to steal, modify, or destroy information. Additionally, you could fall victim to other types of unauthorized access such as impersonation (where someone assumes an identity to gain access to unauthorized information) or springboard attacks (where someone gains unauthorized access to your network as a springboard to cover their tracks when infiltrating other systems).

It is recommended to make use of the systems and functions to thoroughly secure your network, preventing these types of problems from occurring.

Checking Network Settings

- **Windows**

Open the Windows **[Command Prompt]**, then enter `ipconfig/all` and press the **<Enter>** key. In addition to the IP address assigned to the computer, the subnet mask, gateway, and DNS server information are also displayed.

- **macOS**

In macOS, open the **[Terminal]** application, enter `ifconfig -a`, and press the **<Return>** key. The IP address assigned to the computer is indicated in the **[en0]** item next to **[inet]**, in the format `****.***.***.***`.

For information about the **[Terminal]** application, refer to the macOS help.

To avoid using the same IP address for the computer and other devices on the network when manually configuring the IP address assigned to the camera (🔗), change the rightmost number.

Example: 192.168.1.**10**

Resetting Communication Settings

All settings of network features can be cleared. This can prevent the information from being leaked if you lend the camera or transfer ownership.

1. Select []: Reset communication settings].

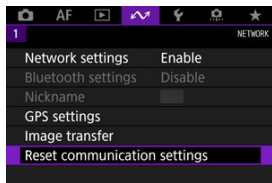

2. Select [OK].



Caution

- If you have paired the camera with a smartphone, on the smartphone's Bluetooth settings screen, delete the connection information of the camera for which you restored default wireless communication settings.

Set-up

This chapter describes menu settings on the set-up (: Set-up) tab.

- [Tab Menus: Set-up](#)
- [Selecting Cards for Recording/Playback](#)
- [Folder Settings](#)
- [File Numbering](#)
- [File Naming](#)
- [Auto Rotate](#)
- [Formatting](#)
- [Display Brightness](#)
- [Display Color Tone](#)
- [Auto Power Off](#)
- [Date/Time/Zone](#)
- [Language](#)
- [Viewfinder Information Display](#)
- [<INFO> Button Display Options](#)
- [Custom Quick Control](#)
- [Shooting Information Display](#)
- [Shutter Button Function for Movies](#)
- [UI Magnification](#)
- [Help](#)
- [Video System](#)
- [Touch Control](#)
- [Beeps](#)
- [Battery Information](#)
- [Sensor Cleaning](#)
- [HDMI Resolution](#)
- [Save/Load Settings on Card](#)
- [Custom Shooting Mode \(C1–C3\)](#)
- [Resetting Camera](#)
- [Copyright Information](#)
- [System Status Display](#)
- [Other Information](#)

Tab Menus: Set-up

● Set-up 1

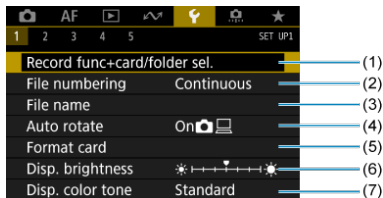

- (1) Record func+card/folder sel.
 - [Selecting Cards for Recording/Playback](#)
 - [Creating a Folder](#)
- (2) [File numbering](#)
- (3) [File name](#)
- (4) [Auto rotate](#)
- (5) [Format card](#)
- (6) [Disp. brightness](#)
- (7) [Disp. color tone](#)

● Set-up 2

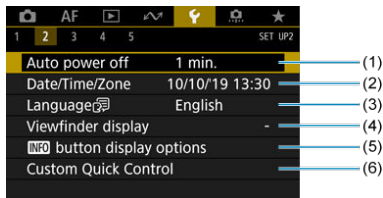

- (1) [Auto power off](#)
- (2) [Date/Time/Zone](#)
- (3) [Language](#)
- (4) [Viewfinder display](#)
- (5) [INFO button display options](#)
- (6) [Custom Quick Control](#)

● Set-up 3

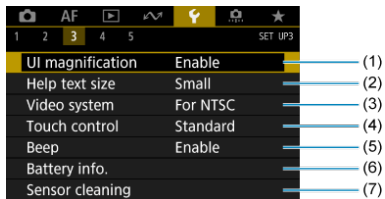

- (1) [UI magnification](#)
- (2) [Help text size](#)
- (3) [Video system](#)
- (4) [Touch control](#)
- (5) [Beep](#)
- (6) [Battery info.](#)
- (7) [Sensor cleaning](#)

● Set-up 4

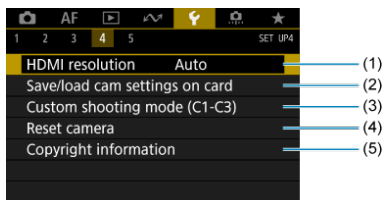

- (1) [HDMI resolution](#)
- (2) [Save/load cam settings on card](#)
- (3) [Custom shooting mode \(C1-C3\)](#)
- (4) [Reset camera](#)
- (5) [Copyright information](#)

● **Set-up 5**

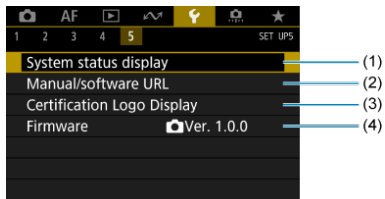

- (1) [System status display](#)
- (2) [Manual/software URL](#)
- (3) [Certification Logo Display](#)
- (4) [Firmware](#)

Caution

- **[Firmware]** is not displayed in Live View shooting or movie recording.

● **In Live View shooting, the following screen is displayed for [F2].**

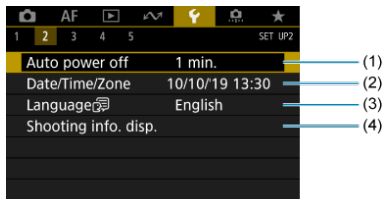

- (1) [Auto power off](#)
- (2) [Date/Time/Zone](#)
- (3) [Language](#)
- (4) [Shooting info. disp.](#)

- In movie recording, the following screen is displayed for [1/2].

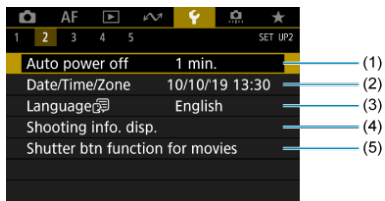

- (1) [Auto power off](#)
- (2) [Date/Time/Zone](#)
- (3) [Language](#)
- (4) [Shooting info. disp.](#)
- (5) [Shutter btn function for movies](#)

Selecting Cards for Recording/Playback

[Recording Method with Two Cards Inserted](#)

[Recording/Playback Selection with Two Cards Inserted](#)

Recording is possible when card [1] or [2] is in the camera (except under some conditions). With only one card inserted, there is no need to follow these steps.

With two cards inserted, you can select the recording method and card to use for recording and playback as follows.

Recording Method with Two Cards Inserted

1. Select [: Record func+card/folder sel.].

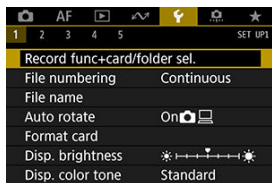

2. Set the recording method.

-   **separate**

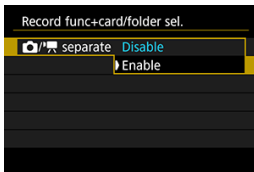

Select **[Enable]** for automatic configuration of the recording method for still photos and movies. Still photos are recorded to card **[1]** and movies to card **[2]**. Still photo shooting is not possible if card **[1]** is full or not inserted. Movie recording is not possible if card **[2]** is full or not inserted.

Caution

- Specifying **[Enable]** will make **[camera icon] Rec options**, **[video camera icon] Rec options**, **[camera icon] Record/play**, and **[video camera icon] Record/play** unavailable.

● Rec options

Set the recording method for still photos.

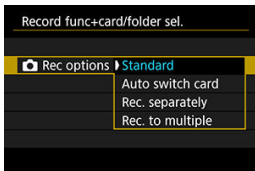



- **Standard**

Records still photos to the card selected in [ Record/play].

- **Auto switch card**



Same as [**Standard**], but additionally, the camera switches to the other card when one card becomes full. When the camera switches cards, a new folder is created.

- **Rec. separately**



Enables you to set a specific image quality for each card (). For each shot, a still photo is recorded to card  and  in your specified image quality.

Note that recording separately to **RAW** and **CRAW** is not available for RAW images.

- **Rec. to multiple**

For each shot, a still photo is recorded to card  and  in the same image quality.

Caution

- Maximum burst for [**Rec. separately**] is lower if you specify different image sizes for cards  and  ().

Note

Rec. separately/Rec. to multiple

- Images are recorded with the same file number to card [1] and [2].
- The number of shots available shown in the viewfinder and top LCD panel is the quantity on the card with less available space.
- [Card* full] is displayed when one of the cards becomes full, and shooting is no longer possible. To continue shooting, either replace the card or set [Rec options] to [Standard] and select the card with free space.
- See [Folder Settings](#) for details on [Folder] in [F: Record func +card/folder sel.].

Rec options

Standard

Records movies to the card selected in [Record/play].

Auto switch card

Same as [Standard], but shooting ends when the card becomes full. When you resume shooting, the camera switches to the other card. At this time, a new folder is created.

[1] RAW, [2] MP4

For each recording, a RAW movie is recorded to card [1] and an MP4 movie to card [2], both with the same file number. When one card becomes full, recording is no longer possible. RAW movies are recorded at [5472×2886] and MP4 at [4096×2160 IPB].

Recording/Playback Selection with Two Cards Inserted

With [📷 Rec options]/[🎥 Rec options] set to [Standard] or [Auto switch card], select the card for recording and playback.

With [📷 Rec options] set to [Rec. separately] or [Rec. to multiple], or with [🎥 Rec options] set to [1 RAW, 2 MP4], select the card for playback.

Setting size via the menu

● Standard/Auto switch card

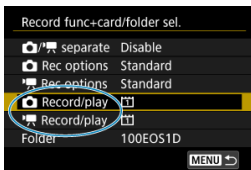

Select [Record/play].

- Select [📷 Record/play] for still photos or [🎥 Record/play] for movies.
[1]: Use card 1 for recording and playback
[2]: Use card 2 for recording and playback

● Rec. separately/Rec. to multiple/[1 RAW, 2 MP4]

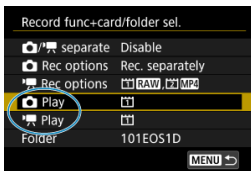

Select [Playback].





- Select [📷 Play] for still photos or [🎥 Play] for movies.
- Pressing the [▶] button in still photo shooting mode plays images from the card selected in [📷 Play].
- Pressing the [▶] button in movie recording mode plays images from the card selected in [🎥 Play].

Note

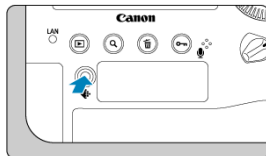
- With [Priority: ] set, the camera switches to the priority card when cards are inserted or removed.

Setting size via the rear LCD panel



1. Press the  button ().
2. Select a card.
 - Turn the  dial to select a card.
 - The card labeled with  is used for recording and playback.

Folder Settings

- [Creating a Folder](#)
- [Renaming Folders](#)
- [Selecting a Folder](#)

You can freely create and select the folder where the captured images are to be saved. You can also rename folders.

Creating a Folder

1. Select [: Record func+card/folder sel.].

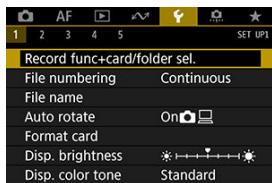

2. Select [Folder].

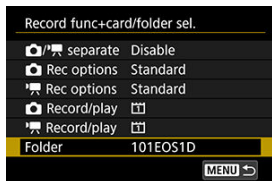

3. Select [Create folder].

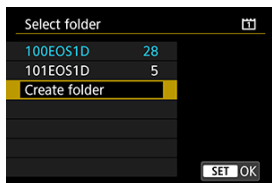

4. Select [OK].

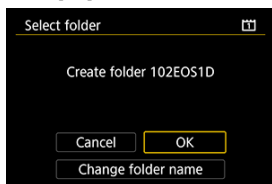

- To rename the folder, select [Change folder name].

1. Enter letters and numbers of your choice.

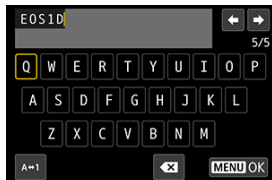

- You can enter five characters.
- By selecting [**A↔1**], you can change the input mode.
- To delete single characters, select [**x**] or press the **** button.



- Use the **<0>** or **<1>** dial to select a character, then press **<SET>** to enter it.

2. Exit the setting.

- Press the **<MENU>** button, then press [**OK**].

Selecting a Folder

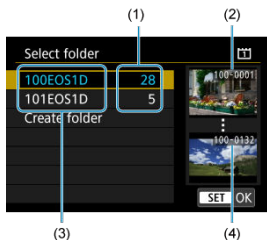

- (1) Number of images in folder
- (2) Lowest file number
- (3) Folder name
- (4) Highest file number

- Select a folder on the folder selection screen.
- Captured images are stored in your selected folder.

Note

Folders

- Folders are named as in “100EOS1D,” with a three-digit folder number followed by five letters or numbers. A folder can contain up to 9999 images (file number 0001–9999). When a folder becomes full, a new folder with the folder number increased by one is created automatically. Also, if manual reset (⏏) is executed, a new folder will be created automatically. Folders numbered from 100 to 999 can be created.

Creating folders with a computer

- With the card open on the screen, create a new folder with “DCIM” as the name. Open the DCIM folder and create as many folders as necessary to save and organize your images. “100ABC_D” is the required format for folder names, and the first three digits must be a folder number in the range 100–999. The last five characters can be any combination of upper- and lower-case letters from A to Z, numerals, and the underscore “_”. The space cannot be used. Also note that two folder names cannot share the same three-digit folder number (for example, “100ABC_D” and “100W_XYZ”) even if the remaining five characters in each name are different.

File Numbering

- [Continuous](#)
- [Auto Reset](#)
- [Manual Reset](#)

The captured images saved in a folder are assigned a file number from 0001 to 9999. You can change how the image files are numbered.

(Example)
IMG_0001.JPG
|
(1)
(1) File number

1. Select [: File numbering].

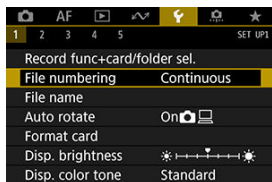

2. Set the item.

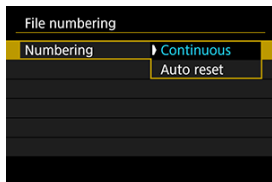

- Select [**Numbering**].
- Select [**Continuous**] or [**Auto reset**].

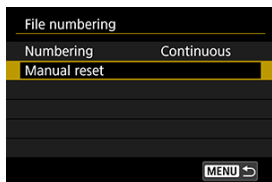

- If you want to reset the file numbering, select [**Manual reset**] (🔗).

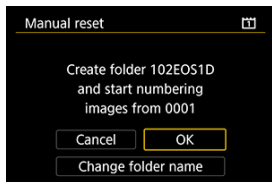

- Select [**OK**] to create a new folder, and the file number will start with 0001.

⚠ Caution

- If the file number in folder 999 reaches 9999, shooting will not be possible even if the card still has free space. After a message requesting you to replace the card is displayed, switch to a new card.

For continuous file numbering regardless of switching cards or creating folders

File numbering is continuous up to 9999, even if you replace a card, create a folder, or switch the target card (as in [1]→[2]). This is useful when you want to save images numbered anywhere between 0001 to 9999 on multiple cards or in multiple folders into one folder on a computer.

Note that file numbering may continue from any existing images in cards or folders that you switch to. If you want to use continuous file numbering, it is recommended that you use a newly formatted card each time.

File numbering after replacing cards or switching target cards

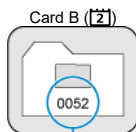
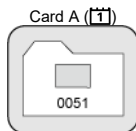

(1)

(1) Next sequential file number

File numbering after creating a folder

Card A



For restarting file numbering from 0001 after switching cards or creating folders

File numbering is reset to 0001 if you replace a card, create a folder, or switch the target card (as in **[1]**→**[2]**). This is useful if you want to organize images by cards or folders. Note that file numbering may continue from any existing images in cards or folders that you switch to. If you want to save images with the file numbering starting from 0001, use a newly formatted card each time.

File numbering after replacing cards or switching target cards

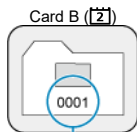
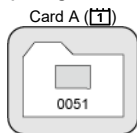

(1)

(1) File numbering is reset

File numbering after creating a folder

Card A



For resetting file numbering to 0001 or starting from 0001 in new folders

When you reset the file numbering manually, a new folder is created automatically and the file numbering of images saved to that folder starts from 0001.

This is useful, for example, if you want to use different folders for the images taken yesterday and the ones taken today.

File Naming

[Registering/Changing File Names](#)

File names consist of four alphanumeric characters followed by a four-digit file number (🔗) and file extension. You can change the first four alphanumeric characters, which by default are unique for each camera and set when the camera is shipped.

User setting 1 enables you to register four characters of your choice. User setting 2 adds three initial, registered characters of your choice to a fourth character representing the image size that is added automatically after you shoot.

(Example)
IMG_0001.JPG

Registering/Changing File Names

1. Select [: File name].

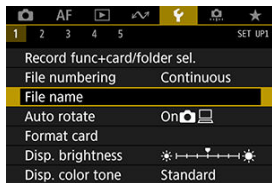

2. Select [Change User setting*].

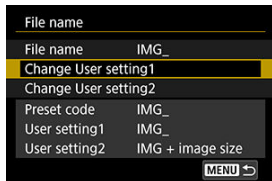

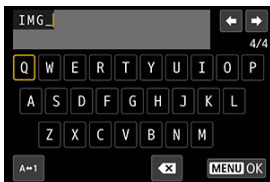

3. Enter letters and numbers of your choice.



- Enter four characters for User setting 1 or three for User setting 2.
- By selecting [**A⇌1**], you can change the input mode.
- To delete single characters, select [**x**] or press the  button.



- Use the  or  dial to select a character, then press  to enter it.

4. Exit the setting.

- Press the **<MENU>** button, then press **[OK]**.

5. Select a registered file name.

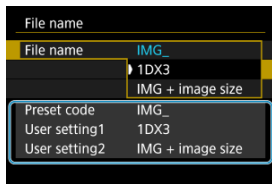

- Select [**File name**], then choose a registered file name.

⚠ Caution

- An underscore (“_”) cannot be used as the first character.

📄 Note

User setting 2

- Shooting after you have selected “**** + image size” (as registered to User setting 2) will add a character representing the current image size to your file name as the fourth character. Meanings of added characters are as follows.

“***L”: **L**, **HEIF**, or **RAW**

“***C”: **CRAW**

“***M”: **M1**

“***N”: **M2**

“***S”: **S**

The automatically added fourth character enables you to determine image sizes without opening the files after transferring them to a computer. Based on file extensions, you can also distinguish RAW, JPEG, and HEIF images.

- Movies recorded with User setting 2 are named with the fourth character as an underscore.

Auto Rotate

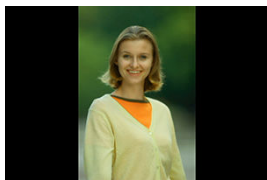

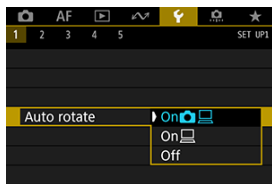

You can change the auto rotation setting that straightens images shot in vertical orientation when they are displayed.

1. Select [🔄: Auto rotate].



2. Select an item.

- **On**  
Automatically rotates images for display on both the camera and computers.
- **On** 
Automatically rotates images only for display on computers.
- **Off**
Images are not automatically rotated.

 **Caution**

- Images captured with auto rotation set to **[Off]** will not rotate during playback even if you later set auto rotation to **[On]**.

 **Note**

- If a picture is taken while the camera is aimed up or down, automatic rotation to the proper orientation for viewing may not be performed correctly.
- If images are not rotated automatically on a computer, try using EOS software.

Formatting

If the card is new or was previously formatted (initialized) by another camera or computer, format the card with this camera.

⚠ Caution

- When the card is formatted, all images and data on the card will be erased. Even protected images will be erased, so make sure there is nothing you need to keep. If necessary, transfer the images and data to a computer, etc. before formatting the card.

1. Select [: Format card].

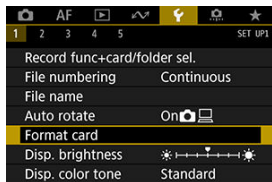

2. Select a card.



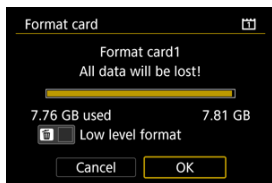

- [] represents card 1, and [], card 2.

3. Format the card.

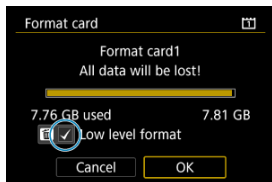

- Select [OK].



- For low-level formatting, press the  button to add a checkmark <  > to [Low level format], then select [OK].

Conditions requiring card formatting

- The card is new.
- The card was formatted by a different camera or a computer.
- The card is full of images or data.
- A card-related error is displayed ().

Low-level formatting

- Perform low-level formatting if the card's writing or reading speed seems slow or if you want to totally erase the data on the card.
- Since low-level formatting will format all recordable sectors on the card, the formatting will take longer than normal formatting.

Card file formats

CFexpress cards are exFAT formatted.

In movie recording, movies exceeding 4 GB are recorded as a single file (which results in a movie file larger than 4 GB) instead of splitting them into multiple files.

Caution

- It may not be possible to use CFexpress cards formatted with this camera in other cameras.
- Formatting or erasing data on a card does not completely erase the data. Be aware of this when selling or discarding the card. When disposing of cards, take steps to protect personal information if necessary, as by physically destroying cards.

Note

- The card capacity displayed on the card format screen may be smaller than the capacity indicated on the card.
- This device incorporates exFAT technology licensed from Microsoft.

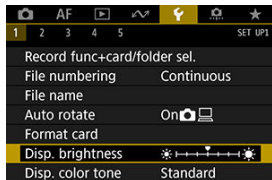

Display Brightness

1. Select [: Disp. brightness].



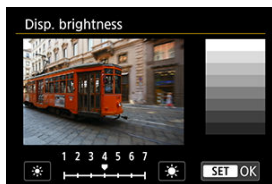

2. Make the adjustment.



- Referring to the gray image, turn the < > dial to adjust brightness, then press < >.

Note

- To check the image's exposure, referring to the histogram is recommended ().
- You can also access the screen in step 2 by pressing the < > button during playback.

Display Color Tone

1. Select [: Disp. color tone].

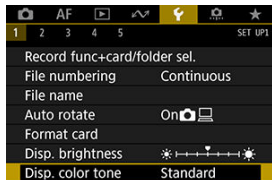

2. Make the adjustment.

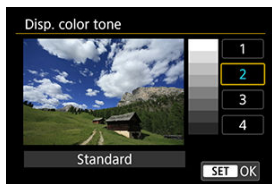

- Turn the < > dial to select an item, then press < >.

Auto Power Off

You can change the idle auto power off time.

1. Select [: Auto power off].

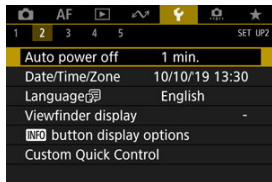

2. Select an item.

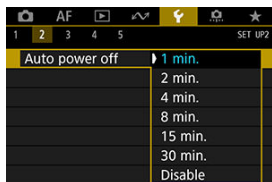

Note

- The screen turns off in approx. 30 min. even when set to **[Disable]**. Note that the camera remains on.

Date/Time/Zone

When you turn on the power for the first time or if the date/time/zone have been reset, follow these steps to set the time zone first.

By setting the time zone first, you can simply adjust this setting as needed in the future and the date/time will be updated to match it.

Since the captured images will be appended with the shooting date and time information, be sure to set your date/time.

1. Select [: Date/Time/Zone].

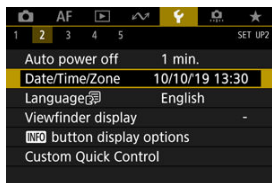

2. Set the time zone.

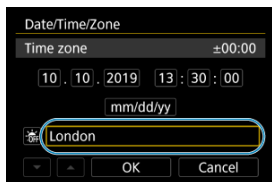

- Turn the <  > dial to select [Time zone].

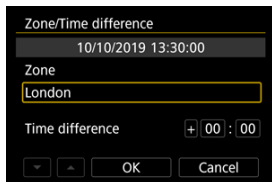

- Press <  >.



- Turn the < ⌚ > dial to select the time zone, then press < SET >.
- If your time zone is not listed, press the < MENU > button, then set the difference from UTC in [Time difference].

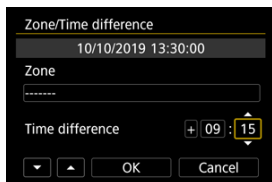

- Turn the < ⌚ > dial to select a [Time difference] item (+/-/hour/minute), then press < SET >.
- Turn the < ⌚ > dial, then press < SET >.
- After entering the time zone or time difference, turn the < ⌚ > dial to select [OK], then press < SET >.

3. Set the date and time.

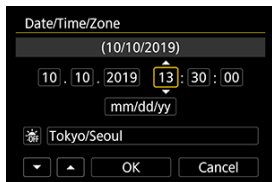

- Turn the < ⌚ > dial to select an item, then press < SET >.
- Turn the < ⌚ > dial, then press < SET >.

4. Set daylight saving time.

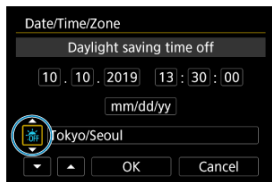

- Set it as necessary.
- Turn the < > dial to select [], then press < >.
- Turn the < > dial to select [], then press < >.
- When the daylight saving time is set to [], the time set in step 3 will advance by 1 hour. If [] is set, the daylight saving time will be canceled and the time will go back by 1 hour.

5. Exit the setting.

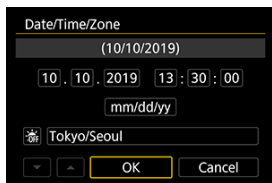

- Turn the < > dial to select [OK].

! Caution

- The date, time, and time zone settings may be reset when the camera is stored without the battery, when the battery is exhausted, or when it is exposed to freezing temperatures for an extended period. If this happens, set them once again.
- After changing [**Zone/Time difference**], check that the correct date/time are set.
- When you will use [**Sync time between cameras**] over a wired LAN or with a Wireless File Transmitter, use other EOS-1D X Mark III cameras. [**Sync time between cameras**] cannot be used with different models.



Note

- Auto power off time may be extended while the [**📍: Date/Time/Zone**] screen is displayed.
- The time can be set or updated automatically using GPS ().

Language

1. Select [: Language ].

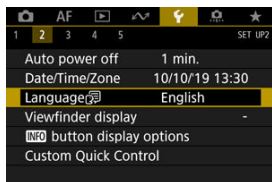

2. Set the desired language.



Viewfinder Information Display

- [Electronic Level](#)
- [Grid](#)
- [Information Display in Viewfinder](#)

Electronic Level

Displays an electronic level at the top of the viewfinder when the shutter button is pressed halfway. Also available in vertical shooting.

1. Select [**ℳ**: Viewfinder display].

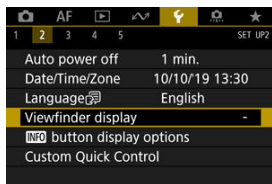

2. Select [Electronic level].

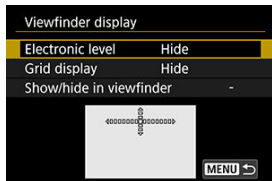

3. Select [Show].

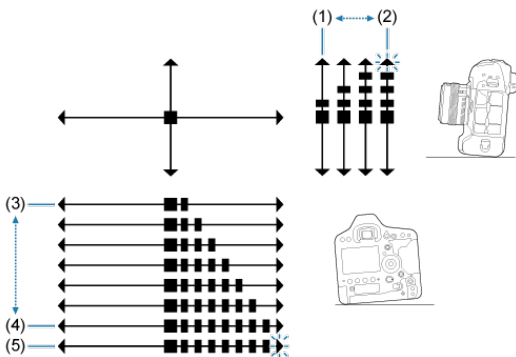

- (1) 1°
- (2) 4° or more
- (3) 1°
- (4) 7°
- (5) 7.5° or more

⚠ Caution

- There may be a margin of error of approx. $\pm 1^\circ$.

Displays a grid in the viewfinder to help you check camera tilt and shot composition.

1. Select [**F**: Viewfinder display].

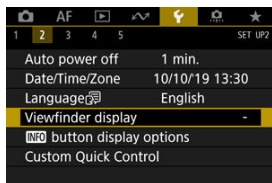

2. Select [Grid display].

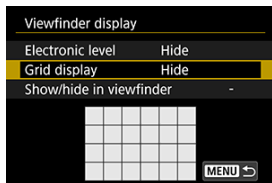

3. Select [Show].

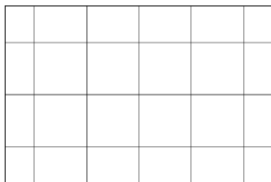

Note

- You can display a grid on the screen during Live View shooting and before you start recording a movie (📷).

Information Display in Viewfinder

Setting information can be displayed in the viewfinder for these shooting functions: shooting mode, metering mode, white balance, drive mode, image quality, AF operation, and flicker detection.

By default, only flicker detection is selected ([√]).

1. Select [: Viewfinder display].

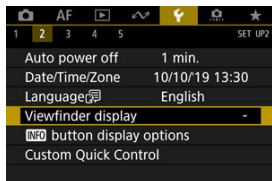

2. Select [Show/hide in viewfinder].

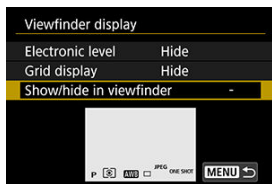

3. Add a checkmark [✓] to items to display.

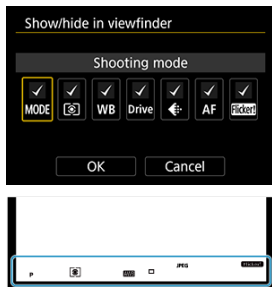

- Select information to display and press < **SET** > to add a checkmark [✓].
- Repeat this step to add a checkmark [✓] to all information to display, then select [OK].

Note

- Regardless of the [✓] setting, relevant information appears in the viewfinder when you press the < **MODE** > / < **DRIVE•AF** > / < **[S]•[WB]** > / < **WB** > buttons, move the lens focus mode switch, or turn the focusing ring of an electronic MF-equipped lens to switch between AF/MF ().

<INFO> Button Display Options

- [Electronic Level](#)
- [Quick Control Screen](#)
- [Custom Quick Control Screen](#)

You can specify the information displayed in response to pressing the <INFO> button when the camera is ready to shoot.

1. Select [: INFO button display options].

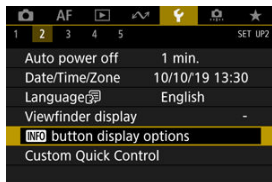

2. Select an item.

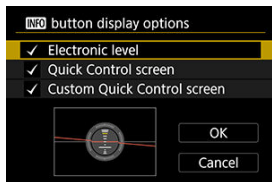

- Select the desired display option, then add a checkmark [✓].
- Select [OK].

Electronic Level

The red line turns green when the image is essentially straight.

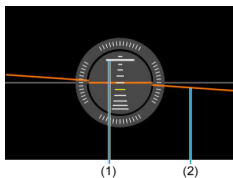

- (1) Vertical
- (2) Horizontal

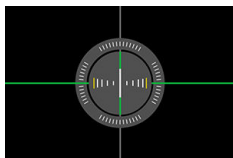

⚠ Caution

- There may be a margin of error of approx. $\pm 1^\circ$.
- If the camera is very tilted, the electronic level's margin of error will be larger.

Quick Control Screen

See [Quick Control Screen \(in Viewfinder Shooting\)](#).

Custom Quick Control Screen

See [Custom Quick Control](#).

Custom Quick Control

[Resetting the Custom Quick Control Screen or Clearing All Items](#)

Unlike the fixed layout and predetermined shooting features on the Quick Control screen () , this screen can be customized with your preferred shooting features and layout. This function is called “Custom Quick Control.”

1. Select [: Custom Quick Control].

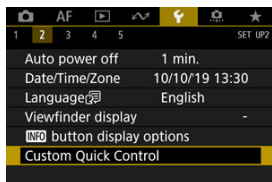

2. Select [Start editing layout].

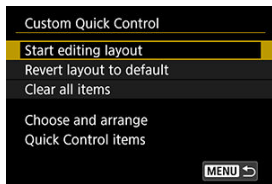



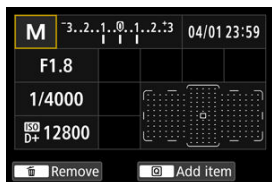
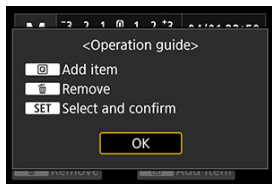

3. Review the instructions and select [OK].



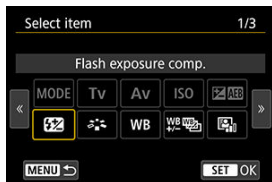



- By default, the layout includes the items shown here.

4. Add an item.

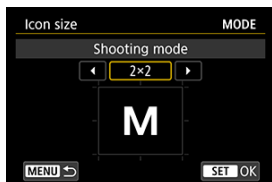





- Press the < Q > button.
- Turn the <  > dial or use <  > to select an item to add, then press <  >.
- To remove an item, either select the item and press the <  > button or select **[Clear all items]** in step 2.

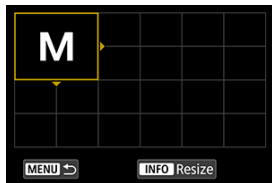

- For items with a customizable display size, once more, turn the <  > dial or use <  > to select a size, then press <  >.
- For details on the items available for the layout and their display sizes, see [Available items and display sizes for the screen layout](#).

5. Arrange the item.



- Turn the <  > or <  > dial or use <  > to move the added item (in the frame with arrows) into position.
- To change the display size, press the < INFO > button and resize the item as needed.
- Press < SET > to confirm the position. Any existing items in that position will be overwritten (deleted).
- To rearrange an item, select the item, then press < SET > and move the item as needed.



Note

- To start by removing all items from the default layout, select [Clear all items] in step 2, then go to step 4.

Sample layout

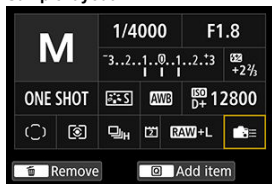

- Arrange items in your preferred layout by repeating steps 4 and 5.
- To remove an item from the layout, select it and press the <  > button.

6. Exit the setting.

- When finished, press the <MENU> button to return to the screen in step 2.

7. Review your setting screen.

Sample screen

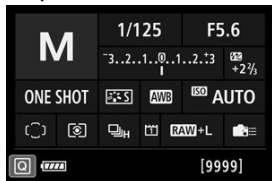

- Confirm that [Custom Quick Control screen] in [☛: INFO button display options] has a checkmark [✓] (☑).
- Press the <INFO> button to display the Custom Quick Control screen (☑), then check the layout.

Resetting the Custom Quick Control Screen or Clearing All Items

To restore the default Custom Quick Control screen layout, select **[Revert layout to default]** in step 2 (🔗).

To remove all items from the layout (so that the screen is blank except for the bottom row), select **[Clear all items]**.

Available items and display sizes for the screen layout

(Vertical × horizontal cells)

Item and Size	1×1	1×2	1×3	1×5	2×2	2×3	3×1	4×1
Shooting mode	○				○			
Shutter speed	○	○						
Aperture	○	○						
ISO speed	○	○						
Exposure comp./AEB setting	○	○	○					
Flash exposure compensation	○	○	○					
Picture Style	○		○					
White balance	○	○						
WB Shift/Bkt.	○	○						
Auto Lighting Optimizer	○							
Custom Controls	○							
AF operation	○	○						
AF point selection	○					○		
Metering mode	○							
Drive mode	○							
Rec function/card selection	○	○			○			
Date/Time/Zone	○	○		○		○		
External Speedlite control	○							
Highlight tone priority	○							
Viewfinder grid	○							
Sensor cleaning	○							
Exposure level							○	○
GPS settings	○							

 **Caution**

- The amount of information that can be shown and the features available for Quick Control vary by item, due to differences in display size.
- The same item cannot be arranged in multiple positions on the screen.

Shooting Information Display

[Customizing Information on the Screen](#)

[Grid](#)

[Histogram](#)

[Clearing Settings](#)

You can customize on-screen display in Live View shooting or movie recording.

Customizing Information on the Screen

1. Select [: Shooting info. disp.].

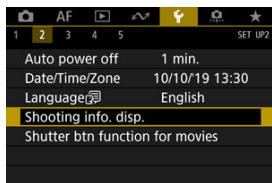

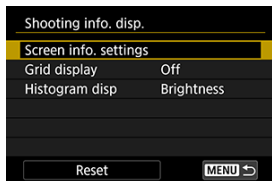

2. Select [Screen info. settings].



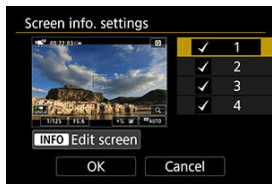

3. Select screens.

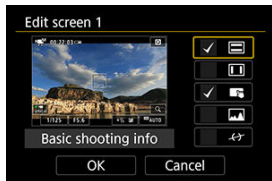

- Turn the <  > dial to select screens of information to show on the camera.
- For information you prefer not to display, press <  > to clear the checkmark [✓].
- To edit the screen, press the < **INFO** > button.

4. Edit the screen.



- Turn the <  > dial to select items to show on the screen of information.
- For items you prefer not to display, press <  > to clear the checkmark [✓].
- Select [**OK**] to register the setting.

1. Select [: Shooting info. disp.].

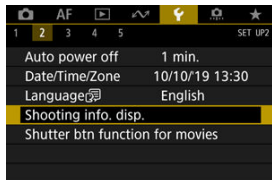

2. Select [Grid display].

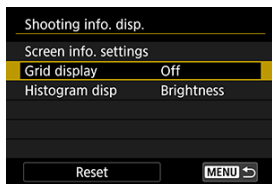

3. Select an item.

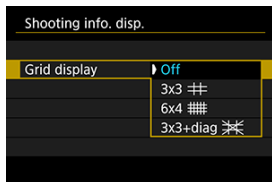

1. Select [**W**: Shooting info. disp.].

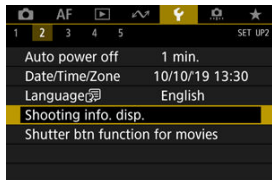

2. Select [Histogram disp.].

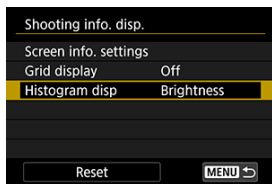

3. Select an item.

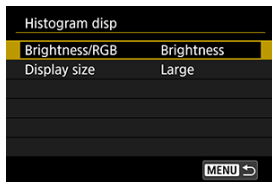

- Select the content (**[Brightness]** or **[RGB]**) and display size (**[Large]** or **[Small]**).
- Press < **MENU** > button to confirm the setting.

Clearing Settings

1. Select [**W**: Shooting info. disp.].

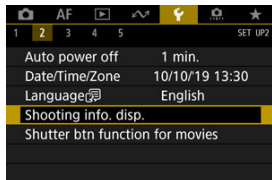

2. Select [Reset].

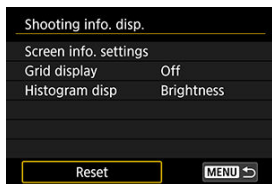

3. Select [OK].

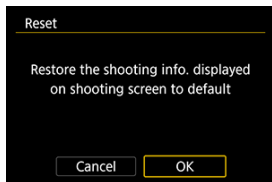

Shutter Button Function for Movies

You can set the functions performed by pressing the shutter button halfway or completely during movie recording.

Caution

- In movie recording, the **[Shutter btn function for movies]** setting overrides any function assigned to the shutter button in **[.,.,.6: Custom Controls]**.

1. Select **[📷: Shutter btn function for movies]**.

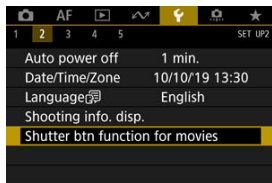

2. Select an item.

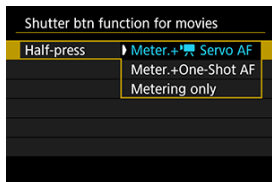

- **Half-press**

Specify the function performed by pressing the shutter button halfway.

- **Fully-press**

Specify the function performed by pressing the shutter button completely.

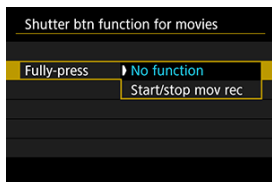

With **[Fully-press]** set to **[Start/stop mov rec]**, you can start/stop movie recording not only with the movie shooting button but also by pressing the shutter button completely, or by using Remote Switch RS-80N3 or Timer Remote Controller TC-80N3 (both sold separately).

UI Magnification

You can magnify menu screens by double-tapping with two fingers. Double-tap again to restore the original display size.

Magnification is also available on the Quick Control screen in viewfinder shooting, the Custom Quick Control screen, and the electronic level screen.

1. Select [: UI magnification].

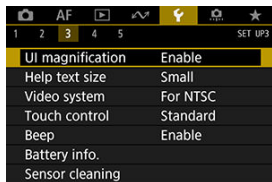

2. Select [Enable].

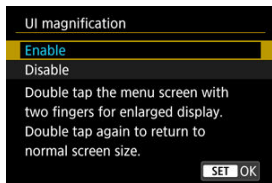

Caution

- Use camera controls when configuring menu functions with the display magnified. Touch-screen operations are not supported.

Help

[Changing the Help Text Size](#)

When **[INFO Help]** is displayed, you can display a description of the feature by pressing the **<INFO>** button. Press it again to exit Help display. To scroll the screen when a scrollbar (1) appears on the right, turn the **<O>** dial.

● Example: [AF: Case 2]

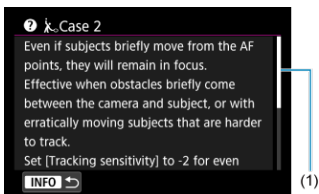
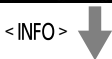
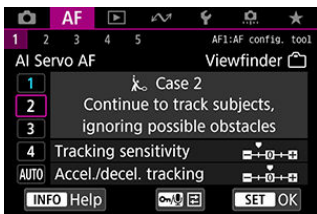

● Example: [🔒6: Multi function lock]

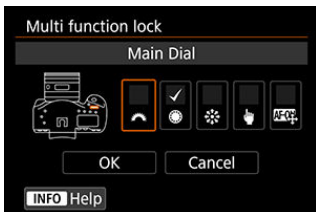

<INFO>

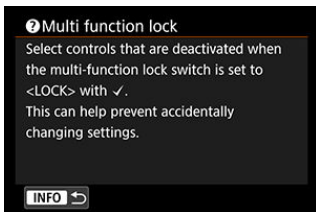

Changing the Help Text Size

1. Select [: Help text size].

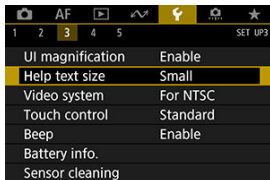

2. Select an item.

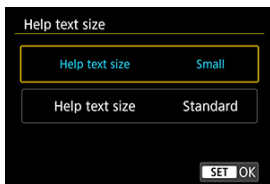

Video System

Set the video system of any television used for display. This setting determines the frame rates available when you record movies.

1. Select [🔧: Video system].

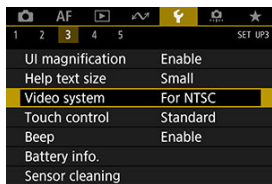

2. Select an item.

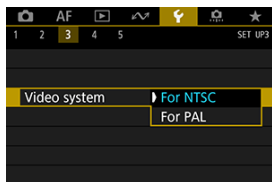

- **For NTSC**
For areas where the TV system is NTSC (North America, Japan, South Korea, Mexico, etc.).
- **For PAL**
For areas where the TV system is PAL (Europe, Russia, China, Australia, etc.).

1. Select [**T**: Touch control].

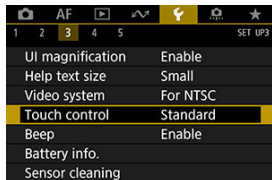

2. Select an item.

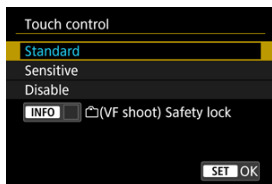

- [Sensitive] makes the touch-screen panel more responsive than [Standard].
- To disable touch operations, select [Disable].

Caution

Precautions for touch-screen operations

- Do not use sharp objects such as fingernails or ballpoint pens for touch operations.
- Do not use wet fingers for touch operations. If the screen has any moisture or if your fingers are wet, the touch-screen panel may not respond or malfunction may occur. In this case, turn off the power and wipe off the moisture with a cloth.
- Attaching any commercially available protective sheet or sticker on the screen may impair responsiveness to touch operations.
- The camera may not respond as well if you quickly perform touch operation when [Sensitive] is set.



Note

- Touch-activated shooting (touch shutter) is not supported.

1. Select [: Beep].

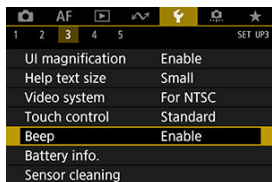

2. Select an item.

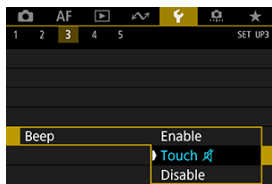

- **Enable**
The camera beeps after focusing and in response to touch operations.
- **Touch **
Disables beeping for touch operations.
- **Disable**
Disables beeping after focusing and in response to touch operations.

Battery Information

You can check the conditions of the battery you are using.

1. Select [🔋: Battery info.].

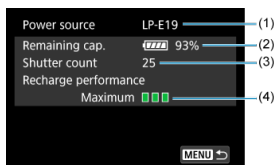
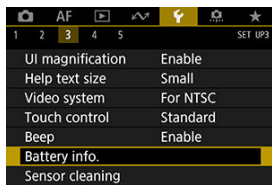

- (1) Model of battery or household power outlet accessory used.
- (2) Battery level indicator (🔋) with the remaining battery level, in 1% increments.
- (3) The number of shots taken with the current battery. The number is reset when the battery is charged (🔋).
- (4) Battery recharge performance level.
 - ■ ■ (Green): Battery's recharge performance is good.
 - ■ □ (Green): Battery's recharge performance is slightly degraded.
 - □ □ (Red): Purchasing a new battery is recommended.

⚠ Caution

- Using a genuine Canon Battery Pack LP-E19 is recommended. If you use batteries that are not genuine Canon products, the camera's full performance may not be attained or malfunction may result.



Note

- The shutter count is the number of still photos taken (not including movie recording).
- See [Charging the Battery](#) if **[Calibration is recommended when charging battery next time]** is displayed.
- If a battery communication error message is displayed, follow the instructions in the message.

Sensor Cleaning

[Cleaning Now](#)

[Cleaning Automatically](#)

[Cleaning Manually](#)

The camera's sensor cleaning feature cleans the front of the image sensor.

Note

- For best results, clean with the camera in a stable position on a desk or other flat surface.

Cleaning Now

1. Select [: Sensor cleaning].

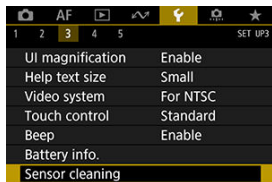

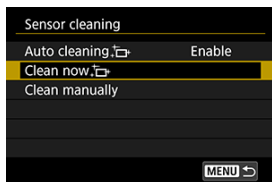

2. Select [Clean now.].



- Select [OK] on the confirmation screen.

Note

- Even if you repeat the sensor cleaning, the result will not improve much. Note that [Clean now. ] may not be available immediately after cleaning.
- Dots of light may appear in captured images or on the shooting screen if the sensor is affected by cosmic rays or similar factors. By selecting [Clean now. ], their appearance may be suppressed ().

Cleaning Automatically

1. Select [Auto cleaning, ].

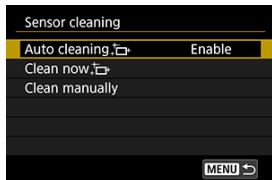

2. Select an item.

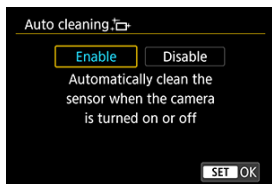

- Turn the  dial to select an item, then press .

Cleaning Manually

Dust that could not be removed by automatic cleaning can be removed manually with a commercially available blower or similar tool.

Always use a fully charged battery.

The image sensor is extremely delicate. If the sensor needs to be cleaned directly, having it done by a Canon Service Center is recommended.

1. Select [**W**: Sensor cleaning].

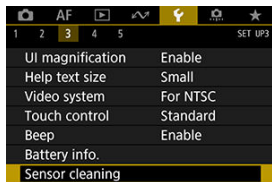

2. Select [Clean manually].

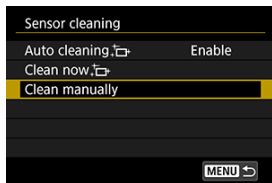

3. Select [OK].

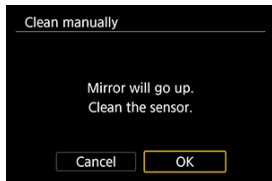

- <CLn> blinks on the top LCD panel.

4. Remove the lens and clean the sensor.

5. End the cleaning.

- Set the power switch to <OFF>.



Note

- Using the household power outlet accessories (sold separately) is recommended.



Caution

- **While cleaning the sensor, never do any of the following. If the power is cut off, the shutter will close and the reflex mirror will go back down. These may result in damaging the image sensor, shutter curtains, and reflex mirror.**
 - **Setting the power switch to <OFF>.**
 - **Removing or inserting the battery.**
- Do not move the reflex mirror with your hand. This may damage the mirror.
- The surface of the image sensor is extremely delicate. Clean the sensor with care.
- Use a plain blower without any brush attached. A brush can scratch the sensor.
- Do not insert the blower tip inside the camera beyond the lens mount. If the power is turned off, the shutter will close and the shutter curtains or reflex mirror may get damaged.
- Never use pressurized air or gas to clean the sensor. Pressurized air may damage the sensor, and sprayed gas may freeze on the sensor and scratch it.
- If the battery level becomes low while cleaning the sensor, the beeper will sound as a warning. Stop cleaning the sensor.
- If a smudge that cannot be removed with a blower remains, having the sensor cleaned by a Canon Service Center is recommended.

HDMI Resolution

Set the image output resolution used when the camera is connected to a television or external recording device with an HDMI cable.

1. Select [: HDMI resolution].

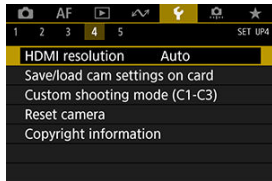

2. Select an item.

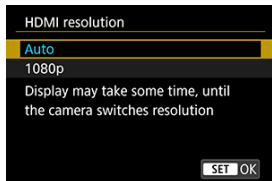

- **Auto**
The images will automatically be displayed at the optimum resolution matching the connected television.
- **1080p**
Output at 1080p resolution. Select if you prefer to avoid display or delay issues when the camera switches resolution.

Save/Load Settings on Card

 [Saving Camera Settings](#)

 [Loading Camera Settings](#)

Current camera settings such as shooting, menu, and Custom Function settings can be saved to a card as a camera settings file. By loading a camera settings file, you can apply the state of the settings as saved. This enables you to save optimal settings for particular scenes or subjects, or load settings files on other EOS-1D X Mark III cameras to use the cameras with the same settings.

Saving Camera Settings

1. Select [: Save/load cam settings on card].

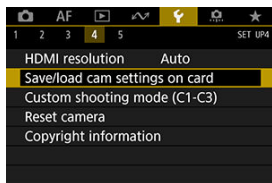

2. Select [Save to card].

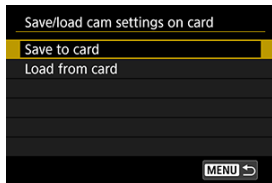

3. Select [OK].

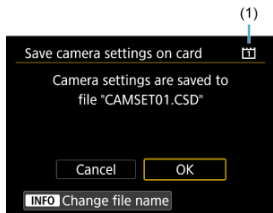

(1) Target card

- The camera settings are saved to the card.



- To rename the file to an 8-character name of your choice before saving it, press the <INFO> button on the screen in step 3.
- For instructions, see [File Naming](#). The steps are the same.

Caution

- Camera settings files saved by a camera other than an EOS-1D X Mark III cannot be loaded on this camera.
- It may not be possible to load camera settings files that were saved by a camera with a different firmware version.

Note

- Up to ten camera settings files can be saved on a card. If a card already has ten camera settings files, either overwrite existing files or use a different card.

Loading Camera Settings

In step 2, select [**Load from card**] to display up to ten camera settings files on the card. Select a file, and the camera will load it and apply the state of the settings as saved.

Custom Shooting Mode (C1–C3)

[Automatic Update of Registered Settings](#)

[Canceling Registered Custom Shooting Modes](#)

You can register current camera settings such as shooting, menu, and Custom Function settings as Custom shooting modes assigned to < C1 > to < C3 > modes. You can register different functions to use when shooting still photos or movies.

To use < C2 > or < C3 >, first enable < C2 > and < C3 > in [**3**: Restrict shooting modes] ().

1. Select [**4**: Custom shooting mode (C1-C3)].

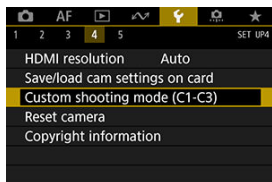

2. Select [Register settings].

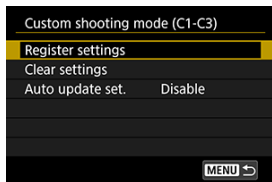

3. Register the desired items.

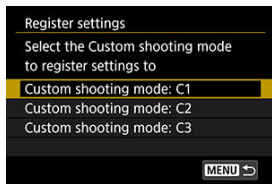

- Select the Custom shooting mode to register, then select **[OK]** on the **[Register settings]** screen.
- The current camera settings are registered to Custom shooting mode C*.

Automatic Update of Registered Settings

If you change a setting while shooting in Custom shooting mode, the mode can be automatically updated with the new setting (Auto update). To enable this automatic update, set **[Auto update set.]** to **[Enable]** in step 2.

Canceling Registered Custom Shooting Modes

If you select **[Clear settings]** in step 2, the settings of each mode can be restored to default settings, as they were before registration.



Note

- You can also change shooting and menu settings in Custom shooting modes.

Resetting Camera

The camera's settings for shooting functions and menu functions can be restored to their defaults.

1. Select [: Reset camera].

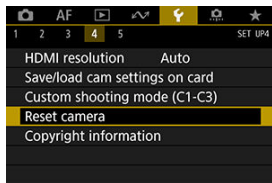

2. Select an item.

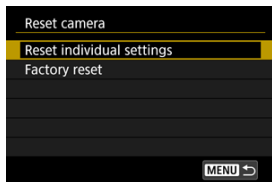

- **Reset individual settings**
Settings for individual selected items can be reset.
 - **Factory reset**
Resets all settings to defaults.
3. Clear the settings.
 - Select [**OK**] on the confirmation screen.



Note

- For details on clearing all Custom Function settings, see [Clear all Custom Func. \(C.Fn\)](#).
- For details on clearing Custom Controls settings, see [Custom Controls](#).
- Still photo Custom shooting modes are reset when [**Custom shooting mode (C1-C3)**] in [**Reset individual settings**] is selected in still photo shooting mode, and movie Custom shooting modes are reset when this option is selected in movie recording mode.

Copyright Information

[☑ Checking the Copyright Information](#)

[☑ Deleting the Copyright Information](#)

When you set the copyright information, it will be recorded to the image as Exif information.

⚠ Caution

- If the entry for "Author" or "Copyright" is long, it may not be displayed entirely when you select **[Display copyright info.]**.

📱 Note

- You can also set or check copyright information with EOS Utility (EOS software, [📄](#)).

1. Select [**📄**: Copyright information].

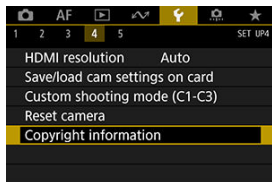





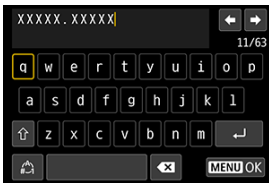

2. Select an item.



3. Enter text.



- Use the <  > or <  > dial to select a character, then press <  > to enter it.
- By selecting [], you can change the input mode.
- To delete single characters, select [] or press the <  > button.

4. Exit the setting.

- Press the < **MENU** > button, then select [**OK**].

Checking the Copyright Information

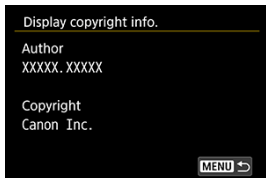

When you select [**Display copyright info.**] in step 2, you can check the [**Author**] and [**Copyright**] information that you entered.

Deleting the Copyright Information

When you select **[Delete copyright information]** in step 2, you can delete the **[Author]** and **[Copyright]** information.

System Status Display

 [Checking the Error Log](#)

 [Clearing the Camera Status Log](#)

You can check the camera's serial number, firmware version, and shutter-release cycles on this screen. You can also check the status log for past errors.

Checking camera status with this feature and requesting any required maintenance at a Canon Service Center can reduce camera problems.

Checking the Error Log

You can check a record of past errors, as well as lens, flash, and battery usage at the time of occurrence.

1. Select [: System status display].

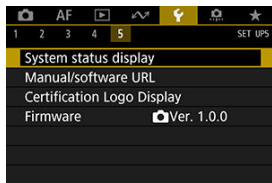

2. Check the details as needed.

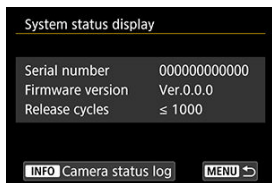

Note

- The camera status log screen lists the five most recent error records. If more than five records are logged, the oldest record is deleted automatically.
- Shutter-release cycles are indicated in units of 1,000.

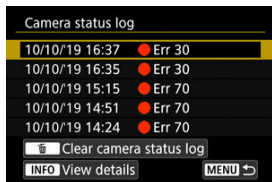

3. Check the log as needed.

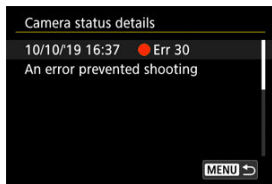

- On the screen in step 2, press the < INFO > button.
- “Err ***” indicates error information (🔗).

4. Check the details as needed.



- Turn the <  > dial to select an item, then press the < INFO > button to view error details.
- Turn the <  > dial to check details.

Clearing the Camera Status Log

To clear all log information displayed, press the <  > button in step 3.

Other Information

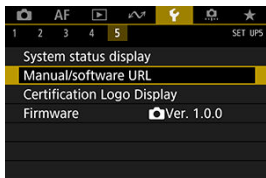

- **Manual/software URL**

To download instruction manuals, select [**⚡**: **Manual/software URL**] and scan the displayed QR code with a smartphone. You can also use a computer to access the website at the URL displayed and download software.

- **Certification Logo Display**

Select [**⚡**: **Certification Logo Display**] to display some of the logos of the camera's certifications. Other certification logos can be found on the camera body and packaging.

- **Firmware**

Select [**⚡**: **Firmware**] to update the firmware of the camera or current lens, flash, or Wireless File Transmitter.

Custom Functions/My Menu

You can fine-tune camera functions and change the functionality of buttons and dials to suit your shooting preferences. You can also add menu items and Custom Functions that you adjust frequently to My Menu tabs.



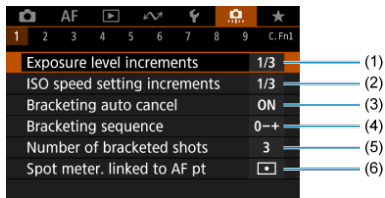

- [Tab Menus: Customization](#)
- [Custom Function Setting Items](#)
- [Custom Controls](#)
- [Tab Menus: My Menu](#)
- [Registering My Menu](#)

Tab Menus: Customization

●  1

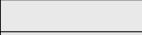
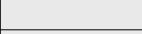

 : Setting disabled (do not work)

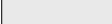
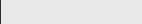
		Viewfinder Shooting	 LV Shooting	 Movie Recording
(1)	Exposure level increments	<input type="radio"/>	<input type="radio"/>	<input type="radio"/>
(2)	ISO speed setting increments	<input type="radio"/>	<input type="radio"/>	M mode
(3)	Bracketing auto cancel	<input type="radio"/>	<input type="radio"/>	
(4)	Bracketing sequence	<input type="radio"/>	<input type="radio"/>	
(5)	Number of bracketed shots	<input type="radio"/>	<input type="radio"/>	
(6)	Spot meter, linked to AF pt	<input type="radio"/>		

● 2

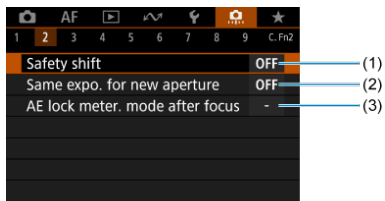

: Setting disabled (do not work)

		Viewfinder Shooting	LV Shooting	Movie Recording
(1)	Safety shift	○	○	
(2)	Same expo. for new aperture	○	○	
(3)	AE lock meter. mode after focus	○	○	

● 3

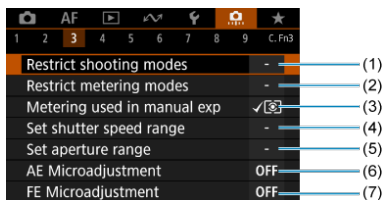

: Setting disabled (do not work)

		Viewfinder Shooting	LV Shooting	Movie Recording
(1)	Restrict shooting modes	○	○	○
(2)	Restrict metering modes	○	○	
(3)	Metering used in manual exp	○	○	
(4)	Set shutter speed range	○	○	○
(5)	Set aperture range	○	○	○
(6)	AE Microadjustment	○	○	○
(7)	FE Microadjustment	○	○	

● **4**

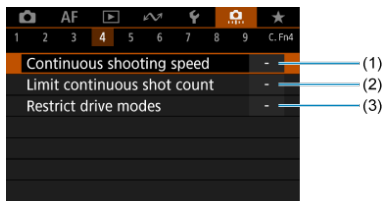

■: Setting disabled (do not work)

		Viewfinder Shooting	LV Shooting	Movie Recording
(1)	Continuous shooting speed	○	■	■
(2)	Limit continuous shot count	○	○	■
(3)	Restrict drive modes	○	○	■

● **5**

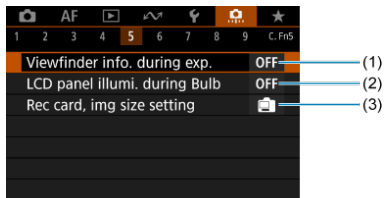



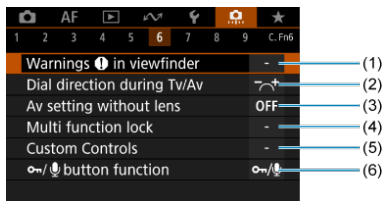

■: Setting disabled (do not work)

		Viewfinder Shooting	LV Shooting	Movie Recording
(1)	Viewfinder info. during exp.	○	■	■
(2)	LCD panel illum. during Bulb	○	○	■
(3)	Rec card, img size setting	○	○	○



 : Setting disabled (do not work)

		Viewfinder Shooting	 LV Shooting	 Movie Recording
(1)	Warnings in viewfinder	○		
(2)	Dial direction during Tv/Av	○	○	○
(3)	Av setting without lens	○	○	○
(4)	Multi function lock	○	○	○
(5)	Custom Controls	Varies by settings		
(6)	button function	 (During playback)		

● **7**

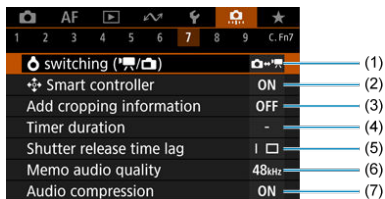

■ : Setting disabled (do not work)

		Viewfinder Shooting	LV Shooting	Movie Recording
(1)	switching (with icons)	○	○	○
(2)	Smart controller	○	○	○
(3)	Add cropping information	○	○	
(4)	Timer duration	*1		
(5)	Shutter release time lag	○		
(6)	Memo audio quality	(During playback)		
(7)	Audio compression			○

*1: [Timer after release] only

● **8**

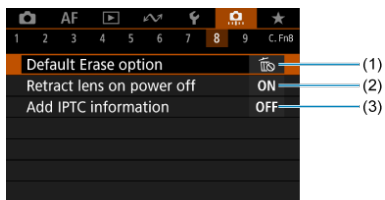

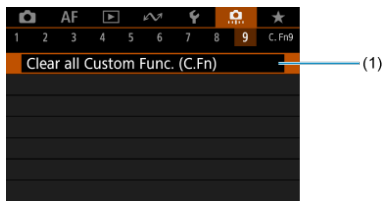

■ : Setting disabled (do not work)

		Viewfinder Shooting	LV Shooting	Movie Recording
(1)	Default Erase option	○	○	
(2)	Retract lens on power off	○	○	○
(3)	Add IPTC information	○	○	



: Setting disabled (do not work)

		Viewfinder Shooting	 LV Shooting	 Movie Recording
(1)	Clear all Custom Func. (C.Fn)	○	○	○

Custom Function Setting Items

[C.Fn1](#)

[C.Fn2](#)

[C.Fn3](#)

[C.Fn4](#)

[C.Fn5](#)

[C.Fn6](#)

[C.Fn7](#)

[C.Fn8](#)

[C.Fn9](#)

You can customize camera features on the [] tab to suit your shooting preferences. Any settings you change from default values are displayed in blue.

Exposure level increments

- **1/3: 1/3-stop, Exp comp 1/3-stop**
Sets 1/3-stop increments for the shutter speed, aperture value, exposure compensation amount, AEB range, and flash exposure compensation amount.
- **1/1: 1-stop, Exp comp 1/3-stop**
Sets whole-stop increments for the shutter speed and aperture value, and 1/3-stop increments for the exposure compensation amount, AEB range, and flash exposure compensation amount.
- **1/2: 1/2-stop, Exp comp 1/2-stop**
Sets 1/2-stop increments for the shutter speed, aperture value, exposure compensation amount, AEB range, and flash exposure compensation amount.

Note

- Display of the exposure level indicator is as follows when [**1/2-stop, Exp comp 1/2-stop**] is set.



ISO speed setting increments

You can change the manual ISO speed setting increment to a whole stop.

- **1/3: 1/3-stop**
- **1/1: 1-stop**

Note

- Even if [**1-stop**] is set, ISO speed will be automatically set in 1/3-stop increments when ISO Auto is set.

Bracketing auto cancel

You can specify to cancel AEB and white balance bracketing when the power switch is set to <OFF>.

- **ON: Enable**
- **OFF: Disable**

Bracketing sequence

The AEB shooting sequence and white balance bracketing sequence can be changed.

- **0-+: 0, -, +**
- **-0+: -, 0, +**
- **+0-: +, 0, -**

AEB	White Balance Bracketing	
	B/A Direction	M/G Direction
0: Standard exposure	0: Standard white balance	0: Standard white balance
-: Underexposure	-: Blue bias	-: Magenta bias
+: Overexposure	+: Amber bias	+: Green bias

Number of bracketed shots

The number of shots taken with AEB and white balance bracketing can be changed. When **[Bracketing sequence]** is set to **[0, -, +]**, the bracketed shots will be taken as shown in the following table.

- **3: 3 shots**
- **2: 2 shots**
- **5: 5 shots**
- **7: 7 shots**

(1-stop/step increments)

	1st Shot	2nd Shot	3rd Shot	4th Shot	5th Shot	6th Shot	7th Shot
3: 3 shots	Standard (0)	-1	+1				
2: 2 shots	Standard (0)	±1					
5: 5 shots	Standard (0)	-2	-1	+1	+2		
7: 7 shots	Standard (0)	-3	-2	-1	+1	+2	+3



Note

- If **[2 shots]** is set, you can select the + or - side when setting the AEB range. With WB bracketing, the second shot is adjusted toward the negative side for the B/A or M/G direction.

Spot meter. linked to AF pt

You can enable AF point-linked spot metering in **< [] >** metering mode.

- **[] Center AF point only**

Spot metering is always performed at the center of the viewfinder, regardless of the AF area selection mode or selected AF point.

- **[] Linked to active AF point**

Spot metering is linked to the manually selected AF point. Note that spot metering is performed at the center of the viewfinder when the AF area selection mode is Automatic selection AF, Zone AF, or Large Zone AF.

With an external flash, FE lock linked to a manually selected AF point is available, and this function can also be used with metered manual flash exposure (☑).

Safety shift

If the subject brightness changes and the standard exposure cannot be obtained within the autoexposure range, the camera will automatically change the manually selected setting to obtain the standard exposure. [Shutter speed/Aperture] applies to < **Tv** > or < **Av** > mode. [ISO speed] applies to < **P** >, < **Tv** >, or < **Av** > mode.

- **OFF: Disable**
- **Tv/Av: Shutter speed/Aperture**
- **ISO: ISO speed**



Note

- When [ISO speed] is set, safety shift also applies to AEB shooting in < **M** > mode.
- Safety shift overrides any changes to [Range for stills] or [Min. shutter spd.] from default settings in [📷: ISO speed settings] if standard exposure cannot be obtained.
- The minimum and maximum limits for the safety shift with the ISO speed are determined by [Auto range] (🔗). However, if the manually set ISO speed exceeds the [Auto range], the safety shift will take effect up or down to the manually set ISO speed.
- Safety shift will take effect as necessary even when flash is used.

Same expo. for new aperture

The maximum aperture value may decrease (the lowest f/number may increase) in **<M>** mode (manual exposure shooting) with ISO speed set manually (except when set to ISO Auto) if you (1) Change lenses, (2) Attach an extender, or (3) Use a zoom lens with a variable maximum aperture value. This function prevents the corresponding underexposure by adjusting ISO speed or shutter speed (Tv) automatically to maintain the same exposure as before (1), (2), or (3).

With **[ISO speed/Shutter speed]**, the ISO speed is automatically adjusted within the ISO speed range. If exposure cannot be maintained by adjusting ISO speed, shutter speed (Tv value) is automatically adjusted.

- **OFF: Disable**
- **ISO: ISO speed**
- **ISO/Tv: ISO speed/Shutter speed**
- **Tv: Shutter speed**

Caution

- Does not respond to changes in effective aperture value from changes in magnification when macro lenses are used.
- Cannot provide the same exposure as before (1), (2), or (3) if **[ISO speed]** is set and the exposure cannot be maintained at speeds set in **[ISO speed range]**.
- Cannot provide the same exposure as before (1), (2), or (3) if **[Shutter speed]** is set and the exposure cannot be maintained at speeds set in **[ 3: Set shutter speed range]**.

Note

- Also responds to changes in the highest f/number (minimum aperture).
- The original exposure setting is restored if you perform (1), (2), or (3) with **[ISO speed]**, **[ISO speed/Shutter speed]**, or **[Shutter speed]** set and do not adjust ISO speed, shutter speed, or aperture value before returning the camera to the original state, before (1), (2), or (3).
- Shutter speed may change to maintain exposure if the ISO speed increases to an expanded ISO speed when **[ISO speed]** is set.

AE lock meter. mode after focus

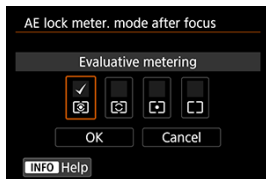

For each metering mode, you can specify whether to lock the exposure (AE lock) once subjects are in focus with One-Shot AF. The exposure will be locked while you keep pressing the shutter button halfway. Select metering modes for AE lock and add a checkmark [✓]. Select [OK] to register the setting.

C.Fn3

Restrict shooting modes

You can restrict the shooting modes available with the <MODE> button. Select shooting modes (<P / Av / M / Tv / BULB / C1 / C2 / C3>), then press <SET> to add a checkmark <✓>. Select [OK] to register the setting.

Caution

- Restricted shooting mode settings are not registered to <C1>, <C2>, or <C3>.
- The <✓> mark cannot be cleared from all eight modes at the same time.

Restrict metering modes

You can restrict the metering modes available with the <Fn2•Fn3> button. Select metering modes (<☉ / ☉ / ☉ / ☐ >), then press <SET> to add a checkmark <✓>. Select [OK] to register the setting.

Caution

- The <✓> mark cannot be cleared from all four modes at the same time.

Metering used in manual exp

You can set the metering mode used in <M> shooting mode.

- ✓☉: **Specified metering mode**
The current metering mode is used.
- ☉: **Evaluative metering**
- ☉: **Partial metering**
- ☉: **Spot metering**
- ☐: **Center-weighted average**

Caution

- Setting <☉ / ☉ / ☉ / ☐ > will prevent you from selecting the metering mode by pressing the <Fn2•Fn3> button in manual exposure shooting.

Set shutter speed range

You can set the shutter speed range. In < **Tv** > or < **M** > mode, you can set the shutter speed manually within your specified range. In < **P** > or < **Av** > mode, the shutter speed is set automatically within your specified range (except for movie recording). Select [**OK**] to register the setting.

- **Lowest speed**
Can be set in a range of 30 sec.–1/4000 sec.
- **Highest speed**
Can be set in a range of 1/8000 sec.–15 sec.

Set aperture range

You can set the aperture value range. In < **Av** >, < **M** >, or < **BULB** > mode, you can set the aperture value manually within your specified range. In < **P** > or < **Tv** > mode, the aperture value is set automatically within your specified range. Select [**OK**] to register the setting.

- **Max. aperture**
Can be set in a range of f/1.0–f/64.
- **Min. aperture**
Can be set in a range of f/91–f/1.4.



Note

- The available aperture value range varies depending on the lens's minimum and maximum aperture value.

AE Microadjustment

Caution

- **Normally, this adjustment is not required. Perform this adjustment only if necessary. Note that performing this adjustment may prevent you from obtaining suitable exposure.**

You can fine-tune the standard exposure level. Effective if images in autoexposure shooting without exposure compensation usually seem underexposed or overexposed.

- **OFF: Disable**
- **ON: Enable**

To access the adjustment screen, select **[Enable]**, then press the <  > button. Standard exposure can be adjusted in a range of ± 1 stop, in 1/8-stop increments. Set on the positive side if shots tend to be underexposed and on the negative side if they tend to be overexposed.

Caution

- The effective exposure compensation range available in movie recording remains unchanged if you adjust standard exposure with AE Microadjustment, and only the standard exposure level is changed. An exposure compensation amount equivalent to the AE Microadjustment amount is not applied to resulting images if the effective exposure compensation range in movie recording is exceeded (for example, an exposure compensation amount of +1 stop is not applied if AE Microadjustment is set to +1 stop and exposure compensation to +3 stops).

Note

- Exposure compensation can be set up to ± 5 stops from the adjusted standard exposure for viewfinder shooting and ± 3 stops for Live View shooting.

⚠ Caution





- **Normally, this adjustment is not required. Perform this adjustment only if necessary. Note that performing this adjustment may prevent you from obtaining suitable flash exposure.**

You can fine-tune the standard flash exposure level. Effective if main subjects in autoflash shooting without flash exposure compensation usually seem underexposed or overexposed.

- **OFF: Disable**
- **ON: Enable**

To access the adjustment screen, select **[Enable]**, then press the < **Q** > button. Standard flash exposure can be adjusted in a range of ± 1 stop, in 1/8-stop increments. Set on the positive side if main subjects tend to be underexposed and on the negative side if they tend to be overexposed.

Continuous shooting speed

You can set the continuous shooting speed for <  > high-speed continuous shooting, <  > medium-speed continuous shooting, <  > low-speed continuous shooting, <  > soft continuous shooting, and <  > soft low-speed continuous shooting. Select [OK] to register the setting.

- **High speed**

The default setting is 16 shots/sec. Can be set in a range of 16–3 shots/sec.

- **Continuous shooting**

The default setting is 10 shots/sec. Can be set in a range of 15–2 shots/sec.

- **Low speed**

The default setting is 3.0 shots/sec. Can be set in a range of 14–1 shots/sec.

- **Soft contin shoot**

The default setting is 8.0 shots/sec. Can be set in a range of 8–2 shots/sec.

- **Soft LS continuous**

The default setting is 3.0 shots/sec. Can be set in a range of 7–1 shots/sec.

Caution

- Even if you set a continuous shooting speed, continuous shooting at the specified speed may not be possible under some shooting conditions. For precautions on continuous shooting, see [Selecting the Drive Mode](#).

Limit continuous shot count











You can limit the maximum burst for continuous shooting, so that while you keep holding down the shutter button with continuous shooting set, the camera automatically stops shooting after the specified number of continuous shots.

You can set it from 99 to 2 exposures. Pressing the <  > button returns the setting to [Disable].

When [Disable] is set, continuous shooting can continue up to the maximum burst shown at right in the viewfinder.

Restrict drive modes

You can restrict the drive modes available with the <DRIVE•AF> button.

Select drive modes (<  / H /  / L / S / S / L / 10 /  2 >), then press <  > to add a checkmark <  >. Select [OK] to register the setting.

Caution

- The <  > mark cannot be cleared from all modes at the same time.

Viewfinder info. during exp.

For viewfinder shooting, you can set whether to display shooting information in the viewfinder during exposure.

- **OFF: Disable**

- **ON: Enable**

Shooting information remains displayed in the viewfinder during exposure. Useful when you want to check exposure, number of shots available, and other information during continuous shooting.

Caution

- Not applied (even if **[Enable]** is set) in bulb shooting mode.

LCD panel illumi. during Bulb

You can set LCD panel operation in response to bulb exposures that you shoot while it is illuminated—either to remain lit or turn off when exposure begins, or to illuminate briefly when the <  > button is pressed.

- **OFF: Off**

When bulb exposures begin, LCD panel illumination turns off. Pressing the <  > button during bulb exposures illuminates the LCD panel for approx. 6 sec.



- **ON: On during Bulb**

LCD panel illumination remains on until bulb exposures end. Useful when you shoot bulb exposures in low light and want to check the exposure time.

Rec card, img size setting

As the display used when the <  > button is pressed to select a card or set the image size, you can specify the rear LCD panel or the screen.



- : **Rear LCD panel**

After pressing the <  > button, you can watch the rear LCD panel while turning the <  > or <  > dial.





- : **Screen**

Pressing the <  > button displays the [Img type/size] or [Record func+card/folder sel.] screen (or [Movie rec quality] screen in movie recording), and then each press of the button switches between these two screens.

- **OFF: Disable  button**

Disables the <  > button for card selection or setting image size. This can prevent unintended changes to the selected card or image size if the <  > button is pressed accidentally. Use menu screens to select cards or set the image size.

Warnings  in viewfinder

The  icon can be displayed in the field of view of the viewfinder when any of the following functions are set . Select the function for which you want the warning icon to appear, then press  to add a checkmark . Select **[OK]** to register the setting.

- **When monochrome  set**

The warning icon appears when the Picture Style is set to **[Monochrome]** .

- **When WB is corrected**

The warning icon appears when white balance correction is set .

- **When one-touch img qual set**





The warning icon appears when image quality is changed with the one-touch image quality setting .

Dial direction during Tv/Av

- : **Normal**

- : **Reverse direction**

Dial turning direction when setting the shutter speed and aperture value can be reversed.

In **<M>** shooting mode, the turning direction of the  and  dial will be reversed. In other shooting modes, the turning direction of only the  dial will be reversed. The direction of the  dial in **<M>** mode matches the direction to set exposure compensation in **<P>**, **<Tv>**, and **<Av>** modes.

Av setting without lens



You can specify whether the aperture value can still be set without a lens attached.

- **OFF: Disable**





- **ON: Enable**

Aperture value can still be set without a lens attached. Convenient when you want to prepare for shooting and have already decided about the aperture value.





Multi function lock

With the power switch set to <LOCK>, this function can prevent settings from being changed by accidentally touching < >, < >, < >, < >, or the touch-screen panel.

Select the camera controls to lock by setting the switch to <LOCK>, then press < > to add a checkmark [✓]. Select [OK] to register the setting.

- : **Main Dial**
The Main dial and vertical-grip Main dial will be locked.
- : **Quick Control Dial**
The Quick control dial will be locked.
- : **Multi-controllers**
The Multi-controller and vertical-grip Multi-controller will be locked.
- : **Touch control**
Touch operations will be locked.
- : **Smart controller**
The Smart controller will be locked.

Note

- Attempting to use any locked camera controls (except [ **Touch control**]) causes <L> to appear in the viewfinder and top LCD panel and [LOCK] to appear on the Quick Control screen () and Custom Quick Control screen ().
- By default, the < > dial is locked when the power switch is set to <LOCK>.

Custom Controls

You can assign frequently used functions to camera buttons or dials according to your preferences for easy operations. For details, see [Custom Controls](#).

button function

You can change the function of the < / > button. During image playback, you can protect images, record voice memos, and rate images.

- / : **Protect(Hold:Record memo)**

To protect an image, press the < / > button. To start recording a voice memo, hold down the < / > button for approx. 2 sec., and release it to stop recording.

- : **Rec.memo(disabled)**

Pressing the < / > button starts recording a voice memo immediately, and releasing it stops recording.

- / : **Play memo(Hold:Rec. memo)**

Press the < / > button to play voice memos of images with voice memos while you are viewing these images. To start recording a voice memo, hold down the < / > button for approx. 2 sec., and release it to stop recording.







- ★: **Rating (and disabled)**



Press the < / > button to rate images. Each press of the button switches the rating as follows: OFF/[★]/[★ ★]/[★ ★ ★]/[★ ★ ★ ★].

Note

- To protect images when [Rec.memo(disabled)], [Play memo(Hold:Rec. memo)], or [Rating (and disabled)] is set, use the []: **Protect images** screen.
- With [Rating (and disabled)] selected, pressing the < > button enables you to set the ratings that are available with the < / > button.



switching (/)

-  : Enable /
- : Disable 

When set to **[Disable **], setting the Live View shooting/Movie shooting switch to **<  >** does not enable movie recording. This enables still photo shooting at all times.

Smart controller



Enables you to move AF points by dragging on the smart controller after pressing the **<  >** button.

- **ON: Enable**
Enables use of the smart controller in both vertical and horizontal shooting.
- : **Disable vertical  only**
Restricts available smart controllers to the smart controller for horizontal shooting.
- **OFF: Disable**
Disables the smart controller.

Caution

- This function is not available if you have set the **[AF-ON]** button to **[Disable]** using Custom Controls.

Note

- With **[Enable]** or **[Disable vertical  only]** selected, you can press the **<  >** button to adjust sensitivity, which changes the amount of AF point movement in response to dragging on the smart controller.

Add cropping information

Adding cropping information displays vertical lines for the aspect ratio specified in Live View shooting, so that you can compose shots as if shooting with a medium- or large-format camera (6×6 cm, 4×5 inch, and so on).

When you shoot, instead of cropping images recorded to the card, the camera adds aspect ratio information to images for cropping in the Digital Photo Professional (EOS software). You can import images to Digital Photo Professional on a computer and easily crop images to the aspect ratio set at the time of shooting.

- **OFF: Off (aspect ratio 3:2)**
- **6:6: Aspect ratio 6:6**
- **3:4: Aspect ratio 3:4**
- **4:5: Aspect ratio 4:5**
- **6:7: Aspect ratio 6:7**
- **5:6: Aspect ratio 10:12**
- **5:7: Aspect ratio 5:7**

Caution

- Cropping information is also added in viewfinder shooting, but the cropping range is not displayed.
- JPEG or HEIF images are not saved at the cropped size if you use the camera to process RAW images with cropping information (). In this case, RAW processing produces JPEG or HEIF images with cropping information.

Note

- Vertical lines are displayed in the viewfinder when set to **[Aspect ratio 6:6]**.

Timer duration

You can change how long a function setting associated with a button remains in effect after you release the button. Can be set in a range of 0–59 sec. or 1–60 min.

- **6 sec. timer**

You can set how long to continue metering and AE lock.

- **16 sec. timer**

You can set how long to continue FE lock and multi-spot metering.

- **Timer after release**

You can set how long to continue metering after shutter release. Normally, metering continues for approx. 2 sec. after you shoot. Setting a longer time makes it easier to keep shooting with AE lock at the same exposure.

Shutter release time lag

Normally, the camera controls shooting so that the shutter-release time lag is consistent, but by setting [**Shortened**], you can disable this control to shorten the shutter-release time lag.

- | : **Standard**

- | : **Shortened**

Although the shutter-release time lag is normally as short as approx. 0.055 sec., you can shorten it to as little as approx. 0.029 sec.

! Caution

- Shutter-release time lag varies by shooting conditions, type of lens, aperture value, and other factors.

Memo audio quality

You can set the audio quality for recording voice memos.

- **48 kHz: High quality (48 kHz)**

Enables voice memo recording at the same level of audio quality as movies.

- **8 kHz: Low quality (8 kHz)**

Enables smaller voice memo file sizes than with [**High quality (48 kHz)**].

! Caution

- Additional voice memo recording for images with existing voice memos is performed at the same level of audio quality as the first recording, regardless of this setting.

Audio compression

Sets audio compression for movie recording. [**Disable**] allows higher audio quality than when audio is compressed, but file sizes are larger.

- **ON: Enable**
- **OFF: Disable**

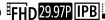
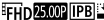

Caution

- Editing movie files recorded with [**Disable**] and then saving them with compression will also compress the audio.
- Audio is compressed even if [**Disable**] is selected when [**Movie rec quality**] is set to  (NTSC) or  (PAL).

Default Erase option

You can set which option is selected by default in the erase menu (☑), which is accessed by pressing the <  > button during image playback or during review after shooting.

By setting an option other than **[Cancel]**, you can simply press <  > to erase images quickly.

- : **[Cancel]** selected
- : **[Erase]** selected
- **RAW**: **[Erase RAW]** selected
- **J/H**: **[Erase non-RAW]** selected

Caution

- Be careful not to erase images accidentally when an option other than **[Cancel]** is set.

Retract lens on power off

You can set whether to retract gear-type STM lenses (such as EF40mm f/2.8 STM) automatically when the camera's power switch is set to < **OFF** >.

- **ON: Enable**
- **OFF: Disable**

Caution

- With auto power off, the lens will not retract regardless of the setting.
- Before detaching the lens, make sure that it is retracted.

Note

- When **[Enable]** is set, this function takes effect regardless of the lens's focus mode switch setting (AF or MF).

Add IPTC information

Registering IPTC (International Press Telecommunications Council) information to the camera from the EOS application EOS Utility enables you to record (add) this information to JPEG/HEIF/RAW still photos at the time of shooting. **This is helpful in file management and other tasks using the IPTC information.**

For instructions on registering IPTC information to the camera and details on the information you can register, refer to the EOS Utility Instruction Manual.

- OFF: Disable
- ON: Enable

Caution

- IPTC information is not added when you record movies.

Note

- During playback, you can check whether IPTC information was added.
- You can use Digital Photo Professional (EOS software) to check IPTC information in images.

Clear all Custom Func. (C.Fn)

Selecting [**C.Fn9**: **Clear all Custom Func. (C.Fn)**] clears all Custom Function settings.

Note

- Customized operations for [**C.Fn6**: **Custom Controls**], [**C.Fn7**: **Switching (P/CM/CM)**], and [**C.Fn7**: **Smart controller**] are not cleared if you perform [**C.Fn9**: **Clear all Custom Func. (C.Fn)**]. Note that although information added using [**C.Fn8**: **Add IPTC information**] is retained, the setting changes to [**Disable**].
- Settings for [**C.Fn3**: **AE Microadjustment**] and [**C.Fn3**: **FE Microadjustment**] are set to [**Disable**] but not cleared when [**C.Fn9**: **Clear all Custom Func. (C.Fn)**] is performed.

Custom Controls

-  [AF: Metering and AF Start](#)
- [AF↔: Switch to Registered AF Function](#)
-  [AF+: Switch to Registered AF Point](#)
-  [AF selection: Direct AF Point Selection](#)
-  [AF selection: Select AF Point, !\[\]\(ffa6dd4cd8800071ccc1a355540c540c_img.jpg\) !\[\]\(dfba61b58454dd961d978e324a1fb5e5_img.jpg\) \(⊙ During Met\)](#)
-  [ISO: Set ISO, !\[\]\(406c76dc95713637836155a54c3b56d5_img.jpg\) !\[\]\(b950fe96ed6737d8544db83990032195_img.jpg\) \(⊙ During Met\)](#)
-  [Image Size Selection](#)
-  [RAW/JPEG: One-Touch Image Quality Setting](#)
-  [RAW/JPEG H: One-Touch Image Quality \(Hold\)](#)
-  [Camera icon: Register/Recall Shooting Function](#)
- [UNLOCK !\[\]\(98c88aacf7bacdc4699eadf00b1c0084_img.jpg\): Unlock While Button Pressed](#)
- [C: Switch to Custom Shooting Mode](#)
-  [Cycle icon: Cycle Between the Set Functions](#)
-  [Illuminate icon: Illuminate Info in Viewfinder](#)

You can assign frequently used functions to camera buttons or dials according to your preferences for easy operations.

1. Select [6: Custom Controls].

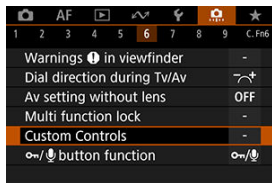

2. Select a part of the bar.

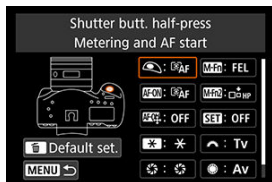

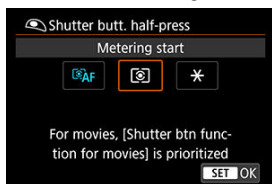

3. Select a function to assign.



- Press <  > to set it.
- You can configure advanced settings for functions labeled with **INFO** in the lower left of the screen by pressing the < **INFO** > button.

Note

- Default settings can be restored by pressing the <  > button with the screen in step 2 displayed. Note that [: **Custom Controls**] settings are not cleared even if you select [: **Clear all Custom Func. (C.Fn)**].

Functions available for camera controls

















AF







Function		AF-ON	AF-ON			LENS	M-Fn	M-Fn2	SET			
AF Metering and AF start	○	○		○		○						
AF-OFF AF stop		○		○	○	○		○				
AF-∞ Switch to registered AF function					○	○		○				
ONE SHOT AI SERVO		○		○	○	○		○				
Switch to registered AF point					○	○		○				
Direct AF point selection			○								○	○
Select AF point, during met)											○	

Exposure

Function		AF-ON	AE-L/AF-ON	*		LENS	M-Fn	M-Fn2	SET			
 Metering start	○	○		○								
* AE lock		○		○	○	○	○	○				
* AE lock (while button pressed)	○											
*H AE lock (hold)		○		○	○	○	○	○				
*AF-OFF AE lock, AF stop		○		○								
FEL FE lock		○		○	○		○	○				
ISO Set ISO speed									○			
ISO Set ISO speed (hold button, turn)									○			
ISO Set ISO speed (during meter)											○	
 Set ISO, ISO during meter)											○	
 Exposure compensation (hold button, turn)		○		○	○	○		○	○			

Operation

Function		AF-ON	AF-ON+	* 		LENS	M-Fn	M-Fn2	SET			
 Depth-of-field preview					○			○				
 IS start					○	○		○				
MENU Menu display									○			
 Register/recall shooting function		○		○								
UNLOCK  Unlock while button pressed					○			○				
C Switch to Custom shooting mode							○					
 Image replay									○			
 Magnify/Reduce (press SET , turn )									○			
 Magnify/Reduce button					○			○				
 Playback button					○			○				
INFO Info button					○			○				
 Erase button					○			○				
 Protect button					○			○				

 Cycle between the set functions							○						
 Flash function settings									○				
 Flash firing					○		○	○	○				
 Illuminate info in viewfinder					○		○	○	○				
 Network settings					○		○	○	○				
 Create folder					○		○	○	○				
OFF No function (disabled)		○	○	○	○		○	○	○	○	○	○	○

Caution

- Assigning [**Disable**] to the < **AF-ON** > button also disables the Smart controller.

Note

- < **LENS** >: "AF stop button" on super telephoto lenses equipped with Image Stabilizer.

The following section describes some examples of Custom Controls settings.

AF: Metering and AF Start

Pressing the button assigned to this function starts metering and AF.

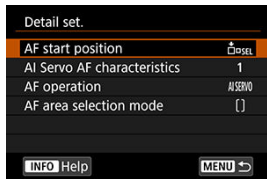



* 1: When the < AF-ON > or < * > button is assigned, pressing the < INFO > button with the setting screen displayed enables you to set detailed AF settings. Pressing the < AF-ON > or < * > button as you shoot starts AF under the configured settings.





● AF start position

When set to [Registered AF point], pressing the < AF-ON > or < * > button switches to the registered AF point.

Registering the AF point

1. Set the AF area selection mode to one of the following: Spot AF, 1-point AF, Expand AF area: , Expand AF area: Surround, or Auto selection AF. Zone AF and Large Zone AF are not available.
2. Select an AF point manually.
3. Hold down the <  > button, then press the < ISO > button, after which the camera beeps and registers the AF point. The registered AF point blinks unless you have set the AF area selection mode to an option other than Auto selection AF.

Note

- The following information is displayed when an AF point is registered.
 - Auto selection AF:  HP (HP: home position)
 - Spot AF, 1-point AF, Expand AF area: (manual selection), or Expand AF area: Surround: SEL  (center)/SEL HP (other than center)
- To clear registered AF points, hold down the <  > button and press the <  > button.

● AI Servo AF characteristics

Pressing the < AF-ON > or < * > button starts AF with characteristics of your specified case [Case *].

● AF operation

Pressing the < AF-ON > or < * > button starts AF with your specified AF operation.

- **AF area selection mode** (🔒)

Pressing the < **AF-ON** > or < ***** > button starts AF in your specified AF area selection mode.

To continue using the current AF point when you press the < **AF-ON** > or < ***** > button, set [**AF start position**] to [**Manually selected AF point**], and to continue using the current AI Servo AF characteristics, AF operation, and AF area selection mode, select [**Maintain current setting**].



Note

- You can register separate AF points for vertical (grip up or down) and horizontal shooting when [**AF: Orientation linked AF point**] is set to [**Separate AF pts: Area+pt**] or [**Separate AF pts: Pt only**].
- [**Registered AF point**] takes precedence if both [**Registered AF point**] and [**AF area selection mode**] are set in [**AF start position**].

AF--: Switch to Registered AF Function

As long as you hold down the button assigned to this function, you can switch AF operation to your registered AF function. This is useful if you want to change AF characteristics during AI Servo AF.

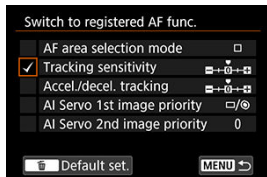

* 2: To access the detailed settings screen when the setting screen is displayed, press the <INFO> button. Turn the <INFO> or <INFO> dial to select an item, then press <SET> to add a checkmark [✓]. To configure function details, select an item, then press <SET>. Default settings can be restored by pressing the <Default set.> button.

! Caution



- Setting details for [Tracking sensitivity] and [Accel./decel. tracking] are not applied when [Case A] is selected in [AF: AI Servo AF/Servo AF].

□ HP: Switch to Registered AF Point



Pressing the button assigned to this function during metering enables you to switch to the registered AF point.

* 3: To select [**Switch only when btn is held**] or [**Switch each time btn is pressed**], press the < **INFO** > button when the setting screen is displayed. For instructions on registering AF points, see [Registering the AF Point](#).



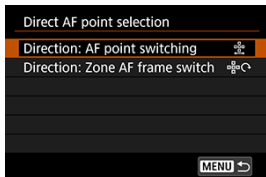

Direct AF Point Selection

During metering, you can select an AF point directly with the  or  dial without pressing the  button.



- * 4: To set the direction for switching AF points with the  dial, press the **< INFO >** button when the Quick control dial setting screen is displayed. **[Horizontal]** and **[Vertical]** settings for **[Direction: AF point switching]** apply to Spot AF, 1-point AF, Expand AF area: (manual selection), and Expand AF area: Surround, and **[Cycle through the zones]**, **[Horizontal]**, and **[Vertical]** settings for **[Direction: Zone AF frame switch]** apply to Zone AF.
- * 5: To select AF point switching (**[Switch to center AF point]** or **[Switch to registered AF point]**) when you press the center of , press the **< INFO >** button when the Multi-controller setting screen is displayed. For instructions on registering AF points, see [Registering the AF Point](#).

: Select AF Point, (☉ During Met)

During metering, you can select an AF point directly with the < ☉ > dial without pressing the <  > button. Setting this function switches the functions of the <  > and <  > buttons. You can set exposure compensation or the aperture value by holding down the <  > button and turning the <  > dial.

- * 6: To set the direction for switching AF points with the < ☉ > dial, press the < INFO > button when the setting screen is displayed. [Horizontal] and [Vertical] settings for [Direction: AF point switching] apply to Spot AF, 1-point AF, Expand AF area: (manual selection), and Expand AF area: Surround, and [Cycle through the zones], [Horizontal], and [Vertical] settings for [Direction: Zone AF frame switch] apply to Zone AF.

: Set ISO, ISO (During Met)







During metering, you can set the ISO speed by turning the <  > dial. Setting this function switches the functions of the <  > and < ISO > buttons. You can set exposure compensation or the aperture value by pressing the < ISO > button and turning the <  > dial.

Image Size Selection

You can select a card or set the image size by pressing <  > while watching the rear LCD panel. To select a card, turn the <  > dial. To set the image size, turn the <  > dial.

Pressing the button assigned to this function enables you to switch to the image size set here. While the camera switches the image size, **JPEG RAW** icons blink in the viewfinder and the image size blinks on the rear LCD panel. One-touch image quality setting is canceled after you finish shooting, and the camera reverts to the original image size.

* 7: To set the image size for this function, press the < **INFO** > button when the setting screen is displayed.

Pressing the button assigned to this function enables you to switch to the image size set here. While the camera switches the image size, **JPEG RAW** icons blink in the viewfinder and the image size blinks on the rear LCD panel. One-touch image quality setting is not canceled after you shoot. To return to the original image size, press the button assigned to this function again.

* 7: To set the image size for this function, press the < **INFO** > button when the setting screen is displayed.

Register/Recall Shooting Function

You can manually set the main shooting functions and register them to the camera. As long as you hold down the button assigned to this function, you can apply your registered shooting function settings as you shoot.



* 8: To access the detailed settings screen when the setting screen is displayed, press the <INFO> button. Turn the <DISP/AF-ON> or <INFO/AF-ON> dial to select an item, then press <SET> to add a checkmark [✓]. To configure function details, select an item, then press <SET>. Default settings can be restored by pressing the <DISP/AF-ON> button.

To register the camera's current settings, select [**Register current settings**]. For instructions on registering AF points, see [Registering the AF Point](#).

Caution

- These setting details are not applied when a Speedlite EL-100 is attached.

UNLOCK : Unlock While Button Pressed

Even with the power switch set to <LOCK >, by holding down the button assigned to this function, you can use camera controls that are locked by [, 6: **Multi function lock**].

C: Switch to Custom Shooting Mode

You can switch to registered Custom shooting modes (☑) by pressing the <M-Fn> button in shooting modes other than <C1>, <C2>, or <C3>. When you have added a [✓] to [C1], [C2], and [C3] in [4.3: Restrict shooting modes], each press of the <M-Fn> button switches from C1 to C2 to C3 to the current shooting mode.

: Cycle Between the Set Functions

Each press of the <M-Fn> button switches from one shooting function setting to the next.

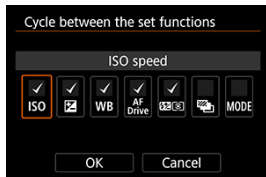

* 9: To access the detailed settings screen when the setting screen is displayed, press the <INFO> button. You can set the the functions that the camera switches among. Turn the <DISP> dial to select an item, then press <SET> to add a checkmark [✓]. Select [OK] to register the setting.

Illuminate Info in Viewfinder

By pressing the button assigned to this function, you can activate red illumination for information in the viewfinder. To deactivate the illumination, either press the button assigned to this function again or a button that starts the metering timer, such as the shutter button.

Caution

- Pressing the button assigned to this function during AE lock cancels AE lock and illuminates information in the viewfinder.

Tab Menus: My Menu

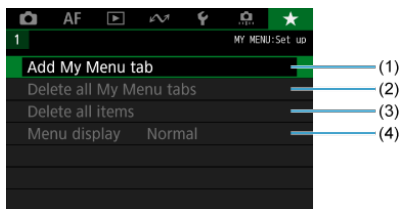

- (1) [Add My Menu tab](#)
- (2) [Delete all My Menu tabs](#)
- (3) [Delete all items](#)
- (4) [Menu display](#)

Registering My Menu

- [Creating and Adding My Menu Tabs](#)
- [Registering Menu Items under the My Menu Tab\(s\)](#)
- [My Menu Tab Settings](#)
- [Deleting All My Menu Tabs/Deleting All Items](#)
- [Menu Display Settings](#)

On the My Menu tab, you can register menu items and Custom Functions you often adjust.

Creating and Adding My Menu Tabs

1. Select [Add My Menu tab].

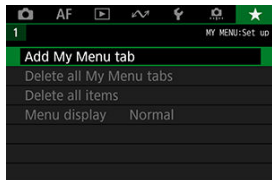

2. Select [OK].

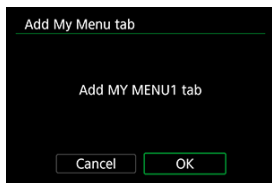

- You can create up to five My Menu tabs by repeating steps 1 and 2.

1. Select [MY MENU*: Configure].

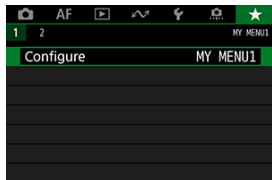

2. Select [Select items to register].

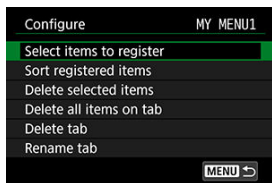

3. Register the desired items.

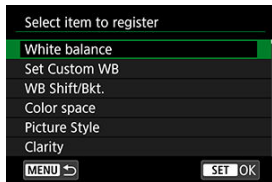

- Select an item, then press < (SET) >.
- Select [OK] on the confirmation screen.
- You can register up to six items.
- To return to the screen in step 2, press the < MENU > button.

My Menu Tab Settings

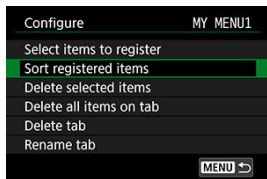

You can sort and delete items on the menu tab, and rename or delete the menu tab itself.

- **Sort registered items**

You can change the order of the registered items in My Menu. Select [**Sort registered items**], select an item to rearrange, then press < (SET) >. With [↕] displayed, turn the < (◂) > dial to rearrange the item, then press < (SET) >.

- **Delete selected items/Delete all items on tab**

You can delete any of the registered items. [**Delete selected items**] deletes one item at a time, and [**Delete all items on tab**] deletes all the registered items on the tab.

- **Delete tab**

You can delete the current My Menu tab. Select [**Delete tab**] to delete the [**MY MENU***] tab.

- **Rename tab**

You can rename the My Menu tab from [MY MENU*].

1. **Select [Rename tab].**

2. **Enter text.**

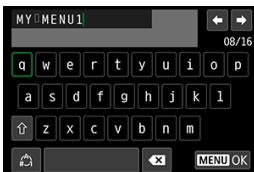

- To delete single characters, select [X] or press the < [trash] > button.
- Use the < [dial] > or < [directional pad] > to select a character, then press < [SET] > to enter it.
- By selecting [input mode], you can change the input mode.

3. **Confirm input.**

- Press the < MENU > button, then select [OK].

Deleting All My Menu Tabs/Deleting All Items

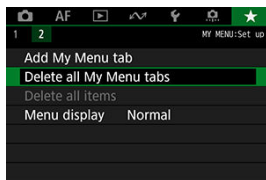

You can delete all the created My Menu tabs or My Menu items registered on them.

- **Delete all My Menu tabs**

You can delete all My Menu tabs you created. When you select [**Delete all My Menu tabs**], all the tabs from [**MY MENU1**] to [**MY MENU5**] will be deleted and the [**★**] tab will revert to its default.

- **Delete all items**

You can delete all the items registered under the [**MY MENU1**] to [**MY MENU5**] tabs. The tabs themselves will remain. When [**Delete all items**] is selected, all the items registered on all the created tabs will be deleted.

! **Caution**

- Performing [**Delete tab**] or [**Delete all My Menu tabs**] will also delete tab names renamed with [**Rename tab**].

Menu Display Settings

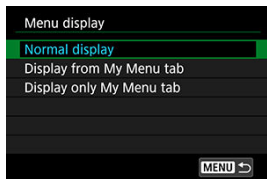

You can select [**Menu display**] to set the menu screen that is to appear first when you press the <MENU> button.

- **Normal display**
Displays the last displayed menu screen.
- **Display from My Menu tab**
Displays with the [★] tab selected.
- **Display only My Menu tab**
Restricts display to the [★] tab ([📷]/[AF]/[▶]/[📶]/[🔊]/[🔍] tabs are not displayed).

Reference

This chapter provides reference information on camera features.

- [Importing Images to a Computer](#)
- [Troubleshooting Guide](#)
- [Error Codes](#)
- [Compatible Lenses and Autofocusing \(Viewfinder Shooting\)](#)
- [System Map](#)
- [Performance Data](#)
- [Information Display](#)
- [Specifications](#)

Importing Images to a Computer

[Connecting to a Computer with an Interface Cable](#)

[Using a Card Reader](#)

[Connecting to a Computer via Wi-Fi](#)

You can use EOS software to import images from the camera to a computer. There are three ways to do this.

Connecting to a Computer with an Interface Cable

1. Install EOS Utility () .

2. Connect the camera to the computer.

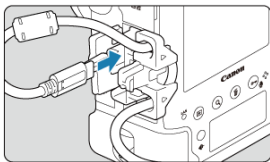

- Use the interface cable included with the camera.
- When connecting the cable to the camera, use the cable protector () and insert the plug in the digital terminal.
- Insert the other end of the cable into the computer's USB terminal (Type-C).

3. Use EOS Utility to import the images.

- Refer to the EOS Utility Instruction Manual.

 **Caution**

- With a Wi-Fi connection established, the camera cannot communicate with the computer even if they are connected with an interface cable.

 **Note**

- By connecting to an FTP server, you can send images on the camera to a computer ()

Using a Card Reader

You can use a card reader to import images to a computer.

1. **Install Digital Photo Professional** .
2. **Insert the card into the card reader.**
3. **Use Digital Photo Professional to import the images.**

- Refer to the Digital Photo Professional Instruction Manual.









Note

- When downloading images from the camera to a computer with a card reader without using EOS software, copy the DCIM folder on the card to the computer.

Connecting to a Computer via Wi-Fi

You can connect the camera to the computer via Wi-Fi and import images to the computer (☑).

Troubleshooting Guide

-  [Power-related problems](#)
-  [Shooting-related problems](#)
-  [Problems with wireless features](#)
-  [Operation problems](#)
-  [Display problems](#)
-  [Playback problems](#)
-  [Sensor cleaning problems](#)
-  [Computer connection problems](#)



If a problem occurs with the camera, first refer to this Troubleshooting Guide. If this Troubleshooting Guide does not resolve the problem, contact your dealer or nearest Canon Service Center.

Power-related problems

The battery does not charge.

- The included Battery Charger LC-E19 is designed exclusively for Battery Pack LP-E19.
- In case of charging or charger issues, see [Charging the Battery](#).

The camera is not activated even when the power switch is set to <ON>.

- Make sure the battery is inserted properly in the camera ()
- Make sure the card slot cover is closed ()
- Charge the battery ()

The access lamp still lights or blinks even when the power switch is set to <OFF>.

- If the power is turned off while an image is being recorded to the card, the access lamp will remain on or continue to blink for a few seconds. When the image recording is complete, the power will turn off automatically.

[Battery communication error. Does this battery/do these batteries display the Canon logo?] is displayed.

- Do not use any battery packs other than a genuine Canon Battery Pack LP-E19.
- Remove and install the battery again (🔧).
- If the electrical contacts are dirty, use a soft cloth to clean them.

The battery becomes exhausted quickly.

- Use a fully charged battery (🔋).
- The battery performance may have degraded. See [🔋: Battery info.] to check the battery's recharge performance level (🔋). If the battery performance is poor, replace the battery with a new one.
- The number of available shots will decrease with any of the following operations:
 - Pressing the shutter button halfway for a prolonged period.
 - Activating the AF frequently without taking a picture.
 - Using the lens's Image Stabilizer.
 - Using GPS.
 - Using the screen frequently.
 - Continuing Live View shooting or movie recording for a prolonged period.
 - Using the wireless communication functions.

The camera turns off by itself.

- Auto power off is in effect. To deactivate auto power off, set [🔋: Auto power off] to [Disable] (🔧).
- Even if [🔋: Auto power off] is set to [Disable], the screen still turns off after the camera is left idle for approx. 30 min. (although the camera itself remains on).

Shooting-related problems

The lens cannot be attached.

- The camera cannot be used with RF, EF-S, or EF-M lenses (🔗).

The viewfinder is dark.

- Install a charged battery in the camera (🔗).

No images can be shot or recorded.

- Make sure the card is properly inserted (🔗).
- If the card is full, replace the card or delete unnecessary images to make space (🔗, 🔗).
- Shooting is not possible during One-Shot AF when the focus indicator < ● > in the viewfinder is blinking, or when the AF point is orange during Live View shooting or movie recording. Press the shutter button halfway again to refocus automatically, or focus manually (🔗).

The card cannot be used.

- If a card error message is displayed, see [Inserting/Removing Cards](#) and [Error Codes](#).

I have to press the shutter button twice to take a picture.

- Set [: Mirror lockup] to [Disable].





The image is out of focus or blurred.

- Set the lens's focus mode switch to < AF > (🔗).
- Press the shutter button gently to prevent camera shake (🔗, 🔗).
- With a lens equipped with an Image Stabilizer, set the Image Stabilizer switch to < ON >.
- In low light, the shutter speed may become slow. Use a faster shutter speed (🔗), set a higher ISO speed (🔗), use flash (🔗), or use a tripod.
- See [Minimizing blurred photos](#).



There are fewer AF points or the Area AF frame shape is different.

- Depending on the lens used, the number of usable AF points, AF point patterns, Area AF frame shape, etc. vary (🔗).

The AF point is blinking or two AF points are displayed.

- See [Selecting the AF Area and AF Point \(Viewfinder Shooting\)](#) for details on AF point blinking or illumination when the <  > button is pressed.
- AF points in registered positions are blinking (, )
- Manually selected AF points (or zones) and registered AF points are displayed (, )

I cannot lock the focus and recompose the shot.

- Set the AF operation to One-Shot AF () . Shooting with the focus locked is not possible with AI Servo AF/Servo AF () .

The continuous shooting speed is slow.

- High-speed continuous shooting may be slower depending on the type of power used, the battery level, ambient temperature, ISO speed, flicker reduction, shutter speed, aperture value, state of the aperture during continuous shooting, subject conditions, brightness, type of lens, use of flash, shooting function settings, and other conditions. For details, see [Selecting the Drive Mode](#).

The maximum burst during continuous shooting is lower.

- If you shoot a subject that has fine detail such as a field of grass, the file size will be larger, and the actual maximum burst may be lower than the number listed in [Performance Data](#).

Even after I change the card, the maximum burst displayed for continuous shooting does not change.

- Estimated maximum burst indicated in the viewfinder does not change when you switch cards, even if you switch to a high-speed card. The maximum burst shown in the table in [Performance Data](#) is based on the standard Canon test card, so the faster the card's writing speed, the higher the actual maximum burst will be. For this reason, estimated maximum burst as indicated in the viewfinder may differ from actual maximum burst.

ISO speeds cannot be selected for still photo shooting.

- The minimum speed in the ISO speed range is ISO 200 when [: **Highlight tone priority**] is set to [Enable] or [Enhanced].

Expanded ISO speeds cannot be selected for still photo shooting.

- Check the **[ISO speed range]** setting under **[Camera Icon]: ISO speed settings**.
- Expanded ISO speeds are not available when **[Camera Icon]: Highlight tone priority** is set to **[Enable]** or **[Enhanced]**.
- Expanded ISO speeds are not available when **[Camera Icon]: HDR shooting [HDR PQ]** is set to **[Enable]**.

Even if I set a decreased exposure compensation, the image comes out bright.

- Set **[Camera Icon]: Auto Lighting Optimizer** to **[Disable]** (🔒). When **[Low]**, **[Standard]**, or **[High]** is set, even if you set a decreased exposure compensation or flash exposure compensation, the image may come out bright.

I cannot set the exposure compensation when both manual exposure and ISO Auto are set.

- See [M: Manual Exposure](#) to set the exposure compensation.
- Exposure compensation is not performed in flash photography.

Not all the lens aberration correction options are displayed.

- Although **[Chromatic aberr corr]** and **[Diffraction correction]** are not displayed when **[Digital Lens Optimizer]** is set to **[Enable]**, both functions are applied in shooting, as when set to **[Enable]**.
- During movie recording, **[Digital Lens Optimizer]** or **[Distortion correction]** will not be displayed.



Images are not displayed after shooting in multiple-exposure shooting.

- When **[On:ContShntng]** is set, images are not displayed for review after capture, and image playback is not available (🔒).



Using flash in < Av > mode lowers the shutter speed.

- To provide suitable exposure for subjects and backgrounds, the shutter speed is automatically reduced (slow-sync shooting) for shots under low light in night scenes or with similar backgrounds. To prevent a slow shutter speed, set **[Flash sync. speed in Av mode]** in **[Camera Icon]: External Speedlite control** to **[1/250-1/60sec. auto]** or **[1/250 sec. (fixed)]** (🔒).

The flash does not fire.

- Make sure the flash unit (or sync cord) is securely attached to the camera.
- When using flash in Live View shooting, set [: **Shutter mode**] to an option other than [**Electronic**] ().

The flash always fires at full output.

- Flash units other than EL/EX series Speedlites used in autoflash mode always fire at full output ().
- When the flash Custom Function setting for [**Flash metering mode**] is set to [**TTL flash metering**] (autoflash), the flash will always fire at full output ().

Flash exposure compensation cannot be set.

- If flash exposure compensation is already set with the Speedlite, flash exposure compensation cannot be set with the camera. When the external Speedlite's flash exposure compensation is canceled (set to 0), flash exposure compensation can be set with the camera.



High-speed sync is not available in < Av > mode.

- Set [**Flash sync. speed in Av mode**] in [: **External Speedlite control**] to [**Auto**] ().



I cannot shoot with Live View.

- Set [: **Live View shoot.**] to [**Enable**].

During Live View shooting, a white or red icon is displayed.

- It indicates that the camera's internal temperature is high. Image quality of still photos may be worse when a white  icon is displayed. If the red  icon is displayed, it indicates that the Live View shooting will soon stop automatically ().

During movie recording, the red icon is displayed.

- It indicates that the camera's internal temperature is high. If the red  icon is displayed, it indicates that the movie recording will soon stop automatically ().

Movie recording stops by itself.

- If the card's writing speed is slow, movie recording may stop automatically. For cards that can record movies, see [Performance Data](#). To find out the card's writing speed, refer to the card manufacturer's website, etc.
- Perform low-level formatting to initialize the card if the card's writing or reading speed seems slow (🔗).
- Recording stops automatically once your movie reaches 29 min. 59 sec. (or 7 min. 29 sec. for a High Frame Rate movie).

The ISO speed cannot be set for movie recording.

- ISO speed is set automatically in < 📷 > / < 📷TV > / < 📷Av > recording mode. In < 📷M > mode, you can manually set the ISO speed (🔗).
- The minimum speed in the ISO speed range is ISO 200 when [📷: Highlight tone priority] is set to [Enable] or [Enhanced].

Expanded ISO speeds cannot be selected for movie recording.

- Check the [ISO speed range] setting under [📷: 📷ISO speed settings].
- Expanded ISO speeds are not available when [📷: Highlight tone priority] is set to [Enable] or [Enhanced].
- Expanded ISO speeds are not available when the camera is set for RAW movies.

The exposure changes during movie recording.

- If you change the shutter speed or aperture value during movie recording, the changes in the exposure may be recorded.
- Recording a few test movies is recommended if you intend to perform zooming during movie recording. Zooming as you record movies may cause exposure changes or lens sounds to be recorded, an uneven audio level, inaccurate lens aberration correction, or loss of focus.

The image flickers or horizontal stripes appear during movie recording.

- Flickering, horizontal stripes (noise), or irregular exposures can be caused by fluorescent lighting, LED lighting, or other light sources during movie recording. Also, changes in the exposure (brightness) or color tone may be recorded. In < TV > or < M > mode, using a slower shutter speed may reduce the problem.

The subject looks distorted during movie recording.

- If you move the camera to the left or right (panning) or shoot a moving subject, the image may look distorted.

Sound is not recorded in movies.

- Sound is not recorded in High Frame Rate movies.

A time code is not added.

- Time codes are not added when you record High Frame Rate movies with **[Count up]** in **[📷: Time code]** set to **[Free run]** (🔗). Additionally, no time code is added to HDMI video output (🔗).

Time codes advance faster than the actual time.

- Time codes in High Frame Rate recording advance 4 sec. per second (🔗).

I cannot take still photos during movie recording.

- Still photos cannot be taken during movie recording. To take still photos, stop the movie recording and perform viewfinder shooting or Live View shooting.

Cannot pair with a smartphone.

- Use a smartphone compliant with Bluetooth Specification Version 4.1 or later.
- Turn on Bluetooth from the smartphone settings screen.
- Pairing with the camera is not possible from the smartphone's Bluetooth settings screen. Install the dedicated app Camera Connect (free of charge) on the smartphone (📲).
- Pairing with a previously paired smartphone is not possible if pairing information registered for another camera remains on the smartphone. In this case, remove the camera's registration retained in the Bluetooth settings on the smartphone and try pairing again (📲).

Wi-Fi functions cannot be set.

- If the camera is connected to a computer or another device with an interface cable, Wi-Fi functions cannot be set. Disconnect the interface cable before setting any functions.

A device connected with an interface cable cannot be used.

- Other devices, such as computers, cannot be used with the camera by connecting them with an interface cable while the camera is connected to devices via Wi-Fi. Terminate the Wi-Fi connection before connecting the interface cable.

Operations such as shooting and playback are not possible.

- With a Wi-Fi connection established, operations such as shooting and playback may not be possible. Terminate the Wi-Fi connection, then perform the operation.

Cannot reconnect to a smartphone.



- Even with a combination of the same camera and smartphone, if you have changed the settings or selected a different setting, reconnection may not be established even after selecting the same SSID. In this case, delete the camera connection settings from the Wi-Fi settings on the smartphone and set up a connection again.
- A connection may not be established if Camera Connect is running when you reconfigure connection settings. In this case, quit Camera Connect for a moment and then restart it.

Operation problems





Settings change when I switch from still photo shooting to movie recording or vice versa.

- Separate settings are retained for use when shooting still photos and recording movies.



I cannot change the setting with < ---

- Set the power switch to < ON > .
- Check the [, 6: Multi function lock] setting .

Settings cannot be changed with < ---

- Set the vertical-grip On/Off switch to < ON > .
- Set [, 7:  Smart controller] to [Enable] .

Touch operation is not possible.

- Make sure [, Touch control] is set to [Standard] or [Sensitive] .

A camera button or dial does not work as expected.

- Check the [, 6: Custom Controls] setting .

Display problems

The display starts with [★] My Menu, or the [★] tab alone is displayed.

- [Menu display] on the [★] tab is set to [Display from My Menu tab] or [Display only My Menu tab]. Set [Normal display] (🔗).

The file name's first character is an underscore (“_”).

- Set [📷: Color space] to [sRGB]. If [Adobe RGB] is set, the first character will be an underscore (🔗).

The fourth character in the file name changes.

- [📷: File name] is set to [*** + image size]. Select either the camera's unique file name or the file name registered in User setting 1 (🔗).

The file numbering does not start from 0001.

- If the card already contains recorded images, the image number may not start from 0001 (🔗).

The shooting date and time displayed are incorrect.

- Make sure the correct date and time are set (🔗).
- Check the time zone and daylight saving time (🔗).

The date and time are not in the image.

- The shooting date and time do not appear in the image. The date and time are recorded in the image data as shooting information. When printing, you can imprint the date and time in the picture, using the date and time recorded in the shooting information (🔗).

[###] is displayed.

- If the number of images recorded on the card exceeds the number the camera can display, [###] will be displayed.

The screen does not display a clear image.

- If the screen is dirty, use a soft cloth to clean it.
- The screen display may seem slightly slow in low temperatures or may look black in high temperatures, but it will return to normal at room temperature.

Part of the image blinks in black.

- [▶]: **Highlight alert** is set to [Enable] (🔗).

A red box is displayed on the image.

- [▶]: **AF point disp.** is set to [Enable] (🔗).

During image playback, the AF points are not displayed.

- AF points are not displayed in playback of cropped images.

The image cannot be erased.

- If the image is protected, it cannot be erased (🔗).

Still photos and movies cannot be played back.

- The camera may not be able to play back images taken with another camera.
- Movies edited with a computer cannot be played back with the camera.

Only few images can be played back.

- The images have been filtered for playback with [▶]: **Set image search conditions** (🔗). Clear the image search conditions.

Mechanical sounds or sounds of camera operations can be heard during movie playback.

- If AF operations are performed or you control the camera or lens during movie recording, the camera's built-in microphone may also record mechanical sounds of the lens or sounds of camera/lens operations. In this case, using an external microphone may reduce these sounds. If the sounds are still distracting with an external microphone, it may be more effective to remove the external microphone from the camera and position it away from the camera and lens.

Movie playback stops by itself.

- Extended movie playback or movie playback under high ambient temperature may cause the camera's internal temperature to rise, and movie playback may stop automatically.
If this happens, playback is disabled until the camera's internal temperature decreases, so turn off the power and let the camera cool down a while.

The movie appears to freeze momentarily.

- Significant change in the exposure level during Program AE recording may cause recording to stop momentarily until the brightness stabilizes. In such a case, shoot in the < **M** > mode (🔗).

The movie is played in slow motion.

- High Frame Rate movies are recorded at 29.97 fps or 25.00 fps, so they are played in slow motion at 1/4 speed.

No picture appears on the television.

- Make sure [🔧: **Video system**] is set to [For NTSC] or [For PAL] correctly for the video system of your television.
- Make sure the HDMI cable's plug is inserted all the way in (🔗).

My card reader does not recognize the card.

- CFexpress cards may not be correctly recognized by some card readers or in some operating systems. In this case, connect the camera to the computer with the interface cable, then import the images to the computer using EOS Utility (EOS software, 🔗).



Images cannot be resized or cropped.

- JPEG **S** images, RAW images, images captured with [📷: **HDR shooting [HDR PQ]**] in [📷: **HDR PQ settings**] set to [Enable], and frame-grab images from 4K movies saved as still photos cannot be resized with the camera (🔗).
- RAW images, images captured with [📷: **HDR shooting [HDR PQ]**] in [📷: **HDR PQ settings**] set to [Enable], and frame-grab images from 4K movies saved as still photos cannot be cropped with the camera (🔗).



Dots of light appear on the image.

- White, red, or blue dots of light may appear in captured images if the sensor is affected by cosmic rays or similar factors. Their appearance may be reduced by performing [Clean now. 🧹] under [🔧: **Sensor cleaning**] (🔗).

The shutter makes a sound during sensor cleaning.

- Although there is a mechanical sound from the shutter during cleaning after [**Clean now** ] is selected, no image is recorded to the card ().

Automatic sensor cleaning does not work.

- If you repeatedly turn the power switch < **ON** > and < **OFF** > within a short time period, the <  > icon may not be displayed ().

I cannot import images to a computer.

- Install EOS Utility (EOS software) on the computer ([🔗](#)).
- Make sure the main EOS Utility window is displayed.
- If the camera is already connected via Wi-Fi, it cannot communicate with any computer connected with an interface cable.
- Check the version of the application.

Error Codes

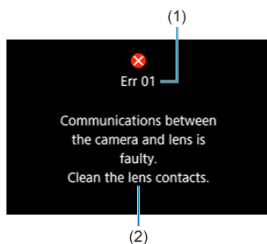

(1) Error number

(2) Cause and countermeasures

If there is a problem with the camera, an error message will appear. Follow the on-screen instructions.

If the problem persists, write down the error code (Errxx) and request service.

Compatible Lenses and Autofocusing (Viewfinder Shooting)

 [Group A](#)

 [Group B](#)

 [Group C](#)

 [Group D](#)

 [Group E](#)

 [Group F](#)

 [Group G](#)

 [Group H](#)

 [Group I](#)





 [Group J](#)

 [Group Classification of Lenses](#)

Caution

- Although the camera has 191 AF points, **lenses are classified into 10 groups (A–J) which vary in the number of AF points available, AF point patterns, Area AF frame shapes, and other details.**
- **When lenses in groups F–J are used, fewer AF points are available.**
- See [Group Classification of Lenses](#) for lenses you will use.

Note

- AF points in positions indicated by  blink when the  button is pressed (while / /  points remain lit). For details on AF point blinking/illumination, see [Meaning of Lit or Blinking AF Points](#).
- For updates on "Group Classification of Lenses," visit the Canon website or others.
- Some lenses may not be available in certain countries or regions.

Group A

Autofocusing with 191 points is possible. All the AF area selection modes are available.

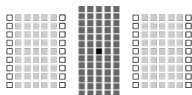

■: Dual cross-type AF point. Offers superior subject tracking and higher focusing precision than other AF points.

■ **■**: Cross-type AF point. Offers excellent subject tracking and high-precision focusing.

□: AF points sensitive to horizontal lines.

Group B

Autofocusing with 191 points is possible. All the AF area selection modes are selectable.

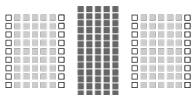

■ ■: Cross-type AF point. Offers excellent subject tracking and high-precision focusing.

□: AF points sensitive to horizontal lines.

Group C

Autofocusing with 191 points is possible. All the AF area selection modes are selectable.

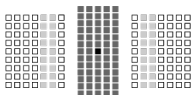

■: Dual cross-type AF point. Offers superior subject tracking and higher focusing precision than other AF points.



■ **■**: Cross-type AF point. Offers excellent subject tracking and high-precision focusing.

□: AF points sensitive to horizontal lines.

Group D

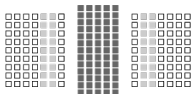
Autofocusing with 191 points is possible. All the AF area selection modes are selectable.



 : Cross-type AF point. Offers excellent subject tracking and high-precision focusing.

: AF points sensitive to horizontal lines.

Group E

Autofocusing with 191 points is possible. All the AF area selection modes are selectable. With an extender attached to extendable lenses, AF is available when maximum aperture is $f/8$ (in a range of $f/5.6$ – $f/8$).



: Cross-type AF point. Offers excellent subject tracking and high-precision focusing.

: AF points sensitive to horizontal lines.

Caution

- If the maximum aperture value is slower than $f/5.6$ (greater than $f/5.6$ but not exceeding $f/8$), focus may not be achieved with AF when shooting low-contrast or low-light subjects.
- If the maximum aperture value is slower than $f/8$ (greater than $f/8$), AF is not possible during viewfinder shooting.

Group F

Not all 191 AF points can be used for autofocus, but the 139 points shown here are available. All the AF area selection modes are selectable. During automatic AF point selection, the outer frame marking the AF area (Area AF frame) will be different from 191-point Automatic selection AF.

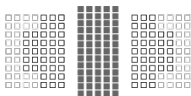

- : Cross-type AF point. Offers excellent subject tracking and high-precision focusing.
- : AF points sensitive to horizontal lines.
- : Disabled AF points (not displayed).

Group G

Not all 191 AF points can be used for autofocus, but the 87 points shown here are available. All the AF area selection modes are selectable. During automatic AF point selection, the outer frame marking the AF area (Area AF frame) will be different from 191-point Automatic selection AF.





- : Cross-type AF point. Offers excellent subject tracking and high-precision focusing.
- : AF points sensitive to horizontal lines.
- : Disabled AF points (not displayed).

Group H

The 23 AF points shown here are available for autofocus. As the AF area selection mode, choose from Spot AF, 1-point AF, Expand AF area: , Zone AF (manual selection), or 23-point Automatic selection AF.

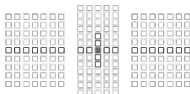
With an extender attached to extendable lenses, AF is available when maximum aperture is $f/8$ (in a range of $f/5.6$ – $f/8$).



: Cross-type AF point. Offers excellent subject tracking and high-precision focusing.

: AF points sensitive to horizontal lines (AF points left and right of the center) or vertical lines (AF points above and below the center).

: Disabled AF points (not displayed).

Caution

- Expand AF area:  applies to the 23 available AF points. Expansion for manually selected AF points that are not surrounded by active AF points is limited to any available adjacent points.
- If the maximum aperture value is slower than $f/5.6$ (greater than $f/5.6$ but not exceeding $f/8$), focus may not be achieved with AF when shooting low-contrast or low-light subjects.
- If the maximum aperture value is slower than $f/8$ (greater than $f/8$), AF is not possible during viewfinder shooting.

Group I

The 15 AF points shown here are available for autofocusing. As the AF area selection mode, choose from Spot AF, 1-point AF, Expand AF area: \square , or 15-point Automatic selection AF. With an extender attached to extendable lenses, AF is available when maximum aperture is $f/8$ (in a range of $f/5.6$ – $f/8$).

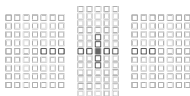

: Cross-type AF point. Offers excellent subject tracking and high-precision focusing.

: AF points sensitive to horizontal lines (AF points left and right of the center) or vertical lines (AF points above and below the center).

: Disabled AF points (not displayed).

Caution

- AF point expansion (manual selection \square) applies to the 15 available AF points. Expansion for manually selected AF points that are not surrounded by active AF points is limited to any available adjacent points.
- If the maximum aperture value is slower than $f/5.6$ (greater than $f/5.6$ but not exceeding $f/8$), focus may not be achieved with AF when shooting low-contrast or low-light subjects.
- If the maximum aperture value is slower than $f/8$ (greater than $f/8$), AF is not possible during viewfinder shooting.

Group J

The 9 AF points shown here are available for autofocusing. As the AF area selection mode, choose from Spot AF, 1-point AF, or Expand AF area: .

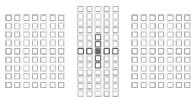

: Cross-type AF point. Offers excellent subject tracking and high-precision focusing.

: AF points sensitive to horizontal lines (AF points to the left and right of the center) or vertical lines (AF points above and below the center). **Manual selection is not available. Enabled only when Expand AF area: manual selection is selected.**

: Disabled AF points (not displayed).

Group Classification of Lenses

EF 14mm f/2.8 L USM	A
EF 14mm f/2.8 L II USM	A
EF 15mm f/2.8 Fisheye	A
EF 20mm f/2.8 USM	A
EF 24mm f/1.4 L USM	A
EF 24mm f/1.4 L II USM	A
EF 24mm f/2.8	A
EF 24mm f/2.8 IS USM	A
EF 28mm f/1.8 USM	A
EF 28mm f/2.8	C
EF 28mm f/2.8 IS USM	A
EF 35mm f/1.4 L USM	A
EF 35mm f/1.4 L II USM	A
EF 35mm f/2	A
EF 35mm f/2 IS USM	A
EF 40mm f/2.8 STM	C
EF 50mm f/1.0 L USM	A
EF 50mm f/1.2 L USM	A
EF 50mm f/1.4 USM	A
EF 50mm f/1.8	A
EF 50mm f/1.8 II	A
EF 50mm f/1.8 STM	A
EF 50mm f/2.5 Compact Macro	B
EF 50mm f/2.5 Compact Macro + LIFE SIZE Converter EF	E
EF 85mm f/1.2 L USM	A
EF 85mm f/1.2 L II USM	A
EF 85mm f/1.4 L IS USM	A
EF 85mm f/1.8 USM	A
EF 100mm f/2 USM	A
EF 100mm f/2.8 Macro	B
EF 100mm f/2.8 Macro USM	E
EF 100mm f/2.8 L Macro IS USM	B

EF 135mm f/2 L USM	A
EF 135mm f/2 L USM + Extender EF 1.4x I/II/III	A
EF 135mm f/2 L USM + Extender EF 2x I/II/III	B
EF 135mm f/2.8 (Softfocus)	A
EF 180mm f/3.5 L Macro USM	G
EF 180mm f/3.5 L Macro USM + Extender EF 1.4x I/II/III	G
EF 200mm f/1.8 L USM	A
EF 200mm f/1.8 L USM + Extender EF 1.4x I/II/III	A*
EF 200mm f/1.8 L USM + Extender EF 2x I/II/III	B*
EF 200mm f/2 L IS USM	A
EF 200mm f/2 L IS USM + Extender EF 1.4x I/II/III	A
EF 200mm f/2 L IS USM + Extender EF 2x I/II/III	B
EF 200mm f/2.8 L USM	A
EF 200mm f/2.8 L USM + Extender EF 1.4x I/II/III	B
EF 200mm f/2.8 L USM + Extender EF 2x I/II/III	E
EF 200mm f/2.8 L II USM	A
EF 200mm f/2.8 L II USM + Extender EF 1.4x I/II/III	B
EF 200mm f/2.8 L II USM + Extender EF 2x I/II/III	E
EF 300mm f/2.8 L USM	A
EF 300mm f/2.8 L USM + Extender EF 1.4x I/II/III	B*
EF 300mm f/2.8 L USM + Extender EF 2x I/II/III	E*
EF 300mm f/2.8 L IS USM	A
EF 300mm f/2.8 L IS USM + Extender EF 1.4x I/II/III	B
EF 300mm f/2.8 L IS USM + Extender EF 2x I/II/III	E
EF 300mm f/2.8 L IS II USM	A
EF 300mm f/2.8 L IS II USM + Extender EF 1.4x I/II/III	B
EF 300mm f/2.8 L IS II USM + Extender EF 2x I/II/III	E
EF 300mm f/4 L USM	B
EF 300mm f/4 L USM + Extender EF 1.4x I/II/III	E
EF 300mm f/4 L USM + Extender EF 2x I/II	I (f/8)
EF 300mm f/4 L USM + Extender EF 2x III	H (f/8)
EF 300mm f/4 L IS USM	B
EF 300mm f/4 L IS USM + Extender EF 1.4x I/II/III	E
EF 300mm f/4 L IS USM + Extender EF 2x I/II	I (f/8)
EF 300mm f/4 L IS USM + Extender EF 2x III	H (f/8)

EF 400mm f/2.8 L USM	A
EF 400mm f/2.8 L USM + Extender EF 1.4x I/II/III	B*
EF 400mm f/2.8 L USM + Extender EF 2x I/II/III	E*
EF 400mm f/2.8 L II USM	A
EF 400mm f/2.8 L II USM + Extender EF 1.4x I/II/III	B*
EF 400mm f/2.8 L II USM + Extender EF 2x I/II/III	E*
EF 400mm f/2.8 L IS USM	A
EF 400mm f/2.8 L IS USM + Extender EF 1.4x I/II/III	B
EF 400mm f/2.8 L IS USM + Extender EF 2x I/II/III	E
EF 400mm f/2.8 L IS II USM	A
EF 400mm f/2.8 L IS II USM + Extender EF 1.4x I/II/III	B
EF 400mm f/2.8 L IS II USM + Extender EF 2x I/II/III	E
EF 400mm f/2.8 L IS III USM	A
EF 400mm f/2.8 L IS III USM + Extender EF 1.4x I/II/III	B
EF 400mm f/2.8 L IS III USM + Extender EF 2x I/II/III	E
EF 400mm f/4 DO IS USM	B
EF 400mm f/4 DO IS USM + Extender EF 1.4x I/II/III	E
EF 400mm f/4 DO IS USM + Extender EF 2x I/II	I (f/8)
EF 400mm f/4 DO IS USM + Extender EF 2x III	E (f/8)
EF 400mm f/4 DO IS II USM	B
EF 400mm f/4 DO IS II USM + Extender EF 1.4x I/II/III	E
EF 400mm f/4 DO IS II USM + Extender EF 2x I/II	I (f/8)
EF 400mm f/4 DO IS II USM + Extender EF 2x III	E (f/8)
EF 400mm f/5.6 L USM	E
EF 400mm f/5.6 L USM + Extender EF 1.4x I/II	I (f/8)
EF 400mm f/5.6 L USM + Extender EF 1.4x III	E (f/8)
EF 500mm f/4 L IS USM	B
EF 500mm f/4 L IS USM + Extender EF 1.4x I/II/III	E
EF 500mm f/4 L IS USM + Extender EF 2x I/II	I (f/8)
EF 500mm f/4 L IS USM + Extender EF 2x III	E (f/8)
EF 500mm f/4 L IS II USM	B
EF 500mm f/4 L IS II USM + Extender EF 1.4x I/II/III	E
EF 500mm f/4 L IS II USM + Extender EF 2x I/II	I (f/8)
EF 500mm f/4 L IS II USM + Extender EF 2x III	E (f/8)
EF 500mm f/4.5 L USM	E
EF 500mm f/4.5 L USM + Extender EF 1.4x I/II	I (f/8)*
EF 500mm f/4.5 L USM + Extender EF 1.4x III	E (f/8)*

EF 600mm f/4 L USM	B
EF 600mm f/4 L USM + Extender EF 1.4x I/II/III	E*
EF 600mm f/4 L USM + Extender EF 2x I/II	I (f/8)*
EF 600mm f/4 L USM + Extender EF 2x III	E (f/8)*
EF 600mm f/4 L IS USM	B
EF 600mm f/4 L IS USM + Extender EF 1.4x I/II/III	E
EF 600mm f/4 L IS USM + Extender EF 2x I/II	I (f/8)
EF 600mm f/4 L IS USM + Extender EF 2x III	E (f/8)
EF 600mm f/4 L IS II USM	B
EF 600mm f/4 L IS II USM + Extender EF 1.4x I/II/III	E
EF 600mm f/4 L IS II USM + Extender EF 2x I/II	I (f/8)
EF 600mm f/4 L IS II USM + Extender EF 2x III	E (f/8)
EF 600mm f/4 L IS III USM	B
EF 600mm f/4 L IS III USM + Extender EF 1.4x I/II/III	E
EF 600mm f/4 L IS III USM + Extender EF 2x I/II	I (f/8)
EF 600mm f/4 L IS III USM + Extender EF 2x III	E (f/8)
EF 800mm f/5.6 L IS USM	F
EF 800mm f/5.6 L IS USM + Extender EF 1.4x I/II/III	I (f/8)
EF 1200mm f/5.6 L USM	G
EF 1200mm f/5.6 L USM + Extender EF 1.4x I/II/III	I (f/8)*
EF 8-15mm f/4 L Fisheye USM	B
EF 11-24mm f/4 L USM	D
EF 16-35mm f/2.8 L USM	A
EF 16-35mm f/2.8 L II USM	A
EF 16-35mm f/2.8 L III USM	A
EF 16-35mm f/4 L IS USM	B
EF 17-35mm f/2.8 L USM	A
EF 17-40mm f/4 L USM	B
EF 20-35mm f/2.8 L	A
EF 20-35mm f/3.5-4.5 USM	E
EF 22-55mm f/4-5.6 USM	F
EF 24-70mm f/2.8 L USM	A
EF 24-70mm f/2.8 L II USM	A
EF 24-70mm f/4 L IS USM	B
EF 24-85mm f/3.5-4.5 USM	E
EF 24-105mm f/3.5-5.6 IS STM	E
EF 24-105mm f/4 L IS USM	B
EF 24-105mm f/4 L IS II USM	B

EF 28-70mm f/2.8 L USM	A
EF 28-70mm f/3.5-4.5	F
EF 28-70mm f/3.5-4.5 II	F
EF 28-80mm f/2.8-4 L USM	B
EF 28-80mm f/3.5-5.6	F
EF 28-80mm f/3.5-5.6 USM	F
EF 28-80mm f/3.5-5.6 II	F
EF 28-80mm f/3.5-5.6 II USM	F
EF 28-80mm f/3.5-5.6 III USM	F
EF 28-80mm f/3.5-5.6 IV USM	F
EF 28-80mm f/3.5-5.6 V USM	F
EF 28-90mm f/4-5.6	E
EF 28-90mm f/4-5.6 USM	E
EF 28-90mm f/4-5.6 II	E
EF 28-90mm f/4-5.6 II USM	E
EF 28-90mm f/4-5.6 III	E
EF 28-105mm f/3.5-4.5 USM	E
EF 28-105mm f/3.5-4.5 II USM	E
EF 28-105mm f/4-5.6	F
EF 28-105mm f/4-5.6 USM	F
EF 28-135mm f/3.5-5.6 IS USM	E
EF 28-200mm f/3.5-5.6	E
EF 28-200mm f/3.5-5.6 USM	E
EF 28-300mm f/3.5-5.6 L IS USM	E
EF 35-70mm f/3.5-4.5	F
EF 35-70mm f/3.5-4.5 A	F
EF 35-80mm f/4-5.6	F
EF 35-80mm f/4-5.6 PZ	F
EF 35-80mm f/4-5.6 USM	F
EF 35-80mm f/4-5.6 II	F
EF 35-80mm f/4-5.6 III	F
EF 35-105mm f/3.5-4.5	E
EF 35-105mm f/4-5-5.6	J
EF 35-105mm f/4-5-5.6 USM	J
EF 35-135mm f/3.5-4.5	E
EF 35-135mm f/4-5.6 USM	E
EF 35-350mm f/3.5-5.6 L USM	F
EF 38-76mm f/4.5-5.6	E

EF 50-200mm f/3.5-4.5	E
EF 50-200mm f/3.5-4.5 L	E
EF 55-200mm f/4.5-5.6 USM	E
EF 55-200mm f/4.5-5.6 II USM	E
EF 70-200mm f/2.8 L USM	A
EF 70-200mm f/2.8 L USM + Extender EF 1.4x I/II/III	B**
EF 70-200mm f/2.8 L USM + Extender EF 2x I/II/III	E**
EF 70-200mm f/2.8 L IS USM	A
EF 70-200mm f/2.8 L IS USM + Extender EF 1.4x I/II/III	B
EF 70-200mm f/2.8 L IS USM + Extender EF 2x I/II/III	E
EF 70-200mm f/2.8 L IS II USM	A
EF 70-200mm f/2.8 L IS II USM + Extender EF 1.4x I/II/III	B
EF 70-200mm f/2.8 L IS II USM + Extender EF 2x I/II/III	E
EF 70-200mm f/2.8 L IS III USM	A
EF 70-200mm f/2.8 L IS III USM + Extender EF 1.4x I/II/III	B
EF 70-200mm f/2.8 L IS III USM + Extender EF 2x I/II/III	E
EF 70-200mm f/4 L USM	B
EF 70-200mm f/4 L USM + Extender EF 1.4x I/II/III	E
EF 70-200mm f/4 L USM + Extender EF 2x I/II	I (f/8)
EF 70-200mm f/4 L USM + Extender EF 2x III	H (f/8)
EF 70-200mm f/4 L IS USM	B
EF 70-200mm f/4 L IS USM + Extender EF 1.4x I/II/III	E
EF 70-200mm f/4 L IS USM + Extender EF 2x I/II	I (f/8)
EF 70-200mm f/4 L IS USM + Extender EF 2x III	H (f/8)
EF 70-200mm f/4 L IS II USM	B
EF 70-200mm f/4 L IS II USM + Extender EF 1.4x I/II/III	E
EF 70-200mm f/4 L IS II USM + Extender EF 2x I/II	I (f/8)
EF 70-200mm f/4 L IS II USM + Extender EF 2x III	H (f/8)
EF 70-210mm f/3.5-4.5 USM	E
EF 70-210mm f/4	B
EF 70-300mm f/4-5.6 IS USM	E
EF 70-300mm f/4-5.6 IS II USM	E
EF 70-300mm f/4-5.6 L IS USM	E
EF 70-300mm f/4-5.6 DO IS USM	E

EF 75-300mm f/4-5.6	E
EF 75-300mm f/4-5.6 USM	E
EF 75-300mm f/4-5.6 II	E
EF 75-300mm f/4-5.6 II USM	E
EF 75-300mm f/4-5.6 III	E
EF 75-300mm f/4-5.6 III USM	E
EF 75-300mm f/4-5.6 IS USM	E
EF 80-200mm f/2.8 L	A
EF 80-200mm f/4.5-5.6	E
EF 80-200mm f/4.5-5.6 USM	F
EF 80-200mm f/4.5-5.6 II	F
EF 90-300mm f/4.5-5.6	E
EF 90-300mm f/4.5-5.6 USM	E
EF 100-200mm f/4.5 A	E
EF 100-300mm f/4.5-5.6 USM	E
EF 100-300mm f/5.6	E
EF 100-300mm f/5.6 L	E
EF 100-400mm f/4.5-5.6 L IS USM	E
EF 100-400mm f/4.5-5.6 L IS USM + Extender EF 1.4x I/II	I (f/8)
EF 100-400mm f/4.5-5.6 L IS USM + Extender EF 1.4x III	E (f/8)
EF 100-400mm f/4.5-5.6 L IS II USM	E
EF 100-400mm f/4.5-5.6 L IS II USM + Extender EF 1.4x I/II	I (f/8)
EF 100-400mm f/4.5-5.6 L IS II USM + Extender EF 1.4x III	E (f/8)
EF 200-400mm f/4 L IS USM Extender 1.4x	D
EF 200-400mm f/4 L IS USM Extender 1.4x: Built-in Ext. 1.4x	E
EF 200-400mm f/4 L IS USM Extender 1.4x + Extender EF 1.4x I/II/III	E
EF 200-400mm f/4 L IS USM Extender 1.4x: Built-in Ext. 1.4x + Extender EF 1.4x I/II	I (f/8)
EF 200-400mm f/4 L IS USM Extender 1.4x: Built-in Ext. 1.4x + Extender EF 1.4x III	E (f/8)
EF 200-400mm f/4 L IS USM Extender 1.4x + Extender EF 2x I/II	I (f/8)
EF 200-400mm f/4 L IS USM Extender 1.4x + Extender EF 2x III	E (f/8)
TS-E 17mm f/4 L	B
TS-E 24mm f/3.5 L	B
TS-E 24mm f/3.5 L II	B
TS-E 45mm f/2.8	A
TS-E 50mm f/2.8 L Macro	B
TS-E 90mm f/2.8	A
TS-E 90mm f/2.8 L Macro	B
TS-E 135mm f/4 L Macro	B

 **Caution**

- AF is not available with Extender EF 2x (I/II/III) attached to the EF 180mm f/3.5 L Macro USM lens.
- Precise autofocus may not be achieved if you use a lens and Extender EF1.4x III/EF2x III combination marked with an asterisk or a lens and extender in a combination marked with two asterisks. In this case, refer to the Instruction Manual of the lens or extender used.

 **Note**

- If you use a TS-E lens, manual focusing is required. TS-E lens group designations apply only when tilt or shift is not used.

System Map

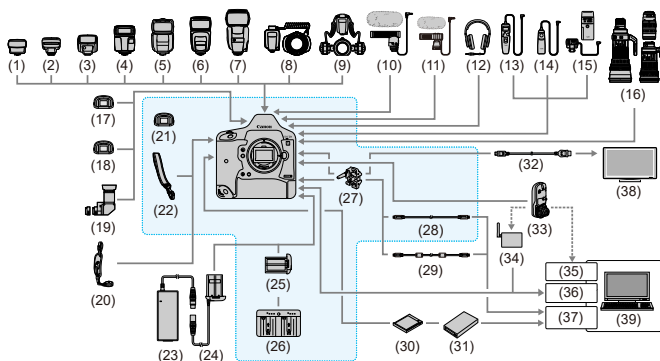

Bundled accessories

- | | |
|------|-------------------------------------|
| (1) | Speedlite Transmitter ST-E2 |
| (2) | Speedlite Transmitter ST-E3-RT |
| (3) | Speedlite 270EX II |
| (4) | Speedlite EL-100 |
| (5) | Speedlite 430EX III-RT/430EX III |
| (6) | Speedlite 470EX-AI |
| (7) | Speedlite 600EX II-RT |
| (8) | Macro Ring Lite MR-14EX II |
| (9) | Macro Twin Lite MT-26EX-RT |
| (10) | Directional Stereo Microphone DM-E1 |
| (11) | Stereo Microphone DM-E100 |
| (12) | Headphones |
| (13) | Timer Remote Controller TC-80N3 |
| (14) | Remote Switch RS-80N3 |
| (15) | Wireless Controller LC-5 |
| (16) | EF lenses |
| (17) | Dioptric Adjustment Lenses Eg |
| (18) | Anti-Fog Eyepiece Eg |
| (19) | Angle Finder C |
| (20) | Hand Strap E2 |

(21)	Eyecup Eg
(22)	Strap
(23)	AC Adapter AC-E19
(24)	DC Coupler DR-E19
(25)	Battery Pack LP-E19 ^{*1}
(26)	Battery Charger LC-E19
(27)	Cable protector
(28)	Interface Cable IFC-100U (approx. 1 m/3.3 ft.) ^{*2, *3}
(29)	Interface Cable IFC-400U (approx. 4m/13.1 ft.) ^{*2, *4}
(30)	CFexpress card
(31)	Card reader
(32)	HDMI Cable HTC-100 (approx. 2.9m/9.5 ft.) ^{*5}
(33)	Wireless File Transmitter WFT-E9
(34)	Wireless LAN access point
(35)	Wireless LAN adapter
(36)	Ethernet port
(37)	USB port
(38)	TV/monitor
(39)	Computer

* 1: The battery charger is designed exclusively for Battery Pack LP-E19.

* 2: Camera and computer end: USB Type-C.

* 3: The transmission rate when IFC-100U is used is equivalent to SuperSpeed USB (USB 3.1 Gen 1).

* 4: The transmission rate when IFC-400U is used is equivalent to Hi-Speed USB (USB 2.0).

* 5: 4K 59.94p/50.00p (4:2:2) output is not supported. When connecting an external device that supports 4K 59.94p/50.00p (4:2:2) video, use a commercially available compatible cable.

Performance Data



- ☑ [Still Photo Shooting](#)
- ☑ [Movie Recording](#)
- ☑ [ISO Speed in Movie Recording](#)
- ☑ [Image Playback](#)

Still Photo Shooting

Number of available shots

(Approx. number of shots)

Temperature	Room Temperature (23°C / 73°F)	Low Temperature (0°C / 32°F)
In viewfinder shooting	2850	2360
In Live View shooting	610	530

- Based on using a fully charged Battery Pack LP-E19, and following CIPA (Camera & Imaging Products Association) testing standards.
- With : **Bluetooth settings**] and : **GPS settings**] set to **[Disable]**.

ISO Auto range

Shooting Mode	ISO Speed	
	No Flash	With Flash
P/Tv/Av/M	ISO 100 ^{*1} , ^{*2} –102400 ^{*2}	ISO 100 ^{*1} , ^{*2} –6400 ^{*2, *3}
BULB	ISO 400 ^{*4}	ISO 400 ^{*4}

* 1: ISO 200 when **[Highlight tone priority]** is set to **[Enable]** or **[Enhanced]**.

* 2: The actual ISO speed range depends on the **[Minimum]** and **[Maximum]** set with **[Auto range]**.

* 3: ISO 1600 for lenses that do not support variable control of maximum ISO Auto limit for E-TTL. For details, refer to the Canon website.

* 4: Changed to the value nearest ISO 400 if out of the setting range.

Guide to image size settings (approx.)

Image Size	Pixels Recorded	File Size (MB)	Available Shots	Maximum Burst
JPEG				
L	20 M	7.6	40650	1,000 or more
M1	13 M	5.4	56960	1,000 or more
M2	8.9 M	4.1	74070	1,000 or more
S	5.0 M	2.8	109110	1,000 or more
HEIF				
L	20 M	7.6	39650	1,000 or more
RAW				
RAW	20 M	22.1	14150	1,000 or more
CRAW	20 M	13.1	27560	1,000 or more
RAW+JPEG				
RAW L	20 M 20 M	22.1 7.6	10500	1,000 or more
CRAW L	20 M 20 M	13.1 7.6	16420	1,000 or more
RAW+HEIF				
RAW L	20 M 20 M	24.3 7.6	9620	350
CRAW L	20 M 20 M	13.7 7.6	14380	420

- Number of shots available and maximum burst as measured in viewfinder shooting with a 325 GB card conforming to Canon testing standards.
- Varies depending on shooting conditions (such as when JPEG/HEIF image quality is set to 8, as well as the subject, memory card brand, ISO speed, Picture Style, and Custom Functions).

Movie Recording

Total movie recording time and file size per minute

(Approx.)

Movie Recording Size			Total Available Recording Time on Card			File Size (Approx. ** MB/min.)
			64 GB	256 GB	1 TB	
4K-D	59.94P 50.00P	RAW	3 min.	13 min.	50 min.	18711
	29.97P 25.00P 24.00P 23.98P	RAW	4 min.	18 min.	1 hr. 13 min.	12937
	59.94P 50.00P	ALL-I	9 min.	36 min.	2 hr. 21 min.	6734
		IPB	36 min.	2 hr. 27 min.	9 hr. 35 min.	1656
	29.97P 25.00P 24.00P 23.98P	ALL-I	18 min.	1 hr. 12 min.	4 hr. 42 min.	3373
		IPB	1 hr. 10 min.	4 hr. 40 min.	18 hr. 17 min.	869
4K-D Crop	59.94P 50.00P	ALL-I	9 min.	36 min.	2 hr. 21 min.	6734
		IPB	36 min.	2 hr. 27 min.	9 hr. 35 min.	1656
	29.97P 25.00P 24.00P 23.98P	ALL-I	18 min.	1 hr. 12 min.	4 hr. 42 min.	3373
		IPB	1 hr. 10 min.	4 hr. 40 min.	18 hr. 17 min.	869
4K-U	59.94P 50.00P	ALL-I	9 min.	36 min.	2 hr. 21 min.	6734
		IPB	36 min.	2 hr. 27 min.	9 hr. 35 min.	1656
	29.97P 25.00P 23.98P	ALL-I	18 min.	1 hr. 12 min.	4 hr. 42 min.	3373
		IPB	1 hr. 10 min.	4 hr. 40 min.	18 hr. 17 min.	869
FHD	119.9P 100.0P	ALL-I	23 min.	1 hr. 34 min.	6 hr. 8 min.	2586
	59.94P 50.00P	ALL-I	47 min.	3 hr. 8 min.	12 hr. 14 min.	1298
		IPB	2 hr. 18 min.	9 hr. 14 min.	36 hr. 6 min.	440
	29.97P 25.00P 23.98P	ALL-I	1 hr. 33 min.	6 hr. 12 min.	24 hr. 16 min.	655
		IPB	4 hr. 30 min.	18 hr. 2 min.	70 hr. 27 min.	226
		IPB+	11 hr. 35 min.	46 hr. 23 min.	181 hr. 13 min.	88

⚠ Caution

- An increase of the camera's internal temperature may cause movie recording to stop before the total recording time shown in the table (🔒).

Total possible time for movie recording

(Approx.)



Temperature	Room Temperature (+23°C / 73°F)	Low Temperature (0°C / 32°F)
FHD 29.97P 25.00P 1PB	4 hr. 40 min.	4 hr. 10 min.

- With a fully charged Battery Pack LP-E19.
- With **[Movie Servo AF]** set to **[Disable]**.
- With [☑: **Bluetooth settings**] and [☑: **GPS settings**] set to **[Disable]**.





ISO Speed in Movie Recording

- The maximum limit is not expanded when the camera is set for RAW movies, even with **[Max for Auto]** set to **[H(51200)]**, **[H(102400)]**, or **[H(204800)]**.

In / > / > mode

- The ISO speed will be set automatically within ISO 100–25600.
- Setting **[Max for Auto]** in : **ISO speed settings** to **[H1(204800)]** (🔗) expands the maximum speed in the automatic setting range to H1 (equivalent to ISO 204800).
- The minimum speed in the automatic setting range is ISO 200 when : **Highlight tone priority** is set to **[Enable]** or **[Enhanced]** (🔗). The maximum limit is not expanded, even when expansion is set in **[Max for Auto]**.
- The minimum speed in the automatic setting range is ISO 400 when : **Canon Log settings** is set to **[On]** (🔗).

In > mode

- With ISO speed set to **[AUTO]**, the speed is automatically set in a range of ISO 100–25600.
- When ISO Auto is set, setting **[Max for Auto]** in : **ISO speed settings** to **[H1(204800)]** (🔗) expands the maximum speed in the automatic setting range to H1 (equivalent to ISO 204800).
- ISO speed can be set manually in a range of ISO 100–25600. Note that setting **[ISO speed range]** in : **ISO speed settings** to **[H1(204800)]** (🔗) expands the maximum speed in the manual setting range to H1 (equivalent to ISO 204800).
- The minimum speed in the automatic or manual setting range is ISO 200 when : **Highlight tone priority** is set to **[Enable]** or **[Enhanced]** (🔗). Even when ISO speed expansion is set, the maximum limit will not be expanded.
- The minimum speed in the automatic setting range is ISO 400 when : **Canon Log settings** is set to **[On]** (🔗). ISO 100–320 represents an expanded ISO speed (L).

Caution

- Expanded ISO speeds are not available when the camera is set for RAW movies.

Resize options, by original JPEG image quality

Original Image Quality	Available Resize Settings		
	M1	M2	S
L	○	○	○
M1		○	○
M2			○

Information Display

- [Quick Control Screen \(in Viewfinder Shooting\)](#)
- [Button Operations on the Quick Control/Custom Quick Control Screen](#)
- [Live View Shooting Screen](#)
- [Movie Recording Screen](#)
- [Playback Screen](#)



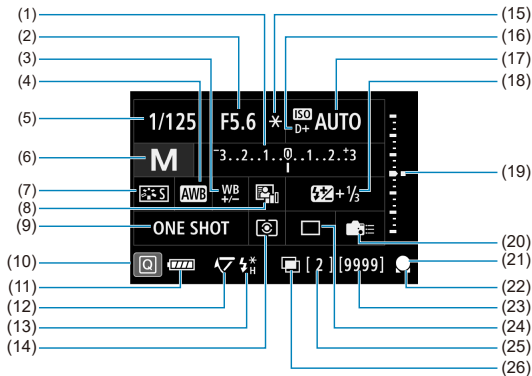



Quick Control Screen (in Viewfinder Shooting)



* The display will show only the settings currently applied.

(1)	Exposure compensation
(2)	Aperture value
(3)	White balance correction
(4)	White balance
(5)	Shutter speed
(6)	Shooting mode
(7)	Picture Style
(8)	Auto Lighting Optimizer
(9)	AF operation
(10)	Quick Control icon
(11)	Battery level
(12)	Mirror lockup
(13)	Flash ready/FE lock/High-speed sync
(14)	Metering mode
(15)	AE lock
(16)	Highlight tone priority
(17)	ISO speed
(18)	Flash exposure compensation
(19)	Exposure level indicator
(20)	Custom Controls
(21)	Focus indicator
(22)	AF operation indicator/Auto cleaning
(23)	Available shots
(24)	Drive mode
(25)	Maximum burst/Number of remaining multiple exposures
(26)	Multiple exposures

Button Operations on the Quick Control/Custom Quick Control Screen

Press the <MODE> / <DRIVE•AF> /  •  > / < > / <ISO> / < > / <WB> buttons to access the corresponding setting screen, then use < > / < > / < > / <M-Fn> to set the function.

Shooting mode

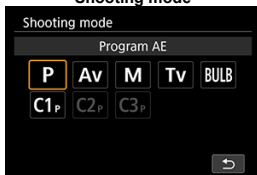

AF operation/drive mode

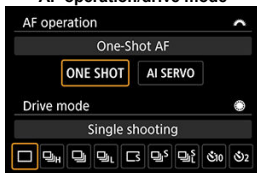

Metering mode/flash exposure compensation



AF point selection

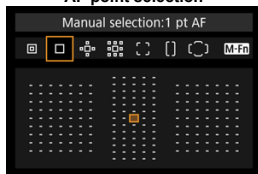

ISO speed

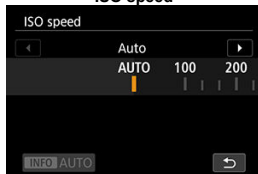

Exposure compensation



White balance

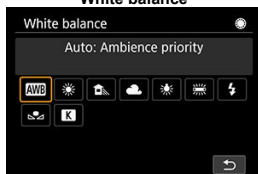

AEB setting

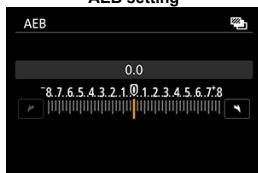

Live View Shooting Screen

Each time you press the <INFO> button, the information display will change.

- The display will show only the settings currently applied.

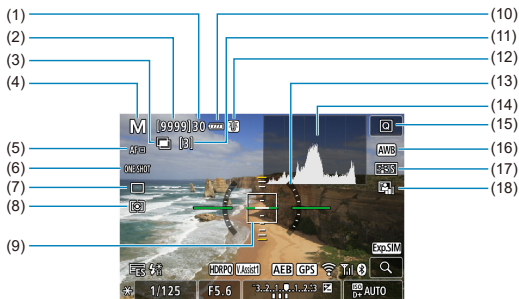

-
- (1) Maximum burst
 - (2) Available shots/Sec. until self-timer shoots
 - (3) Multiple exposures
 - (4) Shooting mode
 - (5) AF method
 - (6) AF operation
 - (7) Drive mode
 - (8) Metering mode
 - (9) AF point (1-point AF)
 - (10) Battery level
 - (11) Number of remaining multiple exposures
 - (12) Temperature warning
 - (13) Electronic level
 - (14) Histogram
 - (15) Quick Control button
 - (16) White balance/White balance correction
 - (17) Picture Style
 - (18) Auto Lighting Optimizer
-

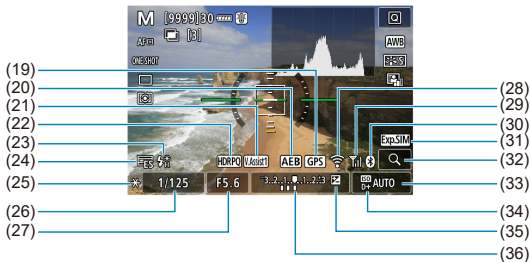

- (19) GPS acquisition status
- (20) AEB/FEB
- (21) View Assist
- (22) HDR PQ
- (23) Flash ready/FE lock/High-speed sync
- (24) Electronic shutter
- (25) AE lock
- (26) Shutter speed/Multi-function lock warning
- (27) Aperture value
- (28) Wi-Fi function
- (29) Wi-Fi signal strength
- (30) Bluetooth function
- (31) Exposure simulation
- (32) Magnify button
- (33) ISO speed
- (34) Highlight tone priority
- (35) Exposure compensation
- (36) Exposure level indicator (metering levels)

Note

- You can specify the information displayed in response to pressing the <INFO> button (📷).
- The electronic level is not displayed when the camera is connected via HDMI to a television.
- Other icons may be displayed temporarily after setting adjustments.

Movie Recording Screen

Each time you press the <INFO> button, the information display will change.

- The display will show only the settings currently applied.

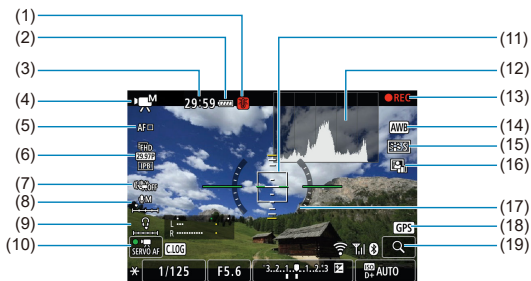

- (1) Temperature warning
- (2) Battery level
- (3) Time available per recording/Elapsed recording time
- (4) Movie recording mode/High Frame Rate movie
- (5) AF method
- (6) Movie recording size
- (7) Movie digital IS
- (8) Audio recording level (manual/line input)
- (9) Headphone volume
- (10) Movie Servo AF
- (11) AF point (1-point AF)
- (12) Histogram (for manual exposure)
- (13) Movie recording in progress
- (14) White balance/White balance correction
- (15) Picture Style
- (16) Auto Lighting Optimizer
- (17) Electronic level
- (18) GPS acquisition status
- (19) Magnify button

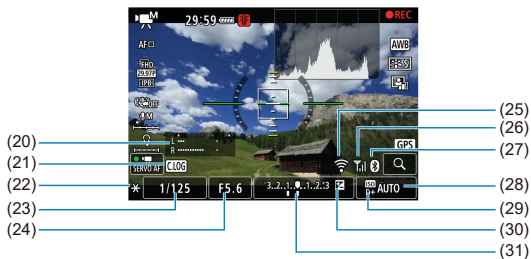

(20) Audio recording level indicator (manual/line input)

(21) Canon Log

(22) AE lock

(23) Shutter speed

(24) Aperture value

(25) Wi-Fi function

(26) Wi-Fi signal strength

(27) Bluetooth function

(28) ISO speed

(29) Highlight tone priority

(30) Exposure compensation

(31) Exposure level indicator (metering levels)

Caution

- You can specify the information displayed in response to pressing the **<INFO>** button (📄).
- The electronic level is not displayed when the camera is connected via HDMI to a television.
- The electronic level, grid lines, and histogram cannot be displayed during movie recording (and if they are currently displayed, recording a movie will clear the display).
- Time available per recording changes to elapsed time after movie recording begins.

Note

- Other icons may be displayed temporarily after setting adjustments.

Playback Screen

Basic information display for still photos



- | | |
|------|--|
| (1) | HDR output status/View Assist |
| (2) | Bluetooth function |
| (3) | Wi-Fi signal strength |
| (4) | Wi-Fi function |
| (5) | Battery level |
| (6) | Current image no./Total images/No. of images found |
| (7) | Shutter speed |
| (8) | Aperture value |
| (9) | Exposure compensation amount |
| (10) | Already sent to a computer/smartphone |
| (11) | Voice memo |
| (12) | Rating |
| (13) | Image protection |
| (14) | Card no. |
| (15) | Folder no.-File no. |
| (16) | Image quality/Edited image/Cropping/Frame Grab |
| (17) | ISO speed |
| (18) | Highlight tone priority |

 **Caution**

- If the image was taken by another camera, certain shooting information may not be displayed.
- It may not be possible to play back images taken with this camera on other cameras.

Detailed information display for still photos

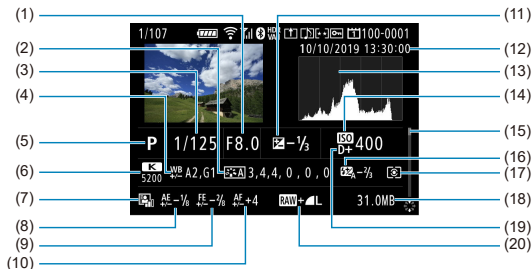

- | | |
|------|--|
| (1) | Aperture value |
| (2) | Picture Style/Settings |
| (3) | Shutter speed |
| (4) | WB correction/Bracketing |
| (5) | Shooting mode/Multiple exposure/Frame Grab |
| (6) | White balance |
| (7) | Auto Lighting Optimizer |
| (8) | AE Microadjustment |
| (9) | FE Microadjustment |
| (10) | AF Microadjustment |
| (11) | Exposure compensation amount |
| (12) | Shooting date and time |
| (13) | Histogram (Brightness/RGB) |
| (14) | ISO speed |
| (15) | Scroll bar |
| (16) | Flash exposure compensation amount/Bounce |
| (17) | Metering mode |
| (18) | File size |
| (19) | Highlight tone priority |
| (20) | Image quality/Edited image/Cropping |

* For images captured in RAW+JPEG/HEIF shooting, indicates RAW file sizes.

* For images with added cropping information, lines are shown to indicate the image area.

* During flash photography without flash exposure compensation, <  > will be displayed.

* <  > will be displayed for images shot with bounce flash photography.

* <  > will be displayed for images shot in multiple-exposure shooting.

* <  > indicates images created and saved by performing RAW image processing, resizing, cropping, or frame-grabbing.

* <  > will be displayed for images cropped and then saved.

Detailed information display for movies

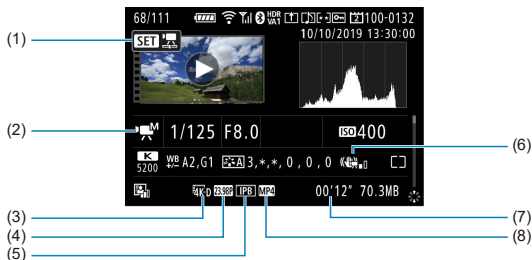

- (1) Movie playback
- (2) Movie recording mode/High Frame Rate
- (3) Image size
- (4) Frame rate
- (5) Compression method
- (6) Movie digital IS
- (7) Recording time
- (8) Movie recording format

* For simplicity, explanations are omitted for items that are also included in basic/detailed information display for still photos, which are not shown here.

Note

- During movie playback, “*,*” is displayed for the [Fineness] and [Threshold] parameters of [Sharpness] in [Picture Style].

Specifications

Type

Type	Digital single-lens reflex AF/AE camera
Recording media	CFexpress memory card * Type B compatible: 2 card slots
Image sensor size	Approx. 35.9×23.9 mm
Compatible lenses	Canon EF lens product groups * Excluding EF-S and EF-M lenses (Effective angle of view is approx. equivalent to the indicated focal length.)
Lens mount	Canon EF mount

Image sensor

Type	CMOS sensor
Effective pixels	Approx. 20.1 megapixels * Rounded to the nearest 100,000.
Aspect ratio	3:2
Dust deletion	Auto/Manual, Appending Dust Delete Data

Recording system

Recording format	DCF 2.0																			
Image type	JPEG (8-bit), HEIF (10-bit), RAW (14-bit Canon original) RAW+JPEG simultaneous recording possible RAW+HEIF simultaneous recording possible * 12 bit A/D conversion processing is applied for RAW images shot with the electronic shutter.																			
Pixels recorded	<table border="1"> <thead> <tr> <th colspan="2">Image Quality</th> <th>Pixel Count</th> </tr> </thead> <tbody> <tr> <td rowspan="4">JPEG</td> <td>L</td> <td>Approx. 20.0 megapixels (5472×3648)</td> </tr> <tr> <td>M1</td> <td>Approx. 12.7 megapixels (4368×2912)</td> </tr> <tr> <td>M2</td> <td>Approx. 8.9 megapixels (3648×2432)</td> </tr> <tr> <td>S</td> <td>Approx. 5.0 megapixels (2736×1824)</td> </tr> <tr> <td>HEIF</td> <td>L</td> <td>Approx. 20.0 megapixels (5472×3648)</td> </tr> <tr> <td>RAW</td> <td>RAW/C-RAW</td> <td>Approx. 20.0 megapixels (5472×3648)</td> </tr> </tbody> </table> <p>* Rounded to the nearest 100,000.</p>		Image Quality		Pixel Count	JPEG	L	Approx. 20.0 megapixels (5472×3648)	M1	Approx. 12.7 megapixels (4368×2912)	M2	Approx. 8.9 megapixels (3648×2432)	S	Approx. 5.0 megapixels (2736×1824)	HEIF	L	Approx. 20.0 megapixels (5472×3648)	RAW	RAW/C-RAW	Approx. 20.0 megapixels (5472×3648)
Image Quality		Pixel Count																		
JPEG	L	Approx. 20.0 megapixels (5472×3648)																		
	M1	Approx. 12.7 megapixels (4368×2912)																		
	M2	Approx. 8.9 megapixels (3648×2432)																		
	S	Approx. 5.0 megapixels (2736×1824)																		
HEIF	L	Approx. 20.0 megapixels (5472×3648)																		
RAW	RAW/C-RAW	Approx. 20.0 megapixels (5472×3648)																		
Recording features	Still photo/movie separate, Still photo recording options, Movie recording options, Still photo record/play, Movie record/play																			
Folder creation and selection	Available																			
File naming	Preset code, User Defined 1, User Defined 2																			
File numbering	Continuous, Auto reset, Manual reset																			

Image processing during shooting

Picture Style	Auto, Standard, Portrait, Landscape, Fine Detail, Neutral, Faithful, Monochrome, User Defined 1–3
White balance	Auto (Ambience priority), Auto (White priority), Preset (Daylight, Shade, Cloudy, Tungsten light, White fluorescent light, Flash), Custom (5 settings), Color temperature setting (approx. 2500–10000 K) White balance correction and bracketing available * Flash color temperature information transmission possible
White balance correction	Blue/amber correction: ± 9 levels Magenta/green correction: ± 9 levels
White balance bracketing	± 3 stops, in 1 stop increments
Automatic image brightness correction	Auto Lighting Optimizer
Noise reduction	Applicable to high ISO speed shots and long exposures
Highlight tone priority	Available
Lens aberration correction	Peripheral illumination correction, Distortion correction, Digital Lens Optimizer, Chromatic aberration correction, Diffraction correction

Viewfinder

Type	Eye-level pentaprism
Field of view (coverage)	Vertical/Horizontal approx. 100% (with eyepoint approx. 20 mm)
Magnification	Approx. $0.76\times$ (-1 m^{-1} with 50 mm lens at infinity)
Eyepoint	Approx. 20 mm (from eyepiece lens end at -1 m^{-1})
Dioptic adjustment range	Approx. -3.0 to $+1.0\text{ m}^{-1}$ (dpt)
Eyepiece shutter	Built-in
Focusing screen	Fixed
Mirror	Quick-return type
Depth-of-field preview	Available

Autofocus (viewfinder shooting)

Focus method	TTL secondary image-registration, phase-difference detection with the dedicated AF sensor
AF points	191 points max. (cross-type AF points: 155 points max.) * Number of available AF points, Dual cross-type AF points, and Cross-type AF points vary depending on the lens used. * Dual cross-type focusing at f/2.8 with center AF point
Focusing brightness range	EV -4 to 21 (with the center AF point supporting f/2.8, One-Shot AF, room temperature, ISO 100)
Focus operation	One-Shot AF, AI Servo AF, manual focusing (MF)
AF area selection mode	Spot AF (manual selection), 1-point AF (manual selection), AF point expansion (manual selection, vertical/horizontal), AF point expansion (manual selection: surround), Zone AF (manual selection of zone), Large zone AF (manual selection of zone), Auto selection AF
Subject detection AF	EOS ITR AF setting (can recognize color information, faces, and heads) * ITR: Intelligent Tracking and Recognition
AF Configuration Tool	Cases 1-4, Case A
AI Servo AF characteristics	Tracking sensitivity, Acceleration/deceleration tracking
AF fine adjustment	AF Microadjustment (All lenses by the same amount, Adjust by lens)
AF-assist beam	Fired by an external flash unit for EOS cameras

Autofocus (Live View shooting/Movie recording)

Focus method	Dual Pixel CMOS AF * AF not available in RAW or 4K 59.94 p/50.00 p (NTSC/PAL) movie recording
AF method	Face+Tracking, Spot AF, 1-point AF, Expand AF area (vertically/horizontally), Expand AF area: Around, Zone AF, Large Zone AF: Vertical, Large Zone AF: Horizontal
Available AF point positions	Max. 3869 * When selected with the Multi-controller
Available AF areas when automatically selected	Max. 525
Eye Detection AF	Available
Magnified view	Approx. 5×/10×
AF area	Horizontal: Approx. 90%, Vertical: Approx. 100% Horizontal: Approx. 80%, Vertical: Approx. 80% * Varies depending on the lens used
Manual focus (MF)	MF peaking, Focus guide

[Live View shooting]

AF operation	One-Shot AF, Servo AF
Continuous AF	Available
Focusing brightness range	EV -6 to 18 (f/1.2, center AF point, at room temperature, ISO 100, One-Shot AF)
AF Configuration Tool	Cases 1-4, Case A
Servo AF characteristics	Tracking sensitivity, Acceleration/deceleration tracking

[Movie recording]

Focusing brightness range	EV -4 to 18 (f/1.2, center AF point, at room temperature, ISO 100, One-Shot AF, 29.97 fps)
Movie Servo AF	Available
Movie Servo AF characteristics	Tracking sensitivity, AF speed

Exposure control

Metering mode	<p>Viewfinder shooting: 216-zone (18×12) TTL open-aperture metering with an approx. 400,000-pixel RGB+IR metering sensor</p> <p>Live View shooting/movie recording: 384-zone (24×16) metering with signals from the image sensor</p>
Metering mode	<p>Viewfinder shooting: Evaluative metering Partial metering (approx. 6.2% of screen) Spot metering (approx. 1.5% of screen) * Options include spot metering linked to AF points and multi-spot metering Center-weighted average metering</p> <p>Live View shooting: Evaluative metering, Partial metering (approx. 5.8% of screen), Spot metering (approx. 2.9% of screen)</p> <p>Movie recording: Center-weighted average metering, Evaluative metering * Set automatically based on shooting conditions</p>
Focusing brightness range	<p>Viewfinder shooting: EV 0 to 20 (at room temperature, ISO 100)</p> <p>Live View shooting/movie recording: EV -3 to 20 (at room temperature, ISO 100)</p>
Shooting mode	<p>Still photo shooting: Program AE, Shutter-priority AE, Aperture-priority AE, Manual exposure, Bulb exposure, Custom shooting modes (C1/C2/C3)</p> <p>Movie recording: Program AE, Shutter-priority AE, Aperture-priority AE, Manual exposure, Custom shooting modes (C1/C2/C3)</p>
ISO speed (recommended exposure index)	<p>Still photo shooting: ISO Auto (automatically set within ISO 100–102400), manually set within ISO 100–102400 (in 1/3- or 1-stop increments), expandable to L (equivalent to ISO 50), H1 (equivalent to ISO 204800), H2 (equivalent to ISO 409600), or H3 (equivalent to ISO 819200) * ISO 200–102400 with Highlight tone priority set</p> <p>Movie recording: Program AE/Av/Tv: ISO Auto (automatically set within ISO 100–25600), expandable to H1 (equivalent to ISO 204800) M: ISO Auto (automatically set within ISO 100–25600), manually set within ISO 100–25600 (in 1/3- or 1-stop increments), expandable to H1 (equivalent to ISO 204800) * ISO 200–25600 with Highlight tone priority set</p>
ISO speed settings	<p>Still photo shooting: ISO speed range, Auto range, Minimum shutter speed</p> <p>Movie recording: ISO speed range, Max for Auto</p>
Exposure compensation	<p>Manual: ±5 stops in 1/3- or 1/2-stop increments (viewfinder shooting), or ±3 stops in 1/3- or 1/2-stop increments (Live View shooting, movie recording) AEB: ±3 stops in 1/3- or 1/2-stop increments (can be combined with manual exposure compensation)</p>
AE lock	<p>Still photo shooting: Auto: AE lock when focus is achieved can be enabled or disabled for each metering mode with a Custom Function Manual: With AE lock button</p> <p>Movie recording: With AE lock button</p>
Flicker reduction	Available (viewfinder shooting)

Multiple exposures

Shooting method	Function/control priority, Continuous shooting priority
Number of multiple exposures	2 to 9 exposures
Multiple-exposure control	Additive, Average, Bright, Dark

HDR shooting (still photo HDR PQ)

Recording format	HEIF
Bit depth	10-bit
Color sampling	YCbCr 4:2:2
HDR specification	ITU-R BT.2100 (PQ)

Shutter

Type	Electronically controlled, focal-plane shutter
Shutter mode	Viewfinder shooting: Mechanical Live View shooting: Mechanical, Electronic 1st-curtain, Electronic
Shutter speed	Mechanical/Electronic 1st-curtain set: 1/8000 sec. to 30 sec., Bulb Electronic set: 1/8000 sec. to 0.5 sec. Max. shutter speed with flash sync: 1/250 sec. * Setting range differs when recording movies

Drive system

Drive mode	Single shooting, High-speed continuous shooting, Medium-speed continuous shooting, Low-speed continuous shooting, Single Soft shooting, Soft continuous shooting, Soft low speed continuous shooting, Self-timer: 10 sec, Self-timer: 2 sec			
Continuous shooting speed	Drive Mode		Viewfinder Shooting	Live View Shooting ²
	High-speed continuous shooting ¹	One-Shot AF	Max. approx. 16 shots/sec. (setting range: 3–16 shots/sec.)	Max. approx. 20 shots/sec.
		AI Servo AF/ Servo AF		
	Medium-speed continuous shooting	One-Shot AF	Approx. 10 shots/sec. (setting range: 2–15 shots/sec.)	Approx. 10 shots/sec. ⁺³
		AI Servo AF/ Servo AF		
	Low-speed continuous shooting	One-Shot AF	Approx. 3.0 shots/sec. (setting range: 1–14 shots/sec.)	Approx. 3.0 shots/sec.
		AI Servo AF/ Servo AF		
Soft continuous shooting		Approx. 8.0 shots/sec. (setting range: 2–8 shots/sec.)	Approx. 10 shots/sec. ⁺³	
Soft low speed continuous		Approx. 3.0 shots/sec. (setting range: 1–7 shots/sec.)	Approx. 3.0 shots/sec.	
Maximum burst	JPEG Large: 1,000 shots or more HEIF Large: 1,000 shots or more RAW: 1,000 shots or more RAW+JPEG Large: 1,000 shots or more RAW+HEIF Large: approx. 350 shots * In viewfinder shooting with a 325 GB card conforming to Canon testing standards * Varies depending on shooting conditions (such as when JPEG/HEIF image quality is set to 8, as well as the subject, memory card brand, ISO speed, Picture Style, and Custom Functions)			

External Speedlite

Compatible Speedlites	EL/EX series Speedlites
Flash metering	E-TTL II autofocus
Flash exposure compensation	±3 stops in 1/3- or 1/2-stop increments
FE lock	Available
PC terminal	Available
Flash control	Flash function settings, Flash Custom Function settings

Movie recording

Normal movies			Canon Log	
			OFF	ON
	Recording format		MP4	
	Compression		MPEG-4 H.264/AVC	MPEG-4 H.265/HEVC
	Video signal recording range		Full range (0–255)	Full range (128–1016)
	Color sampling		YCbCr 4:2:0 (8-bit)	YCbCr 4:2:2 (10-bit)
	Color Matrix		Rec.ITU-R BT.709	Rec.ITU-R BT.709/BT.2020
	Audio	ALL-I/IPB	AAC/Linear PCM*	
IPB (Light)		AAC		
* AAC or Linear PCM can be selected in [C.Fn7-7: Audio compression]				
RAW movies			Canon Log	
			OFF	ON
	Recording format		RAW (12-bit)	
	Audio		Linear PCM	
Movie recording size	RAW (5472×2886), 4K DCI (4096×2160), 4K DCI cropped (4096×2160), 4K UHD (3840×2160), Full HD (1920×1080)			
Frame rate	119.9p/59.94p/29.97p/24.00p/23.98p (with NTSC) 100.0p/50.00p/25.00p/24.00p (with PAL) * 119.9p/100.0p used for High Frame Rate movies			
Compression method	ALL-I (For editing), IPB (Standard), IPB (Light)			

Bit rate	RAW (59.94p/50.00p)	Approx. 2600 Mbps
	RAW (29.97p/25.00p/24.00p/23.98p)	Approx. 1800 Mbps
	4K DCI (59.94p/50.00p)/ALL-I	Approx. 940 Mbps
	4K DCI (59.94p/50.00p)/IPB	Approx. 230 Mbps
	4K DCI (29.97p/25.00p/24.00p/23.98p)/ALL-I	Approx. 470 Mbps
	4K DCI (29.97p/25.00p/24.00p/23.98p)/IPB	Approx. 120 Mbps
	4K DCI cropped (59.94p/50.00p)/ALL-I	Approx. 940 Mbps
	4K DCI cropped (59.94p/50.00p)/IPB	Approx. 230 Mbps
	4K DCI cropped (29.97p/25.00p/24.00p/23.98p)/ALL-I	Approx. 470 Mbps
	4K DCI cropped (29.97p/25.00p/24.00p/23.98p)/IPB	Approx. 120 Mbps
	4K UHD (59.94p/50.00p)/ALL-I	Approx. 940 Mbps
	4K UHD (59.94p/50.00p)/IPB	Approx. 230 Mbps
	4K UHD (29.97p/25.00p)/ALL-I	Approx. 470 Mbps
	4K UHD (29.97p/25.00p)/IPB	Approx. 120 Mbps
	Full HD (119.9p/100.0p)/ALL-I	Approx. 360 Mbps
	Full HD (59.94p/50.00p)/ALL-I	Approx. 180 Mbps
	Full HD (59.94p/50.00p)/IPB	Approx. 60 Mbps
	Full HD (29.97p/25.00p)/ALL-I	Approx. 90 Mbps
	Full HD (29.97p/25.00p)/IPB	Approx. 30 Mbps
Full HD (29.97p/25.00p)/IPB (Light)	Approx. 12 Mbps	
Time code	Can be added	
Drop frame	119.9p/59.94p/29.97p supported	
Sound recording	Built-in monaural microphone; external stereo microphone terminal included, and line input supported Sound-recording level adjustable, wind filter provided, attenuator provided	
Headphone	Headphone terminal provided, volume adjustable	
Movie Digital IS	Available	
Canon Log	Available as a shooting option	
Still photo shooting	Not available during movie recording	
HDMI output	Image output without information display available *4K output supported; Auto/1080p selectable	

Screen

Type	TFT color, liquid-crystal monitor
Screen size and dots	Approx. 8.01 cm (3.15 in.) (3:2) with approx. 2.1 million dots
Brightness adjustment	Manual (7 levels)
Color tone adjustment	Warm tone, Standard, Cool tone 1, Cool tone 2
Interface languages	29
Touch-screen panel	Capacitive sensing
System status display	Available for reference

Playback

Image display format	Without shooting information, with basic information, with detailed shooting information, index display (4/9/36/100 images)
Highlight alert	Overexposed highlights blink
AF point display	Available (except under certain shooting conditions)
Grid display	3 types
Magnified view	Approx. 1.5×–10×, initial magnification and position settable
Image search	Search conditions settable (by rating, date, folder, protected, type of file)
Image browsing	1 image, 10 images, Specified number, Date, Folder, Movies, Stills, Protect, Rating
Image rotation	Available
Image protection	Available
Rating	Available
Voice memo	Recording and playback
Movie playback	Available
Start/end movie scene editing	Available
4K movie frame grab	Extraction of specified movie frames and saving as JPEG images
Slide show	All images or images matching the search conditions are played back automatically.
Image copying	Available
Converting HEIF to JPEG	Available
In-camera RAW image processing	Brightness adjustment, White balance, Picture Style, Clarity, Auto Lighting Optimizer, High ISO speed noise reduction, Image quality, Color space, Lens aberration correction (Peripheral illumination correction, Distortion correction, Digital Lens Optimizer, Chromatic aberration correction, Diffraction correction)
Resizing	Available
Cropping	Available
Print order	DPOF Version 1.1 compatible

Communication Functions

[Wi-Fi]

Standards compliance	IEEE 802.11b/g/n
Transmission method	DS-SS modulation (IEEE 802.11b), OFDM modulation (IEEE 802.11g/n)
Transmission frequency (central frequency)	Frequency: 2412 to 2462 MHz Channels: 1–11
Connection method	Camera access point mode, infrastructure* * Wi-Fi Protected Setup supported
Security	Authentication method: Open system, Shared key, or WPA/WPA2-PSK Encryption: WEP, TKIP, AES
Compatible devices	Smartphone, computer, FTP server

[Wired LAN]

Type	Ethernet
Standards compliance	IEEE 802.3u (10BASE-T/100BASE-TX/1000BASE-T)
Compatible devices	Access point, computer, EOS-1D X Mark III* * When syncing time between cameras

[Bluetooth]

Standards compliance	Bluetooth Specification Version 4.2 compliant (Bluetooth low energy technology)
Transmission method	GFSK modulation
Compatible devices	Smartphone

GPS features

Compatible satellites	GPS satellites (USA), GLONASS satellites (Russia), Quasi-Zenith Satellite System Michibiki (Japan)
Image geotagging	Latitude, longitude, elevation, Coordinated Universal Time (UTC), signal acquisition status
Position update interval	1, 5, 10, 15, or 30 sec., or 1, 2, or 5 min.
Position data retention	10 min., 30 min., 1 hr., 3 hr., 6 hr., unlimited
Time adjustment	Camera time can be set from GPS time data
Log data	One file generated daily, NMEA format * Change of time zone creates a separate file * Log data in internal memory can be transferred to cards or imported to a computer as log files
Log data deletion	Available

Customization features

Custom Functions	38 functions
Custom Quick Control	Available
Saving camera settings	Up to 10 settings can be registered on a card
Custom shooting modes	Still photo C1/C2/C3 modes, movie C1/C2/C3 modes
My Menu	Up to 5 screens can be registered
Copyright information	Text entry and appending possible
IPTC information	Can be added

Interfaces

Digital terminal	SuperSpeed Plus USB (USB 3.1 Gen 2) equivalent, USB Type-C Computer communication
HDMI mini OUT terminal	Type C (auto switching of resolution)
External microphone input/line input terminal	3.5 mm diameter stereo mini-jack Directional Stereo Microphone DM-E1, Stereo Microphone DM-E100, or commercially available external microphones can be connected
Headphone terminal	3.5 mm diameter stereo mini-jack
Remote control terminal	For N3-type remote control units
System extension terminal	Wireless File Transmitter WFT-E9 connection
Ethernet terminal	RJ-45 terminal

Power

Battery	Battery Pack LP-E19, quantity: 1 * AC power usable with household power outlet accessories
Battery information	Power source, Battery level, Shutter count, Recharge performance possible
Number of available shots	Viewfinder shooting: Approx. 2850 shots at room temperature (+23°C/73°F), approx. 2360 shots at low temperatures (0°C/32°F) Live View shooting: Approx. 610 shots at room temperature (+23°C/73°F), approx. 530 shots at low temperatures (0°C/32°F) * With a fully charged Battery Pack LP-E19.
Movie recording time available	Total approx. 4 hr. 40 min. at room temperature (+23°C/73°F) Total approx. 4 hr. 10 min. at low temperatures (0°C/32°F) * Using a fully charged Battery Pack LP-E19 with Movie Servo AF disabled to record Full HD 29.97p/25.00p IPB (Standard)

Dimensions and weight

Dimensions (W×H×D)	Approx. 158.0×167.6×82.6 mm/6.22×6.60×3.25 in.
Weight	Approx. 1440 g/50.80 oz. (including battery pack and card)/Approx. 1250 g/44.09 oz. (body only)

Operating environment

Working temperature range	0–45°C (32–113°F)
Working humidity	85% or less

- All data above is based on Canon testing standards and CIPA (Camera & Imaging Products Association) testing standards and guidelines.
- Dimensions and weight listed above are based on CIPA Guidelines (except weight for camera body only).
- Product specifications and appearance are subject to change without notice.
- If a problem occurs with a non-Canon lens attached to the camera, contact the respective lens manufacturer.

Trademarks and Licensing

[✔ Trademarks](#)

[✔ About MPEG-4 Licensing](#)

[✔ Accessories](#)

Trademarks

- Adobe is a trademark of Adobe Systems Incorporated.
- Microsoft and Windows are trademarks or registered trademarks of Microsoft Corporation in the United States and/or other countries.
- App Store and macOS are trademarks of Apple Inc., registered in the U.S. and other countries.
- Google Play and Android are trademarks of Google LLC.
- IOS is a trademark or registered trademark of Cisco in the U.S. and other countries and is used under license.
- QR Code is a trademark of Denso Wave Inc.
- HDMI, HDMI logo, and High-Definition Multimedia Interface are trademarks or registered trademarks of HDMI Licensing LLC.
- The Wi-Fi CERTIFIED logo and the Wi-Fi Protected Setup mark are trademarks of the Wi-Fi Alliance.
- The Bluetooth® word mark and logos are registered trademarks owned by Bluetooth SIG, Inc. and any use of such marks by Canon Inc. is under license. Other trademarks and trade names are those of their respective owners.
- All other trademarks are the property of their respective owners.

About MPEG-4 Licensing

"This product is licensed under AT&T patents for the MPEG-4 standard and may be used for encoding MPEG-4 compliant video and/or decoding MPEG-4 compliant video that was encoded only (1) for a personal and non-commercial purpose or (2) by a video provider licensed under the AT&T patents to provide MPEG-4 compliant video. No license is granted or implied for any other use for MPEG-4 standard."

THIS PRODUCT IS LICENSED UNDER THE AVC PATENT PORTFOLIO LICENSE FOR THE PERSONAL USE OF A CONSUMER OR OTHER USES IN WHICH IT DOES NOT RECEIVE REMUNERATION TO (i) ENCODE VIDEO IN COMPLIANCE WITH THE AVC STANDARD ("AVC VIDEO") AND/OR (ii) DECODE AVC VIDEO THAT WAS ENCODED BY A CONSUMER ENGAGED IN A PERSONAL ACTIVITY AND/OR WAS OBTAINED FROM A VIDEO PROVIDER LICENSED TO PROVIDE AVC VIDEO. NO LICENSE IS GRANTED OR SHALL BE IMPLIED FOR ANY OTHER USE. ADDITIONAL INFORMATION MAY BE OBTAINED FROM MPEG LA, L.L.C. SEE [HTTP://WWW.MPEGLA.COM](http://www.mpegla.com)

* Notice displayed in English as required.

Accessories

Use of genuine Canon accessories is recommended

This product is designed to achieve optimum performance when used with genuine Canon accessories. Therefore, using this product with genuine accessories is highly recommended. Canon shall not be liable for any damage to this product and/or accidents such as malfunction, fire, etc. caused by the failure of non-genuine Canon accessories (e.g., a leakage and/or explosion of a battery). Please note that repairs arising out of the malfunction of non-genuine accessories will not be covered by the warranty for repairs, although you may request such repairs on a chargeable basis.

Caution

- Battery Pack LP-E19 is dedicated to Canon products only. Using it with an incompatible battery charger or product may result in malfunction or accidents for which Canon cannot be held liable.