

Canon

EOS-1D

Mark IV



ENGLISH

**INSTRUCTION
MANUAL**

Canon
EOS-1D
Mark IV

INSTRUCTION MANUAL

Thank you for purchasing a Canon product.

The EOS-1D Mark IV is a top-of-the-line, high-performance EOS DIGITAL SLR camera featuring a large, fine-detail CMOS sensor with approx. 16.10 effective megapixels, Dual “DIGIC 4”, high-precision and high-speed 45-point AF (39 cross-type points), approx. 10 fps continuous shooting, Live View shooting, and Full HD (Full High-Definition) movie shooting.

The camera is highly responsive to any shooting situation, provides many features for demanding shoots, highly reliable even in harsh environments, and compatible with a wide range of accessories to expand shooting possibilities.

Take a Few Test Shots to Familiarize Yourself with the Camera

With a digital camera, you can immediately view the image you have captured. While reading this manual, take a few test shots and see how they come out. You can then better understand the camera.

To avoid botched pictures and accidents, first read the Safety Warnings (p.266,267) and Handling Precautions (p.12,13).

Testing the Camera Before Use and Liability

After shooting, playback and check whether the image has been properly recorded. If the camera or memory card is faulty and the images cannot be recorded or downloaded to a computer, Canon cannot be held liable for any loss or inconvenience caused.

Copyrights

Copyright laws in your country may prohibit the use of your recorded images of people and certain subjects for anything but private enjoyment. Also be aware that certain public performances, exhibitions, etc., may prohibit photography even for private enjoyment.

Memory Cards

In this manual, “CF card” refers to CompactFlash cards and “SD card” refers to SD/SDHC cards. “Card” refers to all memory cards used to record images or movies. **The camera does not come with a card for recording images/movies.** Please purchase it separately.

Item Check List

Before starting, check that all the following items have been included with your camera. If anything is missing, contact your dealer.



Camera
(with eyecup, body cap,
and battery
compartment cap)



**Battery Pack
LP-E4**
(with protective cover)

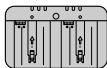

**Battery Charger
LC-E4**



Wide Strap L6



**Interface Cable
IFC-200U**



**Stereo AV Cable
AVC-DC400ST**



Cable Protector
(with attaching
screw, p.26)



**EOS DIGITAL
Solution Disk**
(Software)



**EOS DIGITAL
Software Instruction
Manuals Disk**

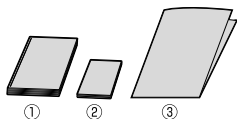







- (1) **Instruction Manual** (this booklet)
- (2) **Pocket Guide**
Quick start guide to shooting.
- (3) **CD-ROM Guide**
Guide to the provided software (EOS DIGITAL Solution Disk) and EOS DIGITAL Software Instruction Manuals Disk.

* Be careful not to lose any of the above items.

Conventions Used in this Manual

Icons in this Manual

-  : Indicates the Main Dial.
-  : Indicates the Quick Control Dial.
-  : Indicates the Multi-controller.
-  : Indicates the setting button.
-  ,  : Indicates that the respective function remains active for 6 sec. or 16 sec. respectively after you let go of the button.

* In this manual, the icons and markings indicating the camera's buttons, dials, and settings correspond to the icons and markings on the camera and on the LCD monitor.

MENU : Indicates a function which can be changed by pressing the <MENU> button and changing the setting.

(p.**): Reference page numbers for more information.



 : Warning to prevent shooting problems.

 : Supplemental information.

 : Tip or advice for better shooting.

 : Problem-solving advice.

Basic Assumptions

- All operations explained in this manual assume that the power switch is already set to <ON> or <J> (p.34).
- < > operations explained in this manual assume that the power switch is already set to <J>.
- It is assumed that all the menu settings and Custom Functions are set to the default.
- It is assumed that a CF card < > or SD/SDHC memory card < > is used.
- For explanatory purposes, the instructions show the camera attached with an EF 50mm f/1.4 USM lens.

Chapters

	Introduction Camera basics.	2
1	Getting Started	27
2	Image Settings Image-recording quality, ISO speed, Picture Style, etc.	55
3	Setting the AF and Drive Modes Setting the AF mode, AF point, and drive mode.	93
4	Exposure Control Metering mode, shooting mode, flash, and other settings.	103
5	Live View shooting Shoot photos while viewing the LCD monitor.	125
6	Shooting Movies Shoot movies while viewing the LCD monitor.	141
7	Image Playback Playing back photos and movies.	155
8	Sensor Cleaning Auto cleaning, appending Dust Delete Data, and other procedures.	183
9	Printing Images Printing with PictBridge and using DPOF for print orders.	189
10	Customizing the Camera Setting Custom Functions (C.Fn), My Menu, etc.	203
11	Reference	241

Contents



Introduction





Item Check List.....	3
Conventions Used in this Manual.....	4
Chapters.....	5
Index to Features.....	10
Handling Precautions.....	12
Quick Start Guide.....	14
Nomenclature.....	16

1 Getting Started 27



Charging the Battery.....	28
Installing and Removing the Battery.....	32
Using a Household Power Outlet (Sold separately).....	33
Turning on the Power.....	34
Installing and Removing the Card.....	36
Attaching and Detaching a Lens.....	39
Basic Operation.....	40
Menu Operations.....	44
Menu Settings.....	46
Before You Start.....	49
Setting the Interface Language.....	49
Setting the Date and Time.....	49
Formatting the Card.....	50
Set the Power-off Time/Auto Power Off.....	52
Silencing the Beeper.....	52
Card Reminder.....	52
Reverting the Camera to the Default Settings.....	53

2 Image Settings 55







Selecting the Card to Record or Playback.....	56
Recording Method with Two Cards Inserted.....	57
Setting the Image-recording Quality.....	59
Selecting the Image Size.....	59
Setting the JPEG Quality (Compression Rate).....	63
ISO: Setting the ISO Speed.....	64
 Selecting a Picture Style.....	66
 Customizing a Picture Style.....	68

 Registering a Picture Style.....	70
Setting the White Balance.....	72
 Custom White Balance.....	73
 Setting the Color Temperature.....	78
 White Balance Correction.....	79
White Balance Auto Bracketing.....	80
Auto Lighting Optimizer.....	81
Lens Peripheral Illumination Correction.....	82
Creating and Selecting a Folder.....	84
Changing the File Name.....	86
File Numbering Methods.....	88
Setting Copyright Information.....	90
Setting the Color Space.....	92

3 Setting the AF and Drive Modes 93

AF: Selecting the AF Mode.....	94
 Selecting the AF Point.....	97
When Autofocus Fails.....	100
MF: Manual Focusing.....	100
DRIVE: Selecting the Drive Mode.....	101
 Using the Self-timer.....	102

4 Exposure Control 103

 Selecting the Metering Mode.....	104
P : Program AE.....	106
Tv : Shutter-Priority AE.....	108
Av : Aperture-Priority AE.....	110
Depth-of-Field Preview.....	111
M : Manual Exposure.....	112
 Exposure Compensation.....	113
 Auto Exposure Bracketing (AEB).....	114
 AE Lock.....	115
Bulb Exposures.....	116
 Mirror Lockup.....	118
 Flash Photography.....	119
Setting the Flash.....	121

5	Live View Shooting	125
	Preparing for Live View Shooting	126
	Live View Shooting	127
	Shooting Function Settings	129
	Menu Function Settings.....	130
	Using AF to Focus	131
	Focusing Manually.....	138
6	Shooting Movies	141
	Preparing to Shoot Movies	142
	Shooting Movies.....	143
	Autoexposure Shooting	143
	Manual Exposure Shooting	144
	Shooting Function Settings	150
	Menu Function Settings.....	151
7	Image Playback	155
	Image Playback.....	156
	INFO. Shooting Information Display	157
	Searching for Images Quickly	159
	Display Multiple Images on One Screen (Index display).....	159
	Jump through Images (Jump display).....	160
	Magnified View	161
	Rotating the Image	162
	Enjoying Movies	163
	Playing Movies	165
	Editing the Movie's First and Last Scenes	167
	Slide Show (Auto Playback)	168
	Viewing the Images on TV.....	170
	Protecting Images.....	172
	Recording and Playing Voice Memos	174
	Copying Images	176
	Erasing Images.....	179
	Changing Image Playback Settings.....	180
	Adjusting the LCD Monitor Brightness	180
	Setting the Image Review Time	181
	Auto Rotation of Vertical Images	182

8	Sensor Cleaning	183
	Automatic Sensor Cleaning	184
	Appending Dust Delete Data	185
	Manual Sensor Cleaning	187
9	Printing Images	189
	Preparing to Print	190
	Printing	192
	Trimming the Image	197
	Digital Print Order Format (DPOF)	199
	Direct Printing with DPOF	202
10	Customizing the Camera	203
	Setting Custom Functions	204
	Custom Functions	205
	Custom Function Settings	208
	C.Fn I: Exposure	208
	C.Fn II: Image/Flash exposure/Display	214
	C.Fn III: Autofocus/Drive	218
	C.Fn IV: Operation/Others	227
	Registering and Applying Custom Function Settings	235
	Registering My Menu	237
	Saving and Loading Camera Settings	238
	Registering and Applying Basic Camera Settings	240
11	Reference	241
	Function Availability Table	242
	System Map	244
	INFO. Checking Camera Settings	246
	Checking the Battery Information	247
	Replacing the Date/Time Battery	248
	Troubleshooting Guide	249
	Error Codes	256
	Specifications	257
	Safety Warnings	266
	Index	269

Index to Features

Power

- **Battery**
 - Charging → p.28
 - Calibration → p.30
 - Battery check → p.35
 - Battery information → p.247
- **Power outlet** → p.33
- **Auto power off** → p.52

Lens

- **Attaching/Detaching** → p.39

Basic Settings (Menu Functions)

- **Menus** → p.46
- **Language** → p.49
- **Date/Time** → p.49
- **LCD brightness adjustment** → p.180
- **Beeper** → p.52
- **Release shutter without card** → p.52
- **Clear camera settings** → p.53

Recording Images

- **Format** → p.50
- **Select card** → p.56
- **Recording to a card** → p.57
- **Create/select a folder** → p.84
- **File name** → p.86
- **File No.** → p.88

Image Quality

- **Image size** → p.59
- **JPEG (Compression rate)** → p.63
- **ISO speed** → p.64
 - ISO speed expansion → p.208
- **Picture Style** → p.66
- **Color space** → p.92

Image improvement features

- **Auto Lighting Optimizer** → p.81
- **Lens peripheral illumination correction** → p.82
- **Noise reduction for long exposures** → p.214
- **Noise reduction for high ISO speeds** → p.214
- **Highlight tone priority** → p.215

White balance

- **White balance setting** → p.72
- **Custom WB** → p.73
- **Color temperature setting** → p.78
- **White balance correction** → p.79
- **WB bracketing** → p.80

Viewfinder

- **Dioptic adjustment** → p.40
- **Eyepiece shutter** → p.117
- **Changing the focusing screen** → p.232

AF

- **AF mode** → p.94
- **AF point selection** → p.97
- **AF Custom Functions**
 - **Number of AF points** → p.223
 - **AF point expansion** → p.222
 - **AI Servo tracking sensitivity** → p.218
 - **AI Servo AF tracking method** → p.219
 - **AF Servo operation** → p.218
 - **Vertical/Horizontal AF point** → p.226
 - **AF fine adjustment** → p.221
- **Manual focusing** → p.100

Metering

- **Metering mode** → p.104
- **Multi-spot metering** → p.105

Drive

- Drive modes → p.101
- Maximum burst → p.62
- Self-timer → p.102

Shooting

- Program AE → p.106
- Shutter-priority AE → p.108
- Aperture-priority AE → p.110
- Manual exposure → p.112
- Bulb → p.116
- Mirror lockup → p.118
- Depth-of-field preview → p.111

Exposure adjustment

- Exposure compensation → p.113
- AEB → p.114
- AE lock → p.115
- Safety shift → p.210

Flash

- External flash → p.119
- Flash control → p.121
- Flash Custom Functions → p.124

Live View shooting

- Still photo shooting → p.126
 - AF → p.131
 - Manual focusing → p.138
 - Exposure simulation → p.130
 - Grid display → p.130

Movie shooting

- Movie shooting → p.142
 - Autoexposure shooting → p.143
 - Manual exposure shooting → p.144
 - Recording size → p.151

Image playback

- Image review time → p.181
- Single image display → p.156
- Index display → p.159
- Image browsing (Jump display) → p.160
- Magnified view → p.161
- Image rotate → p.162
- Slide show → p.168
- Movie playback → p.165
- Editing out movie first/last scene → p.167
- Viewing the images on TV → p.170
- Protect → p.172
- Voice memo → p.174
- Copying images → p.176
- Erase → p.179

Printing

- PictBridge → p.190
- Print Order (DPOF) → p.199

Customization

- Custom Functions (C.Fn) → p.204
- Custom Function setting registration → p.235
- My Menu → p.237
- Saving camera settings → p.238
- Registering basic camera settings → p.240

Sensor cleaning

- Sensor cleaning → p.184
- Append Dust Delete Data → p.185

Handling Precautions

Camera Care

- This camera is a precision instrument. Do not drop it or subject it to physical shock.
- The camera is not waterproof and cannot be used underwater. If you accidentally drop the camera into water, promptly consult your nearest Canon Service Center. Wipe off any water droplets with a dry cloth. If the camera has been exposed to salty air, wipe it with a well-wrung wet cloth.
- Never leave the camera near anything having a strong magnetic field such as a magnet or electric motor. Also avoid using or leaving the camera near anything emitting strong radio waves such as a large antenna. Strong magnetic fields can cause camera misoperation or destroy image data.
- Do not leave the camera in excessive heat such as in a car in direct sunlight. High temperatures can cause the camera to malfunction.
- The camera contains precision electronic circuitry. Never attempt to disassemble the camera yourself.
- Use a blower to blow away dust on the lens, viewfinder, reflex mirror, and focusing screen. Do not use cleaners that contain organic solvents to clean the camera body or lens. For stubborn dirt, take the camera to the nearest Canon Service Center.
- Do not touch the camera's electrical contacts with your fingers. This is to prevent the contacts from corroding. Corroded contacts can cause camera misoperation.
- If the camera is suddenly brought in from the cold into a warm room, condensation may form on the camera and internal parts. To prevent condensation, first put the camera in a sealed plastic bag and let it adjust to the warmer temperature before taking it out of the bag.
- If condensation forms on the camera, do not use the camera. This is to avoid damaging the camera. If there is condensation, remove the lens, card and battery from the camera, and wait until the condensation has evaporated before using the camera.
- If the camera will not be used for an extended period, remove the battery and store the camera in a cool, dry, well-ventilated location. Even while the camera is in storage, press the shutter button a few times once in a while to check that the camera is still working.
- Avoid storing the camera where there are corrosive chemicals such as a darkroom or chemical lab.
- If the camera has not been used for an extended period, test all its functions before using it. If you have not used the camera for some time or if there is an important shoot coming up, have the camera checked by your Canon dealer or check the camera yourself and make sure it is working properly.

LCD Panel and LCD Monitor

- Although the LCD monitor is manufactured with very high precision technology with over 99.99% effective pixels, there might be a few dead pixels among the remaining 0.01% or less pixels. Dead pixels displaying only black or red, etc., are not a malfunction. They do not affect the images recorded.
- If the LCD monitor is left on for a prolonged period, screen burn-in may occur where you see remnants of what was displayed. However, this is only temporary and will disappear when the camera is left unused for a few days.
- In low or high temperatures, the LCD monitor display may seem slow or it might look black. It will return to normal at room temperature.

Cards

To protect the card and its recorded data, note the following:

- Do not drop, bend, or wet the card. Do not subject it to excessive force, physical shock, or vibration.
- Do not store or use the card near anything having a strong magnetic field such as a TV set, speakers, or magnet. Also avoid places prone to having static electricity.
- Do not leave the card in direct sunlight or near a heat source.
- Store the card in a case.
- Do not store the card in hot, dusty, or humid locations.

Lens

After detaching the lens from the camera, attach the lens caps or put down the lens with the rear end up to avoid scratching the lens surface and electrical contacts.

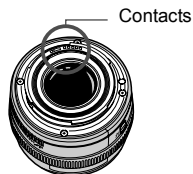

Cautions During Prolonged Use

If you use continuous shooting, Live View shooting, or movie shooting for a prolonged period, the camera may become hot. Although this is not a malfunction, holding the hot camera for a long period can cause slight skin burns.

Quick Start Guide

1

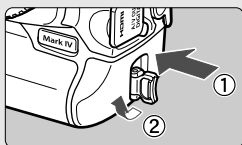

Install the battery. (p.32)

Take off the cap and insert a fully-charged battery. To charge the battery, see page 28.

2



Attach the lens. (p.39)

Align it with the red dot.

3

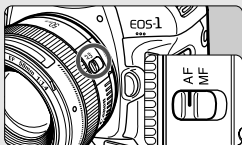

Set the lens focus mode switch to <AF>. (p.39)

4

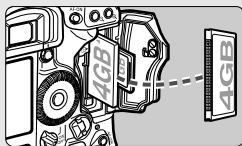

Insert the card. (p.36)

The left slot is for a CF card, and the right slot is for an SD card.

5

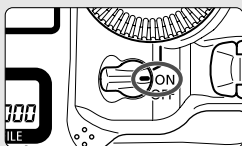

Set the power switch to <ON>. (p.34)

6

Clear all camera settings



Set the camera to the default settings. (p.53)

On the menu screen under the [F:] tab, select [Clear all camera settings].

- Press the <MENU> button and turn the <G> or <D> dial to select it, then press <SET>.
- The <P> Program AE mode will take effect.

7



Focus the subject. (p.41)

Aim the Area AF frame over the subject. Press the shutter button halfway, and the camera will focus the subject.

8

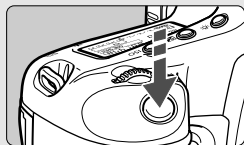

Take the picture. (p.41)

Press the shutter button completely to take the picture.

9



View the image. (p.181)

The captured image will be displayed for approx. 2 sec. on the LCD monitor. To display the image again, press the <▶> button (p.156).

- Shooting will be possible with either a CF card or SD card in the camera.
- To view the images captured so far, see “Image Playback” (p.156).
- To delete an image, see “Erasing Images” (p.179).

Nomenclature

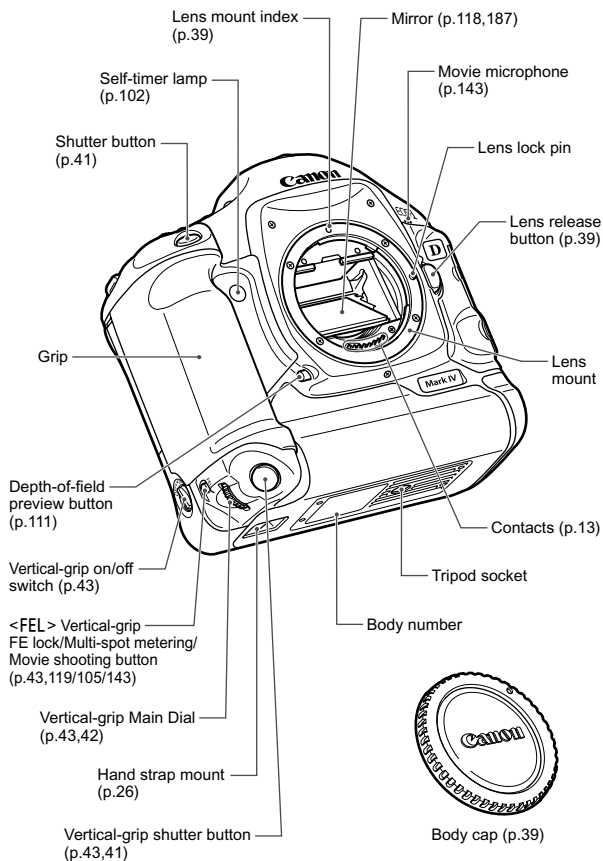

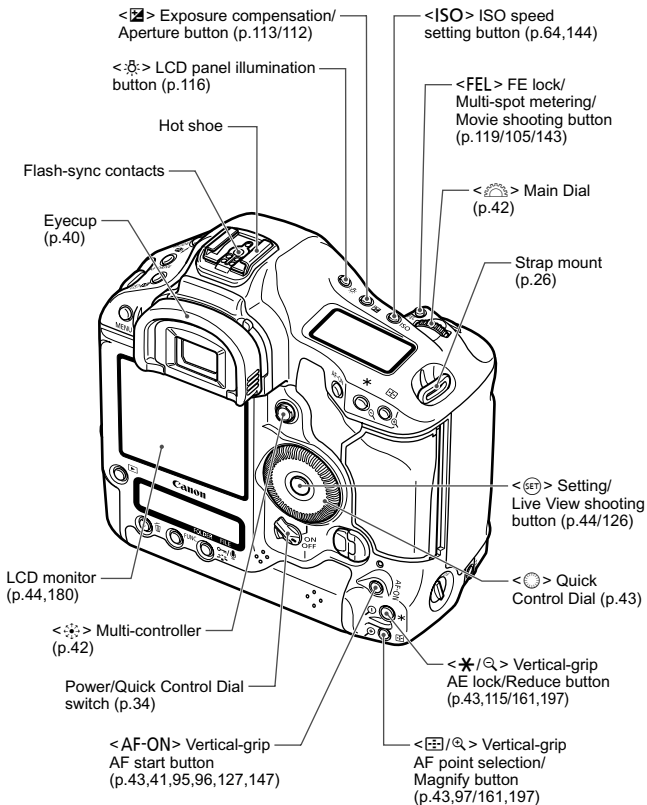

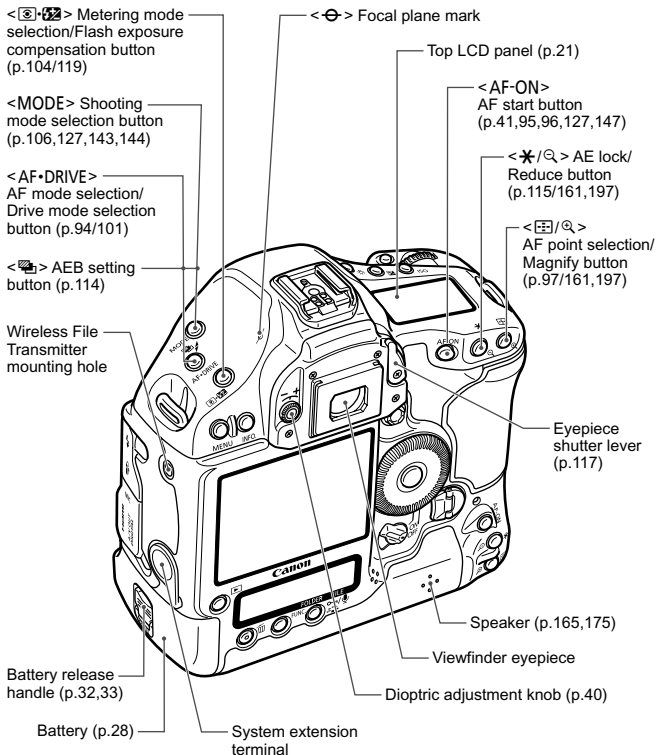

If you use Wireless File Transmitter WFT-E2 connected to the system extension terminal, update the WFT-E2's firmware to Version 2.0.0 or higher.

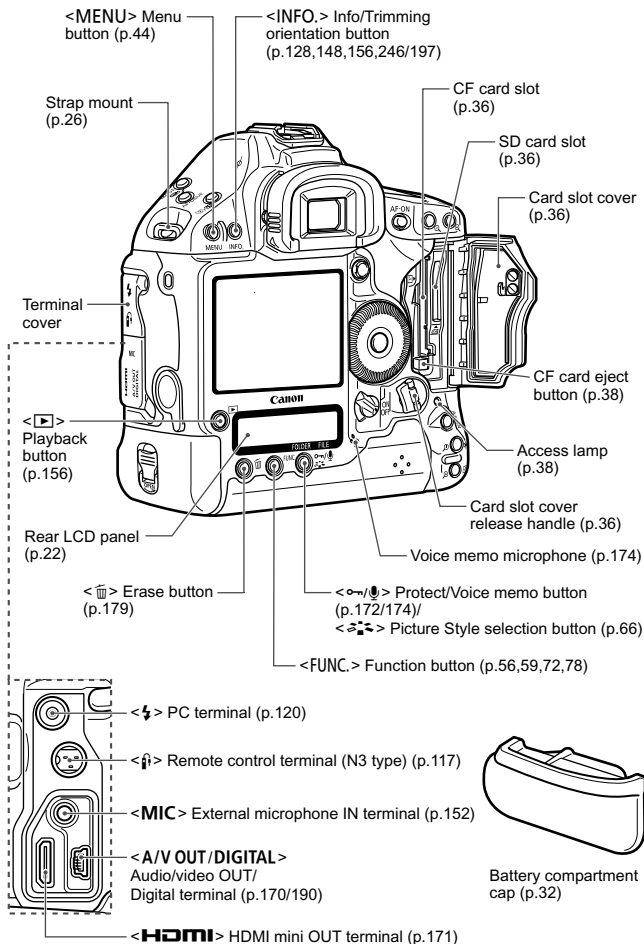

Viewfinder Information

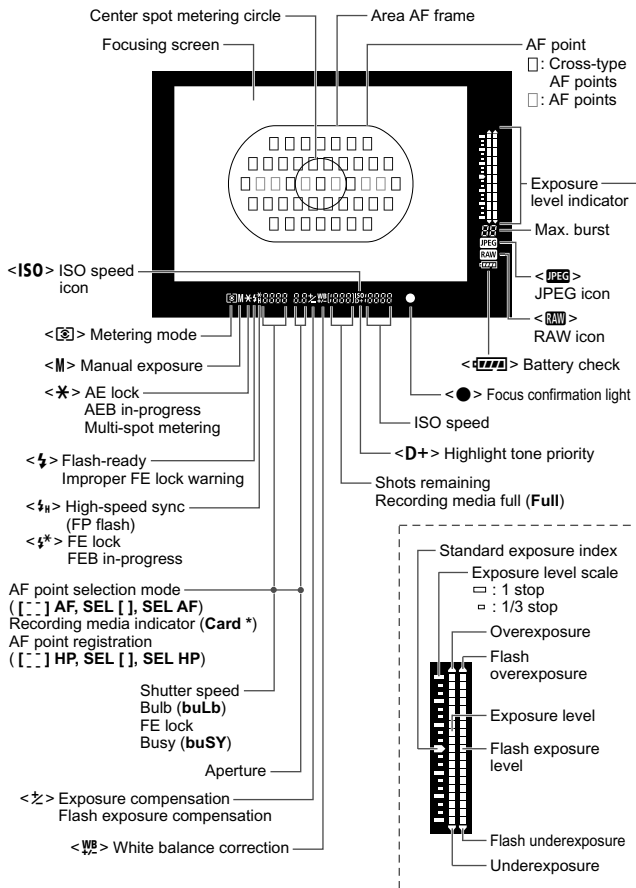

The display will show only the settings currently applied.

Top LCD Panel

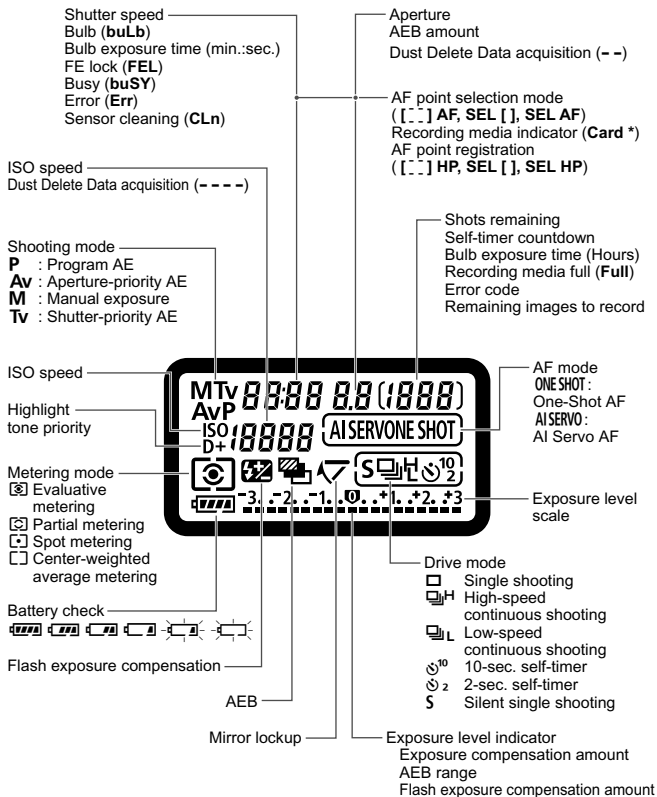

The display will show only the settings currently applied.

Rear LCD Panel

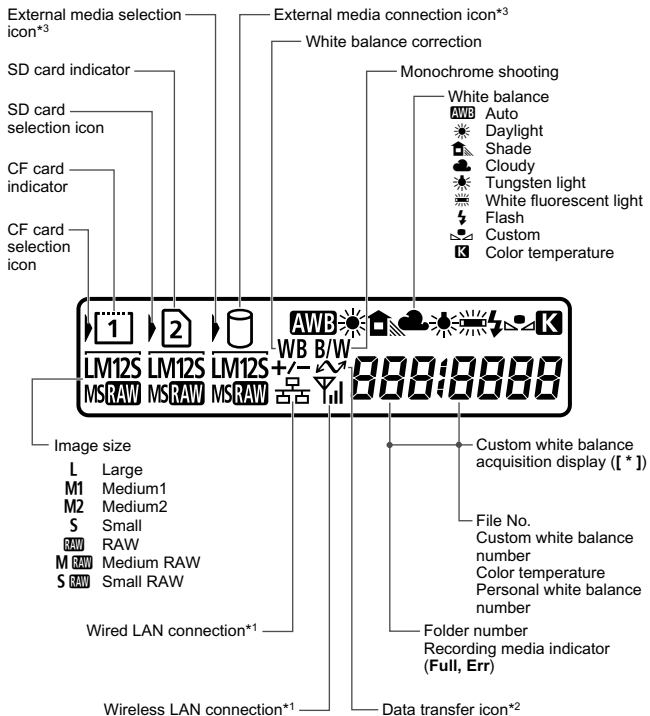

*1: Displayed when Wireless File Transmitter WFT-E2 II or WFT-E2 is used.

*2: Displayed when the camera is connected to a personal computer.

*3: Displayed when the WFT-E2 II or WFT-E2 and external media are used.

The display will show only the settings currently applied.

Shooting Settings Display

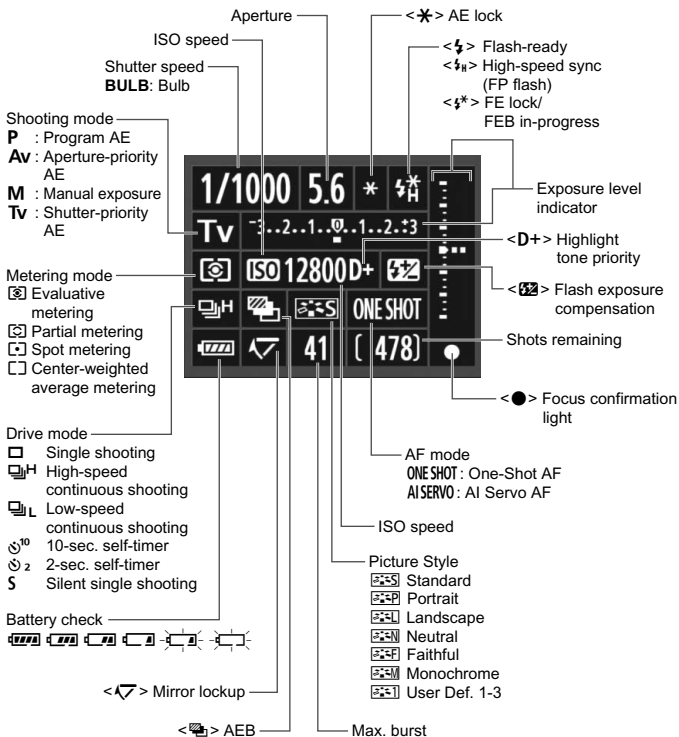

The display will show only the settings currently applied.



- By default, when the power is turned on, pressing the **<INFO.>** button while nothing is displayed on the LCD monitor will display the shooting settings screen. To turn off the display, press the button again.
- Regarding the shooting settings display, see **[C.Fn II -10: INFO. button when shooting]** on page 217.

Battery Pack LP-E4

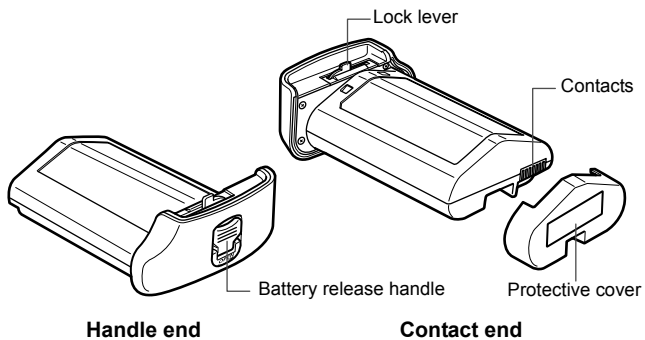

Battery Charger LC-E4

Charger for Battery Pack LP-E4 (p.28).

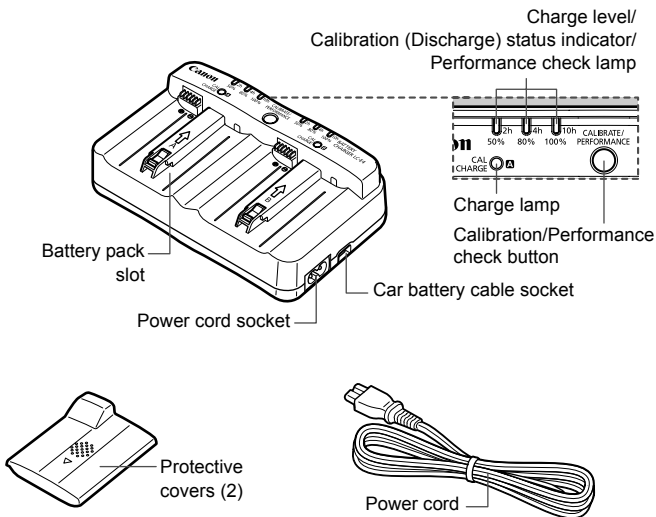

Attaching the Neck Strap and Hand Strap

Using the Cable Protector

Strap

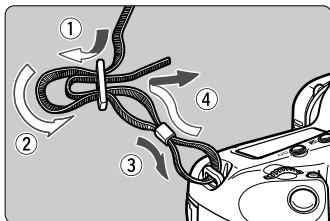

Cable Protector

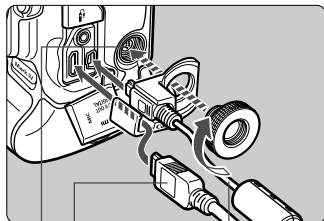

Interface cable

HDMI cable (Sold separately)

System extension terminal

Hand strap (Sold separately)

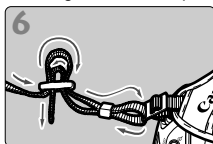
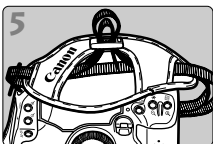
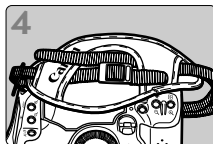
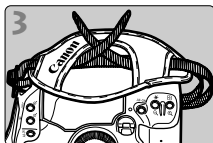
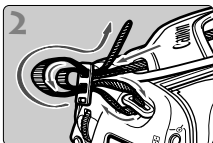
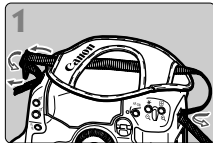

Attaching the Neck Strap

! After attaching the strap, pull it at the buckle to take up the slack and to make sure it does not loosen.

1

Getting Started

This chapter explains preliminary steps and basic camera operations.

Minimizing Dust

- When changing lenses, do it quickly in a place with minimal dust.
- When storing the camera without a lens attached, be sure to attach the body cap to the camera.
- Remove dust on the body cap before attaching it.

Charging the Battery

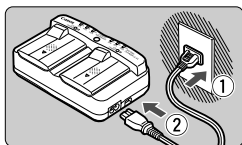

1 Connect the charger to a power outlet.

- Connect the power plug to a power outlet, and connect the power cord to the charger.
- When no battery is attached, all the indicator lamps will be off.

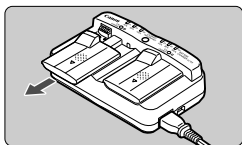

2 Remove the protective covers from the charger and battery.

- Remove the protective cover on the charger by sliding it out.

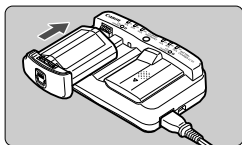
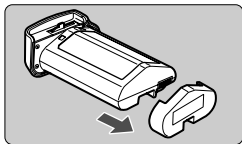

3 Recharge the battery.

- Slide the battery into the charger's slot as shown by the arrow, and make sure it is securely attached.
- You can attach the battery to slot A or B.
 - ▶ The battery will start recharging and the green status lamp will blink.
 - ▶ When the battery is fully charged, all three Charge level indicators will light (50%/80%/100%).
- It takes approx. 2 hours to fully recharge a completely exhausted battery.
- The time required to recharge the battery depends on the ambient temperature and battery's charge level.

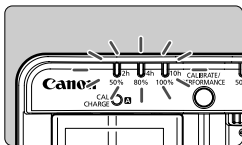



Tips for Using the Battery and Charger

- **Recharge the battery on the day before or on the day it is to be used.**
Even during storage, a charged battery will gradually discharge and lose its power.

- **After recharging the battery, detach it and unplug the power cord from the power outlet.**

When not using the battery and charger, attach the protective covers.

- **Use the battery in an ambient temperature range of 0°C - 45°C / 32°F - 113°F.**

To attain best battery performance, an ambient temperature of 10°C - 30°C / 50°F - 86°F is recommended. In cold locations such as snowy areas, battery performance and operation time may temporarily decrease.

- **When not using the camera, remove the battery.**

If the battery is left in the camera for a prolonged period, a small amount of power current is released, resulting in excess discharge and shorter battery life. Take out the battery from the camera and attach the protective cover before storing. Storing the battery after it is fully charged can lower the battery's performance.

- **The battery charger can also be used in foreign countries.**

The battery charger is compatible with a 100 V AC to 240 V AC 50/60 Hz power source. If necessary, attach a commercially-available plug adapter for the respective country or region. Do not attach any portable voltage transformer to the battery charger. Doing so can damage the battery charger.

- **Check the battery performance.**

While the battery is recharging, press the **<PERFORMANCE>** button to check the battery's performance level indicated by the Charge level indicator.

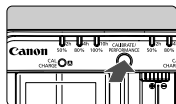

■■■■ (Green) : Battery performance is fine.

■■■□ (Green) : Battery's recharge performance is slightly degraded.

■■□□ (Red) : Purchasing a new battery is recommended.

- **If the battery becomes exhausted quickly even after being fully charged, the battery has reached the end of its service life.**

Check the battery's recharge performance (p.247) and purchase a new battery.



Use the Car's Cigarette Lighter Socket to Recharge the Battery

With Car Battery Cable CB-570 (sold separately), you can connect the charger's car battery cable socket (<DC IN> terminal) to your car's cigarette lighter socket.

- When recharging the battery this way, be sure that the car's engine is running. If the car engine is off, disconnect the car battery cable from the cigarette lighter socket. If you leave the car battery cable connected to the cigarette lighter socket, it may drain the car battery.
- Do not use a transformer for the car with the battery charger.
- Battery charging from a car battery is possible only with a 12 V DC or 24 V DC car battery in a minus-grounded car. The shape or dimensions of the cigarette lighter socket in certain cars might not be compatible with the car battery cable.



The <CAL/CHARGE> Lamp Blinks in Red

- This indicates that you should calibrate the battery so that the correct battery level is detected and the camera's battery level indicator can display the correct battery level. Calibration is not a required operation. If you want to just recharge the battery, you can let the battery start recharging automatically after approx. 10 sec. If you want to do the calibration, press the <CALIBRATE> button while the <CAL/CHARGE> lamp is blinking in red. The Charge level indicator will blink in red and the calibration (power discharge) will start.
- After the calibration is completed, the battery will start recharging automatically. Note that the less depleted the battery, the longer the calibration will take. The <2h>, <4h>, and <10h> figures on the side of the Charge level indicator respectively indicate the approximate number of hours it will take to complete the calibration (power discharge). If the <10h> indicator blinks in red, it will take approx. 10 hours.
- After the calibration is completed and the battery is totally drained, it will take a further 2 hours to recharge the battery fully. If you want to stop the calibration before it is completed and start recharging the battery, remove the battery from the charger and attach it again.

All Three Charge Level Indicators Blink

- If all three Charge level indicators blink in green, it means that the battery's internal temperature is not within 0°C - 40°C / 32°F - 104°F. The battery will start recharging when the internal temperature is within 0°C - 40°C / 32°F - 104°F.
- If all the Calibration (discharge) status indicators blink in red or if all the lamps blink in red and green (including the <CAL/CHARGE> lamp), remove the battery from the charger and take it to your dealer or to nearest Canon Service Center.
- Also, if a battery other than Battery Pack LP-E4 is attached to the charger, the lamps will blink in red and green (including the <CAL/CHARGE> lamp) and the battery cannot be recharged.



- The charger cannot charge any battery other than Battery Pack LP-E4.
- Battery Pack LP-E4 is dedicated to Canon products only. Using it with a non-Canon battery charger or product may result in malfunction or accidents for which Canon cannot be held liable.



- When two battery packs are attached to the charger, the battery attached first will be charged first, then the other battery will be charged. Although one battery can be recharged and another calibrated at the same time, two batteries cannot be recharged or calibrated at the same time.
- For battery calibration, it is best to do it after the battery is nearly exhausted. If you do the calibration with a fully charged battery, it will take approx. 12 hours to complete the calibration and the battery recharging (approx. 10 hours to discharge, and approx. 2 hours to fully recharge).

Installing and Removing the Battery

Installing the Battery

Insert a fully charged Battery Pack LP-E4 into the camera.

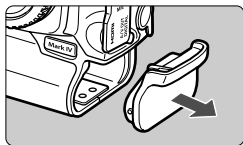

- 1 Remove the battery compartment cap.**

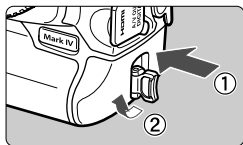

- 2 Insert the battery.**

- Insert the battery firmly all the way, and turn the release handle as shown by the arrow.

Removing the Battery

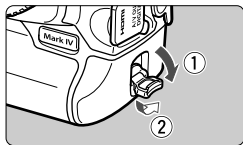

- 1 Flip out the battery release handle and turn it as shown by the arrow.**

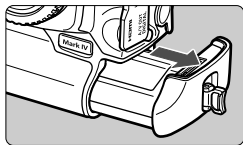

- 2 Pull out the battery.**

- To prevent shorting, be sure to attach the protective cover (p.24) to the battery.
- When not using the camera, attach the battery compartment cap (p.19).

 If the battery's rubber lining (to repel water) is not clean, use a moist cotton swab to wipe it clean.

Rubber lining



Using a Household Power Outlet (Sold separately) ■

With AC Adapter Kit ACK-E4 (sold separately), you can connect the camera to a household power outlet and not worry about the battery level.

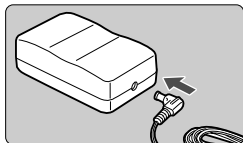

1 Connect the DC Coupler's plug.

- Connect the DC Coupler's plug to the AC adapter's DC terminal.

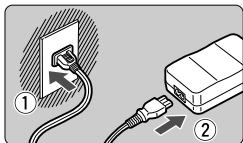

2 Connect the power cord.

- Connect the power plug to the power outlet, then connect the power cord to the AC adapter.

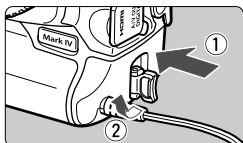

3 Insert the DC Coupler.

- Insert the DC Coupler firmly all the way, and turn the release handle as shown by the arrow.
- After using the camera, unplug the power plug from the power outlet.



- The DC Coupler is not water-resistant, so do not get it wet when using it outdoors.
- Do not connect or disconnect the power cord or DC Coupler while the camera's power switch is set to <ON> or <J>.

Turning on the Power

Power/Quick Control Dial Switch

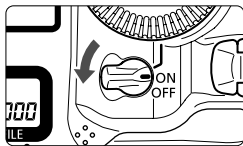

<OFF> : The camera is turned off and does not operate. Set to this position when not using the camera.

<ON> : The camera turns on.

<J> : The camera and <☉> operate (p.43).

About the Automatic Self-Cleaning Sensor

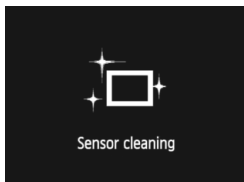

- Whenever you set the power switch to <ON/J> or <OFF>, the sensor cleaning will be executed automatically. During the sensor cleaning, the LCD monitor will display <☐>.
- Even during the sensor cleaning, you can still shoot by pressing the shutter button halfway (p.41) to stop the sensor cleaning and take a picture.
- If you turn on/off the power switch <ON/J>/<OFF> at a short interval, the <☐> icon might not be displayed. This is normal and not a problem.

About Auto Power Off

- To save battery power, the camera turns off automatically after approx. 1 minute of non-operation. To turn on the camera again, just press the shutter button halfway (p.41).
- You can change the auto power-off time with the menu's [**Auto power off**] setting (p.52).

 If you set the power switch to <OFF> while an image is being recorded to the card, [**Recording ...**] will be displayed and the power will turn off after the card finishes recording the image.

Checking the Battery Level

When the power switch is set to <ON>, the battery level will be indicated in one of six levels:



Icon	Level (%)	Indication
	100 - 70	Sufficient battery level
	69 - 50	Battery level exceeds 50%
	49 - 20	Battery level below 50%
	19 - 10	Battery level is low
	9 - 1	Battery will be exhausted soon
	0	Recharge the battery

Battery Life

Temperature	At 23°C / 73°F	At 0°C / 32°F
Possible shots	Approx. 1500	Approx. 1200

- The figures above are based on a fully-charged Battery Pack LP-E4, no Live View shooting, and CIPA (Camera & Imaging Products Association) testing standards.



- The number of possible shots will decrease with any of the following operations:
 - Pressing the shutter button halfway for a prolonged period.
 - Often activating only the AF without taking a picture.
 - Using the LCD monitor often.
 - Using the lens Image Stabilizer.
- The actual number of shots may be fewer than indicated above depending on the shooting conditions.
- The lens operation is powered by the camera's battery. Depending on the lens used, the number of possible shots may be lower.
- For battery life with Live View shooting, see page 129.
- See the [Battery info.] menu to further check the battery's condition (p.247).

Installing and Removing the Card

The camera can use a CF card and SD card. **Images can be recorded when at least one card is installed in the camera.**

If both card slots have a card, you can select which card to record images with or record the same images simultaneously on both cards (p.56, 57).

ⓘ If you use an SD card, be sure the card's write protect switch is set upward to enable writing/erasing.

Installing the Card

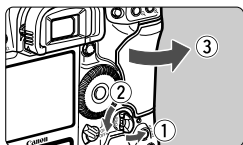

1 Open the cover.

- Flip out and turn the cover release handle as shown by the arrow.

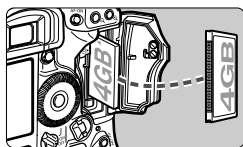

2 Insert the card.

- The left slot is for a CF card, and the right slot is for an SD card.
- **As shown in the illustration, face the CF card's label side toward you and insert the end with the small holes into the camera.**

If the card is inserted in the wrong way, it may damage the camera.

- ▶ The CF card eject button will stick out.
- With the SD card's label facing you, push in the card until it clicks in place.

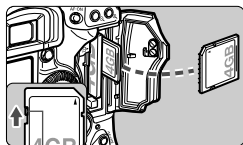

Write protect switch

3 Close the cover.

- Press the cover until it snaps shut.

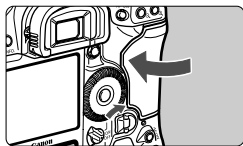

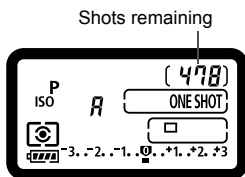

4 Set the power switch to <ON>.

- ▶ The number of remaining shots will be displayed on the top LCD panel and in the viewfinder.
- ▶ The rear LCD panel will indicate which card(s) has been installed. **The images will be recorded to the card with the <▶> arrow next to the respective card's indicator.**

Card selection icon

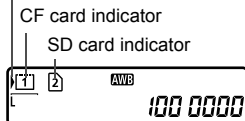

- SDHC memory cards can be used with the camera.
- Although the thickness is different between the two types of CF (CompactFlash) cards, either one can be inserted into the camera.
- Ultra DMA (UDMA) CF cards and hard disk-type cards can also be used with the camera. UDMA CF cards enable faster data writing.
- The number of possible shots varies depending on the card's capacity, image-recording quality, ISO speed, etc.
- Setting the [] **Release shutter without card**] menu option to [**Disable**] will prevent you from forgetting to install a card (p.52).



Removing the Card

1 Open the cover.

- Set the power switch to <OFF>.
- **Make sure the access lamp is off, then open the cover.**

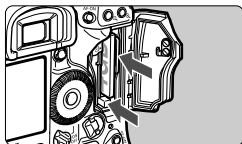

2 Remove the card.

- To remove the CF card, push the eject button.
- To remove the SD card, push it in gently and release it. Then pull it out.
- Close the cover.

- **The access lamp lights or blinks while data is being transferred to the card and when data is being recorded, read, or erased on the card. While the access lamp is lit or blinking, never do any of the following. Doing so may damage the image data. It may also damage the card or camera.**
 - Opening the card slot cover.
 - Removing the battery.
 - Shaking or banging the camera around.
- If the card already contains recorded images, the image number might not start from 0001 (p.88).
- If a card-related error message is displayed on the LCD monitor, remove and reinstall the card. If the error persists, use a different card. If you can transfer all the images in the card to a computer, transfer all the images and then format the card with the camera (p.50). The card may then return to normal.
- When holding a hard disk-type card, always hold its sides. You may damage the card by holding its flat surfaces. Hard disk-type cards are more vulnerable to vibration and physical shock. If you use such a card, be careful not to subject the camera to vibration or physical shock especially while recording or displaying images.
- Do not touch the SD card's contacts with your fingers or metal objects.

 Even with the power switch set to <OFF>, when you insert or remove a card, the access lamp might blink.

Attaching and Detaching a Lens

Attaching a Lens

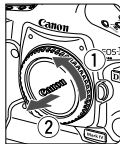

1 Remove the caps.

- Remove the rear lens cap and the body cap by turning them as shown by the arrow.

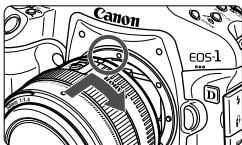

2 Attach the lens.

- Align the red dots on the lens and camera and turn the lens as shown by the arrow until it clicks in place.

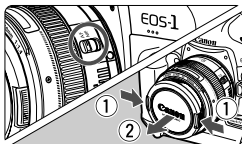

3 On the lens, set the focus mode switch to **<AF>** (autofocus).

- If it is set to **<MF>** (manual focus), autofocus will not operate.

4 Remove the front lens cap.

Detaching the Lens

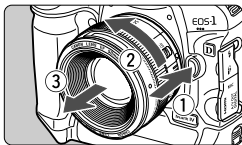

While pressing the lens release button, turn the lens as shown by the arrow.

- Turn the lens until it stops, then detach it.
- Attach the rear lens cap to the detached lens.



- Do not look at the sun directly through any lens. Doing so may cause loss of vision.
- The camera cannot be used with EF-S lenses.

Basic Operation

Adjusting the Viewfinder Clarity

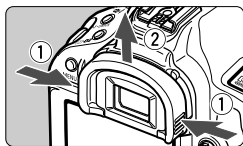

1 Remove the eyecup.

- While grasping both sides of the eyecup, slide it upward to remove.

2 Make the adjustment.

- Turn the knob to the right or left until the AF points or the center spot metering circle (p.20) looks sharp in the viewfinder.
- Attach the eyecup.

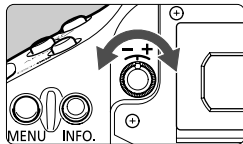

If the camera's dioptic adjustment still cannot provide a sharp viewfinder image, using Dioptic Adjustment Lens Eg (sold separately) is recommended.

Holding the Camera

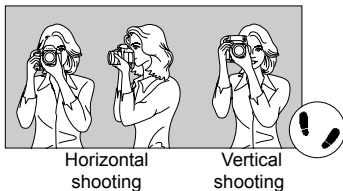

To obtain sharp images, hold the camera still to minimize camera shake.

1. Wrap your right hand around the camera grip firmly.
2. Hold the lens bottom with your left hand.
3. Press the shutter button lightly with your right hand's index finger.
4. Press your arms and elbows lightly against the front of your body.
5. Press the camera against your face and look through the viewfinder.
6. To maintain a stable stance, place one foot in front of the other.

For shooting while looking at the LCD monitor, see page 125.

Shutter Button

The shutter button has two steps. You can press the shutter button halfway. Then you can further press the shutter button completely.

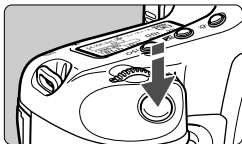

Pressing halfway

This activates autofocus and automatic exposure metering that sets the shutter speed and aperture. The exposure setting (shutter speed and aperture) is displayed on the top LCD panel and in the viewfinder (ⓘ6).

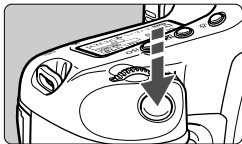

Pressing completely

This releases the shutter and takes the picture.

Preventing Camera Shake

Camera movement during the moment of exposure is called camera shake. Camera shake can cause blurred pictures. To prevent camera shake, note the following:

- Hold and steady the camera as shown on the previous page.
- Press the shutter button halfway to autofocus, then press the shutter button completely.





- Pressing the <AF-ON> button will be the same as pressing the shutter button halfway.
- If you press the shutter button completely without pressing it halfway first or if you press the shutter button halfway and then press it completely immediately, the camera will take a moment before it takes the picture.
- Even during the menu display, image playback, and image recording, you can instantly go back to shooting-ready by pressing the shutter button halfway.

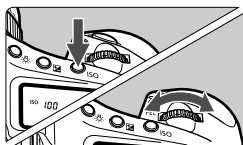

Making Selections with the Main Dial



(1) After pressing a button, turn the < > dial.

When you press a button, its function remains selected for 6 seconds (). During this time, you can turn the <  > dial to set the desired setting. When the function selection turns off or if you press the shutter button halfway, the camera will be ready to shoot.

- Use the dial to select or set the shooting mode, AF mode, metering mode, AF point, ISO speed, Picture Style, exposure compensation when the <  > button is pressed, card, etc.



(2) Turn the < > dial only.

While looking at the viewfinder or top LCD panel, turn the <  > dial to set the desired setting.

- Use this dial to set the shutter speed, aperture, etc.



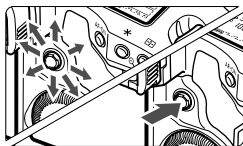

Operating the Multi-controller



The <  > consists of an eight-direction key and a button at the center.

- Use it to select the AF point, correct the white balance, move the AF frame or the magnifying frame during Live View shooting, or scroll over the image during magnified view.



You can use <  > to set menu options (except [ Erase images] and [ Format]) (p.45).

Making Selections with the Quick Control Dial

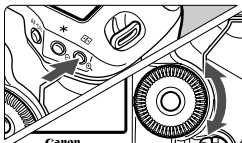
Before using the , set the power switch to **<J>**.



(1) After pressing a button, turn the dial.

When you press a button, its function remains selected for 6 seconds () . During this time, you can turn the  dial to set the desired setting. When the function selection turns off or if you press the shutter button halfway, the camera will be ready to shoot.

- Use the dial to select or set the shooting mode, drive mode, flash exposure compensation, AF point, ISO speed, Picture Style, exposure compensation when the  button is pressed, image size, white balance, etc.

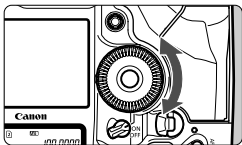

(2) Turn the dial only.

While looking at the viewfinder or top LCD panel, turn the  dial to set the desired setting.

- Use this dial to set the exposure compensation amount, aperture setting for manual exposures, selecting an AF point, etc.



You can do step (1) even when the power switch is set to **<ON>**.

Vertical Shooting

The camera bottom has vertical-grip buttons and a dial (p.16, 17).

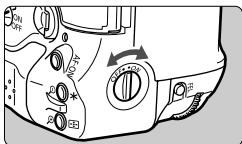

- Before using the vertical grip's buttons and dial, set the vertical-grip ON/OFF switch to **<ON>**.
- When not using the vertical shooting controls, set the switch to **<OFF>** to prevent accidental operation.

Menu Operations

You can set various settings with the menus such as the beeper, date/time, etc. While looking at the LCD monitor, use the <MENU> button on the camera back and the <MAIN DIAL> <Q.C.DIAL> dials.

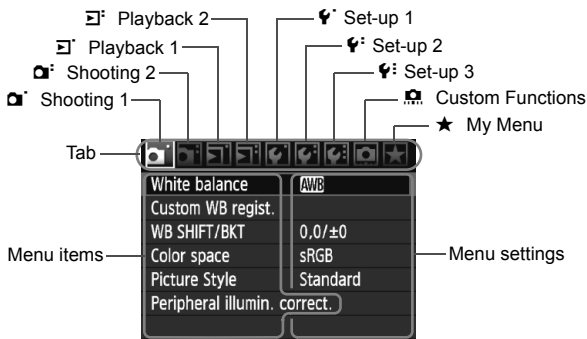
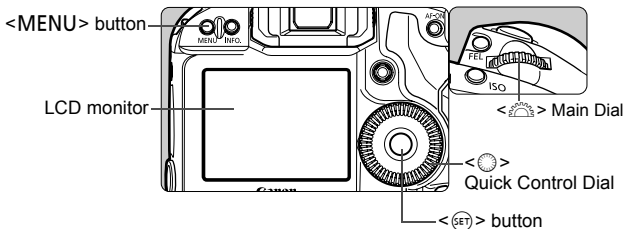

Icon	Color	Category	Description
	Red	Shooting menu	Shooting-related items
	Blue	Playback menu	Image playback-related items
	Yellow	Set-up menu	Camera's function settings
	Orange	Camera's Custom Functions	
	Green	Register frequently-used menu options and Custom Functions	

Menu Setting Procedure

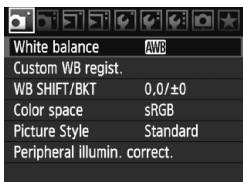

- 1 Display the menu.**
- Press the <MENU> button to display the menu.

- 2 Select a tab.**
- Turn the < > dial to select a tab.

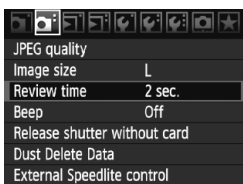

- 3 Select the desired item.**
- Turn the < > dial to select the item, then press < >.



- 4 Select the setting.**
- Turn the < > dial to select the desired setting.
 - The current setting is indicated in blue.

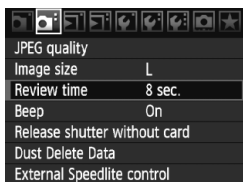

- 5 Set the selected setting.**
- Press < > to set it.
- 6 Exit the menu.**
- Press the <MENU> button to exit the menu and return to camera shooting ready.



- The explanation of menu functions hereinafter assumes that you have pressed the <MENU> button to display the menu screen.
- You can use < > to set menu options (except [Erase images] and [Format]).

Menu Settings

☑ Shooting 1 (Red)

Page

White balance	/ / / / / / / (1 - 5) / (2500 - 10000) / PC-1 - 5	72
Custom WB registration	Manual registration of white balance data	73
WB SHIFT/BKT	WB correction: B/A/M/G bias, 9 levels each WB-BKT: B/A and M/G bias, single-level increments, ±3 levels	79 80
Color space	sRGB / Adobe RGB	92
Picture Style	Standard / Portrait / Landscape / Neutral / Faithful / Monochrome / User Def. 1, 2, 3	66-71
Peripheral illumination correction	Enable / Disable	82

☑ Shooting 2 (Red)

JPEG quality	Compression rate for L, M1, M2, S	63
Image size	/ /	59
	L / M1 / M2 / S (→ p.48)	
Review time	Off / 2 sec. / 4 sec. / 8 sec. / Hold	181
Beep	On / Off	52
Release shutter without card	Enable / Disable	52
Dust Delete Data	Obtain data to be used by provided software to delete dust spots	185
External Speedlite control	Flash function settings / Flash C.Fn settings / Clear all Speedlite C.Fn's	121

☑ Playback 1 (Blue)





Protect images	Erase-protect images	172
Rotate	Rotate vertical images	162
Erase images	Erase images	179
Print order	Specify images to be printed (DPOF)	199
Image copy	Copy images between cards	176
External media backup	Displayed when external media is used via WFT-E2 II or WFT-E2 (both sold separately)	-

☰ Playback 2 (Blue)





Page

Highlight alert	Disable / Enable	157
AF point display	Disable / Enable	158
Histogram	Brightness / RGB	158
Enlarge display	Enlarge from image center / Enlarge from selected AF point	161
Image jump w/ 	1 image / 10 images / 100 images / Date / Folder / Movies / Stills	160
Slide show	Select the images and set the Play time and Repeat settings for automatic playback	168

☛ Set-up 1 (Yellow)

Auto power off	1min. / 2 min. / 4 min. / 8 min. / 15 min. / 30 min. / Off	52
Record func+media/ folder sel.	[Record func.] Standard / Auto switch media / Rec. separately / Rec. to multiple	57
	[Record/play] [Playback]  /  / 	56
	[Folder] Creating and selecting a folder	84
File numbering	Continuous / Auto reset / Manual reset	88
File name setting	File name (unique setting) / User setting 1 / User setting 2	86
Auto rotate	On  / On  / Off	182
Format	Initialize and erase data in the card	50

☛ Set-up 2 (Yellow)

LCD brightness	Adjustable to one of seven brightness levels	180
Date/Time	Set the date (year, month, day) and time (hour, min., sec.)	49
Language 	Language selectable	49
Video system	NTSC / PAL	170
Battery info.	Type, remaining capacity, shutter count, recharge performance check	247
Live View/Movie func. set.	LV  /  setting / AF mode / Grid display / Exposure simulation / Metering timer / Movie recording size / Sound recording (→ p.48 )	126
		130
		142
		151

Set-up 3 (Yellow)

Page







Save/load settings on media	Save/load camera settings to/from the card	238
Regist/apply basic settings	The camera's basic settings are registered in and applied to the camera	240
Clear all camera settings	Resets the camera to the default settings	53
Copyright information	Display copyright information / Enter author's name / Enter copyright details / Delete copyright information	90
Sensor cleaning	Auto cleaning / Clean now / Clean manually	184
Firmware Ver.	For updating the firmware	-
WFT settings	Displayed when external media is used via WFT-E2 II or WFT-E2 (both sold separately)	-

Custom Functions (Orange)

C.Fn I: Exposure	Customize camera functions as desired	208
C.Fn II: Image/Flash exposure/Display		214
C.Fn III: Autofocus/Drive		218
C.Fn IV: Operation/Others		227
Clear all Custom Functions (C.Fn)	Clears all Custom Function settings	204
C.Fn setting register/apply	Custom Function settings are registered in and applied to the camera	235

My Menu (Green)

My Menu settings	Register frequently-used menu items and Custom Functions	237
-------------------------	----------------------------------------------------------	-----

-  ● What is displayed in [ **Image size**] depends on the [**Record func.**] (p.57) setting under [ **Record func+media/folder sel.**]. If [**Record func.**] is set to [**Rec. separately**], select the image size for the respective card.
- What is displayed for [**LV /  set.**] depends on the [ **Live View/ Movie func. set.**] setting. Also, what is displayed (frame rate) for [**Movie rec. size**] depends on the [ **Video system**] setting.

Before You Start

MENU Setting the Interface Language



1 Select [Language].

- Under the [👉] tab, select [Language] (the third item from the top), then press <SET>.

English	Norsk	Română
Deutsch	Svenska	Türkçe
Français	Español	العربية
Nederlands	Ελληνικά	ગુજરાતી
Dansk	Русский	简体中文
Português	Polski	繁體中文
Suomi	Čeština	한국어
Italiano	Magyar	日本語
Українська		

2 Set the desired language.

- Turn the <☉> dial to select the language, then press <SET>.
- ▶ The interface language will change.

MENU Setting the Date and Time

Check if the camera's date and time are set correctly. If necessary, set the correct date and time.



1 Select [Date/Time].

- Under the [👉] tab, select [Date/Time], then press <SET>.



2 Set the date, time and date display format.

- Turn the <☉> dial to select the number.
- Press <SET> so ☐ is displayed.
- Turn the <☉> dial to select the desired setting, then press <SET>. (Returns to ☐.)

3 Exit the setting.

- Turn the <☉> dial to select [OK], then press <SET>.
- ▶ The date/time will be set and the menu will reappear.



It is important to set the correct date/time because it will be recorded together with each captured image.

MENU Formatting the Card

If the card is new or was previously formatted by another camera or personal computer, formatting the card with the camera is recommended.

ⓘ When the card is formatted, all images and data in the card will be erased. Even protected images will be erased, so make sure there is nothing you need to keep. If necessary, transfer the images to a personal computer, etc., before formatting the card.

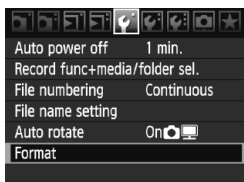

1 Select [Format].

- Under the [**F**] tab, select [**Format**], then press <SET>.



2 Select the card.

- [1] is the CF card, and [2] is the SD card.
- Turn the <DIAL> dial to select the card, then press <SET>.

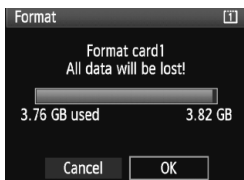

3 Select [OK].

- When [2] is selected, low-level formatting is possible (p.51).
- Turn the <DIAL> dial to select [**OK**], then press <SET>.
- ▶ The card will be formatted.
- ▶ When the formatting is completed, the menu will reappear.

 When the card is formatted or data is erased, only the file management information is changed. The actual data is not completely erased. Be aware of this when selling or discarding the card. When discarding the card, execute low-level formatting or destroy the card physically to prevent the data from being leaked.



 The card capacity displayed on the card format screen might be smaller than the capacity indicated on the card.

About Low-level Formatting

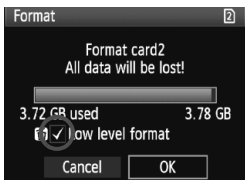
When [2] is selected, low-level formatting is possible. If the writing speed to the SD card is slower than usual or if you want to completely erase the data in the SD card, checkmark [Low level format] and format the card.



Press the < > button.

- In step 3 on the preceding page, press the <  > button.
- ▶ The [Low level format] option will be checkmarked <  >.
- With <  > displayed, select [OK] to start the low-level formatting.

 ● Since low-level formatting will erase all recordable sectors in the SD card, the formatting will take longer than normal formatting.

● You can stop the low-level formatting by selecting [Cancel]. Even in this case, normal formatting will have been completed and you can use the SD card as usual.

MENU Set the Power-off Time/Auto Power Off

To save battery power, the camera turns off automatically after a certain time of non-operation. You can change this auto power-off time. If you do not want the camera to turn off automatically, set this to **[Off]**. After the power turns off, you can turn on the camera again by pressing the shutter button or other button.

**1 Select [Auto power off].**

- Under the [**☺**] tab, select **[Auto power off]**, then press <ⓈET>.

2 Set the desired time.

- Turn the <⌚> dial to select the setting, then press <ⓈET>.

 Even if **[Off]** has been set, the LCD monitor will turn off automatically after 30 min. to save power. (The camera's power does not turn off.)

MENU Silencing the Beeper

Prevents the beeper from sounding when focus is achieved.

1 Select [Beep].

- Under the [**☺**] tab, select **[Beep]**, then press <ⓈET>.

2 Select [Off].

- Turn the <⌚> dial to select **[Off]**, then press <ⓈET>.

MENU Card Reminder

This prevents shooting if there is no card in the camera.

1 Select [Release shutter without card].

- Under the [**☺**] tab, select **[Release shutter without card]**, then press <ⓈET>.

2 Select [Disable].

- Turn the <⌚> dial to select **[Disable]**, then press <ⓈET>.

MENU Reverting the Camera to the Default Settings

The camera's shooting settings and menu settings can be reverted to the default.

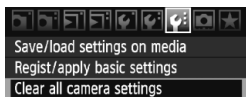

1 Select [Clear all camera settings].

- Under the [] tab, select [Clear all camera settings], then press <SET>.

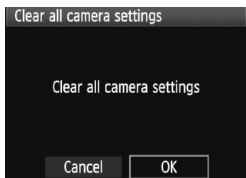

2 Select [OK].

- Turn the < > dial to select [OK], then press <SET>.
- ▶ The camera's default settings will be as shown below.



Shooting Settings

Shooting mode	P (Program AE)
AF mode	One-Shot AF
AF point	Automatic selection
Metering mode	(Evaluative metering)
Drive mode	<input type="checkbox"/> (Single shooting)
Exposure compensation	0 (Zero)
AEB	Canceled
Flash exposure compensation	0 (Zero)
External Speedlite control	Unchanged



Image-recording Settings

Record func.	Standard
Image size	L (Large)
JPEG quality	8
ISO speed	A (AUTO)
Picture Style	(Standard)
Peripheral illumination correction	Enable/Correction data retained
Color space	sRGB
White balance	(Auto)
Custom WB data	Registered setting retained
Personal WB	Registered setting retained
WB correction	Canceled
WB-BKT	Canceled
File numbering	Continuous
File name setting	Preset code
Copyright information	Information retained
Auto cleaning	Enable
Dust Delete Data	Erased

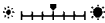
Camera Settings

Auto power off	1 min.
Beep	On
Release shutter without card	Enable
Review time	2 sec.
Highlight alert	Disable
AF point display	Disable
Registered AF point	Canceled (Center)
Histogram	Brightness
Enlarge display	Center
Image jump w/ 	10 images
Auto rotate	On 
Slide show	All image
LCD brightness	
Date/Time	Unchanged
Language	Unchanged
Video system	Unchanged
Basic settings	Unchanged
My Menu settings	Unchanged
Display from My Menu	Disable
Custom Functions	Unchanged

Live View/Movie Shooting Settings



LV   setting	Disable
AF mode	Live mode
Grid display	Off
Exposure simulation	Enable
Movie-recording size	1920x1080
Sound recording	On
Metering timer	16 sec.

2

Image Settings

This chapter explains image-related function settings: Image-recording quality, ISO speed, Picture Style, white balance, Auto Lighting Optimizer, lens peripheral illumination correction, etc.

Selecting the Card to Record or Playback

This Instruction Manual assumes that a CF card or SD card is in the camera. When an external media is used via the Wireless File Transmitter WFT-E2 II or WFT-E2 (both sold separately), the  icon will appear as the third recording media. It can be selected in the same way as with the CF card  and SD card .

If either a CF card or an SD card is in the camera, the card to record images will be selected automatically.

If both the CF and SD cards are in the camera, you can select the card for recording or playing images as follows:

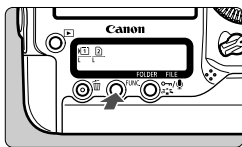



1 Press the <FUNC.> button. (06)

- Press the <FUNC.> button once or twice to display the card and image size on the rear LCD panel.

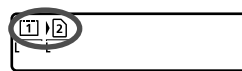
Card/Image size ↔ WB



2 Select the card.

- Turn the <FUNC.> dial to select the card for recording images.
 - ▶  : Record to CF card
 - ▶  : Record to SD card
- Turn the <FUNC.> dial to select the image size (p.59).

MENU Card Selection and Recording and Playback

- You can also use the [ Record func+media/folder sel.] menu's [Record/play] ([Playback]) option to select the card. Depending on the [Record func.] (p.57) setting, the operation selected here will have a different function.

[Standard] [Auto switch media]

The operation explained on this page selects the card for recording and playing back images.

[Rec. separately] [Rec. to multiple]

The captured image is recorded to the CF card and SD card simultaneously. In this case, the operation explained on this page selects the card for playing back images.

MENU Recording Method with Two Cards Inserted

If both the CF card and SD card are inserted into the camera, you can set the recording method for the cards.



1 Select [Record func+media/folder sel.].

- Under the [**Record func+media/folder sel.**] tab, select [**Record func+media/folder sel.**], then press <SET>.

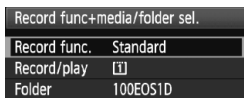

2 Select [Record func.].

- Turn the <DIAL> dial to select [**Record func.**], then press <SET>.

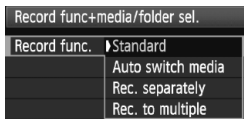

3 Select the recording method.

- Turn the <DIAL> dial to select the recording method, then press <SET>.

- **Standard**

Images will be recorded to the card selected with the procedure on the preceding page.

- **Auto switch media**

Same as with the [**Standard**] setting, but if the card becomes full, the camera will automatically switch to the other card to record images.

- **Rec. separately**

You can set the image size to be recorded for each card (p.59). Each image is recorded to both the CF and SD cards at the image size you have set. The image size can be set freely to **L** and **M2** or **RAW** and **M RAW**, for example.

- **Rec. to multiple**

Each image is recorded to both the CF and SD cards simultaneously at the same image size. You can also select RAW+JPEG.



- When [**Auto switch media**] is set, the card for recording will switch from 1 to 2 to 3.
- When [**Rec. separately**] or [**Rec. to multiple**] is set, the image will be recorded under the same file number to both the CF and SD cards. Also, the top LCD panel and viewfinder will display the number of possible shots of the card having the lower number. If one of the cards becomes full, [**Card* full**] will be displayed and shooting will be disabled. If this happens, either replace the card or set the recording method to [**Standard**] or [**Auto switch media**] and select the card with remaining space to continue shooting.

Setting the Image-recording Quality

You can set the image size (recorded pixels), image type (JPEG or RAW), and JPEG quality (compression rate).

Selecting the Image Size

L/M1/M2/S will record the image as a JPEG image. In the **RAW/M RAW/S RAW** mode, the image will require processing with the software provided.

You can set the image size in one of the two ways below.

Using the Rear LCD Panel to Set the Image Size

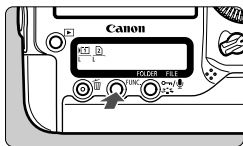

1 Press the <FUNC.> button. (ⓘ6)

- Press the <FUNC.> button once or twice to display the card and image size on the rear LCD panel.

Image size/Card ↔ WB

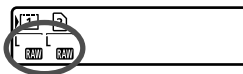

2 Select the image size.

- Turn the <☉> dial to select the image size.
- If **RAW/M RAW/S RAW** and **L/M1/M2/S** are displayed at the same time, the RAW and JPEG image will be recorded simultaneously on the card.
- Turn the <☀> dial to select the card to record or playback images (p.56).

 When [Record func.] is set to [Rec. separately] (p.57), turn the <☀> dial to select the card and set the image size for the respective card.

Using the Menu Screen to Set the Image Size



1 Select [Image size].

- Under the [] tab, select [Image size], then press < >.

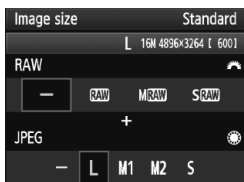

2 Set the image size.

- To select a RAW image size, turn the < > dial. To select a JPEG image size, turn the < > dial.
- On the screen, the “***M (megapixels) *** x ****” number indicates the recorded pixel count, and [****] is the number of possible shots.
- Press < > to set it.

Image Size Setting Examples

L only

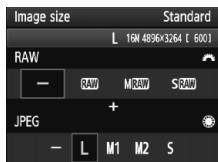

RAW only

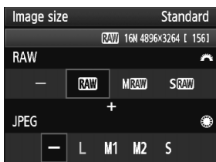

S RAW + M2



- If [-] is set for both RAW and JPEG, L will be set.
- If [Record func.] is set to [Rec. separately] (p.57), the setting screen will be different. You can set the image size for each card.
- In accordance with the selected image size, the < > or < > icon will be displayed on the right side in the viewfinder.
- The image size icons indicate the following: (RAW), (Medium RAW), (Small RAW), JPEG, (Large), (Medium 1), (Medium 2), (Small).

Guide to Image-recording Quality Settings (Approx.)

Image Size	Pixels Recorded	Print Size	File Size (MB)	Possible Shots	Maximum Burst
L	16.0M	A3 or larger	5.7	692	85 (121)
M1	12.4M	Around A3	4.5	874	111 (164)
M2	8.4M	A4 or larger	3.5	1148	182 (309)
S	4.0M	A5 or larger	2.0	1957	1957 (5447)
RAW	16.0M	A3 or larger	22.2	175	26 (28)
RAW + L	16.0M+16.0M	-	22.2+5.7	139	20 (20)
RAW + M1	16.0M+12.4M		22.2+4.5	145	20 (20)
RAW + M2	16.0M+8.4M		22.2+3.5	152	20 (20)
RAW + S	16.0M+4.0M		22.2+2.0	161	20 (20)
M RAW	9.0M	A4 or larger	14.8	263	33 (35)
M RAW + L	9.0M+16.0M	-	14.8+5.7	190	20 (20)
M RAW + M1	9.0M+12.4M		14.8+4.5	202	20 (20)
M RAW + M2	9.0M+8.4M		14.8+3.5	214	20 (20)
M RAW + S	9.0M+4.0M		14.8+2.0	232	20 (20)
S RAW	4.0M	A5 or larger	9.9	397	43 (43)
S RAW + L	4.0M+16.0M	-	9.9+5.7	251	20 (20)
S RAW + M1	4.0M+12.4M		9.9+4.5	272	20 (20)
S RAW + M2	4.0M+8.4M		9.9+3.5	294	20 (20)
S RAW + S	4.0M+4.0M		9.9+2.0	329	20 (20)

- Figures for the file size, possible shots, and maximum burst during continuous shooting are based on Canon's 4GB testing card and Canon's testing standards (JPEG quality 8, ISO 100, and Standard Picture Style). **These figures will vary depending on the subject, card brand, ISO speed, Picture Style, Custom Functions, and other settings.**
- The maximum burst applies to  high-speed continuous shooting. Figures in parentheses apply to an Ultra DMA (UDMA) mode 6 16GB card based on Canon's testing standards.

About RAW

A RAW image is the raw data output by the image sensor, converted to digital data and recorded on the card as is. You can select from **RAW**, **M RAW**, or **S RAW** (Commonly referred as RAW in this manual).

With RAW images, you can use the provided software to make various adjustments as desired and then generate a JPEG, TIFF, etc., image.



Commercially-available software might not be able to display RAW images. Using the provided software is recommended.

Maximum Burst During Continuous Shooting



The maximum burst during continuous shooting indicated on the preceding page is the number of continuous shots that can be taken without stopping, based on a formatted card.

In the viewfinder, the approximate maximum burst is indicated on the right side.



- The maximum burst is displayed even when a card is not inserted in the camera. Make sure that a card is loaded before taking a picture.
- If [**C.Fn II -2: High ISO speed noise reduction**] is set to [**2: Strong**], the maximum burst will be greatly reduced (p.214).



- If the viewfinder displays “99” for the maximum burst, it means the maximum burst is 99 or higher. If the maximum burst decreases to 98 or lower and the internal buffer memory becomes full, “buSY” will be displayed on the top LCD panel and in the viewfinder and shooting will be disabled temporarily. If you stop the continuous shooting, the maximum burst will increase. After all the captured images are written to the card, the maximum burst will be as listed on page 61.
- The maximum burst indicator in the viewfinder will not change even when you use a UDMA CF card. However, the maximum burst shown in parentheses on page 61 will apply.

MENU Setting the JPEG Quality (Compression Rate)

The recording quality (compression rate) can be set for each image size L/M1/M2/S.

**1** Select [JPEG quality].

- Under the [MENU] tab, select [JPEG quality], then press <SET>.

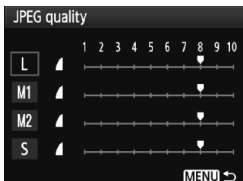
**2** Select the image size.

- Turn the <DIAL> dial to select the image size, then press <SET>.

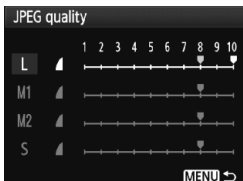
**3** Set the desired quality (compression rate).

- Turn the <DIAL> dial to select the setting, then press <SET>.
- The higher the number, the higher the quality will be (lower compression).
- For 6 - 10, <▲> is displayed.
- For 1 - 5, <■> is displayed.



The higher the recording quality, the fewer the number of possible shots will be. On the other hand, the lower the recording quality, the higher the number of possible shots will be.

ISO: Setting the ISO Speed

Set the ISO speed (image sensor's sensitivity to light) to suit the ambient light level.

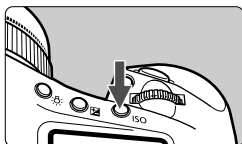

1 Press the <ISO> button. (ⓘ6)

2 Set the ISO speed.

- While looking at the top LCD panel or in the viewfinder, turn the <gear> dial.
- ISO speed can be set within ISO 100-12800 in 1/3-stop increments.
- With "A" selected, the ISO speed will be set automatically (p.65).

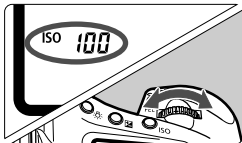

ISO Speed Guide (No flash)

ISO Speed	Shooting Situation	Flash Range
100 - 400	Sunny outdoors	The higher the ISO speed, the farther the flash range will be.
400 - 1600	Overcast skies or evening time	
1600 - 12800, H1, H2, H3	Dark indoors or night	

- If [C.Fn II -3: Highlight tone priority] is set to [1: Enable], the settable ISO speed range will be ISO 200 - 12800 (p.215).
- Using a high ISO speed or shooting in high-temperature conditions may result in more grainy images. Long exposures can also cause irregular colors in the image.
- When you shoot at high ISO speeds, noise (horizontal banding, dots of light, etc.) or irregular colors may appear. Also, if you shoot with the ISO speed range upper limit expanded to H1, H2 or H3 with [C.Fn I -3: Set ISO speed range] (p.208), noise and irregular colors may become more visible.

With [C.Fn I -3: Set ISO speed range], the ISO speed range can be expanded from ISO 50 (L) to ISO 102400 (H3).

About “A” (Auto) ISO Speed



If the ISO speed is set to “A”, the actual ISO speed to be set will be displayed when you press the shutter button halfway. As indicated below, the ISO speed will be set automatically to suit the shooting mode.

Default ISO Speed

Shooting Mode	ISO Speed Setting
P/Tv/Av/M	ISO 100 - 12800
Bulb	Fixed at ISO 400
With flash	Fixed at ISO 400*

* If the shooting mode is <P> and bounce flash is set with an external Speedlite, ISO 400-1600 will be set automatically.

* If fill flash results in overexposure, ISO 100 or a higher ISO will be set.

 With [**C.Fn I -3: Set ISO speed range**] (p.208), the upper and lower limit settings and ISO Auto setting will work as follows.

In P/Tv/Av/M shooting modes

- Even if the upper limit is set to H1, H2, or H3 and the lower limit to L, ISO 100-12800 will be set automatically.
- If you narrowed the upper and lower limits from the default setting, the ISO speed will be set automatically within the range you have set.

With bulb exposures and flash photography

- If ISO 400 is not within the upper and lower limit, the ISO speed will be set close to 400.

 Even if [**C.Fn I -3: Set ISO speed range**], [**C.Fn I -12: Set shutter speed range**] (p.211), or [**C.Fn I -13: Set aperture value range**] (p.211) is set to limit the settable range, if [**C.Fn I -8: Safety shift**] (p.210) is set to [**1: Enable (Tv/Av)**] or [**2: Enable (ISO speed)**], a setting outside the limited range might be set to obtain a correct exposure.

Selecting a Picture Style

By selecting a Picture Style, you can obtain image effects matching your photographic expression or the subject.

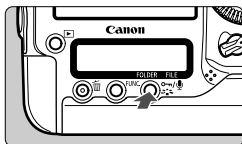

1 Press the **<Picture Style>** button.

- When the camera is ready to shoot, press the **<Picture Style>** button.
- ▶ The Picture Style screen will appear.

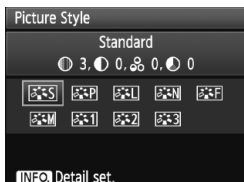

2 Select a Picture Style.

- Turn the **<Mode>** or **<Picture Style>** dial to select a Picture Style, then press **<SET>**.
- ▶ The Picture Style will be set and the camera will be ready to shoot.

 You can also use the **[Picture Style]** menu to select the Picture Style.

Picture Style Effects

Standard

The image looks vivid, sharp, and crisp. This is a general-purpose Picture Style suitable for most scenes.

Portrait

For nice skin tones. The image looks softer. Effective for close-ups of women or children.

By changing the **[Color tone]** (p.68), you can adjust the skin tone.

Landscape

For vivid blues and greens, and very sharp and crisp images. Effective for impressive landscapes.

Neutral

This Picture Style is for users who prefer to process images with their computer. For natural colors and subdued images.

Faithful

This Picture Style is for users who prefer to process images with their computer. When the subject is captured under a daylight color temperature of 5200K, the color is adjusted colorimetrically to match the subject's color. The image is dull and subdued.

Monochrome

Creates black-and-white images.

 JPEG images shot in Monochrome cannot be reverted to color. If you want to later shoot pictures in color, make sure the **[Monochrome]** setting has been canceled. When **[Monochrome]** is selected, **<B/W >** will appear in the viewfinder and on the rear LCD panel.

User Def. 1-3







You can select a base Picture Style such as **[Portrait]** or **[Landscape]**, a Picture Style file, etc., adjust it as desired and register it under **[User Def. *]** (p.70). Any User Defined Picture Style which has not been set will have the same settings as the Standard Picture Style.

About the Symbols

The symbols on the top of the Picture Style selection screen refer to parameters such as **[Sharpness]** and **[Contrast]**. The numerals indicate the parameter settings, such as **[Sharpness]** and **[Contrast]**, for each Picture Style.



Symbols

	Sharpness
	Contrast
	Saturation
	Color tone
	Filter effect (Monochrome)
	Toning effect (Monochrome)



Customizing a Picture Style

You can customize a Picture Style by adjusting individual parameters like **[Sharpness]** and **[Contrast]**. To see the resulting effects, take test shots. To customize **[Monochrome]**, see the next page.



1 Press the  button.

2 Select a Picture Style.

- Turn the  or  dial to select a Picture Style, then press the **<INFO.>** button.

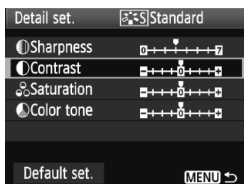

3 Select a parameter.

- Turn the  dial to select the parameter, then press **<SET>**.







4 Set the parameter.

- Turn the  dial to set the parameter as desired, then press **<SET>**.
- Press the **<MENU>** button to save the adjusted parameters. The Picture Style selection screen will reappear.
- ▶ Any settings different from the default will be displayed in blue.



Parameter Settings and Effects

 Sharpness	0: Less sharp outline	+7: Sharp outline
 Contrast	-4: Low contrast	+4: High contrast
 Saturation	-4: Low saturation	+4: High saturation
 Color tone	-4: Reddish skin tone	+4: Yellowish skin tone



- By selecting [**Default set.**] in step 3, you can revert the respective Picture Style to its default parameter settings.
- To shoot with the Picture Style you modified, follow step 2 on the preceding page to select the modified Picture Style and then shoot.

Monochrome Adjustment

For Monochrome, you can also set [**Filter effect**] and [**Toning effect**] in addition to [**Sharpness**] and [**Contrast**].

Filter Effect

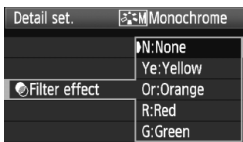

With a filter effect applied to a monochrome image, you can make white clouds or green trees stand out more.

Filter	Sample Effects
N: None	Normal black-and-white image with no filter effects.
Ye: Yellow	The blue sky will look more natural, and the white clouds will look crisper.
Or: Orange	The blue sky will look slightly darker. The sunset will look more brilliant.
R: Red	The blue sky will look quite dark. Fall leaves will look crisper and brighter.
G: Green	Skin tones and lips will look fine. Tree leaves will look crisper and brighter.



Increasing the [**Contrast**] will make the filter effect more pronounced.

Toning Effect

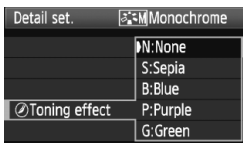

By applying a toning effect, you can create a monochrome image in that color. It can make the image look more impressive.

The following can be selected: [**N:None**] [**S:Sepia**] [**B:Blue**] [**P:Purple**] [**G:Green**].

Registering a Picture Style



You can select a base Picture Style such as **[Portrait]** or **[Landscape]**, adjust its parameters as desired and register it under **[User Def. 1]**, **[User Def. 2]**, or **[User Def. 3]**.

You can create Picture Styles whose parameter settings such as for sharpness and contrast are different. You can also adjust the parameters of a Picture Style which has been registered to the camera with the provided software.

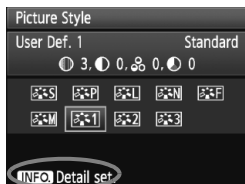
1 Press the button.



2 Select **[User Def.]**.

- Turn the  or  dial to select **[User Def. *]**, then press the **<INFO.>** button.

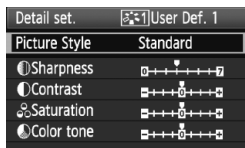

3 Press **<SET>**.

- With **[Picture Style]** selected, press **<SET>**.

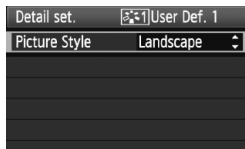

4 Select the base **Picture Style**.

- Turn the  dial to select the base Picture Style, then press **<SET>**.
- To adjust the parameters of a Picture Style which has been registered to the camera with the provided software, select the Picture Style here.

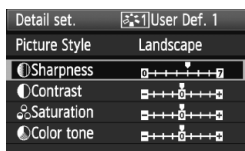

5 Select a parameter.

- Turn the  dial to select a parameter such as **[Sharpness]**, then press **<SET>**.



6 Set the parameter.

- Turn the <☉> dial to set the parameter as desired, then press <SET>.
For details, see “Customizing a Picture Style” on pages 68-69.
- Press the <MENU> button to register the new Picture Style. The Picture Style selection screen will then reappear.
- ▶ The base Picture Style will be indicated on the right of [User Def. *].

⚠ If a Picture Style has already been registered under [User Def. *], changing the base Picture Style in step 4 will nullify the parameter settings of the registered Picture Style.

📄 To shoot with the registered Picture Style, follow step 2 on the preceding page to select [User Def. *] and then shoot.

Setting the White Balance

White balance (WB) is for making the white areas look white. Normally, the **<AWB>** (Auto) setting will obtain the correct white balance. If natural-looking colors cannot be obtained with **<AWB>**, you can set the white balance manually to suit the respective light source.

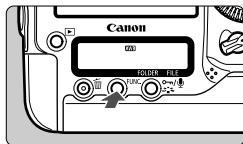

1 Press the **<FUNC.>** button. (6)

- Press the **<FUNC.>** button once or twice to display the WB on the rear LCD panel's upper right.

WB ↔ Card/Image size



2 Select the white balance.

- Turn the **<WB>** dial to select the WB.

Display	Mode	Color Temperature (Approx. K: Kelvin)
AWB	Auto	3000 - 7000
	Daylight	5200
	Shade	7000
	Cloudy, twilight, sunset	6000
	Tungsten light	3200
	White fluorescent light	4000
	Flash use	6000
	Custom (p.73)	2000 - 10000
K	Color temperature (p.78)	2500 - 10000

About White Balance

To the human eye, a white object looks white regardless of the type of lighting. With a digital camera, the color temperature is adjusted with software to make the white areas look white. This adjustment serves as the basis for the color correction. The result is natural-looking colors in the pictures.

- You can also use the **[WB] White balance** menu to set the white balance.
- To set Personal WB, select **[PC-***]. To save the Personal WB to the camera, use the provided software. If Personal WB has not been registered, **[PC-***] will not be displayed.

Custom White Balance

Custom white balance enables you to manually set the white balance for a specific light source for better accuracy. Up to five Custom white balance data can be registered to the camera. You can also append a name (caption) to the registered Custom white balance data.

MENU Registering Custom WB

There are two ways to register Custom white balance data. You can either take a picture and register it, or register an image already saved in the card.

Capture and register the image

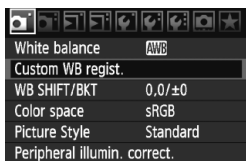

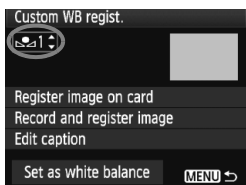

1 Select [Custom WB regist.].

- Under the [] tab, select [Custom WB regist.], then press <SET>.



2 Select the Custom WB No. to be registered.

- Press <SET>.
- Turn the < > dial to select 1 to 5 for <* >, then press <SET>. The Custom WB data will be registered under the selected No.

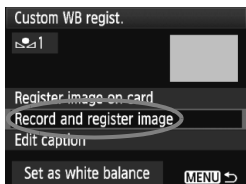

3 Select [Record and register image].

- Turn the < > dial to select [Record and register image], then press <SET>.
- ▶ The LCD monitor will turn off, and the selected No. [*] will blink on the rear LCD panel.

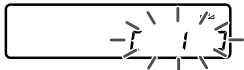

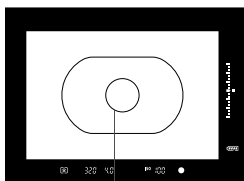

Spot metering circle

4 Photograph a solid-white object.

- The plain, white object should fill the center spot metering circle.
- Focus manually and set the standard exposure for the white object.
- Any white balance mode may be set.

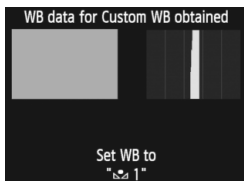

- ▶ The Custom WB data will be registered.
- To use the Custom WB, see “Selecting and Shooting with the Custom WB data” (p.76).

- Custom WB data can also be registered as follows:
 1. Press the <FUNC.> button and turn the <◉> dial to select <☑> (p.72).
 2. Then turn the <☀> dial to select the No. under which the Custom WB is to be registered.
 3. Press the <☑> button.
→ [*] will blink on the rear LCD panel.
 4. Follow step 4 above to photograph a solid-white object.
→ The Custom WB data will be registered under the selected No.

When a picture is taken, the registered Custom white balance will be applied.
- If the exposure of the picture differs greatly from the standard exposure, a correct white balance might not be obtained. If [**Correct WB may not be obtained with the selected image**] is displayed in step 4, go back to step 1 and try again.
- The image captured in step 4 will not be recorded to the card.
- Instead of a white object, an 18% gray card (commercially available) can produce a more accurate white balance.

Register image on card



First follow step 4 under “Capture and register the image” (p.73, 74) to take a picture of a plain, white object. This image saved in the card can then be registered for Custom WB. The procedure up to step 2 is the same as with “Capture and register the image”.

1 Select [Custom WB regist.].

2 Select the Custom WB No. to be registered.





3 Select [Register image on card].

- Turn the <  > dial to select [**Register image on card**], then press <  >.
- ▶ The images saved in the card will be displayed.



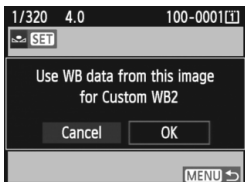

4 Select the image to be used for registering the Custom WB data.

- You can also display a four- or nine-image index by pressing the <  > button.
- Turn the <  > dial to select the image to be registered for the Custom WB data, then press <  >.



5 Select [OK].

- Turn the <  > dial to select [**OK**], then press <  >.
- ▶ The Custom WB data will be registered. When the message appears, press <  > to return to step 3.
- To use the Custom WB, see “Selecting and Shooting with the Custom WB data” (p.76).

 If the image was captured while the Picture Style was set to [**Monochrome**] (p.67), it cannot be selected in step 4.

MENU Selecting and Shooting with the Custom WB data

Registered image

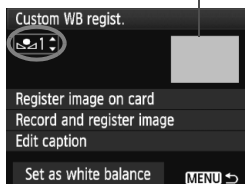

1 Select the Custom WB No.

- On the Custom WB registration screen, select the No. of the registered Custom WB.

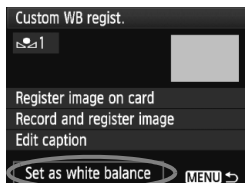

2 Select [Set as white balance].

- Turn the <DIAL> dial to select [**Set as white balance**], then press <SET>.
- ▶ The WB will be set to the registered <WB>*.

3 Take the picture.

- ▶ The picture will be taken with the <WB>* setting.

You can also select the Custom WB No. while looking at the rear LCD panel. Press the <FUNC.> button and turn the <DIAL> dial to select <WB>. Then turn the <DIAL> dial to select the registered Custom WB No.

MENU Naming the Custom WB data

You can also append a name (caption) to the registered Custom white balance data.

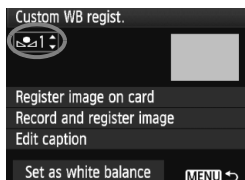

1 Select the Custom WB No.

- On the Custom WB data registration screen, select the Custom WB No. to be appended with a name.

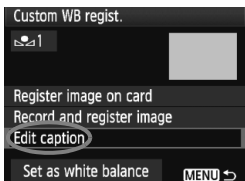

2 Select [Edit caption].

- Turn the <DIAL> dial to select [Edit caption], then press <SET>.

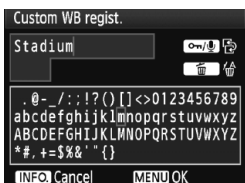

3 Enter any name.

- Press the <ON/OFF/SHOOT> button, and the text palette will be highlighted in a color frame and text can be entered.
- Operate the <DIAL> dial or <MULTI-SELECT> to move the cursor and select the desired character. Then press <SET> to enter it.
- You can enter up to 20 characters.
- To delete a character, press the <DELETE> button.

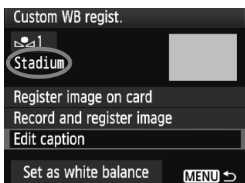

4 Exit the setting.

- After entering the name, press the <MENU> button.
- ▶ The name will be saved and the screen will return to step 2. The entered name will be displayed below <DIAL>.

Entering a name which indicates the Custom WB's place or light source type makes it convenient.

Setting the Color Temperature

You can set the white balance's color temperature numerically in Kelvin. This is for advanced users.

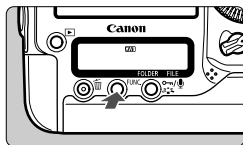

1 Press the <FUNC.> button. (6)

- Press the <FUNC.> button once or twice to display the white balance on the rear LCD panel's upper right.

WB ↔ Card/Image size

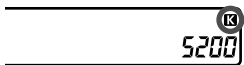

2 Select <K>.

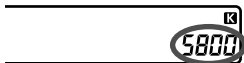

- Turn the <Q> dial to select <K>.



3 Set the desired color temperature.

- Turn the <W> dial to set the color temperature.
- The color temperature can be set from 2500K to 10000K in 100K increments.

- When setting the color temperature for an artificial light source, set white balance correction (magenta or green) as necessary.
- If you want to set <K> to the reading taken with a commercially-available color temperature meter, take test shots and adjust the setting to compensate for the difference between the color temperature meter's reading and the camera's color temperature reading.

 You can also use the [ White balance] menu to set the white balance.

WB \pm White Balance Correction

You can correct the white balance that has been set. This adjustment will have the same effect as using a commercially-available color temperature conversion filter or color compensating filter. Each color can be corrected to one of nine levels.

This is for advanced users who are familiar with using color temperature conversion or color compensating filters.

White Balance Correction

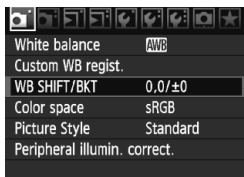

- 1 Select [WB SHIFT/BKT].
 - Under the [WB] tab, select [WB SHIFT/BKT], then press <SET>.

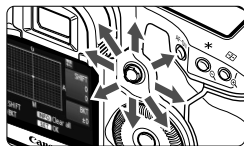

- 2 Set the white balance correction.
 - Use <[WB] > to move the “■” mark to the desired position.
 - B is for blue, A is amber, M is magenta, and G is green. The color in the respective direction will be corrected.
 - On the upper right, “SHIFT” indicates the direction and correction amount.
 - Pressing the <INFO.> button will cancel all the [WB SHIFT/BKT] settings.
 - Press <SET> to exit the setting and return to the menu.

Sample setting: A2, G1

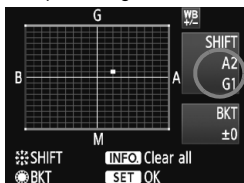

- During the white balance correction, <WB \pm > will be displayed in the viewfinder and on the rear LCD panel.
- One level of the blue/amber correction is equivalent to 5 mireds of a color temperature conversion filter. (Mired: Measuring unit indicating the density of a color temperature conversion filter.)

White Balance Auto Bracketing

With just one shot, three images having a different color balance can be recorded simultaneously. Based on the color temperature of the current white balance setting, the image will be bracketed with a blue/amber bias or magenta/green bias. This is called white balance bracketing (WB-BKT). White balance bracketing is possible up to ± 3 levels in single-level increments.

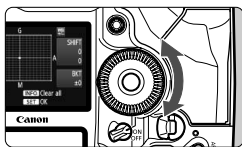

B/A bias ± 3 levels

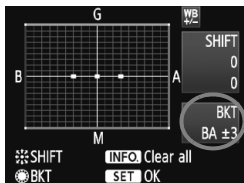

Set the white balance bracketing amount.

- In step 2 for white balance correction, when you turn the  dial, the "■" mark on the screen will change to "■■■" (3 points). Turning the dial to the right sets the B/A bracketing, and turning it to the left sets the M/G bracketing.
- ▶ On the right side of the screen, "BKT" indicates the bracketing direction and the bracketing amount.
- Pressing the <INFO.> button will cancel all the [WB SHIFT/BKT] settings.
- Press <SET> to exit the setting and return to the menu.

Bracketing Sequence

The images will be bracketed in the following sequence: 1. Standard white balance, 2. Blue (B) bias, and 3. Amber (A) bias, or 1. Standard white balance, 2. Magenta (M) bias, 3. Green (G) bias.



- During WB bracketing, the maximum burst for continuous shooting will be lower and the number of possible shots will also decrease to one-third the normal number. Also, the white balance icon will blink on the rear LCD panel.
- You can also set white balance correction and AEB together with white balance bracketing. If you set AEB in combination with white balance bracketing, a total of nine images will be recorded for a single shot.
- Since three images are recorded for one shot, the card will take longer to record the shot.
- "BKT" stands for Bracketing.

Auto Lighting Optimizer

If the image comes out dark or the contrast is low, the brightness and contrast can be corrected automatically. With JPEG images, the correction is done when the image is captured. Setting information is appended to RAW images and automatic correction is possible with Digital Photo Professional (provided software).

By default, [**Standard**] is set. However, with [**C.Fn II -4: Auto Lighting Optimizer**], you can adjust the correction amount (p.215).

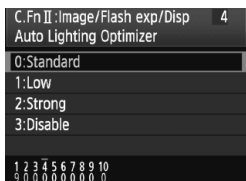

1 Set [**C.Fn II -4: Auto Lighting Optimizer**].

- Set the correction amount.
- For details on setting a Custom Function, see page 204.

2 Take the picture.

- The image will be recorded with the brightness and contrast corrected if necessary.



Sample of corrected brightness

- If [**C.Fn II -4: Auto Lighting Optimizer**] is set to a setting other than [**3: Disable**], the image might still look bright even if manual exposure, exposure compensation, or flash exposure compensation has been set to make the exposure darker. If you want the darker exposure, set the Auto Lighting Optimizer to [**3: Disable**] first (p.215).
- Depending on the shooting conditions, noise might increase.

MENU Lens Peripheral Illumination Correction

Due to the lens characteristics, the four corners of the picture might look darker. This is called lens light fall-off or drop in peripheral illumination. With JPEG images, the correction is done when the image is captured. Setting information is appended to RAW images and automatic correction is possible with Digital Photo Professional (provided software). The default setting is **[Enable]**.

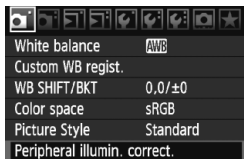

1 Select **[Peripheral illumin. correct.]**.

- Under the [] tab, select **[Peripheral illumin. correct.]**, then press < >.

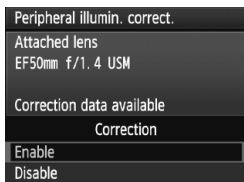

2 Set the correction setting.

- On the screen, check that **[Correction data available]** is displayed for the attached lens.
- If **[Correction data not available]** is displayed, see “About the Lens Correction Data” on the next page.
- Turn the < > dial to select **[Enable]**, then press < >.

3 Take the picture.

- The image will be recorded with the corrected peripheral illumination.



Correction enabled



Correction disabled

About the Lens Correction Data

The camera already contains lens peripheral illumination correction data for approx. 25 lenses. In step 2, if you select **[Enable]**, the peripheral light correction will be applied automatically for any lens whose correction data has been registered in the camera.

With EOS Utility (provided software), you can check which lenses have their correction data registered in the camera. You can also register the correction data for unregistered lenses. For details, see the PDF Software Instruction Manual (on the CD-ROM) for EOS Utility.



- For JPEG images already captured, lens peripheral light correction cannot be applied.
- Depending on shooting conditions, noise might appear on the image periphery.
- When using a third-party lens, setting the correction to **[Disable]** is recommended, even if **[Correction data available]** is displayed.



- Lens peripheral light correction is applied even when an Extender is attached.
- If the correction data for the attached lens has not been registered to the camera, the result will be the same as when the correction is set to **[Disable]**.
- The correction amount applied will be slightly lower than the maximum correction amount settable with Digital Photo Professional (provided software).
- If the lens does not have distance information, the correction amount will be lower.
- The higher the ISO speed, the lower the correction amount will be.

MENU Creating and Selecting a Folder

You can freely create and select the folder where the captured images are to be saved.

This is optional since a folder will be created automatically for saving captured images.

Create a Folder

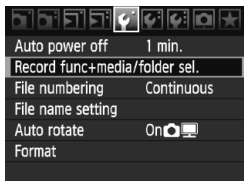

1 Select [Record func+media/folder sel.].

- Under the [**Y**] tab, select [**Record func+media/folder sel.**], then press < **SET** >.

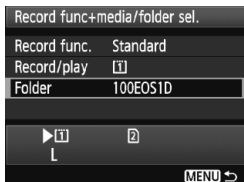

2 Select [Folder].

- Select [**Folder**], then press < **SET** >.

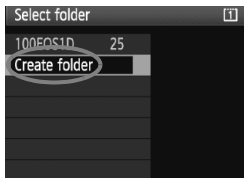

3 Select [Create folder].

- Turn the < **DISP** > dial to select [**Create folder**], then press < **SET** >.

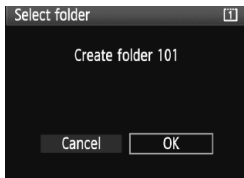

4 Select [OK].

- Turn the < **DISP** > dial to select [**OK**], then press < **SET** >.
- ▶ A new folder with a higher one-up folder number is created.

Selecting a Folder

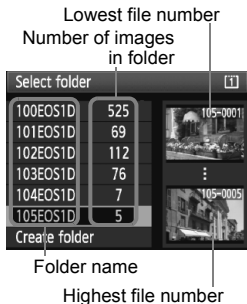

- With the Select folder screen displayed, turn the <◂> dial to select the desired folder, then press <SET>.
- ▶ The folder where the captured images will be saved is selected.
- Subsequent captured images will be recorded into the selected folder.

About Folders

As with “100EOS1D” for example, the folder name starts with three digits (folder number) followed by five alphanumeric characters. A folder can contain up to 9999 images (file No. 0001 - 9999). When a folder becomes full, a new folder with a higher one-up folder number is created automatically. Also, if manual reset (p.89) is executed, a new folder will be created automatically. Folders numbered from 100 to 999 can be created.

Creating Folders with a Personal Computer

With the card open on the screen, create a new folder named “DCIM”. Open the DCIM folder and create as many folders as necessary to save and organize your images. The folder name must follow the “100ABC_D” format where the first three digits is 100 - 999 followed by five alphanumeric characters. The five characters can be a combination of upper- or lower-case letters from A to Z, numerals, and an underscore “_”. There can be no space in the folder name. Also, folder names cannot have the same three-digit number such as “100ABC_D” and “100W_XYZ” even if the letters are different.

MENU Changing the File Name

The file name has four alphanumeric characters followed by a four-digit image number (p.88) and extension. The first four alphanumeric characters are set upon factory shipment and unique to the camera. However, you can change it.

(Ex.) BE3B0001.JPG

With "User setting1," you can change and register the four characters as desired. With "User setting2," if you register three characters, the fourth character from the left will be appended automatically to indicate the image size.

Registering or Changing the File Name



1 Select [File name setting].

- Under the [] tab, select [File name setting], then press <SET>.

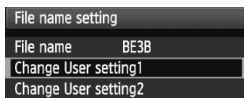

2 Select [Change User setting].

- Turn the < > dial to select [Change User setting*], then press <SET>.

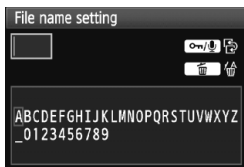

3 Enter any alphanumeric characters.

- For User setting1, enter four characters. For User setting2, enter three characters.
- Press the < > button to delete any unnecessary characters.
- Press the < > button, and the text palette will be highlighted in a color frame and text can be entered.
- Operate the < > dial or < > to move the and select the desired character. Then press <SET> to enter it.

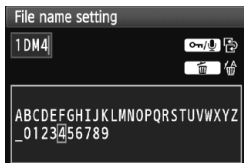

4 Exit the setting.

- Enter the required number of alphanumeric characters, then press the <MENU> button.
- ▶ The new file name will be registered and the screen in step 2 will reappear.



Settings

5 Select the registered file name.

- Turn the <DIAL> dial to select [File name], then press <SET>.
- Turn the <DIAL> dial to select the registered file name, then press <SET>.
- If User setting2 has been registered, select "****" (the 3 characters registered) + image size".



About User setting2

When you select the "**** + image size" registered with User setting2 and take pictures, the image size character will be automatically appended as the file name's fourth character from the left. The meaning of the image size characters is as follows:

"**** L" = L, RAW

"****M" = M1, M RAW

"**** N" = M2

"****S" = S, S RAW

When the image is transferred to a personal computer, the automatically appended fourth character will be included. You can then see the image size without having to open the image. The image type (RAW or JPEG) can be distinguished with the extension.



- The first character cannot be an underscore "_".
- The extension will be ".JPG" for JPEG images, ".CR2" for RAW images, and ".MOV" for movies.
- When you shoot a movie with User setting2, the file name's fourth character will be an underscore "_".

MENU File Numbering Methods

The four-digit file number is like the frame number on a roll of film. The captured images are assigned a sequential file number from 0001 to 9999 and saved in one folder. You can change how the file number is assigned.

(Ex.) **BE3B0001.JPG**

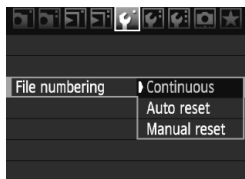

1 Select [File numbering].

- Under the [F] tab, select [File numbering], then press <SET>.

2 Select the file numbering method.

- Turn the <DIAL> to select the desired method, then press <SET>.

Continuous

Continues the file numbering sequence even after the card is replaced or a new folder is created.

Even after you replace the card, create a folder, or switch the target card (such as [1] → [2]), the file numbering continues in sequence up to 9999 for the images saved. This is convenient when you want to save images numbered anywhere between 0001 to 9999 in multiple cards or folders into one folder in your personal computer.

If the replacement card or existing folder already contains images recorded previously, the file numbering of the new images might continue from the file numbering of the existing images in the card or folder. If you want to use continuous file numbering, you should use a newly-formatted card each time.

File numbering after replacing the card

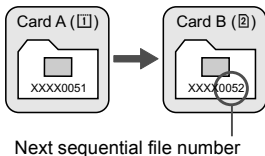

File numbering after creating a folder

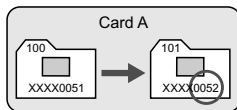

Auto Reset

The file numbering restarts from 0001 each time the card is replaced or a new folder is created.

Even after you replace the card, create a folder, or switch the target card (such as ① → ②), the file numbering continues in sequence from 0001 for the images saved. This is convenient if you want to organize images according to cards or folders.

If the replacement card or existing folder already contains images recorded previously, the file numbering of the new images might continue from the file numbering of the existing images in the card or folder. If you want to save images with the file numbering starting from 0001, use a newly formatted card each time.

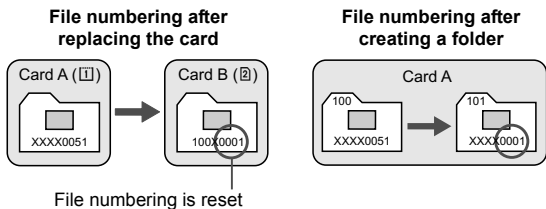

Manual Reset

To reset the file numbering to 0001 or to start from file number 0001 in a new folder.

When you reset the file numbering manually, a new folder is created automatically and the file numbering of images saved to that folder starts from 0001.

This is convenient if you want to use different folders for the images taken yesterday and the ones taken today, for example. After the manual reset, the file numbering returns to continuous or auto reset.

 If the file number in folder No. 999 reaches 9999, shooting will not be possible even if the card still has storage capacity. The LCD monitor will display a message to replace the card. Replace it with a new card.

MENU Setting Copyright Information

When you set the copyright information, it will be appended to the image as Exif information. You can check the entered copyright information with the camera.



1 Select [Copyright information].

- Under the [] tab, select [Copyright information], then press <SET>.



2 Select the desired option.

- Turn the <DIAL> dial, select either [Enter author's name] or [Enter copyright details], then press <SET>.



3 Enter text.

- Press the <COPY/DELETE> button, and the text palette will be highlighted in a color frame. Text can be entered.
- Operate the <DIAL> dial or <DIRECTIONAL> to move the and select the desired character. Then press <SET> to enter it.
- You can enter up to 63 characters.
- To delete a character, press the <DELETE> button.

4 Exit the setting.

- After entering the text, press the <MENU> button.
- ▶ The name will be saved and the screen will return to step 2.

Checking the Copyright Information

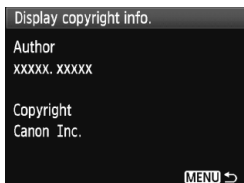

When you select [**Display copyright info.**] in step 2 on the preceding page, you can check the [**Author**] and [**Copyright**] information that you entered.

Deleting the Copyright Information

When you select [**Delete copyright information**] in step 2 on the preceding page, you can delete the [**Author**] and [**Copyright**] information.



You can also enter the copyright information with EOS Utility (provided software).

MENU Setting the Color Space

The color space refers to the range of reproducible colors. With this camera, you can set the color space for captured images to sRGB or Adobe RGB. For normal shooting, sRGB is recommended.

1 Select [Color space].

- Under the [CAMERA] tab, select [Color space], then press <SET>.

2 Set the desired color space.

- Select [sRGB] or [Adobe RGB], then press <SET>.

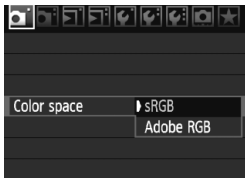

About Adobe RGB

This color space is mainly used for commercial printing and other industrial uses. This setting is not recommended if you do not know about image processing, Adobe RGB, and Design rule for Camera File System 2.0 (Exif 2.21). The image will look very subdued in a sRGB personal computer environment and with printers not compatible with Design rule for Camera File System 2.0 (Exif 2.21). Post-processing of the image with software will therefore be required.

- If the captured still photo was shot in the Adobe RGB color space, the first character in the file name will be an underscore “_”.
- The ICC profile is not appended. See explanations about ICC profile in the PDF Software Instruction Manual on the CD-ROM.

3

Setting the AF and Drive Modes

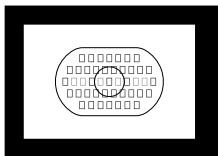

The Area AF frame has 45 AF points (39 high-precision cross-type points and 6 AF points). You can select any one of the 45 AF points to match your composition.

You can also select the AF mode and drive mode best matching the shooting conditions and subject.



<AF> stands for auto focus. <MF> stands for manual focus.

AF: Selecting the AF Mode

Select the AF mode suiting the shooting conditions or subject.

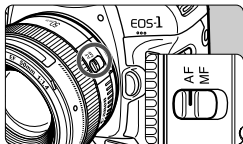

- 1 On the lens, set the focus mode switch to <AF>.

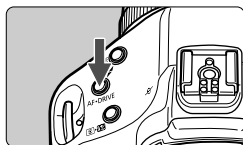

- 2 Press the <AF-DRIVE> button.
()

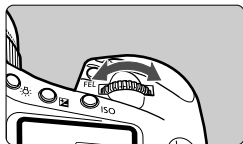

- 3 Select the AF mode.

- While looking at the top LCD panel, turn the < dial.

ONE SHOT : One-Shot AF
AI SERVO : AI Servo AF



One-Shot AF for Still Subjects



AF point
Focus confirmation light

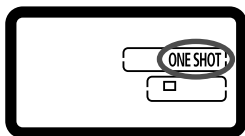

Suited for still subjects. When you press the shutter button halfway, the camera will focus only once.

- When focus is achieved, the AF point which achieved focus will flash in red, and the focus confirmation light <●> in the viewfinder will also light.
- With evaluative metering, the exposure setting will be set at the same time focus is achieved.
- While you hold down the shutter button halfway, the focus will be locked. You can then recompose the shot if desired.
- AF is also possible by pressing the <AF-ON> button.



- If focus cannot be achieved, the focus confirmation light <●> in the viewfinder will blink. If this occurs, a picture cannot be taken even if the shutter button is pressed completely. Recompose the picture and try to focus again. Or see “When Autofocus Fails” (p.100).
- If the [Beep] menu is set to [Off], the beeper will not sound when focus is achieved (p.52).



Focus Lock

After achieving focus with One-Shot AF, you can lock the focus on a subject and recompose the shot. This is called “focus lock.” This is convenient when you want to focus a subject not covered by the Area AF frame.

AI Servo AF for Moving Subjects



This AF mode is for moving subjects when the focusing distance keeps changing. While you hold down the shutter button halfway, the subject will be focused continuously.

- The exposure is set at the moment the picture is taken.
- AF is also possible by pressing the <AF-ON> button.

Focus Tracking with AI Servo AF

If the subject approaches or retreats from the camera at a constant rate, the camera tracks the subject and predicts the focusing distance immediately before the picture is taken. This is for obtaining correct focus at the moment of exposure.





- When the AF point selection is automatic (p.97), the camera first uses the center AF point to focus. During autofocusing, if the subject moves away from the center AF point, focus tracking continues as long as the subject is covered by the Area AF frame.
- With a manually selected AF point, the selected AF point will focus track the subject.

 With AI Servo AF, the beeper will not sound even when focus is achieved. Also, the focus confirmation light <●> in the viewfinder will not light.

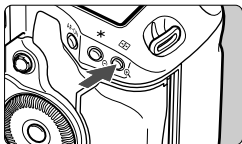
Selecting the AF Point

Select one of the 45 AF points to autofocus. **Manual selection enables you to select one of the 45 AF points. And automatic selection has the camera automatically select one of the 45 AF points.**



- 1 Press the  button. (⊕6)**
 - ▶ The current AF point will be displayed in the viewfinder.
- 2 Select the AF point.**
 - Use  or turn the  or  dial.

Automatic selection:  AF



Manual selection : SEL  (Center)
SEL AF (Off center)

 When the EF 70-200mm f/2.8L USM is used with an Extender, use the center AF point only. The other AF points may cause a focusing error.

 When switching to a vertical AF point, two AF points might light up. In such a case, shooting will proceed with the two AF points automatically selected. With two AF points selected, when you switch to a left or right AF point, only one AF point will be selected.

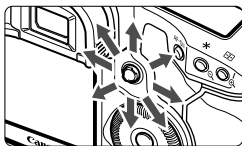
Selecting with the Multi-controller



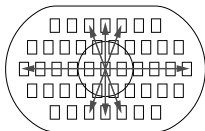

- The AF point selection will change in the direction you tilt the .
- Pressing  straight down selects the center AF point. Pressing it straight down again sets it to automatic AF point selection.
- If all the peripheral AF points light up, automatic AF point selection will take effect.



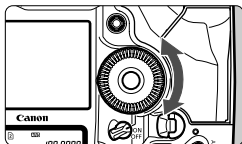
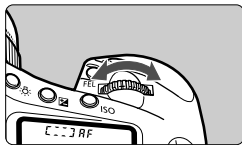

Selecting with the Dial

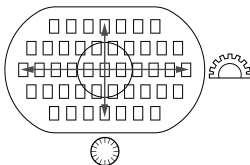

- To select a horizontal AF point, turn the <  > dial.
- To select a vertical AF point, turn the <  > dial.
- If all the peripheral AF points light up, automatic AF point selection will take effect.



- With [ **C.Fn III -10: Selectable AF point**], the selectable AF points can be limited to 19 or 11 AF points or to the inner or outer 9 AF points (p.223).
- With [ **C.Fn III -8: AF expansion w/selected pt**], you can change the AF expansion to the left/right AF points, surrounding AF points, or all 45 AF points (p.222).
- If you use a super telephoto lens equipped with an Image Stabilizer and AF stop button, when [ **C.Fn III -6: Lens AF stop button function**] is set to [**7: Spot AF**], spot AF will be possible (p.220).
- By registering the AF point you use frequently, you can switch to it instantly by setting C.Fn III -11-1/2 (p.224) or C.Fn III -6-6 (p.220).
- If focus cannot be achieved with the external, EOS-dedicated Speedlite's AF-assist beam, select the center AF point.

Lens' Maximum Aperture and AF Sensitivity

With the EOS-1D Mark IV, higher precision AF is possible with a maximum aperture brighter than f/2.8 on a lens or when combined with an Extender.

Maximum f/stop: Up to f/2.8

[Manual selection]

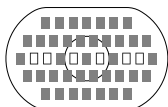

With the 39 AF points indicated by ■, high-precision, cross-type AF (both horizontal- and vertical-line sensitive) is possible during manual AF point selection. The cross-type sensors' vertical-line sensitivity is approx. two times higher than their horizontal-line sensitivity. The remaining six AF points will be horizontal-line sensitive.

[Automatic selection]

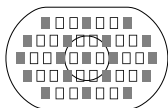

During automatic AF point selection, the number of cross-type AF points will decrease from 39 points to the 19 points indicated with ■. The remaining 26 AF points will be horizontal-line sensitive.

Maximum f/stop: f/4

High-precision, cross-type AF with the center AF point is possible. The remaining 44 AF points will be horizontal-line sensitive only.

Maximum f/stop: f/5.6 or f/8

With f/5.6 lenses, all the AF points will be horizontal-line sensitive only. With f/8 lenses, AF will be possible with the center AF point being horizontal-line sensitive only. AF will not work with the other AF points.



- In the case of zoom lenses whose maximum aperture varies depending on the lens focal length, the AF points will be horizontal-line sensitive only (They will not work as cross-type points). However, with the EF 28-80mm f/2.8-4L USM lens, cross-type AF will work with the center AF point.
- With the EF 24mm f/2.8 or EF 28mm f/2.8 lens, the three AF points on the extreme left and right of the Area AF frame will be horizontal-line sensitive (They will not work as cross-type points).



The following lenses and lens combinations have a maximum aperture of f/4, but cross-type focusing on 39 AF points is still possible as with lenses having an f/2.8 maximum aperture.

- EF 17-40mm f/4L USM, EF 24-105mm f/4L IS USM,
- EF 70-200mm f/2.8L IS USM + Extender EF 1.4X II,
- EF 200mm f/2L IS USM + Extender EF 2X II,
- EF 300mm f/2.8L IS USM + Extender EF 1.4X II,
- EF 400mm f/2.8L IS USM + Extender EF 1.4X II

When Autofocus Fails

Autofocus can fail to achieve focus (the focus confirmation light <●> blinks) with certain subjects such as the following:

Subjects difficult to focus

- Very low-contrast subjects
(Example: Blue sky, solid-color walls, etc.)
- Subjects in very low light
- Extremely backlit or reflective subjects
(Example: Car with a highly reflective body, etc.)
- Near and far subjects covered by an AF point
(Example: Animal in a cage, etc.)
- Repetitive patterns
(Example: Skyscraper windows, computer keyboards, etc.)

In such cases, do one of the following:

- (1) With One-Shot AF (p.95), focus an object at the same distance as the subject and lock the focus before recomposing.
- (2) Set the lens focus mode switch to <MF> and focus manually.

MF: Manual Focusing

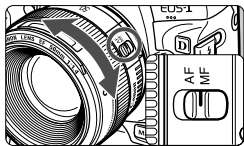

1 Set the lens focus mode switch to <MF>.

2 Focus the subject.

- Focus by turning the lens focusing ring until the subject looks sharp in the viewfinder.

 During automatic AF point selection (p.97), if you hold down the shutter button halfway and focus manually, the focus confirmation light <●> will light when the center AF point achieves focus.

DRIVE: Selecting the Drive Mode

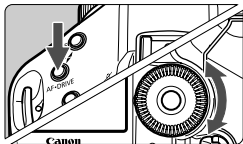

1 Press the <AF•DRIVE> button.
()

2 Select the drive mode.

- While looking at the top LCD panel, turn the  dial.

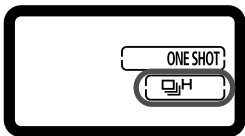



 : **Single shooting**

When you press the shutter button completely, one shot will be taken.

H : **High-speed continuous shooting** (Max. 10 shots per sec.)

L : **Low-speed continuous shooting** (Max. 3 shots per sec.)

In the H and L modes, the camera will shoot continuously while you hold down the shutter button completely.

¹⁰ : **10-sec. self-timer**





₂ : **2-sec. self-timer**

See the next page for the self-timer operation procedure.

S : **Silent single shooting**

The shooting sound for single shooting is quieter than <>. The internal mechanical operation is not executed until you return the shutter button to its halfway position.





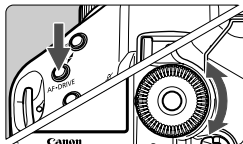

- When the battery level is low, the drive mode icon <H/L/> will blink. If the <H> icon blinks, the continuous shooting speed will decrease slightly.
- In the AI Servo AF mode, the continuous shooting speed may become slightly slower depending on the subject and the lens used.

Using the Self-timer



1 Press the <AF•DRIVE> button.
()

2 Select either <¹⁰> or <₂>.

- Look at the top LCD panel and turn the  dial to select <¹⁰> or <₂>.

 ¹⁰ : 10-sec. self-timer

 ₂ : 2-sec. self-timer

3 Take the picture.

- Look through the viewfinder, focus the subject, then press the shutter button completely.
 - ▶ The self-timer lamp will blink, and 10 sec. or 2 sec. later, the picture will be taken.
 - ▶ The top LCD panel counts down the seconds until the picture is taken.
 - ▶ The lamp's blinking will become faster two seconds before the picture is taken.

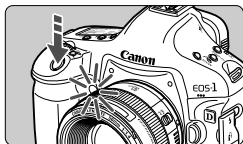

- If you will not look through the viewfinder when you press the shutter button, close the eyepiece shutter before shooting (p.117). If stray light enters the viewfinder when the picture is taken, it may throw off the exposure.
- Do not stand in front of the camera when you press the shutter button to start the self-timer. Doing so prevents the camera from focusing the subject.

- Use a tripod when using the self-timer.
- The <₂> 2-sec. self-timer enables you to shoot while not touching the camera mounted on a tripod. This prevents camera shake while you shoot still lifes or bulb exposures.
- To cancel the self-timer after it starts, set the power switch to <OFF>.
- When using the self-timer for self-portraits, use focus lock for an object at about the same distance as where you will be (p.95).
- After taking self-timer shots, you should check the image for proper focus and exposure (p.156).

4

Exposure Control

Select the shooting mode to suit the subject or shooting objective. You can set the shutter speed and/or aperture to obtain the exposure you want.

Also, with an EX-series Speedlite, you can take flash pictures as easily as shooting without flash.



First set the power switch to <J>.

Selecting the Metering Mode

You can select one of four methods to measure the subject brightness.

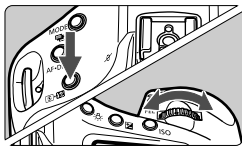

1 Press the   button. (Ⓞ6)

2 Select the metering mode.

- While looking at the top LCD panel, turn the  dial.

: Evaluative metering

: Partial metering

: Spot metering

: Center-weighted average metering

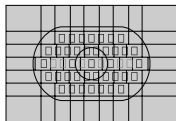
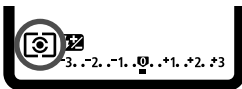

Evaluative metering

This is a general-purpose metering mode suited even for backlit subjects. The camera sets the exposure automatically to suit the scene.

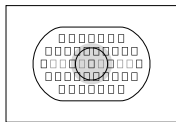

Partial metering

Effective when the background is much brighter than the subject due to backlighting, etc. The metering is weighted at the center covering approx. 13.5% of the viewfinder area.

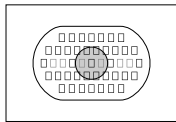

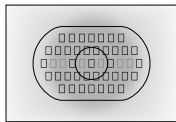

Spot metering

This is for metering a specific spot of the subject or scene. The metering is weighted at the center covering approx. 3.8% of the viewfinder area.



Center-weighted average metering

The metering is weighted at the center and then averaged for the entire scene.

 When [ C.Fn I -7: Spot meter. link to AF point] is set to [1: Enable (use active AF point)] (p.210), spot metering can be linked to the AF points.

Multi-Spot Metering

With multiple spot meter readings, you can see the relative exposure levels of multiple areas in the picture and set the exposure to obtain the desired result.

1 Set the metering mode to  spot metering.





2 Press the <FEL> button. (⌚16)

- Aim the spot metering circle over the area where you want a relative exposure reading, then press the <FEL> button.
- ▶ On the right of the viewfinder, the relative exposure level will be displayed for the spot meter reading taken. For the exposure, the average of the spot meter readings will be set.



- While referring to the exposure level indicator's three spot metering marks, you can set the exposure compensation to set the final exposure and obtain the desired result.



- You can take up to eight spot meter readings for one picture.
- The exposure setting obtained with multi-spot meter readings will be canceled in the following cases:
 - After taking the last spot meter reading, 16 seconds elapsed.
 - You pressed the <MODE>, <AF-DRIVE>, <•>, <ISO>, <•>, or <•> button.
 - After taking the picture, you let go of the shutter button.
- When [ C.Fn I-7: Spot meter. link to AF point] is set to [1: Enable (use active AF point)] (p.210), multi-spot metering is still possible.

P: Program AE

The camera automatically sets the shutter speed and aperture to suit the subject's brightness. This is called Program AE.

* <P> stands for Program.

* AE stands for Auto Exposure.

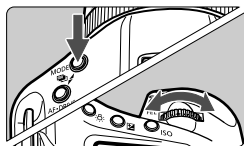

1 Set the shooting mode to <P>.

- Press the <MODE> button and turn the <MODE> dial to select <P>.



2 Focus the subject.

- Look through the viewfinder and aim the selected AF point over the subject. Then press the shutter button halfway.
 - ▶ The AF point which achieves focus flashes in red, and the focus confirmation light <●> in the viewfinder's bottom right lights. (in One-Shot AF mode)
 - ▶ The shutter speed and aperture will be set automatically and displayed in the viewfinder and on the top LCD panel.



3 Check the shutter speed and aperture display.

- A correct exposure will be obtained as long as the shutter speed and aperture display do not blink.

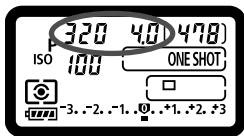

4 Take the picture.

- Compose the shot and press the shutter button completely.

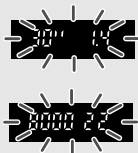

- If the “30” shutter speed and the maximum aperture blink, it indicates underexposure. Increase the ISO speed or use flash.
- If the “8000” shutter speed and the minimum aperture blink, it indicates overexposure. Lower the ISO speed or use an ND filter (sold separately) to reduce the amount of light entering the lens.



During automatic AF point selection (p.97) or manual AF point selection with expanded AF points (p.222), multiple AF points might light up simultaneously.



About Program Shift

- In the Program AE mode, you can freely change the shutter speed and aperture combination (Program) set automatically by the camera while maintaining the same exposure. This is called Program shift.
- To do this, press the shutter button down halfway, then turn the  dial until the desired shutter speed or aperture value is displayed.
- Program shift is canceled automatically after the picture is taken.
- Program shift is not possible with flash.

Tv: Shutter-Priority AE

In this mode, you set the shutter speed and the camera automatically sets the aperture to obtain the correct exposure suiting the brightness of the subject. This is called shutter-priority AE. A faster shutter speed can freeze the action or moving subject. Or a slower shutter speed can create a blurred effect, giving the impression of motion.

* <Tv> stands for Time value.





Blurred motion
(Slow shutter speed)



Frozen action
(Fast shutter speed)



1 Set the shooting mode to <Tv>.

- Press the <MODE> button and turn the <  /  > dial to select <Tv>.

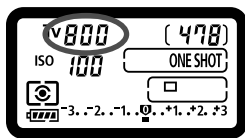

2 Set the desired shutter speed.

- While looking at the top LCD panel, turn the <  > dial.

3 Focus the subject.

- Press the shutter button halfway.
- ▶ The aperture is set automatically.



4 Check the viewfinder display and shoot.

- As long as the aperture is not blinking, the exposure will be correct.



- If the maximum aperture blinks, it indicates underexposure.

Turn the <  > dial to set a slower shutter speed until the aperture stops blinking or set a higher ISO speed.



- If the minimum aperture blinks, it indicates overexposure.

Turn the <  > dial to set a faster shutter speed until the aperture stops blinking or set a lower ISO speed.



Shutter Speed Display

The shutter speeds from “8000” to “4” indicate the denominator of the fractional shutter speed. For example, “125” indicates 1/125 sec. Also, “0”5” indicates 0.5 sec. and “15”” is 15 sec.

Av: Aperture-Priority AE

In this mode, you set the desired aperture and the camera sets the shutter speed automatically to obtain the correct exposure suiting the subject brightness. This is called aperture-priority AE. A higher $f/$ number (smaller aperture hole) will make more of the foreground and background fall within acceptable focus. On the other hand, a lower $f/$ number (larger aperture hole) will make less of the foreground and background fall within acceptable focus.

* <Av> stands for Aperture value (aperture opening).



Blurred background
(With a large aperture opening)



Sharp foreground and background
(With a small aperture opening)



1 Set the shooting mode to <Av>.

- Press the <MODE> button and turn the <MODE> dial to select <Av>.

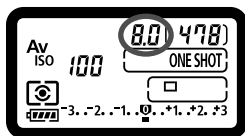

2 Set the desired aperture.

- While looking at the top LCD panel, turn the <APERTURE> dial.

3 Focus the subject.

- Press the shutter button halfway.
- ▶ The shutter speed is set automatically.



4 Check the viewfinder display and shoot.

- As long as the shutter speed is not blinking, the exposure will be correct.



- If the “30” shutter speed blinks, it indicates underexposure. Turn the dial to set a larger aperture (lower f/number) until the shutter speed blinking stops or set a higher ISO speed.



- If the “8000” shutter speed blinks, it indicates overexposure. Turn the dial to set a smaller aperture (higher f/number) until the shutter speed blinking stops or set a lower ISO speed.



Aperture Display

The higher the f/number, the smaller the aperture opening will be. The apertures displayed will differ depending on the lens. If no lens is attached to the camera, “00” will be displayed for the aperture.

Depth-of-Field Preview

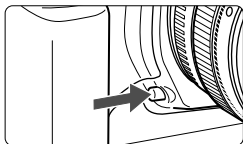

Press the depth-of-field preview button to stop down the lens to the current aperture setting. You can check the depth of field (range of acceptable focus) through the viewfinder.



- A higher f/number will make more of the foreground and background fall within acceptable focus. However, the viewfinder will look darker.
- If the depth of field is difficult to discern, hold down the depth-of-field preview button while turning the dial. The depth of field can be clearly seen with the Live View image (p.126).
- The exposure will be locked (AE lock) while the depth-of-field preview button is pressed.

M: Manual Exposure

In this mode, you set both the shutter speed and aperture as desired. To determine the exposure, refer to the exposure level indicator in the viewfinder or use a commercially-available exposure meter. This method is called manual exposure.

* <M> stands for Manual.



1 Set the shooting mode to <M>.

- Press the <MODE> button and turn the <☀️/🕒> dial to select <M>.

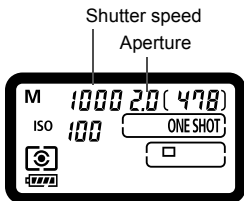

2 Set the shutter speed and aperture.

- To set the shutter speed, turn the <☀️> dial while looking at the top LCD panel.
- To set the aperture, set the power switch to <J> and turn the <🕒> dial while looking at the top LCD panel.
- You can also set it by pressing the <📷> button, then turning the <☀️/🕒> dial.



3 Focus the subject.

- Press the shutter button halfway.
- ▶ The exposure setting will be displayed.
- On the right of the viewfinder, the exposure level indicator <■> indicates the current exposure level relative to the standard exposure index <▶>.



4 Set the exposure.

- Check the exposure level and set the desired shutter speed and aperture.

5 Take the picture.

⚠️ If [C.Fn II -4: Auto Lighting Optimizer] (p.81) is set to a setting other than [3: Disable], the image may still look bright even if a darker exposure has been set.

Exposure Compensation

Exposure compensation can increase (brighter) or decrease (darker) the standard exposure set by the camera.

You can set the exposure compensation up to ± 3 stops in 1/3-stop increments.

Exposure compensation can be set in the <P/Tv/Av> shooting modes.



1 Check the exposure.

- Press the shutter button halfway and check the exposure level indicator.

2 Set the exposure compensation amount.

- Set the power switch to <J>, and while looking at the viewfinder or top LCD panel, turn the <Q> dial.
- Turn the <Q> dial while pressing the shutter button halfway or within (6) after pressing the shutter button halfway.
- ▶ When exposure compensation has been set, the <Z> icon will be displayed in the viewfinder.
- To cancel exposure compensation, set the exposure level indicator <■> to the standard exposure index (<■> or <U>).

3 Take the picture.

 If [ C.Fn II -4: Auto Lighting Optimizer] (p.81) is set to a setting other than [3: Disable], the image may still look bright even if the exposure compensation is decreased.

-  ● The exposure compensation amount will remain in effect even after you set the power switch to <OFF>.
- Be careful not to turn the <Q> dial and change the exposure compensation inadvertently. To prevent this, set the power switch to <ON>.
- You can also set it by pressing the <Z> button and turning the <Q> dial.

Auto Exposure Bracketing (AEB)

By changing the shutter speed or aperture automatically, the camera brackets the exposure up to ± 3 stops in 1/3-stop increments for three successive shots. This is called AEB.

* AEB stands for Auto Exposure Bracketing.

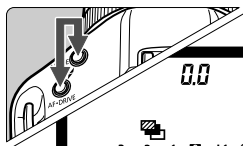

1 Hold down the <MODE> and <AF•DRIVE> buttons simultaneously. (ⓘ6)

- ▶ The <AEB icon> and “0.0” will appear on the top LCD panel.

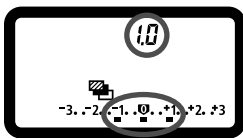

2 Set the AEB amount.

- Turn the <gear/sun icon> dial to set the AEB amount.
- “1.0” is the AEB increment, and <AEB icon> is the AEB amount.

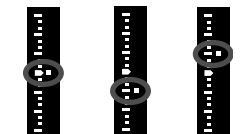

Standard exposure Decreased exposure Increased exposure

3 Take the picture.

- In the current drive mode, the pictures will be taken in this sequence: Standard exposure, decreased exposure, and increased exposure.
- After the three bracketed shots are taken, AEB will not be canceled. To cancel AEB, set the AEB increment to “0.0”.

- During AEB shooting, the <AEB icon> in the viewfinder and the <AEB icon> on the top LCD panel will blink.
- The AEB setting will be canceled automatically if the power switch is set to <OFF> or if the flash is ready.
- AEB will not work with bulb exposures nor with flash.
- If the drive mode is set to <□> or <S>, you must press the shutter button three times. If <□H> or <□L> is set and you hold down the shutter button completely, the three bracketed shots will be taken continuously. Then the camera will stop shooting. When <S¹⁰> or <S₂> is set, the three bracketed shots will be taken continuously after a 10-sec. or 2-sec. delay.
- AEB can also be combined with exposure compensation.

* AE Lock

Use AE lock when the area of focus is to be different from the exposure metering area or when you want to take multiple shots at the same exposure setting. Press the < * > button to lock the exposure, then recompose and take the shot. This is called AE lock. It is effective for backlit subjects.

1 Focus the subject.

- Press the shutter button halfway.
- ▶ The exposure setting will be displayed.

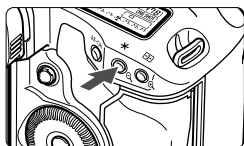

2 Press the < * > button. (ⓘ6)

- ▶ The < * > icon will light in the viewfinder and the exposure setting will be locked (AE lock).
- Each time you press the < * > button, it locks the current auto exposure setting.

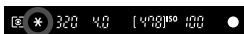

3 Recompose and take the picture.

- The exposure level indicator on the right of the viewfinder will show the AE lock exposure level and the current exposure level in real-time.
- If you want to maintain the AE lock while taking more shots, hold down the < * > button and press the shutter button to take another shot.



AE Lock Effects

Metering Mode (p.104)	AF Point Selection Method (p.97)	
	Automatic Selection	Manual Selection
*	AE lock is applied at the AF point that achieved focus.	AE lock is applied at the selected AF point.
	AE lock is applied at the center AF point.	

* When the lens' focus mode switch is set to < MF >, AE lock is applied at the center AF point.

Bulb Exposures

When bulb is set, the shutter stays open as long as you hold down the shutter button completely, and closes when you let go of the shutter button. This is called bulb exposure. Use bulb exposures for night scenes, fireworks, the heavens, and other subjects requiring long exposures.

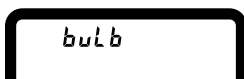

1 Set the shooting mode to <buLb>.

- Press the <MODE> button and turn the <☀️/🌙> dial to select <buLb>.



2 Set the desired aperture.

- While looking at the top LCD panel, turn the <☀️/🌙> dial.

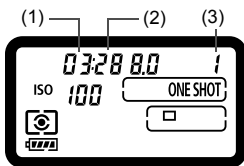

3 Take the picture.

- Press the shutter button completely.
- ▶ The elapsed exposure time will be displayed on the top LCD panel.
1: min., 2: sec., 3: hour

⚠️ Since bulb exposures produce more noise than usual, the image might look a little grainy.

- When [**C.Fn II -1: Long exp. noise reduction**] is set to [1: Auto] or [2: On], noise generated by the bulb exposure can be reduced (p.214).
- For bulb exposures, using the Remote Switch RS-80N3 or Timer Remote Controller TC-80N3 (both sold separately) is recommended.

☀️ LCD Panel Illumination

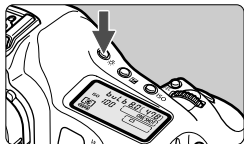

Press the <☀️> button to turn on (☀️6)/off the illumination of the top/rear LCD panel.

During a bulb exposure, pressing the shutter button completely will turn off the LCD panel illumination.

Using the Eyepiece Shutter

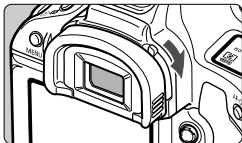

If you take a picture without looking at the viewfinder, light entering the eyepiece can throw off the exposure. To prevent this, slide the eyepiece shutter lever as shown by the arrow to shutter the eyepiece.

You need not shutter the eyepiece during Live View shooting or movie shooting.

Connecting the Remote Switch

You can connect Remote Switch RS-80N3 or Timer Remote Controller TC-80N3 (both sold separately) or any EOS accessory equipped with an N3-type terminal to the camera and shoot with it.

To operate the accessory, refer to its instruction manual.

- 1 Open the terminal cover.**
 - Open the upper terminal cover.
- 2 Connect the plug to the remote control terminal.**
 - Connect the plug as shown in the illustration.
 - To disconnect the plug, grasp the plug's silver part and pull out.

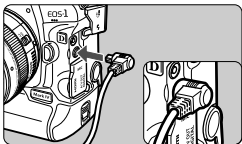

Mirror Lockup

Although using the self-timer or Remote Switch can prevent camera shake, using mirror lockup to prevent camera vibrations (mirror shock) can also help when you use a super telephoto lens or shoot close ups (macro photography).

When [C.Fn III -17: Mirror lockup] is set to [1: Enable] or [2: Enable: Down with SET] (p.226), shooting with mirror lockup is possible.



1 Focus the subject, press the shutter button completely and let go of it.

- ▶ The mirror will lockup and  will blink on the top LCD panel.

2 Press the shutter button completely again.

- ▶ The picture will be taken.
- With [1] set, the mirror will go back down when the picture is taken.
- With [2] set, the mirror lockup will remain even after the picture is taken. To cancel the mirror lockup, press .

- In very bright light such as at the beach or a ski slope on a sunny day, take the picture promptly after mirror lockup.
- During mirror lockup, do not point the camera lens at the sun. The sun's heat can scorch and damage the shutter curtains.
- If you use bulb exposures, the self-timer, and mirror lockup in combination, keep pressing the shutter button completely (self-timer delay time + bulb exposure time). If you let go of the shutter button during the self-timer countdown, there will be a shutter-release sound but no picture is actually taken.

- When [1: Enable] is set, single shooting will take effect even if the drive mode is set to continuous. When [2: Enable: Down with SET] is set, the current drive mode will take effect for the shooting.
- When the self-timer is set to  or , the picture will be taken after 10 sec. or 2 sec. respectively.
- The mirror locks up, and after 30 seconds, it will go back down automatically. Pressing the shutter button completely again locks up the mirror again.
- For mirror lockup shots, using the Remote Switch RS-80N3 or Timer Remote Controller TC-80N3 (both sold separately) is recommended.

⚡ Flash Photography

EOS-dedicated, EX-series Speedlites

An EX-series Speedlite (sold separately) makes flash photography as easy as shooting without flash.

For detailed instructions, see the EX-series Speedlite's instruction manual. This camera is a Type-A camera that can use all the features of EX-series Speedlites.

To set the flash functions and flash Custom Functions with the camera's menu, see pages 121-124.



Shoe-mount Speedlites



Macro Lites

- **FE lock**

This enables you to attain a proper flash exposure for a specific part of the subject. Aim the viewfinder center over the subject, then press the <FEL> button and take the picture.

- **Flash exposure compensation**

In the same way as normal exposure compensation, you can set exposure compensation for flash. You can set flash exposure compensation up to ± 3 stops in 1/3-stop increments.

Press the camera's <[•]> button, then turn the <[]> dial while looking at the top LCD panel or viewfinder.



If [•C.Fn II -4: Auto Lighting Optimizer] (p.81) is set to a setting other than [3: Disable], the image may still look bright even if a darker flash exposure has been set.



If the camera has difficulty autofocusing, the EOS-dedicated, external Speedlite may automatically emit the AF-assist beam.

Using Non-EX-series Canon Speedlites

- With an EZ/E/EG/ML/TL-series Speedlite set in TTL or A-TTL autoflash mode, the flash can be fired at full output only. Set the camera's shooting mode to <M> (manual exposure) or <Av> (aperture-priority AE) and adjust the aperture setting before shooting.
- When using a Speedlite which has manual flash mode, shoot in the manual flash mode.

Using Non-Canon Flash Units

Sync Speed

The camera can synchronize with compact, non-Canon flash units at 1/300 sec. or 1/250 sec. or slower. With large studio flash units, since the flash duration is longer than compact flash units, set the sync speed within 1/125 sec. to 1/30 sec. Be sure to test the flash synchronization before shooting.

PC Terminal

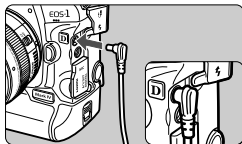

- The camera's PC terminal can be used with flash units having a sync cord. The PC terminal is threaded to prevent inadvertent disconnection.
- The camera's PC terminal has no polarity. You can connect any sync cord regardless of its polarity.

- ⚠ If the camera is used with a flash unit or flash accessory dedicated to another camera brand, the camera may not operate properly and malfunction may result.
- Do not connect to the camera's PC terminal any flash unit requiring 250 V or more.
- Do not attach a high-voltage flash unit on the camera's hot shoe. It might not fire.

 A flash unit attached to the camera's hot shoe and a flash unit connected to the PC terminal can both be used at the same time.

MENU Setting the Flash

When an EX-series Speedlite (such as the 580EX II, 430EX II, and 270EX) settable by the camera is attached, you can use the camera's menu screen to set the Speedlite's flash function settings and Custom Functions. First attach the Speedlite to the camera and turn on the Speedlite.

Setting Flash Functions

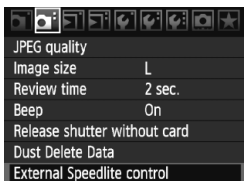

1 Select [External Speedlite control].

- Under the [] tab, select [**External Speedlite control**], then press <SET>.

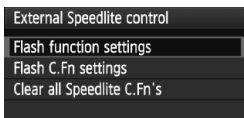

2 Select [Flash function settings].

- Turn the < > dial to select [**Flash function settings**], then press <SET>.

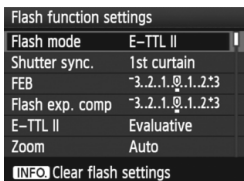

3 Set the flash function settings.

- Turn the < > dial to select a flash function and set it as desired.
- The procedure is the same as setting a menu function.



- If you press the <INFO.> button in step 3, you can revert the settings to the default.
- With an EX-series Speedlite not settable with the camera, only [**Flash exp. comp.**], [**E-TTL II**], and [**Flash firing**] are settable under [**Flash function settings**]. (Certain EX-series Speedlites also enable [**Shutter sync.**] to be set.)

Functions settable under [Flash function settings]

On the screen, the settable functions and what's displayed will differ depending on the Speedlite, current flash mode, flash Custom Function settings, etc.

To see which functions your Speedlite provides, refer to the Speedlite's instruction manual.

● Flash mode

With an external Speedlite, you can select the flash mode to suit your flash shooting.

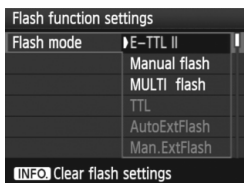

- [E-TTL II] is the standard mode of EX-series Speedlites for automatic flash shooting.
- [Manual flash] is for users who want to set the [Flash output] (1/1 to 1/128) themselves.
- [MULTI flash] is for users who want to set the [Flash output], [Frequency], and [Flash count] themselves.
- For [TTL], [AutoExtFlash], and [Man.ExtFlash], refer to the instruction manual of the Speedlites which provide the respective flash mode.

● Shutter sync.

Normally, set this to [1st curtain] so that the flash fires immediately after the exposure starts.

If [2nd curtain] is set, the flash will fire right before the shutter closes. When this is combined with a slow sync speed, you can create a trail of light such as from car headlights at night. With 2nd curtain sync, two flashes will be fired: Once when you press the shutter button completely, and once immediately before the exposure ends.

If [Hi-speed] is set, the flash can be used with all shutter speeds.

This is especially effective for portraits using fill flash when you want to give priority to the aperture setting.

- **FEB**

While the flash output is changed automatically, three flash shots are taken. For details, see the instructions for FEB (Flash Exposure Bracketing) in your Speedlite's instruction manual.

- **Flash exposure compensation**

The same setting as "Flash exposure compensation" on page 119 can be done.

- **E-TTL II**

For normal flash exposures, set it to **[Evaluative]**.

If **[Average]** is set, the flash exposure will be averaged for the entire metered scene as with an external metering flash. Since flash exposure compensation may be necessary depending on the scene, this setting is for advanced users.

- **Zoom**

You can adjust the Speedlite's flash coverage. Normally, set this to **[Auto]** so that the camera will automatically set the flash coverage to match the lens focal length.

- **Wireless setting**

Wireless flash (with multiple flash units) is possible. For details, see your Speedlite's instruction manual about wireless flash.

- **Flash firing**

To enable flash photography, set **[Enable]**. To enable only the AF-assist beam to be emitted, set **[Disable]**.



When using 2nd-curtain sync, set the shutter speed to 1/50 sec. or slower. If the shutter speed is 1/60 sec. or faster, 1st-curtain sync will be applied even if **[2nd curtain]** is set.



- If flash exposure compensation has already been set with the Speedlite, you cannot use the camera's **<[Fn]•[Flash] >** button or Flash function settings menu to set flash exposure compensation. If it is set with both the camera and Speedlite, the Speedlite's setting overrides the camera's.
- The flash function's **[E-TTL II]** setting will work together with C.Fn II -5 (p.215). And **[Flash firing]** will work with C.Fn II -7 (p.216).

Flash C.Fn Settings

1 Select [Flash C.Fn settings].

- Turn the <  > dial to select [Flash C.Fn settings], then press <  >.

2 Set the flash function.

- Turn the <  > dial to select the function number, then set the function. The procedure is the same as setting the camera's Custom Functions (p.204).

Canceling Speedlite Custom Function Settings

In step 1, select [Clear all Speedlite C.Fn's] to clear all the Speedlite's Custom Function settings (except [C.Fn -0: Distance indicator display]).

- If you use an EX-series Speedlite and the Speedlite Custom Function's [Flash metering mode] is set to [TTL], the flash will always be fired at full output.

Metered Manual Flash Exposure

This is for close-up flash photography when you want to set the flash level manually. Use an 18% gray card and an EX-series Speedlite which has manual flash mode. Follow the instructions below:

1. Set the camera and Speedlite settings.
 - Set the camera's shooting mode to < **M** > or < **Av** >.
 - Set the Speedlite to manual flash mode.
2. Focus the subject.
 - Focus manually.
3. Set up the 18% gray card.
 - Place the gray card at the subject's position.
 - In the viewfinder, the entire spot metering circle at the center should cover the gray card.
4. Press the < **FEL** > button. ( 16)
5. Set the flash exposure level.
 - Adjust the Speedlite's manual flash level and the camera aperture so that the flash exposure level aligns with the standard exposure index.
6. Take the picture.
 - Remove the gray card and take the picture.

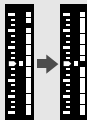

5

Live View Shooting

You can shoot while viewing the image on the camera's LCD monitor. This is called "Live View shooting."

Live View shooting is effective for still subjects which do not move.

If you handhold the camera and shoot while viewing the LCD monitor, camera shake can cause blurred images. Using a tripod is recommended.



About Remote Live View Shooting

With EOS Utility (provided software) installed in your computer, you can connect the camera to the computer and shoot remotely while viewing the computer screen. For details, see the PDF Software Instruction Manual on the CD-ROM.

📷 Preparing for Live View Shooting

This sets the camera for Live View shooting of still photos. To shoot movies, see page 141.



1 Select [Live View/Movie func. set.].

- Under the [] tab, select [Live View/Movie func. set.], then press <SET>.

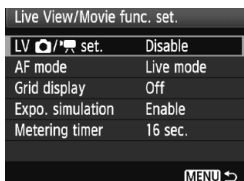

2 Select [LV / set.].

- Turn the <◉> dial to select [LV / set.], then press <SET>.
- “LV” stands for Live View.

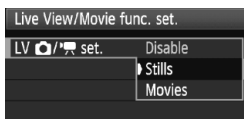

3 Select [Stills].

- Turn the <◉> dial to select [Stills], then press <SET>.

4 Exit the menu.

- Press the <MENU> button or press the shutter button halfway to turn off the menu screen.



5 Display the Live View image.

- Press <SET>.
- ▶ The Live View image will appear on the LCD monitor.
- The displayed image brightness will be close to the actual brightness of the resulting image.
- If the standard exposure has not been obtained, turn the </◉> dial.

📷 Live View Shooting

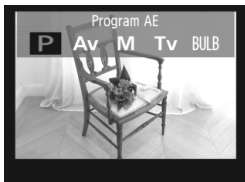

1 Select the shooting mode.

- Press the <MODE> button and turn the <🔆/🕒> dial to select the shooting mode.



2 Focus the subject.

- Before shooting, focus with AF or manual focus (p.131-138).
- When you press the shutter button halfway, the camera will focus with the current AF mode.

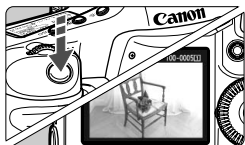

3 Take the picture.

- Press the shutter button completely.
 - ▶ The picture will be taken and the captured image is displayed on the LCD monitor.
 - ▶ After the image review ends, the camera will return to Live View shooting automatically.
- Press <SET> to end the Live View shooting.



- During Live View shooting, do not point the lens toward the sun. The sun's heat can damage the camera's internal components.
- **Cautions for using Live View shooting are on pages 139-140.**



- You can also focus by pressing the <AF-ON> button.
- The image's field of view is approx. 100%.
- When you press the shutter button completely, the shutter will sound like two shots have been taken, but only one shot will be taken. For flash shots, the reflex mirror and shutter will also make multiple sounds, but only one shot will be taken. During continuous shooting, only the first shot will make two shutter sounds.

INFO. About the Information Display

- Each time you press the <INFO.> button, the information display will change.

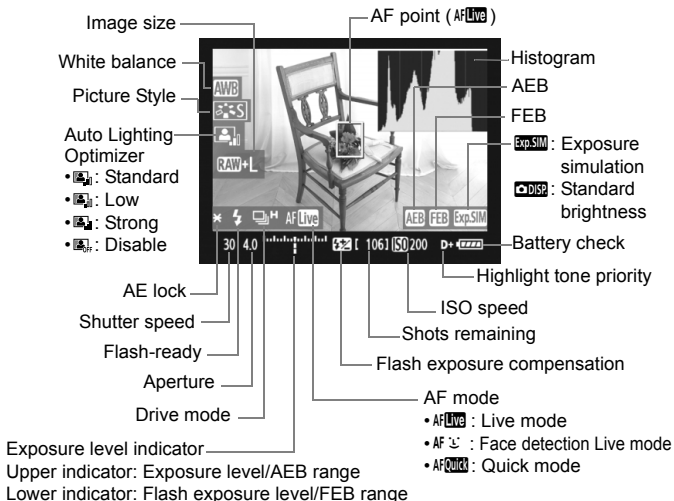

- The histogram can be displayed when [Expo. simulation: Enable] (p.130) has been set.
- By setting [C.Fn IV -15: Add aspect ratio information] to setting 1 to 6, you can shoot with the same framing as with a medium- or large-format film camera such as 6x6cm, 6x4.5cm, and 4x5 inch. Vertical lines matching the set aspect ratio will be displayed (p.234).
- When <Exp.SIM> is displayed in white, it indicates that the Live View image brightness is close to what the captured image will look like.
- If <Exp.SIM> is blinking, it indicates that the Live View image is not being displayed at the suitable brightness due to low or bright light conditions. However, the actual image recorded will reflect the exposure setting.
- If flash is used or bulb is set, the <Exp.SIM> icon and histogram will be grayed out (for your reference). The histogram might not be properly displayed in low- or bright-light conditions.

Shooting Function Settings

As with normal shooting through the viewfinder, while the Live View image is displayed, you can still use the camera buttons to change settings and playback images.



- Pressing the <MODE> <AF•DRIVE> <Fn> <ISO> <Fn> <Fn> button will display the setting screen on the LCD monitor. To change the setting, turn the <Fn> or <Fn> dial.

- When you press the <FUNC.> button, turn the <Fn> dial to set the card and turn the <Fn> dial to set the image size or white balance while looking at the rear LCD panel.
- The metering mode is fixed to evaluative metering for Live View shooting.
- Pressing the <Fn> button will lock the exposure for 16 sec.
- To check the depth of field, press the depth-of-field preview button.
- During continuous shooting, the exposure set for the first shot will also be applied to subsequent shots.

Possible Shots During Live View Shooting

Temperature	At 23°C / 73°F	At 0°C / 32°F
Possible shots	Approx. 270	Approx. 230

- The figures above are based on a fully-charged Battery Pack LP-E4 and CIPA (Camera & Imaging Products Association) testing standards.
- Continuous Live View shooting is possible for approx. 3 hr. at 23°C/73°F or 2 hr. 50 min. at 0°C/32°F (with fully-charged Battery Pack LP-E4).



- Even during the Live View image display, image playback is possible by pressing <Fn>.
- If the camera is not operated for a prolonged period, the power will turn off automatically as set with [Fn Auto power off] (p.52). If [Fn Auto power off] is set to [Off], the Live View shooting will stop automatically after approx. 30 min. (camera power remains on).
- You can also autofocus by pressing the release button halfway on Remote Switch RS-80N3 or Timer Remote Controller TC-80N3 (both sold separately).
- With the stereo AV cable (provided) or HDMI cable (sold separately), the Live View image can be displayed on a TV (p.170-171).

MENU Menu Function Settings

During the Live View display, you can still set the menu options. Live View functions are listed below.

Live View/Movie func. set.	
LV set.	Stills
AF mode	Live mode
Grid display	Off
Expo. simulation	Enable
Metering timer	16 sec.
MENU	

Under the [] tab with the [**Live View/ Movie func. set.**] screen, you can set the following functions.

- **AF mode** (p.131-137)

You can select [**Live mode**], [**Live mode**], or [**Quick mode**].

- **Grid display**

With [**Grid 1**] or [**Grid 2**], you can display grid lines. You can check the camera tilt before shooting.

- **Exposure simulation**

- **Enable** ()

The displayed image brightness will be close to the actual brightness (exposure) of the resulting image. If you set exposure compensation, the image brightness will change accordingly.

- **Disable** ()

The image is displayed at the standard brightness to make the Live View image easy to see.

- **Metering timer**

You can change how long the exposure setting is displayed (AE lock time).

If you select [**Custom WB regist.**], [**Dust Delete Data**], [**Save/load settings on media**], [**Regist/apply basic settings**], [**Sensor cleaning**], [**Clear all camera settings**], or [**Firmware Ver.**], the Live View shooting will be terminated.

Using AF to Focus

Selecting the AF Mode

The AF modes available are [**Live mode**], [**Live mode**] (face detection, p.132), and [**Quick mode**] (p.136).

If you want to achieve precise focus, set the lens focus mode switch to <MF>, magnify the image, and focus manually (p.138).



Select the AF mode.

- While the Live View image is displayed, press the <AF•DRIVE> button. (ⓘ6)
- Turn the <MODE> dial to select the AF mode.

AF Live : Live mode

AF Live (face icon) : Live mode

AF Quick : Quick mode



This can also be set with the AF mode menu option explained on the preceding page.

Live Mode: AF Live

The image sensor is used to focus. Although AF is possible with the Live View image displayed, **the AF operation will take longer than with the Quick mode**. Also, achieving focus may be more difficult than with the Quick mode.

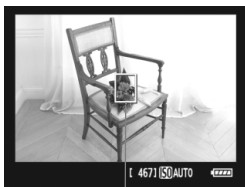

AF point

1

Move the AF point.

- Use <AF•DRIVE> to move the AF point <□> to where you want to focus. (It cannot go to the edges of the picture.)
- If you press <AF•DRIVE> straight down, the AF point will return to the image center.

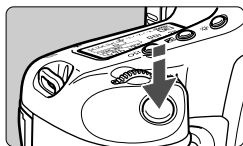

2 Focus the subject.

- Aim the AF point over the subject and press the shutter button halfway.
- ▶ When focus is achieved, the AF point will turn green and the beeper will sound.
- ▶ If focus is not achieved, the AF point will turn orange.



3 Take the picture.

- Check the focus and exposure, then press the shutter button completely to take the picture (p.127).

☺ (Face detection) Live Mode: AF ☺

With the same AF method as the Live mode, human faces are detected and focused. Have the target person face the camera.

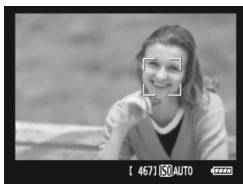

1 Point the camera toward the subject.

- When a face is detected, a <[]> frame will appear over the face to be focused.
- If multiple faces are detected, <[]> will be displayed. Use <☺> to move the <[]> frame over the target face.

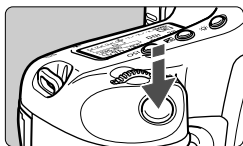

2 Focus the subject.

- Press the shutter button halfway and the camera will focus the face covered by the <[]> frame.
- ▶ When focus is achieved, the AF point will turn green and the beeper will sound.
- ▶ If focus is not achieved, the AF point will turn orange.
- If a face cannot be detected, the AF point <[]> will be displayed and AF will be executed at the center.



3 Take the picture.

- Check the focus and exposure, then press the shutter button completely to take the picture (p.127).



- If the focus is way off, face detection will not be possible. If the lens enables manual focusing even while the lens focus mode switch is set to <AF>, turn the focusing ring to attain rough focus. The face will then be detected and <[]> will be displayed.
- An object other than a human face might be detected as a face.
- Face detection will not work if the face is very small or large in the picture, too bright or too dark, titled horizontally or diagonally, or partially hidden.
- The <[]> focusing frame might cover only part of the face.



- When you press <⊕> straight down, it will switch to the Live mode (p.131). You can tilt <⊕> to move the AF point. If you press <⊕> straight down again, it will switch back to ⊗ (face detection) Live mode.
- Since AF is not possible with a face detected near the edge of the picture, the <⊕> will be grayed out. Then if you press the shutter button halfway, the center AF point <⊕> will be used to focus.

Live Mode and ⊗ (Face Detection) Live Mode Notes

AF operation

- Focusing will take slightly longer.
- Even when focus has been achieved, pressing the shutter button halfway will focus again.
- The image brightness may change during and after the AF operation.
- If the light source changes while the Live View image is displayed, the screen might flicker and focusing can be difficult. If this happens, stop the Live View shooting and autofocus under the actual light source first.
- If you press the <Ⓞ> button in the Live mode, the AF point area will be magnified. If focusing is difficult in the magnified view, return to the normal view and autofocus. Note that the AF speed may differ between the normal and magnified views.
- If you autofocus in the Live mode's normal view and then magnify the image, the focus might be off.
- If you shoot a peripheral subject and the target subject is slightly out of focus, aim the center AF point over the subject to focus, then take the picture.
- In the ⊗ Live mode, pressing the <Ⓞ> button will not magnify the image.
- The external Speedlite will not emit the AF-assist beam.

Shooting conditions which can make focusing difficult:

- Low-contrast subjects such as the blue sky and solid-color, flat surfaces.
- Subjects in low light.
- Stripes and other patterns where there is contrast only in the horizontal direction.
- Under a light source whose brightness, color, or pattern keeps changing.
- Night scenes or points of light.
- Under fluorescent lighting or when the image flickers.
- Extremely small subjects.
- Subjects at the edge of the picture.
- Subjects strongly reflecting light.
- The AF point covers both a near and faraway subject (such as an animal in a cage).
- Subjects which keep moving within the AF point and cannot keep still due to camera shake or subject blur.
- A subject approaching or moving away from the camera.
- Autofocusing while the subject is way out of focus.
- Soft focus effect is applied with a soft focus lens.
- A special effects filter is used.

Quick Mode: AFQuick

The dedicated AF sensor is used to focus in the One-Shot AF mode (p.95), using the same AF method as with viewfinder shooting. Although you can focus the target area quickly, **the Live View image will be interrupted momentarily during the AF operation.**

**1 Select the AF point.**

- Press the <AF•DRIVE> button, then use <⬤> to select the AF point.
- The AF point selection will change in the direction you tilt the <⬤>.
- Pressing <⬤> straight down selects the center AF point. Pressing it straight down again sets it to automatic AF point selection.
- If all the peripheral AF points light up, automatic AF point selection will take effect.
- If you press the <AF•DRIVE> button or when (⌚6) elapse, the AF point selected on the screen will be displayed.
(If automatic AF point selection has been set, no AF point will be displayed.)

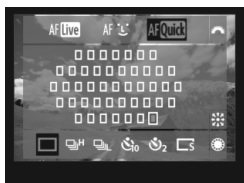

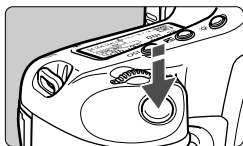

AF point



Magnifying frame

2 Focus the subject.

- Aim the AF point over the subject and press the shutter button halfway.
- ▶ The Live View image will turn off, the reflex mirror will go back down, and AF will be executed.
- ▶ When focus is achieved, the beeper will sound and the AF point will be displayed in red. (If automatic AF point selection has been set, the AF point which achieves focus will flash in red.)
- ▶ The Live View image will automatically reappear.

3 Take the picture.

- Check the focus and exposure, then press the shutter button completely to take the picture (p.127).



You cannot take a picture during autofocusing. Take the picture only while the Live View image is displayed.

Focusing Manually

You can magnify the image and focus precisely manually.

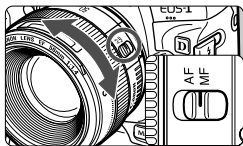

1 Set the lens focus mode switch to <MF>.

- Turn the lens focusing ring to focus roughly.



Magnifying frame

2 Move the magnifying frame.

- Use <⦿> to move the magnifying frame to the position where you want to focus.
- Pressing <⦿> straight down will return the magnifying frame to the image center.

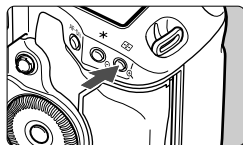

3 Magnify the image.

- Press the <Q> button.
- ▶ The image within the magnifying frame will be magnified.
- Each time you press the <Q> button, the view will change as follows:

→ 5x → 10x → Normal view →



AE lock

Magnified area position

Magnification

4 Focus manually.

- While looking at the magnified image, turn the lens focusing ring to focus.
- After achieving focus, press the <Q> button to return to the normal view.

5 Take the picture.



- Check the focus and exposure, then press the shutter button to take the picture (p.127).

Live View Shooting Cautions

Notes About the Live View Image

- Under low or bright light conditions, the Live View image might not reflect the brightness of the captured image.
- If the light source within the image changes, the screen might flicker. If this happens, stop and resume the Live View shooting under the actual light source to be used.
- If you point the camera in a different direction, it might throw off the Live View image's correct brightness momentarily. Wait until the brightness level stabilizes before shooting.
- If there is a very bright light source in the picture, such as the sun, the bright area might appear black on the LCD monitor. However, the actual captured image will correctly show the bright area.
- In low light, if you set the [ LCD brightness] to a bright setting, chrominance noise may appear in the Live View image. However, the chrominance noise will not be recorded in the captured image.
- When you magnify the image, the image sharpness may look more pronounced than it really is.

About the icon

- If Live View shooting is used under direct sunlight or in other hot environments, the  icon (warning for the camera's high internal temperature) may appear on the screen. If you continue the Live View shooting, the image quality might degrade. You should turn off the power and allow the camera to rest for a while.
- If Live View shooting continues while the  warning icon is displayed and the camera's internal temperature increases, the Live View shooting will stop automatically. Live View shooting will be disabled until the camera's internal temperature decreases.

Live View Shooting Cautions

Notes About the Shooting Results

- When you shoot with the Live View function at high ISO speeds, noise (horizontal banding, dots of light, etc.) or irregular colors may appear.
- When you shoot continuously with the Live View function for a long period, the camera's internal temperature may increase and it can degrade image quality. Terminate Live View shooting when not shooting images.
- Before taking a long exposure, stop Live View shooting temporarily and wait several minutes before shooting. This is to prevent image degradation.
- When you playback an image shot at high ISO speeds, noise or irregular colors may appear.
- If you take the picture during magnified view, the exposure might not come out as desired. Return to the normal view before taking the picture. During the magnified view, the shutter speed and aperture will be displayed in red. Even if you take the picture during magnified view, the image will be captured in the normal view.

Custom Function Notes

- During Live View shooting, certain Custom Function settings will be disabled (p.205-207).
- If [ **C.Fn II -4: Auto Lighting Optimizer**] (p.81) is set to a setting other than [**3: Disable**], the image may look bright even if manual exposure, exposure compensation, or flash exposure compensation has been set to make the exposure darker.

Notes About Lenses and Flash

- The focus preset feature on super telephoto lenses cannot be used.
- FE lock and modeling flash will not work if an external Speedlite is used.

6

Shooting Movies

The Live View image can be recorded to the card as a movie. A movie can be shot with automatic exposure or manual exposure. The movie recording format will be MOV.

Cards which can record movies

When shooting movies, use a large-capacity card with a fast writing/reading speed. The CF card's speed should be 8MB/sec. or higher. And the SD card should be rated SD Speed Class 6 "CLASS 6" or higher.

If you use a slow-writing card when shooting movies, the movie might not be recorded properly. And if you playback a movie on a card having a slow reading speed, the movie might not playback properly. To check the card's read/write speed, refer to the card manufacturer's Web site.



About Full HD 1080

Full HD 1080 indicates compatibility with High-Definition featuring 1080 vertical pixels (scanning lines).



📷 Preparing to Shoot Movies

Set the camera to record the Live View image as a movie. To shoot still photos, see page 125.

1 Select [Live View/Movie func. set.].

- Under the [📷] tab, select [Live View/Movie func. set.], then press <Ⓢ>.

Live View/Movie func. set.	
LV 📷/📷 set.	Stills
AF mode	Live mode
Grid display	Off
Expo. simulation	Enable
Metering timer	16 sec.

2 Select [LV 📷/📷 set.].

- Turn the <🕒> dial to select [LV 📷/📷 set.], then press <Ⓢ>.
- “LV” stands for Live View.

Live View/Movie func. set.	
LV 📷/📷 set.	Disable
	Stills
	▶ Movies

3 Select [Movies].

- Turn the <🕒> dial to select [Movies], then press <Ⓢ>.

	▶ 1920x1080 25
Movie rec. size	1920x1080 24
	1280x720 30
	640x480 30
	MENU ➡

4 Set [Movie rec. size].

- For details on [Movie rec. size], see page 151.

5 Exit the menu.

- Press the <MENU> button or press the shutter button halfway to turn off the menu screen.



6 Display the Live View image.

- Press <Ⓢ>.
- ▶ The Live View image will appear on the LCD monitor.
- A semi-transparent mask will appear on the top/bottom or right/left. The image area surrounded by the masking will be recorded as the movie.
- In <M> shooting mode, turn the <🕒/🕒> dial to adjust the brightness.

Shooting Movies

Autoexposure Shooting

When the shooting mode is set to a shooting mode other than **<M>**, autoexposure control will take effect to fit the scene current brightness. Autoexposure control will be the same for all shooting modes.

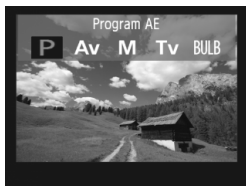

1 Set a shooting mode other than **<M>**.

- Press the **<MODE>** button and turn the **<MODE DIAL>** to select a shooting mode other than **<M>**.



2 Focus the subject.

- Before shooting a movie, focus with AF or manual focus (p.131-138).
- When you press the shutter button halfway or press the **<AF-ON>** button, the camera will focus with the current AF mode.

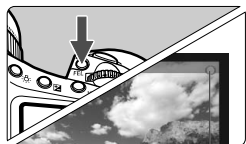

Recording movie

3 Shooting the movie.

- Press the **<FEL>** button.
- ▶ The movie shooting will begin. While the movie is being shot, the "●" mark will be displayed on the upper right of the screen.
- During the movie shooting, you can press the **<AF-ON>** button to focus again.
- To stop shooting the movie, press the **<FEL>** button again.

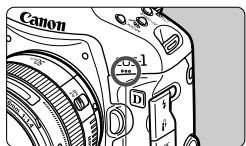

Movie microphone

- During movie shooting, you can lock the exposure (AE lock) by pressing the <★> button (p.115). After applying AE lock during movie shooting, you can cancel it by pressing the <☒> button.
- If you set the power switch to <J> and turn the <☉> dial, you can set the exposure compensation.
- The ISO speed will be set automatically within ISO 100-12800. If the [Highest ISO speed] is set to [H1], [H2] or [H3] in [C.Fn 1-3: Set ISO speed range] (p.208), the ISO speed will be set automatically within the expanded range up to the upper limit. However, setting the [Lowest ISO speed] to [L] will not expand the ISO speed range to the lower limit. Also, even if the ISO speed range is set to a narrower range than the default, the narrower range will not take effect.
- Pressing the shutter button halfway displays the ISO speed, shutter speed, and aperture at the screen bottom. This is the exposure setting for taking a still photo (p.148). The exposure setting for movie shooting is not displayed. Note that the exposure setting for movie shooting may differ from that for still shooting.

Manual Exposure Shooting

When the shooting mode is <M>, you can manually set the ISO speed, shutter speed, and aperture for movie shooting.





- 1 **Set the shooting mode to <M>.**
 - Press the <MODE> button and turn the <☒/☉> dial to select <M>.

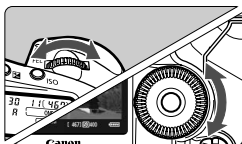

- 2 **Set the ISO speed.**
 - Press the <ISO> button and look at the screen while turning the <☒/☉> dial to set the ISO speed.
 - For details on the ISO speed, see page 146.



3 Set the shutter speed and aperture.

- Press the shutter button halfway and check the exposure level indicator.
- Turn the <  > dial to set the shutter speed within 1/30 (1/60) sec. to 1/4000 sec.
- If you set the power switch to < J > and turn the <  > dial, you can set the aperture.



4 Focus and shoot the movie.

- The procedure is the same as steps 2 and 3 for “Autoexposure Shooting” (p.143).



- With manual exposure shooting, AE lock and exposure compensation cannot be set.
- Changing the aperture during movie shooting is not recommended since variations in the exposure, due to the drive of the lens aperture, will be recorded.
- If < AWB > is set and the ISO speed or aperture changes during movie shooting, the white balance may also change.
- If you shoot a movie under fluorescent lighting, the movie image might flicker.



- The shutter speed's lower limit will change depending on the frame rate (p.151).
- When shooting a movie of a moving subject, a shutter speed of 1/30 sec. to 1/125 sec. is recommended. The faster the shutter speed, the less smooth the subject's movement will look.

About the ISO speed during manual exposure

- The ISO speed can be set to **[AUTO] (A)** or within ISO 100-12800 in 1/3-stop increments.
- If the ISO speed is set to **[AUTO] (A)**, the ISO speed will be set automatically within ISO 100-12800. (The **[C.Fn I -3: Set ISO speed range]** (p.208) setting will not take effect.) Movie shooting as in aperture-priority AE mode (fixed aperture, standard exposure) is then possible.
- If **[Highest ISO speed]** is set to **[H1]** (ISO 25600), **[H2]** (ISO 51200), or **[H3]** (ISO 102400) in **[C.Fn I -3: Set ISO speed range]**, the ISO speed can be set manually within the expanded range up to the upper limit. Also, if the ISO speed range has been set to a narrower range than the default, you can set the ISO speed within the narrower range.
- Even if **[Lowest ISO speed]** has been set to **[L]** (ISO 50) in **[C.Fn I -3: Set ISO speed range]**, **[L]** cannot be selected when you set the ISO speed.
- If **[C.Fn II -3: Highlight tone priority]** (p.215) is set to **[1: Enable]**, the settable ISO speed range will start from ISO 200.

Notes for autoexposure and manual exposure shooting



- The camera cannot autofocus continuously like a camcorder.
- During movie shooting, do not point the lens toward the sun. The sun's heat can damage the camera's internal components.
- Even if the [**F** Record func+media/folder sel.] menu option has been set to [Rec. separately] or [Rec. to multiple] (p.57), a movie cannot be recorded simultaneously to both the CF card <[1]> and SD card <[2]>. If [Rec. separately] or [Rec. to multiple] has been set, the movie will be recorded to the card which has been set for [Playback].
- **Cautions for movie shooting are on pages 153 and 154.**
- **If necessary, also read the Live View shooting cautions on pages 139 and 140.**
- Movies cannot be encrypted with Original Data Security Kit OSK-E3.



- A single movie file will be recorded for each movie shot.
- During movie shooting, the top, bottom, left, and right parts of the screen will have a semi-transparent mask. The movie will be recorded in the area surrounded by the mask. The semi-transparent mask size will change depending on the [Movie rec. size] setting (p.151).
- The sound is recorded in monaural by the camera's built-in microphone (p.143).
- Stereo sound recording is possible by connecting an external microphone equipped with a stereo mini plug (3.5mm dia.) to the camera's external microphone IN terminal (p.19). Do not connect the camera's external microphone IN terminal to anything other than an external microphone.
- The sound recording level will be adjusted automatically.
- If you playback the movie with "Shooting information display" (p.156), the shooting mode, shutter speed, and aperture will not be displayed. The image information (Exif) will record the settings used at the start of the movie.
- With a fully-charged Battery Pack LP-E4, the total movie recording time will be as follows: At 23°C/73°F: Approx. 2 hr. 40 min., At 0°C/32°F: Approx. 2 hr. 20 min.
- With ZoomBrowser EX/ImageBrowser (provided software), you can extract a still photo from the movie. The still photo quality will be as follows: Approx. 2.07 megapixels at [1920x1080], approx. 920,000 pixels at [1280x720], and approx. 310,000 pixels at [640x480].

INFO. About the Information Display

- Each time you press the <INFO.> button, the information display will change.

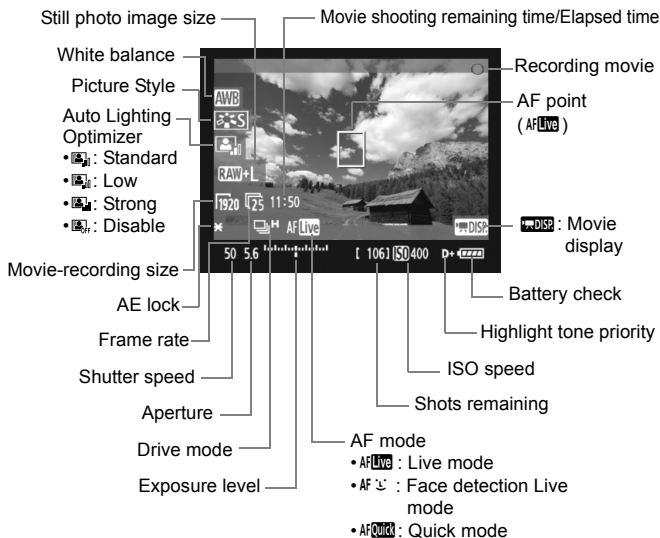

- If there is no card in the camera, the movie shooting remaining time will be displayed in red.
- When movie shooting starts, the movie shooting remaining time will change to the elapsed time.

Taking Still Photos During Movie Shooting

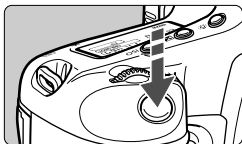

You can take a still photo at anytime by pressing the shutter button completely, even during movie shooting.

- The still photo will record the entire screen including the semi-transparent mask.
 - The still photo will be taken at the exposure setting displayed when you press the shutter button halfway. If a still photo is shot during movie shooting in manual exposure mode, the still photo will be taken with the exposure setting set for the movie.
 - The still photo will be taken at the image size, JPEG compression rate, and Picture Style that have been set.
 - If you take a still photo during movie shooting, the movie will have a still moment lasting approx. 1 sec. The still photo will be recorded to the card, and the movie shooting will resume automatically when the Live View image is displayed.
 - The movie and still photo will be recorded to the card as separate files. If you use continuous shooting, the captured still photos will be recorded to the card.
 - If **[Record func.]** (p.57) is set to **[Standard]** or **[Auto switch media]**, the movies and still photos will be recorded to the same card. If **[Rec. separately]** or **[Rec. to multiple]** is set, the movies will be recorded to the card set for **[Playback]**. And the still photos will be recorded at the image size set for the respective card.
-
- Any external Speedlite used will not fire.
 - AEB cannot be used.
 - Continuous still photo shooting is possible during movie shooting, but the captured images will not be displayed during the continuous shooting. Depending on the still photo's image size, number of shots during continuous shooting, card performance, etc., the movie shooting might stop automatically.

- For continuous shooting of still photos during movie shooting, using a high-speed CF card compatible with UDMA transfers is recommended. Setting a smaller image size for still photos and shooting fewer continuous still photos are also recommended.
- If the drive mode has been set to <U>¹⁰> or <U>₂> and you start shooting a movie, the drive mode will automatically change to <□> (single shooting).

Shooting Function Settings

As with normal shooting through the viewfinder, during movie shooting, you can still use the camera buttons to change function settings and execute playback.

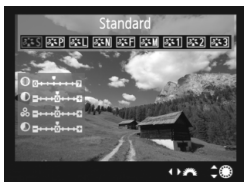



- Pressing the <MODE>, <AF•DRIVE>, <□> or <U>₂> button will display the respective setting screen on the LCD monitor. To change the setting, turn the <DIAL> or <DIAL> dial.

- When you press the <FUNC.> button, turn the <DIAL> dial to set the card to be used to record and turn the <DIAL> dial to set the image size or white balance while looking at the rear LCD panel.
- The metering mode will be fixed to center-weighted average metering for movie shooting. If the AF mode is set to [L (Face detection) Live mode], the exposure control will be evaluative metering linked to the detected face.
- Even if the AF mode has been set to [Quick mode], it will switch to [Live mode] during movie shooting.

MENU Menu Function Settings

During movie shooting, you can still set the menu options. Movie shooting functions are listed below.

Live View/Movie func. set.	
LV  set.	Movies
AF mode	Live mode
Grid display	Off
Movie rec. size	1920x1080 
Sound recording	On
Metering timer	16 sec.



Under the [>] tab with the [**Live View/Movie func. set.**] screen, you can set the following functions.

- **AF mode** (p.131-137)



You can select [**Live mode**], [ **Live mode**], or [**Quick mode**].

Note that the camera cannot focus a moving subject continuously.

- **Grid display**

With [**Grid 1** >] or [**Grid 2** >], you can display grid lines. You can check the camera tilt before shooting.

- **Movie-recording size**

You can select the movie's image size [****x****] and frame rate [>] (frames recorded per second).  (frame rate) displayed on the [**Movie rec. size**] screen switches automatically depending on the [ **Video system**] setting.



- **Image size**



[**1920x1080**] : Full HD (Full High-Definition) recording quality.

[**1280x720**] : HD (High-Definition) recording quality.





[**640x480**] : Standard recording quality. The screen format will be 4:3.

- **Frame rate** (fps: frames per second)

[>] [>] : For areas where the TV format is NTSC (North America, Japan, Korea, Mexico, etc.).

[>] [>] : For areas where the TV format is PAL (Europe, Russia, China, Australia, etc.).

[>] : Mainly for motion pictures.

* The actual frame rate (fps) will be: : 29.97, : 25.00, : 23.976, : 59.94, : 50.00

Total Movie Recording Time and File Size Per Minute (Approx.)

Movie-recording Size	Total Recording Time		File Size
	4GB Card	16GB Card	
1920x1080 [30] [25] [24]	12 min.	49 min.	330 MB/min.
1280x720 [60] [50]	12 min.	49 min.	330 MB/min.
640x480 [60] [50]	24 min.	1 hr. 39 min.	165 MB/min.

- After you start shooting a movie, the movie shooting will stop automatically if the file size reaches 4 GB or if the movie time reaches 29 min. 59 sec. To start movie shooting again, press the <FEL> button. (A new movie file starts being recorded.)
- **Sound recording**
When [On] is set, the built-in microphone will record sound in monaural. Stereo sound recording is possible by connecting an external microphone equipped with a stereo mini plug (3.5mm dia.) to the camera's external microphone IN terminal (p.19). When an external microphone is connected, the sound recording will automatically come through the external microphone. If [Off] is set, sound will not be recorded.
- **Metering timer**
You can change how long the exposure setting is displayed (AE lock time).

 If you select [☑ Custom WB regist.], [☑ Dust Delete Data], [☑ Save/load settings on media], [☑ Regist/apply basic settings], [☑ Sensor cleaning], [☑ Clear all camera settings], or [☑ Firmware Ver.], the movie shooting will stop.

Movie Shooting Cautions

Recording and Image Quality



- If the attached lens has an Image Stabilizer, the Image Stabilizer will operate at all times even if you do not press the shutter button halfway. The Image Stabilizer may cause the total movie shooting time or the number of possible shots to decrease. If you use a tripod or if the Image Stabilizer is not necessary, you should set the IS switch to <OFF>.
- The camera's built-in microphone will also pick up camera operation noise. If you use a commercially-available external microphone, you can prevent (or reduce) these noises from being recorded.
- To autofocus again during movie shooting, press the <AF-ON> button. (AF will not work by pressing the shutter button halfway.) However, autofocus during movie shooting is not recommended since it can momentarily throw the focus way off or change the exposure.
- If the card's remaining capacity is not enough for movie shooting, the movie shooting remaining time (p.148) will be displayed in red.
- If you use a card having a slow writing speed, a five-level indicator might appear on the right of the screen during movie shooting. It indicates how much data has not yet been written to the card (remaining capacity of the internal buffer memory). The slower the card, the faster the indicator will climb upward. If the indicator becomes full, movie shooting will stop automatically.
If the card has a fast writing speed, the indicator will either not appear or the level (if displayed) will hardly go upward. First, shoot a few test movies to see if the card can write fast enough.
- During movie shooting, certain Custom Function settings will be disabled (p.205-207).



Indicator

Movie Shooting Cautions

Camera's internal temperature increase and image degradation

- When you shoot movies at high ISO speeds, noise (horizontal banding, dots of light, etc.) or irregular colors may appear.
- If you continue to shoot movies for a prolonged period, the camera's internal temperature will increase. This can degrade the image quality. While not shooting, turn off the power.
- If you shoot under direct sunlight or high-temperature conditions, the  icon (high internal temperature warning) may appear on the screen. If you keep shooting a movie with the warning icon displayed, the image quality might degrade. You should turn off the power and allow the camera to rest for a while.
- If the  icon is displayed and you keep shooting movies until the camera's internal temperature increases further, the movie shooting will stop automatically. Movie shooting will be disabled until the camera's internal temperature decreases.

Playback and TV connection

- If the brightness changes greatly during movie shooting, that part might look momentarily still when you playback the movie.
- If the camera is connected to a TV set with an HDMI cable (p.171), pressing the <INFO.> button during movie shooting will not display the INFO screen.
- If you connect the camera to a TV set (p.170-171) and shoot a movie, the TV will not output any sound during the shooting. However, the sound will be properly recorded.

7

Image Playback

This chapter explains how to playback and erase photos and movies, how to view them on a TV screen, and other playback-related functions.

About images taken with another camera:

The camera might not be able to properly display images captured with a different camera or edited with a computer or whose file name or file format was changed.

▶ Image Playback

Single Image Display

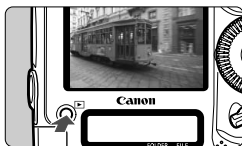

1 Playback the image.

- Press the <▶> button.
- ▶ The last captured image or last image viewed will appear.



2 Select the image.

- To playback images starting with the last image, turn the <◀> dial counterclockwise.
- To playback images starting with the first captured image, turn the dial clockwise.
- Each time you press the <INFO.> button, the display format will change.



Single image display



Single image display + Image size

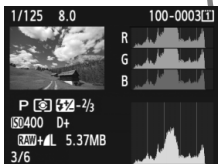

Histogram display

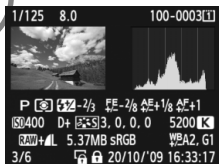

Shooting information display

3 Exit the image playback.

- Press the <▶> button to exit the image playback and return the camera to shooting ready.

INFO. Shooting Information Display

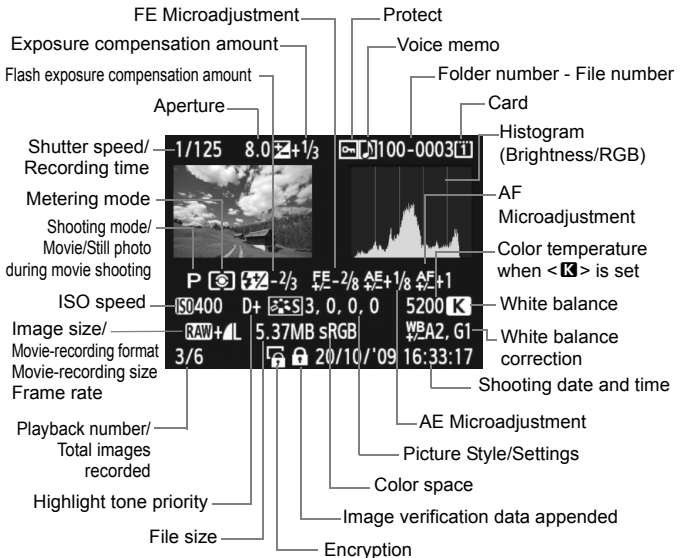

* When you shoot in RAW+JPEG image size, the JPEG image file size will be displayed.

* For movie files, the movie icon <MOV>, recording format <MOV>, recording size <1920/1280/640>, and frame rate <60/50/30/25/24> will be displayed. The shooting mode, shutter speed, and aperture will not be displayed.

* For still photos taken during movie shooting display, <P> will be displayed.

● About the Highlight Alert

When the [] **Highlight alert** menu option is set to [Enable], overexposed highlight areas will blink. To obtain more image detail in the overexposed areas, set the exposure compensation to a negative amount and shoot again.

● About the AF Point Display

When the [\square] **AF point disp.**] menu option is set to **[Enable]**, the AF point which achieved focus will be displayed in red. If automatic AF point selection was used, multiple AF points might be displayed in red.

● About the Histogram

The brightness histogram display shows the exposure level distribution and overall brightness. The RGB histogram display is for checking the color saturation and gradation. The display can be switched with the [\square] **Histogram**] menu option.

[Brightness] Display

This histogram is a graph showing the distribution of the image's brightness level. The horizontal axis indicates the brightness level (darker on the left and brighter on the right), while the vertical axis indicates how many pixels exist for each brightness level. The more pixels there are toward the left, the darker the image. And the more pixels there are toward the right, the brighter the image. If there are too many pixels on the left, the shadow detail will be lost. And if there are too many pixels on the right, the highlight detail will be lost. The gradation in-between will be reproduced. By checking the image and its brightness histogram, you can see the exposure level inclination and the overall gradation.

Sample Histograms



Dark image



Normal brightness



Bright image

[RGB] Display

This histogram is a graph showing the distribution of each primary color's brightness level in the image (RGB or red, green, and blue). The horizontal axis indicates the color's brightness level (darker on the left and brighter on the right), while the vertical axis indicates how many pixels exist for each color brightness level. The more pixels there are toward the left, the darker and less prominent the color. And the more pixels there are toward the right, the brighter and denser the color. If there are too many pixels on the left, the respective color information will be lacking. And if there are too many pixels on the right, the color will be too saturated with no detail. By checking the image's RGB histogram, you can see the color's saturation and gradation condition and white balance inclination.

▶ Searching for Images Quickly

🔍 Display Multiple Images on One Screen (Index display)

Search for images quickly with the index display showing four or nine images on one screen.



1 Turn on the index display.

- During image playback, press the <🔍> button.
- ▶ The 4-image index display will appear. The currently-selected image will be highlighted in a blue frame.
- Press the <🔍> button again to switch to the 9-image index display. Pressing the <🔍> button will toggle the display from 9 images, 4 images, and one image displayed.

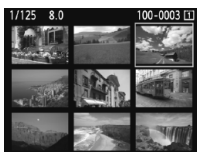
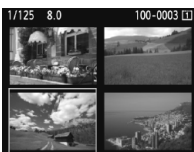

2 Select the image.

- Turn the <🌀> dial to move the blue frame to select the image.
- Press <SET> and the selected image will be displayed as a single image.

Jump through Images (Jump display)

With the single image display, you can turn the < > dial to jump through the images.





Jump method
Image location

1 Select the jump method.

- With the [] menu option, select the desired jump method from [1 image/10 images/100 images/Date/Folder/Movies/Stills], then press < >.

2 Browse by jumping.

- Press the < > button to playback the image.
- Turn the < > dial.
 - ▶ The jump display will proceed according to the selected jump method.
 - ▶ On the bottom right, the jump method and current image location are indicated.

- To search images according to the shooting date, select [**Date**]. Turn the < > dial to display the shooting date.
- To search images according to folder, select [**Folder**].
- If the card has both [**Movies**] and [**Stills**], select either one to display only movies or stills.

🔍/🔍 Magnified View

You can magnify the image by 1.5x to 10x on the LCD monitor.



Magnified area position

1 Magnify the image.

- During image playback, press the <🔍> button.
- ▶ The image will be magnified.
- If you hold down the <🔍> button, the image will continue to be magnified until it reaches the maximum magnification.
- To reduce the magnification, press the <🔍> button. If you hold down the button, the magnification will continue to reduce to the single image display.



2 Scroll around the image.

- Use <🔍> to scroll around the magnified image.
- To exit the magnified display, press the <▶> button and the single image display will return.

Magnified View's Starting Position

Normally, the magnified view starts at the image center. When the [🔍] **Enlarge display**] menu option is set to **[Enlarge from selected AF point]**, the magnified view starts at the selected AF point. This is convenient for quickly checking the focus.





- While in the magnified view, you can keep the same magnified area and magnification when you turn the <🔍> dial to view another image.
- In the case of images shot with automatic AF point selection or with manual focus <MF>, the magnification will start at the image center.
- Magnified view is not possible during the image review immediately after the image is taken.
- With **[Enlarge from selected AF point]**
 - The starting magnification varies depending on the image size that was set.
 - If C.Fn III -8-1/2/3 is set, the focusing point area will be expanded and the magnified view starts from the AF point that actually achieved focus. Therefore, the view may not be magnified from the manually-selected AF point.
- A movie cannot be magnified.

Rotating the Image

You can rotate the displayed image to the desired orientation.



1 Select [Rotate].

- Under the [] tab, select [Rotate], then press </>.







2 Select the image.

- Turn the </> dial to select the image to be rotated.
- You can also select an image on the index display.



3 Rotate the image.

- Each time you press </>, the image will rotate clockwise as follows: 90° → 270° → 0°
- To rotate another image, repeat steps 2 and 3.
- To exit and return to the menu, press the <MENU> button.

- If you have set [ **Auto rotate**] to [] (p.182) before taking vertical shots, you need not rotate the image as described above.
- If the rotated image is not displayed in the rotated orientation during image playback, set the [ **Auto rotate**] menu option to [].
- A movie cannot be rotated.

Enjoying Movies

Basically, there are the following three ways to playback the movies you shot.

Playback on a TV set (p.170, 171)

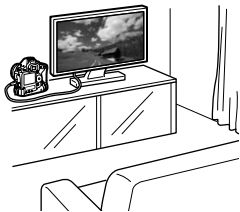

Use the provided stereo AV cable or HDMI Cable HTC-100 (sold separately) to connect the camera to a TV set. You can then playback the captured movies and photos on the TV.

If you have a High-Definition TV set and connect your camera to it with an HDMI cable, you can watch Full HD (Full High-Definition 1920x1080) and HD (High-Definition 1280x720) movies with higher image quality.



- Movies on a card can be played only by devices compatible with MOV files.
- Since hard disk recorders do not have an HDMI IN terminal, the camera cannot be connected with an HDMI cable.
- Even if the camera is connected to a hard disk recorder with a USB cable, movies and photos cannot be played nor saved.

Playback on the Camera's LCD Monitor (p.165-169)

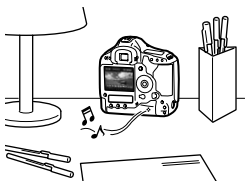

You can playback movies on the camera's LCD monitor and even edit out the first and last scenes. You can also playback the photos and movies recorded in the card as an automatic slide show.



- A movie edited with a personal computer cannot be rewritten to the card and played back with the camera.

Playback and Editing with a Personal Computer

(See the PDF file instruction manual for ZoomBrowser EX/ImageBrowser)



The movie files recorded in the card can be transferred to a personal computer and played or edited with ZoomBrowser EX/ImageBrowser (provided software). You can also extract a single frame from a movie and save it as a still photo.

- To have the movie playback smoothly on a personal computer, the personal computer must be a high-performance model. Regarding the hardware requirements for ZoomBrowser EX/ImageBrowser, see the PDF file instruction manual.
- If you want to use commercially-available software to playback or edit the movies, be sure it is compatible with MOV files. For details on commercially-available software, inquire the software maker.

▶ Playing Movies



1 Playback the image.

- Press the <▶> button to playback images.



2 Select a movie.

- Turn the <☉> dial to select an image.
- With the single-image display, the <▶ SET> icon displayed on the upper left indicates that it is a movie.
- During the index display, the perforation on the left edge of the image indicates that it is a movie. **Movies cannot be played on the index display, so press <SET> to switch to the single-image display.**



3 On the single-image display, press <SET>.

- ▶ The movie playback panel will appear on the bottom.







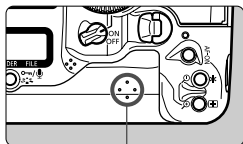





4 Playback the movie.

- Turn the <☉> dial to select [▶] (play), then press <SET>.
- ▶ The movie will start playing.
- You can pause the movie playback by pressing <SET>.
- During movie playback, you can adjust the sound volume by turning the <☉> dial.
- For more details on the playback procedure, see the next page.



Speaker

Function	Playback Description
 Exit	Returns to the single-image display.
 Play	Pressing <SET> toggles between play and stop.
 Slow motion	Adjust the slow motion speed by turning the <DIAL> dial. The slow-motion speed is indicated on the upper right.
 First frame	Displays the movie's first frame.
 Previous frame	Each time you press <SET>, a single previous frame is displayed. When you hold down <SET>, it will rewind the movie.
 Next frame	Each time you press <SET>, the movie will play frame-by-frame. When you hold down <SET>, it will fast forward the movie.
 Last frame	Displays the movie's last frame.
 Edit	Displays the editing screen (p.167).
	Playback position
mm' SS"	Playback time
 Volume	You can adjust the built-in speaker's sound volume by turning the <DIAL> dial.

- With a fully-charged Battery Pack LP-E4, the continuous playback time at 23°C/73°F will be as follows: Approx. 9 hr. 20 min.
- During the single-image display, press the <INFO.> button to switch the display format (p.156).
- If you took a still photo while you shot the movie, the still photo will be displayed for approx. 1 sec. during the movie playback.
- If you connect the camera to a TV set (p.170, 171) and playback a movie, adjust the sound volume with the TV set. Turning the <DIAL> dial will not change the sound volume.

✂ Editing the Movie's First and Last Scenes

You can edit out the first and last scenes of a movie in 1-sec. increments.



1 On the movie playback screen, select [✂].

- ▶ The editing screen will be displayed.



2 Specify the parts to be edited out.

- Select either [✂] (Cut beginning) or [✂] (Cut end), then press <SET>.
- Tilt <◀▶> to the left or right to see the previous or next frames. Holding it down will fast forward the frames. Turn the <◀▶> dial to browse frame-by-frame.
- After deciding which part to edit out, press <SET>. The portion highlighted in blue on the top of the screen is what will remain.



3 Check the editing.

- Select [▶] and press <SET> to playback the portion highlighted in blue.
- To change the editing, go back to step 2.
- To cancel the editing, select [↶] and press <SET>.



4 Save the movie.

- Select [⏏], then press <SET>.
- ▶ The save screen will appear.
- To save it as a new movie, select [New file]. Or to save it and overwrite the original movie file, select [Overwrite]. Then press <SET>.

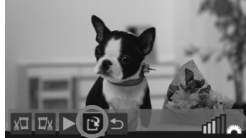

- Since the editing is done in 1-sec. increments (position indicated by [✂]), the exact position where the movie is edited may differ slightly from the position you specified.
- If the card does not have enough room, [New file] will not be selectable.
- More movie editing functions are available with ZoomBrowser EX/ImageBrowser (provided software).

MENU Slide Show (Auto Playback)

You can playback the images in the card as an automatic slide show.



1 Select [Slide show].

- Under the [] tab, select [Slide show], then press <SET>.

Number of images to be played



2 Select the images to be played back.

- Turn the <DISP> dial to select the item shown on the left, then press <SET>.

[All images/Movies/Stills]

- Turn the <DISP> dial to select one of the following: [All images/ Movies/ Stills]. Then press <SET>.

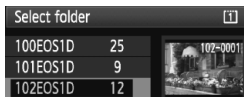

[Folder/Date]

- Turn the <DISP> dial to select either [Folder] or [Date].
- When <INFO> is highlighted, press the <INFO> button.
- Turn the <DISP> dial to select the folder or date, then press <SET>.

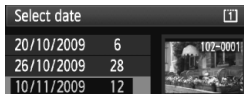

Item	Playback Description
All images	All the still photos and movies in the card will be played back.
Folder	Still photos and movies in the selected folder will be played back.
Date	Still photos and movies taken on the selected shooting date will be played back.
Movies	Only the movies in the card will be played back.
Stills	Only the still photos in the card will be played back.



3 Set the play time and repeat option.

- Turn the < > dial to select **[Set up]**, then press < >.
- For still photos, set the **[Play time]** and **[Repeat]** options, then press the < **MENU** > button.

[Play time]

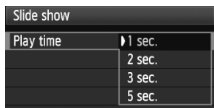

[Repeat]

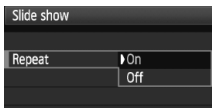

4 Start the slide show.

- Turn the < > dial to select **[Start]**, then press < >.
- ▶ After **[Loading image...]** is displayed for a few seconds, the slide show will start.

5 Quit the slide show.

- To quit the slide show and return to the setting screen, press the < **MENU** > button.



- To pause the slide show, press < >. During pause, **[||]** will be displayed on the upper left of the image. Press < > again to resume the slide show.
- During auto playback, you can press the < **INFO** > button to change the still photo display format.
- During movie playback, you can adjust the sound volume by turning the < >.
- During pause, you can turn the < > or < > dial to view another image.
- During the slide show, auto power off will not work.
- The display time may vary depending on the image.
- To view the slide show on a TV set, see pages 170-171.

Viewing the Images on TV

You can view the still photos and movies on a TV set. Before connecting or disconnecting the cable between the camera and television, turn off the camera and television.

* Adjust the movie's sound volume with the TV set. To playback movies, see page 165.

* Depending on the TV set, part of the image displayed might be cut off.

Viewing on Non-HD (High-Definition) TV Sets

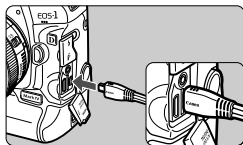

1 Connect the provided AV cable to the camera.

- Connect the stereo AV cable to the camera's <A/V OUT/DIGITAL> terminal.
- With the plug's <Canon> logo facing the front of the camera, insert it into the <A/V OUT/DIGITAL> terminal.

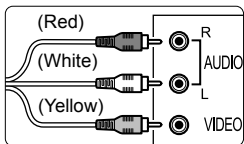

2 Connect the AV cable to the TV set.

- Connect the stereo AV cable to the TV's video IN terminal and to the audio IN terminal.

3 Turn on the TV and switch the TV's video input to select the connected port.

4 Set the camera's power switch to <ON>.

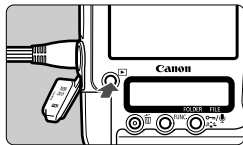

5 Press the <▶> button.

- ▶ The image will appear on the TV screen. (Nothing will be displayed on the camera's LCD monitor.)

● If the video system format does not match the TV's, the images will not be displayed properly. Set the proper video system format with [**Video system**].

- Do not use any stereo AV cable other than the one provided. Images might not be displayed if you use a different cable.

Viewing on HD (High-Definition) TV Sets

The HDMI Cable HTC-100 (sold separately) is required.

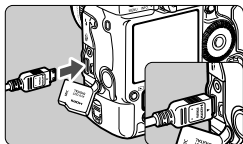

1 Connect the HDMI cable to the camera.

- Connect the HDMI cable to the camera's <HDMI OUT> terminal.
- With the plug's <▲HDMI MINI> logo facing the back of the camera, insert it into the <HDMI OUT> terminal.

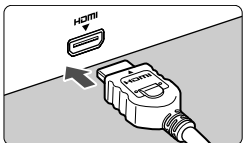

2 Connect the HDMI cable to the TV set.

- Connect the HDMI cable to the TV's HDMI IN port.

3 Turn on the TV and switch the TV's video input to select the connected port.

4 Set the camera's power switch to <ON>.

5 Press the <▶> button.

- ▶ The image will appear on the TV screen. (Nothing will be displayed on the camera's LCD monitor.)
- The images will be displayed at the TV's optimum resolution automatically.
- By pressing the <INFO.> button, you can change the display format.

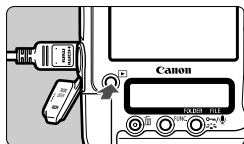

Do not connect any other device's output to the camera's <HDMI OUT> terminal. Doing so may cause a malfunction.



- Some TVs might not be able to display the captured images. In such a case, use the stereo AV cable provided.
- The camera's <A/V OUT/DIGITAL> terminal and <HDMI OUT> terminal cannot be used at the same time.

Protecting Images

Protecting the image prevents it from being erased accidentally.

Protecting a Single Image

1 Select the image to be protected.

- Press the button to playback images, then turn the dial to select an image.

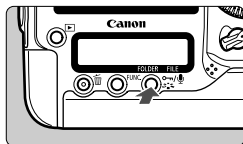

2 Protect the image.

- During image playback, press the button.
- ▶ When an image is protected, the icon will appear on the top of the screen.
- To cancel the image protection, press the button again. The icon will disappear.
- To protect another image, repeat steps 1 and 2.



MENU Protecting All Images in a Folder or Card

You can protect all the images in a folder or card at one time.



When the **Protect images** menu option is set to **[All images in folder]** or **[All images on card]**, all the images in the folder or card will be protected.

To cancel the image protection, select **[Clear all images in folder]** or **[Clear all images on card]**.



- **If you format the card (p.50), the protected images will also be erased.**
- To protect an image, press and quickly let go of the <Fn/⏏> button. If you hold down the button for approx. 2 sec., a voice memo will be recorded.



- Images can also be protected individually when the [Fn] **Protect images** menu option is set to **[Select images]**. Press <Fn/CET> to protect or unprotect the image.
- Once an image is protected, it cannot be erased by the camera's erase function. To erase a protected image, you must first cancel the protection.
- If you erase all the images (p.179), only the protected images will remain. This is convenient when you want to erase unnecessary images all at once.
- If [**C.Fn IV -9: Fn/⏏ button function**] is set to **[1: Record memo (Protect: Disabled)]** or **[2: Play memo (hold: Record memo)]**, images cannot be protected with the <Fn/⏏> button. Use the [Fn] **Protect images** menu option's **[Select images]** to protect images.

Recording and Playing Voice Memos

You can append a voice memo to a captured image. The voice memo will be saved as a WAV sound file having the same file number as the image. The sound can be played back with the camera or provided software.

Recording a Voice Memo

1 Select the image to which you want to append a voice memo.

- Press the <▶> button to playback images, then turn the <◂> dial to select the image.

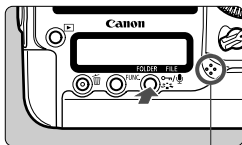

Voice memo microphone

2 Record a voice memo.

- While the image is displayed, press the <◂/▶> button for approx. 2 sec.
- When [Recording memo...] appears, keep pressing the button and speak into the microphone. The maximum recording time for a voice memo is 30 sec.
- To end the voice memo, let go of the button.
- ▶ The <[▶]> icon will be displayed on the top of the screen.



- You cannot append a voice memo to a protected image.
- You cannot append a voice memo to a movie.
- To record a voice memo longer than 30 sec., repeat step 2.
- You can also record a voice memo once, right after image capture during the image review by following step 2.
- A voice memo cannot be recorded with an external microphone.

Playing a Voice Memo

When [**C.Fn IV -9:  button function**] is set to [**2: Play memo (hold: Record memo)**] (p.231), the voice memo appended to the image can be played back.





1 Set [**C.Fn IV -9: button function**] to [**2: Play memo (hold: Record memo)**].

- Set this function while referring to page 231.
- For details on setting a Custom Function, see page 204.



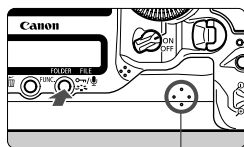

2 Select the image whose voice memo you want to playback.

- Press the  button to playback images, then turn the  dial to select an image which has the  icon displayed on the top.



Speaker

3 Playback a voice memo.

- While the image is displayed, press the  button.
- ▶ The voice memo will be played.
- Turn the  dial to adjust the sound volume.
- To stop playback, press the  button.

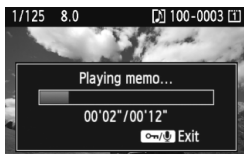

- If the image has been appended with multiple voice memos, they will be played consecutively.
- Erasing only the voice memo appended to an image is not possible with the camera.
- If the image is erased (p.179), any appended voice memo will also be erased.



Copying Images

The images recorded in a card can be copied to the other card.

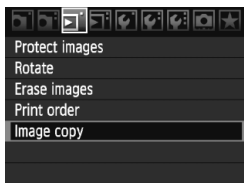
MENU Copying Individual Images



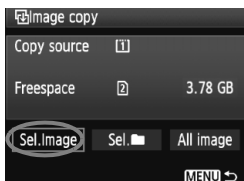

1 Select [Image copy].

- Under the [] tab, select [Image copy], then press < >.







2 Select [Sel. Image].

- Check the copy source and target card's capacity.
- Turn the < > dial to select [Sel. Image], then press < >.



3 Select the folder.

- Turn the < > dial to select the folder containing the image to be copied, then press < >.
- Refer to the images displayed on the right to help you select the desired folder.
- ▶ The images in the selected folder will be displayed.

 The copy source is the card selected by the [ **Record func+media/folder sel.**] menu option's [**Record/play**] ([**Playback**]) setting.

Total images selected



4 Select the image.

- Turn the $\langle \text{DIAL} \rangle$ dial to select the image to be copied, then press $\langle \text{SET} \rangle$.
- ▶ The $\langle \checkmark \rangle$ icon will appear on the upper left of the screen.
- Press the $\langle \text{Q} \rangle$ button to display the three-image view. To return to the single-image display, press the $\langle \text{Q} \rangle$ button.
- To select another image to be copied, repeat step 4.

5 Press the $\langle \text{COPY} \rangle$ button.

- After selecting all the images to be copied, press the $\langle \text{COPY} \rangle$ button.

6 Select [OK].

- Check the target card and press $\langle \text{SET} \rangle$.

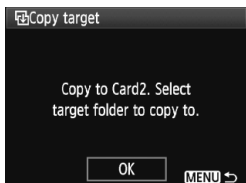

7 Select the target folder.

- Turn the $\langle \text{DIAL} \rangle$ dial to select the target folder where the images are to be copied to, then press $\langle \text{SET} \rangle$.
- To create a new folder, select [Create folder].

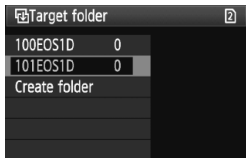

8 Select [OK].

- Check the copy source and target card's information.
- Turn the $\langle \text{DIAL} \rangle$ dial to select [OK], then press $\langle \text{SET} \rangle$.

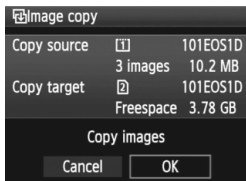

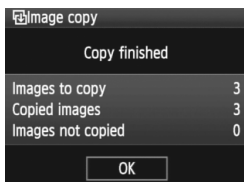

- ▶ The copying will start and the progress will be displayed. When the copying is completed, the result will be displayed. Select **[OK]** to return to the screen in step 2.

MENU Copying All Images in a Folder

In step 2, select **[Sel. ■■]**. Select the source folder to be copied, then the target folder.

MENU Copying All Images in a Card

In step 2, select **[All image]**. All the folders and images in the source card will be copied to the target card. (The folder numbers and file names will remain the same in the target folder.)

- The file name of the copied image will be the same as the source image's file name.
- If **[Sel. Image]** has been set, you cannot copy images in multiple folders at one time. Select images in each folder to copy them folder by folder.
- If an image is being copied to a target folder having the same folder number as the source folder and the target folder already has an image with the same file number, the following will be displayed: **[Skip image and continue]** **[Replace existing image]** **[Cancel copy]**. Select the copying method, then press < **(SET)** >.
 - **[Skip image and continue]:**
Any images in the source folder having the same file number as images in the target folder will be skipped and not copied.
 - **[Replace existing image]:**
Any images in the target folder having the same file number as the source images (including protected images) will be overwritten. If an image with a print order (p.201) is overwritten, you will have to set the print order again.
- The image's print order information will not be retained when the image is copied.
- Shooting is not possible during the copying operation. Select **[Cancel]** before trying to shoot.

Erasing Images

You can either select and erase images one by one or erase them in one batch. Protected images (p.172) will not be erased.

- ❗ **Once an image is erased, it cannot be recovered. Make sure you no longer need the image before erasing it. To prevent important images from being erased accidentally, protect them. Erasing a RAW+JPEG image will erase both the RAW and JPEG images.**

Erasing a Single Image

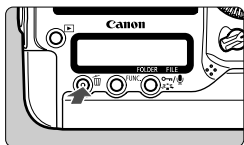



1 Playback the image to be erased.

2 Press the  button.





- ▶ The erase menu will appear at the bottom of the screen.



3 Erase the image.

- ▶ Turn the  dial to select [Erase], then press . The image displayed will be erased.

MENU Checkmarking Images to be Erased in a Batch

By checkmarking the images to be erased, you can erase multiple images at one time. With the  **Erase images** menu option, select **[Select and erase images]**. With , checkmark  the images to be erased. Then press the .

MENU Erasing All Images in a Folder or Card

You can erase all the images in a folder or card at one time. When the  **Erase images** menu option is set to **[All images in folder]** or **[All images on card]**, all the images in the folder or card will be erased.

 To also erase protected images, format the card (p.50).

Changing Image Playback Settings

MENU Adjusting the LCD Monitor Brightness

You can adjust the brightness of the LCD monitor to make it easier to read.

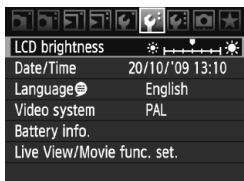

1 Select [LCD brightness].

- Under the [**☀**] tab, select [**LCD brightness**], then press < **SET** >.

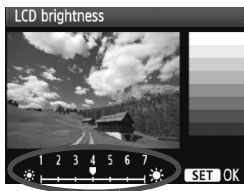

2 Adjust the brightness.

- While referring to the gray chart, turn the < **☀** > dial, then press < **SET** >.

- To check the image's exposure, looking at the histogram is recommended (p.158).
- During image playback, you can press the < **☀** > button to display the screen in step 2 and adjust the brightness.

MENU Setting the Image Review Time

You can set how long the image is displayed on the LCD monitor immediately after capture. To keep the image displayed, set **[Hold]**. To not have the image displayed, set **[Off]**.

1 Select **[Review time]**.

- Under the **[Q⁺]** tab, select **[Review time]**, then press **<SET>**.

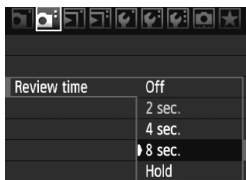
**2** Set the desired time.

- Turn the **<DIAL>** to select the option, then press **<SET>**.



If **[Hold]** is set, the image will be displayed until the auto power off time elapses.

MENU Auto Rotation of Vertical Images



Vertical images are rotated automatically so they are displayed vertically on the camera's LCD monitor and computer instead of horizontally. The setting of this feature can be changed.

1 Select [Auto rotate].

- Under the [F] tab, select [Auto rotate], then press <SET>.

2 Set the auto rotation.

- Turn the <DIAL> dial to select the option, then press <SET>.

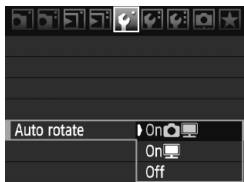

● On

The vertical image is automatically rotated on both the camera's LCD monitor and on the personal computer.

● On

The vertical image is automatically rotated only on the personal computer.

● Off

The vertical image is not rotated.

 Auto rotation will not work with vertical images captured while Auto rotate was set to [Off]. They will not be rotated even if you later switch it to [On] for playback.

-  Immediately after image capture, the vertical image will not be automatically rotated for the image review.
- Movies cannot be rotated.
- If the vertical image is taken while the camera is pointed up or down, the image might not be rotated automatically for playback.
- If the vertical image is not automatically rotated on the personal computer screen, it means the software you are using is unable to rotate the image. Using the provided software is recommended.

8

Sensor Cleaning

The camera has a Self Cleaning Sensor Unit attached to the image sensor's front layer (low-pass filter) to shake off dust automatically.

The Dust Delete Data can also be appended to the image so that the dust spots remaining can be erased automatically by Digital Photo Professional (provided software).

About smear adhering to the front of the sensor

Besides dust entering the camera from outside, in rare cases lubricant from the camera's internal parts may adhere to the front of the sensor. In case visible spots still remain after the automatic sensor cleaning, having the sensor cleaned by a Canon Service Center is recommended.

 Even while the Self Cleaning Sensor Unit is operating, you can press the shutter button halfway to interrupt the cleaning and start shooting immediately.

Automatic Sensor Cleaning

Whenever you set the power switch to <ON/J> or <OFF>, the Self Cleaning Sensor Unit operates to automatically shake off any dust on the front of the sensor. Normally, you need not pay attention to this operation. However, you can execute the sensor cleaning at anytime as well as disable it.

Cleaning the Sensor Now



1 Select [Sensor cleaning].

- Under the [] tab, select [**Sensor cleaning**], then press <SET>.

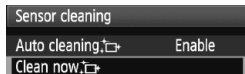



2 Select [Clean now].

- Turn the <DIAL> dial to select [**Clean now **], then press <SET>.



3 Select [OK].

- Turn the <DIAL> dial to select [**OK**], then press <SET>.
- ▶ During the sensor cleaning, the <> icon will be displayed on the LCD monitor. When the cleaning ends, the screen will return to step 2.

- During the sensor cleaning, the shutter will make three shutter-release sounds. The camera is not taking pictures.
- For best results, do the sensor cleaning while the camera bottom is placed on a table or other flat surface.
- Even if you repeat the sensor cleaning, the result will not improve that much. Right after the sensor cleaning is finished, the [**Clean now **] option will remain disabled temporarily.

Disabling Automatic Sensor Cleaning

- In step 2, select [**Auto cleaning **] and set it to [**Disable**].
- ▶ The sensor cleaning will no longer be executed when you set the power switch to <ON/J> or <OFF>.

MENU Appending Dust Delete Data

Normally, the Self Cleaning Sensor Unit will eliminate most of the dust that might be visible on captured images. However, in case visible dust still remains, you can append the Dust Delete Data to the image to later erase the dust spots. The Dust Delete Data is used by Digital Photo Professional (provided software) to erase the dust spots automatically.

Preparation

- Get a solid-white object (paper, etc.).
- Set the lens focal length to 50mm or longer.
- Set the lens focus mode switch to **<MF>** and set the focus to infinity (∞). If the lens has no distance scale, look at the front of the lens and turn the focusing ring clockwise all the way.

Obtain the Dust Delete Data

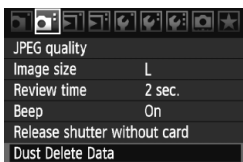

1 Select [Dust Delete Data].

- Under the [] tab, select [**Dust Delete Data**], then press **<SET>**.

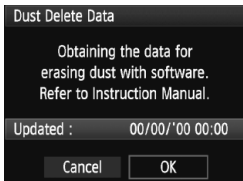

2 Select [OK].

- Turn the **<DISP>** dial to select [**OK**], then press **<SET>**. After the automatic sensor cleaning ends, a message will appear. Although there will be a shutter sound, a picture is not taken.

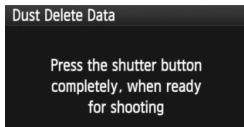
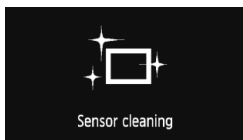

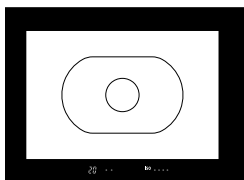

3 Photograph a solid-white object.

- At a distance of 20 cm - 30 cm / 0.7 ft. - 1.0 ft., fill the viewfinder with a patternless, solid-white object and take a picture.
- ▶ The picture will be taken in the aperture-priority AE mode with an aperture of f/22.
- Since the image will not be saved, the data can still be obtained even if there is no card in the camera.
- ▶ When the picture is taken, the camera will start obtaining the Dust Delete Data. When the Dust Delete Data is obtained, a message will appear. Select **[OK]**, and the menu will reappear.
- If the data was not obtained successfully, a message to that effect will appear. Follow the “Preparation” procedure on the preceding page, then select **[OK]**. Take the picture again.

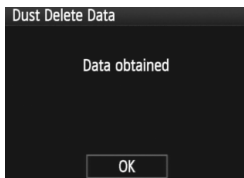

About the Dust Delete Data

After the Dust Delete Data is obtained, it is appended to all the JPEG and RAW images captured thereafter. Before an important shoot, you should update the Dust Delete Data by obtaining it again.

To erase dust spots automatically with the provided software, see the PDF Software Instruction Manual on the CD-ROM.

The Dust Delete Data appended to the image is so small that it hardly affects the image file size.

! Be sure to use a solid-white object such as a new sheet of white paper. If the paper has any pattern or design, it may be recognized as dust data and affect the accuracy of the dust deletion with the software.

MENU Manual Sensor Cleaning

Dust which could not be removed by the automatic sensor cleaning can be removed manually with a blower, etc.

The surface of the image sensor is extremely delicate. If the sensor needs to be cleaned directly, having it done by a Canon Service Center is recommended.

Before cleaning the sensor, detach the lens from the camera.



1 Select [Sensor cleaning].

- Under the [] tab, select [**Sensor cleaning**], then press <SET>.

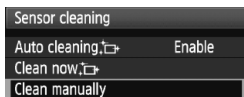

2 Select [Clean manually].

- Turn the < > dial to select [**Clean manually**], then press <SET>.



3 Select [OK].

- Turn the < > dial to select [**OK**], then press <SET>.
- ▶ In a moment, the reflex mirror will lockup and the shutter will open.
- “CLn” will blink on the top LCD panel.



4 End the cleaning.

- After cleaning the sensor, set the power switch to <OFF>.



- Using the AC Adapter Kit ACK-E4 (sold separately) as power source is recommended.
- If you use the battery, make sure it is fully recharged.



- **While cleaning the sensor, never do any of the following. If the power is cut off, the shutter will close and the shutter curtains and image sensor might get damaged.**
 - **Setting the power switch to <OFF>.**
 - **Removing or inserting the battery.**
- The surface of the image sensor is extremely delicate. Clean the sensor with care.
- Use a plain blower without any brush attached. A brush can scratch the sensor.
- Do not insert the blower tip inside the camera beyond the lens mount. If the power is cut off, the shutter will close and the shutter curtains or reflex mirror might get damaged.
- Never use canned air or gas to clean the sensor. The blowing force can damage the sensor or the spray gas can freeze on the sensor.
- If smear that cannot be removed with a blower remains, having the sensor cleaned by a Canon Service Center is recommended.

9

Printing Images

- **Printing** (p.190)
You can connect the camera directly to a printer and print out the images in the card. The camera is compatible with “PictBridge” which is the standard for direct printing.
- **Digital Print Order Format (DPOF)** (p.199)
DPOF (Digital Print Order Format) enables you to print images recorded in the card according to your printing instructions such as the image selection, quantity to print, etc. You can print multiple images in one batch or give the print order to a photofinisher.

Preparing to Print

The direct printing procedure is done entirely with the camera while you look at the LCD monitor.

Connecting the Camera to a Printer

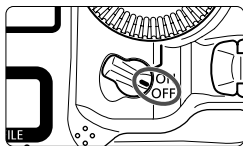

1 Set the camera's power switch to <OFF>.

2 Set up the printer.

- For details, see the printer's instruction manual.

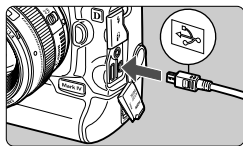

3 Connecting the camera to a printer

- Use the interface cable provided with the camera.
- When connecting the cable plug to the <A/V OUT/DIGITAL> terminal, the cable plug's <↔> icon must face the back of the camera.
- To connect to the printer, refer to the printer's instruction manual.

4 Turn on the printer.

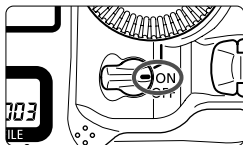

5 Set the camera's power switch to <ON>.

- ▶ Some printers may make a beeping sound.

PictBridge



6 Playback the image.

- Press the <▶> button.
- ▶ The image will appear, and the <📷> icon will appear on the upper left to indicate that the camera is connected to a printer.



- Movies cannot be printed.
- The camera cannot be used with printers compatible only with CP Direct or Bubble Jet Direct.
- Do not use any interface cable other than the one provided.
- If there is a long beeping sound in step 5, it indicates a problem with the printer. To find out what's wrong, do the following:
 1. Press the <▶> button to playback the image.
 2. Press <SET>.
 3. On the print setting screen, select **[Print]**.

The error message will be displayed on the LCD monitor (p.198).



- You can also print RAW images taken by this camera.
- If you use the battery to power the camera, make sure it is fully charged. With a fully-charged battery, printing up to approx. 6 hours is possible.
- Before disconnecting the cable, turn off the camera and printer first. Hold the plug (not the cord) to pull out the cable.
- For direct printing, using AC Adapter Kit ACK-E4 (sold separately) to power the camera is recommended.

Printing

The screen display and setting options will differ depending on the printer. Some settings might not be available. For details, see the printer's instruction manual.



1 Select the image to be printed.

- Check that the <☞> icon is displayed on the upper left of the LCD monitor.
- Turn the <⊙> dial to select the image to be printed.

2 Press <SET>.

- ▶ The print setting screen will appear.

Print setting screen

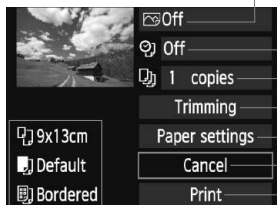

Sets the printing effects (p.194).

Sets the date or file number imprinting to on or off.

Sets the quantity to be printed.

Sets the trimming (cropping) (p.197).

Sets the paper size, type, and layout.

Returns to the screen in step 1.

Starts the printing.

The paper size, type, and layout you have set are displayed.

* Depending on the printer, certain settings such as the date and file number imprinting and trimming might not be available.

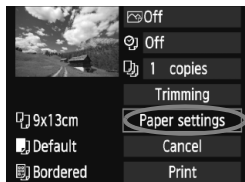

3 Select [Paper settings].

- Turn the <⊙> dial to select [Paper settings], then press <SET>.
- ▶ The paper settings screen will appear.

Setting the Paper Size

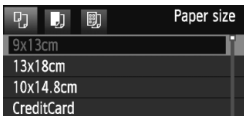

- Turn the <⊙> dial to select the size of the paper loaded in the printer, then press <SET>.
- ▶ The paper type screen will appear.

Setting the Paper Type

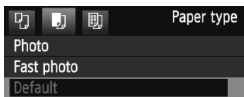

- Turn the <⊙> dial to select the type of the paper loaded in the printer, then press <SET>.
- When using a Canon printer and Canon paper, read the printer's instruction manual to check what paper types can be used.
- ▶ The page layout screen will appear.

Setting the Page Layout

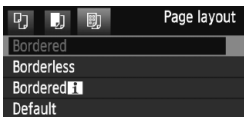

- Turn the <⊙> dial to select the page layout, then press <SET>.
- ▶ The print setting screen will reappear.

Item	Description
Bordered	The print will have white borders along the edges.
Borderless	The print will have no borders. If your printer cannot print borderless prints, the print will have borders.
Bordered [i]	The shooting information* will be imprinted on the border on 9x13cm and larger prints.
xx-up	Option to print 2, 4, 8, 9, 16, or 20 images on one sheet.
20-up [i] 35-up [i]	On A4 or Letter size paper, 20 or 35 thumbnails of the images ordered through DPOF (p.199) will be printed. • [20-up [i]] will have the shooting information* imprinted.
Default	The page layout will vary depending on the printer model or its settings.

* From the Exif data, the camera name, lens name, shooting mode, shutter speed, aperture, exposure compensation amount, ISO speed, white balance, etc., will be imprinted.



4 Set the printing effects.

- Set as necessary. If you need not set any printing effects, go to step 5.
- Turn the < > dial to select the item on the upper right, then press < >.
- If the < > icon is displayed next to < **INFO.** >, you can also adjust the printing effect (p.196).
- Next, turn the < > dial to select the desired printing effect, then press < >.

Printing Effect	Description
On	The image will be printed according to the printer's standard colors. The image's Exif data is used to make automatic corrections.
Off	Same as the printing characteristics turned "On". No automatic correction will be performed.
VIVID	The image will be printed with higher saturation to produce more vivid blues and greens.
NR	The image noise is reduced before printing.
B/W B/W	Prints in black-and-white with true blacks.
B/W Cool tone	Prints in black-and-white with cool, bluish blacks.
B/W Warm tone	Prints in black-and-white with warm, yellowish blacks.
Natural	Prints the image in the actual colors and contrast. No automatic color adjustments are applied.
Natural M	The printing characteristics are the same as the "Natural" setting. However, this setting enables finer printing adjustments than with "Natural."
Default	The printing will differ depending on the printer. For details, see the printer's instruction manual.

* The screen display may differ depending on the printer.

* When you change the printing effects, it is reflected in the image displayed on the upper left. Note that the printed image might look slightly different from the displayed image which is only an approximation. This also applies to [Brightness] and [Adjust levels] on page 196.



5 Set the date and file number imprinting.

- Set as necessary.
- Turn the <☉> dial to select <☺>, then press <⊙>.
- Turn the <☉> dial to select the desired setting, then press <⊙>.



6 Set the number of copies.

- Set as necessary.
- Turn the <☉> dial to select <☺>, then press <⊙>.
- Turn the <☉> dial to select the number of copies, then press <⊙>.



7 Start printing.

- Turn the <☉> dial to select [**Print**], then press <⊙>.
- ▶ The printing will start.



- For details on trimming, see page 197.
- The [**Default**] setting for printing effects and other options are the printer's own default settings as set by the printer's manufacturer. See the printer's instruction manual to find out what the [**Default**] settings are.
- When imprinting the shooting information **I** (p.193) for images shot at H2, H3 ISO speeds during ISO speed range expansion, the ISO speed setting may not be correctly printed.
- Depending on the image's file size and image size, it may take some time for the printing to start after you select [**Print**].
- If image tilt correction (p.197) has been applied, it may take longer to print the image.
- To stop the printing, press <⊙> while [**Stop**] is displayed, then select [**OK**].
- If you execute the [**☛: Clear all camera settings**] menu option (p.53), all the settings will revert to the default.

Adjustment of Printing Effects

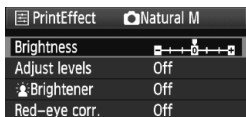
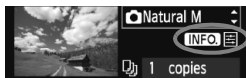

In step 4 on page 194, select the printing effect. When the icon is displayed next to **<INFO.>**, press the **<INFO.>** button. You can then adjust the printing effect. What can be adjusted or what is displayed will depend on the selection made in step 4.

- **Brightness**

The image brightness can be adjusted.

- **Adjust levels**

When you select **[Manual]**, you can change the histogram's distribution and adjust the image's brightness and contrast.

With the Adjust levels screen displayed, press the **<INFO.>** button to change the position of the . Turn the to freely adjust the shadow level (0 - 127) or highlight level (128 - 255).



- **Brightener**

Effective in backlit conditions which can make the subject's face look dark. When **[On]** is set, the face will be brightened for printing.

- **Red-eye corr.**

Effective in flash images where the subject has red eye. When **[On]** is set, the red eye will be corrected for printing.

- The **[Brightener]** and **[Red-eye corr.]** effects will not show on the screen.
- When **[Detail set.]** is selected, you can adjust the **[Contrast]**, **[Saturation]**, **[Color tone]**, and **[Color balance]**. To adjust the **[Color balance]**, use . B is for blue, A is amber, M is magenta, and G is green. The color in the respective direction will be corrected.
- If you select **[Clear all]**, all the printing effect settings will be reverted to the default.

Trimming the Image



You can crop the image and print only the trimmed portion as if the image was recomposed. **Do the trimming right before printing.** If you set the trimming and then set the print settings, you may have to set the trimming again.

1 On the print setting screen, select [Trimming].

2 Set the trimming frame size, position, and aspect ratio.

- The image area within the trimming frame will be printed. The trimming frame's aspect ratio can be changed with [Paper settings].

Changing the trimming frame size

When you press the <Q> or <Q> button, the size of the trimming frame will change. The smaller the trimming frame, the larger the image magnification will be for printing.

Moving the trimming frame

Use <⬆> to move the frame over the image vertically or horizontally. Move the trimming frame until it covers the desired image area.

Rotating the frame

Each time you press the <INFO.> button, the trimming frame will toggle between the vertical and horizontal orientations. This enables you to create a vertical-oriented print from a horizontal image.

Image tilt correction

By turning the <⦿> dial, you can adjust the image tilt angle up to ± 10 degrees in 0.5-degree increments. When you adjust the image tilt, the <⚙> icon on the screen will turn blue.

3 Press <SET> to exit the trimming.

- ▶ The print setting screen will reappear.
- You can check the trimmed image area on the upper left of the print setting screen.

- Depending on the printer, the trimmed image area might not be printed as you specified.
- The smaller you make the trimming frame, the grainier the picture will look on the print.
- While trimming the image, look at the camera's LCD monitor. If you look at the image on a TV screen, the trimming frame might not be displayed accurately.



Handling Printer Errors

If you resolve a printer error (no ink, no paper, etc.) and select [**Continue**] to resume printing but it does not resume, operate the buttons on the printer to resume printing. For details, see the printer's instruction manual.

Error Messages

If a problem occurs during printing, an error message will appear on the camera's LCD monitor. Press <ⓈET> to stop printing. After fixing the problem, resume printing. For details on how to fix a printing problem, refer to the printer's instruction manual.

Paper Error

Check whether the paper is properly loaded in the printer.

Ink Error

Check the printer's ink level, and check the waste ink tank.

Hardware Error

Check for any printer problems other than paper and ink problems.

File Error

The selected image cannot be printed via PictBridge. Images taken with a different camera or images edited with a computer might not be printable.

Digital Print Order Format (DPOF)

You can set the print type, date imprinting, and file No. imprinting. The print settings will be applied to all print-ordered images. (They cannot be set individually for each image.)

Setting the Printing Options

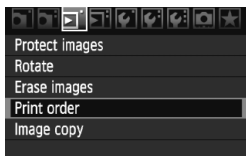

1 Select [Print order].

- Under the [Print order] tab, select [Print order], then press <SET>.

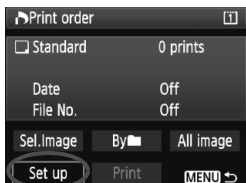

2 Select [Set up].

- Turn the <DIAL> dial to select [Set up], then press <SET>.

3 Set the option as desired.

- Set the [Print type], [Date], and [File No.].
- Turn the <DIAL> dial to select the option, then press <SET>.
- Turn the <DIAL> dial to select the setting, then press <SET>.

[Print type]

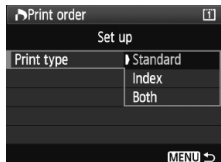



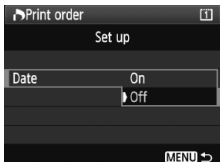

[Date]

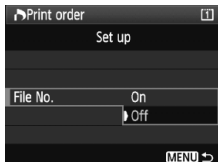

[File No.]



Option	Description	
Print type	 Standard	Prints one image on one sheet.
	 Index	Multiple, thumbnail images are printed on one sheet.
	  Both	Prints both the standard and index prints.
Date	On	[On] imprints the recorded date on the print.
	Off	
File number	On	[On] imprints the file No. on the print.
	Off	

4 Exit the setting.

- Press the <MENU> button.
- ▶ The print order screen will reappear.
- Next, select [Sel.Image], [By■], or [All image] to order the images to be printed.

- Even if [Date] and [File No.] are set to [On], the date or file No. might not be imprinted depending on the print type setting and printer model.
- When printing with DPOF, you must use the card whose print order specifications have been set. It will not work if you just extract images from the card and try to print them.
- Certain DPOF-compatible printers and photofinishers might not be able to print the images as you specified. If this happens with your printer, refer to the printer's instruction manual. Or check with your photofinisher about compatibility when ordering prints.
- Do not insert into the camera a card whose print order was set by a different camera and then try to specify a print order. The print order may not work or may be overwritten. Also, depending on the image type, the print order may not be possible.

- RAW images and movies cannot be print ordered.
- With [Index] prints, both the [Date] and [File No.] cannot be set to [On] at the same time.

Print Ordering

● Sel.Image

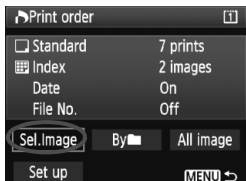

Select and order images one by one. Press the <Q> button to display the three-image view. To return to the single-image display, press the <Q> button. After completing the print order, press the <MENU> button to save the print order to the card.

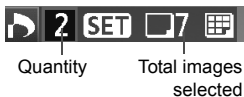

[Standard] [Both]

Press <SET> and a print order for 1 copy of the displayed image will be placed. Then turn the <Q> dial to set the number of copies (up to 99) to be printed for that image.



[Index]

Press <SET>, and the displayed image will be included in the index print. The <√> icon will also appear on the upper left.

● By [Folder]

Select [By [Folder]] and select the folder. A print order for 1 copy of all the images in the folder will be placed. If you select Clear all and a folder, the print order for all the images in the folder will be canceled.

● All image

A print order for 1 copy of all the images in the card will be placed. If you select Clear all, the print order for all the images in the card will be canceled.



- Note that RAW images and movies will not be included in the print order even if you set "By [Folder]" or "All image."
- When using a PictBridge printer, print no more than 400 images for one print order. If you specify more than this, all the images might not be printed.

Direct Printing with DPOF

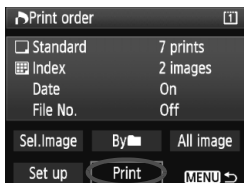

With a PictBridge printer, you can easily print images with DPOF.

1 Prepare to print.

- See page 190. Follow the “Connecting the Camera to a Printer” procedure up to step 5.

2 Under the [] tab, select [Print order].

3 Select [Print].

- [Print] will be displayed only if the camera is connected to the printer and printing is possible.

4 Set the [Paper settings]. (p.192)

- Set the printing effects (p.194) if necessary.

5 Select [OK].

- Before printing, be sure to set the paper size.
- Certain printers cannot imprint the file No.
- If [Bordered] is set, certain printers might imprint the date on the border.
- Depending on the printer, the date might look light if it is imprinted on a bright background or on the border.

- Under [Adjust levels], [Manual] cannot be selected.
- If you stopped the printing and want to resume printing the remaining images, select [Resume]. Note that printing will not resume if you stop the printing and any of the following occurs:
 - Before resuming the printing, you changed the print order or deleted print-ordered images.
 - When you set the index, you changed the paper setting before resuming the printing.
 - When you paused the printing, the card's remaining capacity was low.
- If a problem occurs during printing, see page 198.

10

Customizing the Camera

To suit your shooting preferences, you can fine-tune the camera's functions, save the camera settings to a card or register them to the camera.

MENU Setting Custom Functions



Custom Function No.

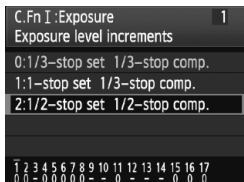
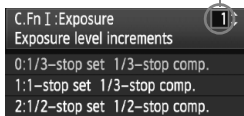

- 1 Select [MENU].**
 - Turn the < [MENU] > dial to select the [MENU] tab.
- 2 Select the group.**
 - Turn the < [C.Fn] > dial to select C.Fn I - IV, then press < [SET] >.
- 3 Select the Custom Function number.**
 - Turn the < [C.Fn] > dial to select the Custom Function No., then press < [SET] >.
- 4 Change the setting as desired.**
 - Turn the < [C.Fn] > dial to select the setting (number), then press < [SET] >.
 - Repeat steps 2 to 4 if you want to set other Custom Functions.
 - At the bottom of the screen, the current Custom Function settings are indicated below the respective function numbers.
- 5 Exit the setting.**
 - Press the < MENU > button.
 - ▶ The screen for step 2 will reappear.



Clearing All Custom Functions

In step 2, select [Clear all Custom Func. (C.Fn)] to clear all the Custom Function settings.

Even if all the Custom Functions are cleared, the setting for [C.Fn IV -12: Focusing Screen] will remain unchanged. The registered settings for [C.Fn I -16: AE Microadjustment], [C.Fn I -17: FE Microadjustment], and [C.Fn III -7: AF Microadjustment] will also be retained but [0: Disable] will be set.

MENU Custom Functions

C.Fn I: Exposure

		 LV shooting	 Movie shooting
1	Exposure level increments	○	
2	ISO speed setting increments	○	In M movie mode
3	Set ISO speed range	○	In M movie mode
4	Bracketing auto cancel	○	
5	Bracketing sequence	○	
6	Number of bracketed shots	○	
7	Spot metering link to AF point		
8	Safety shift	○	
9	Select usable shooting modes	○	
10	Select usable metering modes		
11	Exposure mode in manual exposure		
12	Set shutter speed range	○	In M movie mode
13	Set aperture value range	○	In M movie mode
14	Apply shooting/metering mode		
15	Flash sync. speed in Av mode	○	
16	AE Microadjustment	○	(Still photo)
17	FE Microadjustment	○	



- The shaded Custom Functions do not function during Live View (LV shooting) nor movie shooting. (Settings are disabled.)
- In  Movie shooting, even if the AF mode has been set to **[Quick mode]** (**AFQuick**), it will switch to **[Live mode]** (**AFLive**) during movie shooting. Therefore, the Custom Functions marked “With **AFQuick**”, do not function during movie shooting. (Functions only before movie shooting.)



C.Fn II: Image/Flash exposure/Display

1	Long exposure noise reduction	p.214
2	High ISO speed noise reduction	
3	Highlight tone priority	p.215
4	Auto Lighting Optimizer	
5	E-TTL II flash metering	
6	Shutter curtain sync.	p.216
7	Flash firing	
8	Viewfinder info. during exposure	
9	LCD panel illumination during Bulb	p.217
10	INFO. button when shooting	

 LV shooting	 Movie shooting
○	(Still photo)
○	(Still photo)
○	
○	
○	
○	
○	
○	
○	





C.Fn III: Autofocus/Drive

1	USM lens electronic MF	p.218
2	AI Servo tracking sensitivity	
3	AI Servo 1st/2nd image priority	p.219
4	AI Servo AF tracking method	
5	Lens drive when AF impossible	
6	Lens AF stop button function	p.220
7	AF Microadjustment	p.221
8	AF expansion with selected point	p.222
9	Multi-controller while metering	p.223
10	Selectable AF point	
11	Switch to registered AF point	p.224
12	AF point auto selection	

 LV shooting	 Movie shooting
○	
	With AFQuick
	Except 4 (With AFQuick only for some settings)
	With AFQuick
	With AFQuick
	With AFQuick
	With 2+ AFQuick
	With AFQuick

13	AF point display during focus	p.225	With AFQuick	
14	AF point brightness		With AFQuick	
15	AF-assist beam firing		With AFQuick	
16	Orientation linked AF point	p.226	With AFQuick	
17	Mirror lockup			
18	Continuous shooting speed		○	
19	Limit continuous shot count	p.227	○	

C.Fn IV: Operation/Others

		 LV shooting		 Movie shooting	
1	Shutter button/AF-ON button	p.227	○		
2	AF-ON/AE lock button switch		○		
3	Quick Control Dial in metering	p.228	1,3: With AFQuick  +2,4: M movie mode		
4	Assign SET button	p.229			
5	Tv/Av setting for Manual exposure		○ (In M)		
6	Dial direction during Tv/Av	p.230	○	In M movie mode	
7	Av setting without lens		○	In M movie mode	
8	WB + media/image size setting				
9	 button function	p.231			
10	Button function when  <OFF>		○		
11	Start movie shooting	p.232			○
12	Focusing screen				
13	Timer length for timer	p.233	[Timer after release] only		
14	Shortened release time lag				
15	Add aspect ratio information	p.234	○	(Still photo)	
16	Add image verification data		○	(Still photo)	

MENU Custom Function Settings

Custom Functions are organized in four groups based on the function type: C.Fn I: Exposure, C.Fn II: Image/Flash exp (exposure)/Disp (Display), C.Fn III: Autofocus/Drive, and C.Fn IV: Operation/Others.

 **Note that some Custom Function numbers differ from the EOS-1D Mark III's Custom Functions.**

C.Fn I: Exposure

C.Fn I -1 Exposure level increments

0: 1/3-stop set 1/3-stop compensation

1: 1-stop set 1/3-stop compensation

Sets full-stop increments for the shutter speed and aperture.

2: 1/2-stop set 1/2-stop compensation

Sets 1/2-stop increments for the shutter speed, aperture, and exposure compensation.

 If 2 is set, the viewfinder and the top LCD panel display for 1/2-stop increments will change as follows: “■” → “■■”.

C.Fn I -2 ISO speed setting increments

0: 1/3-stop

1: 1-stop

C.Fn I -3 Set ISO speed range

Disable: The settable ISO speed range will be 100 - 12800.

Enable: The settable ISO speed will range from the highest ISO speed to the lowest ISO speed set with [**Register**].

Register: The highest ISO speed can be registered within 100 to H3 (102400), and the lowest ISO speed can be registered within L (50) to H2 (51200). After entering the settings, select [**Apply**].

- 
- If you want to set the ISO speed range expansion in the same way as other EOS cameras, set the upper limit to [**H1**], [**H2**], or [**H3**], and the lower limit to [**L**].
 - Even if C.Fn I -3 is set to L as the lower limit, L cannot be selected during manual exposure movie shooting (ISO 50).

C.Fn I -4 Bracketing auto cancel

0: On

The AEB and WB-BKT settings will be canceled if you set the power switch to <OFF> or clear the camera settings. AEB will also be canceled when bulb exposure is set or the flash is ready to fire.

1: Off

The AEB and WB-BKT settings will be retained even when the power switch is set to <OFF>. (When the flash is ready, AEB will be canceled. However, the AEB amount will be retained in memory.)

C.Fn I -5 Bracketing sequence

The AEB shooting sequence and white balance bracketing sequence can be changed.

0: 0, -, +

1: -, 0, +

2: +, 0, -

AEB	WB Bracketing	
	B/A Direction	M/G Direction
0 : Standard exposure	0 : Standard white balance	0 : Standard white balance
- : Decreased exposure	- : Blue bias	- : Magenta bias
+ : Increased exposure	+ : Amber bias	+ : Green bias

C.Fn I -6 Number of bracketed shots

The number of shots taken with AEB and white balance bracketing can be changed from the usual 3 shots to 2, 5, or 7 shots. When C.Fn I -5-0 is set, the bracketed shots will be taken as shown in the table below.

0: 3 shots

2: 5 shots

1: 2 shots

3: 7 shots

(1-stop increments)

	1st shot	2nd shot	3rd shot	4th shot	5th shot	6th shot	7th shot
0: 3 shots	Standard (0)	-1	+1				
1: 2 shots	Standard (0)	-1					
2: 5 shots	Standard (0)	-2	-1	+1	+2		
3: 7 shots	Standard (0)	-3	-2	-1	+1	+2	+3

C.Fn I -7 Spot metering link to AF point

0: Disable (use center AF point)

1: Enable (use active AF point)

If [ **C.Fn III -10: Selectable AF point**] (p.223) is set to [**1: 19 points**], [**2: 11 points**], [**3: Inner 9 points**] or [**4: Outer 9 points**], spot metering linked to the selected AF point is possible. With automatic AF point selection, spot metering will be at the viewfinder center.

 If C.Fn III -10 is set to [**0: 45 points**], spot metering at the center will be set even if C.Fn I -7 is set to [**1: Enable (use active AF point)**].

C.Fn I -8 Safety shift

0: Disable

1: Enable (Tv/Av)

This works in the shutter-priority AE (**Tv**) and aperture-priority AE (**Av**) modes. When the subject's brightness changes erratically and the correct autoexposure cannot be obtained, the camera will change the exposure setting automatically to obtain a correct exposure.

2: Enable (ISO speed)

This works in the Program AE (**P**), shutter-priority AE (**Tv**), and aperture-priority AE (**Av**) modes. When the subject's brightness changes erratically and the correct autoexposure cannot be obtained, the camera will change the ISO speed automatically to obtain a correct exposure.

- 
- Even if the exposure settings settable range has been changed with C.Fn I -3,12,13, the safety shift will override it when necessary to obtain the correct exposure.
 - With settings 1 and 2, safety shift also works with flash.

C.Fn I -9 Select usable shooting modes

Disable: All the shooting modes (**M**, **Tv**, **Av**, **P**, **BULB**) will be selectable.

Enable: Only the shooting modes set with [**Register**] will be selectable.

Register: To make a shooting mode unselectable, uncheck the checkmark <√>. After entering the settings, select [**Apply**].

C.Fn I -10 Select usable metering modes

Disable: All the metering modes (☉: Evaluative, ☒: Partial, ☐: Spot, ☐: Center-weighted average) will be selectable.

Enable: Only the metering modes set with **[Register]** will be selectable.

Register: To make a metering mode unselectable, uncheck the checkmark <✓>. After entering the settings, select **[Apply]**.

C.Fn I -11 Exposure mode in manual exposure

You can set the metering mode to be used in the manual exposure mode.

0: Specified metering mode **3: Spot metering**

1: Evaluative metering

4: Center-weighted average

2: Partial metering



With settings 1 to 4, you cannot change the metering mode by pressing the <☉/☒> button during shooting.

C.Fn I -12 Set shutter speed range

Disable: The settable shutter speed range will be 1/8000 sec. to 30 sec.

Enable: The settable shutter speed will range from the highest shutter speed to the lowest shutter speed set with **[Register]**.

Register: The highest shutter speed can be registered within 1/8000 sec. to 15 sec., and the lowest shutter speed can be registered within 30 sec. to 1/4000 sec. After entering the settings, select **[Apply]**.

C.Fn I -13 Set aperture value range

Disable: The settable aperture will range from the camera-attached lens' maximum aperture to minimum aperture.

Enable: The settable aperture will range from the smallest to largest aperture set with **[Register]**.

Register: The smallest aperture can be registered within f/91 to f/1.4, and the largest aperture can be registered within f/1.0 to f/64. After entering the settings, select **[Apply]**.

C.Fn I -14 Apply shooting/metering mode

While holding down the <★> (AE lock) button, you can switch to the registered setting (shooting mode, metering mode, shutter speed, aperture, or exposure compensation).

Disable: Pressing the <★> button will lock the exposure (AE lock).

Enable: By holding down the <★> button, you can instantly switch to the registered setting.

Register: Set the desired setting for the AE lock button: Shooting mode, metering mode, shutter speed, aperture, or exposure compensation.

When you select [**Register**], [**With AE lock button (AF on/AF off)**] will be displayed where you can set the <★> AE lock button to also execute AF or not. Select [**AF on/AF off**] to register the setting to the camera.

 This setting cannot be registered if the shooting mode is set to "Bulb".

C.Fn I -15 Flash sync. speed in Av mode

You can set the flash-sync speed for flash photography in the aperture-priority AE (**Av**) mode.

0: Auto

The flash sync speed is set automatically within a range of 1/300 sec. to 30 sec. to suit the scene's brightness. High-speed sync can also be used.

1: 1/300-1/60 sec. auto

Prevents the sync speed from being set too slow under low-light conditions. It is effective for preventing subject blur and camera shake. However, while the subject will be properly exposed with the flash, the background may come out dark.

2: 1/300 sec. (fixed)

The flash-sync speed is fixed to 1/300 sec. This more effectively prevents subject blur and camera shake than with setting 1. However, the background may come out darker than with setting 1.

 When 1 or 2 is set, high-speed sync cannot be used with an external Speedlite.

C.Fn I -16 AE Microadjustment

- Normally, this adjustment is not required. Do this adjustment only if necessary. Note that doing this adjustment may prevent correct exposure from being achieved.**

You can fine adjust the camera's standard exposure level. The adjustment can help if the camera's "standard exposure" always seems to be underexposed or overexposed.

With setting 1 selected, press the <INFO.> button to display the adjustment screen.

0: Disable**1: Enable**

The adjustment can be made up to ± 1 stop in 1/8-stop increments. If the image tends to be underexposed, set the adjustment to the + side. Or to the - side if the image tends to be overexposed.

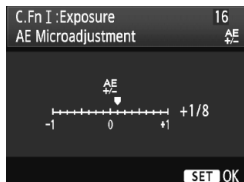

C.Fn I -17 FE Microadjustment

- Normally, this adjustment is not required. Do this adjustment only if necessary. Note that doing this adjustment may prevent the correct flash exposure from being obtained.**

You can fine adjust the camera's standard flash exposure level. The adjustment can help if the camera's "standard flash exposure" (without flash exposure compensation) always seems to be underexpose or overexpose the subject.

With setting 1 selected, press the <INFO.> button to display the adjustment screen.

0: Disable**1: Enable**

The adjustment can be made up to ± 1 stop in 1/8-stop increments. If the subject tends to be underexposed, set the adjustment to the + side. Or to the - side if the subject tends to be overexposed.

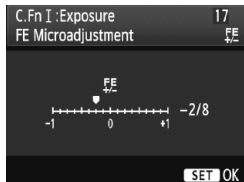

C.Fn II: Image/Flash exposure/Display

C.Fn II -1 Long exposure noise reduction

0: Off

1: Auto

For 1 sec. or longer exposures, noise reduction is performed automatically if noise typical of long exposures is detected. This [**Auto**] setting is effective in most cases.

2: On

Noise reduction is performed for all exposures of 1 sec. or longer. The [**On**] setting may be effective for noise that cannot be detected or reduced with the [**Auto**] setting.

- With setting 1 and 2, after the picture is taken, the noise reduction process may take the same amount of time as the exposure. During the noise reduction, shooting is still possible as long as the maximum burst indicator in the viewfinder shows “1” or higher.
- At ISO 1600 and higher, noise might be more pronounced with setting 2 than with setting 0 or 1.
- With setting 2, if a long exposure is shot during Live View display, “**BUSY**” will be displayed during the noise reduction process and the Live View display will not appear until the noise reduction is completed. (You cannot take another picture.)

C.Fn II -2 High ISO speed noise reduction

Reduces the noise generated in the image. Although noise reduction is applied at all ISO speeds, it is particularly effective at high ISO speeds. At low ISO speeds, the noise in the shadow areas is further reduced. Change the setting to suit the noise level.

0: Standard

2: Strong

1: Low

3: Disable

- With setting 2, the maximum burst for continuous shooting will greatly decrease.
- This function does not work with movies. However, the noise reduction setting will be applied to still photos taken during movie shooting.
- If you playback a RAW or RAW+JPEG image with the camera or print the image directly, the effect of the high ISO speed noise reduction may look minimal. You can check the noise reduction effect or print noise-reduced images with Digital Photo Professional (provided software).

C.Fn II -3 Highlight tone priority**0: Disable****1: Enable**

Improves the highlight detail. The dynamic range is expanded from the standard 18% gray to bright highlights. The gradation between the grays and highlights becomes smoother.



With setting 1, noise may be slightly more pronounced than usual.



With setting 1, the settable ISO speed range will be 200 - 12800. Also, <D+> will be displayed on the top LCD panel and in the viewfinder.

C.Fn II -4 Auto Lighting Optimizer

If the image comes out dark or the contrast is low, the brightness and contrast can be corrected automatically.

For details on the Auto Lighting Optimizer, see page 81.

0: Standard**2: Strong****1: Low****3: Disable****C.Fn II -5 E-TTL II flash metering****0: Evaluative flash metering**

Fully automatic flash photography for all conditions, from low light to daylight fill-flash.

1: Average flash metering

The entire metered area is averaged. Since automatic flash exposure compensation will not be executed, you may have to set it yourself depending on the scene. This also applies if you use FE lock.

C.Fn II -6 Shutter curtain sync.**0: 1st-curtain synchronization****1: 2nd-curtain synchronization**

The flash fires immediately before the exposure ends. When this is combined with a slow sync speed, you can create a trail of light such as from car headlights at night.

This Custom Function can be used to obtain 2nd-curtain sync effects even with EX-series Speedlites which do not have this feature (except Speedlite 270EX).

-  ● When using EX-series Speedlites having the shutter curtain synchronization function, C.Fn II -6's setting does not take effect. Set the shutter curtain synchronization in the Flash functions settings menu (p.122) or directly on the flash.
- When using a Speedlite 270EX, shutter curtain synchronization can be set in the Flash functions settings menu.
- If 1 is set and you press the shutter button completely, note that the flash will fire a total of two times right before the exposure ends.
- When using 2nd-curtain sync, set the shutter speed to 1/50 sec. or slower. If the shutter speed is 1/60 sec. or faster, 1st-curtain sync will be applied even if 1 is set.

C.Fn II -7 Flash firing

Enables or disables the firing of an external flash or non-Canon flash connected to the PC terminal.

0: Enable**1: Disable**

Convenient when you want to use the external flash's AF-assist beam only. Note that whether or not the AF-assist beam is emitted depends on the C.Fn III -15 setting.

C.Fn II -8 Viewfinder info. during exposure**0: Disable****1: Enable**

The viewfinder information will be displayed even during an exposure. Displays the exposure setting, number of remaining shots, etc., during continuous shooting.

-  When the shooting mode is set to "Bulb", even if setting 1 is set, it will not take effect.

C.Fn II -9 LCD panel illumination during Bulb

0: Off

1: On during Bulb

If the LCD panel illumination is on (p.116) and you take a bulb exposure, the illumination will continue until the bulb exposure ends. This is convenient when you are taking a bulb exposure in low light and want to check the exposure time.

C.Fn II -10 INFO. button when shooting

You can change what is displayed on the LCD monitor when you press the <INFO.> button while the camera is ready to shoot.

0: Displays shooting functions (p.23)

Displays shooting functions as found on the top LCD panel and in the viewfinder.

While the shooting settings are displayed, you can press the <MODE> <AF•DRIVE> <INFO.> <INFO.> <INFO.> or <INFO.> button to display the respective function

screen and turn the <INFO.> or <INFO.> dial to change the setting.

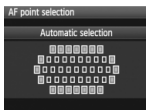
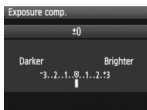
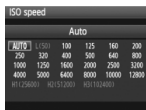
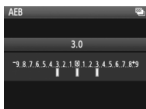
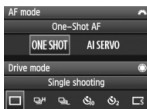
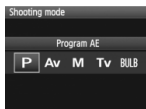

1: Displays camera settings (p.246)

Displays the camera settings.

C.Fn III: Autofocus/Drive

C.Fn III -1 USM lens electronic MF

The USM lens electronic MF can be enabled or disabled when you use any of the following lenses.

EF 50mm f/1.0L USM, EF 85mm f/1.2L USM,
EF 85mm f/1.2L II USM, EF 200mm f/1.8L USM,
EF 300mm f/2.8L USM, EF 400mm f/2.8L USM,
EF 400mm f/2.8L II USM, EF 500mm f/4.5L USM,
EF 600mm f/4L USM, EF 1200mm f/5.6L USM,
EF 28-80mm f/2.8-4L USM

0: Enable after One-Shot AF

After focus is achieved in One-Shot AF, electronic MF is enabled. If C.Fn IV -1-2/3 is set, it is also enabled before focus is achieved.

1: Disable after One-Shot AF

After focus is achieved in One-Shot AF, electronic MF is disabled. If C.Fn IV -1-2/3 is set, it is possible before focus is achieved.

2: Disable in AF mode

Electronic MF is disabled in the AF mode.

C.Fn III -2 AI Servo tracking sensitivity

During focusing in AI Servo AF mode, the AF sensitivity for tracking subjects (or obstacles) moving into the AF points can be set to one of five levels.

If it is set toward **[Slow]**, interruptions by any obstacles will be less disruptive. It makes it easier to keep tracking the target subject.

If it is set toward **[Fast]**, it will be easier to focus any subject which suddenly enters the picture from the side. Convenient when you want to successively photograph multiple subjects located at random distances.

C.Fn III -3 AI Servo 1st/2nd image priority

When AI Servo AF is used with continuous shooting, you can change the Servo's operation characteristics and shutter-release timing.

0: AF priority/Tracking priority

For the first shot, focusing the subject is given priority. For the second and following shots during continuous shooting, focus-tracking of the subject is given priority.

1: AF priority/Drive speed priority

For the first shot, focusing the subject is given priority. During continuous shooting, the continuous shooting speed is given priority over the focus-tracking of the subject.

2: Release/Drive speed priority

For the first shot, shutter release is given priority over focusing the subject. During continuous shooting, the continuous shooting speed is given priority more than with setting 1.

3: Release/Tracking priority

For the first shot, shutter release is given priority over focusing the subject. For the second and following shots during continuous shooting, focus-tracking of the subject is given priority.

C.Fn III -4 AI Servo AF tracking method

In the AI Servo AF mode while you are focus-tracking a subject, the camera can either continue focusing the target subject even if a closer subject (closer than at the main focus point) suddenly appears in the picture, or the camera can switch to focus the closer subject.

- * Main focus point = With automatic AF point selection: Center AF point
 With manual AF point selection + AF point expansion (C.Fn III -8-1/2/3): Manually-selected AF point

0: Main focus point priority

The active AF point will switch to the main focus point and start focusing the closer subject. Convenient when you always want to focus the closest subject.

1: Continuous AF track priority

Any closer subject appearing in the picture will be ignored as an obstruction. The main focus point does not take priority, so the tracking of the target subject can continue and switch to an adjacent AF point based on the preceding focusing result. Convenient when obstacles such as telephone poles appear in front of the target subject.

C.Fn III -5 Lens drive when AF impossible

If focus cannot be achieved with autofocus, the camera can either keep trying to focus or stop.

0: Focus search on**1: Focus search off**

Prevents the camera from becoming grossly out of focus as it attempts to focus again. Especially convenient with super telephoto lenses which can become extremely out of focus.

C.Fn III -6 Lens AF stop button function

* The AF stop button is provided only on super telephoto IS lenses.

0: AF stop**1: AF start**

AF operates only while the button is pressed. While you hold down the button, AF will not work on the camera.

2: AE lock

When the button is pressed, AE lock is applied. Convenient when you want to focus and meter at different parts of the picture.

3: AF point: M → Auto/Auto → Center

In the manual AF point selection mode, the button instantly switches to automatic AF point selection (among 45 AF points) while you hold it down. Convenient when you are no longer able to focus track a moving subject with a manually-selected AF point in the AI Servo AF mode.

In the automatic AF point selection mode, the button selects the center AF point only while you hold it down.

4: ONE SHOT ↔ AI SERVO

In the One-Shot AF mode, the camera switches to AI Servo AF mode only while you hold down the button. And in the AI Servo AF mode, the camera switches to One-Shot AF mode only while you hold down the button.

Convenient when you need to keep switching between One-Shot AF and AI Servo AF for a subject which keeps moving and stopping.

5: IS start

With the lens' IS switch already <ON>, the Image Stabilizer operates when you press the button. The Image Stabilizer will not operate when you press the shutter button halfway.

6: Switch to registered AF point

While holding down the AF Stop button, press the <FEL> button to switch to the registered AF point. Press it again to switch to the previous AF point. To register the AF point, see page 224.

7: Spot AF

The focusing line sensor's active area is made narrower to enable a narrower part to be focused. This works in all AF modes and with any AF point selection method. It is especially convenient during manual AF point selection. However, since it is difficult to keep the AF point on a moving subject, focusing might be difficult. With spot AF, the AF point will blink brighter than usual.

C.Fn III -7 AF Microadjustment

- Normally, this adjustment is not required. Do this adjustment only if necessary. Note that doing this adjustment may prevent correct focusing from being achieved.**

C.Fn III:Autofocus/Drive	7 ↕
AF Microadjustment	↕
0:Disable	
1:Adjust all by same amount	±0
2:Adjust by lens	±0

You can make fine adjustments for the AF's point of focus. It can be adjusted in ± 20 steps (-: Forward / +: Backward).

The adjustment amount of one step varies depending on the maximum aperture of the lens. **Adjust, shoot, and check the focus, then repeat to adjust the AF's point of focus.**

With setting 1 or 2 selected, press the <INFO.> button to view the register screen. To cancel all the registered adjustments, press the <⏏> button.

0: Disable

1: Adjust all by same amount

The same adjustment amount is applied to all lenses.

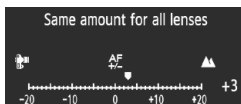

2: Adjust by lens

An adjustment can be set individually for any particular lens. Adjustments for up to 20 lenses can be registered in the camera.

When a lens whose focus adjustment has been registered is attached to the camera, its point of focus will be shifted accordingly.

If adjustments for 20 lenses have already been registered and you want to register an adjustment for another lens, select a lens whose adjustment can be overwritten or deleted.



- When you adjust, shoot, and check the focus to make the adjustment, set the image size to JPEG Large and the JPEG quality (compression) to 8 or higher.
- It is best to make the adjustment at the actual place where you will shoot. This will make the adjustment more precise.
- With setting 2, if an Extender is used, the adjustment will be registered for the lens and Extender combination.
- AF adjustment cannot be done during Live View shooting in Live and Live modes.

C.Fn III -8 AF expansion with selected point

During manual AF point selection, it is possible to activate the AF points surrounding the selected AF point for AF. This function works in both the One-Shot AF and AI Servo AF modes.

Convenient when it is difficult to track a moving subject with just one manually-selected AF point. If the manually-selected AF point cannot focus, focusing will be done with the expanded AF points.

0: Disable

1: Left/right AF point

The points on the immediate left and right (or top and bottom for a vertical shot) of the manually-selected AF point become active.

2: Surrounding AF points

The adjacent AF points surrounding the manually-selected AF point become active.

3: All 45 points area

In the AI Servo AF mode, the autofocus will center on the manually-selected AF point with the row of six AF points right above and below the AF point and the three AF points on the immediate left and right will also become active (total of eighteen AF points). If the subject moves to another AF point within the expanded AF points, the expanded AF will center on that AF point. Since all 45 AF points will operate, as long as the subject is within the Area AF frame, it will be focused at all times.

In the One-Shot AF mode, if focus cannot be achieved with the manually-selected AF point, focusing will be done with the remaining 44 AF points.



- Even when C.Fn III -10-1/2/3/4 is set, the AF point expansion will take effect.
- In AI Servo AF mode, first focus with the manually-selected AF point.
- If there are two manually-selected AF points and setting 1 is set, the AF point on the left and right of the two AF points will become active. If setting 2 is set, up to eight AF points adjacent to the two AF points will become active.
- The AF point expansion centers on the selected AF point. Therefore, if a peripheral AF point is selected, the AF point expansion will be smaller as shown below.

Expanded by one AF point on the left/right



Expanded by one AF point all around



All 45 AF points can be used



■ Selected AF point □ Expansion points

C.Fn III -9 Multi-controller while metering

0: Off

1: AF point selection

During viewfinder shooting while the metering is active, you can select the AF point directly with <AF-ON> instead of pressing the <AE-L/AF-ON> button first.

C.Fn III -10 Selectable AF point

You can change the number of manually-selectable AF points. During automatic AF point selection, all 45 AF points will be selectable regardless of the setting below.

0: 45 points

1: 19 points

Sets the same manually-selectable 19 points as with the EOS-1D Mark III.

2: 11 points

Sets 11 manually-selectable AF points.

3: Inner 9 points

Sets 9 manually-selectable inner AF points.

4: Outer 9 points

Sets 9 manually-selectable outer AF points.



The AF point selection sequence is shown below:

[19 points]

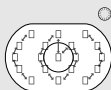
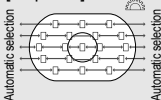

[11 points]

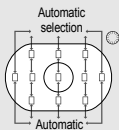
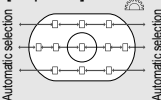

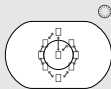
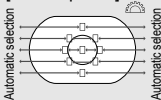

[Inner 9 points]

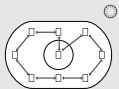
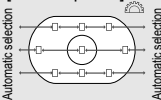

[Outer 9 points]



C.Fn III -11 Switch to registered AF point



You can instantly switch to the registered AF point with  or the  button while the metering timer is active. The AF will operate when the switch is made.

0: Disable

1: Switch with

By pressing , you can switch to the registered AF point. Press it again to switch to the previous AF point.



2: Only while is pressed

You can switch to the registered AF point only while you hold down the  button. When you release the  button, the camera will return to the original AF point.



Registering the AF point

You can register an AF point you use frequently.



1. Select the AF point to be registered. (p.97)
2. While holding down the , press the  button.

-  HP: Automatic selection, **SEL []**: Center AF point,
SEL HP: Off-center AF point

If you change the C.Fn III -10 setting, the registered AF point will be canceled. The camera will switch to the center AF point.

You cannot register multiple AF points.

C.Fn III -12 AF point auto selection

For AF point selection, you can enable or disable automatic selection. The setting before the slash (/) applies to the  dial's function while the metering timer is active with C.Fn IV -3-1/3 set. And the setting after the slash applies to the  dial's function when the  button is pressed.



0: direct:disable/ :enable

When metering is active, the  dial cannot select automatic selection. You can select automatic selection with .

1: direct:disable/ :disable

Automatic selection cannot be selected.

2: direct:enable/ :enable

When metering is active, the  dial can select automatic selection. You can select automatic selection with .

C.Fn III -13 AF point display during focus**0: On****1: Off**

The AF point will not light in red other than during AF point selection.

2: On (when focus achieved)

During AF, the manually-selected AF point will no longer light faintly. After AF starts, the AF point will light only when it achieves focus.

C.Fn III -14 AF point brightness**0: Normal****1: Brighter**

Makes the AF point light up brighter in red.

C.Fn III -15 AF-assist beam firing

Enables or disables the EOS-dedicated Speedlite's AF-assist beam.

0: Enable

The external Speedlite will emit the AF-assist beam when necessary.

1: Disable**2: IR AF assist beam only**

Among external Speedlites, only those which have an infrared AF-assist beam will be able to emit the beam. Set this if you do not want the AF assist to be emitted as small flashes.



The external Speedlite's Custom Function [**AF-assist beam firing**] set to [**Disabled**] will override this Custom Function's 0 and 2 settings. The AF-assist beam will not be emitted.

C.Fn III -16 Orientation linked AF point

You can either use the same AF point or a different AF point for vertical and horizontal shooting.

0: Same for both vertical/horizontal

The same AF point is used for both vertical and horizontal shooting.

1: Select different AF points

A different AF point can be set separately for vertical and horizontal shooting. The camera's orientation is detected automatically and the set AF point switches automatically.

If 1 is set, select separately the AF point (p.97) for the vertical (grip up and down) and horizontal orientations. The AF point selected for the respective orientations will be recorded in the camera.

 If 1 is set and the camera settings are cleared (p.53), the AF points set for the vertical and horizontal orientations will be canceled and the center AF point will be selected.

C.Fn III -17 Mirror lockup

See page 118 for the mirror lockup procedure.

0: Disable



1: Enable

2: Enable: Down with SET (button)



 With setting 1 and 2, the  icon will appear on the top LCD panel.

C.Fn III -18 Continuous shooting speed

Disable: Continuous shooting will be enabled:

<H>: Approx. 10 fps, <L>: Approx. 3 fps

Enable: The continuous shooting speed set with [Register] will be enabled.

Register: <H> can be set within 2 fps to 10 fps, and <L> can be set within 1 fps to 9 fps. After entering the settings, select [Apply].

C.Fn III -19 Limit continuous shot count

- Disable:** Continuous shooting is not limited to any number of shots. Continuous shooting will be possible up to the current maximum burst displayed.
- Enable:** The continuous shooting will be limited to the number of shots set with **[Register]** after which the shooting will stop automatically.
- Register:** The continuous shot count can be limited between 2 to 99. After entering the settings, select **[Apply]**.

C.Fn IV: Operation/Others

C.Fn IV -1 Shutter button/AF-ON button

0: Metering + AF start

1: Metering + AF start/AF stop

Pressing the <AF-ON> button during AF will stop the AF operation.

2: Metering start/Meter + AF start

This is useful for subjects which keep moving and stopping repeatedly. In the AI Servo AF mode, you can press the <AF-ON> button to repeatedly start or stop the AI Servo AF operation. The exposure is set at the moment the picture is taken. Thus, the optimum focusing and exposure will always be achieved as you wait for the decisive moment.

3: AE lock/Metering + AF start

Convenient when you want to focus and meter at different parts of the picture. Press the <AF-ON> button to meter and autofocus, and press the shutter button halfway to attain AE lock.

4: Metering + AF start/Disable

The <AF-ON> button will not function.

C.Fn IV -2 AF-ON/AE lock button switch

0: Disable

1: Enable



The functions of the <AF-ON> and <*/Q> buttons will be switched between them.



C.Fn IV -3 Quick Control Dial in metering

The Quick Control Dial's function while the metering is active can be changed.

0: Exposure compensation/Aperture

1: AF point selection



You can select the AF point directly with the  dial without first pressing the  button. While metering is active, turning the  dial will select a horizontal AF point. Automatic selection cannot be selected. However, if C.Fn III -12-2 has also been set, automatic selection can be selected.





Press the  button and turn the  dial to set the exposure compensation or the aperture for manual exposure.

2: ISO speed

You can turn the  dial to change the ISO speed in real-time.





3: AF point selection + ↔

You can select the AF point directly with the  dial without first pressing the  button. While metering is active, turning the  dial will select a horizontal AF point. Automatic selection cannot be selected. However, if C.Fn III -12-2 has also been set, automatic selection can be selected.

The functions of the  and  buttons will be switched between them. By holding down the  button and turning the  dial, you can set the exposure compensation or aperture.

4: ISO speed + ↔ ISO

You can turn the  dial to change the ISO speed in real-time.

The functions of the  and  buttons will be switched between them. By holding down the  button and turning the  dial, you can set the exposure compensation or aperture.

C.Fn IV -4 Assign SET button

You can assign a frequently-used function to <SET>. Press <SET> when the camera is shooting-ready.

0: Normal (disabled)

1: White balance

While looking at the rear LCD panel, you can change the white balance.

2: Image size

While looking at the rear LCD panel, you can change the card and image size.

3: ISO speed

While looking at the top LCD panel or in the viewfinder, you can change the ISO speed.

4: Picture Style

The Picture Style screen will appear.

5: Record func. + media/folder

The [Record func+media/folder sel.] menu will appear.

6: Menu display

Assigns the same function as the <MENU> button.

7: Image playback

Assigns the same function as the < > button.



If the camera has been set to enable Live View shooting (p.126) or movie shooting (p.142), the Live View or movie shooting will override all of the above settings 1 to 7.

C.Fn IV -5 Tv/Av setting for Manual exposure

0: Tv=/Av=





1: Tv=/Av=

Convenient when you use studio flash and frequently change the aperture.

Also, when you use AEB in the manual exposure mode, the shutter speed can stay fixed while only the aperture is shifted for AEB. The shutter speed can also be set by pressing the < > button and turning the </ < > dial.

C.Fn IV -6 Dial direction during Tv/Av**0: Normal****1: Reverse direction**

The dial's turning direction for setting the shutter speed and aperture can be reversed.

In the manual exposure mode, the direction of the < > and < > dials will be reversed. In other shooting modes, the < > dial will be reversed. The < > dial's turning direction will be the same for the manual exposure mode and exposure compensation.

C.Fn IV -7 Av setting without lens**0: Disable****1: Enable**

You can set the aperture with the camera even while the lens is detached. For studio photography when the aperture is already determined, you can set the aperture beforehand.

C.Fn IV -8 WB + media/image size setting

When you press the <FUNC.> button to select or set the white balance, card, or image size, you can choose to do it with the rear LCD panel or with the menu screen.

0: Rear LCD panel**1: LCD monitor**



When you press the <FUNC.> button, the menu screen will appear. Each time you press the button, the screen will change to display the [**White balance**], [**Image size**], and [**Record func+media/folder sel.**].

 Even with setting 1, if you press the <FUNC.> button during Live View or movie shooting, you can set the settings above while looking at the rear LCD panel.



C.Fn IV -9  button function**0: Protect (hold: Record memo)**

When you hold down the  button for 2 sec., you can start recording a voice memo. When you let go of the button, the voice memo recording will stop.



1: Record memo (Protect: Disabled)

When you press the  button, you can start recording a voice memo immediately. When you let go of the button, the voice memo recording will stop. To protect an image, use the [ **Protect images**] menu option.

2: Play memo (hold: Record memo)



Plays the voice memo appended to the image. Press the  button to play the voice memo. When you hold down the  button for 2 sec. during image playback, you can start recording a voice memo. When you let go of the button, the voice memo recording will stop. To protect an image, use the [ **Protect images**] menu option.

C.Fn IV -10 Button function when  <OFF>**0: Normal (enable)****1: Disable , , Multi-controller**

When the power switch is set to <ON>, the , , and  will be disabled from setting anything. The shutter button can still be used to shoot.

This prevents any settings to be changed inadvertently, so it is convenient when you keep shooting with the same settings.



Even with setting 1, if the power switch is set to <J>, you can use , , and  to change settings.

C.Fn IV -11 Start movie shooting**0: Default (from LV)****1: Quick start (<FEL> button)**

If the [ Live View/Movie func. set.] menu option has been set to enable movie shooting (p.142), press the <FEL> button to start shooting a movie immediately while the camera is ready to shoot.

C.Fn IV -12 Focusing Screen

If you change the focusing screen, change this setting to match the focusing screen type. This is to obtain the correct exposure.

0:  Ec-C IV

Standard focusing screen (Laser-matte).

1:  Ec-A, B, C, C II, C III, D, H, I, L

For Laser-matte screens.

2:  Ec-S

For Super Precision Matte screens.

3:  Ec-N, R

For New Laser-matte screens.

 About Super Precision Matte Ec-S and Maximum Lens Aperture

- This focusing screen is optimized for f/1.8 to f/2.8 lenses.
- If the lens maximum aperture is brighter than f/1.8, the center spot metering circle and Area AF frame might become difficult to see.
- Also, if the lens maximum aperture is slower than f/2.8, the viewfinder will look darker.

-  Since the Ec-A, Ec-B, Ec-I, and Ec-L focusing screens have a prism at the center, correct exposures cannot be obtained with evaluative metering and center spot metering. Use either center-weighted average metering or AF point-linked spot metering (except the center AF point).
- To change the focusing screen, refer to the instructions that come with the focusing screen.

C.Fn IV -13 Timer length for timer

How long the function setting remains in effect after you let go of the respective button can be changed.

Disable: The timer length is set to the default.

Enable: The timer length is set to the time set with **[Register]**.

Register: You can set the 6-sec. and 16-sec. timer length and the timer length after the shutter release. The timer length can be set to 0 sec. to 59 sec. or 1 min. to 60 min. After entering the settings, select **[Apply]**.

- **6 sec. timer**

This timer length will apply to the AE lock started with the metering timer/<★> button.

- **16 sec. timer**

This timer length will apply to multi-spot metering and FE lock with the <FEL> button.

- **Timer after release**

Normally, the timer length is 2 sec. after the shutter release. A longer timer length will make it easier to keep using AE lock for the same exposure.

C.Fn IV -14 Shortened release time lag

Normally, stabilization control is executed for the shutter-release time lag. This stabilization control can be omitted to make the shutter-release time lag shorter.

0: Disable

1: Enable

When the aperture is stopped down to no more than 3 stops from the maximum aperture, the shutter-release time lag will be as much as approx. 20% shorter than normal.

C.Fn IV -15 Add aspect ratio information

During Live View and movie shooting, vertical lines corresponding to the aspect ratio will be displayed. You can thereby simulate still photo framing for medium- and large-format film sizes such as 6x6 cm, 6x4.5 cm, and 4x5 in.

This aspect ratio information will be appended automatically to the captured image. (The image will not be saved to the card as a cropped image.)

When the image is transferred to a personal computer and Digital Photo Professional (provided software) is used, the image will be displayed in the aspect ratio you specified.

0: Off**4: Aspect ratio 6:7****1: Aspect ratio 6:6****5: Aspect ratio 10:12****2: Aspect ratio 3:4****6: Aspect ratio 5:7****3: Aspect ratio 4:5**

- Aspect ratio information will also be appended during viewfinder shooting.
- During image playback on the camera, vertical lines for the respective ratio will be displayed.

C.Fn IV -16 Add image verification data**0: Disable****1: Enable**

Data for verifying whether the image is original or not is appended to the image automatically. When the shooting information of an image appended with the verification data is displayed (p.157), the  icon will appear.

To verify whether the image is original, the Original Data Security Kit OSK-E3 (sold separately) is required.

MENU Registering and Applying Custom Function Settings

You can register up to three sets of Custom Function settings. You can register a different set of Custom Function settings for different shooting situations such as sports, snapshots, and landscapes. You can then instantly apply a registered set of Custom Function settings.

Registering Custom Function Settings

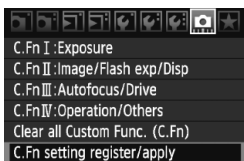

1 Select [C.Fn setting register/apply].

- Under the [] tab, select [**C.Fn setting register/apply**], then press < >.

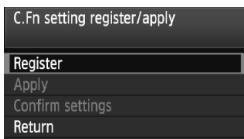

2 Select [Register].

- Turn the < > dial to select [**Register**], then press < >.

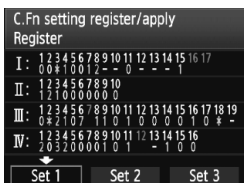



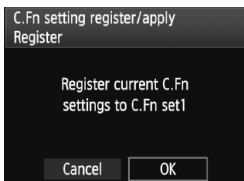

3 Select [Set].

- Check the settings.
- Turn the < > dial to select [**Set ***], then press < >.



4 Select [OK].

- Turn the < > dial to select [**OK**], then press < >.
- ▶ The Custom Function settings will be registered under [**Set ***], and the Custom Function settings will be displayed in a list. To return to the screen in step 2, press < >.

 The settings for [ **C.Fn I -16: AE Microadjustment**], [ **C.Fn I -17: FE Microadjustment**], [ **C.Fn III -7: AF Microadjustment**], and [ **C.Fn IV -12: Focusing Screen**] will not be included in the registered Custom Function settings.

 To view the registered Custom Function settings, select [**Confirm settings**]. The numbers of options changed from the default setting are displayed in blue. Also, non-numerical settings are displayed by a blue [*].

Applying Custom Function Settings

In step 2, select [**Apply**] and select the [**Set ***] of the Custom Function settings to be applied. Select [**OK**], and the Custom Function settings will switch to those registered under Set *.

MENU Registering My Menu

Under the My Menu tab, you can register up to six menu options and Custom Functions whose settings you change frequently.

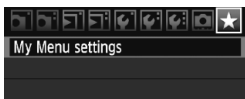

1 Select [My Menu settings].

- Under the [★] tab, select [My Menu settings], then press <SET>.

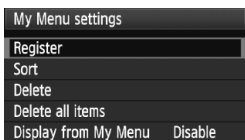

2 Select [Register].

- Turn the <DIAL> dial to select [Register], then press <SET>.

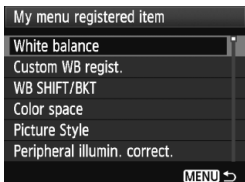

3 Register the desired items.

- Turn the <DIAL> dial to select the item, then press <SET>.
- On the confirmation dialog, select [OK] and press <SET> to register the item.
- You can register up to six items in My Menu.
- To return to the screen in step 2, press the <MENU> button.

About My Menu settings

● Sort

You can change the order of the registered items in My Menu. Select [Sort] and select the item whose order you want to change. Then press <SET>. With [◆] displayed, turn the <DIAL> dial to change the order, then press <SET>.

● Delete / Delete all items

Deletes the registered items. [Delete] deletes one item at a time, and [Delete all items] deletes all items.

● Display from My Menu

When [Enable] is set, the [★] tab will be displayed first when you display the menu screen.

MENU Saving and Loading Camera Settings

The camera's shooting modes, menus, Custom Functions, and other camera settings can be saved in the card as a camera settings file. When this file is loaded by the camera, the saved camera settings will be applied.

Convenient when you want to load the camera settings from a different EOS-1D Mark IV body and set the camera in the same way. Or you can save and load different camera settings for different shooting situations.

Saving Camera Settings



1 Select [Save/load settings on media].

- Under the [] tab, select [Save/load settings on media], then press <SET>.

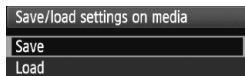

2 Select [Save].

- Turn the < > dial to select [Save], then press <SET>.



3 Select [Start].

- Turn the < > dial to select [Start], then press <SET>.
- ▶ The camera settings will be saved to the card, and the screen in step 2 will reappear.











- If you select [Change file name], you can change the file name (8 characters) and save the file. For the procedure, see “Changing the File Name” on page 86. The number of characters that can be entered will be different, but the procedure for entering the file name is the same.

Saved Settings

● Shooting functions

Shooting mode + setting, ISO speed, AF mode, AF point, Metering mode, Drive mode, Exposure compensation amount, Flash exposure compensation amount

● Menu functions

- [] White balance, Custom WB registration, WB SHIFT/BKT, Color space, Picture Style, Peripheral illumination correction
- [] JPEG quality, Image size, Review time, Beep, Release shutter without card, External Speedlite control (Flash function settings)
- [] Highlight alert, AF point display, Histogram, Enlarge display, Image jump w/ 
- [] Auto power off, Record func+media/folder sel. (Recording function), File numbering, File name setting, Auto rotate
- [] LCD brightness, Live View/Movie function setting
- [] Sensor cleaning (Auto cleaning)
- [] Custom Functions
- [] My Menu

Loading Camera Settings

In step 2, select [**Load**]. Up to ten camera settings files saved in the card will be displayed. When you select the desired file, it will be loaded and the settings will be applied to the camera.



- The date/time, language, video system, and C.Fn I -16, C.Fn I -17, C.Fn III -7, C.Fn IV -12 settings will not be saved.
- Up to ten camera settings files can be saved in a card. If the card already has ten camera settings files, you can either overwrite an existing file or use another card.
- Camera settings files saved with a camera other than the EOS-1D Mark IV cannot be loaded.

MENU Registering and Applying Basic Camera Settings

You can set the basic settings of major functions such as the shooting mode, AF mode, metering mode, and drive mode and register them in the camera. This is convenient when you want to instantly switch to frequently-used shooting settings.

Registering Basic Settings



1 Select [Regist/apply basic settings].

- Under the [**F**] tab, select [**Regist/apply basic settings**], then press <SET>.

2 Select [Register].

- Turn the <DISP> dial to select [**Register**], then press <SET>.

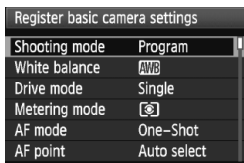

3 Select a function.

- Turn the <DISP> dial to select the function, then press <SET>.
- Up to nine settings such as the shooting mode, white balance, and drive mode can be set.



4 Set the function as desired.

- Turn the <DISP> dial to select the desired setting, then press <SET>.

5 Exit the setting.

- To exit the setting and return to the screen in step 2, press the <MENU> button.

Applying Basic Settings

In step 2, select [**Apply**]. The camera settings will switch to the registered settings.

 [**Record func.**] will also be set to [**Standard**], and the exposure compensation, AEB, flash exposure compensation, and WB correction/BKT will all be canceled.

11

Reference

This chapter provides reference information for camera features, system accessories, etc. The back of this chapter also has an index to make it easier to look up needed information.

Function Availability Table

● : Set automatically ○ : User selectable □ : Not selectable/Disabled

Function		Viewfinder Shooting					📷 LV Shooting	🎬 Movie Shooting
		P	Tv	Av	M	Bulb		
Image size	JPEG	○	○	○	○	○	○	(Still photo)
	RAW	○	○	○	○	○	○	
	RAW+JPEG	○	○	○	○	○	○	
ISO speed	Auto	○	○	○	○	○	○	○
	Manual	○	○	○	○	○	○	Enabled in M movie mode
Picture Style	Standard	○	○	○	○	○	○	○
	Portrait	○	○	○	○	○	○	○
	Landscape	○	○	○	○	○	○	○
	Neutral	○	○	○	○	○	○	○
	Faithful	○	○	○	○	○	○	○
	Monochrome	○	○	○	○	○	○	○
	User Defined	○	○	○	○	○	○	○
White balance	Auto WB	○	○	○	○	○	○	○
	Preset WB	○	○	○	○	○	○	○
	Custom WB	○	○	○	○	○	○	○
	Color temperature setting	○	○	○	○	○	○	○
	WB correction	○	○	○	○	○	○	○
	WB-BKT	○	○	○	○	○	○	(Still photo)
Color space	sRGB	○	○	○	○	○	○	●
	Adobe RGB	○	○	○	○	○	○	□
Auto Lighting Optimizer		○	○	○	○	○	○	○
Lens peripheral illumination correction		○	○	○	○	○	○	○
Long exposure noise reduction		○	○	○	○	○	○	□
High ISO speed noise reduction		○	○	○	○	○	○	(Still photo)
Highlight tone priority		○	○	○	○	○	○	○

●: Set automatically ○: User selectable □: Not selectable/Invalid

Function		Viewfinder Shooting					📷 LV Shooting	🎬 Movie Shooting
		P	Tv	Av	M	Bulb		
AF	One-Shot	○	○	○	○	○	With AF ^{Quick}	
	AI Servo	○	○	○	○	○		
	AF point selection	Auto	○	○	○	○	○	With AF ^{Quick}
		Manual	○	○	○	○	○	
	Live mode						○	○
	☺ Live mode						○	○
Quick mode						○	Before shooting starts	
Metering	Evaluative	○	○	○	○	○	●	With AF ☺
	Partial	○	○	○	○	○		
	Spot	○	○	○	○	○		
	Center-weighted average	○	○	○	○	○		●
Exposure	Program shift	○					○	
	Exposure compensation	○	○	○			○	Other than M movie mode
	AE lock	○	○	○			○	
	AEB	○	○	○	○		○	
	Depth-of-field preview	○	○	○	○	○	○	
Drive	Single shooting	○	○	○	○	○	○	(Still photo)
	High-speed continuous shooting	○	○	○	○	○	○	
	Low-speed continuous shooting	○	○	○	○	○	○	
	10-sec. self-timer	○	○	○	○	○	○	
	2-sec. self-timer	○	○	○	○	○	○	
	Silent single shooting	○	○	○	○	○	○	(Still photo)
External Speedlite	FE lock	○	○	○	○	○		
	Flash exposure compensation	○	○	○	○	○	○	

System Map

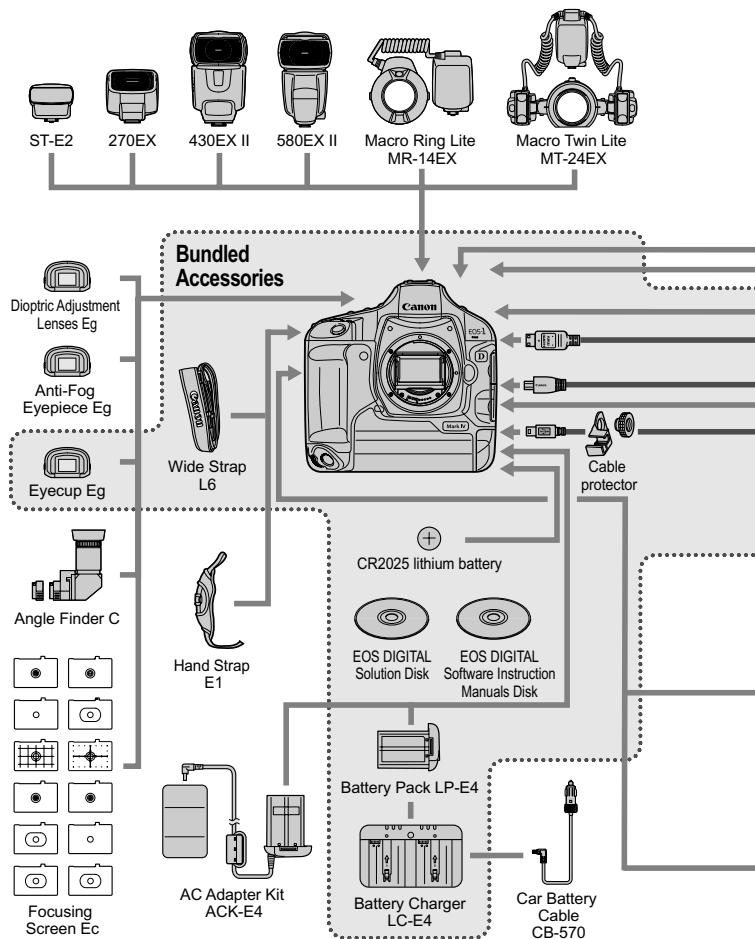

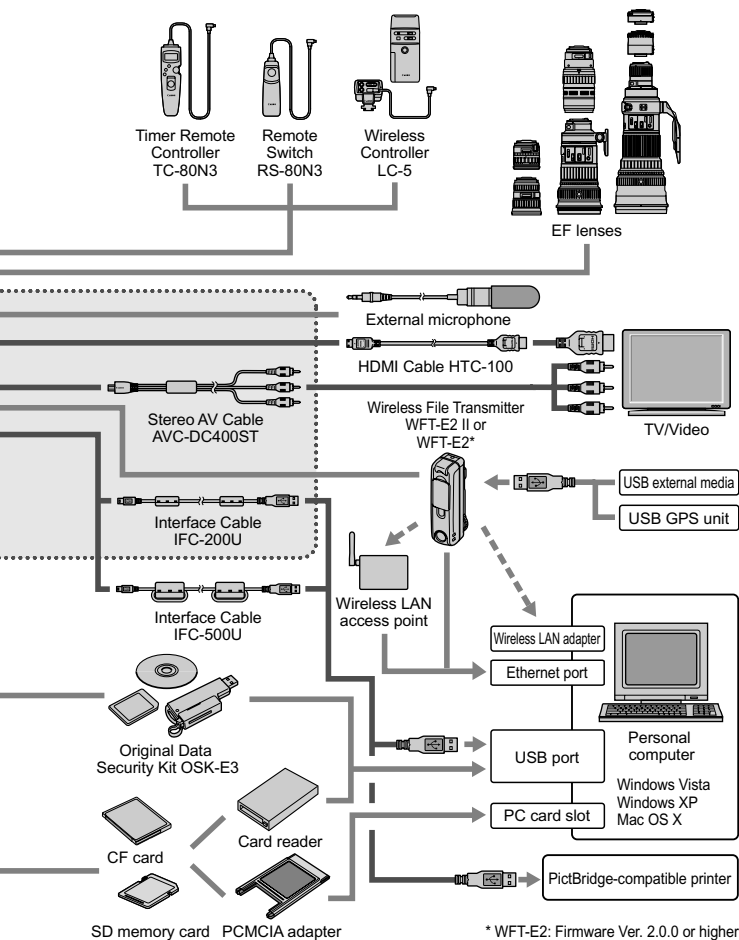

INFO. Checking Camera Settings

With [**C.Fn II -10: INFO. button when shooting**] (p.217) set to [**1: Displays camera settings**], pressing the <INFO.> button while the camera is ready to shoot will display image-related function settings.

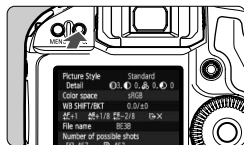

Display the camera settings.

- While the camera is ready to shoot, press the <INFO.> button.

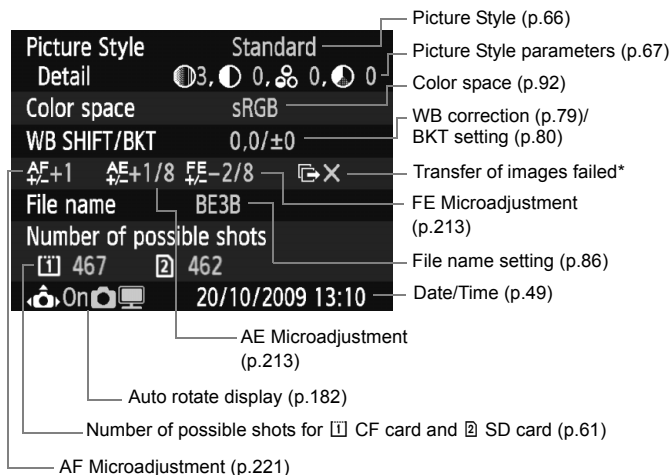

* Displayed only if Wireless File Transmitter WFT-E2 II or WFT-E2 is used and the transfer of some images failed.



 As the default setting, when you press the <INFO.> button, the shooting function settings will be displayed (p.23).

MENU Checking the Battery Information

You can check the battery's condition on a menu screen.



Select [Battery info.].

- Under the [] tab, select [**Battery info.**], then press <  >.

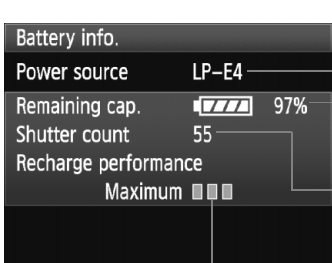



The model of the battery or household power source (sold separately) being used is displayed.

Next to the battery check (p.35), the remaining battery capacity is displayed in 1% increments.

Shots taken with the current battery. The number is reset when the battery is recharged.

Battery's recharge performance level is displayed in one of three levels (p.29).

 (Green): Battery's recharge performance is fine.

 (Green): Battery's recharge performance is slightly degraded.

 (Red): Purchasing a new battery is recommended.



Do not use any battery other than Battery Pack LP-E4. Otherwise, the camera's full performance may not be attained or malfunction may result.



- The shutter count is the number of still photos taken. (Movies are not counted.)
- If [**Calibration is recommended when charging battery next time**] is displayed, see page 30.
- If you set the power switch to < ON / J > and communication with the battery is faulty for some reason, [**Cannot communicate with battery**] will be displayed. Select [**OK**] and you can continue shooting. In such a case, the <  > battery check icon will light on the top LCD panel.

Replacing the Date/Time Battery

The date/time (back-up) battery's service life is approx. 5 years. If the date/time is reset when the camera is turned on, replace the back-up battery with a new CR2025 lithium battery as described below.

The date/time setting will also be reset, so be sure to set the correct date/time (p.49).

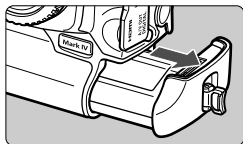

1 Set the power switch to <OFF> and remove the battery pack.

- The back-up battery is on the ceiling of the battery compartment.

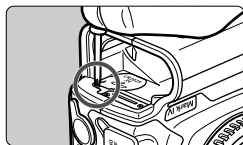

2 Remove the back-up battery cover.

- Use a small screwdriver to loosen the screw and remove the cover.
- Be careful not to lose the cover and screw.



3 Remove the battery.

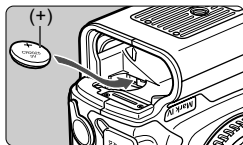

4 Install a new back-up battery.

- The plus side of the battery must face up.

5 Attach the cover.

 For the date/time battery, be sure to use a CR2025 lithium battery.

Troubleshooting Guide

If there is a problem, first refer to this Troubleshooting Guide on pages 249 to 255. If this Troubleshooting Guide does not resolve the problem, contact your dealer or nearest Canon Service Center.

Power-Related Problems

The battery cannot be recharged with the battery charger provided.

- Do not recharge any battery pack other than a genuine Canon Battery Pack LP-E4.

The battery charger's <CAL/CHARGE> lamp blinks in red. The charger's lamp blinks three times.

- See pages 30 and 31.

The camera does not operate even when the power switch is set to <ON>.

- The battery is not properly installed in the camera (p.32).
- Recharge the battery (p.28).
- Make sure the card slot cover is closed (p.36).

The access lamp still blinks even when the power switch is set to <OFF>.

- If the power is cut off while an image is being recorded to the card, the access lamp will still continue to light/blink for a few seconds. When the image recording is completed, the power will turn off automatically.

The battery becomes exhausted quickly.

- Use a fully-charged battery (p.28).
- The battery performance might have degraded. See the [**Battery info.**] menu option to check the battery's performance level (p.247). If the battery's performance level has degraded, purchase a new battery.
- If you keep displaying the shooting function setting screen (p.23) or using Live View shooting or movie shooting (p.125, 141) for a prolonged period, the number of possible shots will decrease.

The camera turns off by itself.

- Auto power off is in effect. If you do not want auto power off to take effect, set [ Auto power off] to [Off].

Shooting-Related Problems

The lens cannot be attached.

- The camera cannot be used with EF-S lenses (p.39).

The card cannot be used.

- If a card error message is displayed, see page 38 or 256.

No images can be shot or recorded.

- The card is not properly inserted (p.36).
- If you are using an SD card, set the write-protect switch upward (p.36).
- If the card is full, replace the card or delete unnecessary images to make room (p.36, 179).
- If you try to focus in One-Shot AF mode while the focus confirmation light <●> in the viewfinder blinks, a picture cannot be taken. Press the shutter button halfway again to focus, or focus manually (p.41, 95, 100).

The image is out of focus.

- Set the lens focus mode switch to <AF> (p.39).
- To prevent camera shake, hold the camera still and press the shutter button gently (p.40, 41).
- If the lens has an Image Stabilizer, set the IS switch to <ON>.

A darker exposure was set with exposure compensation, but the image looks bright.

- Set [ C.Fn II -4: Auto Lighting Optimizer] to [3: Disable]. If it is set to [Standard/Low/Strong], the image might still come out bright even if you set a darker exposure with manual exposure, exposure compensation, or flash exposure compensation (p.81, 215).

The maximum burst during continuous shooting is lower.

- Set [ C.Fn II -2: High ISO speed noise reduction] to one of the following settings: [Standard/Low/Disable]. If it is set to [Strong], the maximum burst will greatly decrease (p.214).
- If you shoot a subject which has fine detail (field of grass, etc.), the file size will be larger and the actual maximum burst might be lower than the number mentioned on page 61.

ISO 100 cannot be set.

- If [ C.Fn II -3: Highlight tone priority] is set to [Enable], the settable ISO speed range starts from ISO 200. If [Disable] is set, ISO 100 can be set (p.215).

When I use the <Av> mode with flash, the shutter speed becomes slow.

- If you shoot at night when the background is dark, the shutter speed becomes slow automatically (slow-sync shooting) so that both the subject and background are properly exposed. If you do not want a slow shutter speed to be set, set [ C.Fn I -15: Flash sync. speed in Av mode] to 1 or 2 (p.212).

The flash does not fire.

- Make sure the flash (or PC sync cord) is securely attached to the camera.

The flash always fires at full output.

- If you use a flash unit other than an EX-series Speedlite, the flash will always be fired at full output (p.120).
- When the [Flash metering mode] flash Custom Function is set to [TTL (autoflash)], the flash will always be fired at full output (p.124).

Flash exposure compensation cannot be set.

- If flash exposure compensation has already been set with the Speedlite, flash exposure compensation cannot be set with the camera. When the Speedlite's flash exposure compensation is canceled (set to 0), flash exposure compensation can be set with the camera.

High-speed sync cannot be set in the Av mode.

- Set [C.Fn I -15: Flash sync. speed in Av mode] to [0: Auto] (p.212).

Live View shooting is not possible.

- For Live View shooting, use a memory card (a hard disk-type card is not recommended). A hard disk-type card requires a lower temperature range for operation than memory cards. If the temperature gets too high, the Live View shooting may stop temporarily to prevent damage to the card's hard disk. When the camera's internal temperature decreases, you can resume Live View shooting (p.139).



During Live View shooting, the ISO speed, shutter speed, and aperture cannot be set.

- Set [LV / set.] to [Stills] (p.126).

The shutter makes two shooting sounds during Live View shooting.

- During Live View shooting, the shutter will make two sounds when you take a picture (p.127).

Movies cannot be shot with manual exposure.

- Set [LV /  set.] to [Movies] and set the shooting mode to <M> (manual exposure) (p.142, 144).

The movie shooting terminates by itself.

- If the card's writing speed is slow, movie shooting may stop automatically. If you use a CF card, use one with a read/write speed of at least 8 MB per sec. If you use an SD card, use one with SD Speed Class 6 "CLASS⑥" or higher. To find out the card's read/write speed, see the card manufacturer's Web site, etc.
- If the movie file size reaches 4 GB or if the movie recording time reaches 29 min. 59 sec., movie shooting will stop automatically.

The subject looks distorted during movie shooting.

- During movie shooting, if you move the camera left or right quickly (high-speed panning) or shoot a moving subject, the image might look distorted. There might be less distortion if you shoot in the 1280x720 or 640x480 movie recording size (p.151).

When I shoot still photos during movie shooting, the movie shooting stops.

- To shoot still photos during movie shooting, using a CF card compatible with UDMA transfer rates is recommended.
- Setting a smaller image size for still photos and shooting fewer continuous still photos can also resolve the problem.

The movie cannot play.

- Movies edited with a personal computer using the provided software, etc., cannot be played with the camera.

When the movie is played, camera operation noise can be heard.

- If you operate the camera's dial or lens during movie shooting, the respective operation noise will also be recorded. Using an external microphone (commercially available) is recommended (p.153).

Display & Operation Problems

The LCD monitor does not display a clear image.

- If the LCD monitor is dirty, use a soft cloth to clean it.
- In low or high temperatures, the LCD monitor display may seem slow or might look black. It will return to normal at room temperature.

Part of the image blinks in black.

- The [☐] **Highlight alert** menu option is set to **[Enable]** (p.157).

A red box is displayed on the image.

- The [☐] **AF point disp.** menu option is set to **[Enable]** (p.158).

The image cannot be erased.

- If the image has been protected, it cannot be erased (p.172).

The file name's first character is an underscore (" _").

- Set the color space to sRGB. If Adobe RGB is set, the first character will be an underscore (p.92).

The fourth character in the file name changes.

- With the [☐] **File name setting** menu option, select the camera's unique file name or the file name registered under User setting 1 (p.86).

The file numbering does not start from 0001.

- If you use a card which already has images recorded, the file numbering might start from the last image in the card (p.88).



The shooting date and time displayed is incorrect.

- The correct date and time has not been set (p.49).

No image appears on the TV screen.

- Make sure the stereo AV cable or HDMI cable's plug is connected all the way in (p.170, 171).
- Set the video OUT format (NTSC/PAL) to the same video format as the TV (p.170).
- Use the stereo AV cable that came with the camera (p.170).

The voice memo cannot be played.

- Set [ C.Fn IV -9:  button function] to [2: Play memo (hold: Record memo)] (p.175, 231).

Sensor Cleaning Problems**The shutter makes a noise during sensor cleaning.**

- If you selected [Clean now ], the shutter will make a noise three times (p.184).

Printing-Related Problems**There are fewer printing effects than listed in the instruction manual.**

- What is displayed on the screen differs depending on the printer. This instruction manual lists all the printing effects available (p.194).

Error Codes

Error No.

If there is a problem with the camera, an error message will appear. Follow the on-screen instructions.



Countermeasures

No.	Error Message & Solution
01	Communications between the camera and lens is faulty. Clean the lens contacts.
	→ Clean the electrical contacts on the camera and lens and use a Canon lens. (p.13, 16)
02	Card * cannot be accessed. Reinsert/change card * or format card * with camera.
	→ Remove and install the card again, replace the card, or format the card (p.36, 50).
04	Cannot save images because card * is full. Replace card *.
	→ Replace the card, erase unnecessary images, or format the card (p.36, 179, 50).
06	Sensor cleaning is not possible. Turn the camera off and on again.
	→ Operate the power switch (p.34).
10, 20, 30, 40, 50, 60, 70, 80, 99	Shooting is not possible due to an error. Turn the camera off and on again or re-install the battery.
	→ Operate the power switch, remove and install the battery pack again, or use a Canon lens (p.34, 32).

* If the error still persists, write down the error No. and contact your nearest Canon Service Center.

Specifications

• Type

Type:	Digital, single-lens reflex, AF/AE camera
Recording media:	CF card (Type I or II, UDMA-compatible), SD memory card, SDHC memory card * With Wireless File Transmitter WFT-E2 II or WFT-E2 (with firmware Ver. 2.0.0 or higher), recording to USB external media possible
Image sensor size:	27.9 x 18.6 mm
Compatible lenses:	Canon EF lenses (except EF-S lenses) (35mm-equivalent focal length is approx. 1.3 times the lens focal length)
Lens mount:	Canon EF mount

• Image Sensor

Type:	CMOS sensor
Effective pixels:	Approx. 16.10 megapixels
Aspect ratio:	3:2
Dust delete feature:	Auto, Manual, Dust Delete Data appending

• Recording System

Recording format:	Design rule for Camera File System 2.0
Image type:	JPEG, RAW (14-bit Canon original) RAW+JPEG simultaneous recording possible
Recorded pixels:	Large : Approx. 16.00 megapixels (4896 x 3264) Medium 1: Approx. 12.40 megapixels (4320 x 2880) Medium 2: Approx. 8.40 megapixels (3552 x 2368) Small : Approx. 4.00 megapixels (2448 x 1632) RAW : Approx. 16.00 megapixels (4896 x 3264) M-RAW : Approx. 9.00 megapixels (3672 x 2448) S-RAW : Approx. 4.00 megapixels (2448 x 1632)
Recording function:	Standard, Auto switch media, Rec. separately, Rec. to multiple
Create/select a folder:	Possible
File name:	Preset code, User setting 1, User setting 2
File numbering:	Consecutive numbering, auto reset, manual reset

• Image Processing

Picture Style:	Standard, Portrait, Landscape, Neutral, Faithful, Monochrome, User Def. 1 - 3
White balance:	Auto, Preset (Daylight, Shade, Cloudy, Tungsten light, White fluorescent light, Flash), Custom (total 5 settings), Color temperature setting (2500-10000K), personal white balance (total 5 settings) White balance correction and white balance bracketing features provided * Color temperature information transmission enabled
Noise reduction:	Applicable to long exposures and high ISO speed shots
Automatic image brightness correction:	Auto Lighting Optimizer
Highlight tone priority:	Provided
Lens peripheral illumination correction:	Provided

• Viewfinder

Type:	Eye-level pentaprism
Coverage:	Vertical/Horizontal approx. 100%
Magnification:	Approx. 0.76x (-1 m ⁻¹ diopter with 50mm lens at infinity)
Eye point:	Approx. 20 mm (From eyepiece lens center at -1 m ⁻¹)
Built-in dioptic adjustment:	-3.0 - +1.0 m ⁻¹ (dpt)
Eyepiece shutter:	Built-in
Focusing screen:	Ec-C IV provided, interchangeable
Mirror:	Quick-return type
Depth-of-field preview:	Provided

• Autofocus

Type:	TTL secondary image-registration, phase detection
AF points:	45 points (39 cross-type points + 6 points)
Metering range:	EV -1 - 18 (at 23°C/73°F, ISO 100)
Focus modes:	One-Shot AF, AI Servo AF, Manual focusing (MF)
AF-assist beam:	Emitted by the dedicated external Speedlite
AF fine adjustment:	Enabled with AF Microadjustment

• Exposure Control

Metering modes:	63-zone TTL full-aperture metering <ul style="list-style-type: none"> • Evaluative metering (linkable to any AF point) • Partial metering (approx. 13.5% of viewfinder at center) • Spot metering (approx. 3.8% of viewfinder at center) • Center-weighted average metering
Metering range:	EV 0 - 20 (at 23°C/73°F with EF 50mm f/1.4 USM lens, ISO 100)
Exposure control:	Program AE, shutter-priority AE, aperture-priority AE, manual exposure, bulb exposure
ISO speed: (Recommended exposure index)	Auto (ISO Auto), manual setting within ISO 100 - 12800 (1/3- or whole-stop increments) and expandable to L (ISO 50), H1 (ISO 25600), H2 (ISO 51200), H3 (ISO 102400)
Exposure compensation:	Manual and AEB (Settable in combination with manual exposure compensation) Settable amount: ±3 stops in 1/3- or 1/2-stop increments
AE lock:	Auto: Applied in One-Shot AF mode with evaluative metering when focus is achieved Manual: By AE lock button
Standard exposure level adjustment:	AE Microadjustment possible

• Shutter

Type:	Electronically-controlled, focal-plane shutter
Shutter speeds:	1/8000 sec. to 30 sec., bulb (Total shutter speed range. Available range varies by shooting mode.) X-sync at 1/300 sec. (with EOS-dedicated external Speedlite)

• Drive System

Drive modes:	Single, High-speed continuous, Low-speed continuous, 10-sec. self-timer, 2-sec. self-timer, and Silent single shooting
Continuous shooting speed:	Max. approx. 10 shots/sec.
Max. burst:	JPEG Large: Approx. 85 shots (Approx. 121 shots) RAW: Approx. 26 shots (Approx. 28 shots) RAW+JPEG Large: Approx. 20 shots (Approx. 20 shots) * Figures are based on Canon's testing standards (High-speed continuous, JPEG quality: 8, ISO 100, and Standard Picture Style) and a 4GB card. * Figures in parentheses apply to an Ultra DMA (UDMA) mode 6 16GB card based on Canon's testing standards.

• External Speedlite

Compatible flash:	EX-series Speedlite (Functions settable with the camera)
Flash metering:	E-TTL II autoflash
Flash exposure compensation:	±3 stops in 1/3- or 1/2-stop increments
FE lock:	Provided
PC terminal:	Provided
Standard flash exposure level adjustment:	FE Microadjustment possible

• Live View Shooting

Focusing:	Live mode, Face detection Live mode (Contrast detection), Quick mode (Phase-difference detection) Manual focusing (5x/10x magnification possible)
Metering modes:	Evaluative metering with the image sensor
Metering range:	EV 0 - 20 (at 23°C/73°F with EF 50mm f/1.4 USM lens, ISO 100)
Grid display:	Two types

• Movie Shooting

Movie compression:	MPEG-4 AVC/H.264 Variable (average) bit rate
Audio recording format:	Linear PCM
Recording format:	MOV
Recording size and frame rate:	1920x1080 (Full HD): 30p/25p/24p 1280x720 (HD) : 60p/50p 640x480 (SD) : 60p/50p * 30p: 29.97 fps, 25p: 25.0 fps, 24p: 23.976 fps, 60p: 59.94 fps, 50p: 50.0 fps
File size:	1920x1080 (30p/25p/24p): Approx. 330 MB/sec. 1280x720 (60p/50p) : Approx. 330 MB/sec. 640x480 (60p/50p) : Approx. 165 MB/sec.
Focusing:	Same as focusing with Live View shooting
Metering modes:	Center-weighted average and evaluative metering with the image sensor * Automatically set by the focusing mode
Metering range:	EV 0 - 20 (at 23°C/73°F with EF 50mm f/1.4 USM lens, ISO 100)
Exposure control:	Program AE (exposure compensation possible) for movies and manual exposure

ISO speed:	During autoexposure shooting: Automatically set During manual exposure shooting: Auto (ISO Auto), manual setting within ISO 100 - 12800 (1/3- or whole-stop increments) and expandable to H1 (ISO 25600), H2 (ISO 51200), H3 (ISO 102400)
Sound recording:	Built-in monaural microphone External stereo microphone terminal provided
Grid display:	Two types

• LCD Monitor

Type:	TFT color liquid-crystal monitor
Monitor size and dots:	3-in. with approx. 920,000 dots (VGA)
Coverage:	Approx. 100%
Brightness adjustment:	Manual (7 levels)
Interface language:	25

• Image Playback

Image display formats:	Single, Single + Info (Image size, shooting information, histogram), 4-image index, 9-image index, image rotate possible
Zoom magnification:	Approx. 1.5x - 10x
Image browsing methods:	Single image, jump by 10 or 100 images, by shooting date, by folder, movies only, stills only
Highlight alert:	Overexposed highlights blink
AF point display:	Possible
Slide show:	All images, by folder, by date, movies, or stills
Image protect:	Possible
Copying images:	Possible
Backup:	With Wireless File Transmitter WFT-E2 II or WFT-E2 (with firmware Ver. 2.0.0 or higher), backing up to external media possible
Voice memo:	Recording/playback possible
Movie playback:	Enabled (LCD monitor, video/audio OUT, HDMI OUT) Built-in speaker

• Direct Printing

Compatible printers:	PictBridge-compatible printers
Printable images:	JPEG and RAW images
Print ordering:	DPOF Version 1.1 compatible

• Custom Functions

Custom Functions:	62 under C.Fn I to IV
C.Fn setting registration:	Three sets can be registered
Save camera settings:	Up to ten sets can be registered in a card
Register basic camera settings:	Up to nine settings can be set
My Menu registration:	Up to six options can be registered
Copyright information:	Entry and inclusion enabled

• Interface

Audio/video OUT/ Digital terminal:	Analog video (Compatible with NTSC/PAL)/stereo audio output For personal computer communication and direct printing (Hi-Speed USB equivalent)
HDMI mini OUT terminal:	Type C (Auto switching of resolution)
External microphone IN terminal:	3.5mm dia. stereo mini-jack
Remote control terminal:	Compatible with N3-type remote control
System extension terminal:	Connects to Wireless File Transmitter WFT-E2 II or WFT-E2 (with firmware version 2.0.0 or higher)

• Power Source

Battery:	Battery Pack LP-E4 (Quantity 1) * AC power can be supplied via AC Adapter Kit ACK-E4 (sold separately)
Battery information:	Six-level battery check, remaining capacity, shutter count, and performance can be checked
Battery life:	With viewfinder shooting: Approx. 1500 shots at 23°C/73°F, approx. 1200 shots at 0°C/32°F With Live View shooting: Approx. 270 shots at 23°C/73°F, approx. 230 shots at 0°C/32°F * Based on CIPA testing standards
Maximum movie shooting time:	Approx. 2 hr. 40 min. total at 23°C/73°F Approx. 2 hr. 20 min. total at 0°C/32°F * With fully-charged Battery Pack LP-E4
Date/Time battery:	One CR2025 lithium battery

• Dimensions and Weight

Dimensions (W x H x D): 156 x 156.6 x 79.9 mm / 6.1 x 6.2 x 3.1 in.

Weight: Approx. 1180 g / 41.6 oz. (body only)

• Operation Environment

Working temperature range: 0°C - 45°C / 32°F - 113°F

Working humidity: 85% or less

• Battery Pack LP-E4

Type: Rechargeable lithium ion battery

Rated voltage: 11.1 V DC

Battery capacity: 2300 mAh

Dimensions (W x H x D): 68.4 x 34.2 x 92.8 mm / 2.7 x 1.3 x 3.7 in.

Weight: Approx. 180 g / 6.3 oz. (excluding protective cover)

• Battery Charger LC-E4

Type: Charger dedicated to the Battery Pack LP-E4

Recharging time: Approx. 120 min. (for 1 pack)

Rated input: 100 - 240 V AC (50/60 Hz)

12 V / 24 V DC

Rated output: 12.6 V DC, 1.55A

Power cord length: Approx. 2 m / 6.6 ft.

Working temperature range: 0°C - 40°C / 32°F - 104°F

Working humidity: 85% or less

Dimensions (W x H x D): 155 x 52.3 x 95 mm / 6.1 x 2.1 x 3.7 in.

Weight: Approx. 340 g / 12.0 oz. (excluding power cord and protective covers)

- All specifications above are based on Canon's testing standards.
- Product specifications and the exterior are subject to change without notice.
- If a problem occurs with a non-Canon lens attached to the camera, consult the respective lens maker.

Trademarks

- Adobe is a trademark of Adobe Systems Incorporated.
 - Windows is a trademark or registered trademark of Microsoft Corporation in the United States and other countries.
 - Macintosh and Mac OS is a trademark or registered trademark of Apple Inc. in the United States and other countries.
 - CompactFlash is a trademark of SanDisk Corporation.
 - The SDHC logo is a trademark.
 - HDMI, HDMI logo, and High-Definition Multimedia Interface are a trademark or registered trademark of HDMI Licensing LLC.
 - All other corporate and product names and trademarks mentioned in this manual are the property of their respective owners.
- * This digital camera supports Design rule for Camera File System 2.0 and Exif 2.21 (also called “Exif Print”). Exif Print is a standard that enhances compatibility between digital cameras and printers. By connecting the camera to an Exif Print-compliant printer, the shooting information is incorporated to optimize the print output.

About MPEG-4 Licensing

“This product is licensed under AT&T patents for the MPEG-4 standard and may be used for encoding MPEG-4 compliant video and/or decoding MPEG-4 compliant video that was encoded only (1) for a personal and non-commercial purpose or (2) by a video provider licensed under the AT&T patents to provide MPEG-4 compliant video. No license is granted or implied for any other use for MPEG-4 standard.”

* Notice displayed in English as required.

Use of genuine Canon accessories is recommended

This product is designed to achieve excellent performance when used with genuine Canon accessories. Canon shall not be liable for any damage to this product and/or accidents such as fire, etc., caused by the malfunction of non-genuine Canon accessories (e.g., a leakage and/or explosion of a battery pack). Please note that this warranty does not apply to repairs arising out of the malfunction of non-genuine Canon accessories, although you may request such repairs on a chargeable basis.



Image Conversion Factor

Since the image sensor size is smaller than the 35mm film format, it will look like the lens focal length is increased by 1.3x.

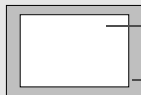

Image sensor size
(27.9 x 18.6 mm / 1.10 x 0.73 in.)

35mm image size
(36 x 24 mm / 1.42 x 0.94 in.)

Safety Warnings

Follow these safeguards and use the equipment properly to prevent injury, death, and material damage.

Preventing Serious Injury or Death

- To prevent fire, excessive heat, chemical leakage, and explosions, follow the safeguards below:
 - Do not use any batteries, power sources, and accessories not specified in this booklet. Do not use any home-made or modified batteries.
 - Do not short-circuit, disassemble, or modify the battery pack or back-up battery. Do not apply heat or apply solder to the battery pack or back-up battery. Do not expose the battery pack or back-up battery to fire or water. And do not subject the battery pack or back-up battery to strong physical shock.
 - Do not install the battery pack or back-up battery in reversed polarity (+ -). Do not mix new and old or different types of batteries.
 - Do not recharge the battery pack outside the allowable ambient temperature range of 0°C - 40°C (32°F - 104°F). Also, do not exceed the recharging time.
 - Do not insert any foreign metallic objects into the electrical contacts of the camera, accessories, connecting cables, etc.
- Keep the back-up battery away from children. If a child swallows the battery, consult a physician immediately. (Battery chemicals may harm the stomach and intestines.)
- When disposing of a battery pack or back-up battery, insulate the electrical contacts with tape to prevent contact with other metallic objects or batteries. This is to prevent fire or an explosion.
- If excessive heat, smoke, or fumes are emitted during battery pack recharging, immediately unplug the battery charger from the power outlet to stop the recharging and prevent a fire.
- If the battery pack or back-up battery leaks, changes color, deforms, or emits smoke or fumes, remove it immediately. Be careful not to get burned in the process.
- Prevent any battery leakage from contacting your eyes, skin, and clothing. It can cause blindness or skin problems. If the battery leakage contacts your eyes, skin, or clothing, flush the affected area with lots of clean water without rubbing it. See a physician immediately.
- During the recharging, keep the equipment away from the reach of children. The cord can accidentally choke the child or give an electrical shock.
- Do not leave any cords near a heat source. It can deform the cord or melt the insulation and cause a fire or electrical shock.
- Do not fire the flash at someone driving a car. It may cause an accident.
- Do not fire the flash near a person's eyes. It may impair the person's vision. When using flash to photograph an infant, keep at least 1 meter away.
- Before storing the camera or accessory when not in use, remove the battery pack and disconnect the power plug. This is to prevent electrical shock, heat generation, and fire.
- Do not use the equipment where there is flammable gas. This is to prevent an explosion or fire.

-
- If you drop the equipment and the casing breaks open to expose the internal parts, do not touch the internal parts due to the possibility of electrical shock.
 - Do not disassemble or modify the equipment. High-voltage internal parts can cause electrical shock.
 - Do not look at the sun or an extremely bright light source through the camera or lens. Doing so may damage your vision.
 - Keep the camera from the reach of small children. The neck strap can accidentally choke the child.
 - Do not store the equipment in dusty or humid places. This is to prevent fire and electrical shock.
 - Before using the camera inside an airplane or hospital, check if it is allowed. Electromagnetic waves emitted by the camera may interfere with the plane's instruments or the hospital's medical equipment.
 - To prevent fire and electrical shock, follow the safeguards below:
 - Always insert the power plug all the way in.
 - Do not handle a power plug with wet hands.
 - When unplugging a power plug, grasp and pull the plug instead of the cord.
 - Do not scratch, cut, or excessively bend the cord or put a heavy object on the cord. Also do not twist or tie the cords.
 - Do not connect too many power plugs to the same power outlet.
 - Do not use a cord whose insulation has been damaged.
 - Occasionally unplug the power plug and use a dry cloth to clean off the dust around the power outlet. If the surrounding is dusty, humid, or oily, the dust on the power outlet may become moist and short-circuit the outlet to cause a fire.
-

Preventing Injury or Equipment Damage

-
- Do not leave equipment inside a car under the hot sun or near a heat source. The equipment may become hot and cause skin burns.
 - Do not carry the camera around while it is attached to a tripod. Doing so may cause injury. Also make sure the tripod is sturdy enough to support the camera and lens.
 - Do not leave a lens or lens-attached camera under the sun without the lens cap attached. Otherwise, the lens may concentrate the sun's rays and cause a fire.
 - Do not cover or wrap the battery-recharging apparatus with a cloth. Doing so may trap heat within and cause the casing to deform or catch fire.
 - If you drop the camera in water or if water or metal fragments enter inside the camera, promptly remove the battery pack and back-up battery. This is to prevent fire and electrical shock.
 - Do not use or leave the battery pack or back-up battery in a hot environment. Doing so may cause battery leakage or a shorter battery life. The battery pack or back-up battery can also become hot and cause skin burns.
 - Do not use paint thinner, benzene, or other organic solvents to clean the equipment. Doing so may cause fire or a health hazard.
-

If the product does not work properly or requires repair, contact your dealer or your nearest Canon Service Center.

European Union (and EEA) only.



These symbols indicate that this product is not to be disposed of with your household waste, according to the WEEE Directive (2002/96/EC), the Battery Directive (2006/66/EC) and/or your national laws implementing those Directives.

■
If a chemical symbol is printed beneath the symbol shown above, in accordance with the Battery Directive, this indicates that a heavy metal (Hg = Mercury, Cd = Cadmium, Pb = Lead) is present in this battery or accumulator at a concentration above an applicable threshold specified in the Battery Directive.

This product should be handed over to a designated collection point, e.g., on an authorized one-for-one basis when you buy a new similar product or to an authorized collection site for recycling waste electrical and electronic equipment (EEE) and batteries and accumulators. Improper handling of this type of waste could have a possible impact on the environment and human health due to potentially hazardous substances that are generally associated with EEE. Your cooperation in the correct disposal of this product will contribute to the effective usage of natural resources.

For more information about the recycling of this product, please contact your local city office, waste authority, approved scheme or your household waste disposal service or visit

www.canon-europe.com/environment.

(EEA: Norway, Iceland and Liechtenstein)

Index

- 10-sec. or 2-sec. delay..... 102
1280x720 151
1920x1080 151
1st-curtain sync..... 122
2nd-curtain sync..... 122
4- or 9-image index display..... 159
640x480 151
- A**
- About servicing 265
AC Adapter Kit 33
AC power 33
Access lamp..... 19, 38
Adobe RGB..... 92
AE lock..... 115, 212, 227
AE Microadjustment..... 213
AEB..... 114, 209
AF → Focusing
AF Microadjustment 221
AF point expansion 222
AF start button 41
AF stop button..... 220
AI SERVO (AI Servo AF) 96
 Operation characteristics 218
 Subject tracking sensitivity 218
 Tracking method 219
Aperture-priority AE 110
Aspect ratio information 234
Auto ISO 65
Auto Lighting Optimizer..... 81, 215
Auto playback (Slide show)..... 168
Auto power off..... 34, 52
Auto reset..... 89
Auto rotate of vertical images 182
Auto switch media..... 57
Autofocus → Focusing
Automatic cleaning..... 184
Automatic selection (AF) 97
Av (Aperture-priority AE) 110
- B**
- B/W..... 67, 69
Battery → Power
Battery check..... 35, 247
Beeper..... 52
Black-and-white (printing)..... 194
Black-and-white image 67, 69
Borders (Bordered/Borderless) 193
Bracketing 80, 114, 209
Bulb 116
 Noise reduction 214
Bulb exposures..... 116
- C**
- Cable 3, 163, 170, 171
Cable protector..... 26
Camera
 Camera shake..... 118
 Clear camera settings 53
 Holding the camera..... 40
 Settings display..... 246
Camera shake 41
Camera shooting-ready..... 41, 45
Caption (name)..... 76
Card..... 13, 36, 50
 Card reminder 52
 Format..... 50
 Problem..... 38
Center-weighted average
metering 104
CF card → Card
Cleaning 184
Clear camera settings 53
Clock 49
Color space 92

Color temperature setting	78
Color tone	68, 196
Compression rate	63
Continuous	88
Continuous shooting	101
Contrast	68, 196
Cool tone (printing)	194
Copyright information	90
Cord	3, 163, 170, 171
Cross-type focusing	99
Custom Functions	204
Clear all	204
Settings registration	235
Custom WB	73

D

Date/Time	49
Date/time battery replacement	248
DC coupler	33
Default (printing)	193
Depth-of-field preview	111
Dial	
Main Dial	42
Quick Control Dial	43
Digital terminal	190
Dioptic adjustment	40
Direct printing → Printing	
DPOF	199
Drive mode	101
Dust Delete Data	185

E

Erase (image)	179
Error codes	256
E-TTL II flash metering	123, 215
Evaluative metering	104
Exposure compensation	113
Exposure level increments	208

Exposure simulation	130
EX-series Speedlite	119
Extension	87
External media	22, 46
External Speedlite → Flash	
Eyecup	40
Eyepiece shutter	117

F

Faithful	67
FE lock	119
FE Microadjustment	213
FEB	123
File name	86
File number	88
File size	61, 152, 157
Filter effect (Monochrome)	69
Firmware Ver.	48
Flash	
Custom Functions	124
External Speedlite	119, 120
FE lock	119
Flash exposure compensation ...	119
Shutter sync. (1st/2nd curtain) ...	122
Flash-sync speed	120, 212
Function settings	121
Non-Canon flash units	120
Flash exposure compensation	119
Flash mode	122
Flash-sync contacts	17
Focus confirmation light	95
Focus lock	95
Focus mode switch	39, 100, 138
Focus tracking	96

Focusing	
AF mode	94
AF point display	158
AF point selection	97
AF-assist beam.....	225
Beeper	52
Difficult-to-focus subjects....	100, 135
Live View shooting.....	131, 138
Manual focusing	100, 138
Out of focus	100, 135
Recompose	95
Focusing screen.....	232
Folder Create/Select.....	84
Format (card initialization).....	50
Frame rate	151
Full HD	141
Full High-Definition.....	151, 163, 171
Function availability table.....	242

G

Grid display	130, 151
--------------------	----------

H

Hand strap	26
HDMI.....	163, 171
High ISO speed noise reduction ...	214
High-Definition	151, 163, 171
Highlight alert.....	157
Highlight detail loss	157
Highlight tone priority	215
High-speed continuous shooting...	101
Histogram (Brightness/RGB)	158
Hot shoe.....	17
Household power	33

I

ICC profile	92
Illumination (LCD panel)	116

Image

AF point display	158
Auto playback	168
Auto rotate	182
Backup	46
Copying	176
Erase.....	179
Highlight alert.....	157
Histogram.....	158
Index	159
Jump display	
(Image browsing)	160
Magnified view	161
Manual rotate	162
Playback	156
Protect.....	172
Shooting information...	128, 148, 157
View on TV.....	163, 170

Image area	265
------------------	-----

Image browsing (Jump display)....	160
-----------------------------------	-----

Image dust prevention.....	27, 183
----------------------------	---------

Image review time	181
-------------------------	-----

Image size	59
Appended automatically.....	87

Image verification data	234
-------------------------------	-----

Image-recording quality.....	59
------------------------------	----

Index display	159
---------------------	-----

ISO speed	64, 146, 208
Automatic setting (Auto).....	65
ISO expansion	208

J

JPEG	59
------------	----

Jump display (Image browsing)....	160
-----------------------------------	-----



L

Landscape.....	66
----------------	----

Language	49
----------------	----

Large (Image size)	60
--------------------------	----

Laser-matte	232
-------------------	-----

- LCD monitor..... 13, 17
 - Brightness adjustment..... 180
 - Image playback 156
 - Menu screen..... 44, 46
 - Shooting settings display.... 23, 217
- LCD panel..... 21, 22
 - Illumination 116
- Lens
 - Attaching/Detaching 39
 - Peripheral illumination correction..... 82
- Live View shooting..... 125
 - Exposure simulation 130
 - Face detection Live mode 132
 - Grid display 130
 - Information display 128
 - Live mode..... 131
 - Manual focusing 138
 - Movie shooting 141
 - Possible shots 129
 - Quick mode 136
- Long exposure noise reduction.... 214
- Low level format..... 51
- Low-speed continuous shooting ... 101
- LV   setting 126, 142

M

- M (Manual exposure)..... 112, 144
- Magnified view 138, 161
- Main Dial () 42
- Manual exposure 112
- Manual focusing..... 100, 138
- Manual reset..... 89
- Manual selection (AF)..... 97
- Maximum aperture f/stop (AF)..... 98
- Maximum burst 61, 62
- Medium (Image size) 60
- Medium RAW..... 59, 62
- Memory card → Card

Menu

- Menu settings 46
 - My Menu 237
 - Setting operation..... 45
 - MENU** icon 4
 - Metered manual flash..... 124
 - Metering mode 104, 211
 - Metering timer 130, 152, 233
 - MF (Manual focusing) 100, 138
 - Microphone
(Built-in/External).... 19, 143, 152, 174
 - Mirror lockup 118
 - Monochrome image 67, 69
 - Movie..... 141
 - Autoexposure shooting 143
 - Enjoying 163
 - File size..... 152
 - First/last scene trimming..... 167
 - Focusing 143
 - Frame rate 151
 - Information display..... 148
 - Manual exposure shooting..... 144
 - Playback 165
 - Recording size 151
 - Shooting preparation 142
 - Sound recording 152
 - Still photo shooting..... 149
 - View on TV 163, 170
 - M-RAW (Medium RAW) 59, 62
 - Multi-controller ()..... 42, 97
 - Multi-spot metering..... 105
 - My Menu 237
- ## N
- Natural/M (printing) 194
 - Neutral..... 67
 - Noise reduction 214
 - Nomenclature..... 16
 - NR (printing)..... 194

NTSC 151, 170
Number of AF points 223

O

ONE SHOT (One-Shot AF) 95
One-Shot AF 95

P

P (Program AE) 106
PAL 151, 170
Paper settings (printing) 192
Partial metering 104
PC terminal 120
Peripheral illumination correction 82
Personal white balance 72
PictBridge 189
Picture Style 66, 71
Pixels 60
Playback → Image
Portrait 66
Possible shots 35, 61, 129
Power
 Auto power off 52
 Battery check 35, 247
 Battery info. 247
 Calibration 30
 Household power 33
 Possible shots 35, 61, 129
 Recharge 28
 Recharge performance 247
 Switch 34
Precision matte 232
Pressing completely 41
Pressing halfway 41

Printing 189
 Page layout 193
 Paper settings 192
 PictBridge 189
 Print Order (DPOF) 199
 Printing effects 194, 196
 Tilt correction 197
 Trimming 197
Program AE 106
 Program shift 107
Protect 172

Q

Quick Control Dial (☉) 34, 43
Quick mode 136

R

RAW 59, 62
RAW+JPEG 60
Rec. separately 57
Rec. to multiple 57
Recharge 28
Recording func. 57
Registered AF point 224
Registering basic camera
settings 240
Release shutter without card 52
Remote Switch 117
Rotate (image) 162, 182

S

Safety shift 210
Safety warnings 266
Saturation 68, 196
Saving camera settings 238
SD card → Card
Self-timer 102
Sensor cleaning 183, 184, 187
Sepia (Monochrome) 69

SET button.....	44
Sharpness.....	68
Shooting information display.....	128, 148, 157
Shooting mode.....	21
Aperture-priority AE.....	110
Bulb.....	116
Manual exposure.....	112
Program AE.....	106
Shutter-priority AE.....	108
Shooting settings display.....	23, 217
Shortened (time lag).....	233
Shutter button.....	41
Shutter sync.....	122
Shutter-priority AE.....	108
Silent shooting.....	101
Silent single shooting.....	101
Single image display.....	156
Single shooting.....	101
Slide show.....	168
Small (Image size).....	59
Small RAW.....	59, 62
Specifications.....	257
Spot metering.....	104
S-RAW (Small RAW).....	59, 62
sRGB.....	92
Standard.....	66, 200
Stills → Image	
Stopped-down aperture.....	111
Strap.....	26
Superimposed display.....	225
System extension terminal.....	18
System map.....	244

T

Toning effect (Monochrome).....	69
Trademarks.....	264

Trimming (printing).....	197
Tripod socket.....	16
Troubleshooting.....	249
Tv (Shutter-priority AE).....	108

U

Ultra DMA (UDMA).....	37, 150
USB (Digital) terminal.....	190
User defined.....	70, 86

V

Vertical/horizontal AF point.....	226
Video system.....	170
View on TV.....	163, 170
Viewfinder.....	20
Dioptic adjustment.....	40
VIVID (printing).....	194
Voice memo	
Playback.....	175
Recording.....	174
Volume (Movie playback).....	166

W

Warm tone (printing).....	194
WB → White balance	
WFT settings.....	48
White balance.....	72
Bracketing.....	80
Color temperature setting.....	78
Correction.....	79
Custom.....	73
Personal.....	72



Canon

CANON INC.

30-2 Shimomaruko 3-chome, Ohta-ku, Tokyo 146-8501, Japan

Europe, Africa & Middle East

CANON EUROPA N.V.

PO Box 2262, 1180 EG Amstelveen, The Netherlands

CANON UK LTD

For technical support, please contact the Canon Help Desk:

Canon UK, RCC Customer Service

Unit 130, Centennial Park, Elstree, Herts, WD6 3SE, UK

Helpdesk: 0844 369 0100 (5 pence/min from a BT landline, other costs may vary)

Fax: 020 8731 4164

www.canon.co.uk

CANON FRANCE SAS

17, quai du Président Paul Doumer

92414 Courbevoie cedex, France

Hot line 0170480500

www.canon.fr

CANON DEUTSCHLAND GmbH

Europark Fichtenhain A10, 47807 Krefeld, Germany

Helpdesk: 069 2999 3680

www.canon.de

CANON ITALIA S.P.A.

Via Milano 8, I-20097 San Donato Milanese (MI), Italy

Servizio clienti: 848 800519 (0,0787 € + 0,0143 €/min)

Fax: 02-8248.4600

www.canon.it

CANON ESPAÑA S.A.

Avenida de Europa nº 6, 28108 Alcobendas (Madrid)

Helpdesk: 901.900.012 (€0,039/min)

Fax: (+34) 91 411 77 80

www.canon.es

CANON BELGIUM N.V. / S.A.

Berkenlaan 3, B – 1831 Diegem, Belgium

Helpdesk : (02) 620.01.97 (0,053 € + 0,053 €/min)

Fax: (02) 721.32.74

www.canon.be

CANON LUXEMBOURG S.A.

Rue des Jons 21, L-1818 Howald, Luxembourg

Helpdesk : 27 302 054 (0,12 €/min)

Fax: (352) 48 47 96232

www.canon.lu

CANON NEDERLAND N.V.

Bovenkerkerweg 59-61,

1185 XB Amstelveen, The Netherlands

Helpdesk: 020 7219 103

www.canon.nl

CANON DANMARK A/S

Knud Højgaard's Vej 1, DK-2860 Søborg, Denmark

Helpdesk: 70 20 55 15 (0,25 DKK + 0,25 DKK/min)

Fax: 70 155 025

www.canon.dk

CANON NORGE as

Hallangerbakken 110, Postboks 33, Holmlia, 1201 Oslo, Norway

Helpdesk: 23 50 01 43 (0,89 NOK + 0,49 NOK/min)

www.canon.no

CANON OY

Kuluttajatuotteet, Huopalahdentie 24, PL1, 00351 Helsinki, Finland

Helpdesk: 020 366 466 (0,0821 € + 0,0149 €/min)

www.canon.fi

CANON SVENSKA AB

Gustav III:s Boulevard 26, S-169 88 Solna, Sweden

Helpdesk: +46 (0)8 519 923 69 (0,23 SEK + 0,45 SEK/min)

Fax: +46 (0)8 97 20 01

www.canon.se

CANON (SCHWEIZ) AG

Industriestrasse 12, 8305 Dietlikon, Switzerland

Helpdesk: 0848 833 838 (0,08 CHF/min)

www.canon.ch

CANON AUSTRIA GmbH

Oberlaaer Strasse 233, A – 1110 Wien, Austria

Helpdesk: 0810 081009 (0,07 €/min)

www.canon.at

CANON PORTUGAL, S.A.

Rua Alfredo Silva, 14 - Alfragide, 2610-016 Amadora, Portugal

Helpdesk: +351 21 42 45 190 (€0,0847 + €0,031/min)

www.canon.pt

WEB SELF-SERVICE: www.canon-europe.com

This Instruction Manual booklet is current as of October 2009. For information on the camera's compatibility with any accessories and lenses introduced after this date, contact any Canon Service Center.