

# Nikon

DIGITAL CAMERA

# Z 5

## Reference Manual

This camera features updated firmware with added functions. For more information, see “Changes Made via Firmware Updates” (page 746).

- Read this manual thoroughly before using the camera.
- To ensure proper use of the camera, be sure to read “For Your Safety” (page xxxv).
- After reading this manual, keep it in a readily accessible place for future reference.

# When Your First Photo Can't Wait

## ■ Getting Ready

### 1 Insert the battery (📖 36).

For information on charging the battery, see “Charging the Battery” (📖 34).

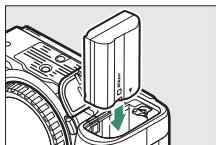

### 2 Insert a memory card (📖 38).

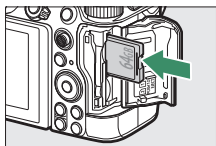

### 3 Attach a lens (📖 42).

- Align the white dot on the lens with the white dot on the camera body (①) and rotate the lens in the direction shown (②).
- A strap can be attached to the camera. For more information, see “Attaching the Strap” (📖 33).

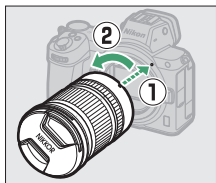

### 4 Turn the camera on and then choose a language and set the clock (📖 44).

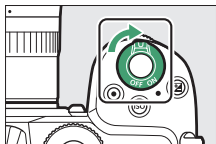

**Z 5 Model Name: N1933**

## ■ Take (📖 48) and View (📖 58) Pictures

**1** Rotate the mode dial to <sup>AUTO</sup> .

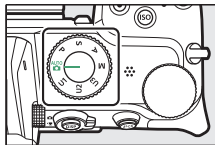

**2** To focus, press the shutter-release button halfway (i.e., lightly press the shutter-release button, stopping when it is pressed halfway).

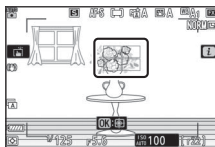

**3** Without lifting your finger from the shutter-release button, press the button the rest of the way down to take the picture.



**4** View the picture.

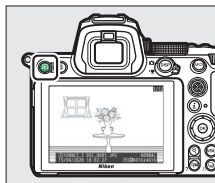

## Package Contents

Be sure all items listed here were included with your camera.

- Camera



- BF-N1 body cap



- DK-29 rubber eyecup  
(comes attached to camera, [☞651](#))



- EN-EL15c rechargeable Li-ion battery with terminal cover

- MH-25a battery charger  
(comes with either an AC wall adapter or power cable of a type and shape that varies with the country or region of sale)

- Strap ([☞33](#))

- Warranty

- User's Manual*

- UC-E24 USB cable ([☞552](#))

- BS-1 accessory shoe cover  
([☞653](#))

- Memory cards are sold separately.
- Purchasers of the lens kit option should confirm that the package also includes a lens. Manuals for the lens may also be provided.

---

## **The Nikon Download Center**

Visit the Nikon download center to download firmware updates, NX Studio and other Nikon software, and manuals for Nikon products including cameras, NIKKOR lenses, and flash units.



<https://downloadcenter.nikonimglib.com/>

---

# About This Manual

## ■ Symbols

The following symbols and conventions are employed in this manual. Use them to help locate the information you need.

	This icon marks notes, information that should be read before using this product.
	This icon marks tips, additional information you may find helpful when using this product.
	This icon marks references to other sections in this manual.

## ■ Conventions

- This camera uses SD, SDHC, and SDXC memory cards, referred to throughout this manual as “memory cards”. SD, SDHC, and SDXC may also on occasion be referred to as “SD memory cards”.
- Throughout this manual, battery chargers are referred to as “battery chargers” or “chargers”.
- Throughout this manual, the display in camera monitor and viewfinder during shooting is referred to as the “shooting display”; in most cases, the illustrations show the monitor.
- Throughout this manual, smartphones and tablets are referred to as “smart devices”.
- Throughout this manual, the term “default settings” is used to refer to the settings in effect at shipment. The explanations in this manual assume that default settings are used.

---

**⚠ For Your Safety**

“For Your Safety” contains important safety instructions. Be sure to read them before using the camera. For more information, see “For Your Safety” (📖xxxv).

---

# Table of Contents

When Your First Photo Can't Wait .....	ii
Package Contents .....	iv
About This Manual .....	vi
Menu List .....	xxviii
For Your Safety .....	xxxv
Notices .....	xl
<b>Getting to Know the Camera</b> .....	<b>1</b>
<hr/>	
Parts of the Camera.....	1
Camera Body .....	1
The Monitor and Viewfinder .....	6
Camera Controls .....	9
Viewfinder .....	9
The <b> </b> (Monitor Mode) Button .....	10
The Mode Dial .....	11
The Command Dials.....	12
The <b>ISO</b> Button .....	12
The <b>±</b> (Exposure Compensation) Button.....	14
Touch Controls .....	15
The <b>DISP</b> Button .....	21
The <b>Q</b> and <b>Q</b> (?) Buttons .....	23
The Sub-Selector .....	23
The <b>AF-ON</b> Button.....	24
The <b>MENU</b> Button .....	24
The <b>i</b> Button (the <b>i</b> Menu).....	29
The <b>FN1</b> and <b>FN2</b> Buttons.....	31



## First Steps

33

---

Attaching the Strap.....	33
Charging the Battery .....	34
Inserting the Battery .....	36
Removing the Battery .....	36
Battery Level .....	37
Inserting Memory Cards.....	38
Removing Memory Cards .....	38
Number of Exposures Remaining .....	39
Attaching a Lens .....	42
Detaching Lenses.....	43
Choose a Language and Set the Clock .....	44

## Basic Photography and Playback

48

---

Taking Photographs (AUTO Mode) .....	48
Shooting Movies (AUTO Mode) .....	53
Taking Photos in Movie Mode.....	56
Playback.....	58
Viewing Photos.....	58
Viewing Movies .....	59
Deleting Unwanted Pictures.....	61

## Basic Settings

63



---

Focus .....	63
Focus Mode.....	63
AF-Area Mode .....	66
The Touch Shutter .....	76
Manual Focus .....	78

White Balance.....	81
Adjusting White Balance .....	81
Silent Photography.....	87
Rating Pictures .....	89
Protecting Pictures from Deletion .....	91

## **Shooting Controls 93**

---

The Mode Dial .....	93
Using the Mode Dial .....	93
<b>P</b> (Programmed Auto) .....	94
<b>S</b> (Shutter-Priority Auto) .....	95
<b>A</b> (Aperture-Priority Auto).....	96
<b>M</b> (Manual).....	97
<b>U1, U2, and U3</b> (User Settings Modes) .....	102
The <b>ISO</b> Button.....	105
Adjusting ISO Sensitivity.....	105
Auto ISO Sensitivity Control .....	107
The  (Exposure Compensation) Button .....	109
Adjusting Exposure Compensation.....	109
The  (Release Mode/Self-Timer) Button .....	111
Choosing a Release Mode .....	111
The Self-Timer.....	115
The Sub-Selector .....	117
Focus-Point Selection .....	117
Exposure Lock.....	117
Focus Lock .....	117
Locking Focus and Exposure.....	118



---

The <i>i</i> Menu .....	120
Still Images .....	122
Set Picture Control .....	123
White Balance .....	129
Image Quality .....	136
Image Size .....	138
Flash Mode .....	139
Metering .....	140
Wi-Fi Connection .....	141
View Memory Card Info .....	141
Release Mode .....	142
Vibration Reduction .....	143
AF-Area Mode .....	145
Focus Mode .....	146
Movies .....	147
Set Picture Control .....	149
White Balance .....	149
Frame Size and Rate/Image Quality .....	150
Microphone Sensitivity .....	152
Choose Image Area .....	153
Metering .....	155
Wi-Fi Connection .....	155
Destination .....	155
Electronic VR .....	156
Vibration Reduction .....	156
AF-Area Mode .....	157
Focus Mode .....	157

---

Viewing Pictures .....	158
Full-Frame Playback .....	158
Thumbnail Playback.....	159
Calendar Playback.....	160
Photo Information .....	162
File Information.....	163
Exposure Data.....	164
Highlight Display .....	164
RGB Histogram .....	165
Shooting Data.....	167
Location Data.....	170
Overview.....	170
The <b>i</b> Button (Playback Mode) .....	172
Photos.....	172
Movies .....	175
Movies (Playback Paused) .....	175
Playback Zoom.....	183
Using Playback Zoom .....	183
Deleting Pictures .....	185
Using the Delete Button .....	185
Deleting Multiple Pictures .....	187

---

Defaults .....	191
Playback Menu Defaults .....	191
Photo Shooting Menu Defaults .....	192
Movie Shooting Menu Defaults .....	196
Custom Settings Menu Defaults .....	198
Setup Menu Defaults .....	204
 The Playback Menu: Managing Images .....	208
Delete .....	209
Playback Folder .....	209
Playback Display Options .....	210
Dual-format Recording PB Slot .....	210
Image Review .....	211
After Delete .....	212
Rotate Tall .....	212
Copy Image(s) .....	213
Copying Pictures .....	213
Slide Show .....	220
Viewing Slide Shows .....	221
Rating .....	222
 The Photo Shooting Menu: Shooting Options .....	223
Reset Photo Shooting Menu .....	224
Storage Folder .....	225
Renaming Folders .....	225
Select Folder by Number .....	227
Select Folder from List .....	229

File Naming.....	231
Role Played by Card in Slot 2.....	232
Deleting Copies.....	233
Choose Image Area.....	234
Image Quality.....	234
Image Size.....	235
NEF (RAW) Recording.....	236
NEF (RAW) Compression.....	236
NEF (RAW) Bit Depth.....	236
ISO Sensitivity Settings.....	237
White Balance.....	239
The White Balance Menu: Fine-Tuning.....	239
The White Balance Menu: Choosing a Color Temperature.....	242
Preset Manual: Copying White Balance from a Photograph.....	244
Set Picture Control.....	247
Modifying Picture Controls from the Menus.....	247
Manage Picture Control.....	250
Creating Custom Picture Controls.....	250
Color Space.....	254
Active D-Lighting.....	255
Long Exposure NR.....	257
High ISO NR.....	258
Vignette Control.....	259
Diffraction Compensation.....	260
Auto Distortion Control.....	260
Flicker Reduction Shooting.....	261
Metering.....	262



Flash Control.....	263
Flash Control Mode.....	264
Wireless Flash Options.....	265
Remote Flash Control.....	266
Radio Remote Flash Info.....	266
Flash Mode.....	267
Flash Compensation.....	267
Focus Mode.....	267
AF-Area Mode.....	268
Vibration Reduction.....	268
Auto Bracketing.....	269
Exposure and Flash Bracketing.....	270
White Balance Bracketing.....	275
ADL Bracketing.....	278
Multiple Exposure.....	281
Creating a Multiple Exposure.....	284
HDR (High Dynamic Range).....	291
Taking HDR Photographs.....	292
Interval Timer Shooting.....	297
Interval-Timer Photography.....	300
Time-Lapse Movie.....	311
Recording Time-Lapse Movies.....	313
Focus Shift Shooting.....	322
Focus Shift Photography.....	324
Silent Photography.....	332

 The Movie Shooting Menu: Movie Shooting Options.....	333
Reset Movie Shooting Menu .....	334
File Naming.....	334
Destination .....	334
Choose Image Area.....	335
Frame Size/Frame Rate .....	335
Movie Quality .....	335
Movie File Type .....	335
ISO Sensitivity Settings.....	336
White Balance .....	337
Set Picture Control .....	337
Manage Picture Control .....	337
Active D-Lighting.....	338
High ISO NR .....	338
Vignette Control .....	339
Diffraction Compensation.....	339
Auto Distortion Control.....	339
Flicker Reduction .....	340
Metering .....	340
Focus Mode .....	341
AF-Area Mode .....	341
Vibration Reduction.....	341
Electronic VR.....	341
Microphone Sensitivity.....	342
Attenuator.....	343
Frequency Response .....	343
Wind Noise Reduction .....	344
Headphone Volume .....	344
Timecode.....	345



 Custom Settings: Fine-Tuning Camera Settings.....	347
Reset Custom Settings .....	351
a: Autofocus .....	351
a1: AF-C Priority Selection .....	351
a2: AF-S Priority Selection.....	352
a3: Focus Tracking with Lock-On .....	352
a4: Auto-Area AF Face/Eye Detection .....	353
a5: Focus Points Used .....	354
a6: Store Points by Orientation .....	355
a7: AF Activation .....	357
Out-of-Focus Release .....	357
a8: Limit AF-Area Mode Selection .....	358
a9: Focus Point Wrap-Around .....	358
a10: Focus Point Options .....	359
Manual Focus Mode.....	359
Dynamic-Area AF Assist.....	359
a11: Low-Light AF.....	360
a12: Built-in AF-Assist Illuminator.....	361
a13: Manual Focus Ring in AF Mode.....	362
b: Metering/Exposure .....	363
b1: EV Steps for Exposure Cntrl .....	363
b2: Easy Exposure Compensation .....	363
b3: Center-Weighted Area .....	364
b4: Fine-Tune Optimal Exposure .....	364

c: Timers/AE Lock.....	365
c1: Shutter-Release Button AE-L.....	365
c2: Self-Timer .....	365
c3: Power Off Delay .....	366
d: Shooting/Display .....	367
d1: CL Mode Shooting Speed .....	367
d2: Max. Continuous Release.....	367
d3: Sync. Release Mode Options .....	368
d4: Exposure Delay Mode .....	368
d5: Shutter Type .....	369
d6: File Number Sequence .....	370
d7: Apply Settings to Live View .....	372
d8: Framing Grid Display.....	372
d9: Peaking Highlights .....	373
Peaking Level.....	373
Peaking Highlight Color.....	373
d10: View All in Continuous Mode .....	373
e: Bracketing/Flash.....	374
e1: Flash Sync Speed.....	374
e2: Flash Shutter Speed .....	376
e3: Exposure Comp. for Flash .....	376
e4: Auto ⚡ ISO Sensitivity Control.....	377
e5: Modeling Flash.....	377
e6: Auto Bracketing (Mode M).....	378
e7: Bracketing Order .....	379

f: Controls.....	380
f1: Customize  Menu.....	380
View Memory Card Info.....	381
Bluetooth Connection.....	381
f2: Custom Controls.....	382
f3: OK Button.....	394
Shooting Mode.....	394
Playback Mode.....	395
f4: Shutter Spd & Aperture Lock.....	396
f5: Customize Command Dials.....	397
Reverse Rotation.....	397
Change Main/Sub.....	397
Menus and Playback.....	398
Sub-Dial Frame Advance.....	399
f6: Release Button to Use Dial.....	400
f7: Reverse Indicators.....	401
g: Movie.....	402
g1: Customize  Menu.....	402
g2: Custom Controls.....	403
g3: OK Button.....	410
g4: AF Speed.....	411
g5: AF Tracking Sensitivity.....	411
g6: Highlight Display.....	412
Display Pattern.....	412
Highlight Display Threshold.....	412

⚙ The Setup Menu: Camera Setup .....	413
Format Memory Card .....	415
Save User Settings .....	415
Reset User Settings .....	415
Language .....	416
Time Zone and Date .....	416
Monitor Brightness .....	417
Monitor Color Balance .....	418
Viewfinder Brightness .....	419
Viewfinder Color Balance .....	420
Limit Monitor Mode Selection .....	420
Information Display .....	421
AF Fine-Tuning Options .....	422
Creating and Saving Fine-Tuning Values .....	424
Choosing a Default Fine-Tuning Value .....	425
Non-CPU Lens Data .....	426
Clean Image Sensor .....	426
Image Dust Off Ref Photo .....	427
Acquiring Image Dust Off Reference Data .....	427
Pixel Mapping .....	430
Image Comment .....	432
Input Comment .....	432
Attach Comment .....	432
Copyright Information .....	433
Artist/Copyright .....	433
Attach Copyright Information .....	433

Beep Options .....	435
Beep On/Off .....	435
Volume .....	436
Pitch .....	436
Touch Controls.....	436
Enable/Disable Touch Controls .....	436
Full-Frame Playback Flicks.....	436
HDMI.....	437
Location Data .....	437
Wireless Remote (WR) Options .....	438
LED Lamp.....	438
Link Mode.....	439
Assign Remote (WR) Fn Button.....	441
Airplane Mode.....	441
Connect to Smart Device .....	442
Pairing (Bluetooth) .....	442
Select to Send (Bluetooth).....	443
Wi-Fi Connection .....	443
Send While Off .....	444
Location Data (Smart Device).....	444
Connect to PC.....	445
Wi-Fi Connection .....	445
Network Settings .....	445
Options .....	447
MAC Address .....	448
Conformity Marking .....	448
Battery Info.....	449
USB Power Delivery.....	450

Energy Saving .....	452
Slot Empty Release Lock .....	453
Save/Load Menu Settings.....	454
Save Menu Settings .....	458
Load Menu Settings .....	458
Reset All Settings .....	459
Firmware Version.....	459
☑ The Retouch Menu: Creating Retouched Copies.....	460
Creating Retouched Copies.....	461
NEF (RAW) Processing: Converting NEF (RAW) to JPEG .....	464
Trim.....	469
Resize .....	470
Resizing Multiple Images.....	470
D-Lighting .....	475
Red-Eye Correction .....	476
Straighten.....	477
Distortion Control.....	478
Perspective Control .....	479
Monochrome .....	480
Image Overlay.....	481
Add .....	481
Lighten and Darken.....	486
Trim Movie .....	490
☞ My Menu/☞ Recent Settings.....	491
☞ My Menu: Creating a Custom Menu .....	491
☞ Recent Settings: Accessing Recently-Used Settings.....	496

## **Establishing Wireless Connections to Computers or Smart Devices** **497**

---

Network Options.....	497
Connecting to Computers via Wi-Fi.....	498
What Wi-Fi Can Do for You.....	498
The Wireless Transmitter Utility.....	498
Infrastructure and Access-Point Modes.....	499
Connecting in Access-Point Mode .....	501
Connecting in Infrastructure Mode.....	507
Uploading Pictures.....	516
Disconnecting and Reconnecting .....	520
Connecting to Smart Devices.....	522
The SnapBridge App.....	522
What SnapBridge Can Do for You.....	523
Wireless Connections .....	524
Connecting via Wi-Fi (Wi-Fi Mode).....	525
Connecting via Bluetooth.....	534
Troubleshooting .....	551

## **Cabled Connections to Computers and HDMI Devices** **552**

---

Connecting to Computers Via USB .....	552
Installing NX Studio .....	553
Copying Pictures to a Computer Using NX Studio .....	554
Connecting to HDMI Devices .....	557
TVs .....	558
Recorders .....	559

## **On-Camera Flash Photography** **561**

---

“On-Camera” Versus “Remote” .....	561
Camera-Mounted Flash Units .....	561
Remote Flash Photography .....	562
Using an On-Camera Flash .....	563
Flash Control Mode .....	566
Flash Modes .....	569
Flash Compensation .....	572
FV Lock.....	573
Flash Info for On-Camera Units .....	576
Flash Control Mode Displays.....	576

## **Remote Flash Photography** **579**

---

What Is Remote Flash Photography? .....	579
Using Remote Flash Units .....	580
Radio AWL.....	581
Establishing a Wireless Connection.....	581
Remote Flash Photography.....	586
Adding a Shoe-Mounted Flash Unit .....	594
Optical AWL.....	595
Using Optical AWL with the SB-5000 or SB-500 .....	596
Optical/Radio AWL.....	606
Flash Info for Remote Units .....	607
Flash Control Mode Displays.....	607



## **Troubleshooting** **610**

---

Before Contacting Customer Support .....	610
Problems and Solutions .....	612
Battery/Display .....	612
Shooting.....	613
Playback .....	618
Bluetooth and Wi-Fi (Wireless Networks).....	620
Miscellaneous.....	620
Alerts and Error Messages .....	621
Alerts .....	621
Error Messages.....	624

## **Technical Notes** **628**

---

Compatible Lenses and Accessories.....	628
Camera Displays.....	629
Monitor.....	629
Viewfinder .....	636
Compatible Flash Units .....	640
The Nikon Creative Lighting System (CLS) .....	640
Other Compatible Accessories .....	648
Charging AC Adapters .....	654
Attaching a Power Connector and AC Adapter .....	657
Software .....	659

Caring for the Camera .....	661
Storage .....	661
Cleaning .....	662
Image Sensor Cleaning .....	663
Manual Cleaning .....	665
Caring for the Camera and Battery: Cautions .....	667
Camera Care .....	667
Battery Care .....	671
Using the Charger .....	674
Using the Charging AC Adapter .....	674
Specifications .....	675
Nikon Z 5 Digital Camera .....	675
Approved Memory Cards .....	690
Portable Chargers (Power Banks) .....	691
Memory Card Capacity .....	692
Battery Endurance .....	694
AF-Assist Illumination .....	696
Trademarks and Licenses .....	697
Notices .....	701
Bluetooth and Wi-Fi (Wireless LAN) .....	703

---

NIKKOR Z 24–70mm f/4 S Lens Manual .....	709
Using the Lens .....	709
Precautions for Use .....	714
Lens Care.....	715
Accessories.....	716
Specifications .....	717
NIKKOR Z 24–200mm f/4–6.3 VR Lens Manual .....	718
Using the Lens .....	718
Precautions for Use .....	724
Lens Care.....	725
Accessories.....	726
Specifications .....	727
NIKKOR Z 24–50mm f/4–6.3 Lens Manual .....	729
Using the Lens .....	729
Precautions for Use .....	735
Lens Care.....	736
Accessories.....	737
Specifications .....	738

**Index****739**

---

**Changes Made via Firmware Updates****746**

---

Firmware Version Info .....	746
Features Available with “C” Firmware Version 1.10 .....	747
Saving the Focus Position.....	747

## Menu List

The camera offers the following menus. For a more complete description of individual menu items, refer to the “Menu Guide” chapter in the *Online Manual*.

<b>PLAYBACK MENU</b>	<b>PHOTO SHOOTING MENU</b>
Delete	Reset photo shooting menu
Playback folder	Storage folder
Playback display options	File naming
Dual-format recording PB slot	Role played by card in Slot 2
Image review	Choose image area
After delete	Image quality
Rotate tall	Image size
Copy image(s)	NEF (RAW) recording
Slide show	ISO sensitivity settings
Rating	White balance
	Set Picture Control
	Manage Picture Control
	Color space
	Active D-Lighting
	Long exposure NR
	High ISO NR
	Vignette control

**PHOTO SHOOTING MENU**

Diffraction compensation  
Auto distortion control  
Flicker reduction shooting  
Metering  
Flash control  
Flash mode  
Flash compensation  
Focus mode  
AF-area mode  
Vibration reduction  
Auto bracketing  
Multiple exposure  
HDR (high dynamic range)  
Interval timer shooting  
Time-lapse movie  
Focus shift shooting  
Silent photography

**MOVIE SHOOTING MENU**

Reset movie shooting menu  
File naming  
Destination  
Choose image area  
Frame size/frame rate  
Movie quality  
Movie file type  
ISO sensitivity settings  
White balance  
Set Picture Control  
Manage Picture Control  
Active D-Lighting  
High ISO NR  
Vignette control  
Diffraction compensation  
Auto distortion control  
Flicker reduction

**MOVIE SHOOTING MENU**

Metering

Focus mode

AF-area mode

Vibration reduction

Electronic VR

Microphone sensitivity

Attenuator

Frequency response

Wind noise reduction

Headphone volume

Timecode

**CUSTOM SETTING MENU**

Reset custom settings

a Autofocus

a1 AF-C priority selection

a2 AF-S priority selection

a3 Focus tracking with lock-on

a4 Auto-area AF face/eye  
detection

a5 Focus points used

a6 Store points by orientation

a7 AF activation

a8 Limit AF-area mode  
selection

a9 Focus point wrap-around

a10 Focus point options

a11 Low-light AF

a12 Built-in AF-assist  
illuminatora13 Manual focus ring in AF  
mode

**CUSTOM SETTING MENU****b Metering/exposure**

b1	EV steps for exposure cntrl
b2	Easy exposure compensation
b3	Center-weighted area
b4	Fine-tune optimal exposure

**c Timers/AE lock**

c1	Shutter-release button AE-L
c2	Self-timer
c3	Power off delay

**CUSTOM SETTING MENU****d Shooting/display**

d1	CL mode shooting speed
d2	Max. continuous release
d3	Sync. release mode options
d4	Exposure delay mode
d5	Shutter type
d6	File number sequence
d7	Apply settings to live view
d8	Framing grid display
d9	Peaking highlights
d10	View all in continuous mode

**CUSTOM SETTING MENU**

## e Bracketing/flash

e1	Flash sync speed
e2	Flash shutter speed
e3	Exposure comp. for flash
e4	Auto  ISO sensitivity control
e5	Modeling flash
e6	Auto bracketing (mode M)
e7	Bracketing order

**CUSTOM SETTING MENU**

## f Controls

f1	Customize  menu
f2	Custom controls
f3	OK button
f4	Shutter spd & aperture lock
f5	Customize command dials
f6	Release button to use dial
f7	Reverse indicators

## g Movie

g1	Customize  menu
g2	Custom controls
g3	OK button
g4	AF speed
g5	AF tracking sensitivity
g6	Highlight display



<b>SETUP MENU</b>	<b>SETUP MENU</b>
Format memory card	Beep options
Save user settings	Touch controls
Reset user settings	HDMI
Language	Location data
Time zone and date	Wireless remote (WR) options
Monitor brightness	Assign remote (WR) Fn button
Monitor color balance	Airplane mode
Viewfinder brightness	Connect to smart device
Viewfinder color balance	Connect to PC
Limit monitor mode selection	Conformity marking
Information display	Battery info
AF fine-tuning options	USB power delivery
Non-CPU lens data	Energy saving
Clean image sensor	Slot empty release lock
Image Dust Off ref photo	Save/load menu settings
Pixel mapping	Reset all settings
Image comment	Firmware version
Copyright information	

**RETOUCH MENU**

NEF (RAW) processing

Trim

Resize

D-Lighting

Red-eye correction

Straighten

Distortion control

Perspective control

Monochrome

Image overlay

Trim movie

**MY MENU**

Add items

Remove items

Rank items

Choose tab

## For Your Safety

To prevent damage to property or injury to yourself or to others, read “For Your Safety” in its entirety before using this product.

Keep these safety instructions where all those who use this product will read them.

**⚠ DANGER:** Failure to observe the precautions marked with this icon carries a high risk of death or severe injury.

**⚠ WARNING:** Failure to observe the precautions marked with this icon could result in death or severe injury.

**⚠ CAUTION:** Failure to observe the precautions marked with this icon could result in injury or property damage.

### **⚠ WARNING**

**Do not use while walking or operating a vehicle.**

Failure to observe this precaution could result in accidents or other injury.

**Do not disassemble or modify this product. Do not touch internal parts that become exposed as the result of a fall or other accident.**

Failure to observe these precautions could result in electric shock or other injury.

**Should you notice any abnormalities such as the product producing smoke, heat, or unusual odors, immediately disconnect the battery or power source.**

Continued operation could result in fire, burns or other injury.

**Keep dry. Do not handle with wet hands. Do not handle the plug with wet hands.**

Failure to observe these precautions could result in fire or electric shock.

**Do not let your skin remain in prolonged contact with this product while it is on or plugged in.**

Failure to observe this precaution could result in low-temperature burns.

---

**Do not use this product in the presence of flammable dust or gas such as propane, gasoline or aerosols.**

Failure to observe this precaution could result in explosion or fire.

---

**Do not directly view the sun or other bright light source through the lens.**

Failure to observe this precaution could result in visual impairment.

---

**Do not aim the flash or AF-assist illuminator at the operator of a motor vehicle.**

Failure to observe this precaution could result in accidents.

---

**Keep this product out of reach of children.**

Failure to observe this precaution could result in injury or product malfunction. In addition, note that small parts constitute a choking hazard. Should a child swallow any part of this product, seek immediate medical attention.

---

**Do not entangle, wrap or twist the straps around your neck.**

Failure to observe this precaution could result in accidents.

---

**Do not use batteries, chargers, or AC adapters not specifically designated for use with this product. When using batteries, chargers, and AC adapters designated for use with this product, do not:**

- **Damage, modify, forcibly tug or bend the cords or cables, place them under heavy objects, or expose them to heat or flame.**
- **Use travel converters or adapters designed to convert from one voltage to another or with DC-to-AC inverters.**

Failure to observe these precautions could result in fire or electric shock.

---

**Do not handle the plug when charging the product or using the AC adapter during thunderstorms.**

Failure to observe this precaution could result in electric shock.

---

**Do not handle with bare hands in locations exposed to extremely high or low temperatures.**

Failure to observe this precaution could result in burns, or frostbite.

---

 **CAUTION**

**Do not leave the lens pointed at the sun or other strong light sources.**

Light focused by the lens could cause fire or damage to product's internal parts. When shooting backlit subjects, keep the sun well out of the frame. Sunlight focused into the camera when the sun is close to the frame could cause fire.

---

**Turn this product off when its use is prohibited. Disable wireless features when the use of wireless equipment is prohibited.**

The radio-frequency emissions produced by this product could interfere with equipment onboard aircraft or in hospitals or other medical facilities.

---

**Remove the battery and disconnect the AC adapter if this product will not be used for an extended period.**

Failure to observe this precaution could result in fire or product malfunction.

---

**Do not fire the flash in contact with or in close proximity to the skin or objects.**

Failure to observe this precaution could result in burns or fire.

---

**Do not leave the product where it will be exposed to extremely high temperatures, for an extended period such as in an enclosed automobile or in direct sunlight.**

Failure to observe this precaution could result in fire or product malfunction.

---

**Do not look directly at the AF-assist illuminator.**

Failure to observe this precaution could have adverse effects on vision.

---

**Do not transport cameras or lenses with tripods or similar accessories attached.**

Failure to observe this precaution could result in injury or product malfunction.

---

 **DANGER (Batteries)**

**Do not mishandle batteries.**

Failure to observe the following precautions could result in the batteries leaking, overheating, rupturing, or catching fire:

- Use only rechargeable batteries approved for use in this product.
  - Do not expose batteries to flame or excessive heat.
  - Do not disassemble.
  - Do not short-circuit the terminals by touching them to necklaces, hairpins, or other metal objects.
  - Do not expose batteries or the products in which they are inserted to powerful physical shocks.
  - Do not step on batteries, pierce them with nails, or strike them with hammers.
- 

**Charge only as indicated.**

Failure to observe this precaution could result in the batteries leaking, overheating, rupturing, or catching fire.

---

**If battery liquid comes into contact with the eyes, rinse with plenty of clean water and seek immediate medical attention.**

Delaying action could result in eye injuries.

---

**Follow the instructions of airline personnel.**

Batteries left unattended at high altitudes in an unpressurized environment may leak, overheat, rupture, or catch fire.

---

 **WARNING (Batteries)**

**Keep batteries out of reach of children.**

Should a child swallow a battery, seek immediate medical attention.

---

**Keep batteries out of reach of household pets and other animals.**

The batteries could leak, overheat, rupture, or catch fire if bitten, chewed, or otherwise damaged by animals.

---

**Do not immerse batteries in water or expose to rain.**

Failure to observe this precaution could result in fire or product malfunction. Immediately dry the product with a towel or similar object should it become wet.

---

**Discontinue use immediately should you notice any changes in the batteries, such as discoloration or deformation. Cease charging EN-EL15c rechargeable batteries if they do not charge in the specified period of time.**

Failure to observe these precautions could result in the batteries leaking, overheating, rupturing, or catching fire.

---

**When batteries are no longer needed, insulate the terminals with tape.**

Overheating, rupture, or fire may result should metal objects come into contact with the terminals.

---

**If battery liquid comes into contact with a person's skin or clothing, immediately rinse the affected area with plenty of clean water.**

Failure to observe this precaution could result in skin irritation.

---

# Notices

- No part of the manuals included with this product may be reproduced, transmitted, transcribed, stored in a retrieval system, or translated into any language in any form, by any means, without Nikon's prior written permission.
- Nikon reserves the right to change the appearance and specifications of the hardware and software described in these manuals at any time and without prior notice.
- Nikon will not be held liable for any damages resulting from the use of this product.
- While every effort has been made to ensure that the information in these manuals is accurate and complete, we would appreciate it were you to bring any errors or omissions to the attention of the Nikon representative in your area (address provided separately).

## ● **Notice Concerning Prohibition of Copying or Reproduction**

Note that simply being in possession of material that has been digitally copied or reproduced by means of a scanner, digital camera, or other device may be punishable by law.

### • **Items prohibited by law from being copied or reproduced**

Do not copy or reproduce paper money, coins, securities, government bonds, or local government bonds, even if such copies or reproductions are stamped "Sample".

The copying or reproduction of paper money, coins, or securities which are circulated in a foreign country is prohibited.

Unless the prior permission of the government has been obtained, the copying or reproduction of unused postage stamps or post cards issued by the government is prohibited.

The copying or reproduction of stamps issued by the government and of certified documents stipulated by law is prohibited.



- **Cautions on certain copies and reproductions**

The government has issued cautions on copies or reproductions of securities issued by private companies (shares, bills, checks, gift certificates, etc.), commuter passes, or coupon tickets, except when a minimum of necessary copies are to be provided for business use by a company. Also, do not copy or reproduce passports issued by the government, licenses issued by public agencies and private groups, ID cards, and tickets, such as passes and meal coupons.

- **Comply with copyright notices**

Under copyright law, photographs or recordings of copyrighted works made with the camera cannot be used without the permission of the copyright holder. Exceptions apply to personal use, but note that even personal use may be restricted in the case of photographs or recordings of exhibits or live performances.

- **Use Only Nikon Brand Electronic Accessories**

Nikon cameras are designed to the highest standards and include complex electronic circuitry. Only Nikon brand electronic accessories (including lenses, chargers, batteries, AC adapters, and flash accessories) certified by Nikon specifically for use with this Nikon digital camera are engineered and proven to operate within the operational and safety requirements of this electronic circuitry.

The use of non-Nikon electronic accessories could damage the camera and may void your Nikon warranty. The use of third-party rechargeable Li-ion batteries not bearing the Nikon holographic seal shown at right could interfere with normal operation of the camera or result in the batteries overheating, igniting, rupturing, or leaking.



For more information about Nikon brand accessories, contact a local authorized Nikon dealer.

---

## ✔ Before Taking Important Pictures

Before taking pictures on important occasions (such as at weddings or before taking the camera on a trip), take a test shot to ensure that the camera is functioning normally. Nikon will not be held liable for damages or lost profits that may result from product malfunction.

## ✔ Life-Long Learning

As part of Nikon's "Life-Long Learning" commitment to ongoing product support and education, continually-updated information is available on-line at the following sites:

- **For users in the U.S.A.:** <https://www.nikonusa.com/>
- **For users in Europe:**  
<https://www.europe-nikon.com/support/>
- **For users in Asia, Oceania, the Middle East, and Africa:**  
<https://www.nikon-asia.com/>

Visit these sites to keep up-to-date with the latest product information, tips, answers to frequently-asked questions (FAQs), and general advice on digital imaging and photography. Additional information may be available from the Nikon representative in your area. See the following URL for contact information: <https://imaging.nikon.com/>

---

# Getting to Know the Camera

## Parts of the Camera

### Camera Body

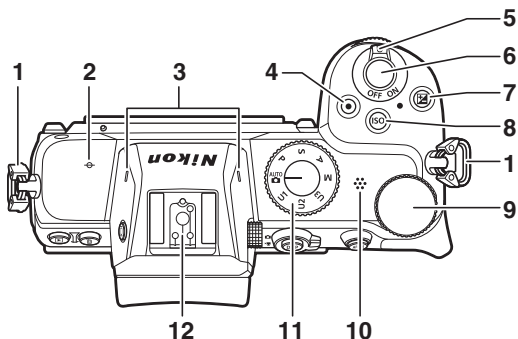

1 Eyelet for camera strap (□ 33)

2  $\ominus$  (focal plane mark; □ 80)

3 Stereo microphone (□ 53)

4 Movie-record button (□ 53)

5 Power switch (□ 44, 48)

6 Shutter-release button (□ 48)

7  button (□ 14, 109)

8 **ISO** button (□ 12, 105)

9 Main command dial (□ 12)

10 Speaker (□ 60)

11 Mode dial (□ 11, 93)

12 Accessory shoe (for optional flash unit; □ 563, 640)

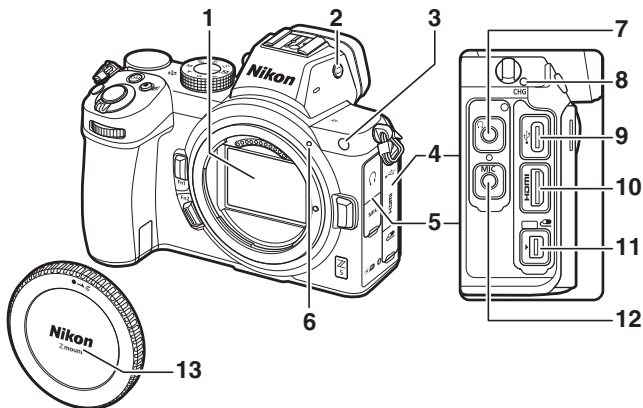

**1** Image sensor (□663)

**2** |□| button (□10, 420)

**3** AF-assist illuminator (□51, 361)

Red-eye reduction lamp

(□139, 569)

Self-timer lamp (□115)

**4** Cover for accessory terminal and USB and HDMI connectors

**5** Cover for headphone and microphone connectors

**6** Lens mounting mark (□42)

**7** Headphone connector (□344)

**8** Charge lamp (□654)

**9** USB connector (□450, 552)

**10** HDMI connector (□557)

**11** Accessory terminal

**12** Connector for external microphone (□651)

**13** Body cap (□42)

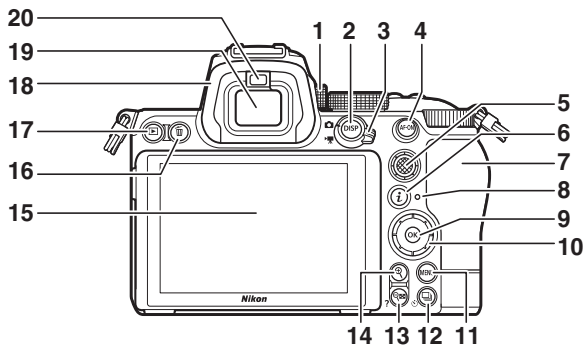

1	Diopter adjustment control (☐9)
2	<b>DISP</b> button (☐21)
3	Photo/movie selector (☐48, 53)
4	<b>AF-ON</b> button (☐24)
5	Sub-selector (☐23, 117)
6	<b>i</b> button (☐29, 120)
7	Memory card slot cover (☐38)
8	Memory card access lamp (☐52, 55)
9	<b>OK</b> button (☐25)

10	Multi selector (☐25)
11	<b>MENU</b> button (☐24, 191)
12	Playback button (☐111, 115)
13	Help button (☐23, 28, 158, 183)
14	Magnifying glass button (☐23, 78, 158, 183)
15	Monitor (☐15, 76)
16	Erase button (☐61, 185)
17	Play button (☐58, 158)
18	Rubber eyecup (☐651)
19	Viewfinder (☐9)
20	Eye sensor (☐9)

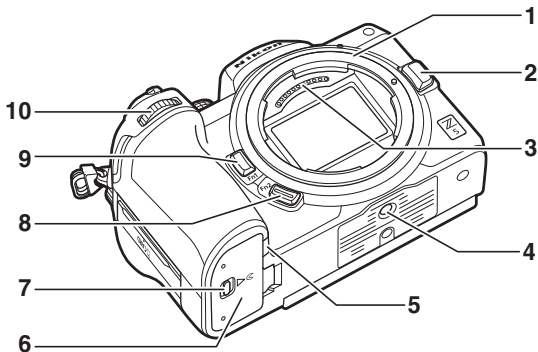

**1** Lens mount (☞42, 80)

**2** Lens release button (☞43)

**3** CPU contacts

**4** Tripod socket

**5** Power connector cover  
(☞657)

**6** Battery-chamber cover

**7** Battery-chamber cover latch

**8** **Fn2** button (☞31, 63)

**9** **Fn1** button (☞31, 81)

**10** Sub-command dial (☞12)

---

### ✔ Do Not Touch the Image Sensor

Under no circumstances should you exert pressure on the image sensor, poke it with cleaning tools, or subject it to powerful air currents from a blower. These actions could scratch or otherwise damage the sensor. For information on cleaning the image sensor, see “Image Sensor Cleaning” (p.663).

### ✔ Notes on the Monitor

The angle of the monitor can be adjusted.

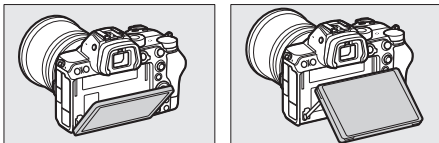

### ✔ Product Serial Number

The serial number for this product can be found by opening the monitor.

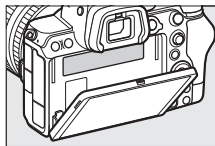

# The Monitor and Viewfinder

## ■ Photo Mode

At default settings, the following indicators appear in the monitor and viewfinder; for a full list of indicators, see “Camera Displays” (629) in “Technical Notes”.

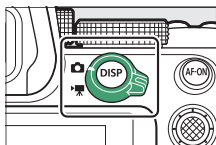

**Monitor**

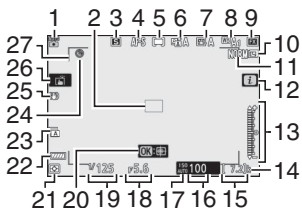

**Viewfinder**

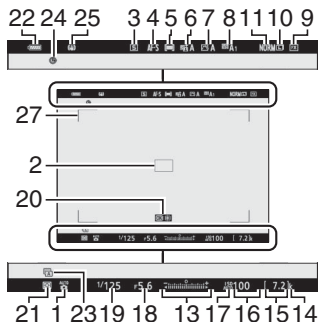



1	Shooting mode (☞93)	15	Number of exposures remaining (☞39, 692)
2	Focus point (☞66)	16	ISO sensitivity (☞105)
3	Release mode (☞111)	17	ISO sensitivity indicator (☞105)
4	Focus mode (☞63)		Auto ISO sensitivity indicator (☞107)
5	AF-area mode (☞66)	18	Aperture (☞96, 97)
6	Active D-Lighting (☞255)	19	Shutter speed (☞95, 97)
7	Picture Control (☞123, 247)	20	Subject-tracking AF (☞74)
8	White balance (☞81, 129, 239)	21	Metering (☞140)
9	Image area (☞234)	22	Battery indicator (☞37)
10	Image size (☞138)	23	Shutter type (☞369)
11	Image quality (☞136)	24	“Clock not set” indicator (☞47)
12	 icon (☞120)	25	Vibration reduction indicator (☞143)
13	Exposure indicator Exposure (☞98) Exposure compensation (☞109)	26	Touch shooting (☞76)
14	“k” (appears when memory remains for over 1000 exposures; ☞39)	27	AF-area brackets (☞66)

## ■ Movie Mode

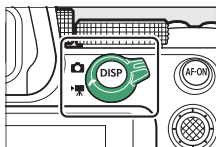

### Monitor

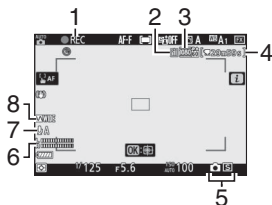

- 1 Recording indicator ( 53)  
"No movie" indicator ( 56)
- 2 Destination ( 155)
- 3 Frame size and rate/image quality ( 150)
- 4 Time remaining ( 53)

### Viewfinder

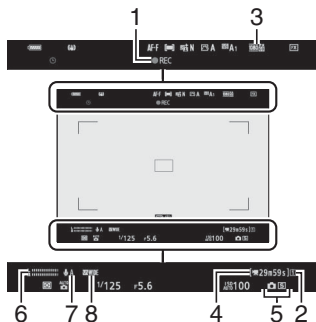

- 5 Release mode (still photography; 114)
- 6 Sound level ( 152)
- 7 Microphone sensitivity ( 152)
- 8 Frequency response ( 343)

# Camera Controls

## Viewfinder

- Placing your eye to the viewfinder activates the eye sensor, switching the display from the monitor to the viewfinder. Note that the eye sensor will also respond to other objects, such as your fingers.
- The viewfinder can be used for menus and playback if desired.

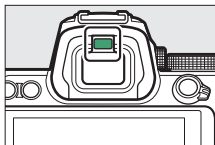

### ✓ **The Diopter Adjustment Control**

- The viewfinder can be focused by lifting and rotating the diopter adjustment control.
- Be careful not to put your fingers or fingernails in your eye.
- After adjusting diopter, push the diopter adjustment control back into its original position.

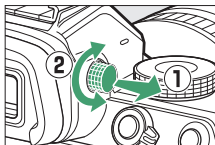

### **Extended Use**

When using the viewfinder for extended periods, you can select [**Off**] for Custom Setting d7 [**Apply settings to live view**] to ensure that viewfinder brightness and hue are adjusted for ease of viewing.

## The (Monitor Mode) Button

Press the  button to cycle between viewfinder and monitor displays.



Press the  button to cycle through the displays as follows.

**[Automatic display switch]:** The camera automatically switches between the viewfinder and monitor displays based on information from the eye sensor.



**[Viewfinder only]:** The monitor remains blank. The viewfinder is used for shooting, menus, and playback.



**[Monitor only]:** The monitor is used for shooting, menus, and playback. The viewfinder display will remain blank even if you put your eye to the viewfinder.



**[Prioritize viewfinder]:** The camera functions in a manner similar to existing digital SLR cameras.

- During photo mode, placing your eye to the viewfinder turns the viewfinder on; the monitor remains off after you take your eye away.
- During movie mode or playback or while menus are displayed, the camera automatically switches between the viewfinder and the monitor based on information from the eye sensor.





## Monitor Mode

You can limit the choice of monitor modes available using the **[Limit monitor mode selection]** item in the setup menu.

## The Mode Dial

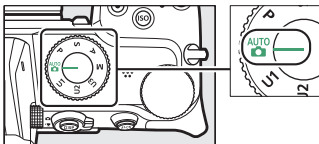
Rotate the mode dial to choose a shooting mode.



Mode		Description
	<b>Auto</b>	A simple, “point-and-shoot” mode that leaves the camera in charge of settings (□48, 53).
<b>P</b>	<b>Programmed auto</b>	The camera sets shutter speed and aperture for optimal exposure.
<b>S</b>	<b>Shutter-priority auto</b>	You choose the shutter speed; the camera selects the aperture for best results.
<b>A</b>	<b>Aperture-priority auto</b>	You choose the aperture; the camera selects the shutter speed for best results.
<b>M</b>	<b>Manual</b>	You control both shutter speed and aperture.
<b>U1</b> <b>U2</b> <b>U3</b>	<b>User settings modes</b>	Assign frequently-used settings to these positions for quick recall.

## The Command Dials

Rotate the command dials to choose settings for shutter speed, aperture, or the functions assigned to other camera controls.

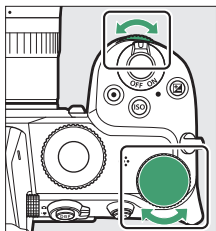

## The ISO Button

Adjust the camera's sensitivity to light (ISO sensitivity) in accord with lighting conditions.

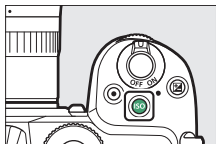

## ■ Photo Mode

ISO sensitivity can be adjusted by holding the **ISO** button and rotating the main command dial.

- In modes **P**, **S**, **A**, and **M**, you can hold the **ISO** button and rotate the sub-command dial to choose from "**ISO AUTO**" (auto ISO sensitivity control enabled) or "**ISO**" (auto ISO sensitivity control disabled).

- In  mode, “**ISO AUTO**” (auto ISO sensitivity control enabled) is selected by default. Hold the **ISO** button and rotate the main command dial to cycle between “**ISO AUTO**” and “**ISO**” (auto ISO sensitivity control disabled).

## ■■ Movie Mode

ISO sensitivity can be adjusted by holding the **ISO** button and rotating the main command dial. ISO sensitivity for movie recording can be adjusted in mode **M** only.

- The value selected for [**ISO sensitivity settings**] > [**ISO sensitivity (mode M)**] applies when [**Off**] is selected for [**ISO sensitivity settings**] > [**Auto ISO control (mode M)**].
- You can choose between “**ISO AUTO**” (auto ISO sensitivity control enabled) and “**ISO**” (auto ISO sensitivity control disabled) by holding the **ISO** button and rotating the sub-command dial.

## The (Exposure Compensation) Button

Alter exposure from the value suggested by the camera.

Exposure compensation can be used to make pictures brighter or darker.



-1 EV



No exposure  
compensation



+1 EV

- Exposure compensation can be adjusted by holding the  button and rotating either command dial.
- Higher values make the subject brighter, lower values darker.

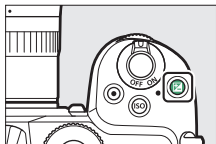



## Touch Controls

The touch-sensitive monitor offers a variety of controls that can be operated by touching the display with your fingers. During viewfinder photography, touch controls are disabled and cannot be used for focus or the like.

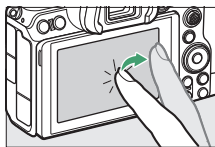

### ■ Focusing and Releasing the Shutter

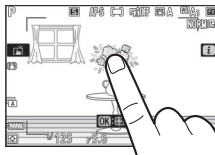

- Touch the monitor to focus on the selected point (touch AF).
- In photo mode, the shutter will be released when you lift your finger from the display (touch shutter).
- Touch shutter/AF settings can be adjusted by tapping the  icon (book 76).

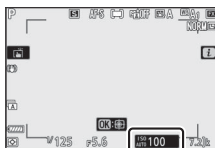

### ■ Adjusting Settings

- Tap highlighted settings in the display.
- You can then choose the desired option by tapping icons or sliders.



- Tap  or press  to select the chosen option and return to the previous display.



## ■ Playback

- Flick left or right to view other pictures during full-frame playback.

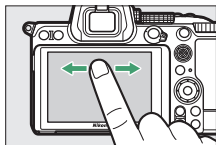

- In full-frame playback, touching the bottom of the display brings up a frame-advance bar. Slide your finger left or right over the bar to scroll rapidly to other pictures.

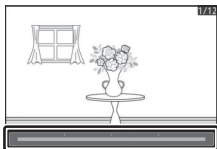
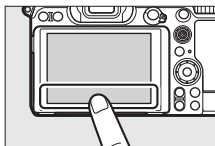

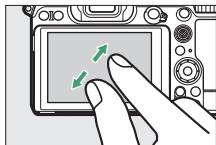

- To zoom in on a picture displayed during full-frame playback, use a stretch gesture or give the display two quick taps. You can adjust the zoom ratio using stretch gestures to zoom in and pinch gestures to zoom out.

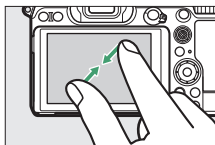

- Use slide gestures to view other parts of the image during zoom.
- Giving the display two quick taps while zoom is in effect cancels zoom.
- To “zoom out” to a thumbnail view, use a pinch gesture during full-frame playback. Use pinch and stretch to choose the number of images displayed from 4, 9, and 72 frames.
- Using a pinch gesture when 72 frames are displayed selects calendar playback. Use a stretch gesture to return to the 72-frame display.



## ■ Viewing Movies

- Movies are indicated by a  icon; to start playback, tap the on-screen guide.
- Tap the display to pause. Tap again to resume.
- Tap  to exit to full-frame playback.

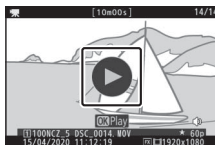

## ■ The *i* Menu

- Tap the **i** icon to display the *i* menu during shooting (☞ 29, 120).



- Tap items to view and change options.

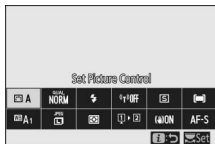

## ■ Text Entry

- When a keyboard is displayed, you can enter text by tapping the keys.



- 1 Text display area
- 2 Keyboard area
- 3 Keyboard selection

- To position the cursor, tap ◀ or ▶ or tap directly in the text display area.
- To cycle through the upper- and lower-case and symbol keyboards, tap the keyboard selection button.

## ■ Navigating the Menus

- Slide up or down to scroll.

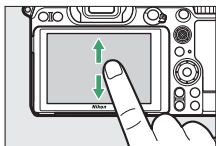

- Tap a menu icon to choose a menu.

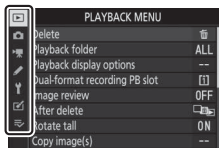

- Tap menu items to display options.  
You can then choose the desired option by tapping icons or sliders.

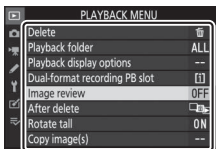

- To exit without changing settings, tap .

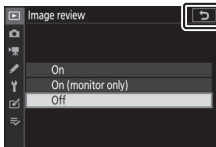

---

## ✔ **The Touch Screen**

- The touch screen responds to static electricity. It may not respond when touched with fingernails or gloved hands.
- Do not touch the screen with sharp objects.
- Do not use excessive force.
- The screen may not respond when covered with third-party protective films.
- The screen may not respond when touched simultaneously in multiple locations.

---

## ✔ **Enabling or Disabling Touch Controls**

Touch controls can be enabled or disabled using the **[Touch controls]** item in the setup menu.

---

## The DISP Button

Use the **DISP** button to cycle through the following displays:

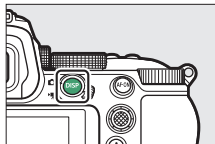

### Photo Mode

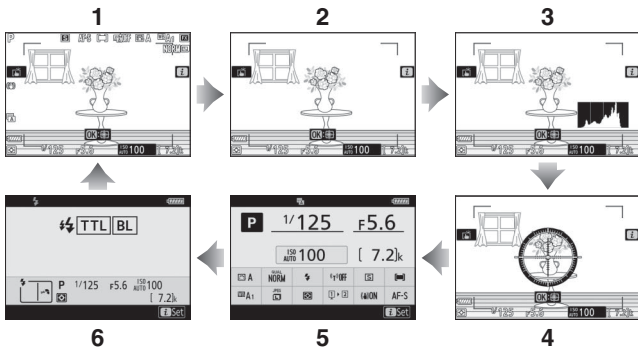

1 Indicators on

2 Simplified display

3 Histogram <sup>1,2</sup>

4 Virtual horizon

5 Information display (□629)

6 Flash info (□576, 607) <sup>3</sup>

- 1 Displayed when **[On]** is selected for Custom Setting d7 [**Apply settings to live view**].
- 2 Not displayed if **[On]** is selected for **[Overlay shooting]** during multiple exposure photography.

- 3 Displayed when an optional SB-5000, SB-500, SB-400, or SB-300 flash unit is mounted on the accessory shoe or a WR-R10 wireless remote controller commands a flash unit via radio flash control.

---

### The Viewfinder

The **DISP** button can also be used to choose the information displayed in the viewfinder. Note, however, that the information display and flash info do not appear in the viewfinder.

---

## ■■ Movie Mode

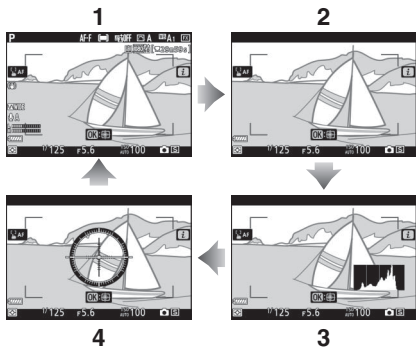

- 1 Indicators on
- 2 Simplified display
- 3 Histogram
- 4 Virtual horizon





## The and (?) Buttons

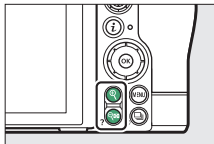



Zoom the display in the monitor in or out during shooting or playback.



### ■ Shooting

Press  to zoom in on the view through the lens during shooting. Press  to increase the zoom ratio,  (?) to zoom out.

### ■ Playback

Press  to zoom in on pictures during full-frame playback. Press  to increase the zoom ratio,  (?) to zoom out. Pressing  (?) when the picture is displayed full frame “zooms out” to the thumbnail list. Pressing  (?) when 72 frames are displayed selects calendar playback.

## The Sub-Selector

Press the sub-selector up, down, left, or right to select the focus point. Press and hold the center of the selector to lock focus and exposure ( 117).

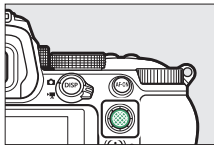

## The AF-ON Button

The **AF-ON** button can be used for focus in autofocus mode.

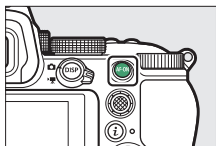

## The MENU Button

Press the **MENU** button to view the menus.

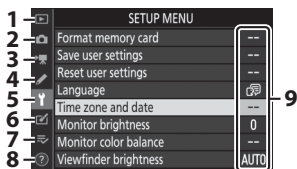
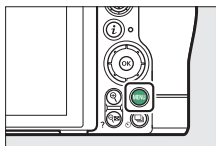

- 1 [PLAYBACK MENU] (☐ 208)
- 2 [PHOTO SHOOTING MENU] (☐ 223)
- 3 [MOVIE SHOOTING MENU] (☐ 333)
- 4 [CUSTOM SETTING MENU] (☐ 347)
- 5 [SETUP MENU] (☐ 413)
- 6 [RETOUCH MENU] (☐ 460)
- 7 [MY MENU]/  
 [RECENT SETTINGS] \* (☐ 491)
- 8 The Help icon (☐ 28)
- 9 Current settings

\* You can choose the menu displayed. The default is [MY MENU].

## ■ Using the Menus

You can navigate the menus using the multi selector and **OK** button.

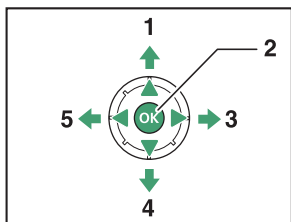

- 1 Move cursor up
- 2 Select highlighted item
- 3 Display sub-menu, select highlighted item, or move cursor right
- 4 Move cursor down
- 5 Cancel and return to previous menu, or move cursor left

### 1 Highlight the icon for the current menu.

Press **OK** to place the cursor in the menu-selection area.

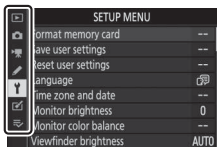

### 2 Select a menu.

Press **Up** or **Down** to select the desired menu.

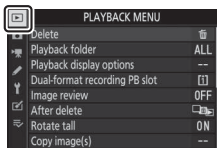

---

### 3 Position the cursor in the selected menu.

Press  to position the cursor in the selected menu.



---

### 4 Highlight a menu item.

Press  or  to highlight a menu item.

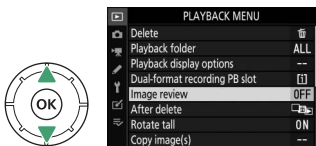

---

### 5 Display options.

Press  to display options for the selected menu item.



---

## 6 Highlight an option.

Press  or  to highlight an option.

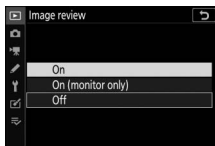

---

## 7 Select the highlighted option.

- Press  to select the highlighted option.
- To exit without making a selection, press the **MENU** button.
- To exit the menus and return to shooting mode, press the shutter-release button halfway.







---

## ✔ Grayed-Out Items

Some items and menu options may be unavailable depending on the mode and camera status. Unavailable items are displayed in gray.

---

## ✔ The ? (Help) Icon

- Where available, a description of the currently-selected item can be viewed by pressing the  (?) button.
- Press  or  to scroll.
- Press  (?) again to return to the menu.

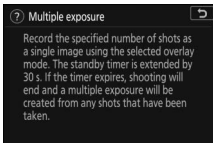
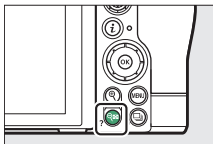

## ✔ Touch Controls

You can also navigate the menus using touch controls ( 15).

---

## The *i* Button (the *i* Menu)

For quick access to frequently-used settings, press the *i* button or tap the *i* icon to view the *i* menu.

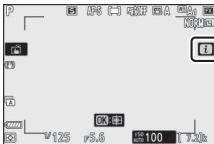
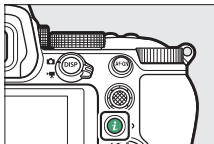

- Different menus are displayed during photo mode and movie mode.
- Options can be viewed by tapping items in the display or by highlighting items and pressing **OK**; selections can then be made using the multi selector.
- Items for which the camera displays an on-screen guide can be adjusted by highlighting them in the *i* menu and rotating a command dial. In some cases, adjustments can be made using both the main and sub-command dials.

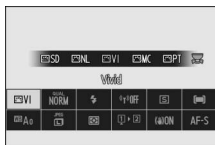
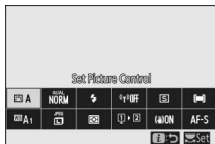

---

### The Playback *i* Menu

Pressing the *i* button during playback displays a context-sensitive *i* menu of frequently-used playback options.

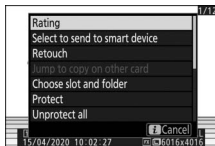

## ■ Customizing the **i** Menu

The items displayed in the photo-mode **i** menu can be chosen using Custom Setting f1 or g1 [**Customize **i** menu**].

### 1 Highlight Custom Setting f1 or g1 [**Customize **i** menu**] and press **OK**.

See “The MENU Button” (□ 24) for information on using the menus.



### 2 Highlight the position you want to change and press **OK**.

A list of the items available for the selected position will be displayed.

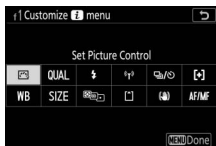

### 3 Highlight the desired item and press **OK**.

- The item will be assigned to the selected position and the options shown in Step 2 will be displayed.
- Repeat Steps 2 and 3 as desired.

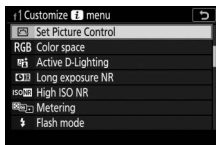

### 4 Press the MENU button.

Changes will be saved and the Custom Settings menu will be displayed.



## The Fn1 and Fn2 Buttons

Use the **Fn1** or **Fn2** button for quick access to selected settings.

- By default, the **Fn1** button is assigned white balance (☰81) and the **Fn2** button focus- and AF-area-mode selection (☰63).
- The assigned setting can be adjusted by holding the **Fn1** or **Fn2** button and rotating the command dials. In some cases, adjustments can be made using both the main and sub-command dials.

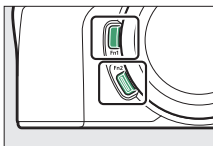

### ■ Choosing Roles for the Fn1 and Fn2 Buttons

The roles played by the **Fn1** and **Fn2** buttons can be selected using Custom Setting f2 or g2 [**Custom controls**] > [**Fn1 button**] and [**Fn2 button**].

#### 1 Highlight Custom Setting f2 or g2 [**Custom controls**] and press

Ⓞ.

See “The MENU Button” (☰24) for information on using the menus.

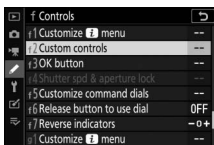

#### 2 Highlight the option for the desired button and press

A list of the items available for the selected button will be displayed.



---

### 3 Highlight the desired item and press **OK**.

- The item will be assigned to the selected button and the options shown in Step 2 will be displayed.
- Repeat Steps 2 and 3 to assign a role to the remaining button.

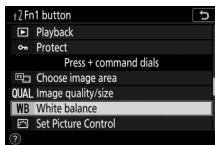

---

### 4 Press the MENU button.

Changes will be saved and the Custom Settings menu will be displayed.

# First Steps

## Attaching the Strap

To attach a strap (whether the supplied strap or one that has been purchased separately):

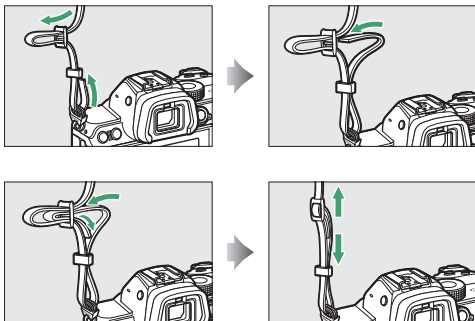

## Charging the Battery

Charge the supplied EN-EL15c battery in the supplied MH-25a battery charger before use. Insert the battery and plug the charger in (depending on the country or region, the charger comes with either an AC wall adapter or a power cable).

### ✓ The Battery and Charger

Read and follow the warnings and cautions in "For Your Safety" (□xxxv) and "Caring for the Camera and Battery: Cautions" (□667).

- **AC wall adapter:** After inserting the AC wall adapter into the charger AC inlet (①), slide the AC wall adapter latch as shown (②) and rotate the adapter 90° to fix it in place (③).

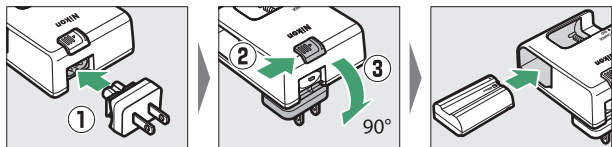

- **Power cable:** After connecting the power cable with the plug in the orientation shown, insert the battery and plug the cable in.

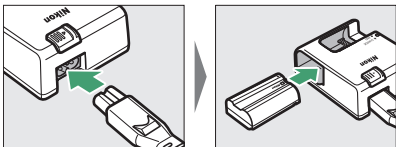

- An exhausted battery will fully charge in about 2 hours and 35 minutes.

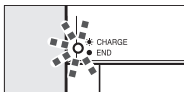

Battery charging (flashes)

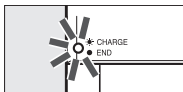

Charging complete (steady)

---

### ✓ If the CHARGE Lamp Flashes Rapidly

If the **CHARGE** lamp flashes rapidly (8 times a second):

- **A battery charging error has occurred:** Unplug the charger and remove and reinsert the battery.
- **The ambient temperature is too hot or too cold:** Use the battery charger at temperatures within the designated temperature range (0–40 °C/+32–104 °F).

If the problem persists, unplug the charger and end charging. Bring the battery and charger to a Nikon-authorized service representative.

---

## Inserting the Battery

- Turn the camera off before inserting or removing the battery.
- Using the battery to keep the orange battery latch pressed to one side, slide the battery into the battery chamber until the latch locks it in place.

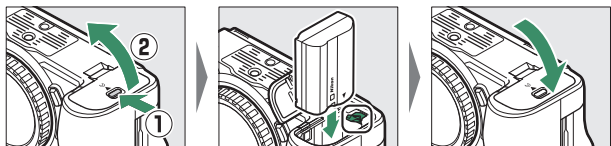

## Removing the Battery

To remove the battery, turn the camera off and open the battery-chamber cover. Press the battery latch in the direction shown by the arrow to release the battery and then remove the battery by hand.

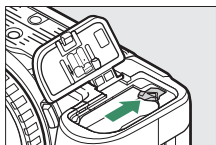

## Battery Level

- The battery level is shown in the shooting display while the camera is on.

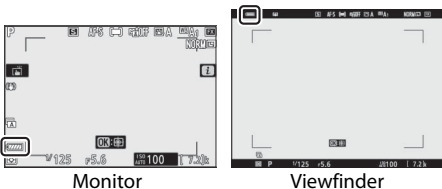

- The battery level display changes as the battery level diminishes, from through , , , and . When the battery level falls to , suspend shooting and charge the battery or ready a spare battery.
- If the message [**Shutter release disabled. Recharge battery.**] is displayed, charge or exchange the battery.

## Inserting Memory Cards

- Turn the camera off before inserting or removing memory cards.
- The camera is equipped with two memory card slots: Slot 1 (①) and Slot 2 (②), allowing use of two memory cards. If you are using only one memory card, insert it into Slot 1.

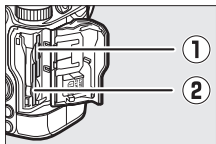

- Holding the memory card in the orientation shown, slide it straight into the slot until it clicks into place.

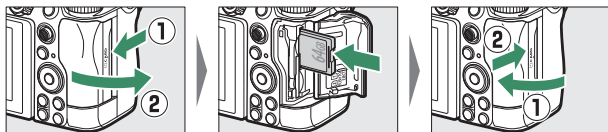

## Removing Memory Cards

After confirming that the memory card access lamp is off, turn the camera off, open the memory card slot cover, and press the card in to eject it (①). The card can then be removed by hand (②).

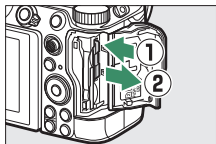



## Number of Exposures Remaining

- When the camera is on, the shooting display shows the number of photographs that can be taken at current settings.
- At default settings, [**Overflow**] is selected for [**Role played by card in Slot 2**] in the photo shooting menu. When two memory cards are inserted, pictures will first be recorded to the card in Slot 1, switching to Slot 2 when the card in Slot 1 is full.
- If two memory cards are inserted, the camera will show the number of additional photographs that can be recorded to the card in Slot 1. When the card in Slot 1 is full, the display will show the number of exposures remaining on the card in Slot 2.
- Values over 1000 are rounded down to the nearest hundred. For example, values between 1500 and 1599 are shown as 1.5 k.

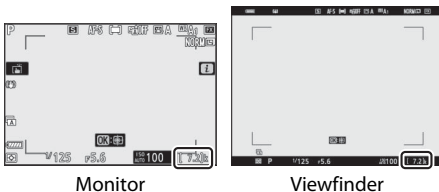

---

## ✔ Memory Cards

- Memory cards may be hot after use. Observe due caution when removing memory cards from the camera.
- Do not perform the following operations during formatting or while data are being recorded, deleted, or copied to a computer or other device. Failure to observe these precautions could result in loss of data or in damage to the camera or card.
  - Do not remove or insert memory cards
  - Do not turn the camera off
  - Do not remove the battery
  - Do not disconnect AC adapters
- Do not touch the card terminals with your fingers or metal objects.
- Do not use excessive force when handling memory cards. Failure to observe this precaution could damage the card.
- Do not bend or drop memory cards or subject them to strong physical shocks.
- Do not expose memory cards to water, heat, or direct sunlight.
- Do not format memory cards in a computer.

## ✔ No Memory Card Inserted

If no memory card is inserted, a “no memory card” indicator and [-E-] will appear in the shooting display.

---

---

## The Write Protect Switch

- SD memory cards are equipped with a write-protect switch. Sliding the switch to the “lock” position write-protects the card, protecting the data it contains.
- A “---” indicator and a [Card] warning appear in the shooting display when a write-protected card is inserted.
- If you attempt to release the shutter while a write-protected card is inserted, a warning will be displayed and no picture will be recorded. Unlock the memory card before attempting to take or delete pictures.

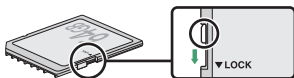

## Attaching a Lens

- The camera can be used with Z mount lenses. The lens generally used in this manual for illustrative purposes is a NIKKOR Z 24–70mm f/4 S.
- Be careful to prevent dust entering the camera.
- Confirm that the camera is off before attaching the lens.
  - Remove the camera body cap (①, ②) and rear lens cap (③, ④).

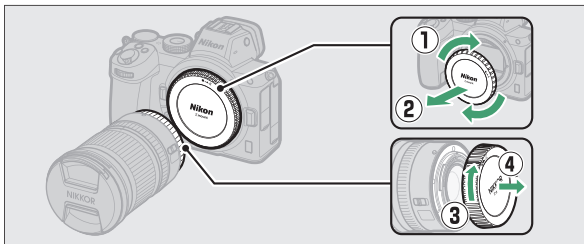

- Align the mounting marks on the camera (⑤) and lens (⑥).  
Do not touch the image sensor or lens contacts.

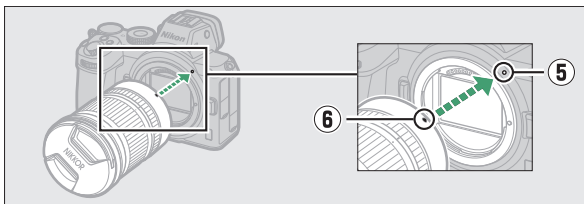

- Rotate the lens as shown until it clicks into place (7).

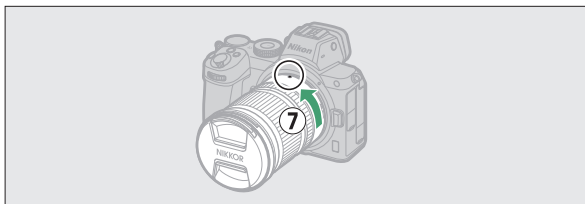

- Remove the front lens cap before taking pictures.

---

### ✓ F Mount Lenses

- Be sure to attach the FTZ mount adapter (available separately) before using F mount lenses.
  - Attempting to attach F mount lenses directly to the camera could damage the lens or image sensor.
- 

## Detaching Lenses

- After turning the camera off, press and hold the lens release button (1) while turning the lens in the direction shown (2).
- After removing the lens, replace the lens caps and camera body cap.

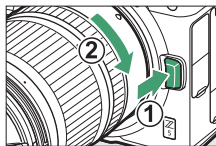

# Choose a Language and Set the Clock

The language option in the setup menu is automatically highlighted the first time menus are displayed. Choose a language and set the camera clock.

## 1 Turn the camera on.

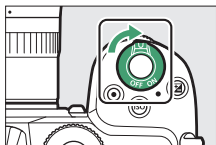

## 2 Highlight [Language] in the setup menu and press .

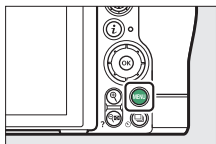

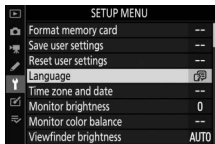

- The [**Language**] item is automatically highlighted in the setup menu the first time the **MENU** button is pressed after purchase.
- For information on using the menus, see “Using the Menus” (□ 25).



---

### 3 Select a language.

Press  or  to highlight the desired language and press  (the languages available vary with the country or region in which the camera was originally purchased).

---

### 4 Highlight [Time zone and date] and press .

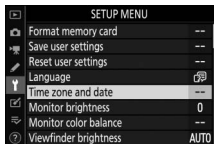

---

### 5 Choose a time zone.

- Select [Time zone] in the [Time zone and date] display.
- Highlight a time zone in the [Time zone] display and press .
- The display shows a time zone map listing the selected cities in the chosen zone and the difference between the time in the chosen zone and UTC.

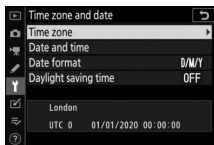

## 6 Turn daylight saving time on or off.

- Select [**Daylight saving time**] in the [**Time zone and date**] display.
- Highlight [**On**] (daylight saving time on) or [**Off**] (daylight saving time off) and press **OK**.
- Selecting [**On**] advances the clock one hour; to undo the effect, select [**Off**].

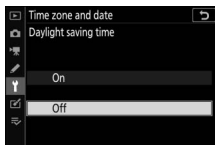

## 7 Set the clock.

- Select [**Date and time**] in the [**Time zone and date**] display.
- Press **OK** after using the multi-selector to set the clock to the date and time in the selected time zone (note that the camera uses a 24-hour clock).

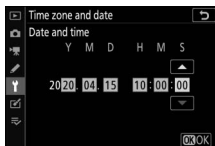

## 8 Choose a date format.

- Select [**Date format**] in the [**Time zone and date**] display.
- Highlight the desired date (year, month, and day) display order and press **OK**.

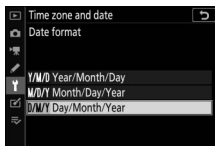



---

## 9 Exit the menus.

Lightly press the shutter-release button halfway to exit to shooting mode.



---

### ✓ The ☺ Icon

A flashing ☺ icon in the shooting display indicates that the camera clock has been reset. The date and time recorded with new photographs will not be correct; use the **[Time zone and date]** > **[Date and time]** option in the setup menu to set the clock to the correct time and date. The camera clock is powered by an independent clock battery. The clock battery charges when the main battery is inserted in the camera. It takes about 2 days to charge. Once charged, it will power the clock for about a month.

---

### ✍ SnapBridge

Use the SnapBridge app to synchronize the camera clock with the clock on a smartphone or tablet (smart device). See SnapBridge online help for details.

---

# Basic Photography and Playback

## Taking Photographs (AUTO Mode)

Select  (auto) mode for simple “point-and-shoot” photography.

### ✔ Lenses with Retractable Barrels

Lenses with retractable barrels must be extended before use. Rotate the lens zoom ring as shown until the lens clicks into the extended position.

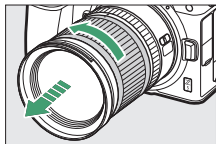

## 1 Turn the camera on.

The monitor turns on.

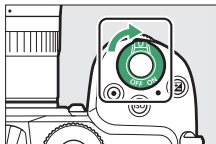

**2** Select photo mode by rotating the photo/movie selector to .

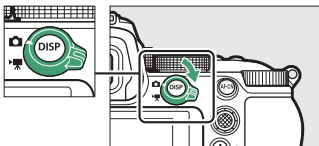

**3** Rotate the mode dial to <sup>AUTO</sup>.

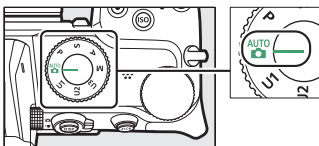

---

## 4 Ready the camera.

Holding the handgrip in your right hand and cradling the camera body or lens with your left, bring your elbows in against the sides of your chest.

- **Framing photos in the viewfinder:**



Landscape (wide)  
orientation



Portrait (tall) orientation

- **Framing photos in the monitor:**



Landscape (wide)  
orientation



Portrait (tall) orientation

---

## 5 Frame the photograph.

Position the main subject in the AF-area brackets.



## 6 Press the shutter-release button halfway to focus.



- The focus point will be displayed in green when the camera focuses. If the camera is unable to focus, the AF-area brackets will flash.
- The AF-assist illuminator may light to assist the focus operation if the subject is poorly lit.
- You can also focus by pressing the **AF-ON** button.

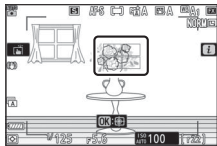

### ✓ The AF-Assist Illuminator

Do not obstruct the AF-assist illuminator while it is lit.



## 7 Smoothly press the shutter-release button the rest of the way down to take the photograph.



- You can also take a photograph by touching the monitor. Touch your subject to focus and lift your finger to release the shutter.

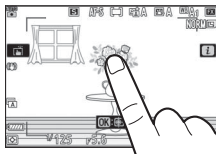

### ✓ The Memory Card Access Lamp

The memory card access lamp will light while the photograph is being recorded. *Do not remove the memory card or battery.*

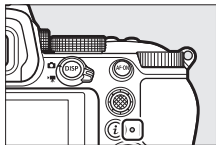

### ✓ The Standby Timer

The camera uses a standby timer to help reduce the drain on the battery. If no operations are performed for about 30 seconds, the standby timer will expire and the monitor and viewfinder will turn off. A few seconds prior to turning off, the displays will dim. They can be reactivated by pressing the shutter-release button halfway. The length of time before the standby timer expires automatically can be selected using Custom Setting c3 [Power off delay] > [Standby timer].

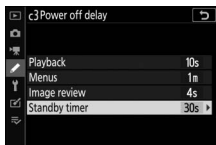

# Shooting Movies (AUTO Mode)

 (auto) mode can also be used for simple, “point-and-shoot” movie recording.

## 1 Turn the camera on.

The monitor turns on.

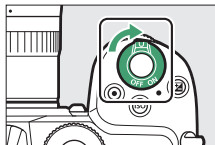

## 2 Select movie mode by rotating the photo/movie selector to .

Note that optional flash units cannot be used when the camera is in movie mode.

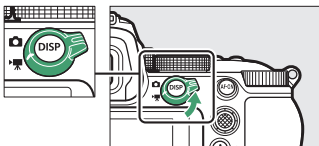

## 3 Rotate the mode dial to .

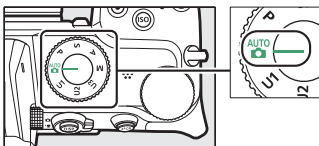

## 4 Press the movie-record button to start recording.

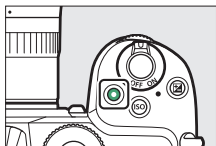

- A recording indicator will be displayed in the monitor. The monitor also shows the time remaining, or in other words the approximate amount of new footage that can be recorded to the memory card.

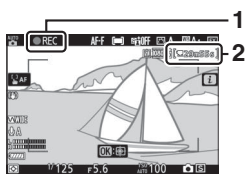

- |   |                     |
|---|---------------------|
| 1 | Recording indicator |
| 2 | Time remaining      |

- The camera can be refocused during recording by pressing the **AF-ON** button.
- Sound is recorded via the built-in microphone. Do not cover the microphone during recording.
- If you tap your subject in the monitor during recording, the focus point will track the subject as it moves through the frame (📖 74).



---

## 5 Press the movie-record button again to end recording.

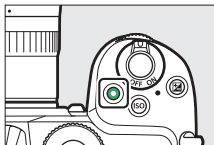

---

### ✔ The Memory Card Access Lamp

The memory card access lamp will light while the photograph is being recorded. *Do not remove the memory card or battery.*

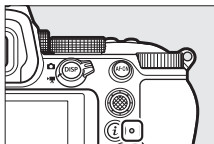

## Taking Photos in Movie Mode

Photos can be taken in movie mode by pressing the shutter-release button all the way down. The release mode (single-frame or continuous) can be selected before shooting begins using the  (☺) button.

- A  icon will flash in the display when a photo is taken.
- The frame advance rate for [**Continuous**] release mode varies with the option selected for [**Frame size/ frame rate**].
- Photos can be taken while recording is in progress. Taking photos does not interrupt movie recording. Note, however, that only one photo will be taken each time the shutter-release button is pressed, even if [**Continuous**] is selected for release mode.

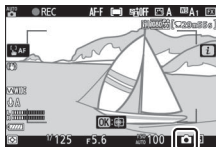

---

### ✓ The Icon

A  icon indicates that movies cannot be recorded.

### ✓ Recording Movies

- Movie recording will end automatically if:
  - The maximum length is reached
  - Another mode is selected
  - The photo/movie selector is rotated to 
  - The lens is removed
- Sounds made by the camera may be audible in footage recorded:
  - During autofocus
  - During vibration reduction
  - When power aperture is used

## ✔ Taking Photos in Movie Mode

- Photo-mode settings do not apply to photos taken in movie mode.
- Up to 40 photographs can be taken with each movie.
- Note that photos can be taken even when the subject is not in focus.
- Photos are recorded at the dimensions currently selected for movie frame size.
- Photos are recorded in [JPEG fine★] format, regardless of the option selected for image quality.
- Photos taken during movie recording are saved to the memory card in the slot selected for [Destination] in the movie shooting menu or in the **i** menu for movie mode.
- A  icon indicates that photos cannot be taken.

## ✔ Photography and Movie Recording

- You may notice the following in the shooting display. These phenomena will also be visible in any photos or footage recorded with the camera.
    - Flicker or banding in scenes lit by such sources as fluorescent, mercury vapor, or sodium lamps
    - Moving objects in the display appear distorted (individual subjects such as trains or cars moving at high speed through the frame may be distorted, or the entire frame may appear distorted when the camera is panned horizontally)
    - Jagged edges, color fringing, *moiré*, and bright spots may appear in the display
    - Bright regions or bands may appear in scenes lit by flashing signs and other intermittent light sources or when the subject is briefly illuminated by a strobe or other bright, momentary light source
    - Flicker occurring when power aperture is used during movie recording
  - Note that noise (randomly-spaced bright pixels, fog, or lines) and unexpected colors may appear if you use the  button to zoom in on the view through the lens during filming.
  - When recording, avoid pointing the camera at the sun or other strong light sources. Failure to observe this precaution could result in damage to the camera's internal circuitry.
-

# Playback

Press the  button to view photos and movies recorded with the camera.

## Viewing Photos

Photos can be viewed by following the steps below.

### 1 Press the button.

- A picture will be displayed in the monitor or viewfinder.
- The memory card containing the picture currently displayed is shown by an icon.

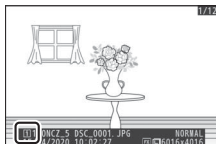
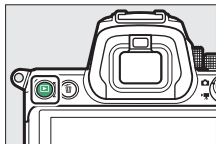



### 2 Press or to view additional pictures.

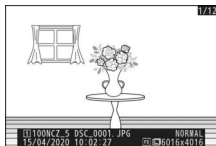

- When pictures are displayed in the monitor, you can view other pictures by flicking a finger left or right over the display.
- To end playback and return to shooting mode, press the shutter-release button halfway.





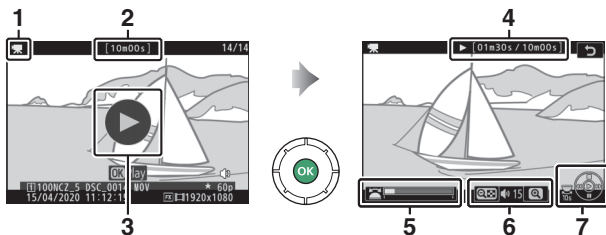















## Viewing Movies

Movies are indicated by a  icon. Tap the  icon in the display or press the  button to start playback (a progress bar shows your approximate position in the movie).



- 1  icon
- 2 Length
- 3  icon
- 4 Current position/total length
- 5 Progress bar
- 6 Volume
- 7 Guide



## Movie Playback Operations

Operation	Description
<b>Pause</b>	Press  to pause playback.
<b>Resume</b>	Press the  button to resume playback when playback is paused or during rewind/advance.
<b>Rewind/ advance</b>	<ul style="list-style-type: none"><li>• Press  to rewind,  to advance. Speed increases with each press, from 2x to 4x to 8x to 16x.</li><li>• Keep  or  pressed to skip respectively to the first frame or last frame.</li><li>• The first frame is indicated by a  in the top right corner of the display, the last frame by a .</li></ul>
<b>Start slow-motion playback</b>	Press  while the movie is paused to start slow-motion playback.
<b>Jog rewind/advance</b>	<ul style="list-style-type: none"><li>• Press  or  while the movie is paused to rewind or advance one frame at a time.</li><li>• Keep  or  pressed for continuous rewind or advance.</li></ul>
<b>Skip 10 s</b>	Rotate the main command dial one stop to skip ahead or back 10 s.
<b>Skip to last or first frame</b>	Rotate the sub-command dial to skip to the last or first frame.
<b>Adjust volume</b>	Press  to increase volume,  (?) to decrease.
<b>Trim movie</b>	To display the [EDIT MOVIE] menu, pause playback and press the  button.
<b>Exit</b>	Press  or  to exit to full-frame playback.
<b>Exit to shooting mode</b>	Press the shutter-release button halfway to end playback.

## Deleting Unwanted Pictures



Pictures can be deleted as described below. *Note that once deleted, pictures cannot be recovered.*

### 1 Display the picture.

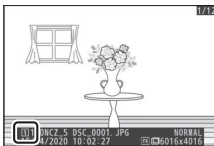
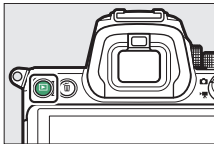
- Press the  button to start playback and press  or  until the desired picture is displayed.
- The location of the current image is shown by an icon at the bottom left corner of the display.



### 2 Delete the picture

- Press the  button; a confirmation dialog will be displayed. Press the  button again to delete the image and return to playback.
- To exit without deleting the picture, press .

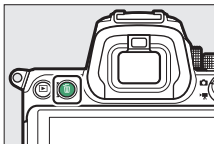

---

### **The Playback Menu [Delete] Item**

Use [**Delete**] in the playback menu to:

- Delete multiple pictures
  - Delete pictures taken on selected dates
  - Delete all pictures in selected folders
-



# Basic Settings

## Focus

### Focus Mode

Choose how the camera focuses.

#### ■ ■ Choosing a Focus Mode

- The focus mode can be selected using the [**Focus mode**] items in the **i** menu and the photo and movie shooting menus (☞ 146, 267, 341).



- At default settings, the focus mode can also be selected by holding the **Fn2** button and rotating the main command dial (☞ 31).

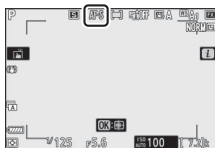

Option		Description
<b>AF-S</b>	<b>[Single AF]</b>	<ul style="list-style-type: none"> <li>• Use with stationary subjects. When you press the shutter-release button halfway to focus, the focus point will turn from red to green and focus will lock. If the camera fails to focus, the focus point will flash red and the shutter release will be disabled.</li> <li>• At default settings, the shutter can only be released if the camera is able to focus (focus priority).</li> </ul>
<b>AF-C</b>	<b>[Continuous AF]</b>	<ul style="list-style-type: none"> <li>• For moving subjects. The camera adjusts focus continuously in response to changes in the distance to the subject while the shutter-release button is pressed halfway.</li> <li>• At default settings, the shutter can be released whether or not the subject is in focus (release priority).</li> </ul>
<b>AF-F</b>	<b>[Full-time AF]</b>	<ul style="list-style-type: none"> <li>• The camera adjusts focus continuously in response to subject movement or changes in composition.</li> <li>• When the shutter-release button is pressed halfway, the focus point will turn from red to green and focus will lock.</li> <li>• This option is only available in movie mode.</li> </ul>
<b>MF</b>	<b>[Manual focus]</b>	Focus manually (□78). The shutter can be released whether or not the subject is in focus.

---

## ✔ Autofocus

- The camera may be unable to focus if:
  - The subject contains lines parallel to the long edge of the frame
  - The subject lacks contrast
  - The subject in the focus point contains areas of sharply contrasting brightness
  - The focus point includes night-time spot lighting or a neon sign or other light source that changes in brightness
  - Flicker or banding appears under fluorescent, mercury-vapor, sodium-vapor, or similar lighting
  - A cross (star) filter or other special filter is used
  - The subject appears smaller than the focus point
  - The subject is dominated by regular geometric patterns (e.g., blinds or a row of windows in a skyscraper)
  - The subject is moving
- The monitor may brighten or darken while the camera focuses.
- The focus point may sometimes be displayed in green when the camera is unable to focus.

## ✔ Turning the Camera Off

The focus position may change if you turn the camera off and then on again after focusing.

---

## AF-Area Mode

Choose how the camera selects the focus-point for autofocus.

- In modes other than [**Auto-area AF**], the focus point can be positioned using the sub-selector (📖 117) or multi selector.

### ■ Choosing an AF-Area Mode



- AF-area mode can be selected using the [**AF-area mode**] items in the **i** menu and the photo and movie shooting menus (📖 145, 268, 341).



- At default settings, AF-area mode can also be selected by holding the **Fn2** button and rotating the sub-command dial (📖 31).

Option	Description
[PIN] <b>[Pinpoint AF]</b>	<ul style="list-style-type: none"><li>• With a focus area smaller than that employed for single-point AF, pinpoint AF is used for pinpoint focus on a selected spot in the frame.</li><li>• Focusing may be slower than with single-point AF.</li><li>• Recommended for shots involving static subjects, such as buildings, in-studio product photography, or close-ups.</li><li>• This option is only available when photo mode is selected and [<b>Single AF</b>] is chosen for [<b>Focus mode</b>].</li></ul>

Option		Description
[C1]	<b>[Single-point AF]</b>	<ul style="list-style-type: none"> <li>• The camera focuses on a point selected by the user.</li> <li>• Use with stationary subjects.</li> </ul>
[C2]	<b>[Dynamic-area AF]</b>	<ul style="list-style-type: none"> <li>• The camera focuses on a point selected by the user. If the subject briefly leaves the selected point, the camera will focus based on information from surrounding focus points.</li> <li>• Use for photographs of athletes and other active subjects that are hard to frame using single-point AF.</li> <li>• This option is only available when photo mode is selected and <b>[Continuous AF]</b> is chosen for focus mode.</li> </ul>
[WIDE-S]	<b>[Wide-area AF (S)]</b>	<ul style="list-style-type: none"> <li>• As for single-point AF except that the camera focuses on a wider area.</li> <li>• Choose for snapshots, subjects that are in motion, and other subjects that are difficult to photograph using single-point AF.</li> <li>• During movie recording, wide-area AF can be used for smooth focus when making panning or tilting shots or filming moving subjects.</li> </ul>
[WIDE-L]	<b>[Wide-area AF (L)]</b>	<ul style="list-style-type: none"> <li>• If the selected focus area contains subjects at different distances from the camera, the camera will assign priority to the closest subject.</li> <li>• The focus areas for <b>[Wide-area AF (L)]</b> are larger than those for <b>[Wide-area AF (S)]</b>.</li> </ul>

Option	Description
 <b>[Auto-area AF]</b>	<ul style="list-style-type: none"> <li>• The camera automatically detects the subject and selects the focus area.</li> <li>• Use on occasions when you don't have time to select the focus point yourself, for portraits, or for snapshots and other spur-of-the-moment photos.</li> <li>• A yellow border indicating the focus point appears around the faces of human subjects detected by the camera. If eyes are detected, the yellow focus point will instead appear over one or the other of their eyes (face/eye detection AF). This frees you to concentrate on framing and your subject's expression while photographing active portrait subjects (□□70).</li> <li>• If <b>[Animal detection on]</b> is selected for Custom Setting a4 <b>[Auto-area AF face/eye detection]</b>, a yellow focus point will appear over the faces of dogs or cats detected by the camera. If eyes are detected, the yellow focus point will instead appear over one or the other of their eyes (animal face/eye-detection AF, □□72).</li> <li>• Subject tracking (□□74) can be initiated by pressing the  button. Custom Setting f2 or g2 <b>[Custom controls]</b> can be used to configure the <b>Fn1</b> or <b>Fn2</b> button to start subject-tracking AF (□□382, 403). Subject-tracking AF can also be assigned to the lens <b>Fn</b> or <b>Fn2</b> button using Custom Setting f2 <b>[Custom controls]</b>.</li> </ul>

---

### : **The Center Focus Point**

In all AF-area modes except [**Auto-area AF**], a dot appears in the focus point when it is in the center of the frame.

### **Quick Focus-Point Selection**

- For quicker focus-point selection, choose [**Every other point**] for Custom Setting a5 [**Focus points used**] to use only a quarter of the available focus points. The number of points available for [**Pinpoint AF**] and [**Wide-area AF (L)**] does not change.
  - If you prefer to use the sub-selector for focus-point selection, you can choose [**Select center focus point**] for Custom Setting f2 [**Custom controls**] > [**Sub-selector center**] to allow the center of the sub-selector to be used to quickly select the center focus point.
-

## ■ Focusing on the Faces or Eyes of Portrait Subjects (Face/Eye-Detection AF)

When photographing portrait subjects with [Auto-area AF], use Custom Setting a4 [Auto-area AF face/eye detection] to choose whether the camera detects both faces and eyes (face/eye-detection AF) or only faces (face-detection AF).

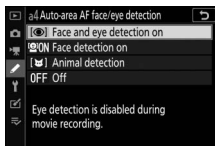

- If [Face and eye detection on] is selected and a portrait subject is detected, a yellow border indicating the focus point will appear around the subject's face. If the camera detects the subject's eyes, the yellow focus point will instead appear over one or the other of their eyes.
- Faces detected when [Face detection on] is selected are similarly indicated by a yellow focus point.
- If **AF-C** is selected for focus mode, the focus point will light yellow when faces or eyes are detected.
- If **AF-S** is selected for focus mode, the focus point will turn green when the camera focuses.
- If more than one portrait subject or more than one eye is detected, ◀ and ▶ icons will appear on the focus point. You will be able to position the focus point over a different face or eye by pressing ◀ or ▶.





- If the subject looks away after their face is detected, the focus point will move to track their motion.
- During playback, you can zoom in on the face or eye used for focus by pressing **OK**.

---

**✔ Face/Eye-Detection AF**

- Eye detection is not available in movie mode.
  - Eye and face detection may not perform as expected if:
    - the subject's face occupies a very large or very small proportion of the frame,
    - the subject's face is lit too brightly or too poorly,
    - the subject is wearing glasses or sunglasses,
    - the subject's face or eyes are obscured by hair or other objects, or
    - the subject moves excessively during shooting.
-

## ■ Focusing on the Faces or Eyes of Animals (Animal Face/Eye-Detection AF)

If [Animal detection on] is selected for Custom Setting a4 [Auto-area AF face/eye detection], the camera will detect the faces and eyes of dogs and cats (animal face/eye-detection).

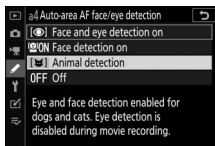

- When the camera detects a dog or cat, a yellow border indicating the focus point will appear around the subject's face. If the camera detects the subject's eyes, the yellow focus point will instead appear over one or the other of their eyes.
- If **AF-C** is selected for focus mode, the focus point will light yellow when faces or eyes are detected.
- While if **AF-S** is selected, the focus point will turn green when the camera focuses.
- If more than one animal or more than one eye is detected, ◀ and ▶ icons will appear on the focus point. You will be able to position the focus point over a different face or eye by pressing ⏪ or ⏩.
- During playback, you can zoom in on the face or eye used for focus by pressing OK.



---

## ✔ **Animal Detection AF**

- Animal eye-detection is not available in movie mode.
  - Animal face- and eye-detection may not perform as expected if:
    - the subject's face occupies a very large or very small proportion of the frame,
    - the subject's face is lit too brightly or too poorly,
    - the subject's face or eyes are obscured by fur or other objects,
    - the subject's eyes are similar in color to the rest of their face, or
    - the subject moves excessively during shooting.
  - Depending on shooting conditions, the camera may fail to detect the faces or eyes of some breeds when [**Animal detection on**] is enabled. Alternatively, the camera may display a border around subjects that are not the faces or eyes of dogs or cats.
  - The light from the AF-assist illuminator may adversely affect the eyes of some animals; we recommend that you select [**Off**] for Custom Setting a12 [**Built-in AF-assist illuminator**].
-

## ■ Subject-Tracking AF

When [**Auto-area AF**] is selected for AF-area mode, the camera can track the subject in the selected focus point.

- Press **OK** to enable focus tracking; the focus point will change to a targeting reticle.



- Position the reticle over the target and press the **AF-ON** button or press **OK** again to start tracking; the focus point will track the selected subject as it moves through the frame. To end tracking and select the center focus point, press **OK** again. In photo mode, if subject tracking was initiated in focus mode **AF-C** by pressing the shutter-release button halfway or by pressing the **AF-ON** button, the camera will track the subject only while the button is pressed; releasing the button ends tracking and restores the focus point selected before tracking started.
- To exit subject-tracking mode, press the **Q** (?) button.

---

## ✔ Subject Tracking

The camera may be unable to track subjects if they:

- are similar in color or brightness to the background,
  - change visibly in size, color, or brightness,
  - are too large or too small,
  - are too dark or too bright,
  - move quickly, or
  - leave the frame or are obscured by other objects.
-

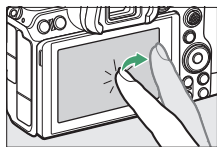

## The Touch Shutter

Touch the display to focus on the selected point. The shutter will be released when you lift your finger from the display.



Tap the icon shown in the illustration to choose the operation performed by tapping the display.



Option	Description
	<ul style="list-style-type: none"><li>• Touch the display to focus on the selected point and lift your finger to release the shutter. If an option other than <b>[Off]</b> is selected for Custom Setting a4 <b>[Auto-area AF face/eye detection]</b> and the camera detects human faces or eyes or the faces or eyes of dogs or cats, the camera will focus on the face or eye * closest to the selected point.</li><li>• Available only in photo mode.</li></ul>
	<ul style="list-style-type: none"><li>• Touch the display to focus on the selected point. Lifting your finger from the display does not release the shutter.</li><li>• If auto-area AF is selected for AF-area mode, the camera will track the selected subject as it moves through the frame. To switch to a different subject, tap it in the display. If an option other than <b>[Off]</b> is selected for Custom Setting a4 <b>[Auto-area AF face/eye detection]</b> and the camera detects human faces or eyes or the faces or eyes of dogs or cats, the camera will focus on and track the face or eye * closest to the selected point.</li></ul>
	Touch shutter disabled.

Option	Description
	<ul style="list-style-type: none"> <li>• Touch the display to position the focus point. The camera will not focus and lifting your finger from the display will not release the shutter.</li> <li>• If auto-area AF is selected for AF-area mode, the camera will track the selected subject as it moves through the frame. To switch to a different subject, tap it in the display. If an option other than <b>[Off]</b> is selected for Custom Setting a4 <b>[Auto-area AF face/eye detection]</b> and the camera detects human faces or eyes or the faces or eyes of dogs or cats, the camera will track the face or eye * closest to the selected point.</li> </ul>

\* When choosing an eye using touch controls, note that the camera may not focus on the eye on the side you intend. Use the multi selector to choose the desired eye.

### Taking Pictures Using Touch Shooting Options

- Touch controls cannot be used for manual focus.
- The shutter-release button can be used to take pictures when the  icon is displayed.
- Touch controls cannot be used to take photographs during movie recording.
- During burst photography, touch controls can be used only to take one picture at a time. Use the shutter-release button for burst photography.
- In self-timer mode, focus locks on the selected subject when you touch the monitor and the shutter is released about 10 seconds after you lift your finger from the display. If the number of shots selected is greater than 1, the remaining shots will be taken in a single burst.

## **Manual Focus**

Manual focus is available in manual focus mode. Use manual focus when, for example, autofocus does not produce the desired results.

- Position the focus point over your subject and rotate the focus or control ring until the subject is in focus.

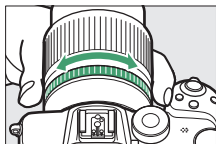

- For greater precision, press the  button to zoom in on the view through the lens.

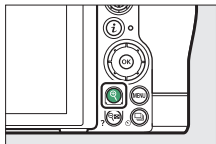



- The focus indicator (●) in the shooting display can be used to confirm whether the subject in the selected focus point is in focus (electronic rangefinding). The focus point will also light green when the subject is in focus.

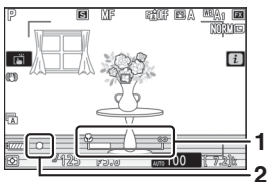

- 1 Focus distance indicator
- 2 Focus indicator

Focus indicator	Description
● (steady)	The subject is in focus.
▶ (steady)	The focus point is in front of the subject.
◀ (steady)	The focus point is behind the subject.
▶ ◀ (flashes)	The camera is unable to focus.

- When using manual focus with subjects not suited to autofocus, note that the in-focus indicator (●) may be displayed when the subject is not in focus. Zoom in on the view through the lens and check focus. Use of a tripod is recommended when the camera is having trouble focusing.

---

## ✔ Lenses with Focus-Mode Selection

Manual focus mode can be chosen using focus-mode selection controls on the lens (where available).

## ✔ The Focal Plane Mark and Flange-Back Distance

Focus distance is measured from the focal plane mark (☉) on the camera body, which shows the position of the focal plane inside the camera (①). Use this mark when measuring the distance to your subject for manual focus or macro photography. The distance between the focal plane and the lens mounting flange is known as the “flange-back distance” (②). On this camera, the flange-back distance is 16 mm (0.63 in.).

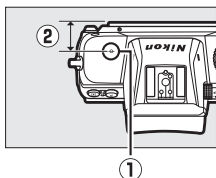

---

## ✔ Peaking Highlights (Focus Peaking)

- If an option other than [Off] is selected for Custom Setting d9 [Peaking highlights], objects that are in focus will be indicated by colored outlines that appear when focus is adjusted manually (focus peaking).
- Note that peaking highlights may not be displayed if the camera is unable to detect outlines. Check focus in the shooting display.

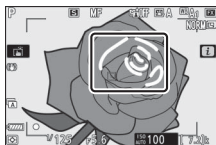

# White Balance

White balance ensures that white objects appear white, regardless of the color of the light source. The default setting (auto white balance, or **WB A1**) is recommended with most light sources; if the desired results cannot be achieved with auto white balance, choose another option as described below.

## Adjusting White Balance

- White balance can be selected using the [**White balance**] items in the **i** menu and the photo and movie shooting menus (📖 129, 239, 337).

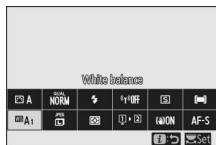

- At default settings, white balance can also be selected by holding the **Fn1** button and rotating the main command dial (📖 31).

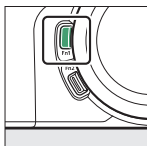

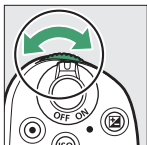
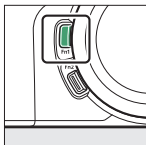

- When **WB A [Auto]** or **[Fluorescent]** is selected, you can choose a sub-option by holding the **Fn1** button and rotating the sub-command dial.



Option	Color temperature *	Description
<b>WB A [Auto]</b>		White balance is adjusted automatically for optimal results with most light sources. If an optional flash unit is used, white balance will be adjusted in accord with the conditions in effect when the flash fires.
<b>WB A<sub>0</sub> [Keep white (reduce warm colors)]</b>	Approx. 3500–8000 K	Eliminate the warm color cast produced by incandescent lighting.
<b>WB A<sub>1</sub> [Keep overall atmosphere]</b>	Approx. 3500–8000 K	Partially preserve the warm color cast produced by incandescent lighting.
<b>WB A<sub>2</sub> [Keep warm lighting colors]</b>	Approx. 3500–8000 K	Preserve the warm color cast produced by incandescent lighting.



Option	Color temperature*	Description
☀️ <b>A [Natural light auto]</b>	Approx. 4500–8000 K	When used under natural light in place of <b>☀️ A [Auto]</b> , this option produces colors closer to those seen by the naked eye.
☀️ <b>[Direct sunlight]</b>	Approx. 5200 K	Use with subjects lit by direct sunlight.
☁️ <b>[Cloudy]</b>	Approx. 6000 K	Use in daylight under overcast skies.
🏠 <b>[Shade]</b>	Approx. 8000 K	Use in daylight with subjects in shade.
💡 <b>[Incandescent]</b>	Approx. 3000 K	Use under incandescent lighting.
💡 <b>[Fluorescent]</b>		Use under fluorescent lighting; choose the bulb type according to the light source.
💡 <b>[Sodium-vapor lamps]</b>	Approx. 2700 K	
💡 <b>[Warm-white fluorescent]</b>	Approx. 3000 K	
💡 <b>[White fluorescent]</b>	Approx. 3700 K	
💡 <b>[Cool-white fluorescent]</b>	Approx. 4200 K	
💡 <b>[Day white fluorescent]</b>	Approx. 5000 K	
💡 <b>[Daylight fluorescent]</b>	Approx. 6500 K	
💡 <b>[High temp. mercury-vapor]</b>	Approx. 7200 K	

Option	Color temperature *	Description
WB  [Flash]	Approx. 5400 K	Use for flash photography.
 [Choose color temperature]	Approx. 2500–10000 K	<ul style="list-style-type: none"> <li>• Choose the color temperature directly.</li> <li>• To choose a color temperature, hold the <b>Fn1</b> button and rotate the sub-command dial.</li> </ul>
PRE [Preset manual]		<ul style="list-style-type: none"> <li>• Measure white balance for the subject or light source or copy white balance from an existing photograph.</li> <li>• To choose a white balance preset, hold the <b>Fn1</b> button and rotate the sub-command dial.</li> <li>• To enter direct measurement mode, press and hold the <b>Fn1</b> button ( 132).</li> </ul>



\* Values when fine-tuning is set to 0.

---



### ✔ **A [Natural Light Auto]**

 **A [Natural light auto]** may not produce the desired results under artificial light. Choose  **A [Auto]** or an option that matches the light source.

### ✔ **White Balance Fine-Tuning**

At settings other than  **[Choose color temperature]**, white balance can be fine-tuned. Use the **[White balance]** items in the **i** menu and the photo and movie shooting menus ( 130, 239).

### ✔ **Studio Flash Lighting**

 **A [Auto]** may not produce the desired results with large studio flash units. Use preset manual white balance or set white balance to   **[Flash]** and use fine-tuning to adjust white balance.

---

## ✔ WB A [Auto]

- The photo info for pictures shot using **WB A** [Auto] lists the color temperature selected by the camera at the time the picture was taken. You can use this as reference when choosing a value for **K** [Choose color temperature].

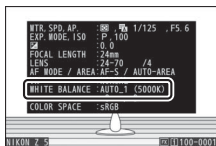

- To view shooting data during playback, select **[Playback display options]** > **[Additional photo info]** in the playback menu and place a check () next to **[Shooting data]**.

## ✔ Color Temperature

The perceived color of a light source varies with the viewer; some may have a red cast while others appear blue. Color temperature is an objective measure of the color of a light source, expressed in Kelvins (K). The lower the color temperature, the redder the cast (①); the higher the temperature, the bluer the cast (②).

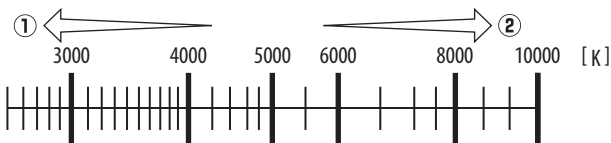

## ✔ Choosing a Color Temperature

In general, choose lower values if your pictures have a red cast or to intentionally make pictures bluer, higher values if your pictures are tinged blue or to intentionally make pictures redder.



## Silent Photography

To enable the electronic shutter and eliminate the noise and vibration caused by operation of the mechanical shutter, select **[On]** for **[Silent photography]** in the photo shooting menu.

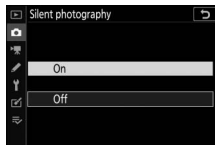

- An icon is displayed while silent photography is in effect.
- Note that the electronic shutter will be used regardless of the option selected for Custom Setting d5 **[Shutter type]**.
- The display will briefly go dark when the shutter is released. This signals that a photo has been taken.
- Regardless of the setting chosen for **[Beep options]** in the setup menu, no beep will sound when the camera focuses or while the self-timer is counting down.
- Enabling silent photography disables some features, including:
  - the flash,
  - long exposure noise reduction,
  - flicker reduction, and
  - high ISO sensitivities (Hi 0.3–Hi 1.0).



---

## ✔ Silent Photography

- Selecting **[On]** for **[Silent photography]** does not completely silence the camera. Camera sounds may still be audible, for example during autofocus or aperture adjustment, in the latter case most noticeably at apertures smaller (i.e., at f-numbers higher) than f/5.6.
  - You may notice the following in photographs and in the shooting display:
    - Flicker or banding in scenes lit by such sources as fluorescent, mercury vapor, or sodium lamps
    - Distortion associated with motion (moving subjects may be distorted, or the entire frame may appear distorted if the camera is moved during shooting)
    - Jagged edges, color fringing, *moiré*, and bright spots in the display
    - Bright regions or bands in scenes lit by flashing signs and other intermittent light sources or when the subject is briefly illuminated by a strobe or other bright, momentary light source
  - The frame advance rate for burst photography changes when **[On]** is selected for **[Silent photography]** (□ 113).
  - If an option other than **[Off]** is selected for **[Vibration reduction]** in the photo shooting menu, sounds made by the camera may be audible when the **MENU** or **▶** button is pressed.
  - Silent photography mutes the shutter, but this does not absolve photographers of the need to respect their subjects' privacy and image rights.
-

# Rating Pictures

Selected pictures can be rated or marked as candidates for later deletion. Ratings can also be viewed in NX Studio. Protected pictures cannot be rated.

**1 Press the  button to start playback.**

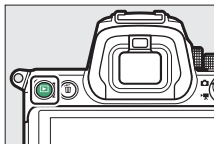

**2 Select the desired picture and press the *i* button.**

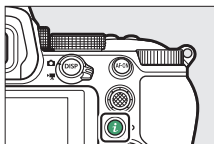

The playback *i* menu will be displayed.

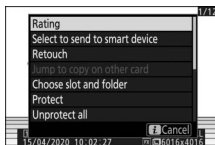

**3 Highlight [Rating] and press .**



## 4 Choose a rating.

- Rotate the main command dial to choose a rating of from zero to five stars, or select  to mark the picture as a candidate for later deletion.
- Press  to select the highlighted option.

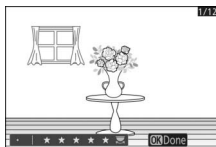

# Protecting Pictures from Deletion

Pictures can be protected to prevent their being deleted accidentally. Protected pictures will however be deleted when the memory card is formatted.

## 1 Press the button to start playback.

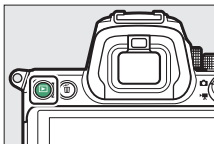

## 2 Select the desired picture and press the button.

The playback  menu will be displayed.

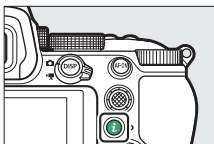

## 3 Highlight [Protect] and press

.

- Protected pictures are marked with a  icon.
- To remove protection, display or highlight the picture and select [Protect] again.

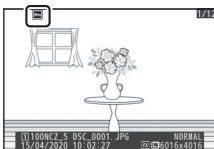

---

### **Removing Protection from All Pictures**

To remove protection from all pictures in the folder or folders currently selected for [Playback folder] in the playback menu, select [**Unprotect all**] in the **i** menu.

---

# Shooting Controls

## The Mode Dial

Use the mode dial to choose whether shutter speed and/or aperture can be adjusted manually or are set automatically by the camera.

### Using the Mode Dial

Use the mode dial to choose a shooting mode.

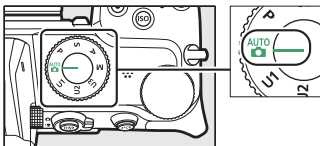

Mode		Description
 <b>AUTO</b>	<b>Auto</b>	A simple, “point-and-shoot” mode that leaves the camera in charge of settings (□48, 53).
<b>P</b>	<b>Programmed auto</b>	The camera sets shutter speed and aperture for optimal exposure.
<b>S</b>	<b>Shutter-priority auto</b>	Use to freeze or blur motion. You choose the shutter speed; the camera selects the aperture for best results.

Mode		Description
<b>A</b>	<b>Aperture-priority auto</b>	Use to blur backgrounds or bring both foreground and background into focus. You choose the aperture; the camera selects the shutter speed for best results.
<b>M</b>	<b>Manual</b>	You control both shutter speed and aperture. Set shutter speed to “bulb” or “time” for long time-exposures.
<b>U1</b> <b>U2</b> <b>U3</b>	<b>User setting mode</b>	Assign frequently-used settings to these positions. The settings can be recalled simply by rotating the mode dial.

## **P (Programmed Auto)**

- In this mode, the camera automatically adjusts shutter speed and aperture according to a built-in program to ensure optimal exposure in most situations.
- Different combinations of shutter speed and aperture that produce the same exposure can be selected by rotating the main command dial (“flexible program”).
  - While flexible program is in effect, a flexible program indicator (\* ) is displayed.
  - To restore default shutter speed and aperture settings, rotate the main command dial until the indicator is no longer displayed. Flexible program also ends when the mode dial is rotated to another setting or the camera is turned off.

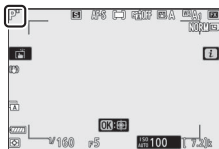



## **S (Shutter-Priority Auto)**

- In shutter-priority auto, you choose the shutter speed while the camera automatically adjusts aperture for optimal exposure. Choose fast shutter speeds to “freeze” motion, slow shutter speeds to suggest motion by blurring moving objects.
- Rotate the main command dial to set the shutter speed.
- Shutter speed can be set to values between  $1/8000$  s and 30 s, or x200.
- Shutter speed can be locked at the selected value (☞ 396).



## A (Aperture-Priority Auto)

- In aperture-priority auto, you choose the aperture while the camera automatically adjusts shutter speed for optimal exposure.
- Aperture can be adjusted by rotating the sub-command dial.
- The minimum and maximum values for aperture vary with the lens.
- Aperture can be locked at the selected value (📖396).



### ✔ Movie Mode Exposure Settings

The following movie shooting settings can be adjusted during filming:

Mode	Aperture	Speed	ISO sensitivity
P, S <sup>1</sup>	—	—	—2
A	✓	—	—2
M	✓	✓	✓3

- 1 Exposure control in shooting mode **S** is the same as in mode **P**.
- 2 The upper limit for ISO sensitivity can be selected using the **[ISO sensitivity settings] > [Maximum sensitivity]** item in the movie shooting menu.
- 3 If **[On]** is selected for **[ISO sensitivity settings] > [Auto ISO control (mode M)]** in the movie shooting menu, the upper limit for ISO sensitivity can be selected using **[Maximum sensitivity]**.

## M (Manual)

- You control both shutter speed and aperture. Choose this mode for long time-exposures of such subjects as fireworks or the night sky (“Bulb” or “Time” photography, [□ 99](#)).
- Shutter speed and aperture can be adjusted with reference to the exposure indicators by rotating the command dials.
- Rotate the main command dial to choose the shutter speed. Shutter speed can be set to values between  $1/8000$  s and 30 s, to “Bulb” or “Time”, or to x200.
- Aperture can be adjusted by rotating the sub-command dial.
- The minimum and maximum values for aperture vary with the lens.
- Shutter speed and aperture can be locked at the selected values ([□ 396](#)).

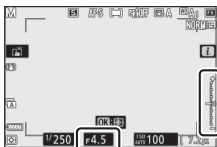
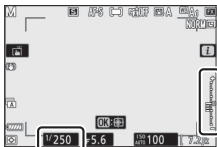

## ✓ Exposure Indicators

The exposure indicators in the monitor and viewfinder show whether the photograph would be under- or over-exposed at current settings. The exposure indicators can be read as follows (the display varies with the option selected for Custom Setting b1 [EV steps for exposure cntrl]):

Display	[1/3 step] selected for [EV steps for exposure cntrl]		
	Optimal exposure	Underexposed by 1/3 EV	Overexposed by over 3 1/3 EV
Monitor			
Viewfinder			

## ✓ Exposure Warning

The displays will flash if the selected settings exceed the limits of the exposure metering system.

## ✓ Auto ISO Sensitivity Control (Mode M)

If auto ISO sensitivity control (□ 107) is enabled, ISO sensitivity will automatically be adjusted for optimal exposure at the selected shutter speed and aperture.

## ■ Long Time-Exposures

The camera offers two options for long time-exposures: “Bulb” and “Time”. Long time-exposures can be used for pictures of fireworks, night scenery, the stars, or moving lights.



A 35-second exposure shot at a shutter speed of “Bulb” and an aperture of f/25

Shutter speed	Description
<b>Bulb</b>	The shutter remains open while the shutter-release button is held down.
<b>Time</b>	The exposure starts when the shutter-release button is pressed and ends when the button is pressed a second time.

**1** Keep the camera steady, for example by using a tripod.

**2** Rotate the mode dial to M.

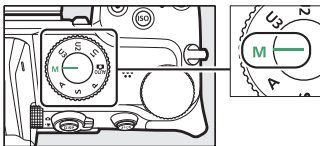

---

### 3 Rotate the main command dial to choose a shutter speed of Bulb (“Bulb”) or Time (“Time”).

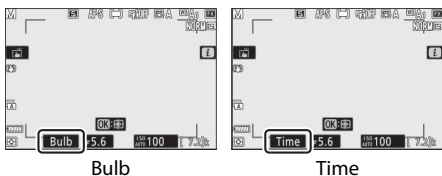

---

### 4 Focus and start the exposure.

- **“Bulb”**: Press the shutter-release button all the way down to start the exposure. Keep the shutter-release button pressed during the exposure.
- **“Time”**: Press the shutter-release button all the way down to start the exposure.

---

### 5 End the exposure.

- **“Bulb”**: Lift your finger from the shutter-release button.
- **“Time”**: Press the shutter-release button all the way down a second time.

---

## ✓ Long Time-Exposures

- Note that “noise” (bright spots, randomly-spaced bright pixels or fog) may be present in long exposures.
  - Bright spots and fog can be reduced by choosing **[On]** for **[Long exposure NR]** in the photo shooting menu.
  - Nikon recommends using a fully-charged battery, an optional charging AC adapter, or an optional AC adapter and power connector to prevent loss of power during long exposures.
  - To prevent blur, use of a tripod or a device such as an optional wireless remote controller is recommended.
-

## U1, U2, and U3 (User Settings Modes)

Frequently-used settings can be assigned to user setting positions **U1** through **U3** and later recalled simply by rotating the mode dial.

### ■ Save User Settings

---

#### 1 Adjust settings.

The settings that can be saved include:

- photo shooting menu options,
- movie shooting menu options,
- Custom Settings, and
- shooting mode, shutter speed (modes **S** and **M**), aperture (modes **A** and **M**), flexible program (mode **P**), exposure compensation, and flash compensation.

#### 2 Highlight [Save user settings] in the setup menu.

Highlight [**Save user settings**] in the setup menu and press .

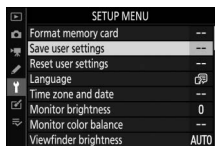



#### 3 Select a position.

Highlight [**Save to U1**], [**Save to U2**], or [**Save to U3**] and press .



---

## 4 Save user settings.

Highlight [**Save settings**] using  or  and press  to assign current settings to the selected position.

---

## 5 Take pictures using the saved settings.

Rotating the mode dial to **U1**, **U2**, or **U3** recalls the settings last saved to that position.

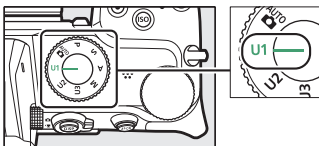

---

### User Settings U1, U2, and U3

The release mode is not saved. In addition, the following settings are not saved.

- PHOTO SHOOTING MENU
    - [**Storage folder**]
    - [**Choose image area**]
    - [**Manage Picture Control**]
    - [**Multiple exposure**]
    - [**Interval timer shooting**]
    - [**Time-lapse movie**]
    - [**Focus shift shooting**]
  - MOVIE SHOOTING MENU
    - [**Choose image area**]
    - [**Manage Picture Control**]
-

## Resetting User Settings

### 1 Highlight [Reset user settings] in the setup menu.

Highlight [**Reset user settings**] in the setup menu and press .

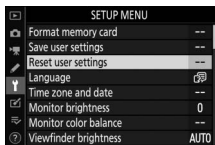

### 2 Select a position.

Highlight [**Reset U1**], [**Reset U2**], or [**Reset U3**] and press .

### 3 Reset user settings.

Highlight [**Reset**] and press  to restore default settings for the selected position (the camera will function in mode **P**).

## The ISO Button

The camera's sensitivity to light (ISO sensitivity) can be adjusted according to the amount of light available. In general, choosing higher values allows faster shutter speeds at the same aperture.

### Adjusting ISO Sensitivity

- Hold the **ISO** button and rotate the main command dial.
- Choose from values of from ISO 100 to 51200. Extended settings of from about 0.3 to 1 EV below ISO 100 and 0.3 to 1 EV above ISO 51200 are also available.
-  offers an ISO AUTO option.
- The option currently selected is shown in the display during shooting.

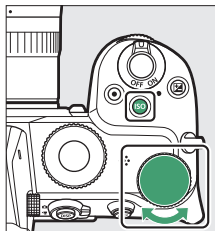

---

### ✓ High ISO Sensitivities

The higher the ISO sensitivity, the less light needed to make an exposure, allowing pictures to be taken when lighting is poor and helping prevent blur when the subject is in motion. Note, however, that the higher the sensitivity, the more likely the image is to be affected by “noise” in the form of randomly-spaced bright pixels, fog, or lines.

### ✓ Hi 0.3–Hi 1.0

A setting of **[Hi 0.3]** corresponds to an ISO sensitivity approximately 0.3 EV higher than ISO 51200 (ISO 64000) and **[Hi 1.0]** to an ISO sensitivity approximately 1 EV higher (ISO 102400). Note that pictures taken at these settings are particularly prone to “noise” in the form of randomly-spaced bright pixels, fog, or lines.

### ✓ Lo 0.3–Lo 1.0

**[Lo 0.3]** corresponds to an ISO sensitivity about 0.3 EV below ISO 100 (equivalent to ISO 80). **[Lo 1.0]** is roughly 1 EV below ISO 100 (ISO 50). Use for larger apertures or slower shutter speeds when lighting is bright. Highlights may be overexposed. In most cases, ISO sensitivities of ISO **[100]** or above are recommended.

---

## **Auto ISO Sensitivity Control**

Auto ISO sensitivity control automatically adjusts ISO sensitivity if optimal exposure cannot be achieved at the value selected by the user in modes **P**, **S**, **A**, and **M**. You can select an upper limit for auto ISO sensitivity control (200–Hi 1.0) to prevent ISO sensitivity being raised too high.

- Hold the **ISO** button and rotate the sub-command dial to select from **ISO AUTO** (auto ISO sensitivity control enabled) and **ISO** (auto ISO sensitivity control disabled).

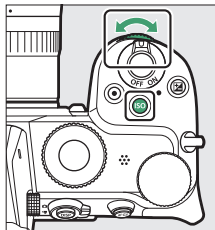

- When auto ISO sensitivity control is enabled, the shooting display will show **ISO AUTO**. When sensitivity is altered from the value selected by the user, the ISO sensitivity will be shown in the displays.

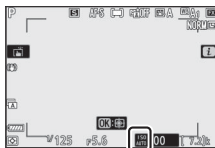

- Maximum sensitivity can be adjusted using the [**ISO sensitivity settings**] item in the photo shooting menu.

---

### ✔ Auto ISO Sensitivity Control

- If value currently selected for [ISO sensitivity settings] is higher than that chosen for [Maximum sensitivity], the value chosen for [ISO sensitivity settings] will serve as the upper limit for auto ISO sensitivity control.
  - During flash photography, shutter speed is limited to the range defined by the values selected for Custom Settings e1 [Flash sync speed] and e2 [Flash shutter speed].
-

## The (Exposure Compensation) Button

Use this button to alter exposure from the value suggested by the camera. Exposure compensation can be used to make pictures brighter or darker.



-1 EV





No exposure  
compensation





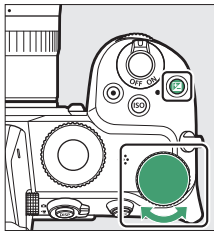

+1 EV

### Adjusting Exposure Compensation

- Hold the  button and rotate the main command dial.
- Choose from values between -5 EV (underexposure) and +5 EV (overexposure). Values between -3 EV and +3 EV are available in movie mode.
- By default, changes are made in increments of  $\frac{1}{3}$  EV. The size of the increments can be changed using Custom Setting b1 [**EV steps for exposure ctrl**] to  $\frac{1}{2}$  EV.
- Higher values make the subject brighter, lower values darker.
- Exposure compensation is not available in  mode.



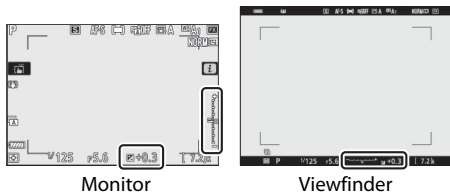

- Normal exposure can be restored by setting exposure compensation to  $\pm 0$ . Exposure compensation is not reset when the camera is turned off.
- At values other than  $\pm 0.0$ , the camera displays a  icon (movie mode) or a  icon and the exposure indicator (photo mode) after you release the  button. The current value for exposure compensation can be confirmed by pressing the  button.



Monitor

Viewfinder

### ✓ Mode M

- In shooting mode **M**, exposure compensation affects only the exposure indicator; shutter speed and aperture do not change.
- The exposure indicator and the current value for exposure compensation can be displayed by pressing the  button.
- When auto ISO sensitivity control ( 107) is in effect, ISO sensitivity is automatically adjusted according to the value selected for exposure compensation.

### ✓ Using a Flash



When an optional flash unit is used, exposure compensation affects both flash level and exposure, altering the brightness of both the main subject and the background. Custom Setting e3 [**Exposure comp. for flash**] can be used to restrict the effects of exposure compensation to the background only.



## The / (Release Mode/Self-Timer) Button

Choose the operation performed when the shutter is released.

### Choosing a Release Mode



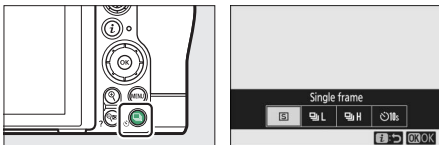

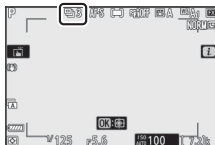

- After pressing the  () button, highlight a release mode using the multi selector and then press  to select the highlighted option.



- The option currently selected is shown in the display during shooting.



## ■ Photo Mode

	Option	Description
	[ <b>Single frame</b> ]	The camera takes one photograph each time the shutter-release button is pressed.
	[ <b>Continuous L</b> ]	<ul style="list-style-type: none"><li>• The camera takes photographs at a selected rate while the shutter-release button is pressed.</li><li>• The frame rate can be chosen by pressing  when [<b>Continuous L</b>] is highlighted in the release-mode menu.</li><li>• Choose from rates of from 1 to 4 fps.</li></ul>
	[ <b>Continuous H</b> ]	The camera takes photos at up to 4.5 fps while the shutter-release button is pressed.
	[ <b>Self-timer</b> ]	Take pictures with the self-timer (  115).

### ✓ The Shooting Display

In continuous low-speed and continuous high-speed modes, the display is updated in real time even while shooting is in progress.

## ✔ Frame Advance Rate

Frame advance rate varies with camera settings.

Release mode	Image quality	NEF (RAW) bit depth	Silent photography	
			Off	On
[Continuous L]	JPEG	—	User-selected frame advance rate	User-selected frame advance rate*
	NEF (RAW)	12 bit		
		14 bit		
[Continuous H]	JPEG	—	Approx. 4.5 fps	Approx. 2.5 fps
	NEF (RAW)	12 bit		
		14 bit		

\* Rate when 3 fps or faster is selected is approximately 2.5 fps.

## ✔ Burst Photography

- Depending on shooting conditions and memory card performance, the memory card access lamp may light for anywhere from a few tens of seconds to around a minute. Do not remove the memory card while the memory card access lamp is lit. Not only could any unrecorded images be lost, but the camera or memory card could be damaged.
- If the camera is switched off while the memory card access lamp is lit, it will not power off until all images in the buffer have been recorded.
- If the battery is exhausted while images remain in the buffer, the shutter release will be disabled and the images transferred to the memory card.

## ✔ The Memory Buffer

- While the shutter-release button is pressed halfway, the frame-count display will show the number of pictures that can be stored in the memory buffer.
- When the buffer is full, the display will show **r00** and the frame rate will drop.
- The number shown is approximate. The actual number of photos that can be stored in the memory buffer varies with camera settings and shooting conditions.





## ■ Movies

In movie mode, you can choose the operation performed when the shutter-release button is pressed (☞ 56).

Option	Description
☐ [Single frame]	The camera takes one photograph each time the shutter-release button is pressed. Up to 40 photographs can be taken with each movie.
☐ [Continuous]	<ul style="list-style-type: none"><li>• The camera takes photos at up to 3 s while the shutter-release button is pressed.</li><li>• The frame rate varies with the option selected for [Frame size/frame rate] in the movie shooting menu.</li><li>• While movie shooting is in progress, only one photo will be taken each time the shutter-release button is pressed.</li></ul>

## The Self-Timer

In self-timer mode, pressing the shutter-release button starts a timer, and a photo is taken when the timer expires.

- 1 Press the  () button, highlight [Self-timer] using the multi selector, and press .**



- 2 Choose the desired shutter-release delay and number of shots using the multi selector.**

Press  to select the highlighted option.

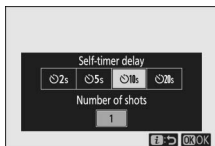

- 3 Frame the photograph and focus.**

The timer will not start if the shutter cannot be released, as may be the case, for example, if the camera is unable to focus when **AF-S** is selected for focus mode.



---

## 4 Start the timer.

- A  icon appears in the shooting display when the self-timer is enabled.
- Press the shutter-release button all the way down to start the timer; the self-timer lamp will begin to flash. The lamp stops flashing two seconds before the timer expires.



---

### ✓ Taking Multiple Shots

The number of shots taken and the interval between shots can be selected using Custom Setting c2 [**Self-timer**].

---

## The Sub-Selector

Use the sub-selector to choose the focus point. The center of the sub-selector can also be used to lock exposure and focus.

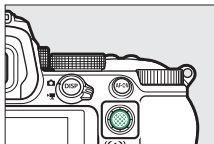

### Focus-Point Selection

The sub-selector can be used to choose the focus point when an option other than auto-area AF is selected for AF-area mode (☐ 66).



### Exposure Lock

- Exposure lock can be used to recompose shots after metering a subject that will not be in the selected focus area in the final composition.
- Exposure lock is particularly effective with spot and center-weighted metering.

### Focus Lock

- Use focus lock to lock focus on the current subject when **AF-C** is selected for focus mode.
- When using focus lock, choose an AF-area mode other than auto-area AF.

## Locking Focus and Exposure

**1** Position the subject in the selected focus point and press the shutter-release button halfway to set focus and exposure.

**2** Press the center of the sub-selector.

- Focus and exposure will lock while pressing the center of the sub-selector. Exposure will not change even when the composition is altered.

- An **AE-L** icon will be displayed in the monitors.

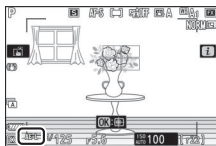
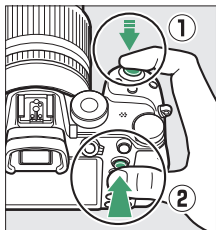



---

### 3 Keeping the center of the sub-selector pressed, recompose the photograph and shoot.



Do not change the distance between the camera and the subject. If the distance to the subject changes, release the lock and focus again at the new distance.

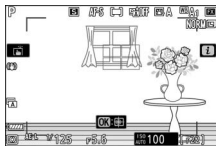

---

#### ✔ Locking Focus When AF-S Is Selected for Focus Mode

Focus locks while the shutter-release button is pressed halfway. You can also lock focus by pressing the center of the sub-selector.

#### ✔ Locking Exposure with the Shutter-Release Button

If **[On (half press)]** is selected for Custom Setting c1 **[Shutter-release button AE-L]**, exposure will lock while the shutter-release button is pressed halfway.

#### ✔ Taking Multiple Shots at the Same Focus Distance

- If you locked focus by pressing the center of the sub-selector, focus will remain locked between shots if you keep the center of the sub-selector pressed.
  - Focus will also remain locked if you keep the shutter-release button pressed halfway between shots.
-

# The *i* Menu

## The *i* Menu

This menu is used for quick access to frequently-used settings. To view the menu, press the *i* button.

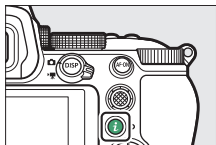

- Highlight items using the multi selector and press **OK** to view options. Highlight the desired option and press **OK** to select and return to the *i* menu.



- To cancel and return to the previous display, press the *i* button.

---

## The Command Dials

- In some cases, the setting for the item currently highlighted in the **i** menu can be chosen by rotating the main command dial. Options for the selected setting, if any, can be selected by rotating the sub-command dial.
- Some items can be adjusted by rotating either dial.
- Press **OK** to save changes. You can also save changes by pressing the shutter-release button halfway or highlighting another item.

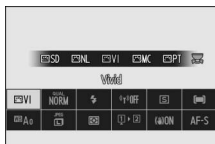



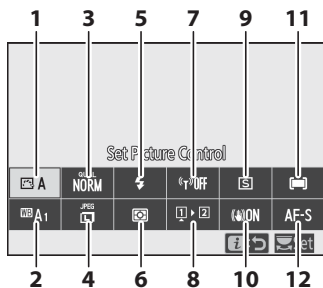





## Still Images





- |          |                             |           |                               |
|----------|-----------------------------|-----------|-------------------------------|
| <b>1</b> | Set Picture Control (☞ 123) | <b>7</b>  | Wi-Fi connection (☞ 141)      |
| <b>2</b> | White balance (☞ 129)       | <b>8</b>  | View memory card info (☞ 141) |
| <b>3</b> | Image quality (☞ 136)       | <b>9</b>  | Release mode (☞ 142)          |
| <b>4</b> | Image size (☞ 138)          | <b>10</b> | Vibration reduction (☞ 143)   |
| <b>5</b> | Flash mode (☞ 139)          | <b>11</b> | AF-area mode (☞ 145)          |
| <b>6</b> | Metering (☞ 140)            | <b>12</b> | Focus mode (☞ 146)            |

## Set Picture Control

Choose image processing (“Picture Control”) options for new photos according to the scene or your creative intent.

	Option	Description
 A	<b>[Auto]</b>	<ul style="list-style-type: none"><li>• The camera automatically adjusts hues and tones based on the <b>[Standard]</b> Picture Control.</li><li>• The complexions of portrait subjects will appear softer than in pictures taken with the <b>[Standard]</b> Picture Control.</li><li>• In outdoor shots, elements such as the foliage and sky will appear more vivid than in pictures taken with the <b>[Standard]</b> Picture Control.</li></ul>
 SD	<b>[Standard]</b>	Standard processing for balanced results. Recommended for most situations.
 NL	<b>[Neutral]</b>	Minimal processing for natural results. Choose for photographs that will later be processed or retouched.
 VI	<b>[Vivid]</b>	Pictures are enhanced for a vivid, photoprint effect. Choose for photographs that emphasize primary colors.
 MC	<b>[Monochrome]</b>	Take monochrome photographs.
 PT	<b>[Portrait]</b>	Smooth complexions for natural-looking portraits.
 LS	<b>[Landscape]</b>	Shoot vibrant landscapes and cityscapes.
 FL	<b>[Flat]</b>	Details are preserved over a wide tone range, from highlights to shadows. Choose for photographs that will later be extensively processed or retouched.

Option	Description
01– 20 [Creative Picture Control] (Creative Picture Control)	<ul style="list-style-type: none"> <li>• Creative Picture Controls offer unique combinations of hue, tone, saturation, and other settings tuned for particular effects.</li> <li>• Choose the type from [Dream], [Morning], [Pop], [Sunday], [Somber], [Dramatic], [Silence], [Bleached], [Melancholic], [Pure], [Denim], [Toy], [Sepia], [Blue], [Red], [Pink], [Charcoal], [Graphite], [Binary], or [Carbon].</li> </ul>

- To view Picture Control settings, highlight a Picture Control and press . Any changes to fine-tuning options can be previewed in the display ( 125).
- The option currently selected is shown in the display during shooting.

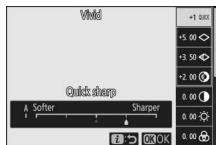

## ■ ■ Modifying Picture Controls

Highlighting [Set Picture Control] in the **i** menu and pressing **OK** displays a Picture Control list. Highlight a Picture Control and press **OK** to preview the effect in the display.

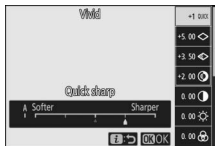

- Press **▲** or **▼** to highlight settings.  
Press **←** or **→** to choose a value in increments of 1, or rotate the sub-command dial to choose a value in increments of 0.25.
- The options available vary with the Picture Control selected.
- To abandon any changes and start over from default settings, press the **🗑️** button.
- Press **OK** to save changes and return to the **i** menu.
- Picture Controls that have been modified from default settings are indicated by an asterisk ("**\***").

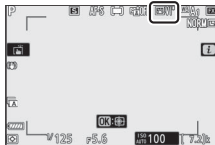

---

### ✓ The $\Delta$ Indicator

The  $\Delta$  indicator under the value display in the Picture Control setting menu indicates the previous value for the setting.



### ✓ [A] (Auto)

- Selecting the **A** (auto) option available for some settings lets the camera adjust the setting automatically.
- Results vary with exposure and the position of the subject in the frame.

---

### ✓ The “ AAuto” Picture Control

Settings can be adjusted in the range [A-2] to [A+2].





## Picture Control Settings

Option	Description
[Effect level]	Mute or heighten the effect of Creative Picture Controls.
[Quick sharp]	Quickly adjust levels for balanced [Sharpening], [Mid-range sharpening], and [Clarity]. These parameters can also be adjusted individually.
[Sharpening]	Control the sharpness of details and outlines.
[Mid-range sharpening]	Adjust the sharpness of patterns and lines in the range between [Sharpening] and [Clarity].
[Clarity]	Adjust overall sharpness and the sharpness of thicker outlines without affecting brightness or dynamic range.
[Contrast]	Adjust contrast.
[Brightness]	Raise or lower brightness without loss of detail in highlights or shadows.
[Saturation]	Control the vividness of colors.
[Hue]	Adjust hue.
[Filter effects]	Simulate the effect of color filters on monochrome pictures.
[Toning]	Choose the tint used in monochrome pictures. Pressing  when an option other than [B&W] (black-and-white) is selected displays saturation options.
[Toning] (Creative Picture Control)	Choose the shade of color used for Creative Picture Controls.

---

## ✓ [Filter Effects]

Choose from the following [Filter effects]:

Option	Description
[Y] (yellow) *	These options enhance contrast and can be used to tone down the brightness of the sky in landscape photographs. Orange [O] produces more contrast than yellow [Y], red [R] more contrast than orange.
[O] (orange) *	
[R] (red) *	
[G] (green) *	Green softens skin tones. Use for portraits and the like.

\* The term in parentheses is the name of the corresponding third-party color filter for black-and-white photography.

---

## White Balance

Adjust white balance. For more information, see “Basic Settings” under “White Balance” (□□81).

Option
<b>WB A [Auto]</b>
<b>WB A<sub>0</sub> [Keep white (reduce warm colors)]</b>
<b>WB A<sub>1</sub> [Keep overall atmosphere]</b>
<b>WB A<sub>2</sub> [Keep warm lighting colors]</b>
<b>☀️ A [Natural light auto]</b>
<b>☀️ [Direct sunlight]</b>
<b>☁️ [Cloudy]</b>
<b>🏠 [Shade]</b>
<b>💡 [Incandescent]</b>

Option
<b>☀️ [Fluorescent]</b>
<b>[Sodium-vapor lamps]</b>
<b>[Warm-white fluorescent]</b>
<b>[White fluorescent]</b>
<b>[Cool-white fluorescent]</b>
<b>[Day white fluorescent]</b>
<b>[Daylight fluorescent]</b>
<b>[High temp. mercury-vapor]</b>
<b>WB ⚡️ [Flash]</b>
<b>☑️ [Choose color temperature]</b>
<b>PRE [Preset manual]</b>

- Pressing  when **WB A [Auto]** or **☀️ [Fluorescent]** is highlighted displays sub-options for the highlighted item.
- The option currently selected is shown in the display during shooting.



## ■ Fine-Tuning White Balance

Pressing **OK** when **[White balance]** is highlighted in the **i** menu displays a list of white balance options. If an option other than **[Choose color temperature]** is highlighted, fine-tuning options can be displayed by pressing **OK**. Any changes to fine-tuning options can be previewed in the display.

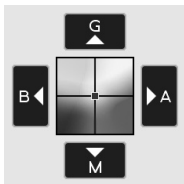
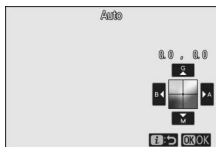

<b>G</b>	Increase green
<b>B</b>	Increase blue
<b>A</b>	Increase amber
<b>M</b>	Increase magenta

- Tap the arrows in the display or use the multi selector to fine-tune white balance.
- Press **OK** to save changes and return to the **i** menu.
- If white balance has been fine-tuned, an asterisk ("\*") will be displayed in the white balance icon.



## ■ Choosing a Color Temperature

Pressing **OK** when [**White balance**] is highlighted in the **i** menu displays a list of white balance options. When **[Choose color temperature]** is highlighted, color temperature options can be viewed by pressing **◀▶**.

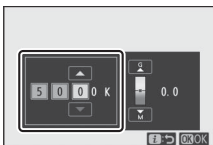

Value for **Amber-Blue**  
axis

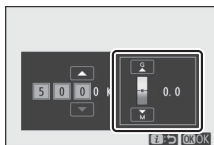

Value for **Green-  
Magenta** axis

- Press **◀** or **▶** to highlight digits on the A-B (amber-blue) axis. You can also highlight the G-M (green-magenta) axis.
- Press **▲** or **▼** to edit the selected item.
- Press **OK** to save changes and return to the **i** menu.
- If a value other than 0 is selected for the green (G)-magenta (M) axis, an asterisk (“\*”) will appear in the white balance icon.

---

### ✔ Color-Temperature Selection

- Do not use color-temperature selection with fluorescent light sources; instead, use the **[Fluorescent]** option.
  - When using color-temperature selection with other light sources, take a test shot to determine if the selected value is appropriate.
-

## ■ Preset Manual

White balance settings such as **WB A [Auto]**, **[Incandescent]**, and **[Choose color temperature]** may fail to produce the desired results under mixed lighting or lighting with a strong color cast. Should this occur, white balance can be set to a value measured under the light source used in the final photograph. The camera can store up to six values for preset manual white balance.

### 1 Select [White balance] in the *i* menu, then highlight PRE [Preset manual] and press



### 2 Select a preset.

- Select from presets [d-1] through [d-6].
- Press **OK** to save changes and return to the *i* menus.



### 3 Highlight [White balance] in the *i* menu and hold the button to initiate direct measurement mode.

- A **PRE** indicator will flash in the shooting display.
- The white balance target () appears in the center of the frame.

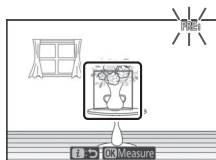
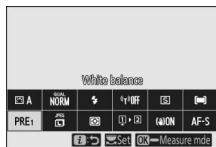

---

## 4 Position the white balance target (□) over a white or gray object and measure a value for preset manual white balance.

- Position the target (□) using the multi selector.
- To measure white balance, press the shutter-release button all the way down or press **OK**.
- You can also position the target and measure white balance by tapping the display.
- Target selection will not be available if an optional flash unit is attached. Frame the shot so that the white or gray reference object is in the center of the display.

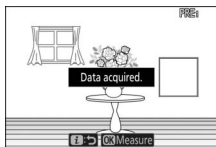

- If the camera is unable to measure white balance, a message will be displayed and the camera will return to direct measurement mode. Try measuring white balance again, for example with the target (□) positioned over a different area of the subject.

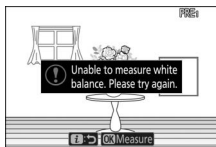

---

## 5 Press the **i** button to exit direct measurement mode.



---

## ✔ The Preset Manual White Balance Menu

The preset manual white balance menu can be accessed by selecting **[White balance] > PRE [Preset manual]** in the photo shooting menu. The preset manual white balance menu offers options for copying values for preset manual white balance from an existing photograph or adding comments to or protecting white balance presets.

## ✔ Protected Presets

White balance presets indicated by **On** icons are protected and cannot be changed.

## ✔ Preset Manual: Selecting a Preset

- At shipment, presets d-1 through d-6 are set to 5200 K, equivalent to the **☀ [Direct sunlight]** white balance option.
- White balance presets can be viewed by selecting **[White balance] > PRE [Preset manual]** in the photo shooting menu. To recall a stored value, highlight a preset using the multi selector and press **OK**.



## ✔ Direct Measurement Mode

Direct measurement mode will end if no operations are performed in the time selected for Custom Setting c3 **[Power off delay] > [Standby timer]**.

## ✔ Measuring White Balance

Preset manual white balance cannot be measured during multiple exposures.

---

## Image Quality

Choose a file format for photographs.

Option	Description
[NEF (RAW) + JPEG fine★]	<ul style="list-style-type: none"><li>Record two copies of each photo: an NEF (RAW) image and a JPEG copy.</li><li>For the JPEG copy, you can choose from options prioritizing image quality or file size. Choose options with a star ("★") to maximize image quality. Choose options without a star ("★") to ensure that the JPEG copies all have more or less the same file size.</li><li>Only the JPEG copy is displayed during playback. The NEF (RAW) copies can only be viewed using a computer.</li><li>Deleting the JPEG copies on the camera also deletes the NEF (RAW) images.</li></ul>
[NEF (RAW) + JPEG fine]	
[NEF (RAW) + JPEG normal★]	
[NEF (RAW) + JPEG normal]	
[NEF (RAW) + JPEG basic★]	
[NEF (RAW) + JPEG basic]	
[NEF (RAW)]	
[JPEG fine★]	
[JPEG fine]	
[JPEG normal★]	
[JPEG normal]	
[JPEG basic★]	
[JPEG basic]	

The option currently selected is shown in the display during shooting.

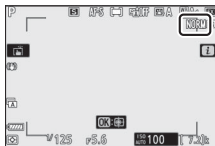

---

## **NEF (RAW)**

- NEF (RAW) files have the extension “\*.nef”.
- The process of converting NEF (RAW) pictures to other highly-portable formats such as JPEG is referred to as “NEF (RAW) processing”. During this process, Picture Controls and settings such as exposure compensation and white balance can be freely adjusted.
- The RAW data themselves are unaffected by NEF (RAW) processing and their quality will remain intact even if the pictures are processed multiple times at different settings.
- NEF (RAW) processing can be performed in-camera using the **[NEF (RAW) processing]** item in the retouch menu or on a computer using Nikon’s NX Studio software. NX Studio is available free-of-charge from the Nikon Download Center.

## **“NEF (RAW) + JPEG”**

- The camera displays only the JPEG copies of photos recorded at image quality settings of “NEF (RAW) + JPEG”. If only one memory card was inserted in the camera when the photos were recorded, the NEF (RAW) copies can only be viewed using a computer.
  - In the case of photos recorded with only one memory card inserted, deleting the JPEG copies on the camera also deletes the NEF (RAW) images.
  - If **[RAW Slot 1 - JPEG Slot 2]** is selected for **[Role played by card in Slot 2]**, the NEF (RAW) copies will be recorded to the card in Slot 1 and the JPEG copies to the card in Slot 2 (□□232).
-

## Image Size

Choose the size at which photographs are recorded. The option currently selected is shown in the display during shooting.

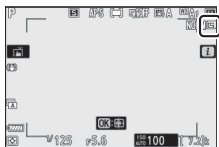

### ■ Image Size Versus Number of Pixels

The physical dimensions of the photos in pixels vary with the option selected for [**Choose image area**] in the photo shooting menu.

Image area	Image size		
	Large	Medium	Small
[FX (36×24)]	6016 × 4016	4512 × 3008	3008 × 2008
[DX (24×16)]	3936 × 2624	2944 × 1968	1968 × 1312
[1:1 (24×24)]	4016 × 4016	3008 × 3008	2000 × 2000
[16:9 (36×20)]	6016 × 3384	4512 × 2536	3008 × 1688

## Flash Mode

Choose a flash mode for optional flash units. The options available vary with the shooting mode.





Option	Available in
⚡ [Fill flash]	AUTO, P, S, A, M
⚡👁 [Red-eye reduction]	AUTO, P, S, A, M
⚡ SLOW [Slow sync]	P, A
⚡👁 SLOW [Slow sync + red-eye]	P, A
⚡ REAR [Rear-curtain sync]	P, S, A, M
🔌 [Flash off]	AUTO, P, S, A, M

The option currently selected is shown in the display during shooting.



## Metering

Metering determines how the camera sets exposure.

	Option	Description
	<b>[Matrix metering]</b>	The camera meters a wide area of the frame and sets exposure according to tone distribution, color, composition, and distance for results close to those seen by the naked eye.
	<b>[Center-weighted metering]</b>	<ul style="list-style-type: none"><li>• The camera assigns the greatest weight to the center of the frame. It can be used with subjects that dominate the composition, for example.</li><li>• Center-weighted metering is also recommended when using filters with an exposure factor (filter factor) over 1x.</li><li>• The size of the area assigned the greatest weight can be selected using Custom Setting b3 <b>[Center-weighted area]</b>.</li></ul>
	<b>[Spot metering]</b>	<ul style="list-style-type: none"><li>• The camera meters a circle with a diameter of 4 mm/0.16 in. (equivalent to approximately 1.5% of the frame). This ensures that the subject will be correctly exposed even when the background is much brighter or darker.</li><li>• The metered area is centered on the current focus point. If auto-area AF (□□66) is in effect, the camera will instead meter the center focus point.</li></ul>
	<b>[Highlight-weighted metering]</b>	The camera assigns the greatest weight to highlights. Use this option to reduce loss of detail in highlights, for example when photographing spotlight performers on stage.

The option currently selected is shown in the display during shooting.

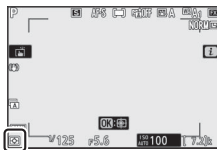

## **Wi-Fi Connection**

Enable or disable Wi-Fi.

- Enable Wi-Fi to establish wireless connections to computers or between the camera and smartphones or tablets (smart devices) running the SnapBridge app (□525).
- The camera displays a Wi-Fi icon when Wi-Fi is enabled.

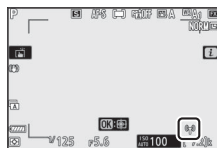

- To turn Wi-Fi off, highlight [**Wi-Fi connection**] in the **i** menu and press **OK**; if Wi-Fi is currently enabled, a [**Close Wi-Fi connection**] prompt will be displayed. Press **OK** to end the connection.





## **View Memory Card Info**



View the slot currently selected as the destination for new pictures and the role played by the card in Slot 2 when two memory cards are inserted. This option can be used to view but not to change the option selected.

- The role played by the card in Slot 2 can be selected using [**Role played by card in Slot 2**] in the photo shooting menu.

## Release Mode

Choose the operation performed when the shutter is released. For more information, see “The /☺ (Release Mode/Self-Timer) Button” (111).

Option		Option	
	[Single frame]	 H	[Continuous H]
 L	[Continuous L]		[Self-timer]

- Pressing  when [Continuous L] is highlighted displays frame advance rate options.
- Pressing  when [Self-timer] is highlighted displays options for the shutter-release delay and the number of shots taken when the timer expires.
- The option currently selected is shown in the display during shooting.

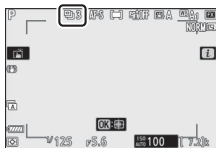
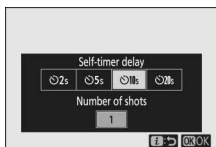



## Vibration Reduction

Choose whether to enable vibration reduction. The options available vary with the lens.

Option	Description
[ON]	Choose for enhanced vibration reduction when photographing static subjects.
[SPT]	Choose when photographing athletes and other subjects that are moving rapidly and unpredictably.
[OFF]	Vibration reduction is disabled.

Options other than **[Off]** are shown by an icon in the display during shooting.









---

## ✔ Using Vibration Reduction: Notes

- Vibration reduction may be unavailable with some lenses.
  - We recommend that you wait for the image in the display to stabilize before shooting.
  - Depending on the lens, when vibration reduction is active, the image in the viewfinder may jiggle after the shutter is released, but this does not indicate a malfunction.
  - **[Sport]** or **[On]** is recommended for panning shots. In **[Sport]**, **[Normal]**, and **[On]** modes, vibration reduction applies only to motion that is not part of the pan. If the camera is panned horizontally, for example, vibration reduction will be applied only to vertical shake.
  - To prevent unintended results, select **[Off]** when the camera is mounted on a tripod. Note that settings for VR lenses may differ; consult the lens manual for more information. Note, however, that **[Normal]**, **[Sport]**, or **[On]** is recommended if the tripod head is unsecured or the camera is mounted on a monopod.
-

## **AF-Area Mode**

AF-area mode controls how the camera selects the focus-point for autofocus. For more information, see “Focus” under “AF-Area Mode” in “Basic Settings” (📖 66).

Option		Option	
	[Pinpoint AF]		[Wide-area AF (S)]
	[Single-point AF]		[Wide-area AF (L)]
	[Dynamic-area AF]		[Auto-area AF]

The option currently selected is shown in the display during shooting.

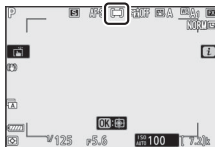

## Focus Mode

Focus mode controls how the camera focuses. For more information, see “Focus” under “Focus Mode” in “Basic Settings” (p.63).

Option	
<b>AF-S</b>	[Single AF]
<b>AF-C</b>	[Continuous AF]
<b>MF</b>	[Manual Focus]

The option currently selected is shown in the display during shooting.

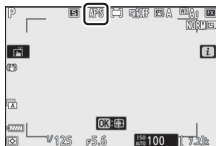

# Movies

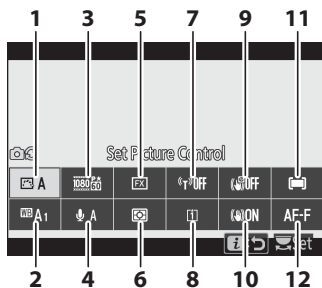

- 1 Set Picture Control (📖 149)
- 2 White balance (📖 149)
- 3 Frame size and rate/image quality (📖 150)
- 4 Microphone sensitivity (📖 152)
- 5 Choose image area (📖 153)

- 6 Metering (📖 155)
- 7 Wi-Fi connection (📖 155)
- 8 Destination (📖 155)
- 9 Electronic VR (📖 156)
- 10 Vibration reduction (📖 156)
- 11 AF-area mode (📖 157)
- 12 Focus mode (📖 157)

---

### ✔ [Same as Photo Settings]

If [Same as photo settings] is selected for [Set Picture Control], [White balance], [Active D-Lighting], or [Vibration reduction] in the movie shooting menu, a  icon will appear at the top left corner of the **i** menu. Changes made to the setting from the **i** menu in photo mode will also apply in movie mode and *vice-versa*.

---



## **Set Picture Control**

Choose a Picture Control for movie recording. For more information, see “Still Images” (📖 123).

## **White Balance**

Adjust white balance for movie recording. For more information, see “Still Images” (📖 129).

## Frame Size and Rate/Image Quality

Select the movie frame size (in pixels), frame rate, and movie quality.

### ■ Movie Quality

Choose from [**High quality**] and [**Normal**]. A star (“★”) appears in the icon for [**Frame size/frame rate**] when [**High quality**] is selected. Some frame size/rate options only support [**High quality**].

### ■ Frame Size/Frame Rate

The maximum bit rate and recording time for each [**Frame size/frame rate**] option are shown below. The bit rate varies with the option selected for movie quality.

Option <sup>1</sup>		Max. bit rate		Max. recording time
		High quality	Normal	
	[3840×2160; 30p] <sup>2</sup>	144 Mbps	— <sup>3</sup>	29 min. 59 s <sup>4</sup>
	[3840×2160; 25p] <sup>2</sup>			
	[3840×2160; 24p] <sup>2</sup>			
	[1920×1080; 60p]	56 Mbps	28 Mbps	
	[1920×1080; 50p]	28 Mbps	14 Mbps	
	[1920×1080; 30p]			
	[1920×1080; 25p]			
	[1920×1080; 24p]			



- 1 The frame rates for 60p, 50p, 30p, 25p, and 24p are respectively 59.94 fps, 50 fps, 29.97 fps, 25 fps, and 23.976 fps.
- 2 Movies are recorded in 4K UHD.
- 3 Movie quality fixed at **[High quality]**.
- 4 Each movie may be recorded across up to 8 files. Each file may be up to 4 GB in size. The number of files and the length of each file vary with the options selected for **[Frame size/frame rate]** and **[Movie quality]**. Movies recorded to memory cards formatted in the camera will however be recorded as a single file regardless of size if the card has a capacity over 32 GB.

The option currently selected for **[Frame size and rate/Image quality]** is shown in the display during shooting.

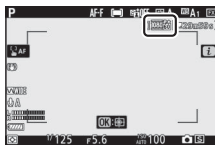

## Microphone Sensitivity

Turn built-in or external microphones on or off or adjust microphone sensitivity.

Option	Description
A	Adjust microphone sensitivity automatically.
[Microphone off]	Turn sound recording off.
1 - 20	Select microphone sensitivity manually. Choose from values of from [1] to [20]. The higher the value, the higher the sensitivity; the lower the value, the lower the sensitivity.

- At settings other than A, the option currently selected is shown in the display.

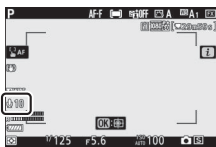

- If the sound level is displayed in red, the volume is too high. Reduce microphone sensitivity.

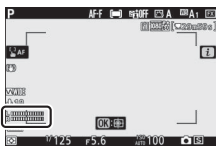

### ✓ Movies Without Sound

Movies recorded with [Microphone off] selected for microphone sensitivity are indicated by a icon.

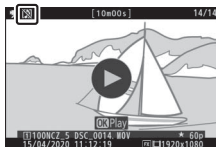

## Choose Image Area

Choose a movie crop from **[FX]** and **[DX]**. Select **[FX]** to shoot movies in what is referred to as “FX-based movie format”, **[DX]** to shoot in “DX-based movie format”. The movie crop is fixed at 1.7x at a frame size of 3840 × 2160. The differences are illustrated below.

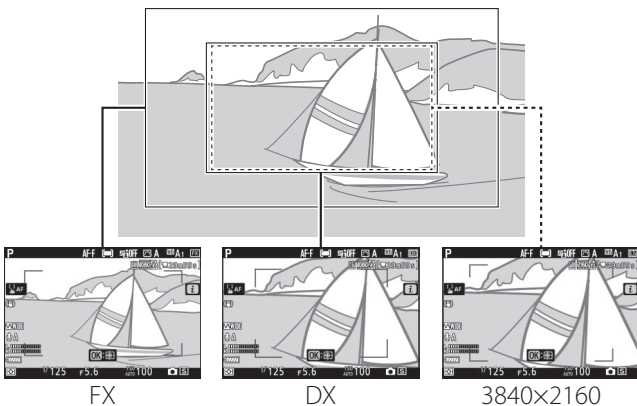

- The sizes of the areas recorded in FX- and DX-based movie formats differ. The differences are shown below.

Image size	Format	Area recorded
3840 × 2160	—*	Approx. 22.4 × 12.6 mm/ 0.9 × 0.5 in.
1920 × 1080	FX	Approx. 35.9 × 20.2 mm/ 1.4 × 0.8 in.
	DX	Approx. 23.5 × 13.2 mm/ 0.9 × 0.5 in.

\* Image area fixed regardless of option chosen for [**Choose image area**].

- The option currently selected (**[FX]**, **[DX]**, or **[L7i]**) is shown in the image area.

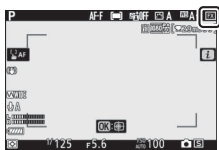

## **Metering**

Choose how the camera sets exposure during movie recording. For more information, see “Still Images” (☞ 140).

---

### **✔ Metering**

[**Spot metering**] is not available in movie mode.

---

## **Wi-Fi Connection**

Enable or disable Wi-Fi. For more information, see “Still Images” (☞ 141) or turn to “Menu Guide” and refer to “Connect to Smart Device” under the heading “Wi-Fi Connection” (☞ 443).

## **Destination**

Choose the slot to which movies are recorded when two memory cards are inserted.

- The menu shows the time available on each card.
- Recording ends automatically when no time remains.

## **Electronic VR**

Choose whether to enable electronic vibration reduction in movie mode.

Option	Description
[On]	<ul style="list-style-type: none"><li>• Enable electronic vibration reduction during movie recording.</li><li>• Electronic vibration reduction is not available at a frame size of 3840 × 2160.</li><li>• Note that when [On] is selected, the angle of view will be reduced, slightly increasing the apparent focal length.</li></ul>
[Off]	Electronic vibration reduction is disabled.

An icon appears in the display when [On] is selected.





## **Vibration Reduction**

Choose whether to enable vibration reduction in movie mode. For more information, see “Still Images” (143).

## **AF-Area Mode**

AF-area mode controls how the camera selects the focus-point for autofocus. For more information, see “Focus” under “AF-Area Mode” in “Basic Settings” (📖 66).

<b>Option</b>		<b>Option</b>	
	[Single-point AF]		[Wide-area AF (L)]
	[Wide-area AF (S)]		[Auto-area AF]

## **Focus Mode**

Focus mode controls how the camera focuses. For more information, see “Focus” under “Focus Mode” in “Basic Settings” (📖 63).

<b>Option</b>		<b>Option</b>	
<b>AF-S</b>	[Single AF]	<b>AF-F</b>	[Full-time AF]
<b>AF-C</b>	[Continuous AF]	<b>MF</b>	[Manual focus]





# Playback

## Viewing Pictures

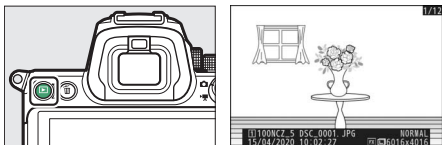
### Full-Frame Playback

Press the  button to view the most recent picture full frame in the display.









- Press  to return to the previous frame,  to skip to the next frame.
- Press , , or the **DISP** button to view more information on the current picture ([162](#)).

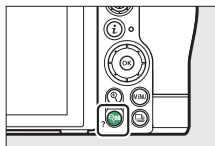

## Thumbnail Playback

To view multiple pictures, press the  (?) button when a picture is displayed full frame.













- The number of pictures displayed increases from 4 to 9 to 72 each time the  (?) button is pressed, and decreases with each press of the  button.
- Highlight pictures using , , , or .

## Calendar Playback

To view images taken on a selected date, press the  (?) button when 72 images are displayed.



- Use the multi selector (, , , or ) to highlight a date in the date list (①) and press  (?) to place the cursor in the thumbnail list (②). Press  or  to highlight pictures in the thumbnail list. To return to the date list, press the  (?) button a second time.
- To zoom in on the picture highlighted in the thumbnail list, press and hold the  button.
- To exit to thumbnail playback, press  when the cursor is in the date list.

---

## ✔ Touch Controls

Touch controls can be used when pictures are displayed in the monitor (☞ 16).

## ✔ Rotate Tall

To display “tall” (portrait-orientation) photographs in tall orientation, select [**On**] for [**Rotate tall**] in the playback menu.





## ✔ Image Review

When [**On**] is selected for [**Image review**] in the playback menu, photographs are automatically displayed after shooting; there is no need for you to press the ▶ button.

- If [**On (monitor only)**] is selected, photos will not be displayed in the viewfinder.
  - In continuous release modes, display begins when shooting ends, with the first photograph in the current series displayed.
  - Images are not rotated automatically during image review even when [**On**] is selected for [**Rotate tall**] in the playback menu.
-

# Photo Information

Photo information is superimposed on images displayed in full-frame playback. Press , , or the **DISP** button to cycle through photo information as shown below.

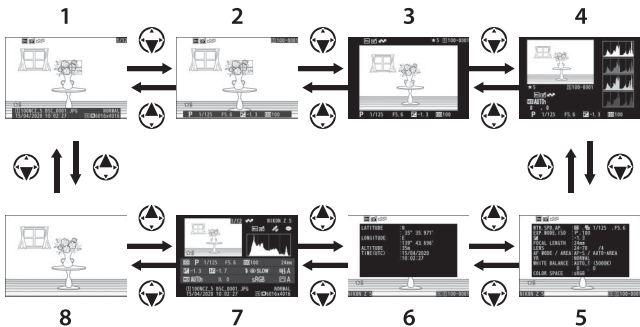

**1** File information

**2** Exposure data <sup>1</sup>

**3** Highlight display <sup>1</sup>



**4** RGB histogram <sup>1</sup>

**5** Shooting data <sup>1,2</sup>

**6** Location data <sup>3</sup>

**7** Overview data <sup>1</sup>

**8** None (image only) <sup>1</sup>

- 1 Displayed only if the corresponding option is selected for [**Playback display options**] in the playback menu.
- 2 The shooting data list has multiple pages, which can be viewed by pressing  or .
- 3 Location data are displayed only if embedded in the picture at the time it was taken.

## File Information

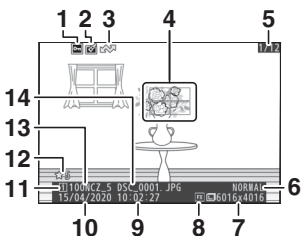

- 1 Protect status (☐91)
- 2 Retouch indicator (☐460)
- 3 Upload marking (☐176)
- 4 Focus point\* (☐48)
- 5 Frame number/total number of frames
- 6 Image quality (☐136)
- 7 Image size (☐138)
- 8 Image area (☐234)
- 9 Time of recording (☐416)
- 10 Date of recording (☐416)
- 11 Current card slot
- 12 Rating (☐89)
- 13 Folder name (☐225)
- 14 File name (☐231)

\* Displayed only if **[Focus point]** is selected for **[Playback display options]** in the playback menu.

## Exposure Data

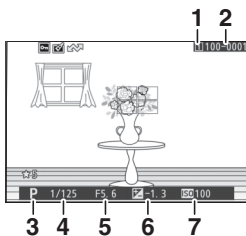

- 1 Current card slot
- 2 Folder number-frame number (☐ 225)
- 3 Shooting mode (☐ 93)
- 4 Shutter speed (☐ 95, 97)
- 5 Aperture (☐ 96, 97)
- 6 Exposure compensation value (☐ 109)
- 7 ISO sensitivity\* (☐ 105)

\* Displayed in red if the picture was taken in mode **P**, **S**, **A**, or **M** with auto ISO sensitivity control enabled.

## Highlight Display

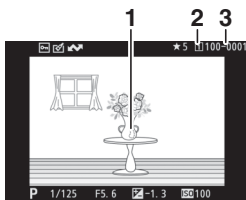

- 1 Highlights (areas that may be overexposed)
- 2 Current card slot
- 3 Folder number-frame number (☐ 225)

## RGB Histogram

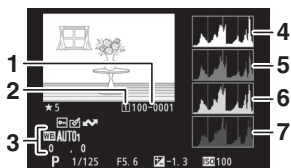

- 1 Folder number–frame number (□ 225)
- 2 Current card slot
- 3 White balance (□ 81, 129, 239)  
Color temperature (□ 131)  
Preset manual (□ 132)  
White balance fine-tuning (□ 130)
- 4 Histogram (RGB channel)
- 5 Histogram (red channel)
- 6 Histogram (green channel)
- 7 Histogram (blue channel)

### ✔ Playback Zoom

To zoom in on the picture in the histogram display, press  $\mathcal{Q}$ . The histogram will be updated to show only the data for the portion of the image visible in the display. Use the multi-selector to scroll to areas of the frame not visible in the monitor. Press  $\mathcal{Q}$  (?) to zoom out.

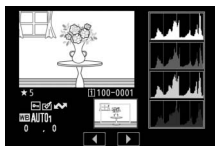

## ✔ Histograms

Histograms show tone distribution. Pixel brightness (tone) is plotted on the horizontal axis and the number of pixels on the vertical axis.

- If the image contains objects with a wide range of brightnesses, the distribution of tones will be relatively even.



- If the image is dark, the distribution will be shifted to the left.



- If the image is bright, the distribution will be shifted to the right.



Increasing exposure compensation shifts the distribution of tones to the right, while decreasing exposure compensation shifts the distribution to the left.



Histograms can provide a rough idea of overall exposure when bright ambient lighting makes it difficult to see pictures in the monitor.

## ✔ The Histogram Display

- RGB histograms show tone distribution.
  - Camera histograms may differ from those displayed in imaging applications. Use them as a guide to actual tone distribution.
-



## Shooting Data

View the settings in effect at the time the picture was taken. The shooting data list has multiple pages, which can be viewed by pressing  or .

### ■ Basic Shooting Data

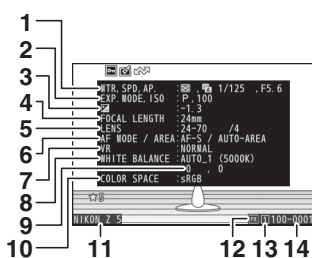

- 1 Metering (☞140)  
Shutter type (☞369)  
Shutter speed (☞95, 97)  
Aperture (☞96, 97)
- 2 Shooting mode (☞93)  
ISO sensitivity<sup>1</sup> (☞105)
- 3 Exposure compensation value (☞109)  
Optimal exposure tuning<sup>2</sup> (☞364)

- 4 Focal length
- 5 Lens data
- 6 Focus mode (☞63)  
AF-area mode (☞66)
- 7 Vibration reduction (☞143)
- 8 White balance<sup>3</sup> (☞81, 129, 239)
- 9 White balance fine-tuning (☞130)
- 10 Color space (☞254)
- 11 Camera name
- 12 Image area (☞234)
- 13 Current card slot
- 14 Folder number–frame number (☞225)

- 1 Displayed in red if the picture was taken in mode **P**, **S**, **A**, or **M** with auto ISO sensitivity control enabled.
- 2 Displayed if Custom Setting b4 [**Fine-tune optimal exposure**] has been set to a value other than zero for any metering method.
- 3 Also includes the color temperature for pictures taken using **WB A** [**Auto**].

## Flash Data

Flash data are displayed only for pictures taken with optional flash units (□561, 579).

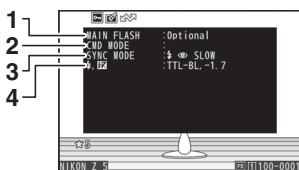

- 1 Flash type
- 2 Remote flash control
- 3 Flash mode (□569)
- 4 Flash control mode (□566)  
Flash compensation (□572)

## Picture Control Data

The items displayed vary with the Picture Control in effect when the picture was taken.

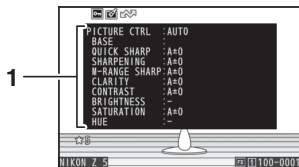

- 1 Picture Control (□123, 247)

## Other Shooting Data

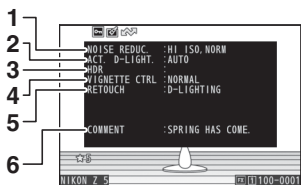

- 1 High ISO noise reduction (☐258)  
Long exposure noise reduction (☐257)
- 2 Active D-Lighting (☐255)
- 3 HDR exposure differential (☐291)  
HDR smoothing (☐291)
- 4 Vignette control (☐259)
- 5 Retouch history (☐460).  
Changes are listed in the order applied.
- 6 Image comment (☐432)

## Copyright Information

Copyright information is only displayed if recorded using the [Copyright information] item in the setup menu at the time the picture was taken.



- 1 Photographer (☐433)
- 2 Copyright holder (☐433)

## Location Data

The location data page lists the latitude, longitude, and other location data downloaded from smartphones, tablets, or optional GPS devices.

- The items listed vary with the device supplying the location data.
- The location data displayed with movies are those reported at the start of recording.

## Overview

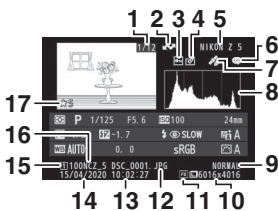

1	Frame number/total number of frames	9	Image quality (☐136)
2	Upload marking (☐176)	10	Image size (☐138)
3	Protect status (☐91)	11	Image area (☐234)
4	Retouch indicator (☐460)	12	File name (☐231)
5	Camera name	13	Time of recording (☐416)
6	Image comment indicator (☐432)	14	Date of recording (☐416)
7	Location data indicator	15	Current card slot
8	Histogram (☐166)	16	Folder name (☐225)
		17	Rating (☐89)

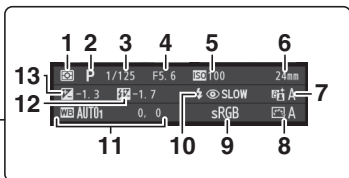
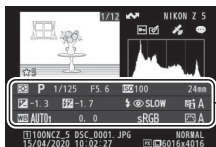

1	Metering (☐ 140)	10	Flash mode <sup>2</sup> (☐ 569)
2	Shooting mode (☐ 93)	11	White balance (☐ 81, 129, 239)
3	Shutter speed (☐ 95, 97)		Color temperature (☐ 131)
4	Aperture (☐ 96, 97)		Preset manual (☐ 132)
5	ISO sensitivity <sup>1</sup> (☐ 105)		White balance fine-tuning (☐ 130)
6	Focal length	12	Flash compensation <sup>2</sup> (☐ 572)
7	Active D-Lighting (☐ 255)		Commander mode <sup>2</sup>
8	Picture Control (☐ 123, 247)	13	Exposure compensation value (☐ 109)
9	Color space (☐ 254)		

- 1 Displayed in red if the picture was taken in mode **P**, **S**, **A**, or **M** with auto ISO sensitivity control enabled.
- 2 Flash data are displayed only for pictures taken with optional flash units (☐ 561, 579).

## The *i* Button (Playback Mode)

Pressing the *i* button during playback zoom or full-frame or thumbnail playback displays the *i* menu for playback mode. Highlight items and press **OK** or **▶** to select.

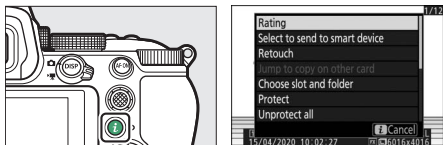



Press the *i* button again to return to playback.

- During calendar playback, the *i* menu can be viewed by pressing the *i* button when thumbnails are displayed.

## Photos

Option	Description
[Quick crop] <sup>1</sup>	Save a copy of the current image cropped to the area visible in the display. This option is not available when RGB histograms are displayed (□ 165).
[Rating]	Rate the current picture (□ 89).
[Select to send to smart device]	Select the current picture for upload (□ 176). The option displayed varies with the type of device connected.
[Select to send to computer]	

Option	Description
<b>[Retouch]</b>	Create a retouched copy of the current picture (□460).
<b>[Jump to copy on other card]</b>	If the current picture is one of a pair created with <b>[Backup]</b> or <b>[RAW Slot 1 - JPEG Slot 2]</b> selected for <b>[Role played by card in Slot 2]</b> , choosing this option displays the copy on the card in the other slot.
<b>[Choose slot and folder]</b>	Choose a slot and folder for playback. Highlight a slot and press  to display a list of the folders on the memory card in the selected slot. You can then highlight a folder and press  to view the pictures it contains.
<b>[Protect]</b>	Add protection to or remove protection from the current picture (□91).
<b>[Unprotect all]</b> <sup>2</sup>	Remove protection from all pictures in the folder currently selected for <b>[Playback folder]</b> in the playback menu.
<b>[Side-by-side comparison]</b> <sup>3</sup>	Compare retouched copies to the originals.

1 Available only during playback zoom.

2 Not available during playback zoom.

3 Available only when a retouched copy (indicated by a ) or the source picture for a retouched copy is selected.







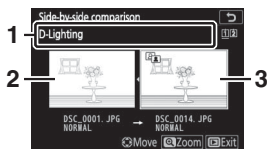

---

## [Side-by-Side Comparison]

Choose [**Side-by-side comparison**] to compare retouched copies with the unretouched originals.





- 1 Options used to create copy
- 2 Source image
- 3 Retouched copy



- The source image is displayed on the left, the retouched copy on the right.
  - The options used to create the copy listed at the top of the display.
  - Press  or  to switch between the source image and the retouched copy.
  - If the copy is an overlay created from multiple source images, press  or  to view the other images.
  - If the source has been copied multiple times, press  or  to view the other copies.
  - To view the highlighted picture full screen, press and hold the  button.
  - Press  to return to playback with the highlighted image displayed full-frame.
  - To exit to playback, press the  button.
  - The source image will not be displayed if the copy was created from a photograph that is now protected.
  - The source image will not be displayed if the copy was created from a photograph that has since been deleted.
-



## Movies

Option	Description
[Rating]	Rate the current picture (□89).
[Select to send to computer]	Select the current picture for upload (□176).
[Volume control]	Adjust playback volume.
[Trim movie]	Trim footage from the current movie and save the edited copy in a new file (□178).
[Choose slot and folder]	Choose a slot and folder for playback. Highlight a slot and press  to display a list of the folders on the memory card in the selected slot. You can then highlight a folder and press  to view the pictures it contains.
[Protect]	Add protection to or remove protection from the current picture (□91).
[Unprotect all]	Remove protection from all pictures in the folder currently selected for [Playback folder] in the playback menu.

## Movies (Playback Paused)

Option	Description
 [Choose start/end point]	Trim footage from the current movie and save the edited copy in a new file (□178).
 [Save current frame]	Save a selected frame as a JPEG still (□182).

## ■ Select to Send

Follow the steps below to select the current picture for upload to a smart device or computer.

- The **i** menu items used to select pictures for upload vary with the type of device connected:
  - [**Select to send to smart device**]: Displayed when the camera is connected to a smart device via built-in Bluetooth using [**Connect to smart device**] in the setup menu (□442).
  - [**Select to send to computer**]: Displayed when the camera is connected to a computer via built-in Wi-Fi using [**Connect to PC**] in the setup menu (□445).
- Movies cannot be selected for upload when the camera is connected to a smart device via the SnapBridge app.
- The maximum file size for movies uploaded by other means is 4 GB.

---

### 1 Select the desired picture and press the **i** button.

## 2 Highlight [Select to send to smart device], or [Select to send to computer] and press



The picture will be marked with a  icon.

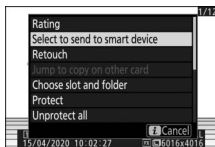

---

### Removing Upload Marking

To remove upload marking, repeat Steps 1 and 2.

---

## ■ Choose Start/End Point

Trim footage from the current movie and save the edited copy in a new file.



### 1 Display a movie full frame.

### 2 Pause the movie on the new opening frame.

- Press the **OK** button to start playback movies. Press **⏸** to pause.
- Your approximate position in the movie can be ascertained from the movie progress bar.

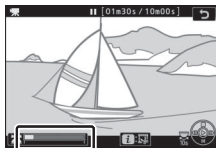

- Press **⏮** or **⏭** or rotate the main command dial to locate the desired frame.

### 3 Select [Choose start/end point].

Press the **i** button, highlight [Choose start/end point], and press **OK**.

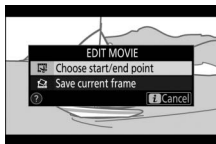

## 4 Choose the start point.

To create a copy that begins from the current frame, highlight **[Start point]** and press **OK**.

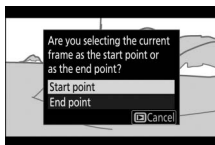

## 5 Confirm the new start point.

- If the desired frame is not currently displayed, press **◀** or **▶** to advance or rewind.
- Rotate the main command dial one stop to skip ahead or back 10 s.
- Rotate the sub-command dial to skip to the last or first frame.

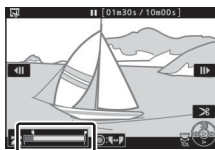

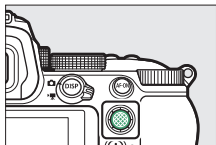

## 6 Choose the end point.

Press the center of the sub-selector to switch to the end-point selection tool (P) and then select the closing frame (P) as described in Step 5.



## 7 Press to create the copy.

## 8 Preview the copy.

- To preview the copy, highlight **[Preview]** and press  (to interrupt the preview and return to the save options menu, press .
- To abandon the current copy and return to Step 5, highlight **[Cancel]** and press .

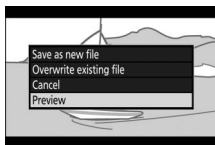

## 9 Choose a save option.

- Choose [**Save as new file**] and press the **OK** button to save the edited copy as a new file.
- To replace the original movie with the edited copy, highlight [**Overwrite existing file**], press **OK**, and then highlight [**Yes**] and press **OK**.

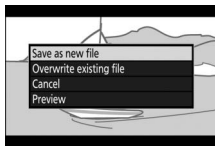

---

### ✓ Trimming Movies

- The copy will not be saved if there is insufficient space available on the memory card.
- Movies less than two seconds long cannot be edited using [**Choose start/end point**].
- Copies have the same time and date of creation as the original.

### ✓ Removing Opening or Closing Footage

- To remove only the closing footage from a movie, choose [**End point**] in Step 4, select the closing frame, and proceed to Step 7 without pressing the center of sub-selector in Step 6.
- To remove only the opening footage, proceed to Step 7 without pressing the center of sub-selector in Step 6.

### ✓ The [Trim Movie] Option (Retouch Menu)



Movies can also be edited using the [**Trim movie**] item in the retouch menu.

---

## ■ Save Current Frame



Save a selected frame as a JPEG still.

### 1 Pause the movie on the desired frame.

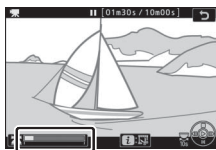
- Press  to pause playback.
- Press  or  to locate the desired frame.



### 2 Choose [Save current frame].

Press the  button, then highlight [Save current frame] and press  to create a JPEG copy of the current frame.

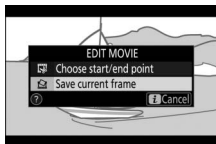



### ✓ [Save Current Frame]

- Stills are saved at the dimensions selected for [Frame size/frame rate] in the movie shooting menu when the movie was recorded.
- They cannot be retouched.
- Some categories of photo information are not displayed during playback.





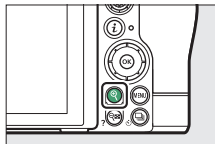

## Playback Zoom

Press  or  to zoom in on photos displayed in full-frame playback. **[FX (36x24)]**-format photos can be zoomed in to a maximum of approximately 33x (**[Large]** pictures), 25x (**[Medium]**), or 17x (**[Small]**).



### Using Playback Zoom

To	Description
<b>Zoom in/ zoom out</b>	<ul style="list-style-type: none"><li>• Press the  button or use stretch gestures to zoom in.</li><li>• To zoom out, press  (?) or use pinch gestures.</li></ul> <div data-bbox="609 506 886 690"></div> <p>A navigation window is displayed during the zoom ratio is altered, with the area currently visible indicated by a yellow border. A bar below the navigation window shows the zoom ratio, turning green at 1:1. The navigation window clears from the display after a few seconds.</p>

To	Description
<b>View other areas of image</b>	Use the multi selector or glide gestures to view areas of image not visible in the monitor. Keep the multi selector pressed to scroll rapidly to other areas of frame.
<b>Select faces</b>	<p>Faces detected during zoom are indicated by white borders in the navigation window. Rotate the sub-command dial or tap the on-screen guide to view other faces.</p> 
<b>View other pictures</b>	Rotate the main command dial to view the same location in other photos without changing the zoom ratio (selecting a movie cancels zoom). You can also view other photos by tapping the ◀ or ▶ icon at the bottom of the display.
<b>Exit to shooting mode</b>	Press the shutter-release button halfway or press the  button to exit.
<b>View menus</b>	Press the MENU button to view the menus.

## Deleting Pictures

Follow the steps below to delete pictures from memory cards. Note that pictures cannot be recovered once deleted. Pictures that are protected, however, cannot be deleted.

### Using the Delete Button

Press the  button to delete the current picture.

---

#### 1 Select the desired picture with the multi selector and press the button.

- A confirmation dialog will be displayed.
- To exit without deleting the picture, press .

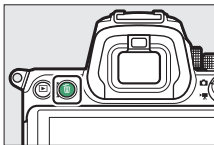

---

#### 2 Press the button again.

The picture will be deleted.

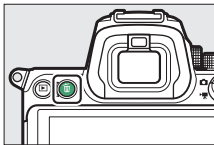



---

## 📌 Calendar Playback

During calendar playback, you can delete all photographs taken on a selected date by highlighting the date in the date list and pressing the  button.

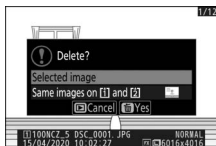

## 📌 Deleting Copies

If the picture selected in the playback display when the  button is pressed was recorded with two memory cards inserted and **[Backup]** or **[RAW Slot 1 - JPEG Slot 2]** selected for **[Role played by card in Slot 2]**, you will be prompted to choose whether to delete both copies or only the copy on the card in the current slot ( 233).





## **Deleting Multiple Pictures**

Use **[Delete]** in the playback menu to delete multiple pictures at once. Note that depending on the number of images, some time may be required for deletion.

	<b>Option</b>	<b>Description</b>
	<b>[Selected images]</b>	Delete selected pictures.
	<b>[Images shot on selected dates]</b>	Delete all pictures taken on selected dates (□ 189).
ALL	<b>[All images]</b>	Delete all pictures from a selected memory card. Only pictures in the folder currently selected for <b>[Playback folder]</b> in the playback menu are affected.

## ■ Deleting Selected Pictures

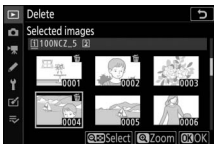
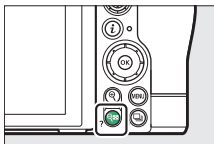

### 1 Select pictures.

- Highlight pictures using the multi selector and press the  (?) button to select; selected pictures are marked with  icons. Selected pictures can be deselected by pressing the  (?) button again.



- Repeat until all the desired pictures are selected.
- To view the highlighted picture full screen, press and hold the  button.



### 2 Delete the pictures.

- Press ; a confirmation dialog will be displayed.
- Highlight **[Yes]** and press  to delete the selected pictures.





## ■ Images Shot on Selected Dates

### 1 Select dates.

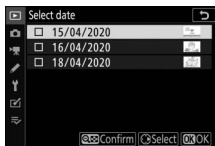
- Highlight dates using the multi selector and press  to select; selected dates are marked with  icons. Selected dates can be deselected by pressing  again.
- Repeat until you have selected all the desired dates.





### 2 Delete the pictures.

- Press ; a confirmation dialog will be displayed.
- Highlight [Yes] and press  to delete all the pictures taken on the selected dates.



## ■ Deleting All Pictures

### 1 Choose a memory card.

Press  or  to highlight the slot containing the memory card from which the pictures will be deleted and press .



### 2 Delete the pictures.

- A confirmation dialog will be displayed showing the name of the folder containing the photos to be deleted. Highlight **[Yes]** and press  to delete all pictures from the folder. The folder is that previously selected via **[Playback folder]** in the playback menu.
- Note that depending on the number of images, some time may be required for deletion.





# Menu Guide

## Defaults

The defaults for the playback, photo shooting, movie shooting, Custom Settings, and setup menus are listed below.

### Playback Menu Defaults

Playback menu option	Default
[Delete]	—
[Playback folder]	All
[Playback display options]	
[Focus point]	<input type="checkbox"/>
[Exposure info]	<input type="checkbox"/>
[Highlights]	<input type="checkbox"/>
[RGB histogram]	<input type="checkbox"/>
[Shooting data]	<input type="checkbox"/>
[Overview]	<input type="checkbox"/>
[None (image only)]	<input type="checkbox"/>
[Dual-format recording PB slot]	Slot 1
[Image review]	Off
[After delete]	Show next
[Rotate tall]	On
[Copy image(s)]	—

Playback menu option	Default
[Slide show]	
[Image type]	Still images and movies
[Frame interval]	2 s
[Rating]	—

## **Photo Shooting Menu Defaults**

Photo shooting menu option	Default
[Reset photo shooting menu]	—
[Storage folder]	
[Rename]	NCZ_5
[Select folder by number]	100
[Select folder from list]	—
[File naming]	DSC
[Role played by card in Slot 2]	Overflow
[Choose image area]	FX (36×24)
[Image quality]	JPEG normal
[Image size]	Large
[NEF (RAW) recording]	
[NEF (RAW) compression]	Lossless compressed
[NEF (RAW) bit depth]	14-bit



Photo shooting menu option	Default
<b>[ISO sensitivity settings]</b>	
[ISO sensitivity]	 : Auto <b>P, S, A, M: 100</b>
[Auto ISO sensitivity control]	On
[Maximum sensitivity]	51200
[Maximum sensitivity with 	Same as without flash
[Minimum shutter speed]	Auto
[White balance]	 <b>A1</b> : Keep overall atmosphere
[Fine-tune]	A-B: 0, G-M: 0
[Choose color temperature]	5000 K
[Preset manual]	d-1
[Set Picture Control]	Auto
[Manage Picture Control]	—
[Color space]	sRGB
[Active D-Lighting]	Off
[Long exposure NR]	Off
[High ISO NR]	Normal
[Vignette control]	Normal
[Diffraction compensation]	On
[Auto distortion control]	On
[Flicker reduction shooting]	Off
[Metering]	Matrix metering

Photo shooting menu option	Default
<b>[Flash control]</b>	
[Flash control mode]	TTL
[Wireless flash options]	Off
[Remote flash control]	Group flash
[Flash mode]	Fill flash
[Flash compensation]	0.0
[Focus mode]	Single AF
[AF-area mode]	Auto-area AF
[Vibration reduction]	(Varies with lens)
<b>[Auto bracketing]</b>	
[Auto bracketing set]	AE & flash bracketing
[Number of shots]	0
[Increment]	1.0
<b>[Multiple exposure]</b>	
[Multiple exposure mode]	Off
[Number of shots]	2
[Overlay mode]	Average
[Save individual images (NEF)]	On
[Overlay shooting]	On
[Select first exposure (NEF)]	—
<b>[HDR (high dynamic range)]</b>	
[HDR mode]	Off
[Exposure differential]	Auto
[Smoothing]	Normal
[Save individual images (NEF)]	Off

Photo shooting menu option	Default
<b>[Interval timer shooting]</b>	
[Choose start day/time]	Now
[Interval]	1 min.
[Intervals×shots/interval]	0001×1
[Exposure smoothing]	On
[Silent photography]	On
[Interval priority]	Off
[Focus before each shot]	Off
[Options]	Off
<b>[Starting storage folder]</b>	
[New folder]	<input type="checkbox"/>
[Reset file numbering]	<input type="checkbox"/>
<b>[Time-lapse movie]</b>	
[Interval]	5 s
[Shooting time]	25 min.
[Exposure smoothing]	On
[Silent photography]	On
[Choose image area]	FX
[Frame size/frame rate]	1920×1080; 60p
[Interval priority]	Off
[Focus before each shot]	Off
[Destination]	Slot 1

Photo shooting menu option	Default
<b>[Focus shift shooting]</b>	
[No. of shots]	100
[Focus step width]	5
[Interval until next shot]	0
[First-frame exposure lock]	On
[Silent photography]	On
<b>[Starting storage folder]</b>	
[New folder]	<input type="checkbox"/>
[Reset file numbering]	<input type="checkbox"/>
[Silent photography]	Off

## **Movie Shooting Menu Defaults**

Movie shooting menu option	Default
[Reset movie shooting menu]	—
[File naming]	DSC
[Destination]	Slot 1
[Choose image area]	FX
[Frame size/frame rate]	1920×1080; 60p
[Movie quality]	High quality
[Movie file type]	MOV
<b>[ISO sensitivity settings]</b>	
[Maximum sensitivity]	25600
[Auto ISO control (mode M)]	On
[ISO sensitivity (mode M)]	100

<b>Movie shooting menu option</b>	<b>Default</b>
[White balance]	Same as photo settings
[Fine-tune]	A-B: 0, G-M: 0
[Choose color temperature]	5000 K
[Preset manual]	d-1
[Set Picture Control]	Same as photo settings
[Manage Picture Control]	—
[Active D-Lighting]	Off
[High ISO NR]	Normal
[Vignette control]	Normal
[Diffraction compensation]	On
[Auto distortion control]	On
[Flicker reduction]	Auto
[Metering]	Matrix metering
[Focus mode]	Full-time AF
[AF-area mode]	Auto-area AF
[Vibration reduction]	Same as photo settings
[Electronic VR]	Off
[Microphone sensitivity]	Auto
[Attenuator]	Disable
[Frequency response]	Wide range
[Wind noise reduction]	Off
[Headphone volume]	15
[Timecode]	
[Record timecodes]	Off
[Count-up method]	Record run
[Timecode origin]	—
[Drop frame]	On

## Custom Settings Menu Defaults



Custom Settings menu option		Default
[Reset custom settings]		—
a1	[AF-C priority selection]	Release
a2	[AF-S priority selection]	Focus
a3	[Focus tracking with lock-on]	3
a4	[Auto-area AF face/eye detection]	Face and eye detection on
a5	[Focus points used]	All points
a6	[Store points by orientation]	No
a7	[AF activation]	Shutter/AF-ON
a8	[Limit AF-area mode selection]	
	[Pinpoint AF]	<input checked="" type="checkbox"/>
	[Single-point AF]	✓ (cannot be deselected)
	[Dynamic-area AF]	<input checked="" type="checkbox"/>
	[Wide-area AF (S)]	<input checked="" type="checkbox"/>
	[Wide-area AF (L)]	<input checked="" type="checkbox"/>
	[Auto-area AF]	<input checked="" type="checkbox"/>
a9	[Focus point wrap-around]	No wrap
a10	[Focus point options]	
	[Manual focus mode]	On
	[Dynamic-area AF assist]	On
a11	[Low-light AF]	On
a12	[Built-in AF-assist illuminator]	On
a13	[Manual focus ring in AF mode]	Enable



	<b>Custom Settings menu option</b>	<b>Default</b>
b1	[EV steps for exposure cntrl]	1/3 step
b2	[Easy exposure compensation]	Off
b3	[Center-weighted area]	φ12 mm
b4	[Fine-tune optimal exposure]	
	[Matrix metering]	0
	[Center-weighted metering]	0
	[Spot metering]	0
	[Highlight-weighted metering]	0
c1	[Shutter-release button AE-L]	Off
c2	[Self-timer]	
	[Self-timer delay]	10 s
	[Number of shots]	1
	[Interval between shots]	0.5 s
c3	[Power off delay]	
	[Playback]	10 s
	[Menus]	1 min.
	[Image review]	4 s
	[Standby timer]	30 s
d1	[CL mode shooting speed]	3 fps
d2	[Max. continuous release]	100
d3	[Sync. release mode options]	Sync
d4	[Exposure delay mode]	Off
d5	[Shutter type]	Auto

	<b>Custom Settings menu option</b>	<b>Default</b>
d6	[File number sequence]	On
d7	[Apply settings to live view]	On
d8	[Framing grid display]	Off
d9	[Peaking highlights]	
	[Peaking level]	Off
	[Peaking highlight color]	Red
d10	[View all in continuous mode]	On
e1	[Flash sync speed]	1/200 s
e2	[Flash shutter speed]	1/60 s
e3	[Exposure comp. for flash]	Entire frame
e4	[Auto $\frac{1}{2}$ ISO sensitivity control]	Subject and background
e5	[Modeling flash]	On
e6	[Auto bracketing (mode M)]	Flash/speed
e7	[Bracketing order]	MTR > under > over
f1	[Customize  Menu]	Set Picture Control, White balance, Image quality, Image size, Flash mode, Metering, Wi-Fi connection, View memory card info, Release mode, Vibration reduction, AF-area mode, Focus mode

Custom Settings menu option		Default
f2	<b>[Custom controls]</b>	
	[Fn1 button]	White balance
	[Fn2 button]	Focus mode/AF-area mode
	[AF-ON button]	AF-ON
	[Sub-selector]	Focus point selection
	[Sub-selector center]	AE/AF lock
	[Movie record button]	None
	[Lens Fn button]	AE/AF lock
	[Lens Fn2 button]	AF-ON
	[Lens control ring]	(Varies with lens)
f3	<b>[OK button]</b>	
	[Shooting mode]	Select center focus point
	[Playback mode]	Zoom on/off
	[Zoom on/off]	1 : 1 (100%)
f4	<b>[Shutter spd &amp; aperture lock]</b>	
	[Shutter speed lock]	Off
	[Aperture lock]	Off

Custom Settings menu option		Default
f5	[Customize command dials]	
	[Reverse rotation]	Exposure compensation: <input type="checkbox"/> Shutter speed/aperture: <input type="checkbox"/>
	[Change main/sub]	Exposure setting: Off, Autofocus setting: Off
	[Menus and playback]	Off
	[Sub-dial frame advance]	10 frames
f6	[Release button to use dial]	No
f7	[Reverse indicators]	
g1	[Customize  Menu]	Set Picture Control, White balance, Frame size and rate/image quality, Microphone sensitivity, Choose image area, Metering, Wi-Fi connection, Destination, Electronic VR, Vibration reduction, AF-area mode, Focus mode

	<b>Custom Settings menu option</b>	<b>Default</b>
g2	<b>[Custom controls]</b>	
	<b>[Fn1 button]</b>	White balance
	<b>[Fn2 button]</b>	Focus mode/AF-area mode
	<b>[AF-ON button]</b>	AF-ON
	<b>[Sub-selector center]</b>	AE/AF lock
	<b>[Shutter-release button]</b>	Take photos
	<b>[Lens control ring]</b>	(Varies with lens)
g3	<b>[OK button]</b>	Select center focus point
g4	<b>[AF speed]</b>	0
	<b>[When to apply]</b>	Always
g5	<b>[AF tracking sensitivity]</b>	4
g6	<b>[Highlight display]</b>	
	<b>[Display pattern]</b>	Off
	<b>[Highlight display threshold]</b>	248

## Setup Menu Defaults

Setup menu option	Default
[Format memory card]	—
[Save user settings]	—
[Reset user settings]	—
[Language]	(Default varies with country of purchase)
[Time zone and date]	
[Time zone]	(Default varies with country of purchase)
[Date and time]	—
[Date format]	(Default varies with country of purchase)
[Daylight saving time]	Off
[Monitor brightness]	0
[Monitor color balance]	A-B: 0, G-M: 0
[Viewfinder brightness]	Auto
[Viewfinder color balance]	A-B: 0, G-M: 0
[Limit monitor mode selection]	
[Automatic display switch]	<input checked="" type="checkbox"/>
[Viewfinder only]	<input checked="" type="checkbox"/>
[Monitor only]	<input checked="" type="checkbox"/>
[Prioritize viewfinder]	<input checked="" type="checkbox"/>
[Information display]	Dark on light

Setup menu option	Default
<b>[AF fine-tuning options]</b>	
[AF fine-tune on/off]	Off
[Fine-tune and save lens]	—
[Default]	—
[List saved values]	—
<b>[Non-CPU lens data]</b>	
[Lens number]	1
[Focal length (mm)]	--
[Maximum aperture]	--
<b>[Clean image sensor]</b>	
[Automatic cleaning]	Clean at shutdown
[Image Dust Off ref photo]	—
[Pixel mapping]	—
<b>[Image comment]</b>	
[Attach comment]	<input type="checkbox"/>
<b>[Copyright information]</b>	
[Attach copyright information]	<input type="checkbox"/>
<b>[Beep options]</b>	
[Beep on/off]	Off
[Volume]	2
[Pitch]	Low
<b>[Touch controls]</b>	
[Enable/disable touch controls]	Enable
[Full-frame playback flicks]	Left → Right

Setup menu option	Default
<b>[HDMI]</b>	
[Output resolution]	Auto
<b>[Advanced]</b>	
[Output range]	Auto
[External recording control]	Off
<b>[Location data]</b>	
[Standby timer]	Enable
[Position]	—
[Set clock from satellite]	Yes
<b>[Wireless remote (WR) options]</b>	
[LED lamp]	On
[Link mode]	Pairing
[Assign remote (WR) Fn button]	None
[Airplane mode]	Disable
<b>[Connect to smart device]</b>	
<b>[Pairing (Bluetooth)]</b>	
[Bluetooth connection]	Disable
<b>[Select to send (Bluetooth)]</b>	
[Auto select to send]	Off
[Wi-Fi connection]	—
[Send while off]	On
<b>[Location data (smart device)]</b>	
[Latitude]	—
[Longitude]	—
[Altitude]	—
[UTC]	—



Setup menu option	Default
<b>[Connect to PC]</b>	
[Wi-Fi connection]	Disable
[Network settings]	—
<b>[Options]</b>	
[Auto send]	Off
[Delete after send]	No
[Send file as]	NEF (RAW) + JPEG
[Deselect all?]	—
[MAC address]	—
[Conformity marking]	—
[Battery info]	—
[USB power delivery]	Enable
[Energy saving]	Enable
[Slot empty release lock]	Enable release
[Save/load menu settings]	—
[Reset all settings]	—
[Firmware version]	—

## ▶ The Playback Menu: Managing Images

To display the playback menu, select the ▶ (playback menu) tab in the camera menus.

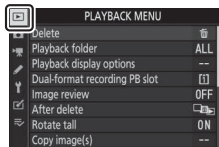

The playback menu contains the following items:

Item	📖	Item	📖
[Delete]	209	[After delete]	212
[Playback folder]	209	[Rotate tall]	212
[Playback display options]	210	[Copy image(s)]	213
[Dual-format recording PB slot]	210	[Slide show]	220
[Image review]	211	[Rating]	222



### ✔ See Also

“Playback Menu Defaults” (📖 191).

## Delete

MENU button ➡  playback menu

Delete multiple images. For more information, see “Deleting Multiple Pictures” (📖187).

Option	Description
 [Selected images]	Delete selected pictures.
 [Images shot on selected dates]	Delete all pictures taken on selected dates.
ALL [All images]	Delete all pictures in the folder currently selected for [Playback folder] in the playback menu. <ul style="list-style-type: none"><li>• If two memory cards are inserted, you can select the card from which pictures will be deleted.</li></ul>

## Playback Folder

MENU button ➡  playback menu



Choose a folder for playback.

Option	Description
(Folder name)	Pictures in all folders with the selected name will be visible during playback. Folders can be renamed using the [Storage folder] > [Rename] option in the photo shooting menu.
[All]	Pictures in all folders will be visible during playback.
[Current]	Only pictures in the current folder will be visible during playback.

## Playback Display Options

MENU button ➡  playback menu

Choose whether the focus points used when the photograph was taken are displayed during full-frame playback. You can also choose the types of photo information that can be viewed during full-frame playback.

- Highlight options and press  to select () or deselect (.
- To complete the operation, press .

## Dual-format Recording PB Slot

MENU button ➡  playback menu

Choose the slot from which dual-format pictures recorded with **[RAW Slot 1 - JPEG Slot 2]** selected for **[Role played by card in Slot 2]** in the photo shooting menu are played back.

# Image Review

MENU button ➡  playback menu



Choose whether pictures are automatically displayed in the monitor immediately after shooting.

Option	Description
[On]	Pictures appear in the currently-selected display (monitor or viewfinder) as they are taken.
[On (monitor only)]	Pictures are displayed after shooting only when the monitor is used to frame shots. Pictures are not displayed in the viewfinder when [Viewfinder only] is selected for monitor mode.
[Off]	Pictures can only be viewed by pressing the  button.

## After Delete

MENU button ➡  playback menu

Choose the picture displayed after an image is deleted.

	Option	Description
	[ <b>Show next</b> ]	<ul style="list-style-type: none"><li>• The following picture is displayed.</li><li>• If the deleted image was the last picture, the preceding picture will be displayed.</li></ul>
	[ <b>Show previous</b> ]	<ul style="list-style-type: none"><li>• The preceding picture is displayed.</li><li>• If the deleted image was the first picture, the next picture will be displayed.</li></ul>
	[ <b>Continue as before</b> ]	<ul style="list-style-type: none"><li>• If you were scrolling through pictures in the order recorded, the following picture will be displayed as described for [<b>Show next</b>].</li><li>• If you were scrolling through pictures in reverse order, the next picture will be displayed as described for [<b>Show previous</b>].</li></ul>

## Rotate Tall

MENU button ➡  playback menu

When [**On**] is selected, “tall” (portrait-orientation) pictures will be automatically rotated for display during playback.

### Rotate Tall

Images are not rotated automatically during image review even when [**On**] is selected for [**Rotate tall**].

# Copy Image(s)

MENU button ➡  playback menu

Copy pictures from one memory card to another when two memory cards are inserted.

Option	Description
[Select source]	Choose the card from which pictures will be copied.
[Select image(s)]	Select pictures to be copied.
[Select destination folder]	Select the destination folder on the remaining card (the card not selected for [Select source]).
[Copy image(s)?]	Copy the pictures.

## Copying Pictures

### 1 Choose [Select source].

Highlight [Select source] and press  to display the [Select source] dialog.

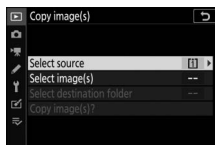

### 2 Select the card containing the pictures to be copied.

Highlight the slot for the card containing the pictures to be copied and press  to select the highlighted slot and return to the [Copy image(s)] menu.

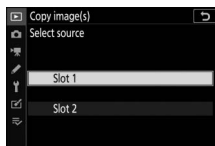

### 3 Choose [Select image(s)].

Highlight [**Select image(s)**] and press **▶** to view the [**Select image(s)**] display.

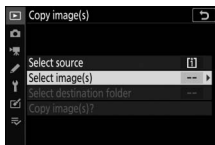

### 4 Select the source folder.

- Highlight the folder containing the images to be copied and press **▶** to select the highlighted folder and display the [**Images selected by default**] menu.
- To copy all pictures from the card in the selected slot, highlight [**All images in slot**], press **OK**, and proceed to Step 10.

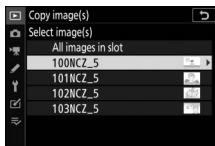





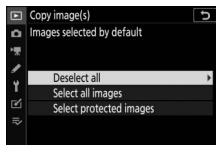

## 5 Make the initial selection.

Choose the pictures that will be selected by default.



Option	Description
[Deselect all]	None of the pictures in the chosen folder will be selected by default. <ul style="list-style-type: none"><li>• Choose this option when you want to select pictures individually.</li></ul>
[Select all images]	All of the pictures in the chosen folder will be selected by default. <ul style="list-style-type: none"><li>• Choose this option if you want to copy all or most of the pictures in the folder.</li></ul>
[Select protected images]	Only the protected images in the folder will be selected by default.

## 6 Select additional images.

- Highlight pictures and press the  (?) button to select; selected pictures are marked with a ✓. To deselect the current picture, press the  (?) button again; the ✓ will no longer be displayed.
- To view the highlighted picture full screen, press and hold the  button.
- After confirming that all the pictures you want to copy have ✓ marks, press  to return to the [**Copy image(s)**] menu.



## 7 Choose [**Select destination folder**].

Highlight [**Select destination folder**] and press  to display [**Select destination folder**] options.

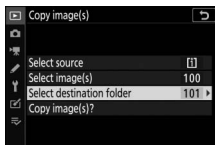

## 8 Choose a destination folder.

Choose one of the following options and press .

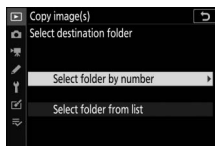

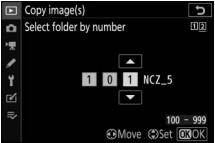
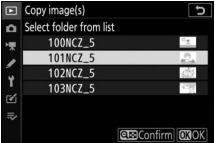
Option	Description
<b>[Select folder by number]</b>	Enter the number of the destination folder (📖227). If the folder with the selected number does not already exist, a new folder will be created. 
<b>[Select folder from list]</b>	Choose the destination folder from a list of existing folders. 

---

## 9 Select the folder.

After entering a folder number or highlighting the folder name, press **OK** to select the folder and return to the **[Copy image(s)]** menu.

---

## 10 Choose **[Copy image(s)?]**.

Highlight **[Copy image(s)?]** and press **OK** to display a confirmation dialog.

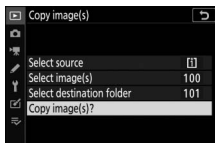

---

## 11 Choose **[Yes]**.

- The camera will display the message "**[Copy?]**" together with the number of pictures that will be copied.
- Highlight **[Yes]** and press **OK** to copy the selected pictures.
- Press **OK** again to exit when copying is complete.

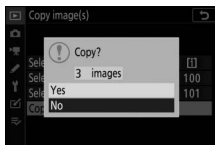

---

## ✔ Copying Pictures

- Pictures will not be copied if there is insufficient space on the destination card.
- If the destination folder contains a file with the same name as one of the pictures to be copied, a confirmation dialog will be displayed. Select [**Replace existing image**] or [**Replace all**] to replace the existing file or files. Protected files in the destination folder will not be replaced. Select [**Skip**] to continue without replacing existing files. Select [**Cancel**] to exit without copying any further pictures.
- Ratings and protected status are copied with the pictures.
- To prevent loss of power while copying is in progress, be sure the battery is fully charged or connect an optional charging AC adapter, or an optional AC adapter and power connector before copying movies.

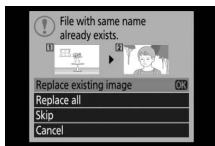

## Slide Show

MENU button ➡  playback menu

View a slide show; pictures are displayed in the order recorded. The pictures in the folder currently selected for **[Playback folder]** ( 209) will be displayed one-by-one in the order recorded.

Option	Description
<b>[Start]</b>	Start the slide show.
<b>[Image type]</b>	<ul style="list-style-type: none"><li>• Choose the type of picture displayed.</li><li>• Select <b>[By rating]</b> to view only pictures with selected ratings. Highlight ratings and press  to select (<input checked="" type="checkbox"/>) or deselect (<input type="checkbox"/>).</li></ul>
<b>[Frame interval]</b>	Choose how long each picture will be displayed.

## Viewing Slide Shows

To start the slide show, highlight **[Start]** and press **OK**. The following operations can be performed while the show is in progress:

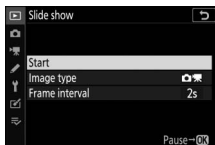

To	Description
<b>Skip back/skip ahead</b>	Press <b>◀</b> to return to the previous frame, <b>▶</b> to skip to the next frame.
<b>View additional photo info</b>	Press <b>▲</b> or <b>▼</b> to choose the photo info displayed. To hide photo info, select <b>[None (image only)]</b> .
<b>Pause</b>	Press <b>OK</b> to pause the slide show. To restart, highlight <b>[Restart]</b> and press <b>OK</b> .
<b>Adjust volume</b>	Press <b>Q</b> to increase volume, <b>Q(?)</b> to decrease.
<b>Exit to the playback menu</b>	Press <b>MENU</b> to end the slide show and return to the playback menu.
<b>Exit to playback mode</b>	Press <b>▶</b> to end the slide show and return to the playback display.
<b>Resume shooting</b>	Press the shutter-release button halfway to return to shooting mode.



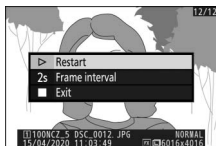



A dialog is displayed when the show ends. To restart, highlight **[Restart]** and press **OK**. To end the show, highlight **[Exit]** and press **OK**.



## Rating

MENU button ➡  playback menu

Rate pictures.

- Highlight pictures using the multi selector  or .
- Press  or  to choose a rating of from zero to five stars, or select  to mark the picture as a candidate for later deletion.
- To view the highlighted picture full screen, press and hold the  button.
- Press **OK** to save changes.





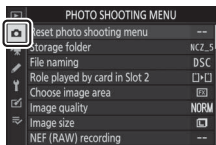

## The Photo Shooting Menu: Shooting Options

To view the photo shooting menu, select the  tab in the camera menus.



The photo shooting menu contains the following items:

Item		Item	
[Reset photo shooting menu]	224	[Active D-Lighting]	255
[Storage folder]	225	[Long exposure NR]	257
[File naming]	231	[High ISO NR]	258
[Role played by card in Slot 2]	232	[Vignette control]	259
[Choose image area]	234	[Diffraction compensation]	260
[Image quality]	234	[Auto distortion control]	260
[Image size]	235	[Flicker reduction shooting]	261
[NEF (RAW) recording]	236	[Metering]	262
[ISO sensitivity settings]	237	[Flash control]	263
[White balance]	239	[Flash mode]	267
[Set Picture Control]	247	[Flash compensation]	267
[Manage Picture Control]	250	[Focus mode]	267
[Color space]	254	[AF-area mode]	268
		[Vibration reduction]	268
		[Auto bracketing]	269

Item	
[Multiple exposure]	281
[HDR (high dynamic range)]	291
[Interval timer shooting]	297

Item	
[Time-lapse movie]	311
[Focus shift shooting]	322
[Silent photography]	332

---

### See Also

“Photo Shooting Menu Defaults” ( 192)

---

## Reset Photo Shooting Menu

MENU button →  photo shooting menu

Restore photo shooting menu options to their default values.

- Photo shooting menu reset is not available while a multiple exposure is in progress.

# Storage Folder

MENU button ➔ 📷 photo shooting menu

Choose the folder in which subsequent pictures will be stored.

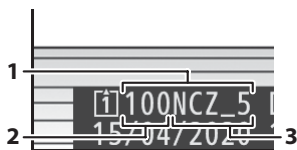

- 1 Folder
- 2 Folder number
- 3 Folder name

## Renaming Folders

The default folder name, which appears after the folder number, is “NCZ\_5”. To change the name assigned to new folders, select **[Rename]**.

- Existing folders cannot be renamed.
- If desired, the default name can be restored for subsequent folders by pressing and holding the 🗑️ button while the keyboard is displayed.



---

## ✓ Text Entry

A keyboard is displayed when text entry is required.

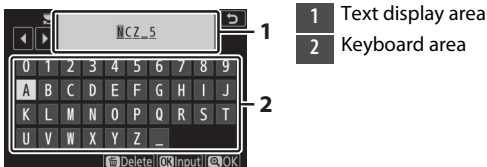
- Tap letters on the screen to insert them at the current cursor position. You can also enter characters by highlighting them with the multi selector and pressing .



- To move the cursor to a new position, tap the display or rotate the main command dial.
  - If a character is entered when the text display area is full, the rightmost character will be deleted.
  - To delete the character under the cursor, press the  button.
  - To complete entry, press .
  - To exit without completing text entry, press **MENU**.
-

## Select Folder by Number



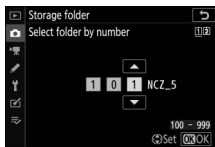

The folder in which subsequent pictures will be stored can be selected by number. If a folder with the specified number does not already exist, a new folder will be created.

### 1 Choose [Select folder by number].

- Highlight [**Select folder by number**] and press  to display the [**Select folder by number**] dialog.
- The card on which the new folder will be created is underlined in the card slot display area at the top right corner of the [**Select folder by number**] dialog. The card used for new folders depends on the option currently selected for [**Role played by card in Slot 2**] in the photo shooting menu.









### 2 Choose a folder number.

- Press  or  to highlight digits.
- To change the highlighted digit, press  or .





---

### 3 Save changes and exit.

- If a folder with the selected number already exists, a , , or  icon will be displayed to the left of the folder number. Press  to complete the operation and return to the main menu; if you chose a folder marked  or , it will be selected as the folder for new pictures.
- If you chose a folder number that does not already exist, a new folder will be created with that number when you press .
- In either case, subsequent pictures will be stored in the chosen folder.
- To exit without changing the storage folder, press the **MENU** button.

---

#### Folder Icons

Folders in the [**Select folder by number**] dialog are shown by  if empty, by  if full (containing either 5000 pictures or a picture numbered 9999), or by  if partially full. A  icon indicates that no further pictures can be stored in the folder.

---

## Select Folder from List

To choose from a list of existing folders:

---

### 1 Choose [Select folder from list].

Highlight [Select folder from list] and press  $\blacktriangleright$  to display the [Select folder from list] dialog.

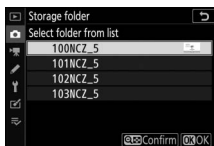

---

### 2 Highlight a folder.

Press  $\blacktriangle$  or  $\blacktriangledown$  to highlight a folder.

---

### 3 Select the highlighted folder.

- Press  $\text{OK}$  to select the highlighted folder and return to the main menu.
- Subsequent photographs will be stored in the selected folder.

---

## ✔ Folder and File Numbers

- Once the folder number has reached 999, the camera will stop creating new folders automatically and disable the shutter release if:
  - the current folder contains 5000 pictures (in addition, movie recording will be disabled if the camera calculates that the number of files needed to record a movie of the maximum length would result in the folder containing over 5000 files), or
  - the current folder contains a picture numbered 9999 (in addition, movie recording will be disabled if the camera calculates that the number of files needed to record a movie of the maximum length would result in a file numbered over 9999).
- If there is space on the memory card, you will nevertheless be able to continue shooting by:
  - creating a folder with a number less than 999 and selecting it as the storage folder, or
  - changing the options selected for **[Frame size/frame rate]** and **[Movie quality]** before recording movies.

## ✔ Startup Time

Additional time may be required for camera startup if the memory card contains a very large number of files or folders.

---



# File Naming

MENU button ➡ 📷 photo shooting menu

Pictures are saved using file names consisting of “DSC\_” followed by a four-digit number and a three-letter extension. **[File naming]** is used to select three letters to replace the “DSC” portion of the file name. For information on text entry, see “Text Entry” (📖 226).

---





## ✔ File Names

- File names take the form “DSC\_nnnn.xxx”. nnnn is a number from 0001 to 9999. xxx is one of the following extensions, assigned according to the options selected for image quality and file type:
  - NEF: NEF (RAW) photos
  - JPG: JPEG (fine, normal, or basic) photos
  - MOV: MOV movies
  - MP4: MP4 movies
  - NDF: Dust off reference data
- Images created with **[Adobe RGB]** selected for **[Color space]** have file names of the form “\_DSCnnnn.xxx”.
- In each pair of photographs recorded at image-quality settings of NEF (RAW)+JPEG, the NEF and JPEG images have the same file names but different extensions.

## Role Played by Card in Slot 2

MENU button →  photo shooting menu

Choose the role played by the card in Slot 2 when two memory cards are inserted in the camera.

Option	Description
  <b>[Overflow]</b>	The card in Slot 2 is used only when the card in Slot 1 is full.
  <b>[Backup]</b>	Each picture is recorded twice, once to the card in Slot 1 and again to the card in Slot 2.
 <b>[RAW Slot 1 - JPEG Slot 2]</b>	<ul style="list-style-type: none"><li>• NEF (RAW) copies of photos taken at settings of NEF (RAW) + JPEG are recorded only to the card in Slot 1, JPEG copies only to the card in Slot 2.</li><li>• Pictures taken at other image quality settings are recorded twice at the same setting, once to the card in Slot 1 and again to the card in Slot 2.</li></ul>

### **[RAW Slot 1 - JPEG Slot 2]**

If **[On]** is selected for **[Multiple exposure]** > **[Save individual images (NEF)]** in the photo shooting menu, or if **[On]** is selected for **[HDR (high dynamic range)]** > **[Save individual images (NEF)]** in the photo shooting menu, unprocessed copies of the individual NEF (RAW) photos that make up each multiple exposure or HDR image will be recorded to both memory cards together with the JPEG composite, regardless of the option selected for image quality.

---

## [Backup] and [RAW Slot 1 - JPEG Slot 2]

The shutter release is disabled when either card is full.



## Viewing Dual-Format Photos

- Use the [Dual-format recording PB slot] item in the playback menu to choose the slot from which dual-format photos are played back.
- When viewing dual-format photos, you can view the other copy using [Jump to copy on other card] in the **i** menu.

---

## Deleting Copies

When deleting pictures recorded using [Backup] or [RAW Slot 1 - JPEG Slot 2], you have the choice of erasing either both copies or only the copy on the card in the current slot.



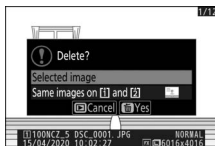

- Pressing  when a picture created using either of these options is selected during playback displays a confirmation message.
- To delete only the copy on the card in the current slot, highlight [Selected image] and press  again. The copy on the remaining card is not deleted.
- To delete both copies, highlight [Same images on [1] and [2]] and press .



## Choose Image Area



MENU button →  photo shooting menu

The camera offers a choice of the following image areas:

	Option	Description
	<b>[FX (36×24)]</b>	Record pictures in FX format with an angle of view equivalent to a 35 mm format camera. Use this option when taking photographs with NIKKOR lenses for 35 mm format cameras.
	<b>[DX (24×16)]</b>	Images are recorded in DX format. To calculate the approximate focal length of the lens in 35 mm format, multiply by 1.5. <ul style="list-style-type: none"><li>• Image-area selection is fixed at <b>[DX (24×16)]</b> when a DX lens is attached.</li></ul>
	<b>[1:1 (24×24)]</b>	Pictures are recorded with an aspect ratio of 1:1.
	<b>[16:9 (36×20)]</b>	Pictures are recorded with an aspect ratio of 16:9.

## Image Quality

MENU button →  photo shooting menu

Choose a file format for photographs. For more information, see “The  Menu” under “Image Quality” ( 136).

# Image Size

MENU button ➔  photo shooting menu

Choose the size, in pixels, of pictures recorded with the camera. Note that image size varies with the option selected for image area.

Image area	Image size	Size when printed at 300 dpi *
[FX (36×24)]	Large (6016 × 4016 pixels)	Approx. 50.9 × 34.0 cm/ 20.0 × 13.4 in.
	Medium (4512 × 3008 pixels)	Approx. 38.2 × 25.5 cm/ 15.0 × 10.0 in.
	Small (3008 × 2008 pixels)	Approx. 25.5 × 17.0 cm/ 10.0 × 6.7 in.
[DX (24×16)]	Large (3936 × 2624 pixels)	Approx. 33.3 × 22.2 cm/ 13.1 × 8.7 in.
	Medium (2944 × 1968 pixels)	Approx. 24.9 × 16.7 cm/ 9.8 × 6.6 in.
	Small (1968 × 1312 pixels)	Approx. 16.7 × 11.1 cm/ 6.6 × 4.4 in.
[1:1 (24×24)]	Large (4016 × 4016 pixels)	Approx. 34.0 × 34.0 cm/ 13.4 × 13.4 in.
	Medium (3008 × 3008 pixels)	Approx. 25.5 × 25.5 cm/ 10.0 × 10.0 in.
	Small (2000 × 2000 pixels)	Approx. 16.9 × 16.9 cm/ 6.7 × 6.7 in.
[16:9 (36×20)]	Large (6016 × 3384 pixels)	Approx. 50.9 × 28.7 cm/ 20.0 × 11.3 in.
	Medium (4512 × 2536 pixels)	Approx. 38.2 × 21.5 cm/ 15.0 × 8.5 in.
	Small (3008 × 1688 pixels)	Approx. 25.5 × 14.3 cm/ 10.0 × 5.6 in.



\* Print size in inches equals image size in pixels divided by printer resolution in dots per inch (dpi; 1 inch = 2.54 cm).

# NEF (RAW) Recording

MENU button →  photo shooting menu

Choose a compression type and bit depth for NEF (RAW) photographs.

## NEF (RAW) Compression

	Option	Description
ON 	[Lossless compressed]	NEF images are compressed using a reversible algorithm. The resulting files are about 60% to 80% the size of uncompressed pictures.
ON 	[Compressed]	NEF images are compressed using a non-reversible algorithm. The resulting files are about 45% to 65% the size of uncompressed pictures.

## NEF (RAW) Bit Depth



	Option	Description
12-bit	[12-bit]	NEF (RAW) images are recorded at a bit depth of 12 bits.
14-bit	[14-bit]	NEF (RAW) images are recorded at a bit depth of 14 bits. Files recorded at a bit depth of 14 bits contain more color data than pictures recorded using [12-bit]. Files recorded at a bit depth of 14 bits are also larger than pictures recorded using [12-bit].

# ISO Sensitivity Settings

MENU button ➔  photo shooting menu

Adjust ISO sensitivity settings for photographs.

Option	Description
[ISO sensitivity]	Select from values between ISO 100 and 51200. Extended settings of from about 0.3 to 1 EV below ISO 100 and 0.3 to 1 EV above ISO 51200 are also available.  offers an ISO AUTO option.

Option	Description
<p><b>[Auto ISO sensitivity control]</b></p>	<p>Highlight <b>[On]</b> and press  to enable auto ISO sensitivity control. If <b>[Off]</b> is selected, <b>[ISO sensitivity]</b> will remain fixed at the value selected by the user. The following options are available when <b>[On]</b> is selected.</p> <ul style="list-style-type: none"> <li>• <b>[Maximum sensitivity]</b>: Choose an upper limit for ISO sensitivity to prevent it being raised too high.</li> <li>• <b>[Maximum sensitivity with </b>]: Choose the upper ISO sensitivity limit for photos taken using an optional flash unit.</li> <li>• <b>[Minimum shutter speed]</b>: Choose the shutter speed below which auto ISO sensitivity control will kick in to prevent underexposure in modes <b>P</b> and <b>A</b>. If <b>[Auto]</b> is selected, the camera will choose the minimum shutter speed based on lens focal length. For example, the camera will automatically choose faster minimum shutter speeds to prevent blur caused by camera shake when a long lens is attached. <ul style="list-style-type: none"> <li>- To view auto shutter-speed selection options, highlight <b>[Auto]</b> and press . Auto shutter-speed selection can be fine-tuned by choosing faster or slower minimums. Faster settings can be used to reduce blur when photographing fast-moving subjects.</li> <li>- Shutter speeds may drop below the selected minimum if optimal exposure cannot be achieved at the ISO sensitivity chosen for <b>[Maximum sensitivity]</b>.</li> </ul> </li> </ul>



# White Balance

MENU button ➔ 📷 photo shooting menu

Adjust white balance to match the color of the light source. For more information, see “Basic Settings” under “White Balance” (📖81) and “The **i** Menu” under “White Balance” (📖129).

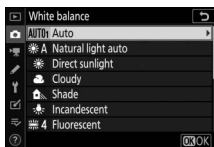

## The White Balance Menu: Fine-Tuning

- 1 Select [White balance] in the photo shooting menu, highlight the desired option, and press **▶** as often as necessary to display fine-tuning options.**

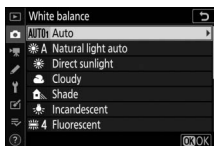

For information on fine-tuning **PRE [Preset manual]** white balance, see “Fine-Tuning Preset Manual White Balance” (📖246).

---

## 2 Fine-tune white balance.

- The multi selector can be used to move the cursor up to six steps from the center of the grid along either of the A (amber)–B (blue) and G (green)–M (magenta) axes. The selected value is displayed to the right of the grid.
- The A (amber)–B (blue) axis corresponds to color temperature and is ruled in increments of 0.5. A change of 1 is equivalent to approximately 5 mired.
- The G (green)–M (magenta) axis has effects similar to color compensation filters and is ruled in increments of 0.25. A change of 1 is equivalent to approximately 0.05 diffuse density units.

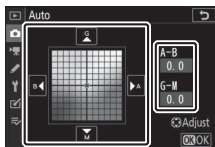

---

## 3 Save changes.

- Press **OK** to save changes and exit to the menus.
- If white balance has been fine-tuned, an asterisk (“\*”) will be displayed in the icon.



---

### ✓ **White Balance Fine-Tuning**

The colors on the fine-tuning axes are relative, not absolute. Selecting more of a color on a given axis does not necessarily result in that color appearing in pictures. For example, moving the cursor to B (blue) when a “warm” setting such as  [Incandescent] is selected will make pictures slightly “colder” but will not actually make them blue.

### ✓ **“Mired”**

Values in mired are calculated by multiplying the inverse of the color temperature by  $10^6$ . Any given change in color temperature produces a greater difference in color at low color temperatures than it would at higher color temperatures. For example, a change of 1000 K produces a much greater change in color at 3000 K than at 6000 K. Mired is a measure of color temperature that takes such variation into account, and as such is the unit used in color-temperature compensation filters.

E.g.: Change in color temperature (in Kelvin): Value in mired





- 4000 K – 3000 K = 1000 K: 83 mired
- 7000 K – 6000 K = 1000 K: 24 mired

## The White Balance Menu: Choosing a Color Temperature

Choose a color temperature by entering values for the A (amber)–B (blue) and G (green)–M (magenta) axes.

**1** Select [White balance] in the photo shooting menu, then highlight  [Choose color temperature] and press .

**2** Choose a color temperature.

- Press  or  to highlight digits on the A–B (amber–blue) axis. You can also highlight the G–M (green–magenta) axis.
- Press  or  to edit the selected item.

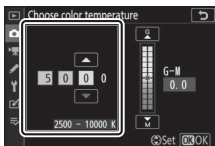

A–B (amber–blue) axis

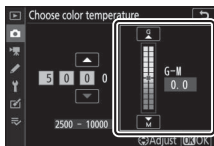

G–M (green–magenta)  
axis

---

### 3 Save changes.

- Press **OK** to save changes and exit to the menus.
- If a value other than 0 is selected for the green (G)–magenta (M) axis, an asterisk (“\*”) will appear in the icon.

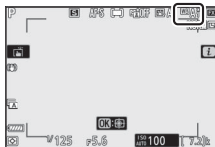

---

#### ✔ Color-Temperature Selection

- Do not use color-temperature selection with fluorescent light sources; instead, use the  [Fluorescent] option.
  - When using color-temperature selection with other light sources, take a test shot to determine if the selected value is appropriate.
-

## Preset Manual: Copying White Balance from a Photograph

The white balance values for existing photographs can be copied to selected presets. For information on measuring new values for preset manual white balance, see “Preset Manual” (p. 132).

- 1 Select [White balance] in the photo shooting menu, then highlight PRE [Preset manual] and press .**

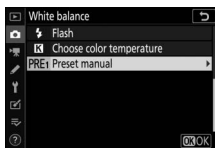

- 2 Select a destination.**

- Using the multi selector, highlight the destination preset (d-1 to d-6).
- Press ; a confirmation dialog will be displayed.



- 3 Choose [Select image].**

Highlight [Select image] and press  to view the pictures on the current memory card.

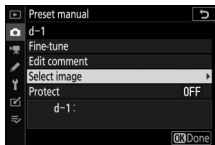

---

## 4 Highlight the source image.

- Use the multi selector to highlight the desired picture.
- To view the highlighted picture full screen, press and hold the  button.



---

## 5 Copy white balance.

- Press  to copy the white balance value for the highlighted photograph to the selected preset.
- If the highlighted photograph has a comment, the comment will be copied to the comment for the selected preset.

---

## ✓ Fine-Tuning Preset Manual White Balance

The selected preset can be fine-tuned by selecting [**Fine-tune**] in the preset manual white balance menu (☐ 239).

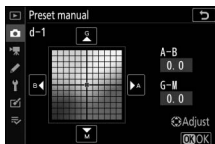

## ✓ "Edit Comment"

To enter a descriptive comment of up to 36 characters for the current white-balance preset, select [**Edit comment**] in the preset manual white balance menu.



## ✓ "Protect"

To protect the current white-balance preset, select [**Protect**] in the preset manual white balance menu. Highlight [**On**] and press **OK**; the current white balance preset is now protected. Protected presets cannot be modified.

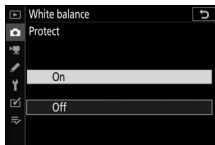



# Set Picture Control

MENU button ➔ 📷 photo shooting menu

Choose image processing (“Picture Control”) options for new photos according to the scene or your creative intent. For more information, see “The **i** Menu” under “Set Picture Control” (📖 123).

## **Modifying Picture Controls from the Menu**

Existing preset or custom Picture Controls can be modified to suit the scene or the user’s creative intent.

### **1 Select a Picture Control.**

Highlight the desired Picture Control in the Picture Control list and press

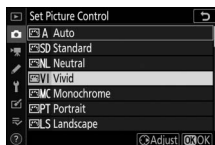

---

## 2 Edit the selected Picture Control.

- Press or to highlight the desired setting (127). Press or to choose a value in increments of 1, or rotate the sub-command dial to choose a value in increments of 0.25.
- The options available vary with the Picture Control selected.
- To quickly adjust levels for balanced [**Sharpening**], [**Mid-range sharpening**], and [**Clarity**], highlight [**Quick sharp**] and press or .
- To abandon any changes and start over from default settings, press the button.



---

## 3 Save changes and exit.

Press to save changes.

---

## ✓ The *i* Menu

- To select Picture Controls in the *i* menu, highlight [**Set Picture Control**] and press **OK**.
- Press **◀** and **▶** to choose a Picture Control and press **⏏** to display Picture Control settings. The effect of any changes can be previewed in the display.

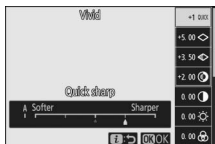

## ✓ Manage Picture Control

Modifications to existing Picture Controls can be saved using the [**Manage Picture Control**] item in the photo or movie shooting menu, creating custom Picture Controls that can then be copied to a memory card and used in compatible software or shared among cameras of the same model.

---

# Manage Picture Control

MENU button → 📷 photo shooting menu

Save modified Picture Controls as custom Picture Controls.

Option	Description
[Save/edit]	Create a new custom Picture Control based on an existing preset or custom Picture Control, or edit existing custom Picture Controls.
[Rename]	Rename custom Picture Controls.
[Delete]	Delete custom Picture Controls.
[Load/save]	Copy custom Picture Controls to and from the memory card.

## Creating Custom Picture Controls

### 1 Select [Save/edit].

Highlight [Save/edit] and press  to view [Choose Picture Control] options.

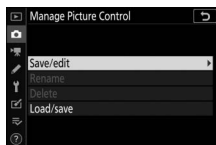

## 2 Select a Picture Control.

- Highlight an existing Picture Control and press **OK** to display edit options.
- To save a copy of the highlighted Picture Control without further modification, press **OK**. [**Save as**] options will be displayed; proceed to Step 4.

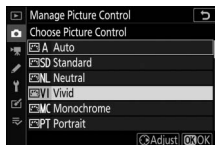

## 3 Edit the selected Picture Control.

- The settings available and the techniques for editing them are the same as for [**Set Picture Control**].
- Press **OK** to display [**Save as**] options when settings are complete.
- To abandon any changes and start over from default settings, press the **Reset** button.



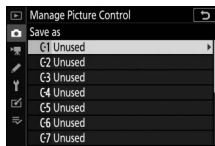

## 4 Select a destination.

Choose a destination for the custom Picture Control (C-1 through C-9).



## 5 Name the Picture Control.

- Pressing  when a destination is highlighted in the previous step displays the **[Rename]** text-entry dialog.
- By default, new Picture Controls are named by adding a two-digit number to the name of the existing Picture Control. The two-digit number is assigned automatically.
- Custom Picture Control names can be up to nineteen characters long. New characters are added at the cursor position.
- To cycle through the upper- and lower-case and symbol keyboards, tap the keyboard selection button.
- For information on editing Picture Control names, see “Text Entry” (☞ 226).
- When entry is complete, press  to save the new Picture Control.
- The new Picture Control will be added to the Picture Control list.



### ✓ The Original Picture Control Icon

The original preset Picture Control on which the custom Picture Control is based is indicated by an icon in the edit display.



## ✔ Custom Picture Control Options

The options available with custom Picture Controls are the same as those on which the custom Picture Control was based.

## ✔ Load/Save

The [**Load/save**] item in the [**Manage Picture Control**] menu can be used to copy custom Picture Controls from the camera to a memory card. You can also delete custom Picture Controls or copy them from a memory card to the camera. (The memory card must be inserted in Slot 1. Memory cards inserted in Slot 2 will not be detected.)

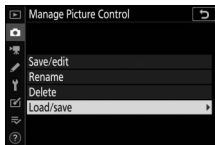

- [**Copy to camera**]: Copy (import) custom Picture Controls from the memory card to the camera. The Picture Controls are copied to custom Picture Controls C-1 through C-9 on the camera and can be named as desired.
  - [**Delete from card**]: Delete selected custom Picture Controls from the memory card.
  - [**Copy to card**]: Copy (export) a custom Picture Control from the camera to a memory card. Highlight a destination (1 through 99) for the selected Picture Control and press **Ⓜ** to export it to the memory card.
-

# Color Space

MENU button ➔  photo shooting menu

The color space determines the gamut of colors available for color reproduction. [sRGB] is recommended for general-purpose printing and display. With a broader gamut of colors than [sRGB], [Adobe RGB] is a better choice for professional publication and commercial printing.

---

## ✔ Color Space

The selected color space may be overwritten when pictures are opened in third-party software. NX Studio can open pictures in the color space selected on the camera.

## ✔ Adobe RGB

For accurate color reproduction, Adobe RGB images require applications, displays, and printers that support color management.

---



# Active D-Lighting

MENU button ➔ 📷 photo shooting menu

Preserve details in highlights and shadows, creating pictures with natural contrast. Use for high-contrast scenes, for example when photographing brightly-lit outdoor scenery through a door or window or taking pictures of shaded subjects on a sunny day. Active D-Lighting is most effective when used with matrix metering.

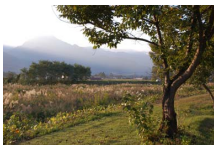

[Off]



[A Auto]

Option		Description
📷 A	[Auto]	The camera automatically adjusts Active D-Lighting in response to shooting conditions.
📷 H <sup>+</sup>	[Extra high]	Choose the amount of Active D-Lighting performed from [Extra high], [High], [Normal], and [Low].
📷 H	[High]	
📷 N	[Normal]	
📷 L	[Low]	
📷 OFF	[Off]	Active D-Lighting off.

The option currently selected is shown in the display during shooting.

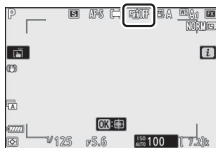

---

### ✓ Active D-Lighting

- “Noise” in the form of randomly-spaced bright pixels, fog, or lines may appear in photos taken with Active D-Lighting.
  - In mode **M**, [A Auto] is equivalent to [N Normal].
  - Uneven shading may be visible with some subjects.
  - This function does not apply at high ISO sensitivities (Hi 0.3–Hi 1.0), including high sensitivities selected via auto ISO sensitivity control.
-

# Long Exposure NR

MENU button ➔ 📷 photo shooting menu

Reduce “noise” (bright spots or fog) in photographs taken at slow shutter speeds.

Option	Description
[On]	Reduce noise in photographs taken at shutter speeds slower than 1 s.
[Off]	Long-exposure noise reduction disabled.

Long-exposure noise reduction is performed after the photo is taken.

During processing, [**Performing noise reduction**] will appear in the shooting display. Pictures cannot be taken until the message has cleared from the display. The time required to process photos after shooting roughly doubles.

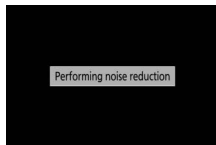

## ✔ Long-Exposure Noise Reduction

If the camera is turned off before processing is complete, the picture will be saved but noise reduction will not be performed.

## High ISO NR

MENU button →  photo shooting menu

Photographs taken at high ISO sensitivities can be processed to reduce “noise” (randomly-spaced bright pixels).

Option	Description
[High]	Reduce noise in photographs taken at all ISO sensitivities. The higher the sensitivity, the greater the effect. Choose the amount of noise reduction performed from [High], [Normal], and [Low].
[Normal]	
[Low]	
[Off]	Noise reduction is performed only as required. The amount of noise reduction performed is always lower than when [Low] is selected.

# Vignette Control

MENU button ➔  photo shooting menu

Vignette control reduces “vignetting”—a drop in brightness at the edges of a photograph—by an amount that varies from lens to lens. Its effects are most noticeable at maximum aperture.

Option	Description
<input type="checkbox"/> H	[High]
<input type="checkbox"/> N	[Normal]
<input type="checkbox"/> L	[Low]
[Off]	Vignette control disabled.

## Vignette Control

Depending on the scene, shooting conditions, and type of lens, JPEG images may exhibit “noise” (fog) or over-processing at the edge of the frame that introduces variations in peripheral brightness. In addition, custom Picture Controls and preset Picture Controls that have been modified from default settings may not produce the desired effect. Take test shots and view the results in the monitor.

## Diffraction Compensation

MENU button →  photo shooting menu

Select [**On**] to reduce diffraction at small apertures (high f-numbers).

## Auto Distortion Control

MENU button →  photo shooting menu

Select [**On**] as required to reduce barrel distortion when shooting with wide-angle lenses and to reduce pin-cushion distortion when shooting with long lenses. Note that [**On**] may be selected automatically with some lenses, in which case this item will be grayed out and unavailable.

# Flicker Reduction Shooting

MENU button ➔  photo shooting menu

When [**On**] is selected, reduce the effects of flicker from such light sources as fluorescent or mercury-vapor lamps.

- Flicker can cause uneven exposure or (in photographs taken in continuous release modes) inconsistent exposure or coloration.
- Note that the frame rate for burst shooting may drop or become erratic when [**On**] is selected.

---

## Flicker Reduction Shooting in the Photo Shooting Menu

- Depending on the light source, flicker reduction may slightly delay shutter response.
- Flicker reduction can detect flicker at 100 and 120 Hz (associated respectively with AC power supplies of 50 and 60 Hz). The desired results may not be achieved if the frequency of the power supply changes during burst photography.
- Flicker may not be detected or the desired results may not be achieved depending on the light source and shooting conditions, for example with scenes that are brightly lit or feature dark backgrounds.
- The desired results may also not be achieved with decorative lighting displays and other non-standard lighting.

## ✓ [Flicker Reduction Shooting] in the Photo Shooting Menu: Restrictions

The [Flicker reduction shooting] item in the photo shooting menu does not take effect under some conditions, including when:

- [On] is selected for [Silent photography] in the photo shooting menu
  - [On] is selected for [Silent photography] in the respective sub-menu during interval-timer photography, time-lapse movie recording, or focus shift
  - HDR is enabled
  - Exposure delay mode is on
- 

## Metering

MENU button ➡  photo shooting menu

Metering determines how the camera sets exposure. For more information, see “The **i** Menu” under “Metering” (📖 140).



# Flash Control

MENU button ➔  photo shooting menu

Adjust settings for wireless remote flash units or optional flash units mounted on the camera accessory shoe.

- For information on adjusting settings for optional flash units mounted on the camera accessory shoe, see “On-Camera Flash Photography” (📖 561).
- For information on adjusting settings for wireless remote flash units, see “Remote Flash Photography” (📖 579).

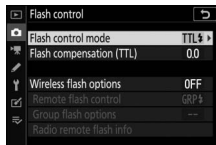

## Flash Control Mode

Choose a flash control mode and flash level and adjust other settings for SB-5000, SB-500, SB-400, or SB-300 flash units mounted on the camera accessory shoe.

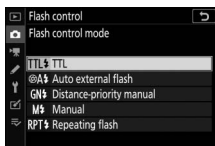

- The options available in the flash control display vary with the option selected for **[Flash control mode]**.
- Settings for flash units other than the SB-5000, SB-500, SB-400, and SB-300 can only be adjusted using flash unit controls.
- Settings for an SB-5000 mounted on the accessory shoe can also be adjusted using the controls on the flash unit.

Option	Description
<b>[TTL]</b>	Flash output is adjusted automatically in response to shooting conditions.
<b>[Auto external flash]</b>	Light from the flash is reflected from the subject to an auto external flash sensor and flash output adjusted automatically.
<b>[Distance-priority manual]</b>	Choose the distance to the subject; flash output will be adjusted automatically.
<b>[Manual]</b>	Choose the flash level manually.
<b>[Repeating flash]</b>	The flash fires repeatedly while the shutter is open, producing a multiple-exposure effect.

## Wireless Flash Options

Adjust settings for simultaneous wireless control of multiple remote flash units. This option is available only when an SB-5000 or SB-500 flash unit or a WR-R10 wireless remote controller is mounted on the camera.

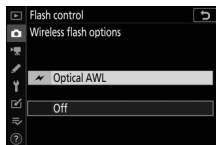

Option		Description
	[Optical AWL]	The remote flash units are controlled using low-intensity flashes emitted by the master flash (☐595).
	[Optical/radio AWL]	Choose this option when using both optically- and radio-controlled flash units (☐606).
	[Radio AWL]	The remote flash units are controlled by radio signals from a WR-R10 attached to the camera (☐581).
[Off]		Remote flash photography disabled.

## Remote Flash Control

Choose the remote flash control mode. Flash options can be adjusted in the flash control display; the options available vary with the option selected for **[Remote flash control]**.

Option	Description
<b>[Group flash]</b>	Choose a separate flash control mode for each group of remote flash units (□ 586, 596).
<b>[Quick wireless control]</b>	Choose the balance between groups A and B and adjust output for group C manually (□ 589, 599).
<b>[Remote repeating]</b>	The flash units fire repeatedly while the shutter is open, producing a multiple-exposure effect (□ 592, 602).

## Radio Remote Flash Info

View the flash units currently controlled via radio AWL.

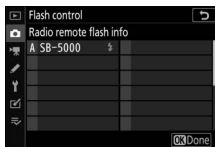

## Flash Mode

MENU button ➔  photo shooting menu

Choose a flash mode for optional flash units. For more information, see “On-Camera Flash Photography” under “Flash Modes” (📖 569).

## Flash Compensation

MENU button ➔  photo shooting menu

Adjust flash output to control the brightness of the main subject relative to the background. Flash output can be increased to make the main subject appear brighter, reduced to prevent glare, or otherwise fine-tuned to produce the desired result (📖 572).

## Focus Mode

MENU button ➔  photo shooting menu

Focus mode controls how the camera focuses. For more information, see “Focus” under “Focus Mode” in “Basic Settings” (📖 63).

## AF-Area Mode

MENU button →  photo shooting menu

Choose how the camera selects the focus point for autofocus. For more information, see “Focus” under “AF-Area Mode” in “Basic Settings” ( 66).

## Vibration Reduction

MENU button →  photo shooting menu

Choose whether to enable vibration reduction. For more information, see “The *i* Menu” under “Vibration Reduction” ( 143).

# Auto Bracketing

MENU button ➔  photo shooting menu

Vary exposure, flash level, Active D-Lighting (ADL), or white balance slightly with each shot, “bracketing” the current value. Bracketing can be used in situations in which getting the right settings is difficult and there is not time to check results and adjust settings with each shot, or to experiment with different settings for the same subject.

Option	Description
[Auto bracketing set]	Choose the setting or settings bracketed when auto bracketing is in effect. <ul style="list-style-type: none"><li>• <b>[AE &amp; flash bracketing]</b>: Perform both exposure and flash-level bracketing.</li><li>• <b>[AE bracketing]</b>: Bracket only exposure.</li><li>• <b>[Flash bracketing]</b>: Perform only flash-level bracketing.</li><li>• <b>[WB bracketing]</b>: Perform white-balance bracketing.</li><li>• <b>[ADL bracketing]</b>: Perform bracketing using Active D-Lighting.</li></ul>
[Number of shots]	Choose the number of shots in the bracketing sequence.
[Increment]	Choose the amount the selected settings vary with each shot when an option other than <b>[ADL bracketing]</b> is selected for <b>[Auto bracketing set]</b> .
[Amount]	Choose how Active D-Lighting varies with each shot when <b>[ADL bracketing]</b> is selected for <b>[Auto bracketing set]</b> .

# Exposure and Flash Bracketing



No exposure compensation



Exposure modified by: -1 EV





Exposure modified by: +1 EV

## 1 Select [AE & flash bracketing], [AE bracketing], or [Flash bracketing] for [Auto bracketing set].

[Number of shots] and [Increment] options will be displayed.

## 2 Choose the number of shots.

- Highlight [Number of shots] and press  or  to choose the number of shots in the bracketing sequence.



- At settings other than [OF], a bracketing icon will appear in the display.

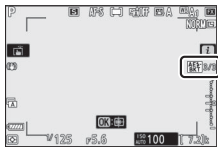



### 3 Select an exposure increment.

- Highlight [**Increment**] and press or to choose the bracketing increment.
- When [**1/3 step**] is selected for Custom Setting b1 [**EV steps for exposure ctrl**], the size of the increment can be chosen from 0.3 (1/3), 0.7 (2/3), 1.0, 2.0, and 3.0 EV. Bracketing programs with an increment of 2.0 or 3.0 EV offer a maximum of 5 shots. If a value of 7 or 9 was selected in Step 2, the number of shots will automatically be set to 5.
- The bracketing programs with an increment of 0.3 EV are listed below.

[Number of shots]	Exposure and flash bracketing indicator	No. of shots	Bracketing order (EVs)
<b>0F</b>	-.....0.....+	0	0
<b>+3F</b>	-.....0 <sub>;</sub> .....+	3	0/+0.3/+0.7
<b>-3F</b>	-.....0 <sub>;</sub> .....+	3	0/-0.7/-0.3
<b>+2F</b>	-.....0 <sub>;</sub> .....+	2	0/+0.3
<b>-2F</b>	-.....0 <sub>;</sub> .....+	2	0/-0.3
<b>3F</b>	-.....0 <sub>;</sub> .....+	3	0/-0.3/+0.3
<b>5F</b>	-.....0 <sub>;</sub> .....+	5	0/-0.7/-0.3/+0.3/+0.7
<b>7F</b>	-.....0 <sub>;</sub> .....+	7	0/-1.0/-0.7/-0.3/ +0.3/+0.7/+1.0
<b>9F</b>	-.....0 <sub>;</sub> .....+	9	0/-1.3/-1.0/-0.7/-0.3/ +0.3/+0.7/+1.0/+1.3

## 4 Take pictures.

- Take the number of pictures in the bracketing program.
- The modified values for shutter speed and aperture are shown in the display.
- While bracketing is in effect, the display shows a bracketing icon, a bracketing progress indicator, and the number of shots remaining in the bracketing sequence. After each shot, a segment will disappear from the indicator and the number of shots remaining will be reduced by one.

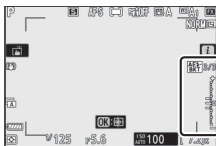

No. shots: 3  
Increment: 0.7

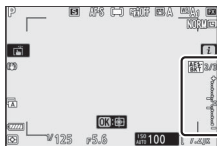

Display after first shot

- Exposure changes due to bracketing are added to those made with exposure compensation.

## ■ Cancelling Bracketing

To cancel bracketing, select **[0F]** for **[Number of shots]**.

---

## ✓ Bracketing Options

When [**AE & flash bracketing**] is selected, the camera varies both exposure and flash level. Select [**AE bracketing**] to vary only exposure, [**Flash bracketing**] to vary only flash level. Note that flash bracketing is available in i-TTL and, where supported, auto aperture (⊕A) flash control modes only (□□565, 640).

## ✓ Exposure and Flash Bracketing

- In continuous release modes, shooting will pause after the number of shots specified in the bracketing program have been taken. Shooting will resume the next time the shutter-release button is pressed.
- If the camera is turned off before all shots in the sequence have been taken, bracketing will resume from the first shot in the sequence when the camera is turned on.
- If the memory card fills before all shots in the sequence have been taken, shooting can be resumed from the next shot in the sequence after the memory card has been replaced.

## ✔ Exposure Bracketing

The settings (shutter speed and/or aperture) altered during exposure bracketing vary with the shooting mode.

Mode	Setting
<b>P</b>	Shutter speed and aperture <sup>1</sup>
<b>S</b>	Aperture <sup>1</sup>
<b>A</b>	Shutter speed <sup>1</sup>
<b>M</b>	Shutter speed <sup>2,3</sup>



- 1 If **[On]** is selected for **[ISO sensitivity settings] > [Auto ISO sensitivity control]** in the photo shooting menu, the camera will automatically vary ISO sensitivity for optimum exposure when the limits of the camera exposure system are exceeded.
  - 2 If **[On]** is selected for **[ISO sensitivity settings] > [Auto ISO sensitivity control]** in the photo shooting menu, the camera will first use auto ISO sensitivity control to bring exposure as close as possible to the optimum and then bracket this exposure by varying shutter speed.
  - 3 Use Custom Setting e6 **[Auto bracketing (mode M)]** to choose whether the camera varies shutter speed, aperture, or both shutter speed and aperture.
-

# White Balance Bracketing

## 1 Select [WB bracketing] for [Auto bracketing set].



[Number of shots] and [Increment] options will be displayed.

## 2 Choose the number of shots.

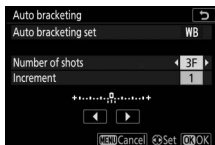
- Highlight [Number of shots] and press  or  to choose the number of shots in the bracketing sequence.
- At settings other than [0F], a bracketing icon will appear in the display.



### 3 Select a white balance increment.

- Highlight [**Increment**] and press  or  to choose the bracketing increment.
- The size of the increment can be chosen from 1 (1 step), 2 (2 steps), or 3 (3 steps).
- Each step is equivalent to 5 mired. Higher “A” values correspond to increased amounts of amber. Higher “B” values correspond to increased amounts of blue.
- The bracketing programs with an increment of 1 are listed below.

[Number of shots]	White balance bracketing indicator	No. of shots	White balance increment	Bracketing order
<b>0F</b>	+.....0.....+	0	1	0
<b>B3F</b>	+.....0.....+	3	1B	0/B1/B2
<b>A3F</b>	+.....0.....+	3	1A	0/A2/A1
<b>B2F</b>	+.....0.....+	2	1B	0/B1
<b>A2F</b>	+.....0.....+	2	1A	0/A1
<b>3F</b>	+.....0.....+	3	1A, 1B	0/A1/B1
<b>5F</b>	+.....0.....+	5	1A, 1B	0/A2/A1/B1/B2
<b>7F</b>	+.....0.....+	7	1A, 1B	0/A3/A2/A1/B1/B2/B3
<b>9F</b>	+.....0.....+	9	1A, 1B	0/A4/A3/A2/A1/B1/B2/B3/B4

---

## 4 Take pictures.

- Each shot will be processed to create the number of copies specified in the bracketing program, and each copy will have a different white balance.
- Modifications to white balance are added to the white balance adjustment made with white balance fine-tuning.
- If the number of shots in the bracketing program is greater than the number of exposures remaining, the shutter release will be disabled. Shooting can begin when a new memory card is inserted.

### ■ Cancelling Bracketing

To cancel bracketing, select **[OF]** for **[Number of shots]**.

---

#### ✔ White Balance Bracketing Restrictions

White balance bracketing is not available at image quality settings of NEF (RAW) or NEF (RAW) + JPEG.



#### ✔ White Balance Bracketing

- White balance bracketing affects only color temperature (the amber–blue axis in the white balance fine-tuning display). No adjustments are made on the green–magenta axis.
  - If the camera is turned off while the memory card access lamp is lit, the camera will power off only after all photographs in the sequence have been recorded.
  - In self-timer mode, the number of copies specified in Step 2 of “White Balance Bracketing” (□275) will be created each time the shutter is released, regardless of the option selected for Custom Setting c2 **[Self-timer]** > **[Number of shots]**.
-

# ADL Bracketing

- 1 Select **[ADL bracketing]** for **[Auto bracketing set]**.  
**[Number of shots]** and **[Amount]** options will be displayed.

- 2 Choose the number of shots.

- Highlight **[Number of shots]** and press  or  to choose the number of shots in the bracketing sequence.
- At settings other than **[OF]**, a bracketing icon will appear in the display.

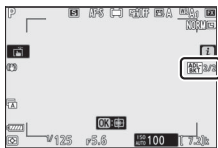
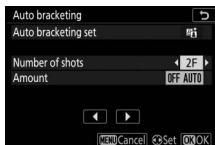

- The number of shots determines the bracketing sequence:



No. of shots	Bracketing sequence
2	<b>[Off]</b> → Value selected in Step 3
3	<b>[Off]</b> → <b>[Low]</b> → <b>[Normal]</b>
4	<b>[Off]</b> → <b>[Low]</b> → <b>[Normal]</b> → <b>[High]</b>
5	<b>[Off]</b> → <b>[Low]</b> → <b>[Normal]</b> → <b>[High]</b> → <b>[Extra high]</b>

- If you chose more than two shots, proceed to Step 4.



---

### 3 If you selected 2 shots, choose the Active D-Lighting amount.

- When the number of shots is 2, the Active D-Lighting setting for the second shot can be selected by highlighting **[Amount]** and pressing  or .
- The following options are available.

[Amount]	Bracketing sequence
OFF L	[Off] → [Low]
OFF N	[Off] → [Normal]
OFF H	[Off] → [High]
OFF H+	[Off] → [Extra high]
OFF AUTO	[Off] → [Auto]

---

### 4 Take pictures.

- Take the number of pictures in the bracketing program.
- While bracketing is in effect, the display shows an ADL bracketing icon and the number of shots remaining in the bracketing sequence. After each shot, the number of shots remaining will be reduced by one.



### ■ Cancelling ADL Bracketing

To cancel bracketing, select **[OF]** for **[Number of shots]**.

---

### ✓ **ADL Bracketing**



- In continuous release modes, shooting will pause after the number of shots specified in the bracketing program have been taken. Shooting will resume the next time the shutter-release button is pressed.
  - If the camera is turned off before all shots in the sequence have been taken, bracketing will resume from the first shot in the sequence when the camera is turned on.
  - If the memory card fills before all shots in the sequence have been taken, shooting can be resumed from the next shot in the sequence after the memory card has been replaced.
-

# Multiple Exposure

MENU button ➔  photo shooting menu

Record two to ten NEF (RAW) exposures as a single photograph.

Option	Description
<b>[Multiple exposure mode]</b>	<ul style="list-style-type: none"><li>• <b>[On (series)]</b>: Take a series of multiple exposures. To end multiple exposure photography, select <b>[Multiple exposure mode]</b> again and choose <b>[Off]</b>.</li><li>• <b>[On (single photo)]</b>: Create one multiple exposure.</li><li>• <b>[Off]</b>: End multiple exposure photography.</li></ul>
<b>[Number of shots]</b>	Choose the number of exposures that will be combined to form a single photograph.

Option	Description
<p>[Overlay mode]</p>	<ul style="list-style-type: none"> <li>• <b>[Add]</b>: The exposures are overlaid without modification; gain is not adjusted.</li> <li>• <b>[Average]</b>: Gain is adjusted before the exposures are overlaid. The gain for each exposure is equal to 1 divided by the total number of exposures taken. For example, in a photo made by combining two exposures, the gain for each exposure will be set to <math>1/2</math>, while in a photo combining three exposures, gain will be set to <math>1/3</math>.</li> <li>• <b>[Lighten]</b>: The camera compares the pixels in each exposure and uses only the brightest.</li> </ul>  <ul style="list-style-type: none"> <li>• <b>[Darken]</b>: The camera compares the pixels in each exposure and uses only the darkest.</li> </ul> 
<p>[Save individual images (NEF)]</p>	<ul style="list-style-type: none"> <li>• <b>[On]</b>: Save both the multiple exposure and the shots that make it up; the pictures are saved in NEF (RAW) format.</li> <li>• <b>[Off]</b>: Discard the individual shots and save only the multiple exposure.</li> </ul>

Option	Description
[ <b>Overlay shooting</b> ]	<ul style="list-style-type: none"> <li>• [<b>On</b>]: Earlier exposures are superimposed on the view through the lens. The earlier exposures aid composition of the next shot.</li> <li>• [<b>Off</b>]: Earlier exposures are not displayed while shooting is in progress.</li> </ul>
[ <b>Select first exposure (NEF)</b> ]	Choose the first exposure from the NEF (RAW) images on the memory card.

# Creating a Multiple Exposure

- 1 Highlight [Multiple exposure] in the photo shooting menu and press** .

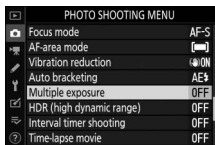

- 2 Choose an option for [Multiple exposure mode].**

- Highlight [**Multiple exposure mode**] and press .
- Highlight a multiple exposure mode using or and press .
- If [**On (series)**] or [**On (single photo)**] is selected, an icon will appear in the display.

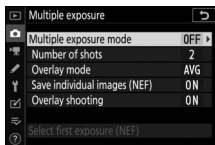



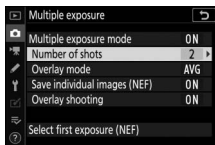

- 3 Choose a value for [Number of shots] (number of exposures).**

- Highlight [**Number of shots**] and press .
- Choose the number of exposures using or and press .



---



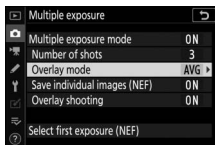

## 4 Choose an option for [Overlay mode].

- Highlight [**Overlay mode**] and press .
- Highlight an option using  or  and press .





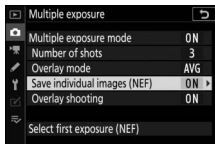

---

## 5 Choose a setting for [Save individual images (NEF)].

- Highlight [**Save individual images (NEF)**] and press .
- Highlight an option using  or  and press .
- To save both the multiple exposure and the shots that make it up, select [**On**]; the individual shots are saved in NEF (RAW) format. To save only the multiple exposure, select [**Off**].



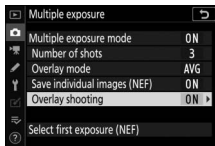

## 6 Choose an option for [Overlay shooting].

- Highlight [Overlay shooting] and press .
- Highlight an option using  or  and press .
- Select [On] to superimpose earlier exposures on the view through the lens. You can use the earlier exposures as a guide when composing subsequent shots.



## 7 Choose an option for [Select first exposure (NEF)].

- To choose the first exposure from existing NEF (RAW) photos, highlight [Select first exposure (NEF)] and press .
- Use the multi selector to highlight the desired picture.
- To view the highlighted picture full screen, press and hold the  button.
- After highlighting the desired picture, press .





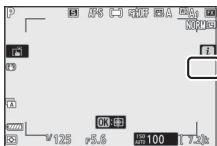

## 8 Start shooting.

- Take the selected number of shots.  
If you used [**Select first exposure (NEF)**] to select an existing NEF (RAW) image as the first exposure in Step 7, shooting will start from the second exposure.
- Once you have taken the selected number of shots, the pictures will be overlaid to create a multiple exposure. Multiple exposures are recorded in JPEG format regardless of the option selected for image quality.
- If [**On (series)**] is selected for [**Multiple exposure mode**], you can continue to take additional multiple exposures until [**Off**] is selected.
- If [**On (single photo)**] is selected, the camera will exit multiple exposure mode once the number of shots selected in Step 3 has been taken.



## ■ The *i* Menu

Pictures can be viewed by pressing the  button while a multiple exposure is in progress. The most recent shot in the current multiple exposure is indicated by a  icon; pressing the *i* button when this icon is present displays the multiple exposure *i* menu.

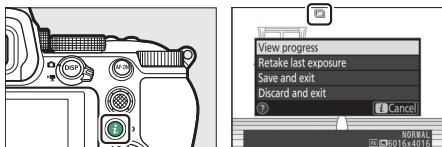

- Highlight items and press  to select.
- You can also have the option of using touch controls after pressing the *i* button.

Option	Description
[View progress]	View a preview created from the exposures recorded to the current point.
[Retake last exposure]	Retake the most recent exposure.
[Save and exit]	Create a multiple exposure from the exposures taken to current point.
[Discard and exit]	Exit without recording a multiple exposure. <ul style="list-style-type: none"><li>• If [On] is selected for [Save individual images (NEF)], the individual exposures will be saved separately.</li></ul>

---

## ✓ Multiple Exposure

- If you use the menus or view pictures in the display while shooting a multiple exposure, remember that shooting will end and the multiple exposure will be recorded if no operations are performed for about 40 seconds (or in the case of menus, about 90 seconds). The time available to record the next exposure can be extended by choosing longer times for Custom Setting c3 [**Power off delay**] > [**Playback**] or [**Menus**].
- Multiple exposures may be affected by “noise” in the form of randomly-spaced bright pixels, fog, or lines.
- In continuous shooting modes, the camera records all exposures in a single burst. If [**On (single photo)**] is selected, multiple exposure shooting will end after the first multiple exposure is recorded. If [**On (series)**] is selected, an additional multiple exposure will be recorded each time the shutter-release button is pressed.
- In self-timer mode, the interval between each shot in the exposure is selected using Custom Setting c2 [**Self-timer**] > [**Interval between shots**]. Regardless of the value selected for the c2 [**Number of shots**] option, shooting will however end after the number of shots selected for the multiple exposure.
- Multiple exposures may end if settings are changed while shooting is in progress.
- Shooting settings and photo info for multiple exposure photographs are those for the first exposure.
- Do not remove or replace the memory card while a multiple exposure is in progress.
- Memory cards cannot be formatted while a multiple exposure is in progress. Some menu items will be grayed out and unavailable.

## ✔ **Multiple Exposure: Restrictions**

Multiple exposure cannot be combined with some camera features, including:

- modes other than **P**, **S**, **A**, and **M**,
  - movie recording,
  - bracketing,
  - HDR (high dynamic range),
  - interval-timer photography,
  - time-lapse movie recording, and
  - focus shift
- 

## ■ **Ending Multiple Exposures**

To end a multiple exposure before the specified number of exposures have been taken, select **[Off]** for multiple exposure mode. A multiple exposure will be created from the exposures that have been recorded to that point (if **[Average]** is selected for **[Overlay mode]**, gain will be adjusted to reflect the number of exposures actually recorded).

The multiple exposure will also end if:

- the standby timer expires after the first exposure has been taken, or
- you press the **[▶]** button followed by the **[i]** button and select either **[Save and exit]** or **[Discard and exit]**

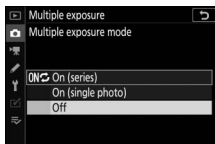

# HDR (High Dynamic Range)

MENU button ➔  photo shooting menu

Used with high contrast subjects, High Dynamic Range (HDR) preserves details in highlights and shadows by combining two shots taken at different exposures. Use with high-contrast scenes and other subjects to preserve a wide range of details, from highlights to shadows.



Option	Description
[HDR mode]	<ul style="list-style-type: none"><li>• <b>[On (series)]</b>: Take a series of HDR photographs. To end HDR photography, select <b>[HDR mode]</b> again and choose <b>[Off]</b>.</li><li>• <b>[On (single photo)]</b>: Take a single HDR photograph.</li><li>• <b>[Off]</b>: End HDR photography.</li></ul>
[Exposure differential]	Choose the difference in exposure between the two shots. The higher the value, the greater the dynamic range. If <b>[Auto]</b> is selected, the camera will automatically adjust the exposure differential to suit the scene.
[Smoothing]	Choose how much the boundaries between the two images are smoothed.
[Save individual images (NEF)]	Choose <b>[On]</b> to save each of the individual shots used to create the HDR image; the shots are saved in NEF (RAW) format.

# Taking HDR Photographs

We recommend that you use the matrix metering option when shooting with HDR.

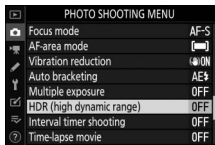

## 1 Highlight [HDR (high dynamic range)] in the photo shooting menu and press .



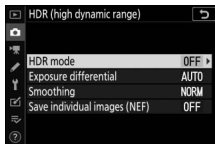

## 2 Select an [HDR mode].

- Highlight [HDR mode] and press .

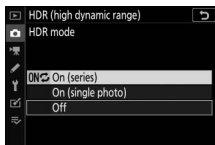

- Highlight one of the following options using  or  and press .



Option		Description
	[On (series)]	Take a series of HDR photographs. HDR shooting will continue until you select [Off] for [HDR mode].
	[On (single photo)]	Normal shooting will resume after you have taken a single HDR photograph.
	[Off]	Proceed without taking additional HDR photographs.

- If **[On (series)]** or **[On (single photo)]** is selected, an icon will appear in the display.



### 3 Choose a value for [Exposure differential].



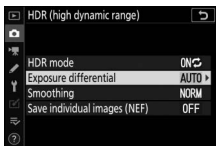

- Highlight **[Exposure differential]** and press **OK**.

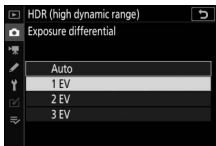

- Highlight an option using **▲** or **▼** and press **OK**.
- Choose higher values for high-contrast subjects.
- Note, however, that choosing a higher value than required may not produce the desired results. Match your choice to the level of contrast in the scene.
- If **[Auto]** is selected, the camera will automatically adjust the exposure differential to suit the scene.





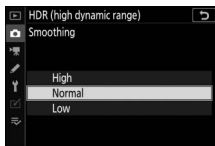
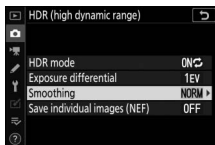

## 4 Adjust [Smoothing].

- Highlight [Smoothing] and press .
- Highlight an option using  or  and press ; the selected option represents the amount the boundaries between the two images are smoothed.
- Higher values produce a smoother composite image.



## 5 Choose a setting for [Save individual images (NEF)].

- Highlight [Save individual images (NEF)] and press .
- Highlight an option using  or  and press .
- Choose [On] to save each of the individual shots used to create the HDR image; the shots are saved in NEF (RAW) format.

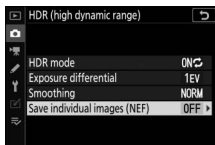



---

## 6 Frame the photograph, focus, and shoot.

- The camera takes two exposures when the shutter-release button is pressed all the way down.
- If [**On (series)**] is selected for [**HDR mode**], you can continue to take HDR photographs until [**Off**] is selected.
- If [**On (single photo)**] is selected, HDR will turn off automatically after a single shot.
- HDR photographs are recorded in JPEG format regardless of the option selected for image quality.

---

## ✓ HDR Photography

- The edges of the image will be cropped out.
- The desired results may not be achieved if the camera or subject moves during shooting. Use of a tripod is recommended.
- Depending on the scene, you may notice shadows around bright objects or halos around dark objects. This can be mitigated using [**Smoothing**].
- Uneven shading may be visible with some subjects.
- With spot or center-weighted metering, an [**Exposure differential**] of [**Auto**] is equivalent to [**2 EV**].
- Optional flash units will not fire.
- In continuous release modes, only one photograph will be taken each time the shutter-release button is pressed all the way down.
- Shutter speeds of "**Bulb**" and "**Time**" are not available.

## ✓ HDR Restrictions

HDR cannot be combined with some camera features, including:

- modes other than **P**, **S**, **A**, and **M**,
  - flicker reduction,
  - bracketing,
  - multiple exposures,
  - interval-timer photography,
  - time-lapse movie recording, and
  - focus shift
-

# Interval Timer Shooting

MENU button ➔  photo shooting menu

Take photographs at the selected interval until the specified number of shots has been recorded. When using the interval timer, select a release mode other than .

Option	Description
[Start]	Start interval timer shooting. Shooting will begin either after 3 s ([ <b>Now</b> ] selected for [ <b>Choose start day/time</b> ]) or at a selected date and time ([ <b>Choose day/time</b> ]). Shooting will continue at the selected interval until all shots have been taken.
[Choose start day/time]	Choose a start option. Select [ <b>Now</b> ] to start shooting immediately, [ <b>Choose day/time</b> ] to start shooting at a chosen date and time.
[Interval]	Specify the interval between shots in hours, minutes, and seconds.
[Intervalsx shots/interval]	Choose the number of intervals and the number of shots per interval.
[Exposure smoothing]	Selecting [ <b>On</b> ] allows the camera to adjust exposure to match the previous shot. <ul style="list-style-type: none"><li>• Large changes in subject brightness during shooting may result in apparent variations in exposure. This can be addressed by shortening the interval between shots.</li><li>• Exposure smoothing will not take effect in mode <b>M</b> if [<b>Off</b>] is selected for [<b>ISO sensitivity settings</b>] &gt; [<b>Auto ISO sensitivity control</b>] in the photo shooting menu.</li></ul>

Option	Description
[Silent photography]	<p>Select <b>[On]</b> to silence the shutter and eliminate the vibrations it produces during shooting.</p> <ul style="list-style-type: none"> <li>• Selecting <b>[On]</b> does not completely silence the camera. Camera sounds may still be audible, for example during autofocus or aperture adjustment, in the latter case most noticeably at apertures smaller (i.e., at f-numbers higher) than f/5.6.</li> </ul>
[Interval priority]	<ul style="list-style-type: none"> <li>• <b>[On]</b>: Enable interval priority to ensure that frames shot in modes <b>P</b> and <b>A</b> are taken at the chosen interval. <ul style="list-style-type: none"> <li>- Select <b>[Release]</b> for Custom Setting a2 <b>[AF-S priority selection]</b> when <b>AF-S</b> is selected for focus mode and for Custom Setting a1 <b>[AF-C priority selection]</b> when <b>AF-C</b> is selected.</li> <li>- The time selected for <b>[ISO sensitivity settings]</b> &gt; <b>[Auto ISO sensitivity control]</b> &gt; <b>[Minimum shutter speed]</b> should be shorter than the interval.</li> </ul> </li> <li>• <b>[Off]</b>: Disable interval priority to ensure that photos are correctly exposed.</li> </ul>
[Focus before each shot]	<p>If <b>[On]</b> is selected, the camera will focus between shots.</p>

Option	Description
<b>[Options]</b>	<p>Combine interval-timer photography with other options.</p> <ul style="list-style-type: none"> <li>• <b>[AE bracketing]</b>: Perform exposure bracketing during interval-timer photography.</li> <li>• <b>[Time-lapse movie]</b>: Use the photos taken during interval-timer photography to create a time-lapse movie with an aspect ratio of 16:9. <ul style="list-style-type: none"> <li>- The camera saves both the photos and the time-lapse movie.</li> <li>- Selecting <b>[1:1 (24×24)]</b> for <b>[Choose image area]</b> in the photo shooting menu disables the shutter release.</li> <li>- Movies created using <b>[Time-lapse movie]</b> are recorded in the <b>[sRGB]</b> color space, regardless of the option selected for <b>[Color space]</b> in the photo shooting menu.</li> </ul> </li> <li>• <b>[Off]</b>: Do not perform additional operations during interval-timer photography.</li> </ul>
<b>[Starting storage folder]</b>	<p>Highlight either of the following options and press  to select (<input checked="" type="checkbox"/>) or deselect (<input type="checkbox"/>)</p> <ul style="list-style-type: none"> <li>• <b>[New folder]</b>: A new folder is created for each new sequence.</li> <li>• <b>[Reset file numbering]</b>: File numbering is reset to 0001 whenever a new folder is created.</li> </ul>

# Interval-Timer Photography

## ✓ Before Shooting

- Take a test shot at current settings.
- Before proceeding, select [**Time zone and date**] in the setup menu and make sure that the camera clock is set to the correct time and date.
- To ensure that shooting is not interrupted, use a fully-charged battery, an optional charging AC adapter, or an optional AC adapter and power connector.

## 1 Highlight [Interval timer shooting] in the photo shooting menu.

Press  to select the highlighted item and view interval timer shooting options.

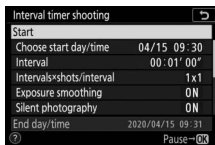
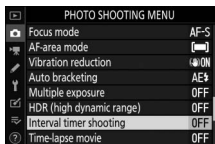

## 2 Adjust interval timer settings.

### • Choose the start day and time.

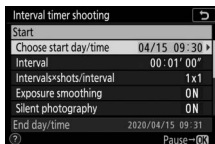

Highlight [**Choose start day/time**] and press .

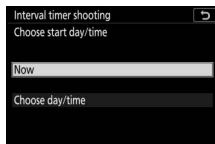

Highlight an option and press .

- To start shooting immediately, select [**Now**].
- To start shooting at a chosen date and time, select [**Choose day/time**]. Choose the date and time and press .

### • Choose the interval between shots.

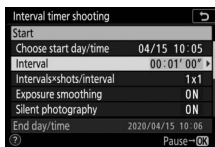

Highlight [**Interval**] and press .

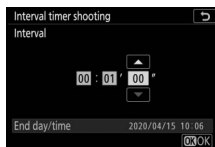

Choose an interval (in hours, minutes, and seconds) and press .

## • Choose the number of shots per interval.

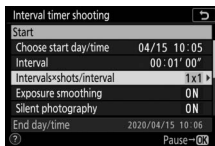

Highlight  
[**Intervals×shots/  
interval**] and press

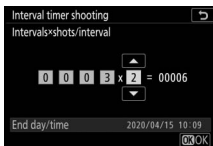

Choose the number of  
intervals and the  
number of shots per  
interval and press

- In single frame release mode, the photographs for each interval will be taken at the rate for continuous high-speed release mode.
- When [**Off**] is selected for [**Silent photography**], the maximum number of intervals will vary with the number of shots per interval.

## • Enable or disable exposure smoothing.

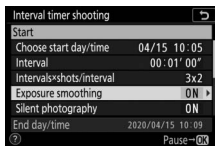

Highlight [**Exposure  
smoothing**] and press

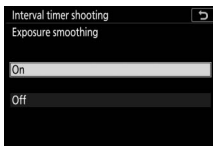

Highlight an option and  
press

- Selecting [**On**] allows the camera to adjust exposure to match the previous shot.



- **Enable or disable silent photography.**

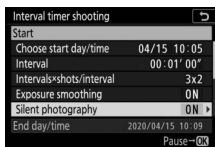

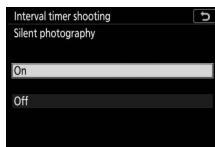

Highlight [**Silent photography**] and press .



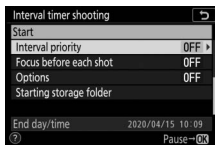

Highlight an option and press .

- **Choose an interval priority option.**



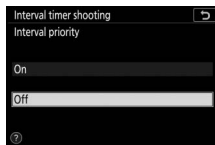

Highlight [**Interval priority**] and press .



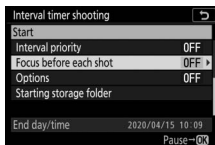

Highlight an option and press .

- **Choose whether the camera focuses between shots.**

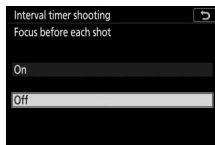

Highlight [**Focus before each shot**] and press .



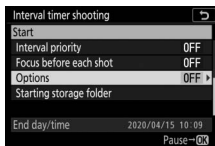

Highlight an option and press .

- **Choose additional options.**

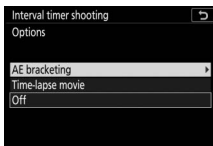

Highlight [**Options**] and press .



Highlight [**AE bracketing**] or [**Time-lapse movie**] and press .

- If you selected [**AE bracketing**], choose values for [**Number of shots**] and [**Increment**]; if you selected [**Time-lapse movie**], choose settings for [**Frame size/frame rate**] and [**Destination**].

- **Choose starting folder options.**

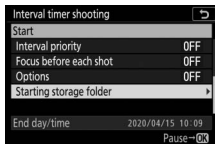

Highlight [**Starting storage folder**] and press .

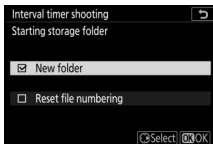

Select the desired options and press  to proceed.

### 3 Highlight [Start] and press .

- If [Now] was selected for [Choose start day/time] in Step 2, shooting will start after three seconds.
- Otherwise shooting will start at the time selected for [Choose start day/time] > [Choose day/time].
- The display turns off during shooting.
- Shooting will continue at the selected interval until all shots have been taken.

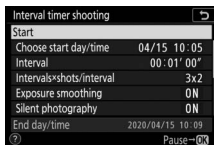

#### During Shooting

- During interval timer photography, the memory card access lamp will flash.
- If the display is turned on by pressing the shutter-release button halfway, the message [Interval timer shooting] will be displayed and the  icon will flash.

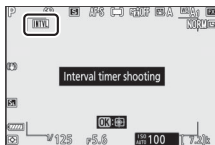
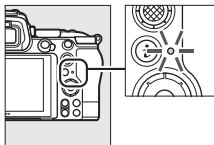

## ■ Pausing Interval-Timer Photography

Interval-timer photography can be paused between intervals by pressing **OK** or by selecting [**Interval timer shooting**] in the photo shooting menu, highlighting [**Pause**], and pressing **OK**. Note that the menus may not be displayed when the **MENU** button is pressed if the time selected for [**Interval**] is very short.

- If [**Time-lapse movie**] is selected for [**Options**], pressing **OK** between intervals will end interval-timer photography.

## ■ Resuming Interval Timer Shooting

Interval timer shooting can be resumed as described below.

- **To resume shooting immediately:**

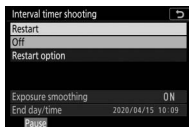

Highlight [**Restart**] and press **OK**.

- **To resume shooting at a specified time:**

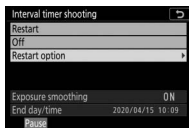

Select [**Restart option**], highlight [**Choose day/time**] and press **OK**.

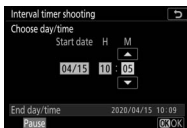

Choose a starting date and time and press **OK**.

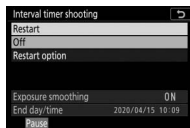

Highlight [**Restart**] and press **OK**.

## ■ ■ Ending Interval Timer Shooting

To end interval-timer photography before all the photos are taken, select [**Interval timer shooting**] in the photo shooting menu, highlight [**Off**], and press **OK**. Note that the menus may not be displayed when the **MENU** button is pressed if the time selected for [**Interval**] is very short. In this case you will need to press **OK** to pause interval-timer photography and then select [**Interval timer shooting**] in the photo shooting menu, highlight [**Off**], and press **OK**.

## ✓ Interval-Timer Photography

- Choose an interval longer than the time needed to take the selected number of shots at the predicted shutter speed. Note that during actual interval-timer photography, the camera must not only take shots at the selected interval but must also have sufficient time to complete the exposures and perform such tasks as processing the photographs. If the interval is too short to take the selected number of photos, the camera may skip to the next interval without shooting.
- If the interval is too short, the total number of shots taken may be less than that selected for **[Intervalsxshots/interval]**.
- If you are using a flash, choose an interval longer than the time needed for the flash to charge. If the interval is too short, the flash may fire at less than the power needed for full exposure.
- If shooting cannot proceed at current settings—for example, if shutter speed is set to “**Bulb**” or “**Time**”, the **[Interval]** is **[00:00'00”]**, or the start time is in less than a minute—a warning will be displayed in the monitor.
- Interval-timer photography will not start if **[On]** is selected for both **[Silent photography]** and **[Interval priority]** and **[00:00'0.5”]** is selected for **[Interval]**.
- If **[On]** is selected for **[Silent photography]** or **[Time-lapse movie]** is selected for **[Options]**, the standby timer will not expire during interval-timer photography, regardless of the option selected for Custom Setting c3 **[Power off delay] > [Standby timer]**.
- If the memory card is full, the interval timer will remain active but no pictures will be taken. Insert another memory card and resume shooting (☐306).

- Interval timer shooting will pause if:
  - The camera is turned off and then on again (when the camera is off, batteries and memory cards can be replaced without ending interval-timer photography)
  -  is selected for release mode
- Changing camera settings while the interval timer is active may cause shooting to end.

### **Release Mode**

Regardless of the release mode selected, the camera will take the specified number of shots at each interval.

### **Adjusting Settings Between Shots**

Pictures can be viewed and shooting and menu settings adjusted between shots. Note, however, that the monitor will turn off and shooting will resume a few seconds before the next shot is taken.

### **Interval-Timer Photography: Restrictions**

Interval-timer photography cannot be combined with some camera features, including:

- movie recording,
- long time-exposures ("**Bulb**" or "**Time**"),
- the self-timer,
- bracketing,
- HDR (high dynamic range),
- multiple exposures, and
- focus shift

### ✔ **When [On] Is Selected for [Silent Photography]**

Selecting [On] for [Silent photography] disables some camera features, including:

- ISO sensitivities of Hi 0.3 through Hi 1.0,
- flash photography,
- long-exposure noise reduction, and
- flicker reduction.

### ✔ **Interval Timer Settings**

Turning the camera off or selecting a new release mode does not affect interval-timer photography settings.

---



# Time-Lapse Movie

MENU button ➔  photo shooting menu

The camera automatically takes photos at selected intervals to create a time-lapse movie.

Option	Description
[Start]	Start time-lapse recording. Shooting starts after about 3 s and continues at the interval selected for [Interval] for the time selected for [Shooting time].
[Interval]	Choose the interval between shots, in minutes and seconds.
[Shooting time]	Choose how long the camera will continue to take pictures, in hours and minutes.
[Exposure smoothing]	Selecting [On] smooths abrupt changes in exposure. <ul style="list-style-type: none"><li>• Large changes in subject brightness during shooting may result in apparent variations in exposure. This can be addressed by shortening the interval between shots.</li><li>• Exposure smoothing will not take effect in mode <b>M</b> if [Off] is selected for [ISO sensitivity settings] &gt; [Auto ISO sensitivity control] in the photo shooting menu.</li></ul>
[Silent photography]	Select [On] to silence the shutter and eliminate the vibrations it produces during shooting. <ul style="list-style-type: none"><li>• Selecting [On] does not completely silence the camera. Camera sounds may still be audible, for example during autofocus or aperture adjustment, in the latter case most noticeably at apertures smaller (i.e., at f-numbers higher) than f/5.6.</li></ul>

Option	Description
[Choose image area]	Choose the image area for time-lapse movies from [FX] and [DX].
[Frame size/frame rate]	Choose the frame size and rate for the final movie.
[Interval priority]	<ul style="list-style-type: none"> <li>• [On]: Enable interval priority to ensure that frames shot in modes <b>P</b> and <b>A</b> are taken at the chosen interval. <ul style="list-style-type: none"> <li>- Select [Release] for Custom Setting a2 [AF-S priority selection] when <b>AF-S</b> is selected for focus mode and for Custom Setting a1 [AF-C priority selection] when <b>AF-C</b> is selected.</li> <li>- If [On] is selected for [ISO sensitivity settings] &gt; [Auto ISO sensitivity control] and the time chosen for [Minimum shutter speed] is longer than the interval, the time selected for the interval will take priority over the selected shutter speed.</li> </ul> </li> <li>• [Off]: Disable interval priority to ensure that photos are correctly exposed.</li> </ul>
[Focus before each shot]	If [On] is selected, the camera will focus between shots.
[Destination]	Choose the slot used to record time-lapse movies when two memory cards are inserted.

# Recording Time-Lapse Movies

## ✓ Before Shooting

- Time-lapse movies are shot using the movie crop.
- Take test shots and check the results in the monitor.
- Before proceeding, select **[Time zone and date]** in the setup menu and make sure that the camera clock is set to the correct time and date.
- To ensure that shooting is not interrupted, use a fully-charged battery, an optional charging AC adapter, or an optional AC adapter and power connector.

## 1 Highlight [Time-lapse movie] in the photo shooting menu.

Press  to select the highlighted item and view the **[Time-lapse movie]** menu.

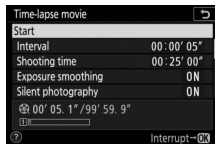
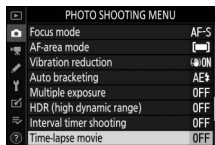

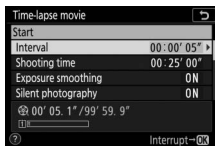

## 2 Adjust time-lapse movie settings.

- Choose the interval between shots.

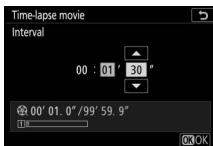

Highlight [**Interval**] and press .



Choose an interval (in minutes and seconds) and press .

- Choose an interval longer than the slowest anticipated shutter speed.

- Choose the total shooting time.

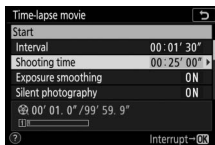

Highlight [**Shooting time**] and press .

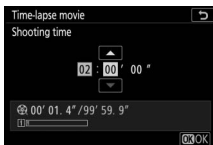

Choose a shooting time (in hours and minutes) and press .

- The maximum shooting time is 7 hours and 59 minutes.

- **Enable or disable exposure smoothing.**

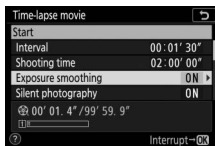

Highlight [**Exposure smoothing**] and press

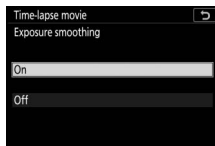

Highlight an option and press .

- Selecting [**On**] smooths abrupt changes in exposure.

- **Enable or disable silent photography.**

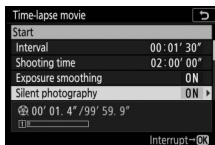

Highlight [**Silent photography**] and press

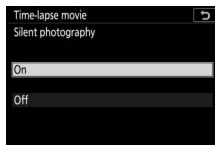

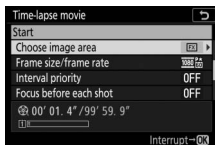

Highlight an option and press .

- **Choose the image area.**

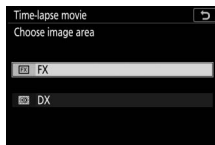

Highlight [**Choose image area**] and press



Highlight an option and press .

- Choose the frame size and rate.

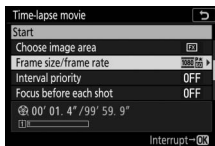

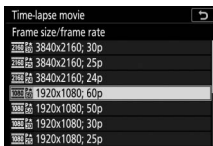

Highlight [**Frame size/  
frame rate**] and press

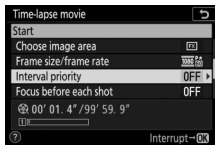

Highlight an option and  
press **OK**.

- Choose an interval priority option.



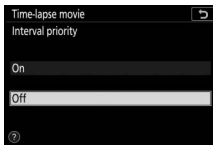

Highlight [**Interval  
priority**] and press .



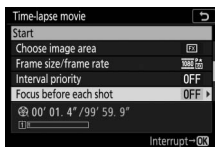

Highlight an option and  
press **OK**.

- **Choose whether the camera focuses between shots.**

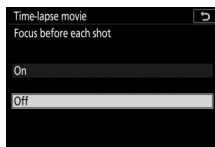

Highlight [**Focus before each shot**] and press .



Highlight an option and press .

- If [**On**] is selected for [**Focus before each shot**], the camera will focus before each shot according to the option currently selected for focus mode.

- **Choose a destination.**

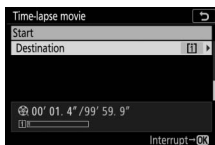

Highlight [**Destination**] and press .

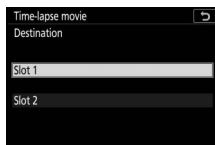

Highlight the slot that will be used to record time-lapse movies when two memory cards are inserted and press .

### 3 Highlight [Start] and press **OK**.

- Shooting starts after about 3 s.
- The display turns off during shooting.
- The camera takes pictures at interval selected for [**Interval**] for the time selected for [**Shooting time**] in Step 2.

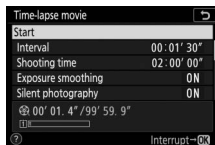

### Ending Shooting

To end shooting before all the photos are taken, press **OK** or select [**Time-lapse movie**] in the photo shooting menu, highlight [**Off**], and press **OK**. Note that the menu may not be displayed when the **MENU** button is pressed if the time selected for [**Interval**] is very short.

- A movie will be created from the frames shot to the point where shooting ended and normal photography will resume.



## ✓ Calculating the Length of the Final Movie

- The total number of frames in the final movie can be calculated by dividing the shooting time selected in Step 2 by the interval, rounding up, and adding 1.
- The length of the final movie can then be calculated by dividing the number of shots by the frame rate selected for **[Frame size/frame rate]** (for example, a 48-frame movie recorded with **[1920×1080; 24p]** selected for **[Frame size/frame rate]** will be about two seconds long).
- The maximum length for time-lapse movies is 20 minutes.

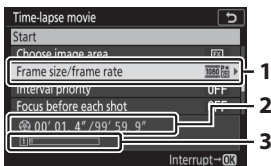



- 1 Frame size/frame rate
- 2 Length recorded/maximum length
- 3 Memory card indicator

## ✓ Image Review

The  button cannot be used to view pictures while shooting is in progress. The current frame will however be displayed for a few seconds after each shot if **[On]** or **[On (monitor only)]** is selected for **[Image review]** in the playback menu. Note that other playback operations cannot be performed while the frame is displayed. The current frame may not be displayed if the interval is very short.

## ✔ Time-Lapse Movies

- Sound is not recorded with time-lapse movies.
- The shutter speed and the time needed to record the image to the memory card may vary from shot to shot. As a result, the interval between a shot being recorded and the start of the next shot may vary.
- Shooting will not begin if a time-lapse movie cannot be recorded at current settings, for example if:
  - The value selected for **[Interval]** is longer than that selected for **[Shooting time]**
  - **[00:00'00" ]** is selected for **[Interval]** or **[Shooting time]**
  - **[On]** is selected for both **[Silent photography]** and **[Interval priority]** and **[00:00'0.5" ]** is selected for **[Interval]**
  - The memory card is full
- The  button cannot be used to view pictures while time-lapse recording is in progress.
- For consistent coloration, choose a white balance setting other than  **A [Auto]** or  **A [Natural light auto]** when recording time-lapse movies.
- Regardless of the option selected for Custom Setting c3 **[Power off delay]** > **[Standby timer]**, the standby timer will not expire while recording is in progress.
- Shooting may end if camera controls are used, settings are changed, or an HDMI cable is connected. A movie will be created from the frames shot to the point where shooting ended.
- The following end shooting without a beep sounding or a movie being recorded:
  - Disconnecting the power source
  - Ejecting the memory card

## ✔ **During Shooting**

The memory card access lamp lights while shooting is in progress.

## ✔ **Adjusting Settings Between Shots**

Shooting and menu settings can be adjusted between shots. Note, however, that the monitor will turn off approximately 2 s before the next shot is taken.

## ✔ **Time-Lapse Movies: Restrictions**

Time-lapse movie recording cannot be combined with some camera features, including:

- movie recording,
- long time-exposures (“**Bulb**” or “**Time**”),
- the self-timer,
- bracketing,
- HDR (high dynamic range),
- multiple exposures,
- interval-timer photography, and
- focus shift.

## ✔ **When [On] Is Selected for [Silent Photography]**

Selecting [**On**] for [**Silent photography**] disables some camera features, including:

- ISO sensitivities of Hi 0.3 through Hi 1.0,
  - flash photography,
  - exposure delay mode,
  - long-exposure noise reduction, and
  - flicker reduction.
-

# Focus Shift Shooting

MENU button →  photo shooting menu

Focus shift automatically varies focus over a series of shots. Use it to take photos that will later be combined using focus stacking to create a single image with increased depth of field. Before using focus shift, choose a focus mode of **AF-S** or **AF-C** and a release mode other than .

Option	Description
[Start]	Start shooting. The camera will take the selected number of shots, changing the focus distance by the selected amount with each shot.
[No. of shots]	Choose the number of shots (maximum 300).
[Focus step width]	Focus shift varies the focus distance over a series of photographs. Choose the amount the focus distance changes with each shot.
[Interval until next shot]	The time between shots, in seconds. <ul style="list-style-type: none"><li>• Select [00] to take photos at up to about 3 fps.</li><li>• To ensure correct exposure when using a flash, choose an interval long enough for the flash to charge.</li></ul>
[First-frame exposure lock]	<ul style="list-style-type: none"><li>• [On]: The camera locks exposure for all shots at the setting for the first frame.</li><li>• [Off]: The camera adjusts exposure before each shot.</li></ul>

Option	Description
<b>[Silent photography]</b>	<p>Select <b>[On]</b> to eliminate shutter sounds during shooting.</p> <ul style="list-style-type: none"> <li>• Selecting <b>[On]</b> does not completely silence the camera. Camera sounds may still be audible, for example during autofocus or aperture adjustment, in the latter case most noticeably at apertures smaller (i.e., at f-numbers higher) than f/5.6.</li> </ul>
<b>[Starting storage folder]</b>	<p>Highlight either of the following options and press  to select (<input checked="" type="checkbox"/>) or deselect (<input type="checkbox"/>)</p> <ul style="list-style-type: none"> <li>• <b>[New folder]</b>: A new folder is created for each new sequence.</li> <li>• <b>[Reset file numbering]</b>: File numbering is reset to 0001 whenever a new folder is created.</li> </ul>

# Focus Shift Photography

## ✓ Before Shooting

- Take a test shot at current settings.
- To ensure that shooting is not interrupted, use a fully-charged battery, an optional charging AC adapter, or an optional AC adapter and power connector.

## 1 Focus.

- During focus shift, the camera takes a series of shots starting from a selected focus position and continuing toward infinity. Given that shooting ends when infinity is reached, the starting focus position should be slightly in front of (i.e., closer to the camera than) the closest point on the subject.
- Do not move the camera after focusing.

## 2 Highlight [Focus shift shooting] in the photo shooting menu.

Press  to select the highlighted item and display focus shift settings.

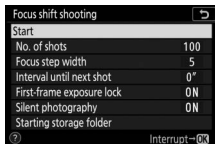
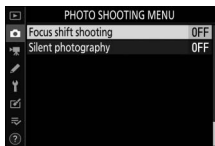

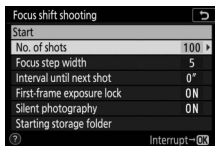

### 3 Adjust focus shift settings.

- Choose the number of shots.

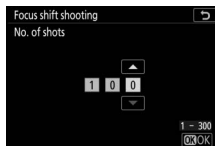

Highlight [**No. of shots**] and press .



Choose the number of shots and press .

- The maximum number of shots is 300.
- We recommend taking more shots than you think you'll need. You can winnow them down during focus stacking.
- More than 100 shots may be required for photographs of insects or other small objects. On the other hand, only a few may be needed to photograph a landscape from front to back with a wide-angle lens.

- **Choose the amount the focus distance changes with each shot.**

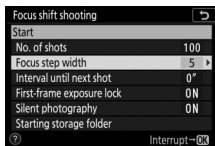

Highlight [**Focus step width**] and press

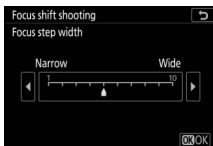



Choose a focus step width and press

- Press to reduce the focus step width, to increase.
- Note that high settings increase the risk that some areas will be out of focus when the shots are stacked. A value of 5 or less is recommended.
- Try experimenting with different settings before shooting.

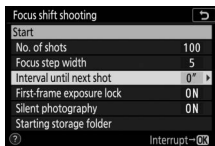

## • Choose the interval until next shot.



Highlight [**Interval until next shot**] and press .

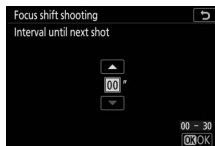

Choose the interval between shots and press .

- Choose the interval between shots, in seconds.
- Select [**00**] to take photos at up to about 3 fps.
- To ensure correct exposure when using a flash, choose an interval long enough for the flash to charge. A setting of [**00**] is recommended when shooting without a flash.

## • Enable or disable first-frame exposure lock.

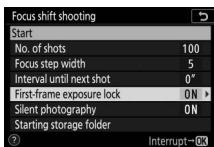

Highlight [**First-frame exposure lock**] and press .

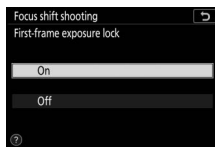

Highlight an option and press .

- [**Off**] is recommended if lighting and other conditions will not change during shooting, [**On**] when photographing landscapes and the like under variable lighting.
- Selecting [**On**] locks exposure at the value for the first shot, ensuring that all photos have the same exposure. Large changes in subject brightness during shooting may however result in apparent variations in exposure. This can be addressed by selecting [**Off**].

## • Enable or disable silent photography.

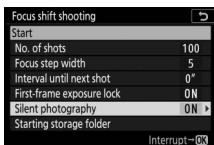

Highlight [**Silent photography**] and press .

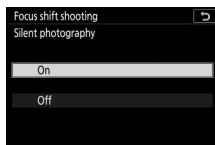



Highlight an option and press .

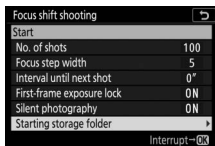

## • Choose starting folder options.

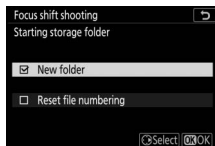

Highlight [**Starting storage folder**] and press .



Select the desired options and press  to proceed.

- Highlight either of the following options and press  to select; selected items are marked with a check () . To deselect (remove the check from: ) a selected option, highlight it and press  again.
- Place a check () next to [**New folder**] to create a new folder for each new sequence.
- Place a check () next to [**Reset file numbering**] to reset file numbering to 0001 whenever a new folder is created.

## 4 Highlight [**Start**] and press .

- Shooting starts after about 3 s.
- The display turns off during shooting.
- The camera takes photographs at the selected interval, starting at the focus distance selected at the start of shooting and progressing out toward infinity by the selected focus step distance with each shot.
- Shooting ends when the selected number of shots has been taken or focus reaches infinity.

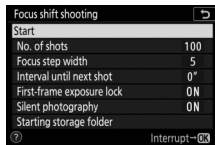

## ■ Ending Focus Shift Photography

To end shooting before all shots have been taken, either:

- select [**Focus shift shooting**] in the photo shooting menu, highlight [**Off**], and press **OK**, or
- press the shutter-release button halfway or press the **OK** button between shots.

---

### ✓ Aperture

Given that pictures shot at very small apertures (high f-numbers) may lack definition, we recommend that you choose apertures wider (f-numbers lower) than f/8–f/11.

### ✓ During Shooting

The memory card access lamp flashes while shooting is in progress.

### ✓ Focus Shift Photography

- The shutter speed and the time needed to record the image may vary from shot to shot. As a result, the interval between a shot being recorded and the start of the next shot may vary.
- Shooting ends when focus reaches infinity, and consequently depending on the focus position at the start of shooting, shooting may end before the selected number of shots has been taken.
- Regardless of the option selected for Custom Setting c3 [**Power off delay**] > [**Standby timer**], the standby timer will not expire while shooting is in progress.
- If you are using a flash, choose an interval longer than the time needed for the flash to charge. If the interval is too short, the flash may fire at less than the power needed for full exposure.
- If shooting cannot proceed at current settings, for example because shutter speed is set to “**Bulb**” or “**Time**”, a warning will be displayed.
- Changing camera settings while focus shift photography is in progress may cause shooting to end.

## ✔ Focus Shift Photography: Restrictions

Focus-shift photography cannot be combined with some camera features, including:

- movie recording,
- long time-exposures (“**Bulb**” or “**Time**”),
- the self-timer,
- bracketing,
- HDR (high dynamic range),
- multiple exposures,
- interval-timer photography, and
- time-lapse movie recording.

## ✔ When [On] Is Selected for [Silent Photography]

Selecting [On] for [Silent photography] disables some camera features, including:

- ISO sensitivities of Hi 0.3 through Hi 1.0,
  - flash photography,
  - exposure delay mode,
  - long-exposure noise reduction, and
  - flicker reduction.
- 

## ✔ Close-ups

Because focus depth is reduced at short focus distances, we recommend choosing smaller focus steps and increasing the number of shots when photographing subjects close to the camera.

---

# Silent Photography

MENU button →  photo shooting menu

Eliminate shutter sounds during shooting (☞87).

Option	Description
[On]	<p>Eliminate vibrations produced by the shutter. Use for landscapes, still lifes, and other static subjects. Use of a tripod is recommended.</p> <ul style="list-style-type: none"><li>• Selecting [On] for [Silent photography] does not completely silence the camera. Camera sounds may still be audible, for example during autofocus or aperture adjustment, in the latter case most noticeably at apertures smaller (i.e., at f-numbers higher) than f/5.6.</li><li>• Flash photography is disabled.</li><li>• Long-exposure noise reduction is disabled.</li><li>• The electronic shutter is used, regardless of the option selected for Custom Setting d5 [Shutter type].</li><li>• Regardless of the settings selected for [Beep options] in the setup menu, beeps will not sound when the camera focuses or while the self-timer is in operation.</li><li>• Enabling silent photography changes the frame advance rates for continuous release modes (☞113).</li></ul>
[Off]	Disable silent photography.

## 🎬 The Movie Shooting Menu: Movie Shooting Options

To view the movie shooting menu, select the 🎬 tab in the camera menus.

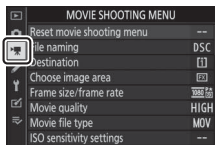

The movie shooting menu contains the following items:

Item	📖	Item	📖
[Reset movie shooting menu]	334	[Diffraction compensation]	339
[File naming]	334	[Auto distortion control]	339
[Destination]	334	[Flicker reduction]	340
[Choose image area]	335	[Metering]	340
[Frame size/frame rate]	335	[Focus mode]	341
[Movie quality]	335	[AF-area mode]	341
[Movie file type]	335	[Vibration reduction]	341
[ISO sensitivity settings]	336	[Electronic VR]	341
[White balance]	337	[Microphone sensitivity]	342
[Set Picture Control]	337	[Attenuator]	343
[Manage Picture Control]	337	[Frequency response]	343
[Active D-Lighting]	338	[Wind noise reduction]	344
[High ISO NR]	338	[Headphone volume]	344
[Vignette control]	339	[Timecode]	345

---

## ✔ See Also

“Movie Shooting Menu Defaults” (📖 196).

---

## Reset Movie Shooting Menu

MENU button ➡ 📷 movie shooting menu

Highlight **[Yes]** and press **OK** to restore movie shooting menu options to their default values (📖 196).

## File Naming

MENU button ➡ 📷 movie shooting menu

Choose the three-letter prefix used in naming the image files in which movies are stored; the default prefix is “DSC” (📖 231).

## Destination

MENU button ➡ 📷 movie shooting menu

Choose the slot to which movies are recorded when two memory cards are inserted.

- The menu shows the time available on each card.
- Recording ends automatically when no time remains on the current card.





## Choose Image Area

MENU button →  movie shooting menu

Choose a movie crop (image area) from FX or DX.

## Frame Size/Frame Rate

MENU button →  movie shooting menu

Choose the movie frame size (in pixels) and frame rate. For more information, see “The  Menu” under “Frame Size and Rate/Image Quality” (📖 150).

## Movie Quality

MENU button →  movie shooting menu

Choose from [**High quality**] and [**Normal**]. For more information, see “The  Menu” under “Frame Size and Rate/Image Quality” (📖 150).

## Movie File Type

MENU button →  movie shooting menu

Record movies in MOV or MP4 format.

- The audio recording format varies with movie file format.  
Linear PCM is used for MOV files and AAC for MP4 files.

# ISO Sensitivity Settings

MENU button ➡  movie shooting menu

Adjust the following ISO sensitivity settings for use in movie mode.

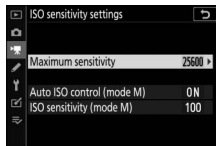

Option	Description
[Maximum sensitivity]	<ul style="list-style-type: none"><li>• Choose the upper limit for auto ISO sensitivity control from values between ISO 200 and 25600.</li><li>• The selected value serves as the upper limit for ISO sensitivity in modes <b>P</b>, <b>S</b>, and <b>A</b> and when [<b>On</b>] is selected for [<b>Auto ISO control (mode M)</b>] in mode <b>M</b>.</li></ul>
[Auto ISO control (mode M)]	<ul style="list-style-type: none"><li>• [<b>On</b>]: Enable auto ISO sensitivity control in mode <b>M</b>.</li><li>• [<b>Off</b>]: Use the value selected for [<b>ISO sensitivity (mode M)</b>].</li><li>• Regardless of the option selected, auto ISO sensitivity control is used in modes other than <b>M</b>.</li></ul>
[ISO sensitivity (mode M)]	Choose the ISO sensitivity for mode <b>M</b> from values between ISO 100 and 25600.

## ✓ Auto ISO Sensitivity Control

- At high ISO sensitivities, “noise” (randomly-spaced bright pixels, fog, or lines) may increase.
- At high ISO sensitivities, the camera may have difficulty focusing.
- The foregoing can be prevented by choosing a lower value for [**ISO sensitivity settings**] > [**Maximum sensitivity**].

## White Balance

MENU button →  movie shooting menu

Choose the white balance for movies.  
Select [**Same as photo settings**] to use the option currently selected for photos (□ 239).

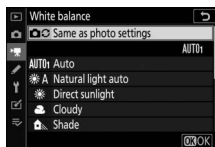

## Set Picture Control

MENU button →  movie shooting menu

Choose a Picture Control for movies.  
Select [**Same as photo settings**] to use the option currently selected for photos (□ 247).

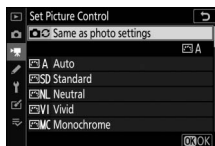

## Manage Picture Control

MENU button →  movie shooting menu

Save modified Picture Controls as custom Picture Controls (□ 250).

## Active D-Lighting

MENU button ➡  movie shooting menu

Preserve details in highlights and shadows, creating movies with natural contrast. Select [**Same as photo settings**] to use the option currently selected for photos ([□255](#)).

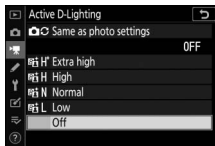

### ✓ [Same as photo settings]

Note that if [**Same as photo settings**] is selected for Active D-Lighting in the movie shooting menu and [**Auto**] is selected in the photo shooting menu, movies will be shot at a setting equivalent to [**Normal**].

## High ISO NR

MENU button ➡  movie shooting menu

Reduce “noise” (randomly-spaced bright pixels) in movies recorded at high ISO sensitivities ([□258](#)).

## Vignette Control

MENU button →  movie shooting menu

Reduce vignetting in movies. Select [**Same as photo settings**] to use the option currently selected for photos (☞259).

## Diffraction Compensation

MENU button →  movie shooting menu

Reduce diffraction in movies (☞260).

## Auto Distortion Control

MENU button →  movie shooting menu

Reduce barrel and pin-cushion distortion in movies (☞260).

## Flicker Reduction

MENU button ➡  movie shooting menu

Reduce flicker and banding when shooting under fluorescent or mercury-vapor lighting during movie recording. Choose [**Auto**] to allow the camera to automatically choose the correct frequency. If [**Auto**] fails to produce the desired results, select [**50 Hz**] or [**60 Hz**] according to the frequency of the local power supply. Choose [**50 Hz**] for areas with a 50 Hz power supply, [**60 Hz**] for areas with a 60 Hz power supply.

### ✔ Flicker Reduction in the Movie Shooting Menu

- If [**Auto**] fails to produce the desired results and you are unsure as to the frequency of the local power supply, test both the 50 and 60 Hz options and choose the one that produces the best results.
- Flicker reduction may not produce the desired results if the subject is very bright. If this is the case, try choosing a smaller aperture (higher f-number).
- Flicker reduction may fail to produce the desired results in modes other than **M**. If this is the case, select mode **M** and choose a shutter speed adapted to the frequency of the local power supply:
  - 50 Hz:  $1/100$  S,  $1/50$  S,  $1/25$  S
  - 60 Hz:  $1/125$  S,  $1/60$  S,  $1/30$  S

## Metering

MENU button ➡  movie shooting menu

Choose how the camera meters exposure in movie mode. [**Spot metering**] is not available in the movie shooting menu ( 140).

## Focus Mode

MENU button →  movie shooting menu

Choose a focus mode for movie recording (📖63).

## AF-Area Mode

MENU button →  movie shooting menu

Choose how the camera focuses in movie mode (📖66).

## Vibration Reduction

MENU button →  movie shooting menu

Adjust vibration reduction settings for movie mode. Select [**Same as photo settings**] to use the option currently selected for photos (📖143).

## Electronic VR

MENU button →  movie shooting menu

Choose whether to enable electronic vibration reduction in movie mode (📖156).

# Microphone Sensitivity

MENU button →  movie shooting menu

Turn built-in or external microphones on or off or adjust microphone sensitivity.

Option	Description
[Auto]	Adjust microphone sensitivity automatically.
[Manual]	Adjust microphone sensitivity manually. Choose from values of from [1] to [20]. The higher the value, the higher the sensitivity; the lower the value, the lower the sensitivity.
[Microphone off]	Turn sound recording off.

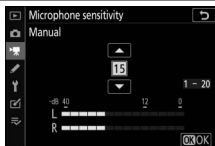

## ✓ Movies Without Sound

Movies recorded with [Microphone off] selected for [Microphone sensitivity] are indicated by a  icon.

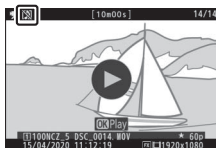



## Attenuator



MENU button →  movie shooting menu

Select [**Enable**] to reduce microphone gain and prevent audio distortion when recording movies in loud environments.

## Frequency Response

MENU button →  movie shooting menu

Choose the range of frequencies to which built-in and external microphones respond.

Option		Description
 WIDE	[ <b>Wide range</b> ]	Record a wide range of frequencies. Choose for everything from music to the bustling hum of a city street.
 VOICE	[ <b>Vocal range</b> ]	Choose for human voices.

## Wind Noise Reduction



MENU button ➡  movie shooting menu

Select [**On**] to enable the low-cut filter, reducing noise produced by wind blowing over the built-in microphone. Note that other sounds may also be affected.

Selecting [**On**] for [**Wind noise reduction**] has no effect on optional stereo microphones. Wind-noise reduction for optional stereo microphones that support this feature can be enabled or disabled using microphone controls.

## Headphone Volume

MENU button ➡  movie shooting menu

Press  or  to adjust headphone volume.

# Timecode

MENU button →  movie shooting menu

Choose whether to record time codes giving the hour, minute, second, and frame number for each frame when shooting movies. Time codes are available only with movies recorded in MOV format.

Option	Description
<b>[Record timecodes]</b>	<ul style="list-style-type: none"><li>• <b>[On]</b>: Record time codes. The time code appears in the shooting display.</li><li>• <b>[On (with HDMI output)]</b>: Time codes will be included with footage saved to external recorders connected to the camera via an HDMI cable. The camera supports Atomos SHOGUN, NINJA, and SUMO-series Monitor recorders.</li><li>• <b>[Off]</b>: Time codes are not recorded.</li></ul>
<b>[Count-up method]</b>	<ul style="list-style-type: none"><li>• <b>[Record run]</b>: Time codes are incremented only while recording is in progress.</li><li>• <b>[Free run]</b>: Time codes are incremented continuously. Time codes continue to be incremented while the camera is off.</li></ul>

Option	Description
[Timecode origin]	<ul style="list-style-type: none"> <li>• [Reset]: Reset the time code to 00:00:00.00.</li> <li>• [Enter manually]: Enter the hour, minute, second, and frame number manually.</li> <li>• [Current time]: Set the time code to the current time as reported by the camera clock. Before proceeding, select [Time zone and date] in the setup menu and make sure that the camera clock is set to the correct time and date.</li> </ul>
[Drop frame]	Select [On] to compensate for discrepancies between the frame count and the actual recording time at frame rates of 30 and 60 fps.

### ✓ HDMI Devices

Selecting [On (with HDMI output)] for [Record timecodes] may disrupt footage output to HDMI devices.

## ✎ Custom Settings: Fine-Tuning Camera Settings

To view Custom Settings, select the ✎ tab in the camera menus.

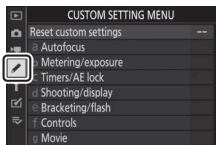

Custom Settings are used to customize camera settings to suit individual preferences. The Custom Settings menu is divided into two levels.

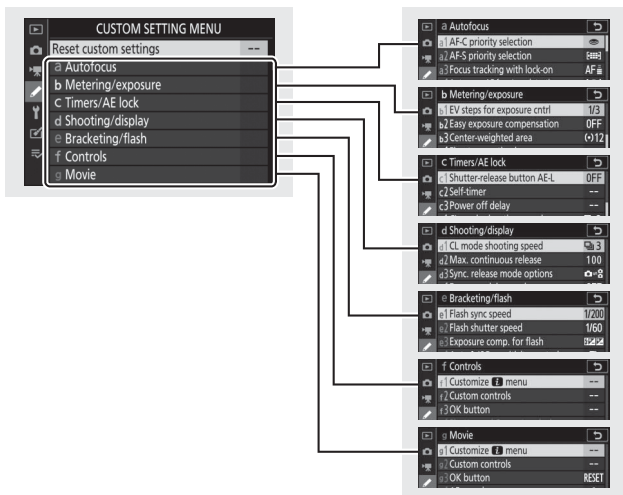

The following Custom Settings are available: <sup>1</sup>

Item		📖
[Reset custom settings]		351
<b>a [Autofocus]</b>		
a1	[AF-C priority selection]	351
a2	[AF-S priority selection]	352
a3	[Focus tracking with lock-on]	352
a4	[Auto-area AF face/eye detection]	353
a5	[Focus points used]	354
a6	[Store points by orientation]	355
a7	[AF activation]	357
a8	[Limit AF-area mode selection]	358
a9	[Focus point wrap-around]	358
a10	[Focus point options]	359
a11	[Low-light AF]	360
a12	[Built-in AF-assist illuminator]	361
a13	[Manual focus ring in AF mode] <sup>2</sup>	362

Item		📖
<b>b [Metering/exposure]</b>		
b1	[EV steps for exposure cntrl]	363
b2	[Easy exposure compensation]	363
b3	[Center-weighted area]	364
b4	[Fine-tune optimal exposure]	364
<b>c [Timers/AE lock]</b>		
c1	[Shutter-release button AE-L]	365
c2	[Self-timer]	365
c3	[Power off delay]	366

Item		
<b>d [Shooting/display]</b>		
d1	[CL mode shooting speed]	367
d2	[Max. continuous release]	367
d3	[Sync. release mode options]	368
d4	[Exposure delay mode]	368
d5	[Shutter type]	369
d6	[File number sequence]	370
d7	[Apply settings to live view]	372
d8	[Framing grid display]	372
d9	[Peaking highlights]	373
d10	[View all in continuous mode]	373

Item		
<b>e [Bracketing/flash]</b>		
e1	[Flash sync speed]	374
e2	[Flash shutter speed]	376
e3	[Exposure comp. for flash]	376
e4	[Auto $\frac{1}{2}$ ISO sensitivity control]	377
e5	[Modeling flash]	377
e6	[Auto bracketing (mode M)]	378
e7	[Bracketing order]	379

Item		📖
<b>f [Controls]</b>		
f1	[Customize <b>f</b> menu]	380
f2	[Custom controls]	382
f3	[OK button]	394
f4	[Shutter spd & aperture lock]	396
f5	[Customize command dials]	397
f6	[Release button to use dial]	400
f7	[Reverse indicators]	401

Item		📖
<b>g [Movie]</b>		
g1	[Customize <b>f</b> menu]	402
g2	[Custom controls]	403
g3	[OK button]	410
g4	[AF speed]	411
g5	[AF tracking sensitivity]	411
g6	[Highlight display]	412

- 1 Items modified from default values are indicated by asterisks ("\*").
- 2 Available with compatible lenses only.

---

### ✔ See Also

"Custom Settings Menu Defaults" (📖198)

---



## Reset Custom Settings

MENU button ➡  Custom Settings menu



Restore Custom Settings to their default values.

## a: Autofocus

### a1: AF-C Priority Selection

MENU button ➡  Custom Settings menu



Choose whether photos can be taken before the camera focuses when **AF-C** is selected.

Option		Description
	[Release]	Photos can be taken whenever the shutter-release button is pressed (release priority).
	[Focus]	Photos can be taken only when the camera is in focus (focus priority).

## a2: AF-S Priority Selection

MENU button ➔  Custom Settings menu

Choose whether photos can be taken before the camera focuses when **AF-S** is selected.

Option	Description
 [Release]	Photos can be taken whenever the shutter-release button is pressed (release priority).
 [Focus]	Photos can be taken only when the camera is in focus (focus priority).

## a3: Focus Tracking with Lock-On

MENU button ➔  Custom Settings menu

Choose how quickly focus responds if something passes between the subject and the camera when **AF-C** is selected for the focus mode.

- Choose [5 (Delayed)] to help maintain focus on your original subject.
- Choose [1 (Quick)] to make it easier to shift focus to objects crossing your field of view.
- If auto-area AF is selected for AF-area mode, blocked shot AF response will function in mode [3] when [2] or [1 (Quick)] is selected.

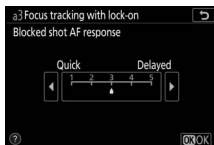

## a4: Auto-Area AF Face/Eye Detection

MENU button ➡  Custom Settings menu

Choose whether the camera detects and focuses on faces or eyes, either of human portrait subjects or of dogs and cats, when [**Auto-area AF**] is selected for AF-area mode.

Option	Description
[ <b>Face and eye detection on</b> ]	When the camera detects a human face, it automatically focuses on one or the other of the subject's eyes. If the eyes are not detected, the camera will instead focus on the subject's face.
[ <b>Face detection on</b> ]	When the camera detects a human face, it automatically focuses on the subject's face.
[ <b>Animal detection on</b> ]	When the camera detects a face of a dog or cat, it automatically focuses on one or the other of the subject's eyes. If the eyes are not detected, the camera will instead focus on the subject's face.
[ <b>Off</b> ]	Face and eye detection disabled.

## a5: Focus Points Used

MENU button ➡  Custom Settings menu

Choose the number of focus points available for manual focus-point selection when an option other than [**Auto-area AF**] is selected for AF-area mode.

Option		Description
ALL	[ <b>All points</b> ]	Every focus point available in the current AF-area mode can be selected. The number of points available varies with the AF-area mode.
1/2	[ <b>Every other point</b> ]	The number of available focus points is reduced to one quarter of the number available when [ <b>All points</b> ] is selected. Use for quick focus-point selection. The number of focus points available in [ <b>Pinpoint AF</b> ] and [ <b>Wide-area AF (L)</b> ] modes does not change.

## a6: Store Points by Orientation

MENU button ➡  Custom Settings menu

Choose whether separate focus points can be selected for “wide” (landscape) orientation, for “tall” (portrait) orientation with the camera rotated 90° clockwise, and for “tall” orientation with the camera rotated 90° counterclockwise.

- Select [**No**] to use the same focus point regardless of camera orientation.



Camera rotated  
90° counter-clockwise



Landscape (wide)  
orientation



Camera rotated  
90° clockwise

- Select **[Yes]** to enable separate focus-point selection.

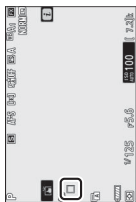

Camera rotated  
90° counter-clockwise



Landscape (wide)  
orientation



Camera rotated  
90° clockwise

## a7: AF Activation

MENU button ➡  Custom Settings menu

Choose whether the shutter-release button can be used to focus. If [**AF-ON only**] is selected, the camera will not focus when the shutter-release button is pressed halfway. Focus can only be adjusted using the **AF-ON** button or other controls to which AF-ON has been assigned using Custom Setting f2 [**Custom controls**].

### Out-of-Focus Release



To choose whether the shutter can be released even in circumstances in which it would normally be disabled, select Custom Setting a7 [**AF activation**], highlight [**AF-ON only**], and press . Selecting [**Enable**] allows the shutter to be released at any time.

Option	Description
[ <b>Enable</b> ]	Shutter-release enabled.
[ <b>Disable</b> ]	Shutter-release disabled.

## a8: Limit AF-Area Mode Selection

MENU button ➔  Custom Settings menu

Choose the AF-area modes that can be selected using the **i** menu or custom controls.

- Highlight either of the following options and press  to select () or deselect (). Modes marked with a check () are available for selection via the sub-command dial.
- To complete the operation, press .

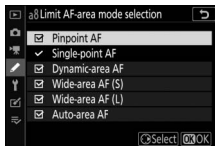

## a9: Focus Point Wrap-Around

MENU button ➔  Custom Settings menu

Choose whether focus-point selection “wraps around” from one edge of the display to another. If **[Wrap]** is selected, focus-point selection will “wrap around” from top to bottom, bottom to top, right to left, and left to right, so that, for example, pressing the sub-selector right when a focus point at the right edge of the viewfinder display is highlighted selects the corresponding focus point at the left edge of the display.



## a10: Focus Point Options

MENU button ➡  Custom Settings menu

Choose from the focus point display options below.

### **Manual Focus Mode**

Option	Description
[On]	The focus point is displayed at all times in manual focus mode.
[Off]	The focus point is displayed only during focus point selection.

### **Dynamic-Area AF Assist**

Choose whether both the selected focus point and the surrounding focus points are displayed in dynamic-area AF mode.

Option	Description
[On]	Display both the selected focus point and surrounding focus points.
[Off]	Display only the selected focus point.

## a11: Low-Light AF

MENU button ➔  Custom Settings menu

Choose **[On]** for more accurate focus under low-light conditions when **AF-S** is selected for focus mode.

- In photo mode, this option takes effect only in modes **P**, **S**, **A**, and **M**.
- In  mode, **[Low-light AF]** is fixed at **[On]**.
- Low-light AF is disabled during interval-timer photography and time-lapse movie recording.
- The camera may require more time to focus when **[On]** is selected.
- While low-light AF is in effect, “Low-light” will appear in the display. The display refresh rate may drop.

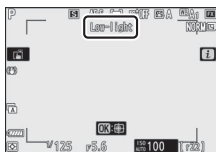

## a12: Built-in AF-Assist Illuminator

MENU button ➡  Custom Settings menu

Choose whether the built-in AF-assist illuminator lights to assist the focus operation in photo mode when lighting is poor.

Option	Description
[On]	In photo mode, the illuminator will light as required when <b>AF-S</b> is selected for focus mode.
[Off]	The illuminator does not light to assist the focus operation. The camera may not be able to focus when lighting is poor.

### The AF-Assist Illuminator

- The AF-assist illuminator has a range of about 1–3 m (3 ft 4 in.–9 ft 10 in.).
- Remove lens hoods when using the illuminator.
- Do not obstruct the AF-assist illuminator while it is lit.



## a13: Manual Focus Ring in AF Mode

MENU button ➡  Custom Settings menu

Choose whether the lens focus ring can be used for manual focus in autofocus mode.

Option	Description
<b>[Enable]</b>	Autofocus can be over-ridden by rotating the lens focus ring (autofocus with manual override). The focus ring can be used for manual focus while the shutter-release button is pressed halfway. To refocus using autofocus, lift your finger from the shutter-release button and then press it halfway again.
<b>[Disable]</b>	The lens focus ring cannot be used for manual focus while autofocus mode is selected.

## b: Metering/Exposure

### b1: EV Steps for Exposure Cntrl

MENU button ➡  Custom Settings menu

Select the increments used for adjustments to shutter speed, aperture, ISO sensitivity, bracketing, and exposure and flash compensation.

### b2: Easy Exposure Compensation

MENU button ➡  Custom Settings menu

Choose whether the  button is needed for exposure compensation.

Option	Description
[On (Auto reset)]	Exposure compensation can be adjusted using only a command dial. The setting selected with the command dial is reset when the camera turns off or the standby timer expires.
[On]	Exposure compensation can be adjusted using only a command dial. Exposure compensation is not reset when the camera turns off or the standby timer expires.
[Off]	Exposure compensation is set by pressing the  button and rotating the main command dial.

- This option takes effect in modes **P**, **S**, and **A**. Easy exposure compensation is not available in other modes.
- The command dial used varies with the shooting mode.

## b3: Center-Weighted Area

MENU button ➔  Custom Settings menu

When [**Center-weighted metering**] is selected, the camera assigns the greatest weight to an area in the center of the shooting display when setting exposure. Custom Setting b3 [**Center-weighted area**] is used to choose the size of the area given the greatest weight when [**Center-weighted metering**] is selected.

## b4: Fine-Tune Optimal Exposure

MENU button ➔  Custom Settings menu

Use this option to fine-tune the exposure value selected by the camera; exposure can be fine-tuned separately for each metering method. Exposure can be adjusted up for brighter exposures or down for darker exposures in the range +1 to -1 EV in steps of  $\frac{1}{6}$  EV. The default is 0.

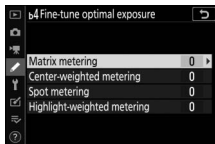

### ✓ Fine-Tuning Exposure



Regardless of the option selected for Custom Setting b4 [**Fine-tune optimal exposure**], the exposure compensation icon () will not be displayed. The only way to determine how much exposure has been altered is to view the amount in the fine-tuning menu for Custom Setting b4.

## c: Timers/AE Lock

### c1: Shutter-Release Button AE-L

MENU button ➡  Custom Settings menu



Choose whether exposure locks when the shutter-release button is pressed.

Option		Description
 ON	[On (half press)]	Pressing the shutter-release button halfway locks exposure.
 ON	[On (burst mode)]	Exposure only locks while the shutter-release button is pressed all the way down.
[Off]		Pressing the shutter-release button does not lock exposure.

### c2: Self-Timer

MENU button ➡  Custom Settings menu

Choose the length of the shutter release delay, the number of shots taken, and the interval between shots in self-timer mode.

Option	Description
[Self-timer delay]	Choose the length of the shutter-release delay.
[Number of shots]	Press  and  to choose the number of shots taken each time the shutter-release button is pressed; choose from values of from 1 to 9.
[Interval between shots]	Choose the interval between shots when [Number of shots] is more than 1.

## c3: Power Off Delay

MENU button ➡  Custom Settings menu

Choose how long the monitor or viewfinder remains on when no operations are performed.

- Different settings can be chosen for [**Playback**], [**Menus**], [**Image review**], and [**Standby timer**].
- [**Standby timer**] determines how long the monitor or viewfinder display remains on after the shutter-release button is pressed halfway. The monitor and viewfinder dim a few seconds before the standby timer expires. If [**10 s**] is selected, the timer will be extended to 20 seconds while the **i** menu is displayed.
- With the exception of [**Image review**], each of the power-off delays is extended by one minute in self-timer mode.
- Longer power-off delays reduce battery endurance.



## d: Shooting/Display

### d1: CL Mode Shooting Speed

MENU button ➡  Custom Settings menu

Choose the frame advance rate for low-speed continuous release mode; options range from [4 fps] to [1 fps].

### d2: Max. Continuous Release

MENU button ➡  Custom Settings menu

The maximum number of shots that can be taken in a single burst in continuous release modes can be set to any value between 1 and 100.

- Note that regardless of the option selected, there is no limit to the number of photos that can be taken in a single burst when a shutter speed of 1 s or slower is selected in mode **S** or **M**.

---

#### The Memory Buffer

Custom Setting d2 [**Max. continuous release**] is used to select the number of shots that can be taken in a single burst. The number of shots that can be taken before the memory buffer fills and shooting slows varies with image quality and other settings. When the buffer is full, the camera will display “r00” and the frame advance rate will drop.

---

### **d3: Sync. Release Mode Options**

MENU button ➡  Custom Settings menu

Choose whether the shutters on the remote cameras are synchronized with the shutter on the master camera when using an optional wireless remote controller.

### **d4: Exposure Delay Mode**



MENU button ➡  Custom Settings menu

In situations where the slightest camera movement can blur pictures, shutter release can be delayed by from about 0.2 to 3 seconds after the shutter-release button is pressed.

## d5: Shutter Type

MENU button ➡  Custom Settings menu

Choose the type of shutter used for photographs.

	Option	Description
	[Auto]	The camera chooses the shutter type automatically according to shutter speed. The electronic front-curtain shutter is used to reduce blur caused by camera shake at slow shutter speeds.
	[Mechanical shutter]	The camera uses the mechanical shutter for all photos.
	[Electronic front-curtain shutter]	The camera uses the electronic front-curtain shutter for all photos.

### "Mechanical Shutter"

[Mechanical shutter] is not available with some lenses.

### The Electronic Front-Curtain Shutter

The fastest shutter speed available when [Electronic front-curtain shutter] is selected is  $1/2000$  s.

## d6: File Number Sequence

MENU button ➡  Custom Settings menu

Choose a file numbering option.

Option	Description
<b>[On]</b>	When a new folder is created or a new memory card is inserted in the camera, file numbering will continue from the last number used. This simplifies file management by minimizing the occurrence of duplicate file names when multiple cards are used.
<b>[Off]</b>	When a new folder is created or a new memory card is inserted, file numbering restarts from 0001. If the current folder already contains images, file numbering will instead continue from the highest file number in the current folder. If you select <b>[Off]</b> after selecting <b>[On]</b> , the camera will store the current file number. File numbering will resume from the previously-stored value the next time <b>[On]</b> is selected.
<b>[Reset]</b>	Reset the file numbering for <b>[On]</b> . If the current folder is empty, file numbering will restart from 0001 with the next picture taken. If the current folder contains images, the next picture taken will be assigned a file number by adding one to the highest file number in the current folder.

---

## ✔ File Number Sequence

- If a picture is taken when the current folder contains a picture numbered 9999, a new folder will be created and file numbering will restart from 0001.
- When the current folder number reaches 999, the camera will no longer be able to create new folders and the shutter release will be disabled if:
  - the current folder contains 5000 pictures (in addition, movie recording will be disabled if the camera calculates that the number of files needed to record a movie of the maximum length would result in the folder containing over 5000 files), or
  - the current folder contains a picture numbered 9999 (in addition, movie recording will be disabled if the camera calculates that the number of files needed to record a movie of the maximum length would result in a file numbered over 9999).

To resume shooting, choose [**Reset**] for Custom Setting d6 [**File number sequence**] and then either format the current memory card or insert a new memory card.

## ✔ Folder Numbering

- If a picture is taken when the current folder contains 5000 pictures or a picture numbered 9999, a new folder will be created and selected as the current folder.
  - The new folder is assigned a number one higher than current folder number. If a folder with that number already exists, the new folder will be assigned the lowest available folder number.
-

## d7: Apply Settings to Live View

MENU button ➡  Custom Settings menu

Choose whether the camera adjusts the preview in the viewfinder or monitor to reflect how shooting settings will affect the hue and brightness of the final picture. Regardless of the option selected, the effects of camera settings are always visible in movie mode.

Option	Description
[On]	The effects of changes to settings such as white balance, Picture Controls, and exposure compensation are visible in the shooting display.
[Off]	<ul style="list-style-type: none"><li>• The effects of changes to settings such as white balance, Picture Controls, and exposure compensation are not visible in the shooting display. The hue and brightness of the display can be adjusted for ease of viewing during extended photo shoots.</li><li>• A  icon appears in the shooting display.</li></ul>

## d8: Framing Grid Display

MENU button ➡  Custom Settings menu

Choose whether to display a grid for reference when framing shots.

## d9: Peaking Highlights

MENU button ➡  Custom Settings menu

When focus peaking is enabled in manual focus mode, objects that are in focus are indicated by colored outlines in the display. You can choose the color.

### Peaking Level

Choose from [**3 (high sensitivity)**], [**2 (standard)**], [**1 (low sensitivity)**], and [**Off**]. The higher the value, the greater the depth that will be shown as being in focus.

### Peaking Highlight Color

Choose the highlight color.

## d10: View All in Continuous Mode

MENU button ➡  Custom Settings menu

If [**Off**] is selected, the display will go blank during burst photography.

## e: Bracketing/Flash

### e1: Flash Sync Speed

MENU button ➡  Custom Settings menu

Choose the flash sync speed.

Option	Description
[1/200 s (Auto FP)]	Auto FP high-speed sync is enabled with compatible flash units and the maximum sync speed for other flash units is set to $1/200$ s. <ul style="list-style-type: none"><li>• When the camera shows a shutter speed of <math>1/200</math> s in mode <b>P</b> or <b>A</b>, auto FP high-speed sync will be activated if the actual shutter speed is faster than <math>1/200</math> s. If the flash supports auto FP high-speed sync, the camera can select shutter speeds as fast as <math>1/8000</math> s.</li><li>• In modes <b>S</b> and <b>M</b>, the user can select shutter speeds as fast as <math>1/8000</math> s when using flash units that support auto FP high-speed sync.</li></ul>
[1/200 s]	Flash sync speed set to selected value, which can be from $1/200$ to $1/60$ s.
[1/160 s]	
[1/125 s]	
[1/100 s]	
[1/80 s]	
[1/60 s]	



---

### ✓ Fixing Shutter Speed at the Flash Sync Speed Limit

In modes **S** and **M**, shutter speed can be fixed at the value selected for Custom Setting e1 [**Flash sync speed**] by selecting the next shutter speed after the slowest possible shutter speed (30 s or “**Time**”). An **X** (flash sync indicator) will appear in the shooting display together with the flash sync speed.

### ✓ Auto FP High-Speed Sync

- Auto FP high-speed sync allows the flash to be used at the highest shutter speed supported by the camera. When [**1/200 s (Auto FP)**] is selected, the camera automatically enables auto FP high-speed sync at shutter speeds faster than the flash sync speed. This makes it possible to choose the maximum aperture for reduced depth of field even when the subject is backlit in bright sunlight.
  - The flash information display shows “FP” when [**1/200 s (Auto FP)**] is selected.
-

## e2: Flash Shutter Speed

MENU button ➡  Custom Settings menu



Choose the slowest shutter speed available with a flash in mode **P** or **A**.

Regardless of the setting chosen for Custom Setting e2 [**Flash shutter speed**], shutter speeds can be as slow as 30 s in modes **S** and **M** or at flash settings of slow sync, slow rear-curtain sync, or red-eye reduction with slow sync.

## e3: Exposure Comp. for Flash

MENU button ➡  Custom Settings menu



Choose how the camera adjusts flash level when exposure compensation is used.

	Option	Description
	[ <b>Entire frame</b> ]	The camera adjusts both the flash level and exposure. This changes the exposure for the entire frame.
	[ <b>Background only</b> ]	Exposure compensation is adjusted for the background only.



## e4: Auto ISO Sensitivity Control

MENU button   Custom Settings menu

Choose how the camera adjusts flash level when auto ISO sensitivity control is enabled.

Option		Description
	[Subject and background]	The camera takes both the main subject and background lighting into account when adjusting ISO sensitivity.
	[Subject only]	ISO sensitivity is adjusted only to ensure that the main subject is correctly exposed.

## e5: Modeling Flash







MENU button   Custom Settings menu

If [On] is selected when the camera is used with an optional flash unit that supports the Nikon Creative Lighting system, pressing a control to which [Preview] has been assigned using Custom Setting f2 [Custom controls] will emit a modeling flash.

## e6: Auto Bracketing (Mode M)

MENU button ➔  Custom Settings menu

The settings affected when bracketing is enabled in mode **M** are determined by the options selected for **[Auto bracketing]** > **[Auto bracketing set]** in the photo shooting menu and the option chosen for Custom Setting e6 **[Auto bracketing (mode M)]**.

Custom Setting e6 [Auto bracketing (mode M)]		Photo shooting menu [Auto bracketing set]	
		AE & flash bracketing*	AE bracketing*
 + 	[Flash/speed]	Shutter speed and flash level	Shutter speed
 + 	[Flash/speed/ aperture]	Shutter speed, aperture, and flash level	Shutter speed and aperture
 + 	[Flash/aperture]	Aperture and flash level	Aperture
	[Flash only]	Flash level	—

\* If a flash is not used when **[On]** is selected for **[Auto ISO sensitivity control]** and **[Flash/speed]**, **[Flash/speed/aperture]**, or **[Flash/aperture]** is selected for e6 **[Auto bracketing (mode M)]**, ISO sensitivity will be fixed at the value for the first shot in each bracketing sequence.

### Flash Bracketing

Flash bracketing is performed only with i-TTL or  (auto aperture) flash control.

## e7: Bracketing Order

MENU button ➡  Custom Settings menu



Choose the order in which the shots in the bracketing program are taken.

	Option	Description
	[MTR > under > over]	The unmodified shot is taken first, followed by the shot with the lowest value, followed by the shot with the highest value.
->+	[Under > MTR > over]	Shooting proceeds in order from the lowest to the highest value.

- Custom Setting e7 [**Bracketing order**] has no effect on the order of the shots taken when [**ADL bracketing**] is selected for [**Auto bracketing**] > [**Auto bracketing set**] in the photo shooting menu.

















# f: Controls







## f1: Customize Menu





MENU button   Custom Settings menu

Choose the items listed in the **i** menu displayed when the **i** button is pressed in photo mode.

- Highlight a position in the **i** menu, press , and select the desired item.
- The following items can be assigned to the **i** menu.

Item			Item		
	[Choose image area]	234		[Metering]	140
QUAL	[Image quality]	136		[Flash mode]	569
SIZE	[Image size]	138		[Flash compensation]	572
	[View memory card info]	381	GRP 	[Group flash options]	586, 596
	[Exposure compensation]	109	AF/MF	[Focus mode]	63
ISO	[ISO sensitivity settings]	105		[AF-area mode]	66
WB	[White balance]	81		[Vibration reduction]	143
	[Set Picture Control]	123	BKT	[Auto bracketing]	269
RGB	[Color space]	254		[Multiple exposure]	281
	[Active D-Lighting]	255	HDR	[HDR (high dynamic range)]	291
	[Long exposure NR]	257		[Interval timer shooting]	297
ISO NR	[High ISO NR]	258		[Time-lapse movie]	311

	Item	📖
	[Focus shift shooting]	322
	[Silent photography]	87
	[Release mode]	111
	[Custom controls]	382
	[Exposure delay mode]	368
	[Shutter type]	369

	Item	📖
	[Apply settings to live view]	372
	[Peaking highlights]	373
	[Monitor/viewfinder brightness]	417, 419
	[Bluetooth connection]	442
	[Wi-Fi connection]	141

## View Memory Card Info

View the slot currently selected as the destination for new pictures and the role played by the card in Slot 2 when two memory cards are inserted. This option can be used to view but not to change the option selected.

- The role played by the card in Slot 2 can be selected using **[Role played by card in Slot 2]** in the photo shooting menu.

## Bluetooth Connection

Enable or disable Bluetooth.









## f2: Custom Controls

MENU button ➔  Custom Settings menu

Choose the operations performed in photo mode using camera or lens controls or by pressing camera controls and rotating command dials.

- Choose the roles played by the controls below. Highlight the desired control and press .

























Option	
	[Fn1 button]
	[Fn2 button]
	[AF-ON button]
	[Sub-selector]
	[Sub-selector center]
	[Movie record button]
	[Lens Fn button]
	[Lens Fn2 button]
	[Lens control ring]



- The roles that can be assigned to these controls are as follows:

Option		Fn1	Fn2	Fn3	⊗	⊙	⌘	Lfn	Rfn	0]
RESET	[Select center focus point]	—	—	✓	—	✓	—	—	—	—
AF-ON	[AF-ON]	✓	✓	✓	—	✓	—	✓	✓	—
AF	[AF lock only]	✓	✓	✓	—	✓	—	✓	✓	—
AE	[AE lock (Hold)]	✓	✓	✓	—	✓	✓	✓	✓	—
AE	[AE lock (Reset on release)]	✓	✓	✓	—	✓	✓	✓	✓	—
AE	[AE lock only]	✓	✓	✓	—	✓	—	✓	✓	—
AE/AF	[AE/AF lock]	✓	✓	✓	—	✓	—	✓	✓	—
FV	[FV lock]	✓	✓	—	—	✓	—	✓	✓	—
Ⓢ/⚡	[ⓈDisable/enable]	✓	✓	—	—	✓	—	✓	✓	—
Ⓢ	[Preview]	✓	✓	—	—	✓	✓	✓	✓	—
Ⓢ	[Matrix metering]	✓	✓	—	—	✓	—	✓	✓	—
Ⓢ	[Center-weighted metering]	✓	✓	—	—	✓	—	✓	✓	—
Ⓢ	[Spot metering]	✓	✓	—	—	✓	—	✓	✓	—
Ⓢ*	[Highlight-weighted metering]	✓	✓	—	—	✓	—	✓	✓	—
BKT	[Bracketing burst]	✓	✓	—	—	✓	—	✓	✓	—
+RAW	[+ NEF (RAW)]	✓	✓	—	—	✓	✓	✓	✓	—









Option										
 [Subject tracking]	✓	✓	—	—	—	—	✓	✓	—	—
 [Framing grid display]	✓	✓	—	—	✓	✓	✓	✓	—	—
 [Zoom on/off]	✓	✓	✓	—	—	✓	✓	✓	—	—
 [MY MENU]	✓	✓	—	—	—	✓	✓	✓	—	—
 [Access top item in MY MENU]	✓	✓	—	—	—	✓	✓	✓	—	—
 [Playback]	✓	✓	—	—	—	—	✓	✓	—	—
 [Protect]	✓	✓	—	—	—	—	—	—	—	—
 [Choose image area]	✓	✓	—	—	✓	✓	—	—	—	—
QUAL [Image quality/size]	✓	✓	—	—	—	✓	—	—	—	—
WB [White balance]	✓	✓	—	—	—	✓	—	—	—	—
 [Set Picture Control]	✓	✓	—	—	—	✓	—	—	—	—
 [Active D-Lighting]	✓	✓	—	—	—	✓	—	—	—	—
 [Metering]	✓	✓	—	—	—	✓	—	—	—	—
 [Flash mode/compensation]	✓	✓	—	—	—	✓	—	—	—	—
AF/[+] [Focus mode/AF-area mode]	✓	✓	—	—	—	✓	—	—	—	—
BKT [Auto bracketing]	✓	✓	—	—	—	✓	—	—	—	—



Option										
	[Multiple exposure]	✓	✓	—	—	—	✓	—	—	—
HDR	[HDR (high dynamic range)]	✓	✓	—	—	—	✓	—	—	—
	[Exposure delay mode]	✓	✓	—	—	—	✓	—	—	—
	[Shutter spd & aperture lock]	✓	✓	—	—	—	✓	—	—	—
	[Peaking highlights]	✓	✓	—	—	—	—	—	—	—
★	[Rating]	✓	✓	—	—	—	—	—	—	—
Non-CPU	[Choose non-CPU lens number]	✓	✓	—	—	✓	✓	—	—	—
= ⊕	[Same as multi selector]	—	—	—	✓	—	—	—	—	—
[+]	[Focus point selection]	—	—	—	✓	—	—	—	—	—
M/A	[Focus (M/A)]	—	—	—	—	—	—	—	—	✓ <sup>1, 2</sup>
	[Aperture]	—	—	—	—	—	—	—	—	✓ <sup>2</sup>
	[Exposure compensation]	—	—	—	—	—	—	—	—	✓ <sup>2</sup>
ISO	[ISO sensitivity]	—	—	—	—	—	—	—	—	✓ <sup>2</sup>
[None]		✓	✓	✓	—	✓	✓	✓	✓	✓ <sup>2</sup>









- 1 Available with compatible lenses only.
- 2 Regardless of the option selected, in manual focus mode the control ring can only be used to adjust focus.





- The following options are available:

	Role	Description
RESET	[ <b>Select center focus point</b> ]	Pressing the control selects the center focus point.
AF-ON	[ <b>AF-ON</b> ]	Pressing the control initiates autofocus, duplicating the function of the <b>AF-ON</b> button.
AF	[ <b>AF lock only</b> ]	Focus locks while the control is pressed.
AE	[ <b>AE lock (Hold)</b> ]	Exposure locks when the control is pressed. Exposure lock does not end when the shutter is released. Exposure remains locked until the control is pressed a second time or the standby timer expires.
AE	[ <b>AE lock (Reset on release)</b> ]	Exposure locks when the control is pressed. Exposure remains locked until the control is pressed a second time, the shutter is released, or the standby timer expires.
AE	[ <b>AE lock only</b> ]	Exposure locks while the control is pressed.
AE/AF	[ <b>AE/AF lock</b> ]	Focus and exposure lock while the control is pressed.





Role		Description
	[FV lock]	Press the control to lock flash value for optional flash units; press again to cancel FV lock.
	[  Disable/enable]	If the flash is currently enabled, it will be disabled while the control is pressed. If the flash is currently off, front-curtain sync will be selected while the control is pressed.
	[Preview]	Keep the control pressed to preview photo color, exposure, and depth of field.
	[Matrix metering]	[ <b>Matrix metering</b> ] is activated while the control is pressed.
	[Center-weighted metering]	[ <b>Center-weighted metering</b> ] is activated while the control is pressed.
	[Spot metering]	[ <b>Spot metering</b> ] is activated while the control is pressed.
	[Highlight-weighted metering]	[ <b>Highlight-weighted metering</b> ] is activated while the control is pressed.







	Role	Description
	<b>[Bracketing burst]</b>	<ul style="list-style-type: none"> <li>• If the control is pressed when an option other than <b>[WB bracketing]</b> is selected for <b>[Auto bracketing]</b> &gt; <b>[Auto bracketing set]</b> in the photo shooting menu in continuous release mode, the camera will take all the shots in the current bracketing program and repeat the bracketing burst while the shutter-release button is pressed. In single-frame release mode, shooting will end after the first bracketing burst.</li> <li>• If <b>[WB bracketing]</b> is selected for <b>[Auto bracketing set]</b>, the camera will take pictures while the shutter-release button is pressed and apply white balance bracketing to each shot.</li> </ul>
	<b>[+ NEF (RAW)]</b>	<ul style="list-style-type: none"> <li>• If a JPEG option is currently selected for image quality, "RAW" will be displayed and an NEF (RAW) copy will be recorded with the next picture taken after the control is pressed. The original image quality setting will be restored when you remove your finger from the shutter-release button or press the control again, canceling <b>[+ NEF (RAW)]</b>.</li> <li>• NEF (RAW) copies are recorded at the settings currently selected for <b>[NEF (RAW) recording]</b> in the photo shooting menu.</li> </ul>



	Role	Description
	<b>[Subject tracking]</b>	Pressing the control during auto-area AF enables subject tracking; the focus point will change to a targeting reticle and the monitor and viewfinder to subject-tracking displays. <ul style="list-style-type: none"> <li>• To end subject-tracking AF, press the control again or press the  (?) button.</li> </ul>
	<b>[Framing grid display]</b>	Press the control to display a framing grid. Press the control again to turn the display off.
	<b>[Zoom on/off]</b>	Press the control to zoom the display in on the area around the current focus point. Press again to cancel zoom.
	<b>[MY MENU]</b>	Press the control to display “MY MENU”.
	<b>[Access top item in MY MENU]</b>	Press the control to jump to the top item in “MY MENU”. Select this option for quick access to a frequently-used menu item.
	<b>[Playback]</b>	Press the control to start playback.
	<b>[Protect]</b>	Press the control during playback to protect the current picture.
	<b>[Choose image area]</b>	Press the control and rotate a command dial to choose the image area.
QUAL	<b>[Image quality/size]</b>	Press the control and rotate the main command dial to choose an image quality option and the sub-command dial to select image size.

Role		Description
WB	[White balance]	To choose a white balance option, hold the button and rotate the main command dial. Some options offer sub-options that can be selected by rotating the sub-command dial.
	[Set Picture Control]	Press the control and rotate a command dial to choose a Picture Control.
	[Active D-Lighting]	Press the control and rotate a command dial to adjust Active D-Lighting.
	[Metering]	Press the control and rotate a command dial to choose a metering option.
	[Flash mode/compensation]	Press the control and rotate the main command dial to choose a flash mode and the sub-command dial to adjust flash output.
AF/[+]	[Focus mode/AF-area mode]	Hold the control and rotate the main command dial to choose the focus mode, the sub-command dial to choose the AF-area mode.
BKT	[Auto bracketing]	Press the control and rotate the main command dial to choose the number of shots and the sub-command dial to select the bracketing increment or Active D-Lighting amount.
	[Multiple exposure]	Press the control and rotate the main command dial to choose the mode and the sub-command dial to choose the number of shots.





	Role	Description
HDR	[HDR (high dynamic range)]	Press the control and rotate the main command dial to choose the mode and the sub-command dial to choose the exposure differential.
	[Exposure delay mode]	Press the control and rotate a command dial to choose the shutter-release delay.
	[Shutter spd & aperture lock]	Press the control and rotate the main command dial to lock shutter speed (modes <b>S</b> and <b>M</b> ). To lock aperture (modes <b>A</b> and <b>M</b> ), press the control and rotate the sub-command dial.
	[Peaking highlights]	Press the control and rotate the main command dial to choose a peaking level and the sub-command dial to select the peaking color.
★	[Rating]	<p>To rate the current picture in playback mode, press the control and rotate the main command dial.</p> <ul style="list-style-type: none"> <li>To display rating options, highlight [Rating] and press . If an option other than [None] is selected, the chosen rating can be assigned to pictures simply by pressing the selected control. Pressing the control again selects a “no star” rating.</li> </ul>
Non-CPU	[Choose non-CPU lens number]	Press the control and rotate a command dial to choose a lens number saved using the [Non-CPU lens data] item in the setup menu.

Role		Description
= 	<b>[Same as multi selector]</b>	<p>Pressing the sub-selector up, down, left, or right during shooting or playback has the same effect as pressing , , , or  on the multi selector. To choose the role played by the sub-selector during focus or playback zoom, highlight <b>[Same as multi selector]</b> and press .</p> <ul style="list-style-type: none"> <li>• Select <b>[Scroll]</b> to use the sub-selector to scroll the display.</li> <li>• Select <b>[Display next/previous frame]</b> to use the sub-selector to page through pictures without altering the zoom ratio.</li> </ul>
[  ]	<b>[Focus point selection]</b>	Use the control to select the focus point. Using the control during playback ends playback and enables focus-point selection.
M/A	<b>[Focus (M/A)]</b>	Autofocus can be over-riden by rotating the lens control ring (autofocus with manual override). The control ring can be used for manual focus while the shutter-release button is pressed halfway. To refocus using autofocus, lift your finger from the shutter-release button and then press it halfway again.

Role		Description
	[Aperture]	Rotate the lens control ring to adjust aperture.
	[Exposure compensation]	Rotate the lens control ring to adjust exposure compensation.
ISO	[ISO sensitivity]	Rotate the lens control ring to adjust ISO sensitivity.
[None]		The control has no effect.

## f3: OK Button





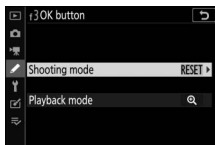

MENU button ➔  Custom Settings menu

Choose the role assigned to the  button in photo mode and during playback.







## Shooting Mode

Regardless of the option selected, when auto-area AF is chosen for AF-area mode, the button functions only to initiate subject-tracking AF ( 74).

	Role	Description
RESET	[ <b>Select center focus point</b> ]	Pressing  selects the center focus point.
	[ <b>Zoom on/off</b> ]	Press  to zoom the display in on the area around the current focus point. Press  again to return to the previous display. To choose the zoom ratio, highlight [ <b>Zoom on/off</b> ] and press  .
[None]		Pressing  during shooting has no effect.

## Playback Mode

Regardless of the option selected, pressing  $\odot$  when a movie is displayed full frame starts movie playback.

Role		Description
	[Thumbnail on/off]	Press $\odot$ to toggle between full-frame playback, 4-, 9-, and 72-frame thumbnail playback, and calendar playback.
	[View histograms]	A histogram is displayed while the $\odot$ button is pressed. The histogram display is available in both full-frame and thumbnail playback.
	[Zoom on/off]	Press $\odot$ to zoom the display in on the area around the active focus point. Press $\odot$ again to return to the previous display. <ul style="list-style-type: none"><li>• To choose the zoom ratio, highlight [Zoom on/off] and press <math>\blacktriangleright</math>.</li><li>• Zoom is available in both full-frame and thumbnail playback.</li></ul>
	[Choose slot and folder]	Press $\odot$ to display the [Choose slot and folder] dialog, where you can then choose a slot and folder for playback.

## f4: Shutter Spd & Aperture Lock

MENU button ➡  Custom Settings menu

Selecting **[On]** for **[Shutter speed lock]** locks shutter speed at the value currently selected in mode **S** or **M**. Selecting **[On]** for **[Aperture lock]** locks aperture at the value currently selected in mode **A** or **M**.

- While shutter speed or aperture lock is in effect, a  icon will be displayed.
- Shutter speed and aperture lock are not available in the shooting mode **P**.



## f5: Customize Command Dials

MENU button ➔  Custom Settings menu

Customize the operation of the main and sub-command dials.

### Reverse Rotation

Reverse the direction of rotation of the command dials for selected operations.

- Highlight [**Exposure compensation**] or [**Shutter speed/aperture**] and press  to select () or deselect ()
- Press  to save changes and exit.

### Change Main/Sub

Reverse the roles of the main- and sub-command dials.

Option	Description
[ <b>Exposure setting</b> ]	If [ <b>On</b> ] is selected, the main command dial will control aperture and the sub-command dial shutter speed. If [ <b>On (Mode A)</b> ] is selected, the main command dial will be used to set aperture in mode <b>A</b> only.
[ <b>Autofocus setting</b> ]	If [ <b>On</b> ] is selected and [ <b>Focus mode/AF-area mode</b> ] has been assigned to a control using Custom Setting f2 [ <b>Custom controls</b> ], you can choose the AF-area mode by holding the control and rotating the main command dial and focus mode by holding the control and rotating the sub-command dial.

## Menus and Playback

Choose the roles played by the multi selector and command dials during playback and menu navigation.





Option	Description
[On]	<b>Playback:</b> <ul style="list-style-type: none"><li>• The main command dial can be used to choose the picture displayed during full-frame playback. The sub-command dial can be used to skip forward or back according to the option selected for [<b>Sub-dial frame advance</b>].</li><li>• During thumbnail playback, the main command dial can be used to highlight thumbnails and the sub-command dial to page up or down.</li></ul> <b>Menus:</b> <p>Use the main command dial to highlight menu items. Rotating the sub-command dial right displays the sub-menu for the highlighted option. Rotating it left displays the previous menu.</p>
ON <sup>Ⓞ</sup>	[On (image review excluded)] As for [On] except that the command dials cannot be used for playback during image review.
[Off]	Use the multi selector to choose the picture displayed during full-frame playback or to highlight pictures or menu items.

\* The sub-command dial cannot be used to select highlighted items. To select highlighted items, press <sup>Ⓞ</sup> or <sup>Ⓛ</sup>.



## Sub-Dial Frame Advance

Choose the number of frames that can be skipped by rotating the sub-command dial during full-frame playback. This option only takes effect when **[On]** or **[On (image review excluded)]** is selected for **[Menus and playback]**.

Option	Description
[10 frames]	Skip forward or back 10 frames at a time.
[50 frames]	Skip forward or back 50 frames at a time.
★ [Rating]	Skip to the next or previous pictures with the selected rating. To choose the rating, highlight [Rating] and press  .
 [Protect]	Skip to the next or previous protected picture.
 [Still images only]	Skip to the next or previous photo.
 [Movies only]	Skip to the next or previous movie.
 [Folder]	Rotate the sub-command dial to select a folder.

## f6: Release Button to Use Dial

MENU button ➡  Custom Settings menu



Selecting **[Yes]** allows adjustments that are normally made by holding a button and rotating a command dial to be made by rotating the command dial after the button is released. This ends when the button is pressed again, the shutter-release button is pressed halfway, or the standby timer expires.

- **[Release button to use dial]** applies to the  and **ISO** buttons.
- **[Release button to use dial]** also applies to controls to which the following roles have been assigned using Custom Settings f2 or g2 **[Custom controls]**: **[Choose image area]**, **[Image quality/size]**, **[White balance]**, **[Set Picture Control]**, **[Active D-Lighting]**, **[Metering]**, **[Flash mode/compensation]**, **[Focus mode/AF-area mode]**, **[Auto bracketing]**, **[Multiple exposure]**, **[HDR (high dynamic range)]**, **[Exposure delay mode]**, **[Shutter spd & aperture lock]**, **[Peaking highlights]**, **[Choose non-CPU lens number]**, and **[Microphone sensitivity]**.

## f7: Reverse Indicators



MENU button ➡  Custom Settings menu



Choose whether the exposure indicator is displayed with negative values on the left and positive values on the right, or with positive values on the left and negative values on the right.



	Option	Description
+0-		The indicator is displayed with positive values on the left and negative values on the right.
-0+		The indicator is displayed with negative values on the left and positive values on the right.























# g: Movie

## g1: Customize Menu

MENU button   Custom Settings menu

Choose the items listed in the  menu displayed when the  button is pressed in movie mode.

- Highlight a position in the  menu, press , and select the desired item.
- The following items can be assigned to the  menu.







	Item			Item	
	[Choose image area]	153		[Electronic VR]	156
	[Frame size and rate/ Image quality]	150		[Microphone sensitivity]	152
	[Destination]	155		[Attenuator]	343
	[Exposure compensation]	109		[Frequency response]	343
ISO	[ISO sensitivity settings]	105		[Wind noise reduction]	344
WB	[White balance]	149		[Headphone volume]	344
	[Set Picture Control]	149		[Peaking highlights]	373
	[Active D-Lighting]	255		[Highlight display]	412
	[Metering]	155		[Monitor/viewfinder brightness]	417, 419
AF/MF	[Focus mode]	157		[Bluetooth connection]	442
	[AF-area mode]	157		[Wi-Fi connection]	141, 155
	[Vibration reduction]	156			

## g2: Custom Controls

MENU button ➔  Custom Settings menu























Choose the operations performed in movie mode using camera or lens controls or by pressing camera controls and rotating command dials.













- Choose the roles played by the controls below. Highlight the desired control and press .

Option	
	[Fn1 button]
	[Fn2 button]
	[AF-ON button]
	[Sub-selector center]
	[Shutter-release button]
	[Lens control ring]









- The roles that can be assigned to these controls are as follows:

Option							
	[Power aperture (open)]	✓	—	—	—	—	—
	[Power aperture (close)]	—	✓	—	—	—	—
	[Exposure compensation +]	✓	—	—	—	—	—
	[Exposure compensation -]	—	✓	—	—	—	—
	[Subject tracking]	✓	✓	—	—	—	—
	[Framing grid display]	✓	✓	—	✓	—	—
	[Zoom on/off]	✓	✓	✓	✓	—	—
	[Protect]	✓	✓	—	—	—	—
RESET	[Select center focus point]	—	—	✓	✓	—	—
	[AF-ON]	—	—	✓	—	—	—
	[AF lock only]	—	—	✓	✓	—	—
	[AE lock (Hold)]	—	—	✓	✓	—	—
	[AE lock only]	—	—	✓	✓	—	—
	[AE/AF lock]	—	—	✓	✓	—	—
	[Take photos]	—	—	—	—	✓	—
	[Record movies]	—	—	✓	✓	✓	—
	[Choose image area]	✓	✓	—	✓	—	—
WB	[White balance]	✓	✓	—	—	—	—
	[Set Picture Control]	✓	✓	—	—	—	—









Option							
	[Active D-Lighting]	✓	✓	—	—	—	—
	[Metering]	✓	✓	—	—	—	—
AF/[+]	[Focus mode/AF-area mode]	✓	✓	—	—	—	—
	[Microphone sensitivity]	✓	✓	—	—	—	—
	[Peaking highlights]	✓	✓	—	—	—	—
★	[Rating]	✓	✓	—	—	—	—
M/A	[Focus (M/A)]	—	—	—	—	—	✓ <sup>1,2</sup>
	[Power aperture]	—	—	—	—	—	✓ <sup>2</sup>
	[Exposure compensation]	—	—	—	—	—	✓ <sup>2</sup>
ISO	[ISO sensitivity]	—	—	—	—	—	✓ <sup>2</sup>
[None]		✓	✓	✓	✓	—	✓ <sup>2</sup>







- 1 Available with compatible lenses only.
- 2 Regardless of the option selected, in manual focus mode the control ring can only be used to adjust focus.





- The following options are available:

	Role	Description
	[Power aperture (open)]	Aperture widens while the <b>Fn1</b> button is pressed. Use in combination with Custom Setting g2 [Custom controls] > [Fn2 button] > [Power aperture (close)] for button-controlled aperture adjustment.
	[Power aperture (close)]	Aperture narrows while the <b>Fn2</b> button is pressed. Use in combination with Custom Setting g2 [Custom controls] > [Fn1 button] > [Power aperture (open)] for button-controlled aperture adjustment.
	[Exposure compensation +]	Exposure compensation increases while the <b>Fn1</b> button is pressed. Use in combination with Custom Setting g2 [Custom controls] > [Fn2 button] > [Exposure compensation -] for button-controlled exposure compensation.
	[Exposure compensation -]	Exposure compensation decreases while the <b>Fn2</b> button is pressed. Use in combination with Custom Setting g2 [Custom controls] > [Fn1 button] > [Exposure compensation +] for button-controlled exposure compensation.
	[Subject tracking]	Pressing the control during auto-area AF enables subject tracking; the focus point will change to a targeting reticle and the monitor and viewfinder to subject-tracking displays. <ul style="list-style-type: none"> <li>• To end subject-tracking AF, press the control again or press the  (?) button.</li> </ul>



	Role	Description
	[Framing grid display]	Press the control to display a framing grid. Press the control again to turn the display off.
	[Protect]	Press the control during playback to protect the current picture.
RESET	[Select center focus point]	Pressing the control selects the center focus point.
	[AF-ON]	Pressing the control initiates autofocus, duplicating the function of the <b>AF-ON</b> button.
	[AF lock only]	Focus locks while the control is pressed.
	[AE lock (Hold)]	Exposure locks when the control is pressed. Exposure lock does not end when the shutter is released. Exposure remains locked until the control is pressed a second time or the standby timer expires.
	[AE lock only]	Exposure locks while the control is pressed.
	[AE/AF lock]	Focus and exposure lock while the control is pressed.
	[Zoom on/off]	Press the control to zoom the display in on the area around the current focus point (the zoom ratio is selected in advance). Press again to cancel zoom.

Role		Description
	[Take photos]	Press the shutter-release button all the way down to take a photograph with an aspect ratio of 16:9.
	[Record movies]	Press the control to start recording. Press again to end recording.
	[Choose image area]	Press the control and rotate a command dial to choose the image area for movies. Note that the image area cannot be changed while recording is in progress.
WB	[White balance]	Hold the control and rotate the main command dial to adjust white balance for movies. Some options offer sub-options that can be selected by rotating the sub-command dial.
	[Set Picture Control]	Press the control and rotate a command dial to choose a Picture Control.
	[Active D-Lighting]	Press the control and rotate a command dial to adjust Active D-Lighting for movies.
	[Metering]	Press the control and rotate a command dial to choose a movie metering option.
AF/[+]	[Focus mode/ AF-area mode]	Hold the control and rotate the main command dial to choose the focus mode, the sub-command dial to choose the AF-area mode.
	[Microphone sensitivity]	Press the control and rotate a command dial to adjust microphone sensitivity.



Role		Description
	[Peaking highlights]	Press the control and rotate the main command dial to choose a peaking level and the sub-command dial to select the peaking color.
★	[Rating]	To rate the current picture in playback mode, press the control and rotate the main command dial. <ul style="list-style-type: none"> <li>To display rating options, highlight [Rating] and press . If an option other than [None] is selected, the chosen rating can be assigned to pictures simply by pressing the selected control. Pressing the control again selects a “no star” rating.</li> </ul>
M/A	[Focus (M/A)]	The lens control ring can be used for manual focus regardless of the option selected for focus mode. To refocus using autofocus, press the shutter-release button halfway or press a control to which AF-ON has been assigned.
	[Power aperture]	Rotate the lens control ring to adjust aperture.
	[Exposure compensation]	Rotate the lens control ring to adjust exposure compensation.
ISO	[ISO sensitivity]	Rotate the lens control ring to adjust ISO sensitivity.
	[None]	The control has no effect.

### ✔ Power Aperture







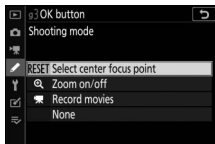

- Power aperture is available only in modes **A** and **M**.
- A  icon in the shooting display indicates that power aperture cannot be used.
- The display may flicker while aperture is adjusted.

## g3: OK Button

MENU button ➔  Custom Settings menu

Choose the role assigned to the  button in movie mode. Regardless of the option selected, the  button can be used for focus tracking ( 74) when auto-area AF is selected for AF-area mode.



	Role	Description
RESET	[ <b>Select center focus point</b> ]	Pressing  selects the center focus point.
	[ <b>Zoom on/off</b> ]	Press  to zoom the display in on the area around the active focus point. Press  again to return to the previous display. To choose the zoom ratio, highlight [ <b>Zoom on/off</b> ] and press  .
	[ <b>Record movies</b> ]	Press  to start recording. Press  again to end movie recording.
	[ <b>None</b> ]	Pressing  during shooting has no effect.

## g4: AF Speed

MENU button ➡  Custom Settings menu

Choose the focus speed for movie mode.

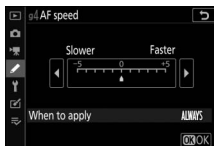

Use [**When to apply**] to choose when the selected option applies.

Option		Description
ALWAYS	[ <b>Always</b> ]	The camera focuses at the selected speed at all times in movie mode.
REC	[ <b>Only while recording</b> ]	Focus is adjusted at the selected speed only during movie recording. At other times, the focus speed is "+5", or in other words as fast possible.

## g5: AF Tracking Sensitivity

MENU button ➡  Custom Settings menu

The AF tracking sensitivity for movie mode can be set to values of from 1 to 7.

- Choose [**7 (Low)**] to help maintain focus on your original subject.
- If the subject leaves the selected focus area when [**1 (High)**] is selected, the camera will respond by quickly shifting focus to a new subject in the same area.

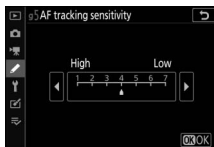

## g6: Highlight Display

MENU button ➔  Custom Settings menu

Choose whether shading is used to indicate highlights (bright areas of the frame) during movie recording.

### Display Pattern

To enable the highlight display, select [**Pattern 1**] or [**Pattern 2**].

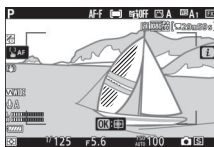

Pattern 1

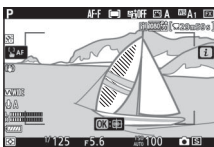

Pattern 2

### Highlight Display Threshold

Choose the brightness needed to trigger the movie highlight display. The lower the value, the greater the range of brightnesses that will be shown as highlights. If [**255**] is selected, the highlight display will show only areas that are potentially overexposed.

---

#### **Highlight Display**

If both the highlight display and peaking highlights are enabled, only peaking highlights will be displayed in manual focus mode. To view the highlight display in manual focus mode, select [**Off**] for Custom Setting d9 [**Peaking highlights**] > [**Peaking level**].

---

## Y The Setup Menu: Camera Setup

To view the setup menu, select the Y tab in the camera menus.

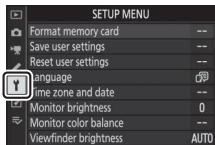

The setup menu contains the following items:

Item		Item	
[Format memory card]	415	[AF fine-tuning options]	422
[Save user settings]	415	[Non-CPU lens data]	426
[Reset user settings]	415	[Clean image sensor]	426
[Language]	416	[Image Dust Off ref photo]	427
[Time zone and date]	416	[Pixel mapping]	430
[Monitor brightness]	417	[Image comment]	432
[Monitor color balance]	418	[Copyright information]	433
[Viewfinder brightness]	419	[Beep options]	435
[Viewfinder color balance]	420	[Touch controls]	436
[Limit monitor mode selection]	420	[HDMI]	437
[Information display]	421		

Item	
[Location data] *	437
[Wireless remote (WR) options]	438
[Assign remote (WR) Fn button]	441
[Airplane mode]	441
[Connect to smart device]	442
[Connect to PC]	445
[Conformity marking]	448

Item	
[Battery info]	449
[USB power delivery]	450
[Energy saving]	452
[Slot empty release lock]	453
[Save/load menu settings]	454
[Reset all settings]	459
[Firmware version]	459

\* Displayed only when a GPS device is connected.

---

### See Also

“Setup Menu Defaults” (□□204)

---



## Format Memory Card

MENU button ➡  setup menu

Format memory cards. To begin formatting, choose a memory card slot and select [**Yes**]. *Note that formatting permanently deletes all pictures and other data on the card.* Before formatting, be sure to make backup copies as required.



### During Formatting

Do not turn the camera off or remove memory cards until the message [**Format memory card**] clears from the display.

## Save User Settings

MENU button ➡  setup menu

Frequently-used combinations of settings can be assigned to the **U1** to **U3** positions on the mode dial (📖 102).

## Reset User Settings

MENU button ➡  setup menu

Reset settings for **U1** to **U3** to default values (📖 104).

## Language

MENU button ➡  setup menu

Choose a language for camera menus and messages. The languages available vary with the country or region in which the camera was originally purchased.

## Time Zone and Date

MENU button ➡  setup menu



Change time zones and set the camera clock. We recommend that the camera clock be adjusted regularly.

Option	Description
[Time zone]	Choose a time zone. <b>[Date and time]</b> is automatically set to the time in the new time zone.
[Date and time]	Set the camera clock to the time in the selected <b>[Time zone]</b> .
[Date format]	Choose the order in which the day, month, and year are displayed.
[Daylight saving time]	Select <b>[On]</b> to turn daylight saving time on, <b>[Off]</b> to turn it off. Selecting <b>[On]</b> automatically advances the clock one hour. The default setting is <b>[Off]</b> .

A flashing  icon in the shooting display indicates that the clock has not been set.

# Monitor Brightness

MENU button ➡  setup menu





Press  or  to adjust monitor brightness. Choose higher values for increased brightness, lower values for reduced brightness.

- **[Monitor brightness]** can only be adjusted when the monitor is the active display. It cannot be adjusted when **[Viewfinder only]** is selected for monitor mode or when your eye is to the viewfinder.
- Higher values increase the drain on the battery.

# Monitor Color Balance

MENU button →  setup menu

Adjust monitor color balance to your taste.

- **[Monitor color balance]** can only be adjusted when the monitor is the active display. It cannot be adjusted when **[Viewfinder only]** is selected for monitor mode or when your eye is to the viewfinder.
- Color balance is adjusted using the multi selector. Press , , , or  to adjust color balance as shown below. Press  to save changes.

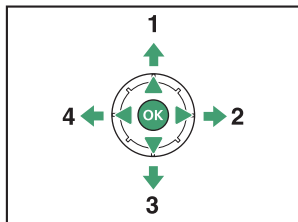
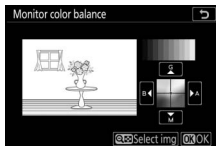

- 1 Increase green
- 2 Increase amber
- 3 Increase magenta
- 4 Increase blue

- Monitor color balance applies only to menus, playback, and the shooting display; photos and movies taken with the camera are not affected.

- The reference image is either the last picture taken or, in playback mode, the picture last displayed. If the memory card contains no pictures, an empty frame will be displayed instead.
- To choose a different picture, press the (?) button. Highlight the desired picture and press to select it as the reference image.
- To view the highlighted picture full frame, press and hold .



## Viewfinder Brightness

MENU button → setup menu

- Adjust viewfinder brightness. **[Viewfinder brightness]** can only be adjusted when the viewfinder is the active display. It cannot be adjusted when the monitor is on or when **[Monitor only]** is selected for monitor mode.
- Higher values increase the drain on the battery.

Option	Description
<b>[Auto]</b>	Viewfinder brightness is adjusted automatically in response to lighting conditions.
<b>[Manual]</b>	Press  or  to adjust brightness manually. Choose higher values for increased brightness, lower values for reduced brightness.

## Viewfinder Color Balance



MENU button ➔  setup menu

Adjust viewfinder color balance to your taste. [**Viewfinder color balance**] can only be adjusted when the viewfinder is the active display. It cannot be adjusted in the monitor or when [**Monitor only**] is selected for monitor mode. Otherwise the procedure is the same as for [**Monitor color balance**] ( 418).

## Limit Monitor Mode Selection

MENU button ➔  setup menu

Choose the monitor modes that can be selected using the  button.

- Highlight options and press  to select () or deselect ().  
Options marked with a check () are available for selection.
- To complete the operation, press .

# Information Display

MENU button ➡  setup menu

Adjust the appearance of the information display according to lighting conditions.



Dark on light

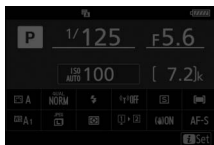

Light on dark







	Option	Description
B	[Dark on light]	To make the display easier to read in bright locations, the monitor lights and the lettering is displayed in black.
W	[Light on dark]	To make the display easier to read in dark locations, the monitor dims and the lettering is displayed in white.

# AF Fine-Tuning Options

MENU button ➔  setup menu

Fine-tune focus for the current lens.

- Use only as required.
- We recommend that you perform fine-tuning at a focus distance you use frequently. If you perform focus-tuning at a short focus distance, for example, you may find it less effective at longer distances.

Option	Description
[AF fine-tune on/off]	<ul style="list-style-type: none"><li>• [On]: Turn AF fine-tuning on.</li><li>• [Off]: Turn AF fine-tuning off.</li></ul>
[Fine-tune and save lens]	<p>Fine-tune focus for the current lens. Press  or  to highlight items and press  or  to choose from values between +20 and -20.</p> <ul style="list-style-type: none"><li>• The larger the fine-tuning value, the farther the focal point is from the lens; the smaller the value, the closer the focal point.</li><li>• The display shows the current and previous values.</li><li>• The camera can store values for up to 40 lens types.</li><li>• New values overwrite existing values.</li></ul>
[Default]	<p>Choose the fine-tuning values for lenses for which no values have previously been saved using [Fine-tune and save lens]. Press  or  to choose from values between +20 and -20.</p>



Option	Description
<p>[List saved values]</p>	<p>List values saved using [Fine-tune and save lens].</p> <p>Highlighting a lens in the list and pressing  displays a [Choose lens number] dialog.</p> <ul style="list-style-type: none"> <li>• The [Choose lens number] dialog is used to enter the lens identifier.</li> <li>• In the case of Z mount lenses and some F mount lenses, the lens serial number is entered automatically.</li> </ul>

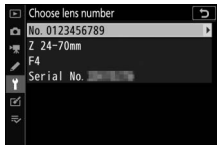

### Deleting Saved Values

To delete values saved using [Fine-tune and save lens], highlight the desired lens in the [List saved values] list and press .

## Creating and Saving Fine-Tuning Values

---

### **1 Attach the lens to the camera.**



---

### **2 Select [AF fine-tuning options] in the setup menu, then highlight [Fine-tune and save lens] and press .**

An AF fine-tuning dialog will be displayed.

---

### **3 Press or to fine-tune autofocus.**

- Choose from values between +20 and -20.
  - The current value is shown by ▲, the previously-selected value by △.
  - If a zoom lens is attached, you can choose separate fine-tuning values for maximum angle (WIDE) and maximum zoom (TELE). Use  and  to choose between the two.
  - The larger the fine-tuning value, the farther the focal point from the lens; the smaller the value, the closer the focal point.
- 

### **4 Press to save the new value.**

## Choosing a Default Fine-Tuning Value

---

**1** Select [AF fine-tuning options] in the setup menu, then highlight [Default] and press .

---

**2** Press  or  to fine-tune autofocus.

- Choose from values between +20 and –20.
  - The current value is shown by ▲, the previously-selected value by Δ.
  - The larger the fine-tuning value, the farther the focal point from the lens; the smaller the value, the closer the focal point.
- 

**3** Press  to save the new value.

## Non-CPU Lens Data

MENU button ➡  setup menu

Record data for non-CPU lenses attached using an optional mount adapter. Recording the focal length and maximum aperture of non-CPU lenses allows them to be used with some camera features normally reserved for CPU lenses, such as on-board vibration reduction.

Option	Description
[Lens number]	Choose a lens identifier.
[Focal length (mm)]	Enter the focal length.
[Maximum aperture]	Enter the maximum aperture.

## Clean Image Sensor

MENU button ➡  setup menu

Dirt or dust entering the camera when lenses are exchanged or the body cap is removed may adhere to the image sensor and affect your photographs. The “clean image sensor” option vibrates the sensor to remove dust.

Option	Description
[Clean now]	Perform image sensor cleaning immediately.
[Automatic cleaning]	<ul style="list-style-type: none"><li>• [Clean at shutdown]: The image sensor is automatically cleaned during shutdown each time the camera is turned off.</li><li>• [Cleaning off]: Automatic image sensor cleaning off.</li></ul>

# Image Dust Off Ref Photo

MENU button ➡ Y setup menu

Acquire reference data for the Image Dust Off option in NX Studio. Image Dust Off processes NEF (RAW) pictures to mitigate effects caused by dust adhering in front of the camera image sensor. For more information, refer to NX Studio's online help.

## Acquiring Image Dust Off Reference Data

### 1 Choose a start option.

- Highlight [**Start**] and press **OK** to immediately display the [**Image Dust Off ref photo**] dialog.

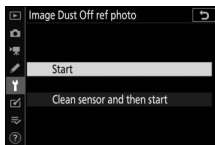

- Highlight [**Clean sensor and then start**] and press **OK** to clean the image sensor before starting. The [**Image Dust Off ref photo**] dialog will be displayed when image sensor cleaning is complete.



- To exit without acquiring Image Dust Off reference data, press **MENU**.

---

## 2 With the lens about ten centimeters (four inches) from a well-lit, featureless white object, frame the object so that it fills the display and then press the shutter-release button halfway.

- In autofocus mode, focus will automatically be set to infinity.
- In manual focus mode, set focus to infinity manually.

---

## 3 Press the shutter-release button the rest of the way down to acquire Image Dust Off reference data.

- The monitor turns off when the shutter-release button is pressed.
- If the reference object is too bright or too dark, the camera may be unable to acquire Image Dust Off reference data and a message will be displayed and the camera will return to the display shown in Step 1. Choose another reference object and press the shutter-release button again.

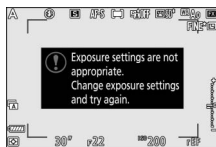

---

## ✔ Image Sensor Cleaning

Dust off reference data recorded before image sensor cleaning is performed cannot be used with photographs taken after image sensor cleaning is performed. Select [**Clean sensor and then start**] only if the Image Dust Off reference data will not be used with existing photographs.

## ✔ Acquiring Image Dust Off Reference Data

- An FX-format lens with a focal length of at least 50 mm is recommended.
- When using a zoom lens, zoom all the way in.
- The same reference data can be used for photographs taken with different lenses or at different apertures.
- Reference images cannot be viewed using computer imaging software.
- A grid pattern is displayed when reference images are viewed on the camera.

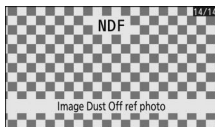

# Pixel Mapping

MENU button ➔  setup menu

Pixel mapping checks and optimizes the camera image sensor. If you notice unexpected bright spots appearing in pictures taken with the camera, perform pixel mapping as described below.

- Pixel mapping is available only when a Z mount lens or an optional FTZ mount adapter is attached.
- To prevent unexpected loss of power, use a fully-charged battery or an optional charging AC adapter or AC adapter and power connector.

---

## 1 Select [Pixel mapping] in the setup menu.

Turn the camera on, press the MENU button, and select **[Pixel mapping]** in the setup menu.

---

## 2 Select [Start].

Pixel mapping will start. A message is displayed while the operation is in progress.

---

## 3 Turn the camera off when pixel mapping is complete.



---

## **Pixel Mapping**

- Do not attempt to operate the camera while pixel mapping is in progress. Do not turn the camera off or remove or disconnect the power source.
  - Pixel mapping may not be available if the camera's internal temperature is elevated.
-

# Image Comment

MENU button ➔  setup menu

Add a comment to new photographs as they are taken. Comments can be viewed in the NX Studio **[Info]** tab.

## **Input Comment**

Input a comment of up to 36 characters. Highlight **[Input comment]** and press  to display a text-entry dialog. For information on text entry, see “Text Entry” (📖226).

## **Attach Comment**

To attach the comment to subsequent photographs, highlight **[Attach comment]**, press , and confirm that a check () appears in the adjacent check box. Press **[OK]** to save changes and exit; the comment will be attached to all subsequent photographs.

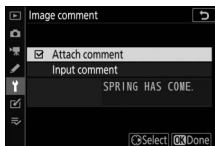

---

### **Photo Info**

Comments can be viewed on the shooting data page in the photo information display.



---

# Copyright Information



MENU button ➡  setup menu

Add copyright information to new photographs as they are taken. Copyright information can be viewed in the NX Studio [Info] tab.

## Artist/Copyright

Enter the names of the photographer (maximum 36 characters) and copyright holder (maximum 54 characters). Highlight [Artist] or [Copyright] or press  to display a text-entry dialog. For information on text entry, see “Text Entry” ( 226).

## Attach Copyright Information

To attach copyright information to subsequent photographs, highlight [Attach copyright information], press , and confirm that a check () appears in the adjacent check box. Press  to save changes and exit; copyright information will be attached to all subsequent photographs.



---

### ✔ Copyright Information

- To prevent unauthorized use of the artist or copyright holder names, make sure that [**Attach copyright information**] is not selected before lending or transferring the camera to another person. You will also need to make sure that the artist and copyright fields are blank.
- Nikon does not accept liability for any damages or disputes arising from the use of the [**Copyright information**] option.

### ✔ Photo Info

Copyright information is included in the shooting data shown in the photo information display.

---

## **Beep On/Off**

Turn the beep speaker on or off.

- If [**On**] is selected for [**Beep on/off**], beeps sound when:
  - the self-timer counts down,
  - interval-timer photography, time-lapse movie recording, or focus shift ends,
  - the camera focuses in photo mode (note that this does not apply if **AF-C** is selected for focus mode or if [**Release**] is selected for Custom Setting a2 [**AF-S priority selection**]),
  - touch controls are used, or
  - the shutter-release button is pressed with a write-protected memory card inserted in the camera.
- Select [**Off (touch controls only)**] to disable the beep for touch controls while enabling it for other purposes.
- When [**On**] is selected for [**Silent photography**] in the photo shooting menu, a beep will not sound when the camera focuses or while the self-timer is in operation, regardless of the settings selected for [**Beep options**].

## Volume

Adjust beep volume.

## Pitch

Choose the pitch of the beep from [**High**] and [**Low**].

## Touch Controls

MENU button ➡  setup menu

Adjust settings for monitor touch controls.

## Enable/Disable Touch Controls

Enable or disable touch controls. Select [**Playback only**] to enable touch controls in playback mode only.

## Full-Frame Playback Flicks

Choose whether the next image in full-frame playback is displayed by flicking left or by flicking right.

Option		Description
←	[Left←Right]	Flick left to display the next picture.
➡	[Left→Right]	Flick right to view the next picture.

## HDMI

MENU button ➡  setup menu

Adjust settings for connection to HDMI devices (📖559).

## Location Data

MENU button ➡  setup menu

Adjust settings for use when the camera is connected to a GPS receiver.

Option	Description
[Standby timer]	If <b>[Enable]</b> is selected when a GPS receiver is connected, the standby timer will expire if no operations are performed for the time selected for Custom Setting c3 <b>[Power off delay]</b> > <b>[Standby timer]</b> . Choose this option to reduce the drain on the battery.
[Position]	View the location data supplied by the GPS receiver. The items displayed vary with the source.
[Set clock from satellite]	Select <b>[Yes]</b> to synchronize the camera clock with the time reported by the GPS device.

## Wireless Remote (WR) Options

MENU button →  setup menu

Adjust status LED and link mode settings for optional WR-R10 wireless remote controllers. You can also choose a link mode for connection to optional radio-controlled flash units that support Advanced Wireless Lighting.

### **LED Lamp**





Enable or disable the status LEDs on a WR-R10 wireless remote controller mounted on the camera. For more information, see the documentation supplied with the wireless remote controller.



## **Link Mode**

Choose a link mode for WR-R10 wireless remote controllers mounted on other cameras or radio-controlled flash units that support Advanced Wireless Lighting. Be sure that the same mode is selected for the other devices.

<b>Option</b>	<b>Description</b>
<b>[Pairing]</b>	<p>The camera connects only to devices with which it has previously been paired. Press the pairing button on the WR-R10 wireless remote controller connected to the camera to pair it with other devices.</p> <ul style="list-style-type: none"><li>• As camera will not communicate with devices with which it has not been paired, this option can be used to prevent signal interference from other devices in the vicinity.</li><li>• Given that each device must be paired separately, however, PIN is recommended when connecting to a large number of devices.</li></ul>

Option	Description
<p>[PIN]</p>	<p>Communication is shared among all devices with the same four-digit PIN. Connect using a four-digit PIN. Press  or  to highlight digits and press  or  to change. Press  to enter and display the selected PIN.</p> <ul style="list-style-type: none"> <li>• This option is a good choice for photography featuring a large number of remote devices.</li> <li>• If there are multiple cameras present that share the same PIN, the flash units will be under the sole control of the camera that connects first, preventing all other cameras from connecting (the LEDs on the WR-R10 units connected to the affected cameras will blink).</li> </ul>

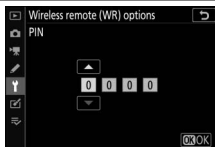

- Regardless of the option selected for [Link mode], signals from paired wireless remote controllers will always be received by the WR-R10. Users of the WR-1 wireless remote controller will need to select pairing as the WR-1 link mode.









### The WR-R10 Wireless Remote Controller

Be sure the firmware for the WR-R10 has been updated to the latest version (version 3.0 or later). For information on firmware updates, see the Nikon website for your area.

## Assign Remote (WR) Fn Button

MENU button ➡  setup menu

Choose the role played by the **Fn** button on optional wireless remote controllers equipped with an **Fn** button. See Custom Setting f2 [**Custom controls**] for more information.

Option		Option	
 [AF-ON]		 [FV lock]	
 [AF lock only]		 [Disable/enable]	
 [AE lock (Reset on release)]		 [Preview]	
 [AE lock only]		+  [+ NEF (RAW)]	
 [AE/AF lock]		[None]	

## Airplane Mode

MENU button ➡  setup menu

Select [**Enable**] to disable the camera's built-in Bluetooth and Wi-Fi functions.

- The wireless functions of optional peripheral devices connected to the camera can only be disabled by disconnecting the devices.

## Connect to Smart Device

MENU button ➔  setup menu

Connect to smartphones or tablets (smart devices) via Bluetooth or Wi-Fi.

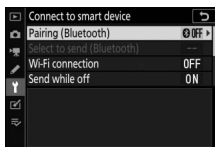

### Pairing (Bluetooth)

Pair with or connect to smart devices using Bluetooth.

Option	Description
[Start pairing]	Pair the camera with a smart device (📱 534).
[Paired devices]	List paired smart devices. To connect, select a device from the list.
[Bluetooth connection]	Select [Enable] to enable Bluetooth.

## **Select to Send (Bluetooth)**

Select pictures for upload to a smart device. You can also opt to upload pictures as they are taken.

<b>Option</b>	<b>Description</b>
<b>[Auto select to send]</b>	Select <b>[On]</b> to mark pictures for upload as they are taken. Photos are uploaded in JPEG format at a size of 2 megapixels, even if other upload size and format options are selected with the camera. Photos taken in movie mode will not be uploaded. They must be uploaded manually.
<b>[Manual select to send]</b>	Upload selected pictures. Transfer marking appears on the selected pictures.
<b>[Deselect all]</b>	Remove transfer marking from all pictures.

## **Wi-Fi Connection**

Connect to smart devices via Wi-Fi.

### **■ Establish Wi-Fi Connection**

Initiate a Wi-Fi connection to a smart device.

- The camera SSID and password will be displayed. To connect, select the camera SSID on the smart device and enter the password (☐525).
- Once a connection is established, this option will change to **[Close Wi-Fi connection]**.
- Use **[Close Wi-Fi connection]** to end the connection when desired.

## Wi-Fi Connection Settings

Access the following Wi-Fi settings:

Option	Description
[SSID]	Choose the camera SSID.
[Authentication/encryption]	Choose [OPEN] or [WPA2-PSK-AES].
[Password]	Choose the camera password.
[Channel]	Choose a channel. <ul style="list-style-type: none"><li>• Select [Auto] to have the camera choose the channel automatically.</li><li>• Select [Manual] to choose the channel manually.</li></ul>
[Current settings]	View current Wi-Fi settings.
[Reset connection settings]	Select [Yes] to reset Wi-Fi settings to default values.

## Send While Off

If [On] is selected, upload of images to smart devices connected via Bluetooth will continue even when the camera is off.

## Location Data (Smart Device)

Display latitude, longitude, altitude, and UTC (Universal Coordinated Time) data downloaded from a smart device.

# Connect to PC

MENU button ➡ ⌘ setup menu

Connect to computers via Wi-Fi.



## Wi-Fi Connection

Select [**Enable**] to connect using the settings currently selected for [**Network settings**].

## Network Settings

Select [**Create profile**] to create a new network profile (□ 501, 507).

- If more than one profile already exists, you can press Ⓚ to select a profile from a list.
- To edit an existing profile, highlight it and press ⌂.

Option	Description
[General]	<ul style="list-style-type: none"><li>• [<b>Profile name</b>]: Rename the profile. The default profile name is the same as the network SSID.</li><li>• [<b>Password protection</b>]: Select [<b>On</b>] to require that a password be entered before the profile can be changed. To change the password, highlight [<b>On</b>] and press ⌂.</li></ul>

Option	Description
[Wireless]	<ul style="list-style-type: none"> <li>• <b>Infrastructure mode:</b> Adjust settings for connection to a network via a router.               <ul style="list-style-type: none"> <li>- [SSID]: Enter the network SSID.</li> <li>- [Channel]: Selected automatically.</li> <li>- [Authentication/encryption]: Choose [OPEN] or [WPA2-PSK-AES].</li> <li>- [Password]: Enter the network password.</li> </ul> </li> <li>• <b>Access-point mode:</b> Adjust settings for direct wireless connection to the camera.               <ul style="list-style-type: none"> <li>- [SSID]: Choose the camera SSID.</li> <li>- [Channel]: Choose [Auto] or [Manual].</li> <li>- [Authentication/encryption]: Choose [OPEN] or [WPA2-PSK-AES].</li> <li>- [Password]: If [WPA2-PSK-AES] is selected for [Authentication/encryption], you can choose the camera password.</li> </ul> </li> </ul>
[TCP/IP]	<p>Adjust TCP/IP settings for infrastructure connections. An IP address is required.</p> <ul style="list-style-type: none"> <li>• If [Enable] is selected for [Obtain automatically], the IP address and sub-net mask for infrastructure mode connections will be acquired via a DHCP server or automatic IP addressing.</li> <li>• Select [Disable] to enter the IP address ([Address]) and sub-net mask ([Mask]) manually.</li> </ul>



## **Options**

Adjust upload settings.

### **■ Auto Send**

Select **[On]** to upload new photos as they are taken.

- Upload begins only after the photo has been recorded to the memory card. Be sure a memory card is inserted in the camera.
- Movies and photos taken during movie mode are not uploaded automatically when recording is complete. They must instead be uploaded from the playback display (☐ 516).

### **■ Delete After Send**

Select **[Yes]** to delete photographs from the camera memory card automatically once upload is complete.

- Files marked for transfer before you selected **[Yes]** are not deleted.
- Deletion may be suspended during some camera operations.

### **■ Send File As**

When uploading NEF + JPEG images, choose whether to upload both the NEF (RAW) and JPEG files or only the JPEG copy.

- When **[RAW Slot 1 - JPEG Slot 2]** is selected for **[Role played by card in Slot 2]** in the photo shooting menu, the option chosen for **[Send file as]** applies only to photos uploaded automatically by selecting **[On]** for **[Auto send]**.

## ■ Deselect All?

Select [**Yes**] to remove transfer marking from all images. Upload of images with a “sending” icon will immediately be terminated.

## MAC Address

View the MAC address.

## Conformity Marking

MENU button ➡  setup menu

View some of the standards with which the camera complies.

# Battery Info

MENU button ➡ Y setup menu

View information on the battery currently inserted in the camera.

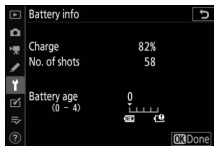

Option	Description
[Charge]	The current battery level, expressed as a percentage.
[No. of shots]	The number of times the shutter has been released since the battery was last charged.
[Battery age]	A five-level display showing battery age. <ul style="list-style-type: none"><li>• A value of "0" (<b>NEW</b>) indicates that battery performance is unimpaired.</li><li>• A value of "4" (<b>LO</b>) indicates that the battery has reached the end of its charging life. Replace the battery.</li></ul>

## ✓ Number of Shots

[No. of shots] shows the number of times the shutter has been released. Note that the camera may sometimes release the shutter without recording a photograph, for example when measuring preset manual white balance.

## ✓ Charging Batteries at Low Temperatures

Batteries in general exhibit a drop in capacity at low ambient temperatures. Even fresh batteries charged at temperatures under about 5 °C (41 °F) may show a temporary increase from "0" to "1" in the value shown for [Battery age], but the display will return to normal once the battery has been recharged at a temperature of about 20 °C (68 °F) or higher.

# USB Power Delivery

MENU button ➔  setup menu

Choose whether optional charging AC adapters or computers connected via USB can be used to power the camera (USB power delivery). USB power delivery allows the camera to be used while limiting the drain on the battery.

Option	Description
[Enable]	The camera draws power from connected devices while on. Connected devices will also supply power when the camera is off if Bluetooth upload is in progress or the memory card access lamp is lit.
[Disable]	The camera does not draw power from connected devices at any time.

- Power will only be supplied to the camera when the battery is inserted.
- A USB power delivery icon appears in the shooting display when the camera is powered by an external source.
- For more information, see “Charging AC Adapters” (p. 654).

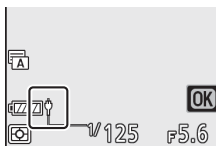

## ✔ Computer USB Power Delivery

- Before using a computer to supply power to the camera, check that the computer is equipped with a Type C USB connector. Use a UC-E25 USB cable (available separately) to connect the camera to the computer.
- Depending on the model and product specifications, some computers will not supply current to power the camera.

## ✔ “Power Delivery” Versus “Charging”

The supply of power for camera operations is referred to as “power delivery”, while the term “charging” is used when power is supplied only to charge the camera battery. The conditions under which the power supplied by external devices is used to power the camera or charge the battery are shown below.

Option selected for [USB power delivery]	Camera	External power source used for
[Enable]	On <sup>1</sup>	Power delivery
	Off	Charging <sup>2</sup>
[Disable]	On <sup>1</sup>	—
	Off	Charging <sup>2</sup>

- 1 Includes instances in which the power switch is in the “OFF” position but Bluetooth upload is in progress or the memory card access lamp is lit.
- 2 EN-EL15c and EN-EL15b batteries inserted in the camera will charge when the camera is connected to an optional charging AC adapter or via USB to a computer.

# Energy Saving

MENU button ➡  setup menu

In photo mode, the shooting display will dim to save power approximately 15 seconds before the standby timer expires.

Option	Description
[Enable]	Enable energy saving. The display refresh rate may drop.
[Disable]	Disable energy saving. Note selecting [Disable] does not stop the shooting display dimming a few seconds before the standby expires.

## ✔ Energy Saving

- Note that even when [Enable] is selected, energy saving will not function:
  - if [No limit] is selected for Custom Setting c3 [Power off delay] > [Standby timer] or if the delay selected is less than 30 seconds,
  - during zoom,
  - while the camera is connected to another device via HDMI,
  - while the camera is connected to and exchanging data with a computer via USB, or
  - while the camera is connected to an AC adapter.
- Selecting [Disable] increases the drain on the battery.

# Slot Empty Release Lock

MENU button ➡  setup menu

Choose whether the shutter can be released when no memory card is inserted in the camera.

	Option	Description
LOCK	[ <b>Release locked</b> ]	The shutter cannot be released when no memory card is inserted.
OK	[ <b>Enable release</b> ]	The shutter can be released with no memory card inserted. No pictures will be recorded; during playback, the camera displays [ <b>Demo</b> ].

# Save/Load Menu Settings

MENU button ➡  setup menu

Save current camera menu settings to a memory card. You can also load saved settings, allowing menu settings to be shared among cameras of the same model.

- If two memory cards are inserted, the settings will be saved to the card in Slot 1.
- The following settings are saved:

## Settings that can be saved and loaded

PLAYBACK MENU	[Playback display options]
	[Dual-format recording PB slot]
	[Image review]
	[After delete]
	[Rotate tall]



## Settings that can be saved and loaded

### PHOTO SHOOTING MENU

[File naming]
[Role played by card in Slot 2]
[Choose image area]
[Image quality]
[Image size]
[NEF (RAW) recording]
[ISO sensitivity settings]
[White balance]
[Set Picture Control] (Custom Picture Controls are saved as [Auto])
[Color space]
[Active D-Lighting]
[Long exposure NR]
[High ISO NR]
[Vignette control]
[Diffraction compensation]
[Auto distortion control]
[Flicker reduction shooting]
[Metering]
[Flash control]
[Flash mode]
[Flash compensation]
[Focus mode]
[AF-area mode]
[Vibration reduction] (the options available vary with the lens)
[Auto bracketing]

## Settings that can be saved and loaded

MOVIE SHOOTING MENU	[File naming]
	[Destination]
	[Choose image area]
	[Frame size/frame rate]
	[Movie quality]
	[Movie file type]
	[ISO sensitivity settings]
	[White balance]
	[Set Picture Control] (Custom Picture Controls are saved as [Auto])
	[Active D-Lighting]
	[High ISO NR]
	[Vignette control]
	[Diffraction compensation]
	[Auto distortion control]
	[Flicker reduction]
	[Metering]
	[Focus mode]
	[AF-area mode]
	[Vibration reduction] (the options available vary with the lens)
	[Electronic VR]
	[Microphone sensitivity]
[Attenuator]	
[Frequency response]	
[Wind noise reduction]	
[Headphone volume]	
[Timecode] (excepting [Timecode origin])	

## Settings that can be saved and loaded

CUSTOM SETTING MENU	All items
SETUP MENU	[Language]
	[Time zone and date] (excepting [Date and time])
	[Limit monitor mode selection]
	[Information display]
	[Non-CPU lens data]
	[Clean image sensor]
	[Image comment]
	[Copyright information]
	[Beep options]
	[Touch controls]
	[HDMI]
	[Location data] (excepting [Position])
	[Wireless remote (WR) options]
	[Assign remote (WR) Fn button]
	[USB power delivery]
	[Energy saving]
	[Slot empty release lock]

## **Save Menu Settings**

Save settings to a memory card. If the card is full, an error will be displayed and settings will not be saved. Saved settings can only be used with other cameras of the same model.

## **Load Menu Settings**

Load saved settings from a memory card. Note that [**Load menu settings**] is available only when a memory card containing saved settings is inserted.

---

### **✔ Saved Settings**

Settings are saved to files named "NCSET\*\*\*\*". "\*\*\*\*" is an identifier that varies from camera to camera. The camera will not be able to load settings if the file name is changed.

---

## Reset All Settings

MENU button ➡  setup menu

Reset all settings except [**Language**] and [**Time zone and date**] to their default values. Copyright information and other user-generated entries are also reset. Once reset, settings cannot be restored.

We recommend that you save settings using the [**Save/load menu settings**] item in the setup menu before performing a reset.

## Firmware Version

MENU button ➡  setup menu

View the current camera firmware version.





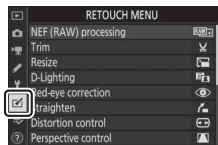

## The Retouch Menu: Creating Retouched Copies







To view the retouch menu, select the  tab in the camera menus.



The items in the retouch menu are used to trim or retouch existing pictures.

- The retouch menu is only displayed when a memory card containing pictures is inserted in the camera.
- Retouched copies are saved to new files, separate from the original pictures.
- The retouch menu contains the following items:



	Item	
	[NEF (RAW) processing]	464
	[Trim]	469
	[Resize]	470
	[D-Lighting]	475
	[Red-eye correction]	476
	[Straighten]	477

	Item	
	[Distortion control]	478
	[Perspective control]	479
	[Monochrome]	480
	[Image overlay] *	481
	[Trim movie]	490

\* Not displayed when [Retouch] is selected in the playback  menu.



# Creating Retouched Copies

## 1 Select an item in the retouch menu.

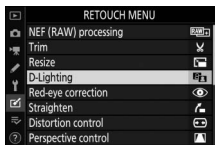
Press  or  to highlight an item,  to select.



## 2 Select a picture.



- Highlight a picture using the multi selector.
- To view the highlighted picture full screen, press and hold the  button.
- Press  to select the highlighted picture.



## 3 Select retouch options.

- For more information, see the section for the selected item.
- To exit without creating a retouched copy, press **MENU**. The retouch menu will be displayed.

## 4 Create a retouched copy.

- Press  to create a retouched copy.
- Retouched copies are indicated by a  icon.

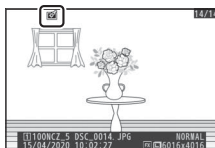

---

## ✓ Retouching the Current Picture

To create a retouched copy of the current image, press **i** and select **[Retouch]**.

## ✓ Retouch

- The camera may not be able to display or retouch images that were taken or retouched using other cameras or that have been retouched on a computer.
- If no actions are performed for a brief period, the display will turn off and any unsaved changes will be lost. To increase the time the display remains on, choose a longer menu display time using Custom Setting c3 **[Power off delay]** > **[Menus]**.

## ✓ Retouching Copies

- Most items can be applied to copies created using other retouch options, although multiple edits may result in reduced image quality or faded colors.
- With the exception of **[Trim movie]**, each item can be applied only once.
- Some items may be unavailable depending on the items used to create the copy.
- Items that cannot be applied to the current image are grayed out and unavailable.



### ✔ Image Quality

- Copies created from NEF (RAW) pictures are saved at an [Image quality] of [JPEG fine ★].
- Copies created from JPEG pictures are the same quality as the original.
- In the case of dual-format pictures recorded to the same memory card at image-quality settings of NEF + JPEG, only the NEF (RAW) copy will be retouched.

### ✔ Image Size

Except in the case of copies created with [NEF (RAW) processing], [Trim], and [Resize], copies are the same size as the original.

---

# NEF (RAW) Processing: Converting NEF (RAW) to JPEG

MENU button ➡  retouch menu



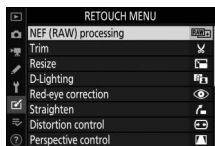

The process of converting NEF (RAW) images to other formats such as JPEG is referred to as “NEF (RAW) processing”. JPEG copies of NEF (RAW) pictures can be created on the camera as described below.

## 1 Select [NEF (RAW) processing] in the retouch menu.

Highlight [**NEF (RAW) processing**] and press .



## 2 Choose a destination.

- If two memory cards are inserted, highlight [**Choose destination**] and press .
- [**Choose destination**] is not available when only one memory card is inserted. Proceed to Step 3.
- Press  or  to highlight a card slot and press .

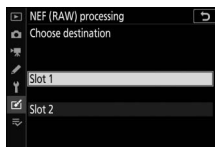
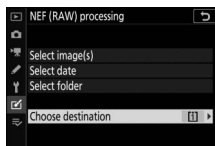

### 3 Choose how images are selected.

Option	Description
[ <b>Select image(s)</b> ]	Create JPEG copies of selected NEF (RAW) images. Multiple NEF (RAW) images can be selected.
[ <b>Select date</b> ]	Create JPEG copies of all NEF (RAW) pictures taken on selected dates.
[ <b>Select folder</b> ]	Create JPEG copies of all NEF (RAW) pictures in a selected folder.

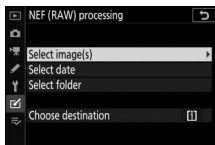

If you chose [**Select image(s)**], proceed to Step 5.



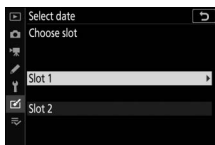

### 4 Select the source slot.

- Highlight the slot with the card containing the NEF (RAW) images and press .
- You will not be prompted to select the slot if only one memory card is inserted.





## 5 Select photographs.

### If you chose [Select image(s)]:

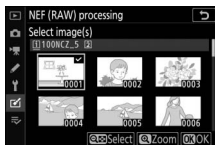
- Highlight pictures using the multi selector.
- To view the highlighted picture full screen, press and hold the  button.
- To select the highlighted image, press the  (?). Selected pictures are marked by a  icon. To deselect the current picture, press the  (?). The  will no longer be displayed. All images will be processed using the same settings.
- Press  to proceed once selection is complete.



### If you chose [Select date]:

- Highlight dates using the multi selector and press  to select () or deselect () .
- All images taken on dates marked with a check () will be processed using the same settings.
- Press  to proceed once selection is complete.

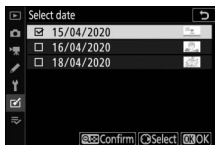

### If you chose [Select folder]:

Highlight a folder and press  to select; all images in the selected folder will be processed using the same settings.

## 6 Choose settings for the JPEG copies.

- The settings in effect when the photograph was taken appear below a preview.
- To use the setting in effect when the photograph was taken, if applicable, select [**Original**].

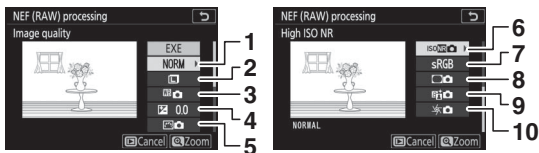

- |   |                              |
|---|------------------------------|
| 1 | Image quality (☐234)         |
| 2 | Image size (☐235)            |
| 3 | White balance (☐239)         |
| 4 | Exposure compensation (☐109) |
| 5 | Set Picture Control (☐247)   |

- |    |                                 |
|----|---------------------------------|
| 6  | High ISO NR (☐258)              |
| 7  | Color space (☐254)              |
| 8  | Vignette control (☐259)         |
| 9  | Active D-Lighting (☐255)        |
| 10 | Diffraction compensation (☐260) |

- To exit without copying the photographs, press the  button.

## 7 Copy the photographs.

- Highlight **[EXE]** and press **OK** to create JPEG copies of the selected photographs.
- If multiple photos are selected, a confirmation dialog will be displayed after you highlight **[EXE]** and press **OK**; highlight **[Yes]** and press **OK** to create JPEG copies of the selected photos.
- To cancel the operation before all copies have been created, press the **MENU** button; when a confirmation dialog is displayed, highlight **[Yes]** and press **OK**.

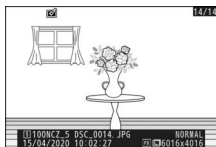



### ✓ NEF (RAW) Processing

- NEF (RAW) processing is available only with NEF (RAW) images created with this camera. Pictures in other formats and NEF (RAW) photos taken with other cameras or Camera Control Pro 2 cannot be selected.
- **[Exposure compensation]** can only be set to values between  $-2$  and  $+2$  EV.

# Trim

MENU button ➡  retouch menu

Create a cropped copy of the selected photograph. The photograph is displayed with the selected crop shown in yellow; create a cropped copy as described below.

To	Description
<b>Size the crop</b>	Press  or  (?) to choose the crop size.
<b>Change the crop aspect ratio</b>	Rotate the main command dial to choose the aspect ratio.
<b>Position the crop</b>	Use the multi selector to position the crop.
<b>Save the crop</b>	Press  to save the current crop as a separate file.

## Cropped Pictures

- Depending on the size of the cropped copy, playback zoom may not be available when cropped copies are displayed.
- The crop size appears at upper left in the crop display. The size of the copy varies with crop size and aspect ratio.



# Resize

MENU button ➡  retouch menu

Create small copies of selected photographs. If two memory cards are inserted, you can choose the card used to store the resized copies.

## Resizing Multiple Images



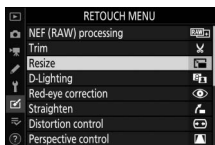

If you accessed the retouch menu via the MENU button, you can resize multiple selected images.

### 1 Select [Resize] in the retouch menu.

Highlight [Resize] and press .





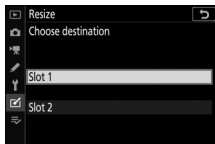
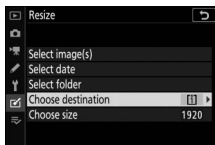

### 2 Choose a destination.

- If two memory cards are inserted, highlight [Choose destination] and press .
- [Choose destination] is not available when only one memory card is inserted. Proceed to Step 3.
- Press  or  to highlight a card slot and press .





### 3 Choose a size.

- Highlight [**Choose size**] and press .
- Highlight the desired size (length in pixels) using  and  and press .

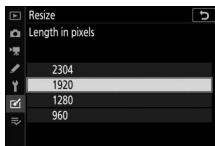
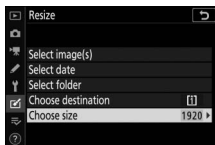

### 4 Choose how pictures are selected.

Option	Description
[ <b>Select image(s)</b> ]	Resize selected pictures. Multiple pictures can be selected.
[ <b>Select date</b> ]	Resize all pictures taken on selected dates.
[ <b>Select folder</b> ]	Resize all pictures in a selected folder.

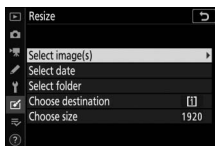

If you chose [**Select image(s)**], proceed to Step 6.





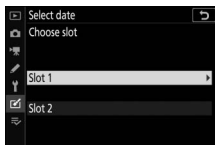

## 5 Select the source slot.

- Highlight the slot with the card containing the desired pictures and press .
- You will not be prompted to select the slot if only one memory card is inserted.







## 6 Choose pictures.

### If you chose [Select image(s)]:

- Highlight pictures using the multi selector.
- To view the highlighted picture full screen, press and hold the  button.
- To select the highlighted picture, press the  (?) button. Selected pictures are indicated by a  icon. To deselect the current picture, press the  (?) button again; the  will no longer be displayed. The selected pictures will all be copied at the size selected in Step 3.
- Press  to proceed once selection is complete.



### If you chose [Select date]:

- Highlight dates using the multi selector and press  to select () or deselect () .
- All pictures taken on dates marked with a check () will be copied at the size selected in Step 3.
- Press  to proceed once selection is complete.

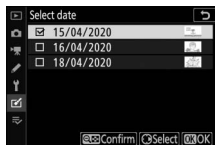

### If you chose [Select folder]:

Highlight a folder and press  to select; all pictures in the selected folder will be copied at the size selected in Step 3.

## 7 Save the resized copies.

- A confirmation dialog will be displayed; highlight **[Yes]** and press **OK** to save the resized copies.
- To cancel the operation before all copies have been created, press the **MENU** button; when a confirmation dialog is displayed, highlight **[Yes]** and press **OK**.

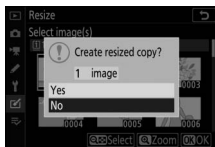

---

### ✓ **Resize**

Depending on the copy size, playback zoom may not be available when resized copies are displayed.

---

# D-Lighting

MENU button ➡  retouch menu

D-Lighting brightens shadows. It is ideal for dark or backlit photographs.

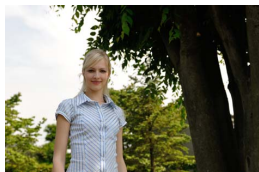



Before



After

The edit display shows before and after images.

- Press  or  to choose the amount of correction performed. The effect can be previewed in the edit display.
- Press  to save the retouched copy.



# Red-Eye Correction

MENU button ➡  retouch menu

Correct “red-eye” caused by light from the flash reflecting from the retinas of portrait subjects.

- Red-eye correction is available only with photographs taken using a flash.
- Red-eye that cannot be detected by the camera will not be corrected.
- Press  to save the retouched copy.

---



## Red-Eye Correction

- Note the following:
    - Red-eye correction may not always produce the expected results.
    - In very rare circumstances, red-eye correction may be applied to portions of the image that are not affected by red-eye.
  - Check the preview thoroughly before proceeding.
-

# Straighten

MENU button ➡  retouch menu

Rotate pictures by up to  $\pm 5^\circ$  in increments of approximately  $0.25^\circ$ .

- The effect can be previewed in the edit display.
- The greater the rotation, the more will be trimmed from the edges.
- Press  or  to choose the amount of straightening performed.
- Press  to save the retouched copy.

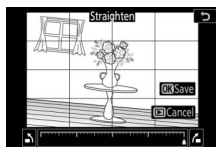



# Distortion Control

MENU button ➡  retouch menu

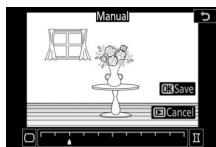
Create copies with reduced peripheral distortion; this can reduce barrel distortion in pictures taken with wide-angle lenses or pin-cushion distortion in pictures taken with telephoto lenses.



Select [**Auto**] to let the camera correct distortion automatically and then make fine adjustments using the multi selector. Select [**Manual**] to reduce distortion manually.

- The effect can be previewed in the edit display.
- Note that [**Manual**] must be used with copies created using the [**Auto**] option and with photos taken using the [**Auto distortion control**] option in the photo shooting menu. Manual distortion control cannot be further applied to copies created using [**Manual**].
- Press  to reduce pincushion distortion,  to reduce barrel distortion.
- Press  to save the retouched copy.

---

## Distortion Control

Note that greater amounts of distortion control result in more of the edges being cropped out.

---



# Perspective Control

MENU button ➡  retouch menu

Create copies that reduce the effects of perspective in photos taken looking up from the base of a tall object.

- The effect can be previewed in the edit display.
- Note that greater amounts of perspective control result in more of the edges being cropped out.
- Use the multi selector (⬆️, ⬇️, ⬇️, or ⬆️) to adjust perspective.
- Press  to save the retouched copy.



Before





After

# Monochrome

MENU button ➡  retouch menu

Copy photographs in monochrome. [**Monochrome**] gives you a choice of the following monochrome tints:

Option	Description
[ <b>Black-and-white</b> ]	Copy photographs in black-and-white.
[ <b>Sepia</b> ]	Copy photographs in sepia.
[ <b>Cyanotype</b> ]	Copy photographs in blue-and-white monochrome.

- The effect can be previewed in the edit display.
- In the case of [**Sepia**] or [**Cyanotype**], color saturation can be adjusted using the multi selector. Press  to increase,  to decrease. The changes are reflected in the preview.
- Press  to save the retouched copy.

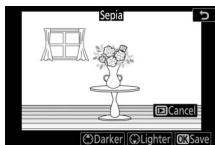

# Image Overlay

MENU button ➡  retouch menu

Image overlay combines existing photographs to create a single picture that is saved separately from the originals. One NEF (RAW) image can be overlaid on another using additive blending ([**Add**]), or multiple images can be combined using [**Lighten**] or [**Darken**].

## Add

Overlay two NEF (RAW) images to create a single new JPEG copy.



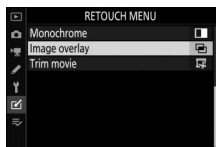

### 1 Select [Image overlay] in the retouch menu.

Highlight [**Image overlay**] and press



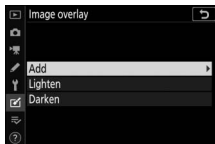

## 2 Select [Add].

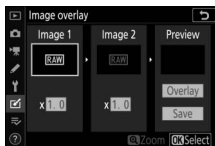

Highlight **[Add]** and press  to display image overlay options with **[Image 1]** highlighted.



## 3 Highlight the first image.

- Press  to display a picture-selection dialog listing only NEF (RAW) images, where you can use the multi selector to highlight the first photograph in the overlay.
- To view the highlighted picture full screen, press and hold the  button.

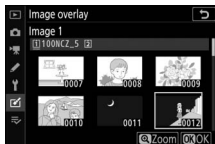

## 4 Select the first image.

Press  to select the highlighted photograph and return to the preview display; the selected image will appear as **[Image 1]**.

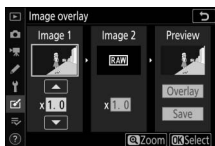

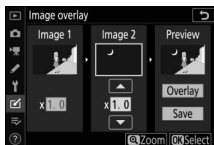

## 5 Select the second image.

Press  and select **[Image 2]**, then select the second photo as described in Steps 3 and 4.



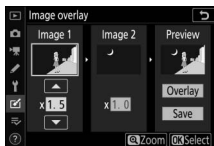

## 6 Adjust gain.

- The overlay of **[Image 1]** and **[Image 2]** can be previewed in the "Preview" column. Highlight **[Image 1]** or **[Image 2]** and optimize exposure for the overlay by pressing  or  to adjust gain.
- Choose from values between 0.1 and 2.0 in increments of 0.1.
- The effects are relative to the default value of 1.0 (no gain). For example, selecting 0.5 halves gain.



## 7 Select the "Preview" column.

- Press  or  to place the cursor in the "Preview" column.
- To proceed without previewing the overlay, highlight **[Save]** and press .

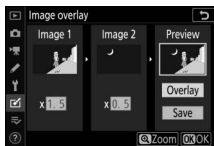

---

## 8 Preview the overlay.

- To preview the overlay, highlight [**Overlay**] and press **OK**.
- To select new photos or adjust gain, press **Q** (?) . You will be returned to Step 6.



---

## 9 Save the overlay.

Press **OK** while the preview is displayed to save the overlay and display the resulting image.



---

## ✓ [Add]

- Colors and brightness in the preview may differ from the final image.
  - Image overlay is available only with NEF (RAW) images created with this camera. Images created with other cameras or in other formats cannot be selected.
  - The overlay is saved at an [Image quality] of [JPEG fine ★].
  - NEF (RAW) pictures can be combined only if they were created with the same options selected for:
    - [Choose image area]
    - [NEF (RAW) recording] > [NEF (RAW) bit depth]
  - The overlay has the same photo info (including date of recording, metering, shutter speed, aperture, shooting mode, exposure compensation, focal length, and image orientation) and values for white balance and Picture Control as the photograph selected for [Image 1]. Copyright information, however, is not copied to the new image. The comment is similarly not copied; instead, the comment currently active on the camera, if any, is appended.
-

## Lighten and Darken

The camera compares multiple selected pictures and selects only the brightest or darkest pixels at each point in the image to create a single new JPEG copy.

---

### 1 Select [Lighten] or [Darken].

After selecting [**Image overlay**] in the retouch menu, highlight either [**Lighten**] or [**Darken**] and press .

- [**Lighten**]: The camera compares the pixels in each picture and uses only the brightest.



- [**Darken**]: The camera compares the pixels in each picture and uses only the darkest.





---

## 2 Choose how pictures are selected.

Option	Description
[Select individual images]	Select pictures for the overlay one-by-one.
[Select consecutive images]	Select two pictures; the overlay will include the two pictures and all images between them.
[Select folder]	The overlay will include all pictures in the selected folder.







---

## 3 Select the source slot.





- Highlight the slot with the card containing the desired pictures and press .
  - You will not be prompted to select the slot if only one memory card is inserted.
- 

## 4 Select pictures.

### If you chose [Select individual images]:

- Highlight pictures using the multi selector.
- To view the highlighted picture full screen, press and hold the  button.
- To select the highlighted picture, press the  (?) button. Selected pictures are marked by a  icon. To deselect the current picture, press the  (?) button again; the  icon will no longer be displayed. The selected pictures will be combined using the option selected in Step 1.
- Press  to proceed once selection is complete.

### **If you chose [Select consecutive images]:**

- All pictures in a range chosen using the multi selector will be combined using the option selected in Step 1.
  - Use the  (?) to select the first and last pictures in the desired range.
  - The first and last pictures are indicated by  icons and the pictures between them by  icons.
  - You can alter your selection by using the multi selector to highlight different pictures to serve as the first or last frame. Press the center of the sub-selector to choose the current picture as the new start or end point.
- To view the highlighted picture full screen, press and hold the  button.
- Press  to proceed once selection is complete.

### **If you chose [Select folder]:**

Highlight the desired folder and press  to overlay all pictures in the folder using the option selected in Step 1.

---

## 5 Save the overlay.

- A confirmation dialog will be displayed; highlight [**Yes**] and press **OK** to save the overlay and display the resulting picture.
- To interrupt the process and display a confirmation dialog before the operation is complete, press the **MENU** button; to save the current overlay “as is” without adding the remaining pictures, highlight [**Save and exit**] and press **OK**. To exit without creating an overlay, highlight [**Discard and exit**] and press **OK**.

---

### ✓ [Lighten]/[Darken]

- The overlay will include only pictures created with this camera. Pictures created with other cameras cannot be selected.
  - The overlay will include only pictures created with the same options selected for:
    - [**Choose image area**]
    - [**Image size**]
  - The image quality setting for the completed overlay is that of the highest quality picture it contains.
  - Overlays that include NEF (RAW) pictures will be saved at an image quality of [**JPEG fine★**].
  - The size of overlays that include both NEF (RAW) and JPEG images is determined by the JPEG picture.
-

## Trim Movie

MENU button ➡  retouch menu

Create a copy from which unwanted footage has been removed (📖 178).

## ☰ My Menu/⌚ Recent Settings

To view [**MY MENU**], select the ☰ tab in the camera menus.

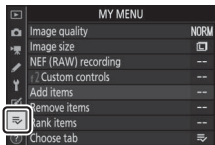

### ☰ My Menu: Creating a Custom Menu

My Menu can be used to create and edit a customized list of up to 20 items from the playback, photo shooting, movie shooting, Custom Settings, setup, and retouch menus. Options can be added, deleted, and reordered as described below.

#### ■ Adding Items to My Menu

##### 1 Select [Add items] in [☰ MY MENU].

Highlight [**Add items**] and press ⏪.

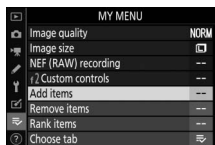

## 2 Select a menu.

Highlight the name of the menu containing the item you wish to add and press .

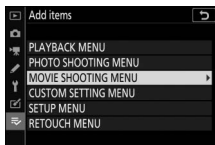

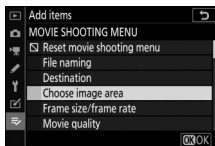

## 3 Select an item.

Highlight the desired menu item and press .



## 4 Position the new item.

Press  or  to position the new item and press  to add it to My Menu.

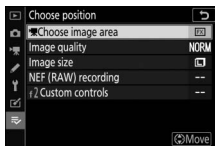

## 5 Add more items.

- The items currently displayed in My Menu are indicated by a check mark (✓).
- Items indicated by a  icon cannot be selected.
- Repeat Steps 1–4 to select additional items.

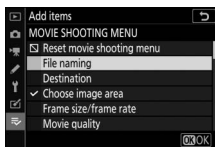

## ■ Removing Items from My Menu

### 1 Select [Remove items] in [≡ MY MENU].

Highlight [Remove items] and press .

### 2 Select items.

- Highlight items and press  to select () or deselect.
- Continue until all the items you wish to remove are selected ().

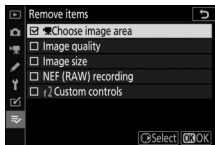



### 3 Remove the selected items.

Press **J**; a confirmation dialog will be displayed. Press **OK** again to remove the selected items.



### ✓ Removing Items While in My Menu

Items can also be removed by highlighting them in [≡ MY MENU] and pressing the  button; a confirmation dialog will be displayed. Press  again to remove the selected item.

## ■ Reordering Items in My Menu

### 1 Select [Rank items] in [≡ MY MENU].



Highlight [Rank items] and press .

### 2 Select an item.

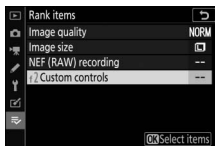
Highlight the item you wish to move and press .



### 3 Position the item.

- Press  or  to move the item up or down in My Menu and press .
- Repeat Steps 2–3 to reposition additional items.



### 4 Exit to [≡ MY MENU].

Press the MENU button to return to [≡ MY MENU].

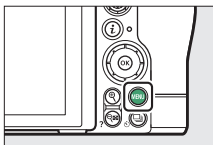





## ■ Displaying [RECENT SETTINGS]

### 1 Select [Choose tab] in [≡ MY MENU].

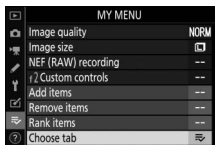
Highlight [**Choose tab**] and press .



### 2 Select [RECENT SETTINGS].

- Highlight [RECENT SETTINGS] in the [**Choose tab**] menu and press .
- The name of the menu will change from [MY MENU] to [RECENT SETTINGS].

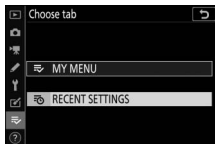

## ☰ Recent Settings: Accessing Recently-Used Settings

### ■ How Items Are Added to [RECENT SETTINGS]

Menu items are added to the top of the [RECENT SETTINGS] menu as they are used. The twenty most recently-used settings are listed.

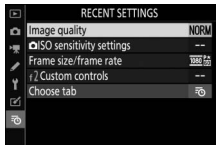

---

### ✓ Removing Items from the Recent Settings Menu

To remove an item from the [RECENT SETTINGS] menu, highlight it and press the ☑ button; a confirmation dialog will be displayed. Press ☑ button again to remove the selected item.

### ✓ Displaying My Menu

Selecting [Choose tab] in the [RECENT SETTINGS] menu displays the items shown in Step 2 of “Displaying [RECENT SETTINGS]” (☰495). Highlight [☰ MY MENU] and press Ⓚ to view My Menu.

---

# Establishing Wireless Connections to Computers or Smart Devices

## Network Options

The camera can:

- **connect to computers via Wi-Fi** (📖498) or

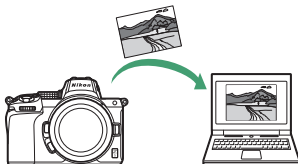

- **establish wireless connections to smartphones or tablets** (smart devices; 📖522).

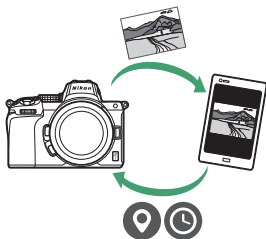

## Connecting to Computers via Wi-Fi

### What Wi-Fi Can Do for You

Connect using the camera's built-in Wi-Fi to upload selected pictures to a computer.

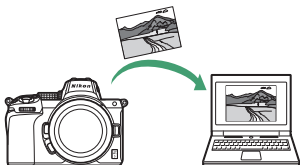

### The Wireless Transmitter Utility

Before you will be able to upload images via Wi-Fi, you will need to pair the camera with the computer using Nikon's Wireless Transmitter Utility software.

- Once the devices are paired, you will be able to connect to the computer from the camera.
- The Wireless Transmitter Utility is available for download from the Nikon Download Center. Be sure to download the latest version after reading the release notes and system requirements.

<https://downloadcenter.nikonimglib.com/>

## Infrastructure and Access-Point Modes

Either of the following two methods can be used to establish wireless connections between the camera and a computer.

### ■ Direct Wireless Connection (Access-Point Mode)

The camera and computer connect via direct wireless link.



The camera acts as a wireless LAN access point, letting you

connect when working outdoors and in other situations in which the computer is not already connected to a wireless network and eliminating the need for complicated adjustments to settings. The computer cannot connect to the Internet while connected to the camera.

- To create a new host profile, select **[Direct connection to PC]** in the connection wizard.

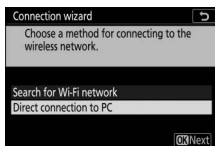

## ■ Infrastructure Mode

The camera connects to a computer on an existing network (including home networks) via a wireless router.



The computer can still connect to the Internet while connected to the camera.

- To create a new network profile, select [**Search for Wi-Fi network**] in the connection wizard.

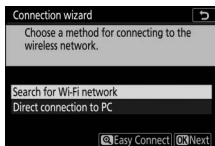

---

## ✓ Infrastructure Mode

- This guide assumes you are connecting via an existing wireless network.
  - Connection to computers beyond the local area network is not supported. You can connect only to computers on the same network.
-

## Connecting in Access-Point Mode

- 1 Select [Connect to PC] in the camera setup menu, then highlight [Network settings] and press .



- 2 Highlight [Create profile] and press .

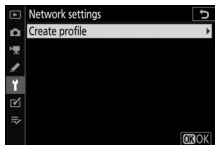

- 3 Highlight [Direct connection to PC] and press .

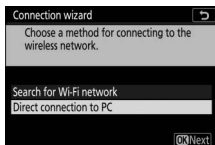

The camera SSID and encryption key will be displayed.

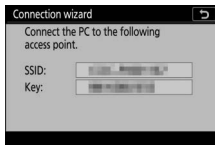

## 4 Establish a connection to the camera.

### Windows:

- Click the wireless LAN icon in the taskbar.
- Select the SSID displayed by the camera in Step 3.
- When prompted to enter the network security key, enter the encryption key displayed by the camera in Step 3. The computer will initiate a connection to the camera.

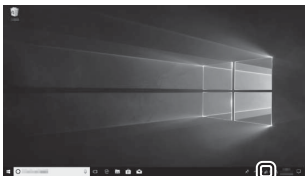

### macOS:

- Click the wireless LAN icon in the menu bar.
- Select the SSID displayed by the camera in Step 3.
- When prompted to enter the network security key, enter the encryption key displayed by the camera in Step 3. The computer will initiate a connection to the camera.





## 5 Start pairing.

When prompted, launch the Wireless Transmitter Utility on the computer.

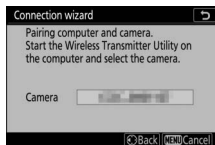

## 6 Select the camera in the Wireless Transmitter Utility.

Select the name displayed by the camera in Step 5 and click **Next**.

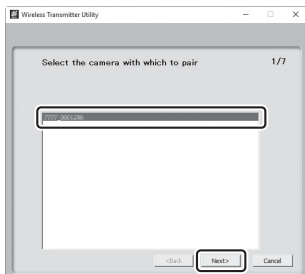

## 7 In the Wireless Transmitter Utility, enter the authentication code displayed by the camera.

- The camera will display an authentication code.
- Enter the authentication code in the dialog displayed by the Wireless Transmitter Utility and click **[Next]**.

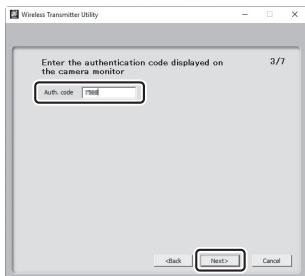

## 8 Complete the pairing process.

- When the camera displays a message stating that pairing is complete, press **OK**.

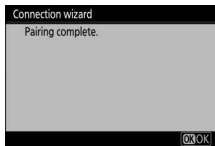

- In the Wireless Transmitter Utility, click **[Next]**; you will be prompted to choose a destination folder. For more information, see online help for the Wireless Transmitter Utility.

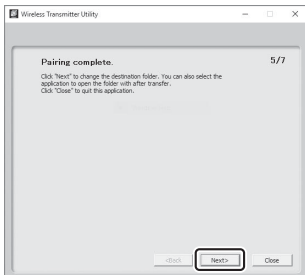

- A wireless connection will be established between the camera and computer when pairing is complete.

## 9 Check the connection.

When a connection is established, the network SSID will be displayed in green in the camera [Connect to PC] menu.

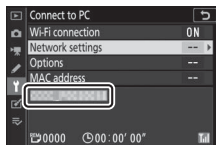

- If the camera SSID is not displayed in green, connect to the camera via the wireless network list on your computer.

*A wireless connection has now been established between the camera and the computer.*

*Pictures taken with the camera can be uploaded to the computer as described in "Uploading Pictures" (📖 516).*

## Connecting in Infrastructure Mode

- 1 Select [Connect to PC] in the camera setup menu, then highlight [Network settings] and press .



- 2 Highlight [Create profile] and press .

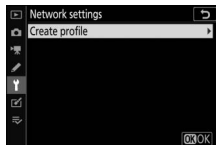

### 3 Highlight [Search for Wi-Fi network] and press **OK**.

The camera will search for networks currently active in the vicinity and list them by name (SSID).

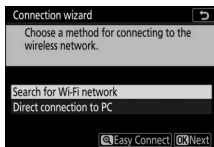

#### ✓ [Easy Connect]

- To connect without entering an SSID or encryption key, press **Q** in Step 3. Next, press **OK** and choose from the following options:

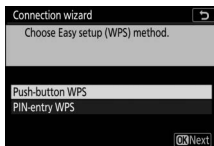

Option	Description
[Push-button WPS]	For routers that support push-button WPS. Press the WPS button on the router and then press the camera <b>OK</b> button to connect.
[PIN-entry WPS]	The camera will display a PIN. Using a computer, enter the PIN on the router. For more information, see the documentation provided with the router.

- After connecting, proceed to Step 6.

## 4 Choose a network.

- Highlight a network SSID and press **OK**.
- Encrypted networks are indicated by a **lock** icon. If the selected network is encrypted (**lock**), you will be prompted to enter the encryption key. If the network is not encrypted, proceed to Step 6.
- If the desired network is not displayed, press **Search** to search again.

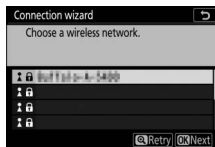

### ✓ Hidden SSIDs

Networks with hidden SSIDs are indicated by blank entries in the network list.

- To connect to a network with a hidden SSID, highlight a blank entry and press **OK**. Next, press **OK**; the camera will prompt you to provide an SSID.
- Enter the network name and press **Search**. Press **Search** again; the camera will now prompt you to enter the encryption key.



## 5 Enter the encryption key.

- Press **OK** and enter the encryption key for the wireless router.
- For more information, see the documentation for the wireless router.
- Press **OK** when entry is complete.
- Press **OK** again to initiate the connection. A message will be displayed for a few seconds when the connection is established.

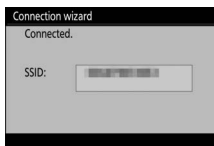
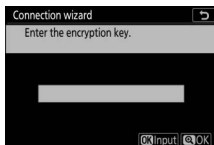



## 6 Obtain or select an IP address.

- Highlight one of the following options and press **OK**.

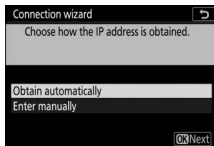

Option	Description
<b>[Obtain automatically]</b>	Select this option if the network is configured to supply the IP address automatically. A “configuration complete” message will be displayed once an IP address has been assigned.
<b>[Enter manually]</b>	Enter the IP address and sub-net mask manually. <ul style="list-style-type: none"><li>• Rotate the main command dial to highlight segments.</li><li>• Press <b>Left Arrow</b> or <b>Right Arrow</b> to change the highlighted segment and press <b>OK</b> to save changes.</li><li>• Next, press <b>Q</b>; a “configuration complete” message will be displayed. Press <b>Q</b> again to display the sub-net mask.</li><li>• Press <b>Up Arrow</b> or <b>Down Arrow</b> to edit the sub-net mask and press <b>OK</b>; a “configuration complete” message will be displayed.</li></ul>

- Press **OK** to proceed when the “configuration complete” message is displayed.

## 7 Start pairing.

When prompted, launch the Wireless Transmitter Utility on the computer.



## 8 Select the camera in the Wireless Transmitter Utility.

Select the name displayed by the camera in Step 7 and click **[Next]**.

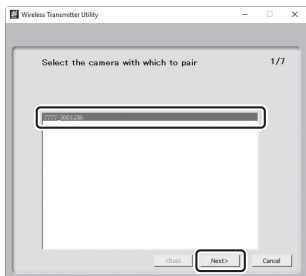

## 9 In the Wireless Transmitter Utility, enter the authentication code displayed by the camera.

- The camera will display an authentication code.
- Enter the authentication code in the dialog displayed by the Wireless Transmitter Utility and click **[Next]**.

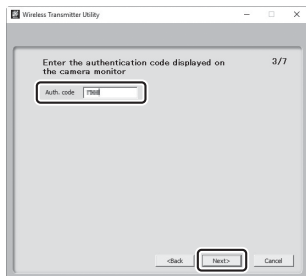

## 10 Complete the pairing process.

- When the camera displays a message stating that pairing is complete, press **OK**.

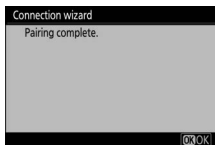

- In the Wireless Transmitter Utility, click [**Next**]; you will be prompted to choose a destination folder. For more information, see online help for the Wireless Transmitter Utility.

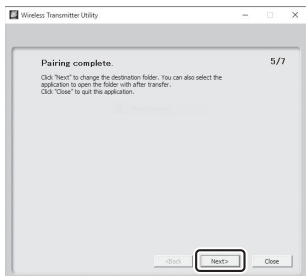

- A wireless connection will be established between the camera and computer when pairing is complete.

## 11 Check the connection.

When a connection is established, the network SSID will be displayed in green in the camera [Connect to PC] menu.

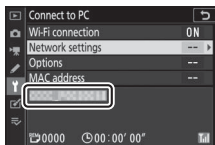

- If the camera SSID is not displayed in green, connect to the camera via the wireless network list on your computer.

*A wireless connection has now been established between the camera and the computer.*

*Pictures taken with the camera can be uploaded to the computer as described in "Uploading Pictures" (📖 516).*

## Uploading Pictures

Pictures can be selected for upload during playback. They can also be uploaded automatically as they are taken.

### ✔ Destination Folders

By default, images are uploaded to the following folders:

- Windows: \Users\\Pictures\Wireless Transmitter Utility
- macOS: /Users/(user name)/Pictures/Wireless Transmitter Utility

The destination folder can be selected using the Wireless Transmitter Utility. For more information, see online help for the Wireless Transmitter Utility.

### ✔ Access Point Mode

Computers cannot access the Internet while connected to the camera in access point mode. To access the Internet, terminate the connection to the camera and then reconnect to a network with Internet access.

## ■ Selecting Pictures for Upload

**1** Press the  button on the camera and select full-frame or thumbnail playback.

**2** Select a picture and press the  button.

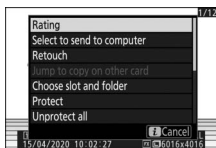

---

### 3 Highlight [Select to send to computer] and press **OK**.

- A white “send” icon will appear on the picture. If the camera is currently connected to a network, upload will begin immediately and the icon will turn green.
- Otherwise, upload will begin when a connection is established.
- Repeat Steps 2–3 to upload additional pictures.

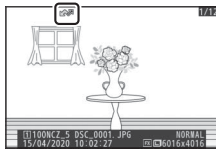

---

#### **✓ Removing Upload Marking**

- Repeat Steps 2–3 to remove transfer marking from selected images.
  - To remove transfer marking from all pictures, select [**Connect to PC**] > [**Options**] > [**Deselect all?**] in the setup menu.
-

## ■ ■ Uploading Photos as They Are Taken

To upload new photos as they are taken, select **[On]** for **[Connect to PC]** > **[Options]** > **[Auto send]** in the setup menu.

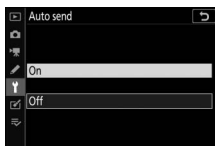

- Upload begins only after the photo has been recorded to the memory card. Be sure a memory card is inserted in the camera.
- Movies and photos taken during movie mode are not uploaded automatically when recording is complete. They must instead be uploaded from the playback display.

## ■ ■ The Transfer Icon

Upload status is indicated by the transfer icon.

### 📷 (white): Send

The picture has been selected for automatic upload but upload has not yet begun.



### 📷 (green): Sending

Upload in progress.

### 📷 (blue): Sent

Upload complete.



## ■ The Status Display

The [Connect to PC] display shows the following:

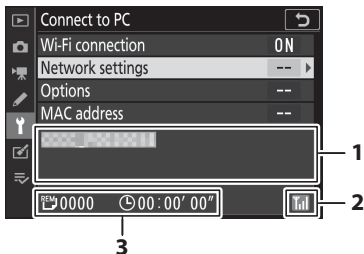

- 1 Status:** The status of the connection to the host. The host name is displayed in green when a connection is established. While files are being transferred, the status display shows "Now sending" preceded by the name of the file being sent. Errors are also displayed here.

- 2 Signal strength:** Wireless signal strength.
- 3 Pictures/time remaining:** The number of pictures remaining and the time needed to send them. The time remaining is an estimate only.

---

### ✓ Loss of Signal

Wireless transmission may be interrupted if the signal is lost. Upload of pictures with "send" marking can be resumed by turning the camera off and then on again once the signal has been re-established.

---

## Disconnecting and Reconnecting

### ■ Disconnecting

You can end the connection by:

- turning the camera off,
- selecting [**Disable**] for [**Connect to PC**] > [**Wi-Fi connection**] in the setup menu,
- selecting [**Wi-Fi connection**] > [**Close Wi-Fi connection**] in the photo-mode **i** menu, or
- connecting to a smart device via Wi-Fi or Bluetooth.

---

### ✓ Access-Point Mode

An error will occur if the computer's wireless connection is disabled before the camera's. Disable camera Wi-Fi first.

---

## ■ Reconnecting

To reconnect to an existing network:

- select **[Enable]** for **[Connect to PC]** > **[Wi-Fi connection]** in the setup menu, or
- select **[Wi-Fi connection]** > **[Establish Wi-Fi connection with PC]** in the photo-mode **i** menu.

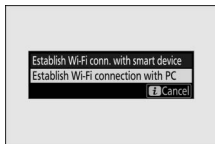

---

### ✓ Access-Point Mode

Enable camera Wi-Fi before connecting.

### ✓ Multiple Network Profiles

If the camera has profiles for more than one network, it will reconnect to the last network used. Other networks can be selected using the **[Connect to PC]** > **[Network settings]** option in the setup menu.

---

## Connecting to Smart Devices

### The SnapBridge App

Use the SnapBridge app for wireless connections between the camera and your smartphone or tablet (“smart device”).



- SnapBridge apps can be downloaded from the Apple App Store® or on Google Play™.



- Visit the Nikon website for the latest SnapBridge news.

## **What SnapBridge Can Do for You**

The tasks that can be performed using the SnapBridge app are outlined below. For details, see the SnapBridge app online help: <https://nikonimglib.com/snbr/onlinehelp/en/index.html>

### **■ ■ Downloading Pictures from the Camera**

Download existing pictures to your smart device. Pictures can be uploaded as they are taken.

### **■ ■ Remote Photography**

Control the camera and take pictures from the smart device.

## Wireless Connections

Use the SnapBridge app for wireless connections between the camera and your smart device. You can connect via either Wi-Fi (📖 525) or Bluetooth (📖 534). Connecting using the SnapBridge app allows you to set the camera clock and update location data using information provided by the smart device. Connecting using Bluetooth allows pictures to be uploaded automatically as they are taken.

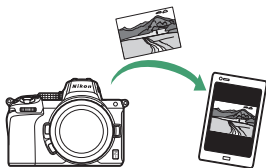

Wi-Fi

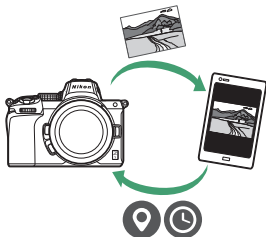

Bluetooth

## Connecting via Wi-Fi (Wi-Fi Mode)



### ✔ Before Connecting

- Enable Wi-Fi on the smart device. For details, see the documentation provided with the device.
- Ensure that the batteries in the camera and smart device are fully charged to prevent the devices turning off unexpectedly.
- Check that there is space available on the camera memory card.

## 1 Smart device: Launch the SnapBridge app.

- *If this is the first time you have launched the app, tap [Connect to camera] and proceed to Step 2.*



- If you have launched the app before, open the  tab and select  > [**Wi-Fi mode**] before proceeding to Step 3.

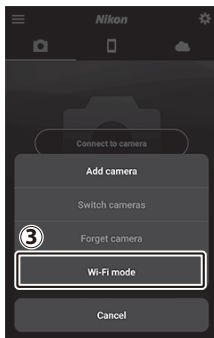





## 2 Smart device: When prompted to choose the camera type, tap [Mirrorless camera] and then tap [Wi-Fi connection].

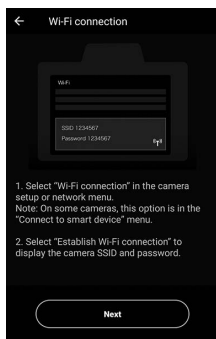

## 3 Camera/smart device: Turn the camera on when prompted.

Do not tap [Next] until you have completed the next step.



**4 Camera: Select [Connect to smart device] > [Wi-Fi connection] in the setup menu, then highlight [Establish Wi-Fi connection] and press .**

The camera SSID and password will be displayed.



** Enabling Wi-Fi**

You can also enable Wi-Fi by selecting **[Wi-Fi connection] > [Establish Wi-Fi conn. with smart device]** in the **i** menu for shooting mode.



## 5 Smart device: Return to the smart device and tap [Next].

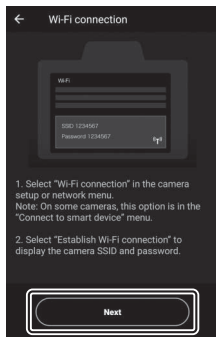

## 6 Smart device: After reading the instructions displayed by the smart device, tap [Open the device settings app].

- Android devices: Wi-Fi settings will be displayed.

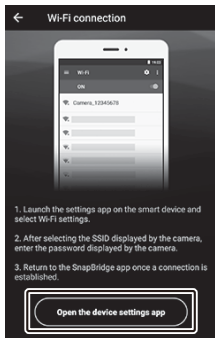

- iOS devices: The “Settings” app will launch. Tap [**Settings**] to open [**Settings**], then scroll up and tap [**Wi-Fi**], which you’ll find near the top of the settings list.

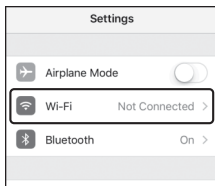
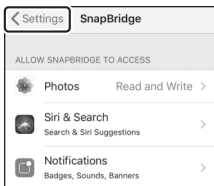

## 7 Smart device: Enter the SSID and password displayed by the camera in Step 4.

- The prompt displayed by the device varies with model and operating system.
  - **Android device:**

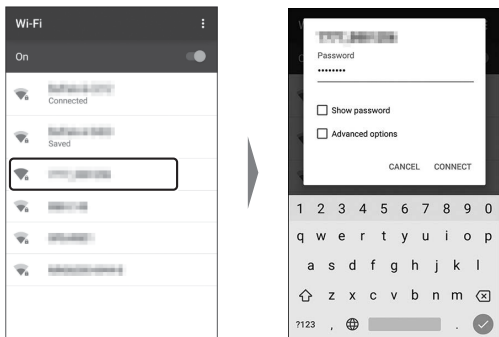

## - iOS device:

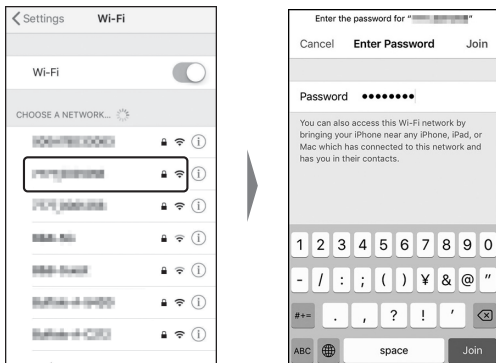



- You will not be required to enter the password when next you connect to the camera.

## 8 Smart device: Return to the SnapBridge app.

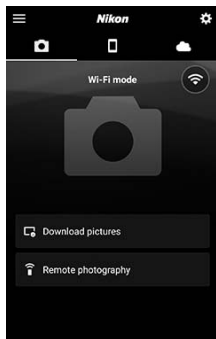
- Once a Wi-Fi connection is established, Wi-Fi mode options will be displayed.
- See online help for information on using the SnapBridge app.



### ✓ Terminating Wi-Fi Mode

To end the Wi-Fi connection, tap . When the icon changes to , tap  and select [**Exit Wi-Fi mode**].



## Connecting via Bluetooth

Before connecting via Bluetooth for the first time, you will need to pair the camera and smart device as described below. The procedure for iOS differs slightly from that for Android devices.

### ✓ Before Pairing

- Enable Bluetooth on the smart device. For details, see the documentation provided with the device.
- Ensure that the batteries in the camera and smart device are fully charged to prevent the devices turning off unexpectedly.
- Check that there is space available on the camera memory card.

## ■ Connecting to an Android Device for the First Time: Pairing

For information on connecting to iOS devices, see “Connecting to an iOS Device for the First Time: Pairing” (☞ 541).

**1 Camera: Select [Connect to smart device] > [Pairing (Bluetooth)] in the setup menu, then highlight [Start pairing] and press .**

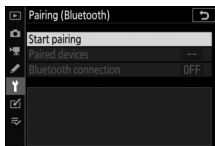

The camera name will be displayed in the monitor.

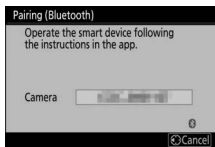



## 2 Android device: Launch the SnapBridge app.

- If this is the first time you have launched the app, tap [**Connect to camera**].

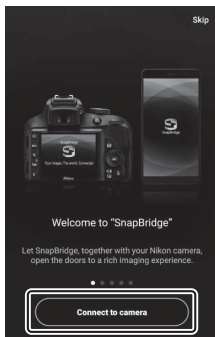

- If you have launched the app before, open the  tab and tap [**Connect to camera**].

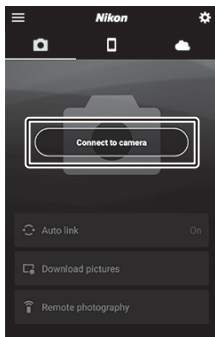

### 3 Android device: Tap [Mirrorless camera] and then tap [Pairing (Bluetooth)].

- This step can be omitted once the devices have been paired.
- You must grant access to location data when using Bluetooth. If prompted to provide access to location data, follow the on-screen instructions.



## 4 Android device: Tap the camera name.

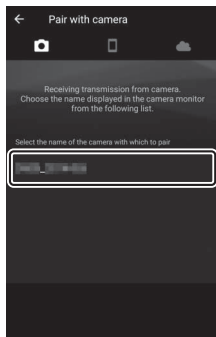

## 5 Camera/Android device: Confirm that the camera and Android device display the same authentication code.

The authentication code is shown circled in the illustrations.

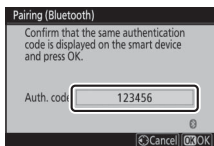
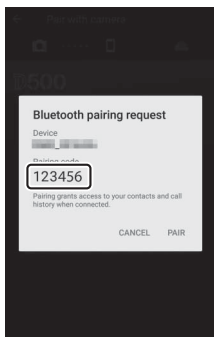

---

## 6 Camera/Android device: Initiate pairing.

- **Camera:** Press **OK**.



- **Android device:** Tap the button indicated in the illustration. The button in the illustration is labeled **[PAIR]**, but the label may differ depending on the type of device and version of Android you are using.

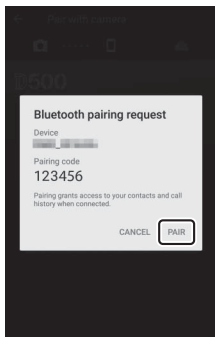

---

### ✓ Pairing Error

If you wait too long between pressing the button on the camera and tapping the button on the Android device, the device will display an error message and pairing will fail. Tap **[OK]** and return to Step 2.

---

## 7 Camera/Android device: Follow the on-screen instructions to complete pairing.

- **Camera:** Press **[OK]**. The camera will display the message shown in the illustration when pairing is complete.



- **Android device:** Pairing is complete. Tap **[OK]** to exit to the  tab.

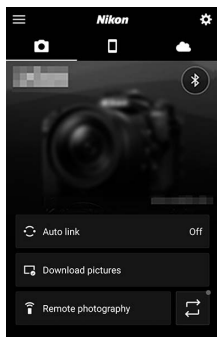
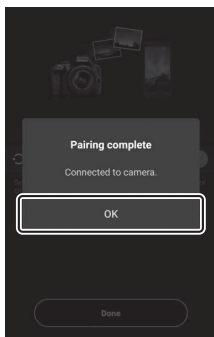

---

### ✔ Pairing for the First Time

- The first time you pair the Android device with a camera after installing the SnapBridge app, you will be prompted to select auto link (auto upload and auto clock and location synchronization) options.
- This prompt will not be displayed a second time. Auto link settings can however be accessed at any time using [**Auto link**] in the  tab.

### ✔ Disabling Bluetooth

To disable Bluetooth, select [**Disable**] for [**Connect to smart device**] > [**Pairing (Bluetooth)**] > [**Bluetooth connection**] in the camera setup menu.

---

## ■ Connecting to an iOS Device for the First Time: Pairing

For information on connecting to Android devices, see “Connecting to an Android Device for the First Time: Pairing” (☞ 534).

- 1 Camera: Select [Connect to smart device] > [Pairing (Bluetooth)] in the setup menu, then highlight [Start pairing] and press .**

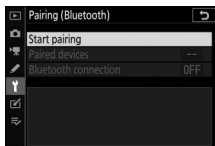

The camera name will be displayed in the monitor.

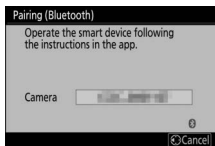

## 2 iOS device: Launch the SnapBridge app.

- If this is the first time you have launched the app, tap **[Connect to camera]**.

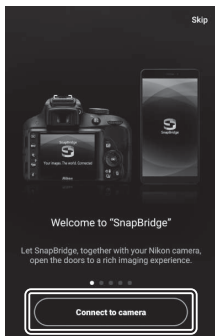

- If you have launched the app before, open the  tab and tap **[Connect to camera]**.

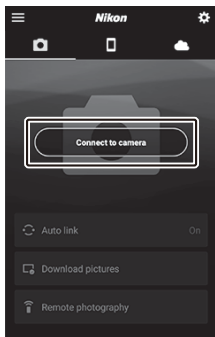



### 3 iOS device: Tap [Mirrorless camera] and then tap [Pairing (Bluetooth)].

- This step can be omitted once the devices have been paired.
- You must grant access to location data when using Bluetooth. If prompted to provide access to location data, follow the on-screen instructions.

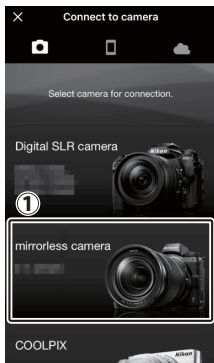

## 4 iOS device: Tap the camera name.



## 5 iOS device: Read the pairing instructions.

Pairing instructions will be displayed. Read the instructions carefully and tap **[Understood]**.

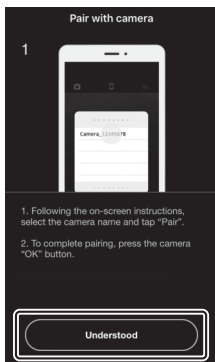

---

## 6 iOS device: Tap the camera name again.

The iOS device prompt you to select an accessory. Tap the camera name again.

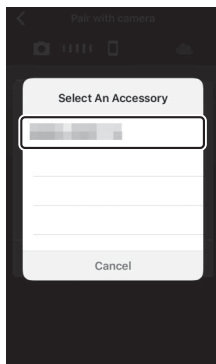

## 7 Camera/iOS device: Initiate pairing.

- **Camera:** Press .



- **iOS device:** Tap the button indicated in the illustration. The button in the illustration is labeled **[Pair]**, but the label may differ depending on the version of iOS you are using.

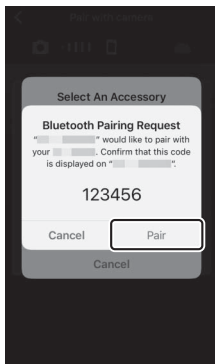

## ✔ Pairing Error

If you wait too long between pressing the button on the camera and tapping the button on the iOS device, the device will display an error message and pairing will fail. Dismiss the SnapBridge app and check that it is not running in the background, then open the iOS “Settings” app and request iOS to “forget” the camera before returning to Step 1. “Forget” the camera using the iOS “Settings” app.

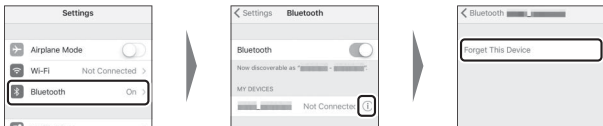

## 8 Camera/iOS device: Follow the on-screen instructions to complete pairing.

- **Camera:** Press **OK**. The camera will display the message shown in the illustration when pairing is complete.



- **iOS device:** Pairing is complete. Tap **[OK]** to exit to the  tab.

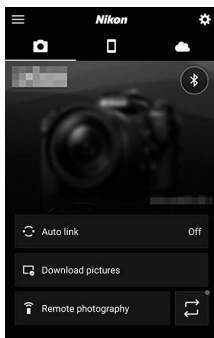
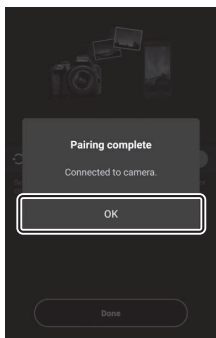

---

### ✔ **Pairing for the First Time**

- The first time you pair the iOS device with a camera after installing the SnapBridge app, you will be prompted to select auto link (auto upload and auto clock and location synchronization) options.
- This prompt will not be displayed a second time. Auto link settings can however be accessed at any time using [**Auto link**] in the  tab.

### ✔ **Disabling Bluetooth**

To disable Bluetooth, select [**Disable**] for [**Connect to smart device**] > [**Pairing (Bluetooth)**] > [**Bluetooth connection**] in the camera setup menu.

---

## ■ Connecting to a Paired Device

Connecting to a smart device that has already been paired with the camera is quick and easy.

- 1 Camera:** In the setup menu, select **[Connect to smart device] > [Pairing (Bluetooth)] > [Bluetooth connection]**, then highlight **[Enable]** and press **OK**.

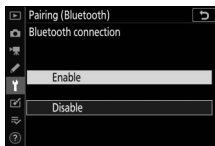

- 2 Smart device:** Launch the SnapBridge app.

A Bluetooth connection will be established automatically.

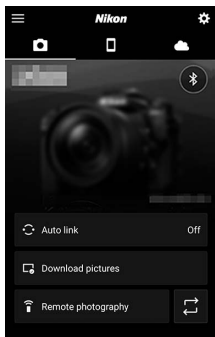



## Troubleshooting

Solutions to some common issues are listed below.

- Troubleshooting information for the SnapBridge app can be found in the app's online help, which can be viewed at: <https://nikonimglib.com/snbr/onlinehelp/en/index.html>
- For information on the Wireless Transmitter Utility, see the utility's online help.

Problem	Solution
The camera displays a TCP/IP error.	Connection settings require adjustment. Check settings for the host computer or wireless router and adjust camera settings appropriately (☐445).
The camera displays a "no memory card" error.	The memory card is inserted incorrectly or not at all. Confirm that the memory card is correctly inserted (☐38).
Upload is interrupted and fails to resume.	Upload will resume if the camera is turned off and then on again (☐516).
The connection is unreliable.	If [ <b>Auto</b> ] is selected for [ <b>Channel</b> ] when you are connecting to a smart device, choose [ <b>Manual</b> ] and select the channel manually (☐443).
	If the camera is connected to a computer in infrastructure mode, check that the router is set to a channel between 1 and 8 (☐445).

# Cabled Connections to Computers and HDMI Devices

## Connecting to Computers Via USB

Connect the camera using the supplied USB cable. You can then use Nikon NX Studio software to copy pictures to the computer for viewing and editing. For information on establishing wireless connections to computers, see “Connecting to Computers via Wi-Fi” (📖 498) in “Establishing Wireless Connections to Computers or Smart Devices”.

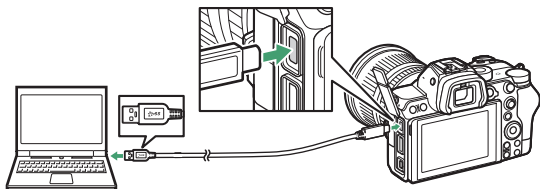

## **Installing NX Studio**

You will need an Internet connection when installing NX Studio. Visit the Nikon website for the latest information, including system requirements.

- Download the latest NX Studio installer from the website below and follow the on-screen instructions to complete installation.

<https://downloadcenter.nikonimglib.com/>

- Note that you may be unable to download pictures from the camera using earlier versions of NX Studio.

## Copying Pictures to a Computer Using NX Studio

See online help for detailed instructions.

---

### **1 Connect the camera to the computer.**

After turning the camera off and ensuring that a memory card is inserted, connect the supplied USB cable as shown.

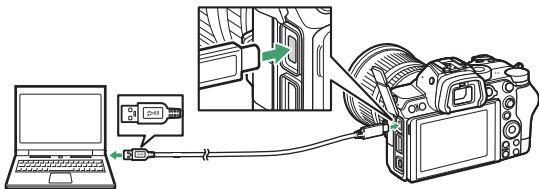

---

#### **Using a Card Reader**

Pictures can also be copied from a memory card inserted in a third-party card reader. You should however check that the card is compatible with the card reader.

---

### **2 Turn the camera on.**

- The Nikon Transfer 2 component of NX Studio will start. Nikon Transfer 2 image transfer software is installed as part of NX Studio.
- If a message is displayed prompting you to choose a program, select Nikon Transfer 2.
- If Nikon Transfer 2 does not start automatically, launch NX Studio and click the “Import” icon.

### 3 Click [Start Transfer].

Pictures on the memory card will be copied to the computer.

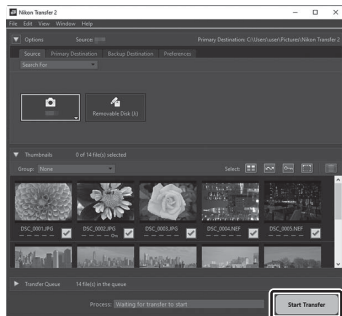

### 4 Turn the camera off.

Disconnect the USB cable when transfer is complete.

#### ✔ Windows 10 and Windows 8.1

Windows 10 and Windows 8.1 may display an AutoPlay prompt when the camera is connected.

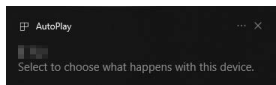

Click the dialog and then click [Nikon Transfer 2] to select Nikon Transfer 2.

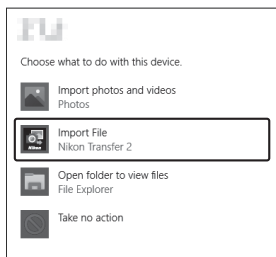

## ✔ macOS

If Nikon Transfer 2 does not start automatically, confirm that the camera is connected and then launch Image Capture (an application that comes with macOS) and select Nikon Transfer 2 as the application that opens when the camera is detected.

## ✔ Caution: Transferring Videos

Do not attempt to transfer videos from the memory card while it is inserted in a camera of a different make or model. Doing so could result in the videos being deleted without being transferred.

## ✔ Cautions: Connecting to Computers

- Do not turn the camera off or disconnect the USB cable while transfer is in progress.
- Do not use force or attempt to insert the connectors at an angle. Be sure also to keep the connectors straight when disconnecting the cable.
- Always turn the camera off before connecting or disconnecting a cable.
- To ensure that data transfer is not interrupted, be sure the camera battery is fully charged.

## ✔ USB Hubs

Connect the camera directly to the computer; do not connect the cable via a USB hub or keyboard. Connect the camera to a pre-installed USB port.

---

## Connecting to HDMI Devices

The camera can be connected to TVs, recorders, and other devices featuring HDMI connectors. Use the optional HDMI cable (□650) or a third-party type C HDMI cable. These items must be purchased separately. Always turn the camera off before connecting or disconnecting an HDMI cable.

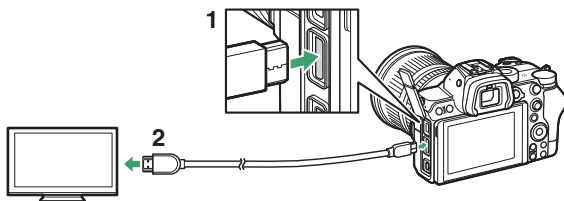

**1** HDMI connector for connection to camera

**2** HDMI connector for connection to external device \*

\* Choose a cable with a connector that matches the connector on the HDMI device.

## **TVs**

- After tuning the TV to the HDMI input channel, turn the camera on and press the  button to view pictures on the television screen.
- Audio playback volume can be adjusted using the controls on the TV. Camera controls cannot be used.
- If the camera is paired with a smart device running the SnapBridge app, the device can be used to control playback remotely while the camera is connected to a TV. See the SnapBridge app online help for details.



## Recorders

The camera can record video directly to connected HDMI recorders. Use the [HDMI] item in the setup menu to adjust settings for HDMI output. Some recorders will start and stop recording in response to camera controls.





### ■ Output Resolution

Choose the format for images output to the HDMI device. If [Auto] is selected, the camera will automatically choose the appropriate format.

### ■ Advanced

Adjust settings for connection to the HDMI device.

Option	Description
[Output range]	<p>The RGB video signal input range varies with the HDMI device. [Auto], which matches the output range to the HDMI device, is recommended in most situations. If the camera is unable to determine the correct RGB video signal output range for the HDMI device, you can choose from the following options:</p> <ul style="list-style-type: none"><li>• [Limited range]: For devices with an RGB video signal input range of 16 to 235. Choose this option if you notice a loss of detail in shadows.</li><li>• [Full range]: For devices with an RGB video signal input range of 0 to 255. Choose this option if you notice that shadows are “washed out” or too bright.</li></ul>

Option	Description
<p><b>[External recording control]</b></p>	<p>Choosing <b>[On]</b> allows camera controls to be used to start and stop recording when the camera is connected via HDMI to a third-party recorder that supports the Atomos Open Protocol.</p> <ul style="list-style-type: none"> <li>External recording control is available with Atomos SHOGUN, NINJA, and SUMO-series Monitor recorders. For more information on device features and operation, contact the manufacturer or refer to the documentation provided with the recorder.</li> <li>The camera display will turn off automatically when the time selected for Custom Setting c3 <b>[Power off delay]</b> &gt; <b>[Standby timer]</b> expires, ending HDMI output. When recording movies to an external device, select <b>[Standby timer]</b> and choose <b>[No limit]</b> or a time longer than the anticipated recording time.</li> <li>An icon will be displayed in the camera monitor when <b>[On]</b> is selected:  <b>STBY</b> is displayed during filming,  <b>REC</b> while movies are being recorded. During recording, check the recorder and recorder display to ensure that footage is being saved to the device.</li> <li>Note that selecting <b>[On]</b> may disrupt the footage output to the device.</li> </ul>

### ✓ **No HDMI Output**

HDMI output is not available when the camera is in movie mode and connected to a computer running Camera Control Pro 2.

### ✓ **Zoom**

Movies recorded at a frame size of 3840 × 2160 display at a frame size of 1920 × 1080 during zoom.

# On-Camera Flash Photography

## “On-Camera” Versus “Remote”

You can take pictures using an optional flash unit mounted on the camera accessory shoe or one or more remote flash units.

- When using a flash, select **[Off]** for **[Silent photography]** in the photo shooting menu.

### Camera-Mounted Flash Units

Take pictures using a flash unit mounted on the camera. See the following pages for more information.



## Remote Flash Photography

Take pictures with one or more remote flash units using wireless flash control (Advanced Wireless Lighting, or AWL). For more information, see “Remote Flash Photography” (📖 579).

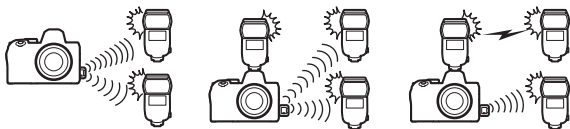

## Using an On-Camera Flash

---

### 1 Mount a flash unit on the camera accessory shoe.

See the manual provided with the unit for details.

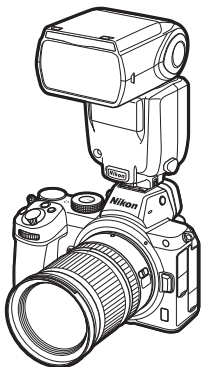

---

### 2 Turn on the camera and flash unit.

The flash will begin charging; the flash-ready indicator (⚡) will appear in the shooting display when charging is complete.

---

### 3 Choose the flash control mode (📖 566) and flash mode (📖 569).

---

### 4 Adjust shutter speed and aperture.

---

### 5 Take pictures.

## ✓ Shutter Speed

Shutter speed can be set as follows when an optional flash unit is used:

Mode	Shutter speed
	Set automatically by camera ( $1/200$ s– $1/60$ s)
<b>P, A</b>	Set automatically by camera ( $1/200$ s– $1/60$ s) *
<b>S</b>	$1/200$ s–30 s
<b>M</b>	$1/200$ s–30 s, <b>Bulb, Time</b>

\* Shutter speed may be set as slow as 30 s if slow sync, slow rear-curtain sync, or slow sync with red-eye reduction is selected for flash mode.

## ✓ Third-Party Flash Units

The camera cannot be used with flash units that would apply voltages over 250 V to the camera's X contacts or short-circuit contacts on the accessory shoe. Use of such flash units could not only interfere with normal operation of the camera but also damage the flash sync circuits of the camera and/or flash.

## ✔ i-TTL Flash Control

When an optional flash unit that supports the Nikon Creative Lighting System is attached and set to TTL, the camera uses monitor pre-flashes for balanced or standard “i-TTL fill-flash” flash control. i-TTL flash control is not available with flash units that do not support the Nikon Creative Lighting System. The camera supports the following types of i-TTL flash control:

Flash control	Description
<b>i-TTL balanced fill-flash</b>	The camera uses “i-TTL balanced fill-flash” flash control for a natural balance between the main subject and ambient background lighting. After the shutter-release button is pressed and immediately before the main flash, the flash unit emits a series of monitor pre-flashes which the camera uses to optimize flash output for a balance between the main subject and ambient background lighting.
<b>Standard i-TTL fill-flash</b>	Flash output is adjusted to bring lighting in the frame to a standard level; the brightness of the background is not taken into account. Recommended for shots in which the main subject is emphasized at the expense of background details, or when exposure compensation is used.

- Standard i-TTL fill-flash is activated automatically when **[Spot metering]** is selected.

## Flash Control Mode

When a flash unit that supports unified flash control (an SB-5000, SB-500, SB-400, or SB-300) is mounted on the camera, the flash control mode, flash level, and other flash settings can be adjusted using the **[Flash control]** >

**[Flash control mode]** item in the photo shooting menu. The flash control modes available vary with the flash used. The options available in the flash control display vary with the option selected for **[Flash control mode]**.

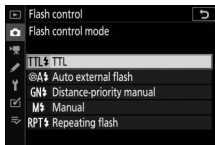

- Settings for flash units other than the SB-5000, SB-500, SB-400, and SB-300 can only be adjusted using flash unit controls.
- Settings for an SB-5000 mounted on the accessory shoe can also be adjusted using the controls on the flash unit.

Option	Description
<b>[TTL]</b>	<ul style="list-style-type: none"><li>• Flash output is adjusted automatically in response to shooting conditions.</li><li>• Output can be adjusted using <b>[Flash compensation (TTL)]</b>. In the cases of the SB-500, SB-400, and SB-300, flash compensation can be adjusted using the <b>[Flash compensation]</b> item in the photo shooting menu.</li></ul>



Option	Description
[Auto external flash]	<ul style="list-style-type: none"> <li>• Light from the flash is reflected from the subject to an auto external flash sensor and flash output adjusted automatically.</li> <li>• Output can be adjusted using [Auto external flash compensation].</li> <li>• Auto external flash supports “auto aperture” (⊕A) and “non-TTL auto” (A) modes. See the flash unit manual for details.</li> </ul>
[Distance-priority manual]	<ul style="list-style-type: none"> <li>• Choose the distance to the subject; flash output will be adjusted automatically.</li> <li>• The distance to the subject is selected using [Distance-priority options] &gt; [Distance], while flash output can be adjusted using [Flash compensation].</li> </ul>
[Manual]	<ul style="list-style-type: none"> <li>• Choose the flash level manually.</li> <li>• Flash output is selected using [Manual output amount].</li> </ul>
[Repeating flash]	<ul style="list-style-type: none"> <li>• The flash fires repeatedly while the shutter is open, producing a multiple-exposure effect.</li> <li>• Use [Repeating flash] &gt; [Output] to adjust flash output and [Times] to choose the number of times the unit fires. [Frequency] controls how often the unit fires per second, measured in Hz.</li> <li>• The maximum number of times the flash will fire varies with [Output] and [Frequency]. See the flash unit manual for details.</li> </ul>

---





## ✓ **Unified Flash Control**





Unified flash control allows the camera and flash unit to share settings. Changes to flash settings made with either the camera or flash unit are reflected on both devices, as are changes made using optional Camera Control Pro 2 software. The flash unit must support unified flash control.

---

## Flash Modes

Use the [**Flash mode**] item in the photo shooting menu to choose the effect produced by the flash. The options available vary with the shooting mode.

	Option	Description	Available in
	[ <b>Fill flash</b> ] (front-curtain sync)	This mode is recommended in most situations. In modes <b>P</b> and <b>A</b> , shutter speed will automatically be set to values between $1/200$ s (or $1/8000$ s with auto FP high-speed sync) and $1/60$ s.	 <b>AUTO</b> , <b>P</b> , <b>S</b> , <b>A</b> , <b>M</b>
	[ <b>Red-eye reduction</b> ]	Use for portraits. The red-eye reduction lamp on the camera or flash unit lights before the flash fires, reducing “red-eye”. <ul style="list-style-type: none"><li>• A flash unit with red-eye reduction is required.</li><li>• The desired results may not be achieved if the subject or camera moves before the shutter is released (this setting is not recommended with moving subjects or in other situations requiring a quick shutter response).</li></ul>	 <b>AUTO</b> , <b>P</b> , <b>S</b> , <b>A</b> , <b>M</b>

Option	Description	Available in
 <b>[Slow sync]</b> (Slow sync)	As for “fill flash”, except that shutter speed slows automatically to capture background lighting at night or under low light. <ul style="list-style-type: none"> <li>Note that photos may be prone to blurring due to camera shake at slow shutter speeds.</li> <li>Use of a tripod is recommended.</li> </ul>	<b>P, A</b>
 <b>[Slow sync + red-eye]</b> (red-eye reduction with slow sync)	Use to include background lighting in portraits. Red-eye reduction is combined with slow shutter speeds to capture background lighting at night or under low light. <ul style="list-style-type: none"> <li>Note that photos may be prone to blurring due to camera shake at slow shutter speeds.</li> <li>Use of a tripod is recommended.</li> </ul>	<b>P, A</b>
 <b>[Rear-curtain sync]</b>	The flash fires just before the shutter closes, creating the effect of a stream of light behind moving light sources. <ul style="list-style-type: none"> <li>Selecting <b>P</b> or <b>A</b> after choosing this option sets the flash mode to slow sync.</li> <li>Note that photos may be prone to blurring due to camera shake at slow shutter speeds.</li> <li>Use of a tripod is recommended.</li> </ul>	<b>P, S, A, M</b>
 <b>[Flash off]</b>	The flash does not fire.	 <b>P, S, A, M</b>

---

### **Studio Strobe Lighting**

Rear-curtain sync cannot be used with studio flash systems, as the correct synchronization cannot be obtained.

---

## Flash Compensation

Flash compensation is used to deliberately alter flash output, for example in order to change the brightness of the subject relative to the background. Via the **[Flash**

**compensation]** item in the photo shooting menu, flash output can be increased to make the main subject appear brighter, reduced to prevent glare, or otherwise fine-tuned to produce the desired result.



- Choose from values of from  $-3$  to  $+1$ .
- By default, changes are made in increments of  $1/3$  EV. The size of the increments can be changed using Custom Setting b1 **[EV steps for exposure ctrl]** to  $1/2$  EV.
- Higher values make the subject brighter, lower values darker.
- At values other than  $\pm 0.0$ , a  icon will appear in the shooting display.
- Normal flash output can be restored by setting flash compensation to  $\pm 0.0$ . Flash compensation is not reset when the camera is turned off.

## FV Lock

This feature is used to lock flash output for CLS-compatible flash units, letting you take multiple photos or recompose shots without changing the flash level. Your subject need not be in the center of the frame, giving you more freedom when composing shots.

- Flash output is adjusted automatically for any changes in ISO sensitivity and aperture.
- FV lock is not available in  mode.

---

### 1 Assign [FV lock] to a control using Custom Setting f2 [Custom controls].

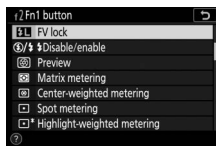

---

### 2 Mount a CLS-compatible flash unit on the camera accessory shoe.

---

### 3 Turn the flash unit on and choose a flash control mode of monitor pre-flash A or A.

- If you are using an SB-5000, SB-500, SB-400, or SB-300 mounted on the camera accessory shoe, choose [TTL] or [Auto external flash] for [Flash control] > [Flash control mode].
- For information on other flash units, see the documentation provided with the unit.

---

### 4 Focus.

Position the subject in the center of the frame and press the shutter-release button halfway to focus.





---

## 5 Lock flash level.

- After confirming that the flash-ready indicator (⚡) appears in the shooting display, press the **[FV lock]** control; the flash unit will emit a monitor pre-flash to determine the appropriate flash level.
- Flash output will lock and an FV lock icon (⚡) will appear in the shooting display.



---

## 6 Recompose the shot.



---

## 7 Press the shutter-release button the rest of the way down to shoot.

If desired, additional pictures can be taken without releasing FV lock. Repeat Steps 6 to 7 to take additional shots.

---

## 8 Release FV lock.

Press the **[FV lock]** control to release FV lock and confirm that the FV lock icon (⚡) is no longer displayed in the shooting display.

## Flash Info for On-Camera Units

When a unit that supports unified flash control (the SB-5000, SB-500, SB-400, or SB-300) is mounted on the camera accessory shoe, flash info can be viewed in the camera display. To view flash info, press the **DISP** button in photo mode (□21).

### Flash Control Mode Displays

#### ■ TTL

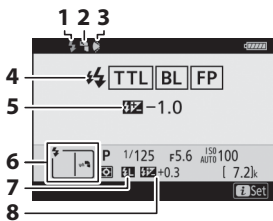

- 1 Flash-ready indicator (□563)
- 2 Bounce icon (displayed if flash head is tilted up)
- 3 Zoom head position warning (displayed if zoom head is not in correct position)
- 4 Flash control mode (□566)  
FP indicator (□374)
- 5 TTL flash compensation (□566)
- 6 Flash mode (□569)
- 7 FV lock indicator (□573)
- 8 Flash compensation (□572)

## ■ Auto External Flash

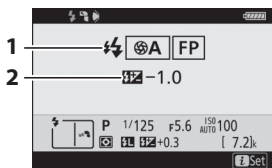

- 1 Flash control mode (□□566)  
FP indicator (□□374)
- 2 Auto external flash compensation (□□566)

## ■ Distance-Priority Manual

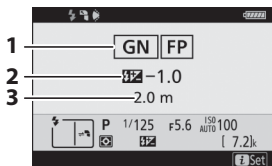

- 1 Flash control mode (□□566)  
FP indicator (□□374)
- 2 Distance-priority manual flash compensation (□□566)
- 3 Distance (□□566)

## ■ Manual

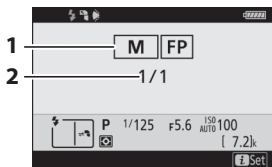

- 1 Flash control mode (□□566)  
FP indicator (□□374)
- 2 Flash level (□□566)

## ■ Repeating Flash

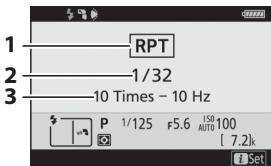

- 1 Flash control mode (☰566)
- 2 Output (☰566)
- 3 Times (☰566)  
Frequency (☰566)

## ✓ Flash Info and Camera Settings

The flash information display shows select camera settings, including shooting mode, shutter speed, aperture, and ISO sensitivity.



## ✓ Changing Flash Settings

Flash settings can be changed by pressing the **i** button in the flash info display. The options available vary with the flash unit and the settings selected. You can also test-fire the flash.

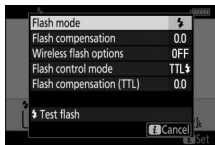

# Remote Flash Photography

## What Is Remote Flash Photography?

Take pictures with one or more remote flash units using wireless flash control (Advanced Wireless Lighting, or AWL). For information on using a flash unit mounted on the camera accessory shoe, see “On-Camera Flash Photography” (📖561).

---

Throughout this chapter, operations involving an accessory connected to the camera are indicated by 📷, operations involving remote flash units by 📷. For more information on using remote flash units (📷), see the manual provided with the flash unit.

---

## Using Remote Flash Units

Remote flash units can be controlled via:

- **radio signals** \* (☞581),

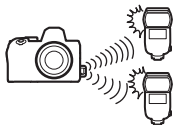

- **optical signals from a flash unit mounted on the camera accessory shoe** (☞595),

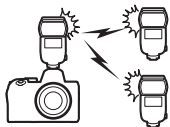

- **radio signals, with additional lighting provided by a shoe-mounted flash unit** \* (☞594), or

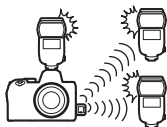

- **combined radio and optical signals** \* (☞606).

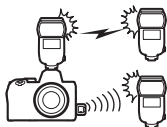

\* Radio flash control is available only when a WR-R10 is connected to the camera.

## Radio AWL

Remote flash control provided via radio signals from a WR-R10 connected to the camera is termed “radio Advanced Wireless Lighting”, or “radio AWL”. Radio AWL is available with SB-5000 flash units.

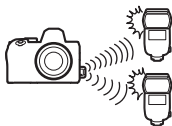

### **Establishing a Wireless Connection**

Before using radio AWL, establish a wireless connection between the WR-R10 and the remote flash units.

---

#### **✓ The WR-R10 Wireless Remote Controller**

Be sure to update the firmware for the optional WR-R10 wireless remote controller to version 3.0 or later before using radio AWL. For information on firmware updates, see the Nikon website for your area.

---

### **1 : Connect the WR-R10.**

For more information, see the documentation provided with the WR-R10.

- 2** : Select [Radio AWL] for [Flash control] > [Wireless flash options] in the photo shooting menu.

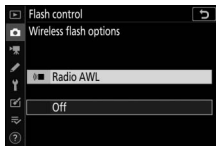

- 3** : Choose a channel for the WR-R10.

Set the WR-R10 channel selector to the desired channel.

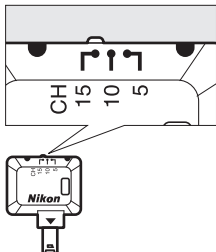



## 4 : Choose a link mode for the WR-R10.

Select **[Wireless remote (WR) options]** > **[Link mode]** in the camera setup menu and choose from the following options:

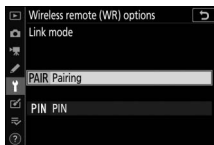

Option	Description
<b>[Pairing]</b>	<p>The camera connects only to devices with which it has previously been paired.</p> <ul style="list-style-type: none"><li>• As camera will not communicate with devices with which it has not been paired, this option can be used to prevent signal interference from other devices in the vicinity.</li><li>• Given that each device must be paired separately, however, PIN is recommended when connecting to a large number of devices.</li></ul>
<b>[PIN]</b>	<p>Communication is shared among all devices with the same four-digit PIN.</p> <ul style="list-style-type: none"><li>• This option is a good choice for photography featuring a large number of remote devices.</li><li>• If there are multiple cameras present that share the same PIN, the flash units will be under the sole control of the camera that connects first, preventing all other cameras from connecting (the LEDs on the WR-R10 units connected to the affected cameras will blink).</li></ul>

---

## **5** : Establish a wireless connection between the WR-R10 and the remote flash units.

- Set the remote units to radio AWL remote mode.
- Set the remote units to the channel you selected for the WR-R10 in Step 3.
- Pair each of the remote units with the WR-R10 according to the option selected in Step 4:
  - **[Pairing]**: Initiate pairing on the remote unit and press the WR-R10 pairing button. Pairing is complete when the LINK lamps on the WR-R10 and flash unit flash orange and green. Once a connection is established, the LINK lamp on the remote flash unit will light green.
  - **[PIN]**: Use the controls on the remote flash unit to enter the PIN you selected in the previous step. Pairing begins when the PIN is entered. Once a connection is established, the LINK lamp on the remote flash unit will light green.

---

## **6** : Repeat Step 5 for the remaining remote units.

## 7 : Confirm that the flash-ready lights for all flash units are lit.

In radio AWL, the flash-ready indicator will light in the camera shooting or flash information display when all flash units are ready.

### Listing Remote Flash Units

To view the flash units currently controlled using radio AWL, select [**Flash control**] > [**Radio remote flash info**] in the camera photo shooting menu.

- The identifier (remote flash unit name) for each unit can be changed using flash unit controls.

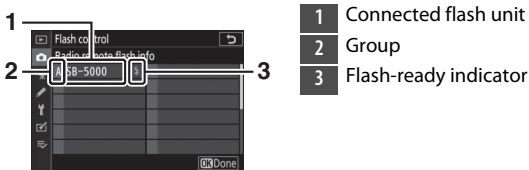

### Reconnecting

As long as the channel, link mode, and other settings remain the same, the WR-R10 will automatically connect to previously paired flash units when you select remote mode, and Steps 3–6 can be omitted. The flash unit LINK lamp lights green when a connection is established.

## Remote Flash Photography

Settings are adjusted using **[Flash control]** > **[Remote flash control]** in the photo shooting menu. Choose a remote flash control mode and take pictures as described below.

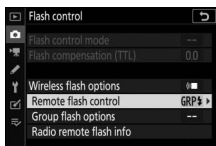

### ■ Group Flash

Select this item if you want to adjust settings separately for the flash units in each group.

- 1** : Select **[Group flash]** for **[Flash control]** > **[Remote flash control]**.

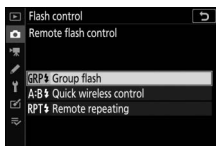

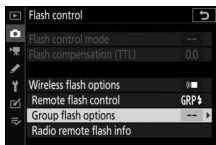

- 2** : Highlight **[Group flash options]** in the **[Flash control]** display and press .

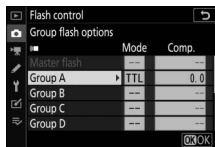

### 3 : Choose a flash control mode and flash level.

- Choose a flash control mode and flash level for the flash units in each group.
- The following options are available:



Option	Description
<b>TTL</b>	i-TTL flash control.
 <b>A</b>	Auto aperture. Available only with compatible flash units.
<b>M</b>	Choose the flash level manually.
-- (off)	The remote units do not fire. [ <b>Comp.</b> ] cannot be adjusted.

### 4 : Group the remote flash units.

- Choose a group (A–F) for each of the remote flash units.
- The master flash can control up to 18 flash units in any combination.

---

## 5 : Compose the shot and arrange the flash units.

- See the documentation provided with the flash units for more information.
- Test-fire the units and confirm that they are functioning normally. To test-fire the units, press the **i** button in the flash info display, highlight [**⚡ Test flash**], and press **OK** ( 609).

---

## 6 : Take the photograph.

## ■ Quick Wireless Control

Select this item to control the relative balance between the remote flash units in groups A and B and adjust flash output for group C. Output for group C is adjusted manually.

- 1 : Select [Quick wireless control] for [Flash control] > [Remote flash control].

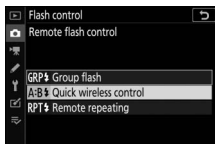

- 2 : Highlight [Quick wireless control options] in the [Flash control] display and press .

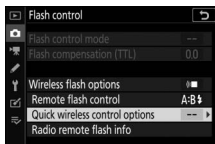

### 3 : Adjust quick wireless control settings.

- Choose the balance between groups A and B.

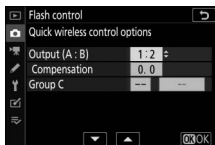

- Adjust flash compensation for groups A and B.

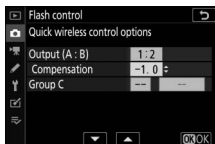

- Adjust settings for group C:
  - Select [M] to enable or [---] to disable the units in group C.
  - When [M] is selected, the units in group C will fire at the chosen output.

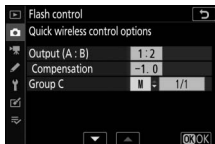



---

## 4 : Group the remote flash units.

- Choose a group (A, B, or C).
- The master flash can control up to 18 flash units in any combination.

---

## 5 / : Compose the shot and arrange the flash units.

- See the documentation provided with the flash units for more information.
- Test-fire the units and confirm that they are functioning normally. To test-fire the units, press the **i** button in the flash info display, highlight [**⚡ Test flash**], and press **OK** ( 609).

---

## 6 : Take the photograph.

## ■ Remote Repeating

The flash units fire repeatedly while the shutter is open, producing a multiple-exposure effect.

- 1** : Select [Remote repeating] for [Flash control] > [Remote flash control].

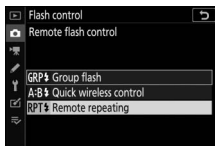

- 2** : Highlight [Remote repeating options] in the [Flash control] display and press .

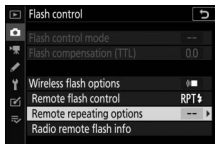

- 3** : Adjust remote repeating options.

- Adjust “output”, “times”, and “frequency”.

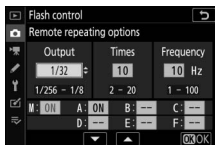

- Enable or disable selected groups.

- Select [ON] to enable the selected group, [---] to disable the selected group.

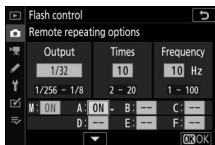



---

## 4 : Group the remote flash units.

- Choose a group (A–F) for each of the remote flash units.
- The master flash can control up to 18 flash units in any combination.

---

## 5 /: Compose the shot and arrange the flash units.

- See the documentation provided with the flash units for more information.
- Test-fire the units and confirm that they are functioning normally. To test-fire the units, press the  button in the flash info display, highlight [ **Test flash**], and press  (☐609).

---

## 6 : Take the photograph.

## Adding a Shoe-Mounted Flash Unit

Radio-controlled flash units (☞ 581) can be combined with any of the following flash units mounted on the camera accessory shoe:

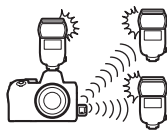

- SB-5000: Before attaching the flash unit, set it to radio-controlled master flash mode (a  icon will appear at the top left corner of the display) and choose group or remote-repeating flash control. Once the unit is attached, settings can be adjusted from the camera menus or using the controls on the SB-5000. In the case of the camera menus, use the options listed under [**Group flash options**] > [**Master flash**] or under [**M**] in the [**Remote repeating options**] display.
- SB-910, SB-900, SB-800, SB-700, SB-600: Configure the flash for standalone use. Use the controls on the flash unit to adjust flash settings.
- SB-500, SB-400, SB-300: Mount the unit on the camera. Adjust settings using the [**Group flash options**] > [**Master flash**] item in the camera menus.

## Optical AWL

Remote flash units can be controlled via optical signals from an optional flash unit mounted on the camera accessory shoe and functioning as a master flash (optical AWL). For information on compatible flash units, see “Features Available with CLS-Compatible Flash Units” (□ 640).

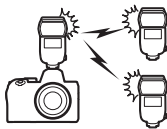

- If the flash unit in question is an SB-5000 or SB-500, settings can be adjusted from the camera. For more information, see “Using Optical AWL with the SB-5000 or SB-500” (□ 596). See the documentation provided with the flash units for more information.
- Settings for other flash units must be adjusted using flash unit controls. For more information, see the documentation provided with the flash unit in question.

## Using Optical AWL with the SB-5000 or SB-500

Mount the flash unit on the camera accessory shoe. Select **[Optical AWL]** for **[Flash control]** > **[Wireless flash options]** in the photo shooting menu and choose a remote flash control mode (the SB-500 supports only **[Group flash]**). Choose a remote flash control mode and take pictures as described below.

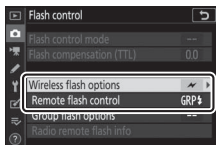

### ✓ The SB-5000

When an SB-5000 is mounted on the camera accessory shoe, **[Flash control]** settings can also be changed using the controls on the flash unit.

## ■ Group Flash

Select this item if you want to adjust settings separately for the flash units in each group.

- 1** : Select **[Group flash]** for **[Flash control]** > **[Remote flash control]**.

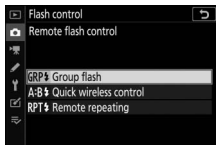

- 2** : Highlight **[Group flash options]** in the **[Flash control]** display and press .

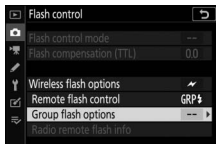

### 3 : Adjust flash output and choose the channel and flash control mode.

- Choose the flash control mode and flash level for the master flash and the remote flash units in each group.
- The following options are available:

Option	Description
<b>TTL</b>	i-TTL flash control.
 <b>A</b>	Auto aperture. Available only with compatible flash units.
<b>M</b>	Choose the flash level manually.
-- (off)	The remote units do not fire. [ <b>Comp.</b> ] cannot be adjusted.

- For [**Channel**], choose the channel (1–4) the master flash will use for optical remote flash control.
- If the remote flash units include an SB-500, you must choose channel [**3**].

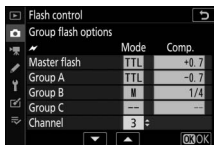
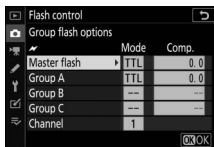

---

#### **4** : Choose a channel for the remote flash units.

Set the remote flash units to the channel selected for [Channel] in Step 3.

---

#### **5** : Group the remote flash units.

- Choose a group (A, B, or C).
  - If you are using an SB-500 as the master flash, choose from groups A and B.
  - There is no limit on the number of remote flash units that may be used. The practical maximum, however, is three per group, as the light emitted by the remote flash units will interfere with performance if more flash units are used.
- 

#### **6** /: Compose the shot and arrange the flash units.

- See the documentation provided with the flash units for more information.
  - Test-fire the units and confirm that they are functioning normally. To test-fire the units, press the test button on the master flash or press the **i** button in the flash info display and select [**⚡ Test flash**], and press **OK** ( 609).
- 

#### **7** /: Take the photograph after confirming that the flash-ready lights for all flash units are lit.



## ■ Quick Wireless Control (SB-5000 Only)

Select this item to control the relative balance between the remote flash units in groups A and B and adjust flash output for group C. Output for group C is adjusted manually.

- 1** : Select [Quick wireless control] for [Flash control] > [Remote flash control].

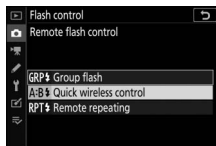

- 2** : Highlight [Quick wireless control options] in the [Flash control] display and press .

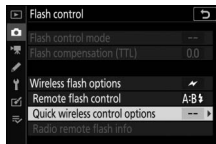

### 3 Adjust quick wireless control settings.

- Choose the balance between groups A and B.

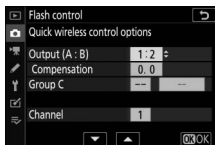

- Adjust flash compensation for groups A and B.

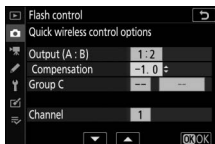

- Adjust settings for group C:
  - Select [M] to enable or [---] to disable the units in group C.
  - When [M] is selected, the units in group C will fire at the chosen output.

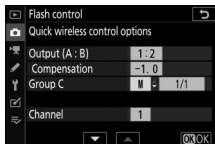

- Choose the channel.
  - For [Channel], choose the channel (1–4) the master flash will use for optical remote flash control.
  - If the remote flash units include an SB-500, you must choose channel [3].

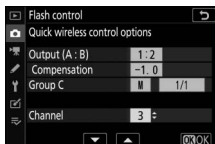

---

#### **4** : Choose a channel for the remote flash units.

Set the remote flash units to the channel selected for [Channel] in Step 3.

---

#### **5** : Group the remote flash units.

- Choose a group (A, B, or C).
  - There is no limit on the number of remote flash units that may be used. The practical maximum, however, is three per group, as the light emitted by the remote flash units will interfere with performance if more flash units are used.
- 

#### **6** /: Compose the shot and arrange the flash units.

- See the documentation provided with the flash units for more information.
  - Test-fire the units and confirm that they are functioning normally. To test-fire the units, press the test button on the master flash or press the **i** button in the flash info display and select [**⚡ Test flash**], and press  (📖 609).
- 

#### **7** /: Take the photograph after confirming that the flash-ready lights for all flash units are lit.

## ■ Remote Repeating (SB-5000 Only)

The flash units fire repeatedly while the shutter is open, producing a multiple-exposure effect.

- 1 : Select [Remote repeating] for [Flash control] > [Remote flash control].

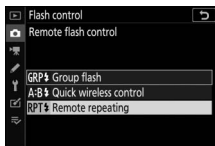

- 2 : Highlight [Remote repeating options] in the [Flash control] display and press .

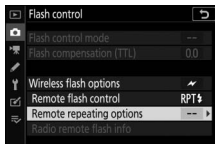

### 3 : Adjust remote repeating options.

- Adjust “output”, “times”, and “frequency”.



- Enable or disable selected groups.

- Select [ON] to enable the selected group, [--] to disable the selected group.

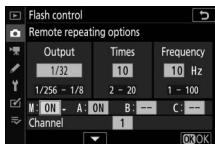

- Choose the channel.

- For [Channel], choose the channel (1–4) the master flash will use for optical remote flash control.

- If the remote flash units include an SB-500, you must choose channel [3].

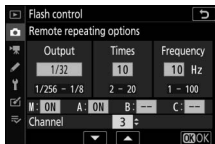

---

#### **4** : Choose a channel for the remote flash units.

Set the remote flash units to the channel selected for [Channel] in Step 3.

---

#### **5** : Group the remote flash units.

- Choose a group (A, B, or C).
  - There is no limit on the number of remote flash units that may be used. The practical maximum, however, is three per group, as the light emitted by the remote flash units will interfere with performance if more flash units are used.
- 

#### **6** / : Compose the shot and arrange the flash units.

- See the documentation provided with the flash units for more information.
  - Test-fire the units and confirm that they are functioning normally. To test-fire the units, press the test button on the master flash or press the **i** button in the flash info display and select [**⚡ Test flash**], and press **OK** (📖 609).
- 

#### **7** / : Take the photograph after confirming that the flash-ready lights for all flash units are lit.

---



## ✓ Optical AWL

- Position the sensor windows on the remote flash units to pick up the light from the master flash. Particular care is required if the master flash is mounted on a hand-held camera.
  - Be sure that direct light or strong reflections from the remote flash units do not enter the camera lens (in [TTL] mode) or the photocells on the remote flash units ([A] mode). Otherwise light from the flash units may interfere with exposure.
  - Even if [—] is selected for [Master flash] > [Mode], the master flash may emit low-intensity timing flashes. These flashes may appear in photographs taken at short range. This can be prevented by choosing low ISO sensitivities or small apertures (high f-numbers).
  - After positioning the remote flash units, take a test shot and view the results in the camera display.
-

## Optical/Radio AWL

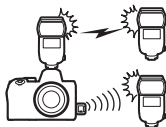
For simultaneous optical and radio AWL, attach a WR-R10 and mount an SU-800 or a master flash that supports optical flash control (the SB-910, SB-900, SB-800, SB-700, or SB-500) on the accessory shoe.



- Establish connections between the WR-R10 and all radio-controlled flash units (☐ 581).
- If an SB-500 is mounted on the camera accessory shoe, select **[Optical/radio AWL]** for **[Wireless flash options]**. With other flash units or the SU-800, **[Wireless flash options]** is set to **[Optical/radio AWL]** automatically.
- The only option available for **[Remote flash control]** will be **[Group flash]**.
- The remote flash units can be placed in up to six groups (A through F). Place optically-controlled units in groups A through C and radio-controlled units in groups D through F. To display options for groups D through F, press  or  in the **[Group flash options]** display.

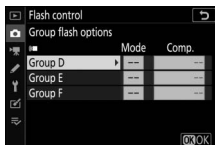



## Flash Info for Remote Units

The camera can display flash info for a SB-5000 or SB-500 flash unit mounted on the camera accessory shoe and configured as a master flash for optical AWL, as well as for remote flash units controlled via radio AWL using a WR-R10. To view flash info, press the **DISP** button in photo mode (☞21).

### Flash Control Mode Displays

#### ■ Group Flash

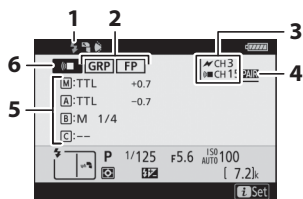

- 1 Flash-ready indicator <sup>1</sup>
- 2 Remote flash control (☞266)  
FP indicator (☞374)
- 3 Channel <sup>2</sup> (☞581, 596)
- 4 Link mode <sup>3</sup> (☞439)
- 5 Group flash control mode <sup>4</sup>  
Group flash mode (☞586, 596)  
Flash compensation/flash level (output; ☞586, 596)
- 6 Remote flash control mode <sup>2</sup>  
(☞265)

## Quick Wireless Control

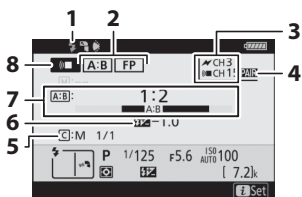

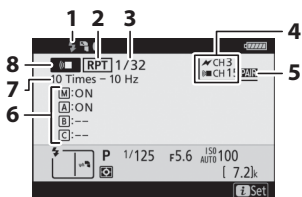

- 1 Flash-ready indicator <sup>1</sup>
- 2 Remote flash control (□ 266)  
FP indicator (□ 374)
- 3 Channel <sup>2</sup> (□ 581, 599)
- 4 Link mode <sup>3</sup> (□ 439)
- 5 Group C flash control mode  
and flash level (output; □ 589,  
599)
- 6 Flash compensation (□ 589,  
599)
- 7 A:B ratio (□ 589, 599)
- 8 Remote flash control mode <sup>2</sup>  
(□ 265)

## Remote Repeating



- 1 Flash-ready indicator <sup>1</sup>
- 2 Remote flash control (□ 266)
- 3 Output (□ 592, 602)
- 4 Channel <sup>2</sup> (□ 581, 602)
- 5 Link mode <sup>3</sup> (□ 439)
- 6 Group status (enabled/  
disabled; □ 592, 602)
- 7 Times (□ 592, 602)  
Frequency (□ 592, 602)
- 8 Remote flash control mode <sup>2</sup>  
(□ 265)

- 1 Displayed in radio AWL when all flash units are ready.
- 2 Optical AWL is indicated by , radio AWL by , joint optical and radio AWL by both icons together. Optical AWL channel for joint optical and radio AWL is displayed only when SB-500 is used as master flash.
- 3 Displayed only when radio AWL or joint optical and radio AWL is used.
- 4 Icons are displayed for each group only when joint optical and radio AWL is used.

## ✓ Flash Info and Camera Settings

The flash information display shows select camera settings, including shooting mode, shutter speed, aperture, and ISO sensitivity.



## ✓ The *i* Button

Flash settings can be changed by pressing the *i* button in the flash info display. The options available vary with the flash unit and the settings selected. You can also test-fire the flash.

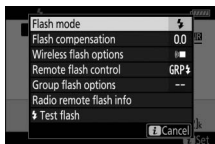

# Troubleshooting

## Before Contacting Customer Support

You may be able to resolve any issues with the camera by following the steps below. Check this list before consulting your retailer or Nikon-authorized service representative.

### STEP 1

**Check the list of common problems.**

Common problems and solutions are listed in the following sections:

- "Problems and Solutions" (□□612)
- "Alerts and Error Messages" (□□621)

### STEP 2

**Turn the camera off and remove the battery, then wait about a minute, re-insert the battery and turn the camera on.**

- ✓ The camera may continue to write data to the memory card after shooting. Wait at least a minute before removing the battery.

### STEP 3

**Search Nikon websites.**

- For support information and answers to frequently asked questions, visit the website for your country or region (□□xlii).
- To download the latest firmware for your camera, visit: <https://downloadcenter.nikonimglib.com/>

### STEP 4

**Consult a Nikon-authorized service representative.**

---

## ✓ Restoring Default Settings

- Depending on current settings, some menu items and other features may be unavailable. To access menu items that are grayed out or features that are otherwise unavailable, try restoring default settings using the **[Reset all settings]** item in the setup menu.
  - Note, however, that wireless network profiles, copyright information, and other user-generated entries will also be reset. Once reset, settings cannot be restored.
-

# Problems and Solutions

Solutions to some common issues are listed below.

## **Battery/Display**

---

### ● **The camera is on but does not respond:**

- Wait for recording and other operations to end.
  - If the problem persists, turn the camera off.
  - If the camera does not turn off, remove and reinsert the battery.
  - If you are using an AC adapter, disconnect and reconnect the AC adapter.
    - Any data currently being recorded will be lost.
    - Data that have already been recorded are not affected by removing or disconnecting the power source.
- 

### ● **The viewfinder or monitor does not turn on:**

- Have you changed the monitor mode? Choose a different monitor mode using the **|□|** button.
  - Have you limited the choice of monitor modes available using the [**Limit monitor mode selection**] item in the setup menu? Adjust settings as required.
  - Dust, lint, or other foreign matter on the eye sensor may prevent it functioning normally. Clean the eye sensor with a blower.
- 

### ● **The viewfinder is out of focus:**

- Rotate the diopter adjustment control to adjust viewfinder focus.
  - If adjusting viewfinder focus does not correct the problem, set the focus mode to **AF-S** and the AF-area mode to single-point AF. Next, select the center focus point, choose a high-contrast subject, and focus using autofocus. With the camera in focus, use the diopter adjustment control to bring the subject into clear focus in the viewfinder.
-

---

● **The display in the viewfinder or monitor turns off without warning:**

Choose longer delays for Custom Setting c3 [**Power off delay**].

---

## **Shooting**

---

● **The camera takes time to turn on:**

More time will be needed to find files if the memory card contains large numbers of files or folders.

● **The shutter cannot be released:**

- Is a memory card inserted, and if so, does it have space available?
- Is the memory card write-protected?
- If you selected mode **S** after selecting a shutter speed of “**Bulb**” or “**Time**” in mode **M**, choose a different shutter speed.
- Is [**Release locked**] selected for [**Slot empty release lock**] in the setup menu?

● **The camera is slow to respond to the shutter-release button:**

Select [**Off**] for Custom Setting d4 [**Exposure delay mode**].

● **Burst shooting is unavailable:**

Burst shooting cannot be used in conjunction with HDR.

● **Photos are out of focus:**

- Is the camera in manual focus mode? To enable autofocus, select **AF-S**, **AF-C**, or **AF-F** for focus mode.
  - Autofocus does not perform well under the following conditions. In these cases, use manual focus or focus lock. Autofocus does not perform well if: there is little or no contrast between the subject and the background, the focus point contains objects at different distances from the camera, the subject is dominated by regular geometric patterns, the focus point contains areas of sharply contrasting brightness, background objects appear larger than the subject, or the subject contains many fine details.
-

---

● **The beep does not sound:**

- Is [On] selected for [Silent photography] in the photo shooting menu?
- A beep does not sound when the camera focuses with AF-C selected for focus mode.
- Select an option other than [Off] for [Beep options] > [Beep on/off] in the setup menu.
- The beep does not sound in movie mode.

---

● **The full range of shutter speeds is not available:**

Using a flash restricts the range of shutter speeds available. Flash sync speed can be set to values of  $1/200$ – $1/60$  s using Custom Setting e1 [Flash sync speed]. When using flash units that support auto FP high-speed sync, choose [1/200 s (Auto FP)] for a full range of shutter speeds.

---

● **Focus does not lock when the shutter-release button is pressed halfway:**

When AF-C is selected for focus mode, focus can be locked by pressing the center of the sub-selector.

---

● **Focus-point selection is not available:**

Focus-point selection is not available when auto-area AF is selected for AF-area mode.

---

● **The camera is slow to record photos:**

Is [On] selected for [Long exposure NR] in the photo shooting menu?

---

● **Photographs and movies do not appear to have the same exposure as the preview shown in the display:**

- The effects of changes to settings that affect exposure and color are not visible in the display when [Off] is selected for Custom Setting d7 [Apply settings to live view].
  - Note that changes to [Monitor brightness] and [Viewfinder brightness] have no effect on images recorded with the camera.
-



---

● **Flicker or banding appears in movie mode:**

Select [**Flicker reduction**] in the movie shooting menu and choose an option that matches the frequency of the local AC power supply.

---

● **Bright regions or bands appear:**

Bright regions or bands may occur if the subject is lit by a flashing sign, flash, or other light source with brief duration.

---

● **Smudges appear in photographs:**

- Are there smudges on the front or rear (mount-side) lens elements?
- Is there foreign matter on the image sensor? Perform image sensor cleaning.

---

● **Bokeh is irregular:**

With fast shutter speeds and/or fast lenses, you may notice irregularities in how *bokeh* is shaped. The effect can be mitigated by choosing slower shutter speeds and/or higher f-numbers.

---

● **Pictures are affected by noticeable ghosting or flare:**

You may notice ghosting or flare in shots that include the sun or other bright light sources. These effects can be mitigated by attaching a lens hood or by composing shots with bright light sources well out of the frame. You can also try such techniques as removing lens filters, choosing a different shutter speed, or using silent photography.

---

● **Shooting ends unexpectedly or does not start:**

- Shooting may end automatically to prevent the camera overheating, for example if:
    - The ambient temperature is high
    - The camera has been used for extended periods to record movies
    - The camera has been used in continuous release modes for extended periods
  - If photographs cannot be taken because the camera is running hot, turn the camera off and wait for it to cool before trying to take photographs again. Note that the camera may feel warm to the touch, but this does not indicate a malfunction.
-

---

● **Image artifacts appear in the display during shooting:**

- To reduce noise, adjust settings such as ISO sensitivity, shutter speed, or Active D-Lighting.
- At high ISO sensitivities, noise may become more noticeable in long exposures or in pictures recorded when the camera temperature is elevated.
- Randomly-spaced bright pixels, fog, or bright spots may arise as a result of increases in the temperature of the camera's internal circuits. Turn the camera off when it is not in use.
- Randomly-spaced bright pixels, fog, lines or unexpected colors may appear if you press the  button to zoom in on the view through the lens during shooting.
- Note that the distribution of noise in the display may differ from that in the final picture.

---

● **The camera cannot measure a value for preset manual white balance:**

The subject is too dark or too bright.

---

● **Certain pictures cannot be selected as sources for preset manual white balance:**

Pictures created with cameras of other types cannot serve as sources for preset manual white balance.

---

● **White balance (WB) bracketing is unavailable:**

- White balance bracketing is not available when an NEF (RAW) or NEF + JPEG option is selected for image quality.
  - White balance bracketing cannot be used in multiple exposure and HDR modes.
-

- 
- **The effects of [Set Picture Control] differ from image to image:**  
[Auto] is selected for [Set Picture Control] or as the basis for a custom Picture Control created using [Manage Picture Control], or [A] (auto) is selected for [Quick sharp], [Contrast], or [Saturation]. For consistent results over a series of photographs, choose a setting other than [A] (auto).
- 
- **The option selected for metering cannot be changed:**  
The option selected for metering cannot be changed during exposure lock.
- 
- **Exposure compensation is not available:**  
Changes to exposure compensation in mode **M** apply only to the exposure indicator and have no effect on shutter speed or aperture.
- 
- **Uneven shading may appear in long exposures:**  
Uneven shading may appear in long exposures shot at shutter speeds of “Bulb” or “Time”. The effect can be mitigated by selecting [On] for [Long exposure NR] in the photo shooting menu.
- 
- **The AF-assist illuminator does not light:**
    - Is [Off] selected for Custom Setting a12 [Built-in AF-assist illuminator]?
    - The illuminator does not light in movie mode.
    - The illuminator does not light when **AF-C** or **MF** is selected for focus mode.
- 
- **Sound is not recorded with movies:**
    - Is [Microphone off] selected for [Microphone sensitivity] in the movie shooting menu?
    - Was the movie recorded with [Manual] chosen for [Microphone sensitivity] in the movie shooting menu and a low sensitivity selected?
-

## Playback

---

- **NEF (RAW) pictures are not visible during playback:**

The camera displays only the JPEG copies of pictures taken with [NEF (RAW) + JPEG fine★], [NEF (RAW) + JPEG fine], [NEF (RAW) + JPEG normal★], [NEF (RAW) + JPEG normal], [NEF (RAW) + JPEG basic★], or [NEF (RAW) + JPEG basic] selected for [Image quality].

---

- **Pictures taken with other cameras are not displayed:**

Pictures recorded with other types of camera may not display correctly.

---

- **Not all photos are visible during playback:**

Select [All] for [Playback folder] in the playback menu.

---

- **“Tall” (portrait) orientation photos are displayed in “wide” (landscape) orientation:**

- Is [Off] selected for [Rotate tall] in the playback menu?
  - Auto image rotation is not available during image review.
  - Camera orientation may not be correctly recorded in photos taken with the camera pointing up or down.
- 

- **Pictures cannot be deleted:**

- Is the memory card write-protected?
  - Are the pictures protected?
- 

- **Pictures cannot be retouched:**

- The pictures cannot be further edited with this camera.
  - There is insufficient space on the memory card to record the retouched copy.
- 

- **The camera displays the message, [Folder contains no images]:**

Select [All] for [Playback folder] in the playback menu.

---

- **NEF (RAW) pictures cannot be printed:**

- Print JPEG copies of the pictures created using a tool such as the [NEF (RAW) processing] item in the retouch menu.
  - Copy the pictures to a computer and print them using NX Studio or other software that supports the NEF (RAW) format.
-

---

● **Pictures are not displayed on HDMI devices:**

Confirm that an HDMI cable is correctly connected.

---

● **Output to HDMI devices does not function as expected:**

- Confirm that an HDMI cable is correctly connected.
- Is **[On]** selected for **[HDMI] > [Advanced] > [External recording control]** in the setup menu?
- Pictures may display correctly if default settings are restored using the **[Reset all settings]** item in the setup menu.

---

● **The Image Dust Off option in NX Studio does not have desired effect:**

Image sensor cleaning changes the position of dust on the image sensor and will not have the desired effect if:

- Dust off reference data recorded after image sensor cleaning is performed are used with photographs taken before image sensor cleaning is performed
- Dust off reference data recorded before image sensor cleaning is performed are used with photographs taken after image sensor cleaning is performed

---

● **The effects of [Set Picture Control], [Active D-Lighting], or [Vignette control] are not visible:**

In the case of NEF (RAW) pictures, the effects can only be viewed using Nikon software. View NEF (RAW) pictures using NX Studio.

---

● **Pictures cannot be copied to a computer:**

Depending on the operating system, you may be unable to upload pictures when the camera is connected to a computer. Copy pictures from the memory card to a computer using a card reader or other device.

---

## **Bluetooth and Wi-Fi (Wireless Networks)**

---

- **Smart devices do not display the camera SSID (network name):**
    - Navigate to the setup menu and confirm both that [**Disable**] is selected for [**Airplane mode**] and that [**Enable**] is selected for [**Connect to smart device**] > [**Pairing (Bluetooth)**] > [**Bluetooth connection**].
    - Confirm that [**Connect to smart device**] > [**Wi-Fi connection**] is enabled in the setup menu.
    - Try disabling and re-enabling wireless network features on the smart device.
- 

- **The camera cannot connect to printers and other wireless devices:**

The camera cannot establish wireless connections with devices other than smartphones, tablets, and computers.

---

## **Miscellaneous**

---

- **The date of recording is not correct:**

Is the camera clock set correctly? The clock is less accurate than most watches and household clocks; check it regularly against more accurate timepieces and reset as necessary.
  - **Menu items cannot be selected:**

Some items are not available at certain combinations of settings.
-

## Alerts and Error Messages

This section lists the alerts and error messages that appear in the camera display.

### Alerts

The following alerts appear in the camera display:

Alert	Problem	Solution
	Low battery.	Ready spare battery.
F --	Lens is not correctly attached.	<ul style="list-style-type: none"><li>• Ensure that the lens is correctly attached.</li><li>• Ensure that retractable lenses are extended.</li><li>• This indicator is also displayed when a non-CPU lens is attached via a mount adapter, but in this case no action need be taken.</li></ul>
<b>Bulb</b> (flashes)	" <b>Bulb</b> " selected in mode <b>S</b> .	<ul style="list-style-type: none"><li>• Change shutter speed.</li><li>• Select mode <b>M</b>.</li></ul>
<b>Time</b> (flashes)	" <b>Time</b> " selected in mode <b>S</b> .	<ul style="list-style-type: none"><li>• Change shutter speed.</li><li>• Select mode <b>M</b>.</li></ul>

Alert	Problem	Solution
(Exposure indicators and shutter speed or aperture display flash)	Subject too bright; limits of camera exposure metering system exceeded.	<ul style="list-style-type: none"> <li>• Lower ISO sensitivity.</li> <li>• Shooting mode <b>P</b>: Use third-party ND (neutral density) filter (filter can also be used if alert is still displayed after following settings are adjusted in mode <b>S</b> or <b>A</b>).</li> <li>• Shooting mode <b>S</b>: Choose faster shutter speed.</li> <li>• Shooting mode <b>A</b>: Choose smaller aperture (higher f-number).</li> </ul>
	Subject too dark; limits of camera exposure metering system exceeded.	<ul style="list-style-type: none"> <li>• Increase ISO sensitivity.</li> <li>• Shooting mode <b>P</b>: Use optional flash unit (flash can also be used if alert is still displayed after following settings are adjusted in mode <b>S</b> or <b>A</b>).</li> <li>• Shooting mode <b>S</b>: Choose slower shutter speed.</li> <li>• Shooting mode <b>A</b>: Choose wider aperture (lower f-number).</li> </ul>



Alert	Problem	Solution
 (flashes)	Flash has fired at full power.	Photo may be underexposed. Check distance to subject and settings such as aperture, flash range, and ISO sensitivity.
	Subjects appear dark and underexposed.	Use optional flash unit.
<b>Full</b> (flashes)	<ul style="list-style-type: none"> <li>• Memory insufficient to record further photos.</li> <li>• Camera has run out of file numbers.</li> </ul>	<ul style="list-style-type: none"> <li>• Delete pictures from memory card until there is room for additional pictures to be recorded. Copy pictures you wish to keep to computer or other device before proceeding.</li> <li>• Insert new memory card.</li> </ul>
<b>Err</b> (flashes)	Camera malfunction.	Press shutter-release button again. If error persists or appears frequently, consult Nikon-authorized service representative.
<b>Card</b> (flashes)	The memory card is write-protected ("locked").	Slide the lock switch to the "write" position (□41).

## **Error Messages**

The following error messages may appear in the camera display:

<b>Messages</b>	<b>Problem</b>	<b>Solution</b>
Shutter release disabled. Recharge battery.	Battery exhausted.	<ul style="list-style-type: none"><li>• Replace with spare battery.</li><li>• Charge battery.</li></ul>
This battery cannot be used. It does not communicate properly with this camera. To use the camera safely, choose a battery designated for use in this camera.	Battery info not available.	<ul style="list-style-type: none"><li>• Battery cannot be used. Contact Nikon-authorized service representative.</li><li>• Battery level is extremely low; charge battery.</li></ul>
	Battery cannot supply data to camera.	Replace third-party batteries with genuine Nikon batteries.
No memory card.	Memory card not inserted or inserted incorrectly.	Check that card is inserted correctly.

Messages	Problem	Solution
Cannot access this memory card. Insert another card.	Error accessing memory card.	<ul style="list-style-type: none"> <li>• Check that camera supports memory card.</li> <li>• If error persists after card has been repeatedly ejected and reinserted, card may be damaged. Contact retailer or Nikon-authorized service representative.</li> </ul>
	Unable to create new folder.	<ul style="list-style-type: none"> <li>• Delete pictures from memory card until there is room for additional pictures to be recorded. Copy pictures you wish to keep to computer or other device before proceeding.</li> <li>• Insert new memory card.</li> </ul>

Messages	Problem	Solution
Memory card is locked. Slide lock to "write" position.	The memory card is write-protected ("locked").	Slide the lock switch to the "write" position (☐41).
This card is not formatted. Format the card.	Memory card is not correctly formatted.	<ul style="list-style-type: none"> <li>• Format memory card.</li> <li>• Replace with correctly-formatted memory card.</li> </ul>
Recording interrupted. Please wait.	Memory card does not support required movie write speed.	Use card that supports required write speed or change option selected for <b>[Frame size/frame rate]</b> in movie shooting menu.
The camera is too hot. It cannot be used until it cools. Please wait. Camera will turn itself off.	Camera's internal temperature is elevated.	Suspend shooting until camera has cooled.
	High battery temperature.	Remove battery and wait for it to cool.

Messages	Problem	Solution
Folder contains no images.	Folder contains no images.	Insert memory card that contains pictures.
	No pictures in folder selected for playback.	Use [ <b>Playback folder</b> ] item in playback menu to select folder that contains pictures.
Cannot display this file.	<ul style="list-style-type: none"> <li>File has been modified using computer application or does not conform to DCF file standard.</li> <li>File is corrupt.</li> </ul>	Do not overwrite images using computer applications.
Cannot select this file.	Selected picture cannot be retouched.	Retouch options are available only with pictures taken with or previously retouched on camera.
This movie cannot be edited.	Selected movie cannot be edited.	<ul style="list-style-type: none"> <li>Movies created with other devices cannot be edited.</li> <li>Movies under two seconds long cannot be edited.</li> </ul>

# Technical Notes

## Compatible Lenses and Accessories

The camera can be used with all Z mount lenses.

NIKKOR Z 24–70mm f/4 S

*Confirm that the lens name includes "NIKKOR Z".*

---

### Compatible F Mount Lenses

F mount lenses can be mounted on Z mount cameras using an FTZ mount adapter.

- Some features may not be available depending on the lens used.

Information on the F mount lenses that can be used with Z mount cameras and on any restrictions that may apply can be found in *Compatible F Mount Lenses*, available from the Nikon Download Center:

<https://downloadcenter.nikonimglib.com/en/products/491/FTZ.html>

---

# Camera Displays

For illustrative purposes, the displays are shown with all indicators lit.

## Monitor

### ■ Photo Mode

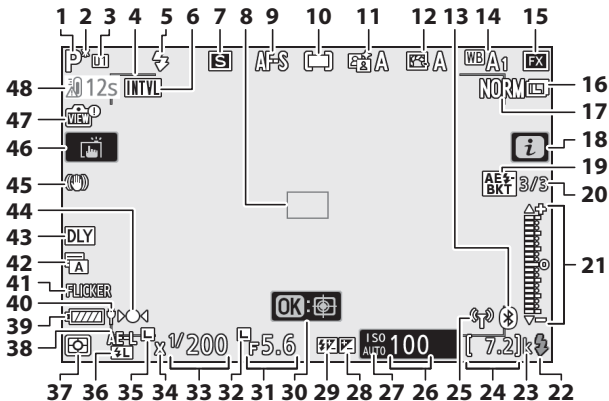

- 1 Shooting mode (☐93)
- 2 Flexible program indicator (☐94)
- 3 User setting mode (☐102)
- 4 AF-area brackets (☐66)
- 5 Flash mode (☐569)

- 6 Interval timer indicator (☐297)
- ☉ icon (☐47)
- "No memory card" indicator (☐38, 40)

7	Release mode (☐ 111, 142)	20	Number of shots in exposure and flash bracketing sequence (☐ 270)
8	Focus point (☐ 48, 66)		Number of shots in WB bracketing sequence (☐ 275)
9	Focus mode (☐ 63)		Number of shots in ADL bracketing sequence (☐ 278)
10	AF-area mode (☐ 66)		HDR exposure differential (☐ 292)
11	Active D-Lighting (☐ 255)		Number of multiple exposure (☐ 284)
12	Picture Control (☐ 123)	21	Exposure indicator
13	Bluetooth connection indicator (☐ 442)		Exposure (☐ 98)
	Airplane mode (☐ 441)		Exposure compensation (☐ 109)
14	White balance (☐ 81, 129, 239)		Auto bracketing (☐ 269)
15	Image area (☐ 234)	22	Flash-ready indicator (☐ 563)
16	Image size (☐ 138)	23	"k" (appears when memory remains for over 1000 exposures; ☐ 39)
17	Image quality (☐ 136)	24	Number of exposures remaining (☐ 39, 692)
18	<b>i</b> icon (☐ 120)	25	Wi-Fi connection indicator (☐ 141)
19	Exposure and flash bracketing indicator (☐ 270)		
	WB bracketing indicator (☐ 275)		
	ADL bracketing indicator (☐ 278)		
	HDR indicator (☐ 292)		
	Multiple exposure indicator (☐ 284)		



26	ISO sensitivity (☐105)	37	Metering (☐140)
27	ISO sensitivity indicator (☐105) Auto ISO sensitivity indicator (☐107)	38	Autoexposure (AE) lock (☐117)
28	Exposure compensation indicator (☐109)	39	Battery indicator (☐37)
29	Flash compensation indicator (☐572)	40	USB power delivery (☐450)
30	Subject-tracking AF (☐74)	41	Flicker detection (☐261)
31	Aperture (☐96, 97)	42	Shutter type (☐369) Silent photography (☐87)
32	Aperture lock icon (☐396)	43	Exposure delay mode (☐368)
33	Shutter speed (☐95, 97)	44	Focus indicator (☐78)
34	Flash sync indicator (☐374)	45	Vibration reduction indicator (☐143)
35	Shutter speed lock icon (☐396)	46	Touch shooting (☐15, 76)
36	FV lock indicator (☐573)	47	Live view preview indicator (☐372)
		48	Temperature warning

---

### ✔ Temperature Warnings

- If the camera temperature becomes elevated, a temperature warning and count-down timer will be displayed. When the timer reaches zero, the shooting display will turn off.
  - The timer turns red when the thirty second mark is reached. In some cases, the timer may be displayed immediately after the camera is turned on.
-

## The Information Display

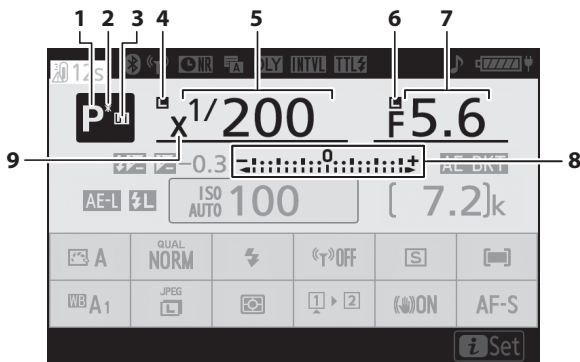

- 1 Shooting mode (□93)
- 2 Flexible program indicator (□94)
- 3 User setting mode (□102)
- 4 Shutter speed lock icon (□396)
- 5 Shutter speed (□95, 97)
- 6 Aperture lock icon (□396)
- 7 Aperture (□96, 97)

- 8 Exposure indicator  
Exposure (□98)  
Exposure compensation (□109)  
Exposure and flash bracketing (□270)  
WB bracketing (□275)  
ADL bracketing (□278)
- 9 Flash sync indicator (□374)

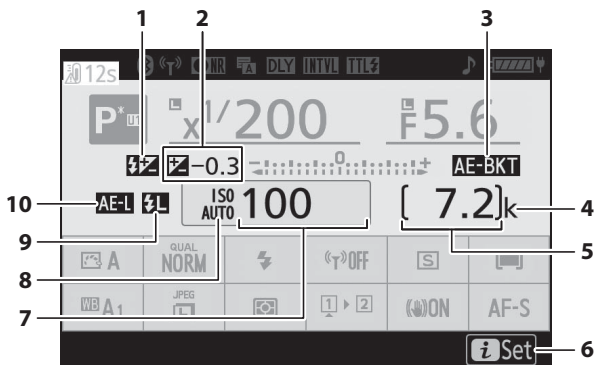

- |   |  |
|---|--|
| <p><b>1</b> Flash compensation indicator (☐572)</p> <p><b>2</b> Exposure compensation indicator (☐109)<br/>Exposure compensation value (☐109)</p> <p><b>3</b> Exposure and flash bracketing indicator (☐270)<br/>WB bracketing indicator (☐275)<br/>ADL bracketing indicator (☐278)<br/>HDR indicator (☐292)<br/>Multiple exposure indicator (☐284)</p> | <p><b>4</b> “k” (appears when memory remains for over 1000 exposures; ☐39)</p> <p><b>5</b> Number of exposures remaining (☐39, 692)</p> <p><b>6</b> <b>i</b> icon (☐120)</p> <p><b>7</b> ISO sensitivity (☐105)</p> <p><b>8</b> ISO sensitivity indicator (☐105)<br/>Auto ISO sensitivity indicator (☐107)</p> <p><b>9</b> FV lock indicator (☐573)</p> <p><b>10</b> Autoexposure (AE) lock (☐117)</p> |
|---|--|

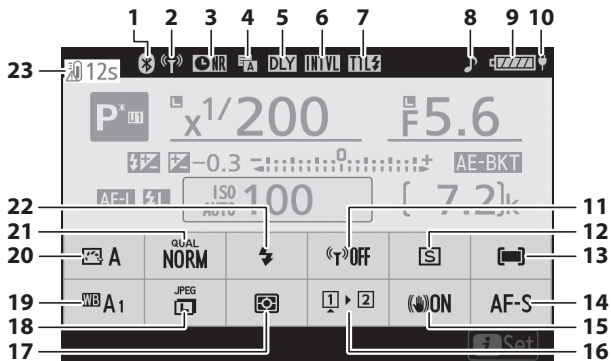

- 1** Bluetooth connection indicator (☎ 442)  
Airplane mode (☎ 441)
- 2** Wi-Fi connection indicator (☎ 141)
- 3** Long exposure noise reduction indicator (☎ 257)
- 4** Shutter type (☎ 369)  
Silent photography (☎ 87)
- 5** Exposure delay mode (☎ 368)
- 6** Interval timer indicator (☎ 297)  
⊕ icon (☎ 47)
- 7** Flash control mode (☎ 566)
- 8** “Beep” indicator (☎ 435)
- 9** Battery indicator (☎ 37)
- 10** USB power delivery (☎ 450)

- 11** Wi-Fi connection (☎ 141)
- 12** Release mode (☎ 111, 142)
- 13** AF-area mode (☎ 66)
- 14** Focus mode (☎ 63)
- 15** Vibration reduction indicator (☎ 143)
- 16** View memory card info (☎ 141)
- 17** Metering (☎ 140)
- 18** Image size (☎ 138)
- 19** White balance (☎ 81, 129, 239)
- 20** Set Picture Control (☎ 123)
- 21** Image quality (☎ 136)
- 22** Flash mode (☎ 569)
- 23** Temperature warning

## ■ Movie Mode

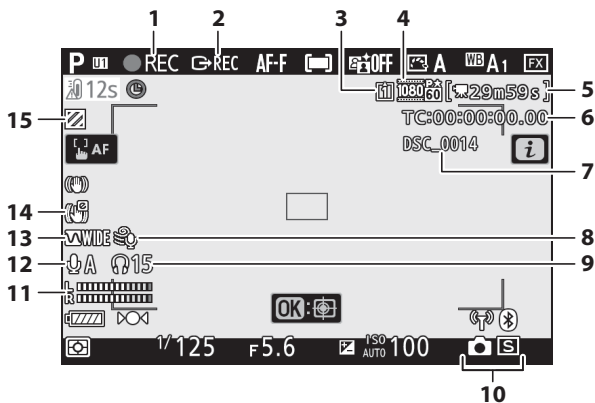

- |   |   |    |  |
|---|---|----|--|
| 1 | Recording indicator (☐ 53)<br>“No movie” indicator (☐ 56) | 9  | Headphone volume (☐ 344)                   |
| 2 | External recording control<br>(☐ 559)                     | 10 | Release mode (still<br>photography; ☐ 114) |
| 3 | Destination (☐ 155)                                       | 11 | Sound level (☐ 152)                        |
| 4 | Frame size and rate/image<br>quality (☐ 150)              | 12 | Microphone sensitivity<br>(☐ 152)          |
| 5 | Time remaining (☐ 53)                                     | 13 | Frequency response (☐ 343)                 |
| 6 | Timecode (☐ 345)  | 14 | Electronic VR indicator (☐ 156)            |
| 7 | File name (☐ 231)   | 15 | Highlight display (☐ 412)                  |
| 8 | Wind noise reduction (☐ 344)                              |    |  |

# Viewfinder

## ■ Photo Mode

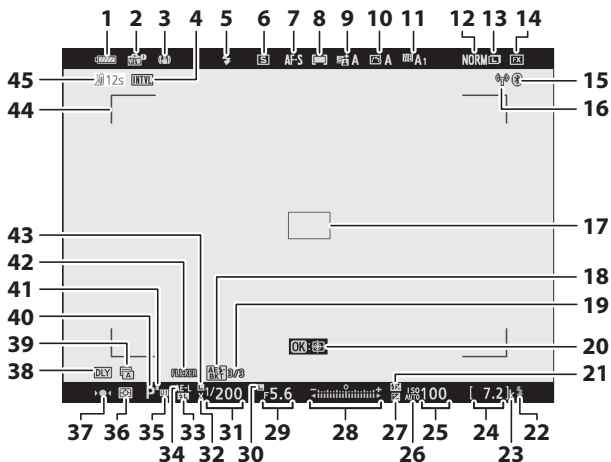

- |   |                                       |
|---|---------------------------------------|
| 1 | Battery indicator (□ 37)              |
| 2 | Live view preview indicator (□ 372)   |
| 3 | Vibration reduction indicator (□ 143) |
| 4 | Interval timer indicator (□ 297)      |
| 5 | Flash mode (□ 569)                    |

- |    |                                |
|----|--------------------------------|
| 6  | Release mode (□ 111, 142)      |
| 7  | Focus mode (□ 63)              |
| 8  | AF-area mode (□ 66)            |
| 9  | Active D-Lighting (□ 255)      |
| 10 | Picture Control (□ 123)        |
| 11 | White balance (□ 81, 129, 239) |
| 12 | Image quality (□ 136)          |
| 13 | Image size (□ 138)             |

14	Image area (☐234)	22	Flash-ready indicator (☐563)
15	Bluetooth connection indicator (☐442) Airplane mode (☐441)	23	“k” (appears when memory remains for over 1000 exposures; ☐39)
16	Wi-Fi connection indicator (☐141)	24	Number of exposures remaining (☐39, 692)
17	Focus point (☐48, 66)	25	ISO sensitivity (☐105)
18	Exposure and flash bracketing indicator (☐270) WB bracketing indicator (☐275) ADL bracketing indicator (☐278) HDR indicator (☐292) Multiple exposure indicator (☐284)	26	ISO sensitivity indicator (☐105) Auto ISO sensitivity indicator (☐107)
19	Number of shots in exposure and flash bracketing sequence (☐270) Number of shots in WB bracketing sequence (☐275) Number of shots in ADL bracketing sequence (☐278) HDR exposure differential (☐292) Number of multiple exposure (☐284)	27	Exposure compensation indicator (☐109)
20	Subject-tracking AF (☐74)	28	Exposure indicator Exposure (☐98) Exposure compensation (☐109) Auto bracketing (☐269)
21	Flash compensation indicator (☐572)	29	Aperture (☐96, 97)
		30	Aperture lock icon (☐396)
		31	Shutter speed (☐95, 97)
		32	Flash sync indicator (☐374)
		33	FV lock indicator (☐573)
		34	Autoexposure (AE) lock (☐117)
		35	User setting mode (☐102)
		36	Metering (☐140)

37	Focus indicator (□□78)
38	Exposure delay mode (□□368)
39	Shutter type (□□369) Silent photography (□□87)
40	Shooting mode (□□93)
41	Flexible program indicator (□□94)
42	Flicker detection (□□261)
43	Shutter speed lock icon (□□396)
44	AF-area brackets (□□66)
45	Temperature warning



## ■ Movie Mode

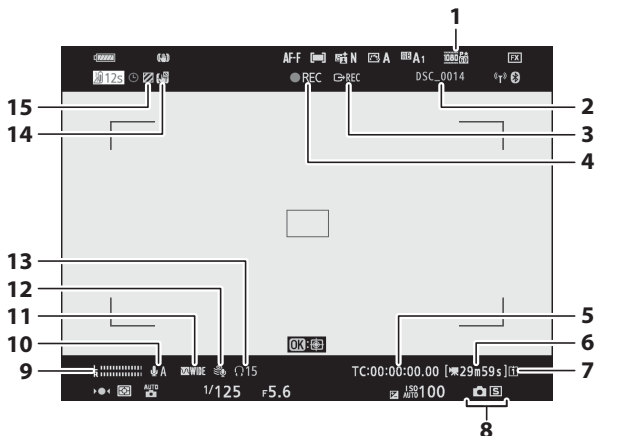

- |   |   |
|---|---|
| 1 | Frame size and rate/image quality (□150)                |
| 2 | File name (□231)  |
| 3 | External recording control (□559)                       |
| 4 | Recording indicator (□53)<br>"No movie" indicator (□56) |
| 5 | Timecode (□345)   |
| 6 | Time remaining (□53)                                    |
| 7 | Destination (□155)                                      |
| 8 | Release mode (still photography; □114)                  |

- |    |                                |
|----|--------------------------------|
| 9  | Sound level (□152)             |
| 10 | Microphone sensitivity (□152)  |
| 11 | Frequency response (□343)      |
| 12 | Wind noise reduction (□344)    |
| 13 | Headphone volume (□344)        |
| 14 | Electronic VR indicator (□156) |
| 15 | Highlight display (□412)       |



## Compatible Flash Units

### The Nikon Creative Lighting System (CLS)



Nikon's advanced Creative Lighting System (CLS) supports a variety of features thanks to improved communication between the camera and compatible flash units.

#### ■ Features Available with CLS-Compatible Flash Units

Supported features			Flash unit								
			SB-5000	SB-800	SB-900/ SB-800	SB-910/ SB-700	SB-600	SB-500	SU-800	SB-R200	SB-400
Single flash	i-TTL	i-TTL balanced fill-flash <sup>1</sup>	✓	✓	✓	✓	✓	—	—	✓	✓
		Standard i-TTL fill-flash	✓ <sup>2</sup>	✓ <sup>2</sup>	✓	✓ <sup>2</sup>	✓	—	—	✓	✓
	 A	Auto aperture	✓	✓ <sup>3</sup>	—	—	—	—	—	—	—
	A	Non-TTL auto	—	✓ <sup>3</sup>	—	—	—	—	—	—	—
	GN	Distance-priority manual	✓	✓	✓	—	—	—	—	—	—
	M	Manual	✓	✓	✓	✓	✓ <sup>4</sup>	—	—	✓ <sup>4</sup>	✓ <sup>4</sup>
	RPT	Repeating flash	✓	✓	—	—	—	—	—	—	—

Supported features		Flash unit									
		SB-5000	SB-800	SB-900/ SB-910/ SB-800	SB-700	SB-600	SB-500	SU-800	SB-R200	SB-400	SB-300
Optical Advanced Wireless Lighting	Master	Remote flash control	✓	✓	✓	—	✓ <sup>4</sup>	✓	—	—	—
		<b>i-TTL</b> i-TTL	✓	✓	✓	—	✓ <sup>4</sup>	—	—	—	—
		<b>[A : B]</b> Quick wireless flash control	✓	—	✓	—	—	✓ <sup>5</sup>	—	—	—
		 <b>A</b> Auto aperture	✓	✓	—	—	—	—	—	—	—
		<b>A</b> Non-TTL auto	—	—	—	—	—	—	—	—	—
		<b>M</b> Manual	✓	✓	✓	—	✓ <sup>4</sup>	—	—	—	—
		<b>RPT</b> Repeating flash	✓	✓	—	—	—	—	—	—	—
	Remote	<b>i-TTL</b> i-TTL	✓	✓	✓	✓	✓	—	✓	—	—
		<b>[A : B]</b> Quick wireless flash control	✓	✓	✓	✓	✓	—	✓	—	—
		 <b>A/A</b> Auto aperture/ non-TTL auto	✓ <sup>6</sup>	✓ <sup>6</sup>	—	—	—	—	—	—	—
		<b>M</b> Manual	✓	✓	✓	✓	✓	—	✓	—	—
		<b>RPT</b> Repeating flash	✓	✓	✓	✓	✓	—	—	—	—

Supported features	Flash unit									
	SB-5000	SB-800	SB-910/ SB-900/ SB-800	SB-700	SB-600	SB-500	SU-800	SB-R200	SB-400	SB-300
Radio-controlled Advanced Wireless Lighting	✓ <sup>7</sup>	—	—	—	—	—	—	—	—	—
Color Information Communication (flash)	✓	✓	✓	✓	✓	—	—	✓	✓	—
Color Information Communication (LED light)	—	—	—	—	✓	—	—	—	—	—
Auto FP high-speed sync <sup>8</sup>	✓	✓	✓	✓	✓	✓	✓	—	—	—
FV lock <sup>9</sup>	✓	✓	✓	✓	✓	✓	✓	✓	✓	✓
Red-eye reduction	✓	✓	✓	✓	✓	—	—	✓	—	—
Camera modeling illumination	✓	✓	✓	✓	✓	✓	✓	—	—	—
Unified flash control	✓	—	—	—	✓	—	—	✓	✓	—
Camera flash unit firmware update	✓	✓ <sup>10</sup>	✓	—	✓	—	—	—	—	✓

- 1 Not available with spot metering.
- 2 Can also be selected via the flash unit.
- 3  A/A mode selection is performed on the flash unit using custom settings.
- 4 Can be selected using the [**Flash control**] item in the camera menus.
- 5 Available during close-up photography only.
- 6 Choice of  A and **A** depends on the option selected with the master flash.
- 7 Supports the same features as remote flash units with optical AWL.
- 8 Available only in **i-TTL**,  A, **A**, **GN**, and **M** flash-control modes.

- 9 Available only in **i-TTL** flash control mode or when the flash is configured to emit monitor preflashes in **ⓂA** or **A** flash control mode.
- 10 Firmware updates for the SB-910 and SB-900 can be performed from the camera.

## ■ ■ The SU-800 Wireless Speedlight Commander

When mounted on a CLS-compatible camera, the SU-800 can be used as a commander for SB-5000, SB-910, SB-900, SB-800, SB-700, SB-600, SB-500, or SB-R200 flash units. Group flash control is supported for up to three groups. The SU-800 itself is not equipped with a flash.

---

### ✓ Flash Photography

Flash photography cannot be combined with some camera features, including:

- silent photography,
- movie recording, and
- HDR (high dynamic range)



## ✓ Other Flash Units

The following flash units can be used in non-TTL auto (**A**) and manual modes. The options available do not vary with the lens used.

Supported features			Flash unit		
			SB-80DX SB-28DX SB-28 SB-26 SB-25 SB-24	SB-50DX SB-23 SB-29 SB-21B SB-29S	SB-30 SB-27 <sup>1</sup> SB-22S SB-22 SB-20 SB-16B SB-15
Flash mode	<b>A</b>	Non-TTL auto	✓	—	✓
	<b>M</b>	Manual	✓	✓	✓
		Repeating flash	✓	—	—
	<b>REAR</b> <sup>2</sup>	Rear-curtain sync	✓	✓	✓

- 1 Mounting an SB-27 on the camera automatically sets the flash mode to **TTL**, but setting the flash mode to **TTL** disables the shutter release. Set the SB-27 to **A**.
- 2 Available when the camera is used to select the flash mode.

## ✓ Using FV Lock with Optional Flash Units

- FV lock is available with optional flash units in TTL and (where supported) monitor pre-flash  **A** and monitor pre-flash **A** flash control modes (see the manual provided with the flash unit for more information).
- Note that when Advanced Wireless Lighting is used to control remote flash units, you will need to set the flash control mode for the master or at least one remote group to **TTL**,  **A**, or **A**.

## ✔ Metering Areas for FV Lock

The areas metered when FV lock is used with optional flash units are as follows:

Picture taken with	Flash control mode	Metered area
Stand-alone flash unit	i-TTL	6-mm circle in center of frame
	Auto aperture (Ⓐ)	Area metered by flash exposure meter
Remote flash units controlled via Advanced Wireless Lighting	i-TTL	Entire frame
	Auto aperture (Ⓐ)	Area metered by flash exposure meter
	Non-TTL auto (A)	

## ✔ Notes on Optional Flash Units

- Refer to the flash unit manual for detailed instructions.
- If the unit supports CLS, refer to the section on CLS-compatible digital SLR cameras. This camera is not included in the “digital SLR” category in the SB-80DX, SB-28DX, and SB-50DX manuals.
- If the flash-ready indicator (⚡) flashes for about three seconds after a photograph is taken in i-TTL or non-TTL auto mode, the flash has fired at full power and the photograph may be underexposed (CLS-compatible flash units only).
- i-TTL flash control can be used at ISO sensitivities between 100 and 12800.
- At ISO sensitivities over 12800, the desired results may not be achieved at some ranges or aperture settings.

- In mode **P**, the maximum aperture (minimum f-number) is limited according to ISO sensitivity, as shown below:

Maximum aperture (f-number) at ISO equivalent of:							
100	200	400	800	1600	3200	6400	12800
4	5	5.6	7.1	8	10	11	13

- \* If the maximum aperture of the lens is smaller than given above, the maximum value for aperture will be the maximum aperture of the lens.
- The SB-5000, SB-910, SB-900, SB-800, SB-700, SB-600, SB-500, and SB-400 provide red-eye reduction in red-eye reduction and slow-sync with red-eye reduction flash modes.
- “Noise” in the form of lines may appear in flash photographs taken with an SD-9 or SD-8A high-performance battery pack attached directly to the camera. Reduce ISO sensitivity or increase the distance between the camera and the battery pack.
- The camera provides AF-assist illumination as required. AF-assist illuminators on optional flash units will not light.
- When an SC-series 17, 28, or 29 sync cable is used for off-camera flash photography, correct exposure may not be achieved in i-TTL mode. We recommend that you select standard i-TTL fill-flash. Take a test shot and view the results in the camera display.
- In i-TTL, do not use any form of flash panel (diffusion panel) other than the flash unit’s built-in flash panel or supplied bounce adapter. Using other panels may produce incorrect exposure.

### ✔ Flash Compensation for Optional Flash Units

In i-TTL and auto aperture (Ⓐ) flash control modes, the flash compensation selected with the optional flash unit or the camera **[Flash control]** item is added to the flash compensation selected with the **[Flash compensation]** item in the photo shooting menu.



---

### **Modeling Illumination**

- Pressing the control to which [**Preview**] has been assigned using Custom Setting f2 [**Custom controls**] causes CLS-compatible flash units to emit a modeling flash.
- This feature can be used with Advanced Wireless Lighting to preview the total lighting effect achieved with multiple flash units.
- The effects of shadows cast by the flash are best observed directly rather than in the shooting display.
- Modeling illumination can be turned off by selecting [**Off**] for Custom Setting e5 [**Modeling flash**].

### **Studio Strobe Lighting**

To adjust the color and brightness of the view through the lens so that shots are easier to frame, select [**Off**] for Custom Setting d7 [**Apply settings to live view**].

---

## Other Compatible Accessories

A variety of accessories are available for your Nikon camera.

### ✔ Compatible Accessories

- Availability may vary with country or region.
- See our website or brochures for the latest information.

### ● Power Sources

- **EN-EL15c Rechargeable Li-ion Battery:** EN-EL15c batteries can be used with Nikon Z 5 digital cameras.
  - EN-EL15b/EN-EL15a/EN-EL15 batteries can also be used. Note, however, that fewer pictures can be taken on a single charge than with the EN-EL15c (□694).
- **MH-25a Battery Charger:** The MH-25a can be used to recharge EN-EL15c batteries.
- **MB-N10 Battery Pack:** A battery pack for Nikon mirrorless cameras. Attached to the camera, it allows the use of two EN-EL15c rechargeable Li-ion batteries as a power source.
  - EN-EL15b/EN-EL15a/EN-EL15 batteries can be used in place of the EN-EL15c. The number of pictures that can be taken on a single charge (i.e., battery endurance) will however drop compared to the EN-EL15c (□694).
  - Batteries inserted in the MB-N10 will charge when an EH-7P charging AC adapter is connected to the MB-N10's charging connector.
  - See the manual supplied with the MB-N10 for information on connection and removal and for instructions on its use and care.

- **EH-7P Charging AC Adapter:** The EH-7P can be used to charge batteries inserted in the camera.
  - The battery will not charge while the camera is on.
  - It cannot be used to charge EN-EL15a/EN-EL15 batteries.
  - The charging AC adapter can be used to power the camera; to do so, select **[Enable]** for **[USB power delivery]** in the setup menu. For more information, see “USB Power Delivery” (□450).
- **EP-5B Power Connector, EH-5d/EH-5c/EH-5b AC Adapter:** Use AC adapters to power the camera for extended periods.
  - The EP-5B is needed to connect the EH-5d/EH-5c/EH-5b to the camera. See “Attaching a Power Connector and AC Adapter” (□657) for details.

### ● Filters

- Neutral Color (NC) filters can be used to protect the lens.
- Filters may cause ghosting when the subject is framed against a bright light, or when a bright light source is in the frame. Filters can be removed if ghosting occurs.
- Matrix metering may not produce the desired results with filters with exposure factors (filter factors) over 1× (Y44, Y48, Y52, O56, R60, X0, X1, C-PL, ND2S, ND4, ND4S, ND8, ND8S, ND400, A2, A12, B2, B8, B12); we suggest that **[Center-weighted metering]** be selected instead. See the filter manual for details.
- Filters intended for special-effects photography may interfere with autofocus or the in-focus indicator (●).

## ● Remote Cords

**MC-DC2 Remote Cord** (length 1 m/3 ft 4 in.): When connected to the camera accessory terminal, the MC-DC2 can be used to release the shutter remotely.

## ● USB Cables

- **UC-E24 USB Cable:** A USB cable with a type C connector for connection to the camera and a type A connector for connection to the USB device.
- **UC-E25 USB Cable:** A USB cable with two type C connectors.

## ● HDMI Cables

**HC-E1 HDMI Cable:** An HDMI cable with a type C connector for connection to the camera and a type A connector for connection to HDMI devices.

## ● Hot Shoe Adapters

**AS-15 Sync Terminal Adapter:** Mount the AS-15 on the camera hot shoe to connect studio strobe lights or other flash equipment via a sync terminal.

## ● Accessory Shoe Covers

**BS-1 Accessory Shoe Cover:** A cover protecting the accessory shoe when no flash unit is attached.

## ● Body Caps

**BF-N1 Body Cap:** The body cap prevents dust entering the camera when no lens is in place.

## ● Viewfinder Eyepiece Accessories

**DK-29 Rubber Eyecup:** A rubber eyecup that can be fitted to the camera viewfinder. The DK-29 makes the image in the viewfinder easier to see, preventing eye fatigue.

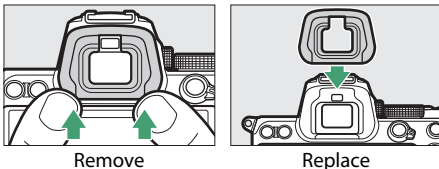

## ● Mount Adapters

**FTZ Mount Adapter:** An adapter that allows NIKKOR F mount lenses to be used with digital cameras that support interchangeable Z mount lenses.

- For information on attaching, removing, maintaining, and using FTZ mount adapters, refer to the mount adapter manual.

## ● Microphones

- **ME-1 Stereo Microphone:** Connect the ME-1 to the camera microphone jack to record stereo sound. Using an external microphone also reduces the chance of picking up equipment noise, such as the sounds produced during movie recording when focus is achieved using autofocus.
- **ME-W1 Wireless Microphone:** A wireless Bluetooth microphone. Use the ME-W1 for off-camera recording.

## ● **Wireless Remote Controllers**

### • **WR-R10 Wireless Remote Controller/WR-T10 Wireless Remote Controller**

- When a WR-R10 wireless remote controller is attached to the accessory terminal, the camera can be controlled wirelessly using a WR-T10 wireless remote controller.
- The WR-R10 can also be used to control radio-controlled flash units.
- For synchronized release involving more than one camera, ready multiple cameras with paired WR-R10 units attached.
- \* When connecting the WR-R10, be sure the cover for the accessory terminal and the USB and HDMI connectors is fully open.

### • **WR-1 Wireless Remote Controller:** WR-1 units are used with WR-R10 or WR-T10 wireless remote controllers or with other WR-1 remote controllers, with the WR-1 units functioning as either transmitters or receivers. When a WR-R10 or a WR-1 configured as a receiver is connected to the camera accessory terminal, a second WR-1 configured as a transmitter can be used to take pictures and adjust camera settings remotely.

- \* Be sure the firmware for the WR-R10 and WR-1 has been updated to the latest versions (WR-R10 firmware version 3.0 or later and WR-1 firmware version 1.0.1 or later). For information on firmware updates, see the Nikon website for your area. Consult a Nikon-authorized service representative when updating the firmware for the WR-R10 from versions prior to version 2.0 to version 3.0 or later.

---

### ✓ Attaching and Removing the Accessory Shoe Cover

The cover slides into the shoe as shown. To remove the cover, hold the camera firmly, press the cover down with a thumb and slide it in the direction shown.

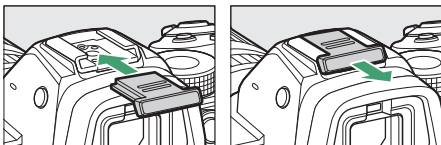

## **Charging AC Adapters**

When a battery is inserted in the camera, the optional EH-7P charging AC adapter can be used to charge the battery or power the camera.

- EN-EL15a or EN-EL15 batteries cannot be charged using a charging AC adapter. Use an MH-25a battery charger instead.
- If [**Enable**] is selected for [**USB power delivery**] in the setup menu, the charging AC adapter can be used to power the camera. The batteries will not charge while the camera is powered by an outside source. For more information, see "'Power Delivery' Versus 'Charging'" (p.451).

---

### **1 Insert the EN-EL15c into the camera (p.36).**

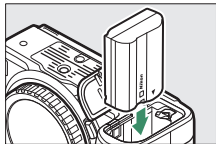



## 2 After confirming that the camera is off, connect the charging AC adapter (①) and plug the adapter in.

Keep the plug straight during insertion and removal.

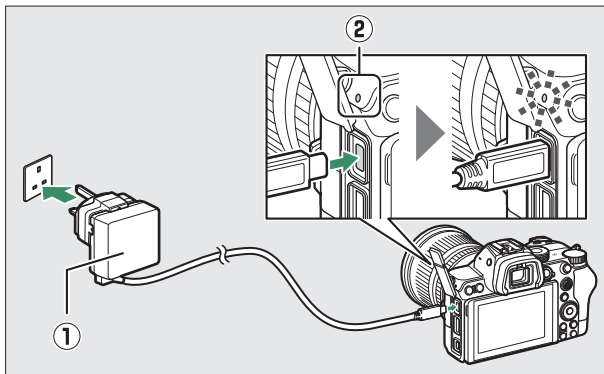

### Charging

- The battery charges while the camera is off.
- The camera charge lamp (②) lights amber while charging is in progress. The lamp turns off when charging is complete.
- An exhausted battery will fully charge in about 2 hours and 45 minutes.

### Power Delivery

The camera will draw power from the adapter while on.

---

### **3 Unplug the charging AC adapter when charging is complete or when it is no longer needed to power the camera.**

---

#### **✔ The Charging AC Adapter**

If the battery cannot be charged using the charging AC adapter, for example because the battery is not compatible or the temperature of the camera is elevated, the charge lamp will flash rapidly for about 30 seconds and then turn off. If the charge lamp is off and you did not observe the battery charging, turn the camera on and check the battery level.

---

#### **✔ Computer USB Power Delivery and Battery Charging**

- Computers will supply current to power the camera or charge the battery only when connected via a UC-E25 USB cable (available separately). The supplied USB cable cannot be used for this purpose.
  - Depending on the model and product specifications, some computers will not supply current to power the camera or charge the battery.
-

## **Attaching a Power Connector and AC Adapter**

Turn the camera off before attaching an optional power connector and AC adapter.

- 1** Open the battery-chamber (①) and power connector (②) covers.

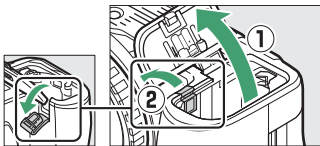

- 2** Insert the EP-5B power connector.

- Be sure to insert the connector in the correct orientation.
- Using the connector to keep the orange battery latch pressed to one side, slide the connector into the battery chamber until the latch locks the connector in place.

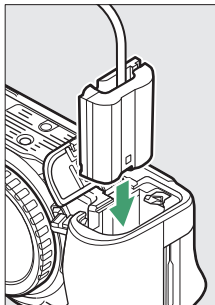

### 3 Close the battery-chamber cover.

Position the power connector cable so that it passes through the power connector slot and close the battery-chamber cover.

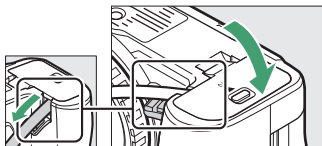

### 4 Connect the EH-5d/EH-5c/EH-5b AC adapter to the EP-5B power connector.

- Connect the AC adapter power cable to the AC socket on the AC adapter (③).
- Insert the DC plug into the DC IN connector (④).
- A  icon is displayed when the camera is powered by the AC adapter and power connector.

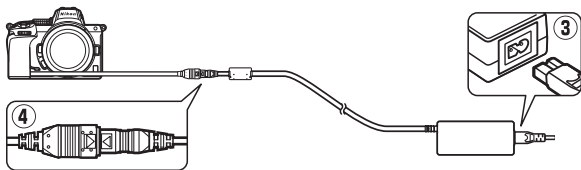

# Software

The following Nikon software can be used with the camera:

## ● Computer Software

Nikon computer software is available from the Nikon Download Center. Check the version and system requirements and be sure to download the latest version.

<https://downloadcenter.nikonimglib.com/>

- **Camera Control Pro 2** (available for purchase): Control the camera remotely from a computer and save photographs directly to the computer hard disk.
- **NX Tether**: Use for tethered photography when the camera is connected to a computer. Exposure, white balance, and other camera settings can be adjusted remotely using controls in the computer display.
- **NX Studio** \*: View and edit photos and videos shot with Nikon digital cameras. NX Studio can be used to fine-tune files in Nikon's unique NEF/NRW (RAW) format and convert them to JPEG or TIFF (NEF/RAW processing). It supports not only NEF/NRW (RAW) pictures but also JPEG and TIFF photos shot with Nikon digital cameras for such tasks as editing tone curves and enhancing brightness and contrast.
  - \* Existing users should be sure to download the latest version, as earlier versions may be unable to download pictures from the camera or open NEF (RAW) pictures.
- **Wireless Transmitter Utility**: The Wireless Transmitter Utility is required if the camera is to be connected to a network. Pair the camera with the computer and download pictures via Wi-Fi.

## ● Smartphone (Tablet) Apps

**SnapBridge:** Download photos and movies from the camera to your smart device via a wireless connection.

- SnapBridge apps can be downloaded from the Apple App Store® or on Google Play™.
- Visit the Nikon website for the latest SnapBridge apps information.

## Caring for the Camera

### **Storage**

When the camera will not be used for an extended period, remove the battery. Before removing the battery, confirm that the camera is off.

Do not store the camera in locations that:

- are poorly ventilated or subject to humidities of over 60%
- are next to equipment that produces strong electromagnetic fields, such as televisions or radios
- are exposed to temperatures above 50 °C (122 °F) or below –10 °C (14 °F)

## **Cleaning**

The procedure varies with the part that requires cleaning. The procedures are detailed below.

- Do not use alcohol, thinner, or other volatile chemicals.

### **■ Camera Body**

Use a blower to remove dust and lint, then wipe gently with a soft, dry cloth. After using the camera at the beach or seaside, wipe off sand or salt with a cloth lightly dampened in distilled water and dry the camera thoroughly.

**Important:** *Dust or other foreign matter inside the camera may cause product malfunction. Damage due to the presence of foreign matter inside the camera is not covered under warranty.*

### **■ Lens and Viewfinder**

These glass elements are easily damaged: remove dust and lint with a blower. If using an aerosol blower, keep the can vertical to prevent the discharge of liquid that could damage glass elements. To remove fingerprints and other stains, apply a small amount of lens cleaner to a soft cloth and clean with care.

### **■ Monitor**

Remove dust and lint with a blower. When removing fingerprints and other stains, wipe the surface lightly with a soft cloth or chamois leather. Do not apply pressure, as this could result in damage or malfunction.



## Image Sensor Cleaning

Dirt or dust entering the camera when lenses are exchanged or the body cap is removed may adhere to the surface of the image sensor and affect your photographs. The “clean image sensor” option vibrates the sensor to remove dust.

The image sensor can be cleaned at any time from the menus, or cleaning can be performed automatically when the camera is turned off. If image sensor cleaning fails to resolve the problem, contact a Nikon-authorized service representative.

### ■ Using the Menus

- For maximum effect, hold the camera in normal orientation (base down).

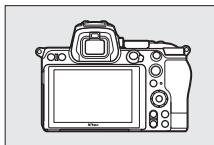

- Select [**Clean image sensor**] in the setup menu, then highlight [**Clean now**] and press **OK** to begin cleaning.
- Camera controls cannot be used while cleaning is in progress. Do not remove or disconnect the power source.
- The setup menu will be displayed when cleaning is complete.

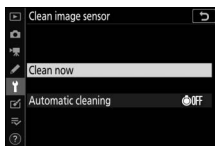

## ■ Cleaning the Image Sensor at Shutdown

Option		Description
●OFF	[Clean at shutdown]	The image sensor is automatically cleaned during shutdown each time the camera is turned off.
[Cleaning off]		Automatic image sensor cleaning off.

### 1 Select [Automatic cleaning] for [Clean image sensor].

Pressing **▶** when [Automatic cleaning] is highlighted displays [Automatic cleaning] options.

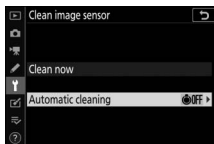

### 2 Highlight an option.

Press **OK** to select the highlighted option.

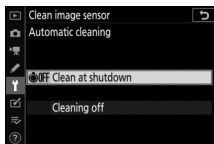

### ✓ Image Sensor Cleaning

- Using camera controls interrupts any image sensor cleaning begun in response to the operation of the power switch.
- If image sensor cleaning is performed several times in succession, image sensor cleaning may be temporarily disabled to protect the camera's internal circuitry. Cleaning can be performed again after a short wait.

## **Manual Cleaning**

If foreign matter cannot be removed from the image sensor using image sensor cleaning, the sensor can be cleaned manually as described below. Note, however, that the sensor is extremely delicate and easily damaged; we recommend that manual cleaning be performed only by a Nikon-authorized service representative.

---

### **1 Turn the camera off and remove the lens.**

---

### **2 Holding the camera so that light can enter the camera, examine the image sensor for dust or lint.**

If no foreign objects are present, proceed to Step 4.

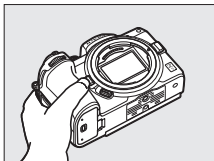

---

### **3 Remove any dust and lint from the sensor with a blower.**

- Do not use a blower-brush. The bristles could damage the sensor.
- Dirt that cannot be removed with a blower can only be removed by Nikon-authorized service personnel. Under no circumstances should you touch or wipe the sensor.

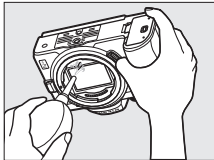

---

### **4 Replace the lens or supplied body cap.**

---

### ✔ Foreign Matter on the Image Sensor

Foreign matter entering the camera when lenses or body caps are removed or exchanged (or in rare circumstances lubricant or fine particles from the camera itself) may adhere to the image sensor, where it may appear in photographs taken under certain conditions. To prevent entry of foreign matter when attaching the body cap or exchanging lenses, avoid dusty environments and be sure to remove all dust and other foreign matter that may be adhering to the camera mount, lens mount, or body cap. To protect the camera when no lens is in place, be sure to replace the supplied body cap. Should you encounter foreign matter that cannot be removed using the image sensor cleaning option (□ 663), clean the image sensor as described in “Manual Cleaning” (□ 665), or have the sensor cleaned by authorized Nikon service personnel. Photographs affected by the presence of foreign matter on the sensor can be retouched using the clean image options available in some imaging applications.

### ✔ Servicing the Camera and Accessories

The camera is a precision device and requires regular servicing; Nikon recommends that the camera be inspected once every one to two years, and that it be serviced once every three to five years (note that fees apply to these services).

- Frequent inspection and servicing are particularly recommended if the camera is used professionally.
  - Any accessories regularly used with the camera, such as lenses or optional flash units, should be included when the camera is inspected or serviced.
-

# Caring for the Camera and Battery: Cautions

## Camera Care

### ● **Do Not Drop**

Do not drop the camera or lens or subject them to blows. The product may malfunction if subjected to strong shocks or vibration.

### ● **Keep Dry**

Keep the camera dry. Rusting of the internal mechanism caused by water inside the camera can not only be expensive to repair but can in fact cause irreparable damage.

### ● **Avoid Sudden Changes in Temperature**

Sudden changes in temperature, such as those that occur when entering or leaving a heated building on a cold day, can cause condensation inside the device. To prevent condensation, place the device in a carrying case or plastic bag before exposing it to sudden changes in temperature.

### ● **Keep Away from Strong Magnetic Fields**

Static charges or the magnetic fields produced by equipment such as radio transmitters could interfere with the monitor, corrupt data stored on the memory card, or affect the product's internal circuitry.

### ● **Do Not Leave the Lens Pointed at the Sun**

Do not leave the lens pointed at the sun or other strong light source for extended periods. Intense light may damage the image sensor or cause fading or "burn in". Photographs taken with the camera may exhibit a white blur effect.

### ● Lasers and Other Bright Light Sources

Do not direct lasers or other extremely bright light sources toward the lens, as this could damage the camera's image sensor.

### ● Cleaning

When cleaning the camera body, use a blower to gently remove dust and lint, then wipe gently with a soft, dry cloth. After using the camera at the beach or seaside, wipe off any sand or salt using a cloth lightly dampened in fresh water and then dry the camera thoroughly.

### ● Cleaning the Lens and Viewfinder

These glass elements are easily damaged: remove dust and lint with a blower. If using an aerosol blower, keep the can vertical to prevent the discharge of liquid that could damage glass elements. To remove fingerprints and other stains from the lens, apply a small amount of lens cleaner to a soft cloth and wipe the lens carefully.

### ● Do Not Touch the Image Sensor

Under no circumstances should you exert pressure on the image sensor, poke it with cleaning tools, or subject it to powerful air currents from a blower. These actions could scratch or otherwise damage the sensor.

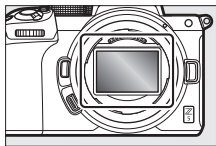

### ● Cleaning the Image Sensor

For information on cleaning the image sensor, see “Image Sensor Cleaning” (□663) and “Manual Cleaning” (□665).

### ● **The Lens Contacts**

Keep the lens contacts clean. Avoid touching them with your fingers.

### ● **Store in a Well-Ventilated Area**

To prevent mold or mildew, store the camera in a dry, well-ventilated area. Do not store the camera with naphtha or camphor moth balls, next to equipment that produces strong electromagnetic, or where it will be exposed to extremely high temperatures, for example near a heater or in an enclosed vehicle on a hot day. Failure to observe these precautions could result in product malfunction.

### ● **Long-Term Storage**

To prevent damage caused by, for example, leaking battery fluid, remove the battery if the product will not be used for an extended period. Store the camera in a plastic bag containing a desiccant. Do not, however, store the leather camera case in a plastic bag, as this may cause the material to deteriorate. Store the battery in a cool, dry place. Note that desiccant gradually loses its capacity to absorb moisture and should be replaced at regular intervals. To prevent mold or mildew, take the camera out of storage at least once a month, insert the battery, and release the shutter a few times.

### ● **Turn the Product Off Before Removing or Disconnecting the Power Source**

Removing or disconnecting the power source while the camera is on could damage the product. Particular care should be taken not to remove or disconnect the power source while images are being recorded or deleted.

## ● **Monitor/Viewfinder**

- The monitors (including viewfinder) are constructed with extremely high precision; at least 99.99% of pixels are effective, with no more than 0.01% being missing or defective. Hence while these displays may contain pixels that are always lit (white, red, blue, or green) or always off (black), this is not a malfunction. Images recorded with the device are unaffected. Your understanding is requested.
- Images in the monitor may be difficult to see in a bright light.
- Do not apply pressure to the monitor. The monitor could malfunction or suffer damage. Dust or lint on the monitor can be removed with a blower. Stains can be removed by wiping the monitor lightly with a soft cloth or chamois leather. Should the monitor break, care should be taken to avoid injury from broken glass. Be careful that liquid crystal from the monitor does not touch the skin or enter the eyes or mouth.
- Should you experience any of the following symptoms while framing shots in the viewfinder, discontinue use until your condition improves:
  - nausea, eye pain, eye fatigue,
  - dizziness, headache, stiffness in your neck or shoulders,
  - queasiness or loss of hand-eye coordination, or
  - motion sickness.
- The display may rapidly flicker on and off during burst photography. Watching the flickering display could cause you to feel unwell. Discontinue use until your condition improves.

## ● **Bright Lights and Back-Lit Subjects**

Noise in the form of lines may in rare cases appear in pictures that include bright lights or back-lit subjects.



## **Battery Care**

### **● Precautions for Use**

- If improperly handled, batteries may rupture or leak, causing the product to corrode. Observe the following precautions when handling batteries:
  - Turn the product off before replacing the battery.
  - Batteries may be hot after extended use.
  - Keep the battery terminals clean.
  - Use only batteries approved for use in this equipment.
  - Do not short or disassemble batteries or expose them to flame or excessive heat.
  - Replace the terminal cover when the battery is not inserted in the camera or charger.
- If the battery is hot, for example immediately after use, wait for it to cool before charging. Attempting to charge the battery while its internal temperature is elevated will impair battery performance, and the battery may not charge or charge only partially.
- If the battery will not be used for some time, insert it in the camera and run it flat before removing it from the camera for storage. The battery should be stored in a cool, dry location with an ambient temperature of 15 °C to 25 °C (59 °F to 77 °F). Avoid hot or extremely cold locations.
- Batteries should be charged within six months of use. During long periods of disuse, charge the battery and use the camera to run it flat once every six months before returning it to a cool location for storage.
- Remove the battery from the camera or charger when not in use. The camera and charger draw minute amounts of charge even when off and could draw the battery down to the point that it will no longer function.

- Do not use the battery at ambient temperatures below 0 °C (32 °F) or above 40 °C (104 °F). Failure to observe this precaution could damage the battery or impair its performance. Charge the battery indoors at ambient temperatures of 5 °C–35 °C (41 °F–95 °F). The battery will not charge if its temperature is below 0 °C (32 °F) or above 60 °C (140 °F).
- Capacity may be reduced and charging times increase at battery temperatures from 0 °C (32 °F) to 15 °C (59 °F) and from 45 °C (113 °F) to 60 °C (140 °F).
- Batteries in general exhibit a drop in capacity at low ambient temperatures. Even fresh batteries charged at temperatures under about 5 °C (41 °F) may show a temporary increase from “0” to “1” in the setup menu [**Battery info**] age display, but the display will return to normal once the battery has been recharged at a temperature of about 20 °C (68 °F) or higher.
- Battery capacity drops at low temperatures. The change in capacity with temperature is reflected in the camera battery-level display. As a result, the battery display may show a drop in capacity as the temperature drops, even if the battery is fully charged.
- Batteries may be hot after use. Observe due caution when removing batteries from the camera.

### ● **Charge Batteries Before Use**

Charge the battery before use. The supplied battery is not fully charged at shipment.

### ● **Ready Spare Batteries**

Before taking photographs, ready a spare battery and keep it fully charged. Depending on your location, it may be difficult to purchase replacement batteries on short notice.

### ● **Have Fully-Charged Spare Batteries Ready on Cold Days**

Partially-charged batteries may not function on cold days. In cold weather, charge one battery before use and keep another in a warm place, ready to be exchanged as necessary. Once warmed, a cold battery may recover some of its charge.

### ● **Battery Level**

- Turning the camera on or off repeatedly when the battery is fully discharged will shorten battery life. Batteries that have been fully discharged must be charged before use.
- A marked drop in the time a fully charged battery retains its charge when used at room temperature indicates that it requires replacement. Purchase a new rechargeable battery.

### ● **Do Not Attempt to Charge Fully-Charged Batteries**

Continuing to charge the battery after it is fully charged can impair battery performance.

### ● **Recycling Used Batteries**

Recycle rechargeable batteries in accord with local regulations, being sure to first insulate the terminals with tape.

## **Using the Charger**

- Do not move the charger or touch the battery during charging; failure to observe this precaution could in very rare instances result in the charger showing that charging is complete when the battery is only partially charged. Remove and reinsert the battery to begin charging again.
- Do not short the charger terminals. Failure to observe this precaution could result in overheating and damage to the charger.
- Unplug the charger when it is not in use.
- Use the MH-25a with compatible batteries only.
- Do not use chargers with damage that leaves the interior exposed or that produce unusual sounds when used.

## **Using the Charging AC Adapter**

- Do not move the camera or touch the battery during charging. Failure to observe this precaution could in very rare instances result in the camera showing that charging is complete when the battery is only partially charged. Disconnect and reconnect the adapter to begin charging again.
- Do not short the adapter terminals. Failure to observe this precaution could result in overheating and damage to the charger.
- Unplug the adapter when it is not in use.
- Do not use adapters with damage that leaves the interior exposed or that produce unusual sounds when used.

# Specifications

## Nikon Z 5 Digital Camera

Type	
Type	Digital camera with support for interchangeable lenses
Lens mount	Nikon Z mount
Lens	
Compatible lenses	<ul style="list-style-type: none"><li>• Z mount NIKKOR lenses</li><li>• F mount NIKKOR lenses (mount adapter required; restrictions may apply)</li></ul>
Effective pixels	
Effective pixels	24.3 million
Image sensor	
Type	35.9 × 23.9 mm CMOS sensor (Nikon FX format)
Total pixels	24.93 million
Dust-reduction system	Image sensor cleaning, Image Dust Off reference data (requires NX Studio)

## Storage

<b>Image size (pixels)</b>	<ul style="list-style-type: none"><li>• <b>[FX (36 × 24)] selected for image area:</b><ul style="list-style-type: none"><li>- 6016 × 4016 (Large: 24.2 M)</li><li>- 4512 × 3008 (Medium: 13.6 M)</li><li>- 3008 × 2008 (Small: 6.0 M)</li></ul></li><li>• <b>[DX (24 × 16)] selected for image area:</b><ul style="list-style-type: none"><li>- 3936 × 2624 (Large: 10.3 M)</li><li>- 2944 × 1968 (Medium: 5.8 M)</li><li>- 1968 × 1312 (Small: 2.6 M)</li></ul></li><li>• <b>[1:1 (24 × 24)] selected for image area:</b><ul style="list-style-type: none"><li>- 4016 × 4016 (Large: 16.1 M)</li><li>- 3008 × 3008 (Medium: 9.0 M)</li><li>- 2000 × 2000 (Small: 4.0 M)</li></ul></li><li>• <b>[16:9 (36 × 20)] selected for image area:</b><ul style="list-style-type: none"><li>- 6016 × 3384 (Large: 20.4 M)</li><li>- 4512 × 2536 (Medium: 11.4 M)</li><li>- 3008 × 1688 (Small: 5.1 M)</li></ul></li><li>• <b>Photographs taken while filming movies at a frame size of 3840 × 2160:</b> 3840 × 2160</li><li>• <b>Photographs taken while filming movies at other frame sizes:</b> 1920 × 1080</li></ul>
<b>File format (image quality)</b>	<ul style="list-style-type: none"><li>• <b>NEF (RAW):</b> 12 or 14 bit (lossless compressed or compressed)</li><li>• <b>JPEG:</b> JPEG-Baseline compliant with fine (approx. 1:4), normal (approx. 1:8), or basic (approx. 1:16) compression; size-priority and optimal-quality compression available</li><li>• <b>NEF (RAW)+JPEG:</b> Single photograph recorded in both NEF (RAW) and JPEG formats</li></ul>

Storage	
<b>Picture Control System</b>	Auto, Standard, Neutral, Vivid, Monochrome, Portrait, Landscape, Flat, Creative Picture Controls (Dream, Morning, Pop, Sunday, Somber, Dramatic, Silence, Bleached, Melancholic, Pure, Denim, Toy, Sepia, Blue, Red, Pink, Charcoal, Graphite, Binary, Carbon); selected Picture Control can be modified; storage for custom Picture Controls
<b>Media</b>	SD (Secure Digital) and UHS-II compliant SDHC and SDXC memory cards
<b>Double card slots</b>	The card in Slot 2 can be used for overflow or backup storage or for separate storage of NEF (RAW) and JPEG images; pictures can be copied between cards.
<b>File system</b>	DCF 2.0, Exif 2.31
Viewfinder	
<b>Viewfinder</b>	1.27-cm/0.5-in. approx. 3690k-dot (Quad VGA) OLED electronic viewfinder with color balance and auto and 11-level manual brightness controls
<b>Frame coverage</b>	Approx. 100% horizontal and 100% vertical
<b>Magnification</b>	Approx. 0.8× (50 mm lens at infinity, $-1.0 \text{ m}^{-1}$ )
<b>Eyepoint</b>	21 mm ( $-1.0 \text{ m}^{-1}$ ; from center surface of viewfinder eyepiece lens)
<b>Diopter adjustment</b>	$-4 - +2 \text{ m}^{-1}$
<b>Eye sensor</b>	Automatically switches between monitor and viewfinder displays

Monitor	
<b>Monitor</b>	8-cm/3.2-in., approx. 1040k-dot tilting TFT touch-sensitive LCD with 170° viewing angle, approximately 100% frame coverage, and color balance and 11-level manual brightness controls
Shutter	
<b>Type</b>	Electronically-controlled vertical-travel focal-plane mechanical shutter; electronic front-curtain shutter; electronic shutter
<b>Speed</b>	$1/8000 - 30$ s (choose from step sizes of $1/3$ and $1/2$ EV), bulb, time, X200
<b>Flash sync speed</b>	$X=1/200$ s; synchronizes with shutter at $1/200$ s or slower; auto FP high-speed sync supported
Release	
<b>Release mode</b>	Single frame, Continuous L, Continuous H, Self-timer
<b>Approximate frame advance rate</b>	<ul style="list-style-type: none"> <li>• <b>Continuous L:</b> Approx. 1 – 4 fps</li> <li>• <b>Continuous H:</b> Approx. 4.5 fps</li> </ul> * Maximum frame advance rate as measured by in-house tests.
<b>Self-timer</b>	2 s, 5 s, 10 s, 20 s; 1–9 exposures at intervals of 0.5, 1, 2, or 3 s



Exposure	
<b>Metering system</b>	TTL metering using camera image sensor
<b>Metering mode</b>	<ul style="list-style-type: none"> <li>• <b>Matrix metering</b></li> <li>• <b>Center-weighted metering:</b> Weight of 75% given to 12 mm circle in center of frame; weighting can instead be based on average of entire frame</li> <li>• <b>Spot metering:</b> Meters 4 mm circle (about 1.5% of frame) centered on selected focus point</li> <li>• <b>Highlight-weighted metering</b></li> </ul>
<b>Range</b>	<p>–3 – +17 EV</p> <p>* Figures are for ISO 100 and f/2.0 lens at 20 °C/68 °F</p>
<b>Mode</b>	<ul style="list-style-type: none"> <li>• : Auto, <b>P</b>: programmed auto with flexible program, <b>S</b>: shutter-priority auto, <b>A</b>: aperture-priority auto, <b>M</b>: manual</li> <li>• <b>U1, U2 and U3:</b> user settings modes</li> </ul>
<b>Exposure compensation</b>	–5 – +5 EV (choose from step sizes of 1/3 and 1/2 EV) available in modes <b>P, S, A,</b> and <b>M</b>
<b>Exposure lock</b>	Luminosity locked at detected value
<b>ISO sensitivity (Recommended Exposure Index)</b>	ISO 100–51200 (choose from step sizes of 1/3 and 1/2 EV); can also be set to approx. 0.3, 0.5, 0.7, or 1 EV (ISO 50 equivalent) below ISO 100 or to approx. 0.3, 0.5, 0.7, or 1 EV (ISO 102400 equivalent) above ISO 51200; auto ISO sensitivity control available
<b>Active D-Lighting</b>	Auto, Extra high, High, Normal, Low, and Off

Exposure	
<b>Multiple exposure</b>	Add, average, lighten, darken
<b>Other options</b>	HDR (high dynamic range), photo mode flicker reduction
Autofocus	
<b>Type</b>	Hybrid phase-detection/contrast AF with AF assist
<b>Detection range</b>	-3 – +19 EV * Without low-light AF: -2 – +19 EV * Measured in photo mode at ISO 100 and a temperature of 20 °C/68 °F using single-servo AF ( <b>AF-S</b> ) and a lens with a maximum aperture of f/2.0
<b>Lens servo</b>	<ul style="list-style-type: none"> <li>• <b>Autofocus (AF)</b>: Single-servo AF (<b>AF-S</b>); continuous-servo AF (<b>AF-C</b>); full-time AF (<b>AF-F</b>; available only in movie mode); predictive focus tracking</li> <li>• <b>Manual focus (M)</b>: Electronic rangefinder can be used</li> </ul>
<b>Focus points</b>	273 focus points * Number of focus points available in photo mode with single-point AF selected for AF-area mode and FX selected for image area
<b>AF-area mode</b>	Pinpoint (available in photo mode only), single-point, and dynamic-area AF (available in photo mode only); wide-area AF (S); wide-area AF (L); auto-area AF
<b>Focus lock</b>	Focus can be locked by pressing shutter-release button halfway (single-servo AF/ <b>AF-S</b> ) or by pressing the center of the sub-selector

**Vibration reduction (VR)**

<b>Camera on-board VR</b>	5-axis image sensor shift
<b>Lens on-board VR</b>	Lens shift (available with VR lenses)

**Flash**

<b>Flash control</b>	<b>TTL:</b> i-TTL flash control; i-TTL balanced fill-flash is used with matrix, center-weighted, and highlight-weighted metering, standard i-TTL fill-flash with spot metering
<b>Flash mode</b>	Front-curtain sync, slow sync, rear-curtain sync, red-eye reduction, red-eye reduction with slow sync, off
<b>Flash compensation</b>	-3 – +1 EV (choose from step sizes of $\frac{1}{3}$ and $\frac{1}{2}$ EV) available in modes <b>P</b> , <b>S</b> , <b>A</b> , and <b>M</b>
<b>Flash-ready indicator</b>	Lights when optional flash unit is fully charged; flashes as underexposure warning after flash is fired at full output
<b>Accessory shoe</b>	ISO 518 hot-shoe with sync and data contacts and safety lock
<b>Nikon Creative Lighting System (CLS)</b>	i-TTL flash control, radio-controlled Advanced Wireless Lighting, optical Advanced Wireless Lighting, modeling illumination, FV lock, Color Information Communication, auto FP high-speed sync, unified flash control

**White balance**

<b>White balance</b>	Auto (3 types), natural light auto, direct sunlight, cloudy, shade, incandescent, fluorescent (7 types), flash, choose color temperature (2500 K–10,000 K), preset manual (up to 6 values can be stored), all with fine-tuning except choose color temperature
----------------------	--

<b>Bracketing</b>	
<b>Bracketing</b>	Exposure and/or flash, white balance, and ADL
<b>Movie</b>	
<b>Metering system</b>	TTL metering using camera image sensor
<b>Metering mode</b>	Matrix, center-weighted, or highlight-weighted
<b>Frame size (pixels) and frame rate</b>	<ul style="list-style-type: none"> <li>• 3840 × 2160 (4K UHD): 30p (progressive)/25p/24p</li> <li>• 1920 × 1080: 60p/50p/30p/25p/24p</li> <li>* Actual frame rates for 60p, 50p, 30p, 25p, and 24p are 59.94, 50, 29.97, 25, and 23.976 fps respectively</li> <li>* Quality selection (normal/★) available at all sizes except 3840 × 2160, when quality is fixed at ★</li> </ul>
<b>File format</b>	MOV, MP4
<b>Video compression</b>	H.264/MPEG-4 Advanced Video Coding
<b>Audio recording format</b>	Linear PCM (for movies recorded in MOV format) or AAC (for movies recorded in MP4 format)
<b>Audio recording device</b>	Built-in stereo or external microphone with attenuator option; sensitivity adjustable
<b>Exposure compensation</b>	-3 – +3 EV (choose from step sizes of $\frac{1}{3}$ and $\frac{1}{2}$ EV) available in modes <b>P</b> , <b>S</b> , <b>A</b> , and <b>M</b>

Movie	
<b>ISO sensitivity (Recommended Exposure Index)</b>	<ul style="list-style-type: none"> <li>• <b>M</b>: Manual selection (ISO 100–25600; choose from step sizes of <math>\frac{1}{3}</math> and <math>\frac{1}{2}</math> EV); auto ISO sensitivity control (ISO 100–25600) available with selectable upper limit</li> <li>• <b>P, S, A</b>: Auto ISO sensitivity control (ISO 100–25600) with selectable upper limit</li> <li>• : Auto ISO sensitivity control (ISO 100–25600)</li> </ul>
<b>Active D-Lighting</b>	Same as photo settings, Extra high, High, Normal, Low, and Off
<b>Other options</b>	Time-lapse movie recording, electronic vibration reduction, time codes

Playback	
<b>Playback</b>	Full-frame and thumbnail (4, 9, or 72 images or calendar) playback with playback zoom, playback zoom cropping, movie playback, photo and/or movie slide shows, histogram display, highlights, photo information, location data display, auto image rotation, and picture rating

Interface	
<b>USB</b>	Type C USB connector (SuperSpeed USB); connection to built-in USB port is recommended
<b>HDMI output</b>	Type C HDMI connector
<b>Accessory terminal</b>	Built-in (can be used with MC-DC2 remote cords and other optional accessories)
<b>Audio input</b>	Stereo mini-pin jack (3.5 mm diameter; plug-in power supported)
<b>Audio output</b>	Stereo mini-pin jack (3.5 mm diameter)

## Wi-Fi/Bluetooth

<b>Wi-Fi</b>	<ul style="list-style-type: none"><li>• <b>Standards:</b><ul style="list-style-type: none"><li>- IEEE 802.11b/g/n (Africa, Asia, Bolivia, Europe, and Oceania)</li><li>- IEEE 802.11b/g/n/a/ac (U.S.A., Canada, Mexico)</li><li>- IEEE 802.11b/g/n/a (other countries in the Americas)</li></ul></li><li>• <b>Operating frequency:</b><ul style="list-style-type: none"><li>- 2412–2462 MHz (channel 11; Africa, Asia, Bolivia, Europe, and Oceania)</li><li>- 2412–2462 MHz (channel 11) and 5180–5825 MHz (U.S.A., Canada, Mexico)</li><li>- 2412–2462 MHz (channel 11) and 5180–5805 MHz (other countries in the Americas)</li></ul></li><li>• <b>Maximum output power (EIRP):</b><ul style="list-style-type: none"><li>- 0.7 dBm (2.4 GHz)</li><li>- 6.2 dBm (5 GHz)</li></ul></li><li>• <b>Authentication:</b> Open system, WPA2-PSK</li></ul>
<b>Bluetooth</b>	<ul style="list-style-type: none"><li>• <b>Communication protocols:</b> Bluetooth Specification Version 4.2</li><li>• <b>Operating frequency:</b><ul style="list-style-type: none"><li>- Bluetooth: 2402–2480 MHz</li><li>- Bluetooth Low Energy: 2402–2480 MHz</li></ul></li><li>• <b>Maximum output power (EIRP):</b><ul style="list-style-type: none"><li>- Bluetooth: –4.8 dBm</li><li>- Bluetooth Low Energy: –6.3 dBm</li></ul></li></ul>
<b>Range (line of sight)</b>	Approximately 10 m (32 ft)* * Without interference. Range may vary with signal strength and presence or absence of obstacles.

<b>Power source</b>	
<b>Battery</b>	One EN-EL15c rechargeable Li-ion battery* * EN-EL15b/EN-EL15a/EN-EL15 batteries can also be used. Note, however, that fewer pictures can be taken on a single charge than with the EN-EL15c (□694). The EH-7P charging AC adapter can be used to charge EN-EL15c/EN-EL15b batteries only.
<b>Battery pack</b>	MB-N10 battery pack (available separately); takes two EN-EL15c* batteries * EN-EL15b/EN-EL15a/EN-EL15 batteries can be used in place of the EN-EL15c. The number of pictures that can be taken on a single charge (i.e., battery endurance) will however drop compared to the EN-EL15c (□694).
<b>Charging AC adapter</b>	EH-7P charging AC adapter (available separately)
<b>AC adapter</b>	EH-5d/EH-5c/EH-5b AC adapter; requires EP-5B power connector (available separately)
<b>Tripod socket</b>	
<b>Tripod socket</b>	1/4 in. (ISO 1222)
<b>Dimensions/weight</b>	
<b>Dimensions</b>	Approx. 134 × 100.5 × 69.5 mm/5.3 × 4.0 × 2.8 in. (width × height × depth)
<b>Weight</b>	Approx. 675 g (1 lb. 7.9 oz.) with battery and memory card but without body cap; approx. 590 g/1 lb. 4.9 oz. (camera body only)

## Operating environment

<b>Temperature</b>	0 °C–40 °C (+32 °F–104 °F)
<b>Humidity</b>	85% or less (no condensation)

- Unless otherwise stated, all measurements are performed in conformity with Camera and Imaging Products Association (CIPA) standards or guidelines.
- All figures are for a camera with a fully-charged battery.
- The sample images displayed on the camera and the images and illustrations in the manuals are for expository purposes only.
- Nikon reserves the right to change the appearance and specifications of the hardware and software described in this manual at any time and without prior notice. Nikon will not be held liable for damages that may result from any mistakes that this manual may contain.



## ■ MH-25a Battery Charger

<b>Rated input</b>	AC 100 to 240 V, 50/60 Hz, 0.23–0.12 A
<b>Rated output</b>	DC 8.4 V/1.2 A
<b>Supported batteries</b>	EN-EL15c/EN-EL15b/EN-EL15a/EN-EL15 Rechargeable Li-ion Battery
<b>Charging time</b>	Approx. 2 hours 35 minutes * Time required to charge battery at an ambient temperature of 25 °C (77 °F) when no charge remains
<b>Operating temperature</b>	0 °C–40 °C (+32 °F–104 °F)
<b>Dimensions</b>	Approx. 95 × 33.5 × 71 mm/3.7 × 1.3 × 2.8 in. (width × height × depth), excluding projections
<b>Length of power cable</b>	Approx. 1.5 m (4.9 ft), if supplied
<b>Weight</b>	Approx. 115 g (4.1 oz), excluding supplied power connector (power cable or AC wall adapter)

The symbols on this product represent the following:

~ AC, — DC, □ Class II equipment (the construction of the product is double-insulated)

## ■ EN-EL15c Rechargeable Li-ion Battery

<b>Type</b>	Rechargeable lithium-ion battery
<b>Rated capacity</b>	7.0 V/2280 mAh
<b>Operating temperature</b>	0 °C–40 °C (+32 °F–104 °F)
<b>Dimensions</b>	Approx. 40 × 56 × 20.5 mm/1.6 × 2.2 × 0.8 in. (width × height × depth)
<b>Weight</b>	Approx. 80 g (2.9 oz), excluding terminal cover

---

## ✔ **Disposing of Data Storage Devices**

Please note that deleting images or formatting memory cards or other data storage devices does not completely erase the original image data. Deleted files can sometimes be recovered from discarded storage devices using commercially available software, potentially resulting in the malicious use of personal image data. Ensuring the privacy of such data is the user's responsibility.

Before discarding a data storage device or transferring ownership to another person, erase all data using commercial deletion software, or format the device and then completely refill it with images containing no private information (for example, pictures of empty sky). Care should be taken to avoid injury when physically destroying data storage devices. Before discarding the camera or transferring ownership to another person, you should also use the **[Reset all settings]** item in the camera setup menu to delete network settings and other personal information.

## ✔ Supported Standards

- **DCF Version 2.0:** The Design Rule for Camera File System (DCF) is a standard widely used in the digital camera industry to ensure compatibility among different makes of camera.
  - **Exif version 2.31:** The camera supports Exif (Exchangeable Image File Format for Digital Still Cameras) version 2.31, a standard introduced with the goal of improving the interoperability of printers and digital cameras, making it easier to produce high-quality prints. Information stored with photographs is used for optimal color reproduction when the images are output on Exif-compliant printers. See the printer manual for details.
  - **HDMI:** High-Definition Multimedia Interface is a standard for multimedia interfaces used in consumer electronics and AV devices. This standard ensures that audiovisual data and control signals can be transmitted to HDMI-compliant devices via a single cable connection.
-

## Approved Memory Cards

- The camera can be used with SD, SDHC, and SDXC memory cards.
- UHS-I and UHS-II are supported.
- Cards rated UHS Speed Class 3 or better are recommended for movie recording and playback. Slower speeds may result in recording or playback being interrupted.
- When choosing cards for use in card readers, be sure they are compatible with the device.
- Contact the manufacturer for information on features, operation, and limitations on use.



## Portable Chargers (Power Banks)

Portable chargers can be used to power the camera or charge the camera battery. The following table lists the portable chargers that have been tested and approved for use, together with the approximate number of shots that can be taken with, and the approximate number of times the camera battery can be charged using, each device.

Manufacturer	Model number	Number of shots <sup>1</sup>	Number of charges <sup>2</sup>
Anker	PowerCore+ 26800 PD 45W	2120	3

- 1 Camera and Imaging Products Association (CIPA) standard. [**Viewfinder only**] selected for monitor mode. Measured at 23 °C/ 73.4 °F (±2 °C/3.6 °F) with a NIKKOR Z 24–70mm f/4 S lens under the following test conditions: one photograph taken at default settings once every 30 s. The “number of shots” is the number of shots that can be taken using a fully-charged portable charger to supply power to a camera with a fully-charged battery (EN-EL15c).
  - 2 The number of times the camera battery (EN-EL15c) can be fully charged using a portable charger at full charge.
- The only batteries that can be charged from portable chargers are the EN-EL15c and EN-EL15b.
  - See the documentation provided with the portable charger for information on use.
  - Use a USB cable with two Type-C connectors supplied with the portable charger when employing the device to power the camera or charge the camera battery.
  - Up-to-date information on portable chargers is available on the website of the manufacturers. Availability may vary with country or region.

## Memory Card Capacity

The following table shows buffer capacity and the approximate number of pictures that can be stored on a 32 GB<sup>1</sup> card at different image qualities and sizes when **[FX (36 × 24)]** is selected for **[Choose image area]**. Actual capacity varies with shooting conditions and the type of card.

Image quality	Image size	File size	Number of exposures remaining <sup>2</sup>	Buffer capacity <sup>2, 3</sup>
<b>NEF (RAW), Lossless compressed, 12-bit</b>	—	Approx. 21.9 MB	757 frames	100 frames
<b>NEF (RAW), Lossless compressed, 14-bit</b>	—	Approx. 27.8 MB	662 frames	100 frames
<b>NEF (RAW), Compressed, 12-bit</b>	—	Approx. 19.5 MB	1000 frames	100 frames
<b>NEF (RAW), Compressed, 14-bit</b>	—	Approx. 24.0 MB	856 frames	100 frames
<b>JPEG fine<sup>4</sup></b>	Large	Approx. 10.2 MB	1800 frames	100 frames
	Medium	Approx. 7.1 MB	3000 frames	100 frames
	Small	Approx. 4.1 MB	5800 frames	100 frames

Image quality	Image size	File size	Number of exposures remaining <sup>2</sup>	Buffer capacity <sup>2, 3</sup>
JPEG normal <sup>4</sup>	Large	Approx. 6.5 MB	3600 frames	100 frames
	Medium	Approx. 4.0 MB	6000 frames	100 frames
	Small	Approx. 2.2 MB	11,100 frames	100 frames
JPEG basic <sup>4</sup>	Large	Approx. 2.5 MB	7000 frames	100 frames
	Medium	Approx. 1.8 MB	11,500 frames	100 frames
	Small	Approx. 1.2 MB	20,300 frames	100 frames

- 1 Figures are for a 32 GB SanDisk SD UHS-II memory card (SDSDXPK-032G-JNJIP – 32GB, measured in January 2020).
- 2 Number of pictures that can be saved to memory card or stored in memory buffer varies with scene recorded.
- 3 Maximum number of exposures that can be stored in memory buffer at ISO 100. May drop in some situations, including when:
  - An optimal-compression ([★]) JPEG option is selected for [Image quality]
  - [On] is selected for [Auto distortion control]
- 4 Figures assume a size-priority option (an option not marked with [★]) is selected for [Image quality]. Selecting an optimal-compression ([★]) option increases file size; the number of images and buffer capacity drop accordingly.

## Battery Endurance

The movie footage or number of shots that can be recorded with a fully-charged EN-EL15c rechargeable Li-ion battery <sup>1</sup> is given below. Actual endurance varies with such factors as the condition of the battery, the interval between shots, and the options selected in the camera menus.

### **Photo Mode: Number of Shots** <sup>2</sup>

- **[Viewfinder only]** selected for monitor mode: Approx. 390 shots
- **[Monitor only]** selected for monitor mode: Approx. 470 shots

### **Movie Mode: Length of Footage** <sup>3</sup>

- **[Viewfinder only]** selected for monitor mode: Approx. 115 minutes
- **[Monitor only]** selected for monitor mode: Approx. 120 minutes

Actions such as the following can reduce battery endurance:

- Keeping the shutter-release button pressed halfway
- Repeated autofocus operations
- Taking NEF (RAW) photographs
- Slow shutter speeds
- Using camera Wi-Fi (wireless LAN) and Bluetooth features
- Using the camera with optional accessories connected
- Repeatedly zooming in and out
- Taking pictures at low ambient temperatures



To ensure that you get the most from rechargeable Nikon EN-EL15c batteries:

- Keep the battery contacts clean. Soiled contacts can reduce battery performance.
  - Use batteries immediately after charging. Batteries will lose their charge if left unused.
- 1 EN-EL15b/EN-EL15a/EN-EL15 batteries can also be used. Note, however, that fewer pictures can be taken on a single charge than with the EN-EL15c.
  - 2 Camera and Imaging Products Association (CIPA) standard. Measured at 23 °C/73.4 °F ( $\pm 2$  °C/3.6 °F) with a NIKKOR Z 24–70mm f/4 S lens under the following test conditions: one photograph taken at default settings once every 30 s.
  - 3 Actual battery endurance as measured under conditions specified by CIPA. Measured at 23 °C/73.4 °F ( $\pm 2$  °C/3.6 °F) with a NIKKOR Z 24–70mm f/4 S lens. Measurement performed at default settings.
    - Each shot can be up to 29 minutes 59 seconds in length.
    - If camera temperature rises, recording may end before maximum length or size is reached.

## AF-Assist Illumination

The AF-assist illuminator has a range of about 1.0–3.0 m (3 ft 4 in.–9 ft 10 in.). Some lenses may block the illuminator at certain focus distances.

- Remove lens hoods when using the illuminator.
- The following lenses interfere with AF-assist illumination:

### Lenses that limit the range at which AF-assist illumination can be used for autofocus

NIKKOR Z 24–70mm f/2.8 S	AF-assist illumination cannot be used for autofocus at distances under 1.5 m (4 ft 12 in.)
NIKKOR Z 70–200mm f/2.8 VR S	AF-assist illumination cannot be used for autofocus at distances under 2.0 m (6 ft 7 in.)

## Trademarks and Licenses

- The SD, SDHC, and SDXC logos are trademarks of SD-3C, LLC.
- Windows is either a registered trademark or a trademark of Microsoft Corporation in the United States and/or other countries.
- Apple®, App Store®, the Apple logos, iPhone®, iPad®, Mac, and macOS are trademarks of Apple Inc. registered in the U.S. and/or other countries.
- Android, Google Play and the Google Play logo are trademarks of Google LLC. The Android robot is reproduced or modified from work created and shared by Google and used according to terms described in the Creative Commons 3.0 Attribution License.
- IOS is a trademark or registered trademark of Cisco Systems, Inc., in the United States and/or other countries and is used under license.
- HDMI, the HDMI logo and High-Definition Multimedia Interface are trademarks or registered trademarks of HDMI Licensing, LLC.

**HDMI**

- The Bluetooth® word mark and logo are registered trademarks owned by Bluetooth SIG, Inc., and any use of such marks by Nikon is under license.
- Wi-Fi and the Wi-Fi logo are trademarks or registered trademarks of the Wi-Fi Alliance.
- All other trade names mentioned in this manual or the other documentation provided with your Nikon product are trademarks or registered trademarks of their respective holders.

---

Use of the Made for Apple badge means that an accessory has been designed to connect specifically to the Apple products identified in the badge, and has been certified by the developer to meet Apple performance standards. Apple is not responsible for the operation of this device or its compliance with safety and regulatory standards. Please note that the use of this accessory with an Apple product may affect wireless performance.

---

#### ✔ **FreeType License (FreeType2)**

Portions of this software are copyright © 2012 The FreeType Project (<https://www.freetype.org>). All rights reserved.

#### ✔ **MIT License (HarfBuzz)**

Portions of this software are copyright © 2018 The HarfBuzz Project (<https://www.freedesktop.org/wiki/Software/HarfBuzz>). All rights reserved.

## **✓ Unicode® Character Database License (Unicode® Character Database)**

The software for this product uses the Unicode® Character Database License open-source software. The terms of the software license are as follows:

### **COPYRIGHT AND PERMISSION NOTICE**

Copyright © 1991-2019 Unicode, Inc. All rights reserved.

Distributed under the Terms of Use in

<https://www.unicode.org/copyright.html>.

Permission is hereby granted, free of charge, to any person obtaining a copy of the Unicode data files and any associated documentation (the "Data Files") or Unicode software and any associated documentation (the "Software") to deal in the Data Files or Software without restriction, including without limitation the rights to use, copy, modify, merge, publish, distribute, and/or sell copies of the Data Files or Software, and to permit persons to whom the Data Files or Software are furnished to do so, provided that either

- (i) this copyright and permission notice appear with all copies of the Data Files or Software, or
- (ii) this copyright and permission notice appear in associated Documentation.

THE DATA FILES AND SOFTWARE ARE PROVIDED "AS IS", WITHOUT WARRANTY OF ANY KIND, EXPRESS OR IMPLIED, INCLUDING BUT NOT LIMITED TO THE WARRANTIES OF MERCHANTABILITY, FITNESS FOR A PARTICULAR PURPOSE AND NON-INFRINGEMENT OF THIRD PARTY RIGHTS. IN NO EVENT SHALL THE COPYRIGHT HOLDER OR HOLDERS INCLUDED IN THIS NOTICE BE LIABLE FOR ANY CLAIM, OR ANY SPECIAL INDIRECT OR CONSEQUENTIAL DAMAGES, OR ANY DAMAGES WHATSOEVER RESULTING FROM LOSS OF USE, DATA OR PROFITS, WHETHER IN AN ACTION OF CONTRACT, NEGLIGENCE OR OTHER TORTIOUS ACTION, ARISING OUT OF OR IN CONNECTION WITH THE USE OR PERFORMANCE OF THE DATA FILES OR SOFTWARE.

Except as contained in this notice, the name of a copyright holder shall not be used in advertising or otherwise to promote the sale, use or other dealings in these Data Files or Software without prior written authorization of the copyright holder.

#### **AVC Patent Portfolio License**

THIS PRODUCT IS LICENSED UNDER THE AVC PATENT PORTFOLIO LICENSE FOR THE PERSONAL AND NON-COMMERCIAL USE OF A CONSUMER TO (i) ENCODE VIDEO IN COMPLIANCE WITH THE AVC STANDARD ("AVC VIDEO") AND/OR (ii) DECODE AVC VIDEO THAT WAS ENCODED BY A CONSUMER ENGAGED IN A PERSONAL AND NON-COMMERCIAL ACTIVITY AND/OR WAS OBTAINED FROM A VIDEO PROVIDER LICENSED TO PROVIDE AVC VIDEO. NO LICENSE IS GRANTED OR SHALL BE IMPLIED FOR ANY OTHER USE. ADDITIONAL INFORMATION MAY BE OBTAINED FROM MPEG LA, L.L.C. SEE <https://www.mpegla.com>

---

# Notices

## Notices for Customers in the U.S.A.

### The Battery Charger

## IMPORTANT SAFETY INSTRUCTIONS—SAVE THESE INSTRUCTIONS

## DANGER—TO REDUCE THE RISK OF FIRE OR ELECTRIC SHOCK, CAREFULLY FOLLOW THESE INSTRUCTIONS

For connection to a supply not in the U.S.A., use an attachment plug adapter of the proper configuration for the power outlet if needed. This power unit is intended to be correctly oriented in a vertical or floor mount position.

### Federal Communications Commission (FCC) Radio Frequency Interference Statement

This equipment has been tested and found to comply with the limits for a Class B digital device, pursuant to Part 15 of the FCC rules. These limits are designed to provide reasonable protection against harmful interference in a residential installation. This equipment generates, uses, and can radiate radio frequency energy and, if not installed and used in accordance with the instructions, may cause harmful interference to radio communications. However, there is no guarantee that interference will not occur in a particular installation. If this equipment does cause harmful interference to radio or television reception, which can be determined by turning the equipment off and on, the user is encouraged to try to correct the interference by one or more of the following measures:

- Reorient or relocate the receiving antenna.
- Increase the separation between the equipment and receiver.
- Connect the equipment into an outlet on a circuit different from that to which the receiver is connected.
- Consult the dealer or an experienced radio/television technician for help.



**Nikon**  
Z 5

#### CAUTIONS

##### *Modifications*

The FCC requires the user to be notified that any changes or modifications made to this device that are not expressly approved by Nikon Corporation may void the user's authority to operate the equipment.

##### *Interface Cables*

Use the interface cables sold or provided by Nikon for your equipment. Using other interface cables may exceed the limits of Class B Part 15 of the FCC rules.

Nikon Inc., 1300 Walt Whitman Road, Melville, New York 11747-3064, U.S.A.  
Tel.: 631-547-4200

## Power Cable

**At voltages over AC 125 V (U.S.A. only):** The power cable must be rated for the voltage in use, be at least AWG no. 18 gauge, and have SVG insulation or better with a NEMA 6P-15 plug rated for AC 250 V 15 A.

## Notice for Customers in Canada

CAN ICES-3 B / NMB-3 B

## Notices for Customers in Europe

**CAUTION:** RISK OF EXPLOSION IF BATTERY IS REPLACED BY AN INCORRECT TYPE. DISPOSE OF USED BATTERIES ACCORDING TO THE INSTRUCTIONS.

This symbol indicates that electrical and electronic equipment is to be collected separately.



The following apply only to users in European countries:

- This product is designated for separate collection at an appropriate collection point. Do not dispose of as household waste.
- Separate collection and recycling helps conserve natural resources and prevent negative consequences for human health and the environment that might result from incorrect disposal.
- For more information, contact the retailer or the local authorities in charge of waste management.

This symbol on the battery indicates that the battery is to be collected separately.



The following apply only to users in European countries:

- All batteries, whether marked with this symbol or not, are designated for separate collection at an appropriate collection point. Do not dispose of as household waste.
- For more information, contact the retailer or the local authorities in charge of waste management.



## Bluetooth and Wi-Fi (Wireless LAN)

This product is controlled by the United States Export Administration Regulations (EAR). The permission of the United States government is not required for export to countries other than the following, which as of this writing are subject to embargo or special controls: Cuba, Iran, North Korea, Sudan, and Syria (list subject to change).

The use of wireless devices may be prohibited in some countries or regions. Contact a Nikon-authorized service representative before using the wireless features of this product outside the country of purchase.

The Bluetooth transmitter in this device operates in the 2.4 GHz band.

### ***Notice for Customers in the U.S.A. and Canada***

This device complies with part 15 of FCC Rules and Innovation, Science and Economic Development Canada's licence-exempt RSSs. Operation is subject to the following two conditions: (1) this device may not cause harmful interference, and (2) this device must accept any interference received, including interference that may cause undesired operation.

### **FCC WARNING**

The FCC requires the user to be notified that any changes or modifications made to this device that are not expressly approved by Nikon Corporation may void the user's authority to operate the equipment.

### **Compliance with FCC requirement 15.407(c)**

Data transmission is always initiated by software, which is then passed down through the MAC, through the digital and analog baseband, and finally to the RF chip. Several special packets are initiated by the MAC. These are the only ways the digital baseband portion will turn on the RF transmitter, which it then turns off at the end of the packet. Therefore, the transmitter will be on only while one of the aforementioned packets is being transmitted. In other words, this device automatically discontinues transmission in case of either absence of information to transmit or operational failure.

Frequency Tolerance:  $\pm 20$  ppm

### **FCC Radio Frequency Interference Statement**

Note: This equipment has been tested and found to comply with the limits for a Class B digital device, pursuant to part 15 of the FCC Rules. These limits are designed to provide reasonable protection against harmful interference in a residential installation. This equipment generates, uses and can radiate radio frequency energy and, if not installed and used in accordance with the instructions, may cause harmful interference to radio communications. However, there is no guarantee that interference will not occur in a particular installation. If this equipment does cause harmful interference to radio or television reception, which can be determined by turning the equipment off and on, the user is encouraged to try to correct the interference by one or more of the following measures:

- Reorient or relocate the receiving antenna.
- Increase the separation between the equipment and receiver.
- Connect the equipment into an outlet on a circuit different from that to which the receiver is connected.
- Consult the dealer or an experienced radio/TV technician for help.

### **Co-location**

This transmitter must not be co-located or operated in conjunction with any other antenna or transmitter.

Nikon Inc., 1300 Walt Whitman Road, Melville, New York 11747-3064, U.S.A.  
Tel.: 631-547-4200

### **FCC/ISED RF Exposure Statement**

The available scientific evidence does not show that any health problems are associated with using low power wireless devices. There is no proof, however, that these low power wireless devices are absolutely safe. Low power Wireless devices emit low levels of radio frequency energy (RF) in the microwave range while being used. Whereas high levels of RF can produce health effects (by heating tissue), exposure of low-level RF that does not produce heating effects causes no known adverse health effects. Many studies of low-level RF exposures have not found any biological effects. Some studies have suggested that some biological effects might occur, but such findings have not been confirmed by additional research. This product has been tested and found to comply with FCC/ISED radiation exposure limits set forth for an uncontrolled environment and meets the FCC radio frequency (RF) Exposure Guidelines and RSS-102 of the ISED radio frequency (RF) Exposure rules. Please refer to the SAR test report that was uploaded to FCC website.

### **Compliance with RSS-247 Issue 2 §6.4**

Data transmission is always initiated by software, which is the passed down through the MAC, through the digital and analog baseband, and finally to the RF chip. Several special packets are initiated by the MAC. These are the only ways the digital baseband portion will turn on the RF transmitter, which it then turns off at the end of the packet. Therefore, the transmitter will be on only while one of the aforementioned packets is being transmitted. In other words, this device automatically discontinues transmission in case of either absence of information to transmit or operational failure.

**Notice for Customers in Canada**

For indoor use only (5150-5350MHz).

**Notice for Customers in Europe and in Countries Complying with the Radio Equipment Directive**

Hereby, Nikon Corporation declares that the radio equipment type Z 5 is in compliance with Directive 2014/53/EU.



The full texts of the EU declarations of conformity are available at the following internet addresses:

[https://imaging.nikon.com/support/pdf/DoC\\_N1933.pdf](https://imaging.nikon.com/support/pdf/DoC_N1933.pdf)

## **Notice for Customers in Singapore**

Trade Name: **Nikon**  
Model: Z 5

This device complies with radio-frequency regulations. The content of certification labels not affixed to the device is given below.

Complies with  
IMDA Standards  
DA103423

## **Notice for Customers in Nigeria**

Connection and use of this communications  
equipment is permitted by the Nigerian  
Communications Commission

## **Security**

Although one of the benefits of this product is that it allows others to freely connect for the wireless exchange of data anywhere within its range, the following may occur if security is not enabled:

- Data theft: Malicious third-parties may intercept wireless transmissions to steal user IDs, passwords, and other personal information.
- Unauthorized access: Unauthorized users may gain access to the network and alter data or perform other malicious actions. Note that due to the design of wireless networks, specialized attacks may allow unauthorized access even when security is enabled.
- Unsecured networks: Connecting to open networks may result in unauthorized access. Use secure networks only.

## **Conformity Marking**

The standards with which the camera complies can be viewed using the [**Conformity marking**] option in the setup menu.

## Certificates

### • ประเทศไทย

เครื่อง โทรคมนาคมและอุปกรณ์นี้ มีความสอดคล้องตาม  
ข้อกำหนดของ กสทช

### • Maroc/

المغرب

AGREE PAR L'ANRT MAROC

Numéro d'agrément : MR23610 ANRT2020



### • México

IFETEL: RCPMU1M18-0171

1MW

La operación de este equipo está sujeta a las siguientes  
dos condiciones:

- (1) es posible que este equipo o dispositivo no cause  
interferencia perjudicial y
- (2) este equipo o dispositivo debe aceptar cualquier  
interferencia, incluyendo la que pueda causar su  
operación no deseada.

### • Paraguay



CONATEL

**Emap S.A. (Casa Nissei)**

Avda Adrian Jara, Esq. Regimiento Piribebuy, Ciudad  
del Este, Paraguay.

Tel: 595 61 500 115

Fax: 595 61 500 115

• عُمان •

Oman-TRA

D090024

R/9266/20

• الإمارات العربية المتحدة •

TRA

REGISTERED No:

ER61596/18

DEALER No:

DA39487/15

# Kit Lens Manual

## NIKKOR Z 24–70mm f/4 S Lens Manual

This section is included as a lens manual for purchasers of the NIKKOR Z 24–70mm f/4 S lens kit.

Note that lens kits may not be available in some countries or regions.

### Using the Lens

#### ■ Parts of the Lens: Names and Functions

The parts of the NIKKOR Z 24–70mm f/4 S are listed below.

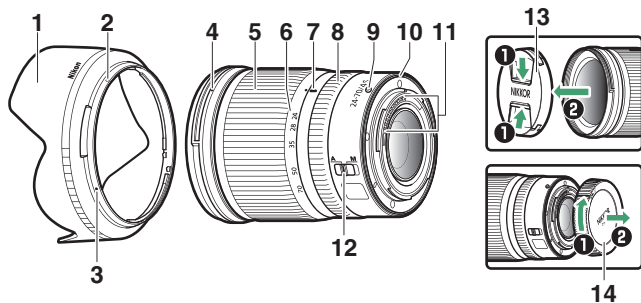

1	<b>Lens hood</b>	Lens hoods block stray light that would otherwise cause flare or ghosting. They also serve to protect the lens.
2	<b>Lens hood lock mark</b>	
3	<b>Lens hood alignment mark</b>	Use when attaching the lens hood.
4	<b>Lens hood mounting mark</b>	
5	<b>Zoom ring</b>	
6	<b>Focal length scale</b>	Determine the approximate focal length when zooming the lens in or out.
7	<b>Focal length mark</b>	
8	<b>Control ring</b>	<ul style="list-style-type: none"> <li>• <b>Autofocus mode selected:</b> In autofocus mode, you can rotate this customizable ring to perform a function selected with the camera.</li> <li>• <b>Manual focus mode selected:</b> Rotate to focus.</li> </ul>
9	<b>Lens mounting mark</b>	Use when mounting the lens on the camera.
10	<b>Rubber lens-mount gasket</b>	—
11	<b>CPU contacts</b>	Used to transfer data to and from the camera.
12	<b>Focus-mode switch</b>	Choose <b>A</b> for autofocus, <b>M</b> for manual focus. Note that regardless of the setting chosen, focus must be adjusted manually when manual focus mode is selected using camera controls.
13	<b>Front lens cap</b>	—
14	<b>Rear lens cap</b>	—



## ■ Attachment and Removal

### Attaching the Lens

---

**1** Turn the camera off, remove the body cap, and detach the rear lens cap.

---

**2** Position the lens on the camera body, keeping the mounting mark on the lens aligned with the mounting mark on the camera body, and then rotate the lens counterclockwise until it clicks into place.

### Removing the Lens

---

**1** Turn the camera off.

---

**2** Press and hold the lens release button while turning the lens clockwise.

## ■ Before Use

The lens is retractable and must be extended before use. Rotate the zoom ring as shown until the lens clicks into the extended position. Pictures can only be taken when the focal length mark points to positions between 24 and 70 on the focal length scale.

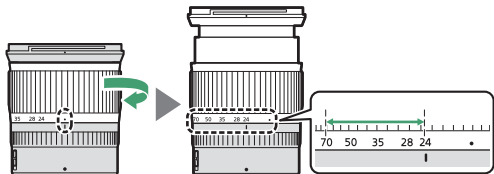

- To retract the lens, rotate the zoom ring in the opposite direction, stopping when you reach the (●) position on the focal length scale.
- If the camera is turned on with the lens retracted, a warning will be displayed. Extend the lens before use.

## ■ ■ Attaching and Removing the Lens Hood

Align the lens hood mounting mark (●) with the lens hood alignment mark (●) and then rotate the hood (②) until the ● mark is aligned with the lens hood lock mark (○).

To remove the hood, reverse the above steps.

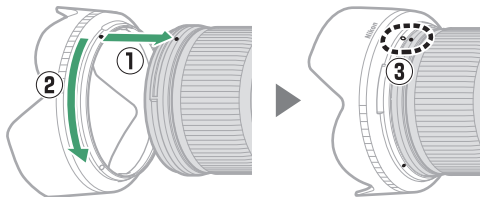

When attaching or removing the hood, hold it near the ● symbol on its base and avoid gripping it too tightly. The hood can be reversed and mounted on the lens when not in use.

## ■ ■ When the Lens Is Attached

The focus position may change if you turn the camera off and then on again after focusing. Refocus before shooting. If you have focused on a pre-selected location while waiting for your subject to appear, we recommend that you do not turn the camera off until the picture is taken.

## **Precautions for Use**

- Do not pick up or hold the lens or camera using only the lens hood.
- Keep the CPU contacts clean.
- Should the rubber lens-mount gasket be damaged, cease use immediately and take the lens to a Nikon-authorized service center for repair.
- Replace the lens caps when the lens is not in use.
- To protect the interior of the lens, store it out of direct sunlight.
- Keep the lens dry. Rusting of the internal mechanism can cause irreparable damage.
- Leaving the lens in extremely hot locations could damage or warp parts made from reinforced plastic.
- Rapid changes in temperature may cause damaging condensation inside and outside the lens. Before taking the lens from a warm to a cold environment or vice versa, place it in its case or a plastic bag to slow the change in temperature.
- We recommend that you place the lens in its case to protect it from scratches during transport.

## **Lens Care**

- Removing dust is normally sufficient to clean the glass surfaces of the lens.
- Smudges and fingerprints can be removed from fluorine-coated lens elements using a soft, clean cotton cloth or lens cleaning tissue; clean from the center outwards using a circular motion. To remove stubborn stains, wipe gently using a soft cloth lightly dampened with a small amount of distilled water, ethanol, or lens cleaner. Any drop-shaped marks left from this process on the water- and oil-repellent surface can subsequently be removed with a dry cloth.
- When cleaning lens elements that are not fluorine-coated, remove smudges and fingerprints using a soft, clean cotton cloth or lens cleaning tissue lightly dampened with a small amount of ethanol or lens cleaner. Wipe gently from the center outwards in a circular motion, taking care not to leave smears or touch the lens with your fingers.
- Never use organic solvents such as paint thinner or benzene to clean the lens.
- Neutral Color (NC) filters (available separately) and the like can be used to protect the front lens element.
- If the lens will not be used for an extended period, store it in a cool, dry location to prevent mold and rust. Do not store in direct sunlight or with naphtha or camphor moth balls.

## **Accessories**

### **■ Supplied Accessories**

- LC-72B 72 mm snap-on Front Lens Cap
  - LF-N1 Rear Lens Cap
  - HB-85 Bayonet Hood
  - CL-C1 Lens Case
- 

### **✓ Using the Lens Case**

- The case is intended to protect the lens from scratches, not from falls or other physical shocks.
- The case is not water resistant.
- The material used in the case may fade, bleed, shrink, or change color when rubbed or wet.
- Remove dust with a soft brush.
- Water and stains can be removed from the surface with a soft, dry cloth. Do not use alcohol, benzene, thinner, or other volatile chemicals.
- Do not store in locations exposed to direct sunlight or high temperatures or humidity.
- Do not use the case to clean the monitor or lens elements.
- Be careful that the lens does not fall from the case during transport.

**Material:** Polyester

---

### **■ Compatible Accessories**

72 mm screw-on filters

---

### **✓ Filters**

Use only one filter at a time. Remove the lens hood before attaching filters or rotating circular polarizing filters.

---

## Specifications

<b>Mount</b>	Nikon Z mount
<b>Focal length</b>	24 – 70 mm
<b>Maximum aperture</b>	f/4
<b>Lens construction</b>	14 elements in 11 groups (including 1 ED lens element, 1 aspherical ED element, 3 aspherical elements, elements with Nano Crystal Coat, and a fluorine-coated front lens element)
<b>Angle of view</b>	<ul style="list-style-type: none"><li>• FX format: 84° – 34° 20′</li><li>• DX format: 61° – 22° 50′</li></ul>
<b>Focal length scale</b>	Graduated in millimeters (24, 28, 35, 50, 70)
<b>Focusing system</b>	Internal focusing system
<b>Minimum focus distance</b>	0.3 m (0.99 ft) from focal plane at all zoom positions
<b>Diaphragm blades</b>	7 (rounded diaphragm opening)
<b>Aperture range</b>	f/4 – 22
<b>Filter-attachment size</b>	72 mm (P = 0.75 mm)
<b>Dimensions</b>	Approx. 77.5 mm maximum diameter × 88.5 mm (distance from camera lens mount flange when lens is retracted)
<b>Weight</b>	Approx. 500 g (1 lb 1.7 oz)

Nikon reserves the right to change the appearance, specifications, and performance of this product at any time and without prior notice.

# NIKKOR Z 24–200mm f/4–6.3 VR Lens Manual

This section is included as a lens manual for purchasers of the NIKKOR Z 24–200mm f/4–6.3 VR lens kit.

Note that lens kits may not be available in some countries or regions.

## Using the Lens

### ■ Parts of the Lens: Names and Functions

The parts of the NIKKOR Z 24–200mm f/4–6.3 VR are listed below.

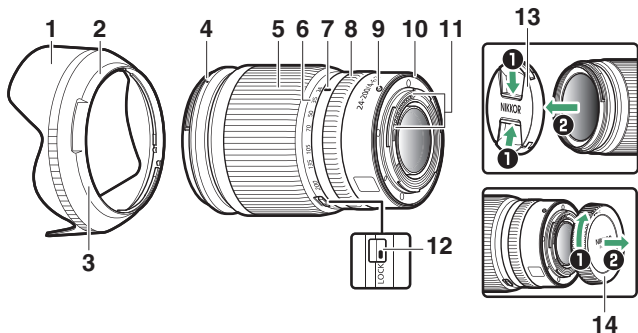



1	<b>Lens hood</b>	Lens hoods block stray light that would otherwise cause flare or ghosting. They also serve to protect the lens.
2	<b>Lens hood lock mark</b>	Use when attaching the lens hood.
3	<b>Lens hood alignment mark</b>	
4	<b>Lens hood mounting mark</b>	
5	<b>Zoom ring</b>	
6	<b>Focal length scale</b>	Determine the approximate focal length when zooming the lens in or out.
7	<b>Focal length mark</b>	
8	<b>Control ring</b>	<ul style="list-style-type: none"> <li>• <b>Autofocus mode selected:</b> In autofocus mode, rotate the ring to adjust a setting such as <b>[Focus (M/A)]</b> or <b>[Aperture]</b> assigned using the camera. For more information, see the description of <b>[Custom control assignment]/[Custom controls (shooting)]</b> in the camera manual.</li> <li>• <b>Manual focus mode selected:</b> Rotate the ring to focus.</li> </ul>
9	<b>Lens mounting mark</b>	Use when mounting the lens on the camera.
10	<b>Rubber lens-mount gasket</b>	—
11	<b>CPU contacts</b>	Used to transfer data to and from the camera.

12	<b>Zoom lock switch</b>	To lock the zoom ring, zoom out to the 24 mm position and slide the switch to <b>LOCK</b> . This prevents the lens extending under its own weight while you are carrying the camera.
13	<b>Lens cap (front cap)</b>	—
14	<b>Lens cap (rear cap)</b>	—

## ■ Attachment and Removal

### Attaching the Lens

- 1 Turn the camera off, remove the body cap, and detach the rear lens cap.**
- 2 Position the lens on the camera body, keeping the mounting mark on the lens aligned with the mounting mark on the camera body, and then rotate the lens counterclockwise until it clicks into place.**

### Removing the Lens

- 1 Turn the camera off.**
- 2 Press and hold the lens release button while turning the lens clockwise.**

## ■ Attaching and Removing the Lens Hood

Align the lens hood mounting mark with the lens hood alignment mark (①) and then rotate the hood (②) until the mounting mark is aligned with the lens hood lock mark (③). To remove the hood, reverse the above steps.

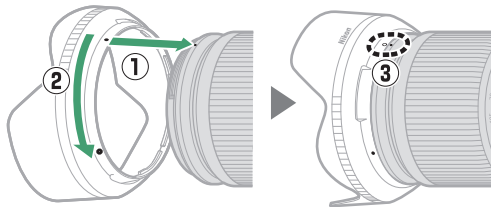

When attaching or removing the hood, hold it near the lens hood alignment mark (●) and avoid gripping the front of the hood too tightly. The hood can be reversed and mounted on the lens when not in use.

## ■ Using the Lens on Cameras with a Built-in Flash

Shadows will be visible in photos where the light from the built-in flash is obscured by the lens or lens hood. Remove the lens hood before shooting. Note, however, that even if the hood is removed, shadows may still be visible at some focal lengths and subject distances.

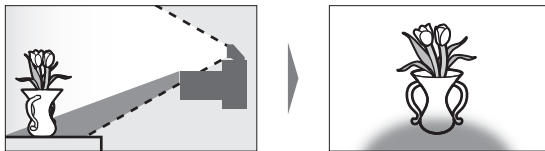

- The lens may produce shadows in photographs taken with the built-in flash when mounted on the following camera. The focal lengths and minimum subject distances at which shadows will not appear are as follows:

Camera <sup>1</sup>	Focal lengths	Minimum distance without shadow <sup>2</sup>
Z 50	24 mm	Shadows occur at all subject distances
	35 mm	1.5 m (5 ft)
	50 mm	1.0 m (3 ft 4 in.)
	70 – 200 mm	No shadows

- 1 See the camera manual for the latest information.
- 2 Lens hood removed.

## ■ ■ Vibration Reduction (VR)

The lens's on-board vibration reduction can be enabled or disabled using camera controls; see the camera manual for details. With [**Normal**] selected for the on-camera vibration reduction option, vibration reduction allows speeds up to 5.0 stops \* slower than would otherwise be the case, expanding the range of shutter speeds available.

\* Measured according to CIPA standards. Values for lenses that support FX format are measured on FX-format mirrorless cameras, those for DX lenses on DX-format mirrorless cameras. Values for zoom lenses are measured at maximum zoom.

---

### ✓ Vibration Reduction

- Due to the design of the vibration reduction system, the lens may rattle when shaken. This does not indicate a malfunction.
- To reduce blur caused by tripod shake, select [**Normal**] or [**Sport**] for the on-camera vibration reduction option when the camera is mounted on a tripod. Note, however, that depending on the type of tripod and shooting conditions, there may be cases in which [**Off**] is the preferred option.
- [**Normal**] or [**Sport**] is recommended when the camera is mounted on a monopod.

---

## ■ ■ When the Lens Is Attached

The focus position may change if you turn the camera off and then on again after focusing. If you have focused on a pre-selected location while waiting for your subject to appear, we recommend that you do not turn the camera off until the picture is taken.

## **Precautions for Use**

- Do not pick up or hold the lens or camera using only the lens hood.
- Keep the CPU contacts clean.
- Should the rubber lens-mount gasket be damaged, cease use immediately and take the lens to a Nikon-authorized service center for repair.
- Replace the lens caps when the lens is not in use.
- To protect the interior of the lens, store it out of direct sunlight.
- Do not leave the lens in humid locations or in locations in which it may be exposed to moisture. Rusting of the internal mechanism can cause irreparable damage.
- Do not leave the lens next to open flames or in other extremely hot locations. Extreme heat could damage or warp exterior parts made from reinforced plastic.
- Rapid changes in temperature may cause damaging condensation inside and outside the lens. Before taking the lens from a warm to a cold environment or vice versa, place it in a bag or plastic case to slow the change in temperature.
- We recommend that you place the lens in its case to protect it from scratches during transport.

## **Lens Care**

- Removing dust is normally sufficient to clean the glass surfaces of the lens.
- *The fluorine-coated front lens element* can be cleaned as described below.
  - Smudges, fingerprints, and other oily stains can be removed using a soft, clean cotton cloth or lens cleaning tissue; clean from the center outwards using a circular motion.
  - To remove stubborn stains, wipe gently using a soft cloth lightly dampened with a small amount of distilled water, ethanol, or lens cleaner.
  - Any drop-shaped marks left from this process on the water- and oil-repellent surface can subsequently be removed with a dry cloth.
- *When cleaning the rear lens element, which is not fluorine-coated*, remove smudges, fingerprints, and other oily stains using a soft, clean cotton cloth or lens cleaning tissue lightly dampened with a small amount of ethanol or lens cleaner. Wipe gently from the center outwards in a circular motion, taking care not to leave smears or touch the lens with your fingers.
- Never use organic solvents such as paint thinner or benzene to clean the lens.
- Neutral Color (NC) filters (available separately) and the like can be used to protect the front lens element.
- If the lens will not be used for an extended period, store it in a cool, dry location to prevent mold and rust. Do not store in direct sunlight or with naphtha or camphor moth balls.

## **Accessories**

### **■ Supplied Accessories**

- LC-67B Lens Cap (front cap)
  - LF-N1 Lens Cap (rear cap)
  - HB-93 Lens Hood
  - CL-C1 Lens Case
- 

### **✓ Using the Lens Case**

- The case is intended to protect the lens from scratches, not from falls or other physical shocks.
- The case is not water resistant.
- The material used in the case may fade, bleed, stretch, shrink, or change color when rubbed or wet.
- Remove dust with a soft brush.
- Water and stains can be removed from the surface with a soft, dry cloth. Do not use alcohol, benzene, thinner, or other volatile chemicals.
- Do not store in locations exposed to direct sunlight or high temperatures or humidity.
- Do not use the case to clean the monitor or lens elements.
- Be careful that the lens does not fall from the case during transport.

**Material:** Polyester

---

### **■ Compatible Accessories**

67 mm screw-on filters

---

### **✓ Filters**

- Use only one filter at a time.
  - Remove the lens hood before attaching filters or rotating circular polarizing filters.
-



## Specifications

<b>Mount</b>	Nikon Z mount
<b>Focal length</b>	24 – 200 mm
<b>Maximum aperture</b>	f/4 – 6.3
<b>Lens construction</b>	19 elements in 15 groups (including 2 ED elements, 1 aspherical ED element, 2 aspherical elements, and elements with an ARNEO coat and a fluorine-coated front lens element)
<b>Angle of view</b>	<ul style="list-style-type: none"><li>• FX format: 84°–12° 20'</li><li>• DX format: 61°–8°</li></ul>
<b>Focal length scale</b>	Graduated in millimeters (24, 35, 50, 70, 105, 135, 200)
<b>Focusing system</b>	Internal focusing system
<b>Vibration reduction</b>	Lens shift using <b>voice coil motors</b> (VCMs)
<b>Minimum focus distance (measured from focal plane)</b>	<ul style="list-style-type: none"><li>• 24 mm zoom position: 0.5 m (1.64 ft)</li><li>• 35 mm zoom position: 0.54 m (1.78 ft)</li><li>• 50 mm zoom position: 0.55 m (1.81 ft)</li><li>• 70 mm zoom position: 0.58 m (1.91 ft)</li><li>• 105 mm zoom position: 0.65 m (2.14 ft)</li><li>• 135 mm zoom position: 0.68 m (2.24 ft)</li><li>• 200 mm zoom position: 0.7 m (2.30 ft)</li></ul>
<b>Maximum reproduction ratio</b>	0.28×
<b>Diaphragm blades</b>	7 (rounded diaphragm opening)

<b>Aperture range</b>	<ul style="list-style-type: none"> <li>• 24 mm zoom position: f/4 – 22</li> <li>• 200 mm zoom position: f/6.3 – 36</li> </ul> <p>The minimum aperture displayed may vary depending on the size of the exposure increment selected with the camera.</p>
<b>Filter-attachment size</b>	67 mm (P = 0.75 mm)
<b>Dimensions</b>	Approx. 76.5 mm/3.1 in. maximum diameter × 114 mm/4.5 in. (distance from camera lens mount flange)
<b>Weight</b>	Approx. 570 g (1 lb 4.2 oz)

Nikon reserves the right to change the appearance, specifications, and performance of this product at any time and without prior notice.

# NIKKOR Z 24–50mm f/4–6.3 Lens Manual

This section is included as a lens manual for purchasers of the NIKKOR Z 24–50mm f/4–6.3 lens kit.

Note that lens kits may not be available in some countries or regions.

## Using the Lens

### ■ Parts of the Lens: Names and Functions

The parts of the NIKKOR Z 24–50mm f/4–6.3 are listed below.

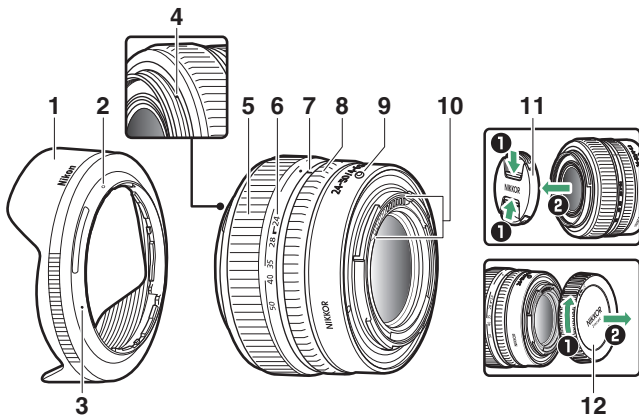

1	<b>Lens hood *</b>	Lens hoods block stray light that would otherwise cause flare or ghosting. They also serve to protect the lens.
2	<b>Lens hood lock mark</b>	Use when attaching the lens hood.
3	<b>Lens hood alignment mark</b>	
4	<b>Lens hood mounting mark</b>	
5	<b>Zoom ring</b>	
6	<b>Focal length scale</b>	Determine the approximate focal length when zooming the lens in or out.
7	<b>Focal length mark</b>	
8	<b>Control ring</b>	<ul style="list-style-type: none"> <li>• <b>Autofocus mode selected:</b> In autofocus mode, rotate the ring to adjust a setting such as <b>[Focus (M/A)]</b> or <b>[Aperture]</b> assigned using the camera. For more information, see the description of <b>[Custom controls]/[Custom control assignment]/[Custom controls (shooting)]</b> in the camera manual.</li> <li>• <b>Manual focus mode selected:</b> Rotate the ring to focus.</li> </ul>
9	<b>Lens mounting mark</b>	Use when mounting the lens on the camera.
10	<b>CPU contacts</b>	Used to transfer data to and from the camera.
11	<b>Lens cap (front cap)</b>	—
12	<b>Lens cap (rear cap)</b>	—

\* Available separately.

## ■ Attachment and Removal

### Attaching the Lens

---

**1** Turn the camera off, remove the body cap, and detach the rear lens cap.

---

**2** Position the lens on the camera body, keeping the mounting mark on the lens aligned with the mounting mark on the camera body, and then rotate the lens counterclockwise until it clicks into place.

### Removing the Lens

---

**1** Turn the camera off.

---

**2** Press and hold the lens release button while turning the lens clockwise.

## ■ Before Use

The lens is retractable and must be extended before use. Rotate the zoom ring as shown until the lens clicks into the extended position. Pictures can only be taken when the focal length mark points to positions between 24 and 50 on the focal length scale.

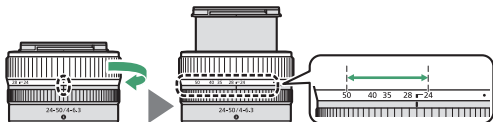

- To retract the lens, rotate the zoom ring in the opposite direction, stopping when you reach the (●) position on the focal length scale.
- If the camera is turned on with the lens retracted, a warning will be displayed. Extend the lens before use.

## ■ Attaching and Removing the Lens Hood

Align the lens hood mounting mark with the lens hood alignment mark (①) and then rotate the hood (②) until the mounting mark is aligned with the lens hood lock mark (③). To remove the hood, reverse the above steps.

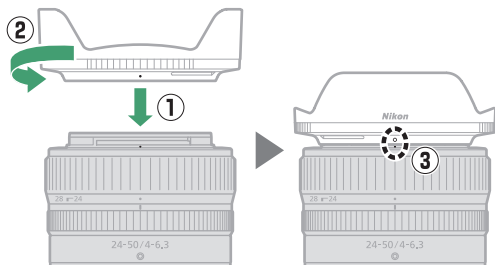

When attaching or removing the hood, hold it near the lens hood alignment mark (●) and avoid gripping the front of the hood too tightly. The hood can be reversed and mounted on the lens when not in use.

## ■ ■ Using the Lens on Cameras with a Built-in Flash

Shadows will be visible in photos where the light from the built-in flash is obscured by the lens or lens hood. Remove the lens hood before shooting.

## ■ ■ When the Lens Is Attached

The focus position may change if you turn the camera off and then on again after focusing. If you have focused on a pre-selected location while waiting for your subject to appear, we recommend that you do not turn the camera off until the picture is taken.



## **Precautions for Use**

- Do not pick up or hold the lens or camera using only the lens hood.
- Keep the CPU contacts clean.
- Replace the lens caps when the lens is not in use.
- To protect the interior of the lens, store it out of direct sunlight.
- Do not leave the lens in humid locations or in locations in which it may be exposed to moisture. Rusting of the internal mechanism can cause irreparable damage.
- Do not leave the lens next to open flames or in other extremely hot locations. Extreme heat could damage or warp exterior parts made from reinforced plastic.
- Rapid changes in temperature may cause damaging condensation inside and outside the lens. Before taking the lens from a warm to a cold environment or vice versa, place it in a bag or plastic case to slow the change in temperature.
- We recommend that you place the lens in its case to protect it from scratches during transport.

## **Lens Care**

- Removing dust is normally sufficient to clean the glass surfaces of the lens.
- Smudges, fingerprints, and other oily stains can be removed from the lens surface using a soft, clean cotton cloth or lens cleaning tissue lightly dampened with a small amount of ethanol or lens cleaner. Wipe gently from the center outwards in a circular motion, taking care not to leave smears or touch the lens with your fingers.
- Never use organic solvents such as paint thinner or benzene to clean the lens.
- Neutral Color (NC) filters (available separately) and the like can be used to protect the front lens element.
- If the lens will not be used for an extended period, store it in a cool, dry location to prevent mold and rust. Do not store in direct sunlight or with naphtha or camphor moth balls.

## **Accessories**

### **■ Supplied Accessories**

- LC-52B Lens Cap (front cap)
- LF-N1 Lens Cap (rear cap)

### **■ Compatible Accessories**

- HB-98 Lens Hood
- CL-C4 Lens Case
- 52 mm screw-on filters

---

### **✓ Filters**

- Use only one filter at a time.
  - Remove the lens hood before attaching filters or rotating circular polarizing filters.
-

## Specifications

<b>Mount</b>	Nikon Z mount
<b>Focal length</b>	24 – 50 mm
<b>Maximum aperture</b>	f/4 – 6.3
<b>Lens construction</b>	11 elements in 10 groups (including 2 ED elements and 3 aspherical elements)
<b>Angle of view</b>	<ul style="list-style-type: none"><li>• FX format: 84°–47°</li><li>• DX format: 61°–31° 30'</li></ul>
<b>Focal length scale</b>	Graduated in millimeters (24, 28, 35, 40, 50)
<b>Focusing system</b>	Internal focusing system
<b>Minimum focus distance</b>	0.35 m (1.15 ft) from focal plane at all zoom positions
<b>Maximum reproduction ratio</b>	0.17× (50 mm zoom position)
<b>Diaphragm blades</b>	7 (rounded diaphragm opening)
<b>Aperture range</b>	<ul style="list-style-type: none"><li>• 24 mm zoom position: f/4 – 22</li><li>• 50 mm zoom position: f/6.3 – 36</li></ul>
<b>Filter-attachment size</b>	52 mm (P = 0.75 mm)
<b>Dimensions</b>	Approx. 73.5 mm (2.9 in.) maximum diameter × 51 mm (2.1 in.) (distance from camera lens mount flange when lens is retracted)
<b>Weight</b>	Approx. 195 g (6.9 oz)

Nikon reserves the right to change the appearance, specifications, and performance of this product at any time and without prior notice.

# Index

## Symbols

(Auto).....	48, 53
<b>P</b> (Programmed auto).....	94
<b>S</b> (Shutter-priority auto).....	95
<b>A</b> (Aperture-priority auto).....	96
<b>M</b> (Manual).....	97
<b>U1, U2, U3</b> (User setting mode).....	102
(Single frame).....	112, 114
<b>L</b> (Continuous L).....	112
<b>H</b> (Continuous H).....	112
(Self-timer).....	112
(Continuous).....	114
(Silent photography).....	87
(Electronic front-curtain shutter). 369	
(Mechanical shutter).....	369
(Pinpoint AF).....	66
(Single-point AF).....	67
(Dynamic-area AF).....	67
(Wide-area AF (S)).....	67
(Wide-area AF (L)).....	67
(Auto-area AF).....	68
(Matrix metering).....	140
(Center-weighted metering).....	140
(Spot metering).....	140
* (Highlight-weighted metering).. 140	
(Monitor mode) button.....	10
<b>MENU</b> button.....	24
<b>i</b> button.....	29, 120
button.....	58
button.....	61
<b>ISO</b> button.....	105

(Exposure compensation) button 109	
(Release mode) button.....	111
(Self-timer) button.....	111
button.....	23
button.....	23
Help.....	28
<b>i</b> menu.....	29, 120

## A

AC adapter.....	657
Access-point mode.....	499, 501
Active D-Lighting.....	255
ADL bracketing.....	278
AE & flash bracketing.....	270
AE bracketing.....	270
AE lock.....	118
AF activation.....	357
AF fine-tuning options.....	422
AF speed.....	411
AF tracking sensitivity.....	411
AF-area mode.....	66
<b>AF-C</b> (Continuous AF).....	64
AF-C priority selection.....	351
<b>AF-F</b> (Full-time AF).....	64
<b>AF-ON</b> button.....	24
<b>AF-S</b> (Single AF).....	64
AF-S priority selection.....	352
After delete.....	212
Airplane mode.....	441
All images.....	190
Animal face/eye-detection AF.....	72
Aperture.....	96, 97
Apply settings to live view.....	372

Assign remote (WR) Fn button...	441
Attaching a lens.....	42
Attenuator.....	343
Auto (Set Picture Control).....	123
Auto (White balance).....	82
Auto bracketing.....	269
Auto bracketing (mode M).....	378
Auto  ISO sensitivity control.....	377
Auto distortion control.....	260, 339
Auto ISO sensitivity control.....	107
Auto send.....	518
Auto-area AF.....	68
Auto-area AF face/eye detection	353

## B

---

Backup (Role played by card in Slot 2).....	232
Battery.....	34, 36
Battery charger.....	34
Battery info.....	449
Beep options.....	435
Bluetooth.....	534
Bracketing order.....	379
Brightness (Set Picture Control).	127
Built-in AF-assist illuminator.....	361
Built-in microphone.....	54
Bulb.....	99

## C

---

Calendar playback.....	160
Camera-mounted flash units.....	561
Center-weighted area.....	364
Center-weighted metering.....	140
Charger.....	34
Charging AC adapter.....	654
Choose color temperature (White balance).....	84

Choose image area.....	153, 234
Choose start/end point.....	178
CL mode shooting speed.....	367
Clarity (Set Picture Control).....	127
Clean image sensor.....	426, 663
Cloudy (White balance).....	83
Color space.....	254
Color temperature.....	86, 131, 242
Command dial.....	12
Compensation.....	572
Conformity marking.....	448
Connect to PC.....	445
Connect to smart device.....	442, 534, 550
Continuous.....	114
Continuous AF.....	64
Continuous H.....	112
Continuous L.....	112
Contrast (Set Picture Control).....	127
Control ring.....	78
Copy image(s).....	213
Copyright information.....	433
Creative Picture Control.....	124
Custom controls.....	382, 403
Custom Settings.....	347
Customize command dials.....	397
Customize  menu.....	30, 380, 402

## D

---

Delete.....	61, 185, 209
Destination.....	155, 334
Detaching lenses.....	43
Diffraction compensation... ..	260, 339
Diopter adjustment control.....	9
Direct connection to PC.....	501
Direct sunlight (White balance)....	83
<b>DISP</b> button.....	21
Distortion control.....	478

D-Lighting.....	475
Dual-format recording PB slot.....	210
Dynamic-area AF.....	67

## E

---

Easy Connect.....	508
Easy exposure compensation.....	363
Effect level (Set Picture Control).....	127
Electronic VR.....	156, 341
Encryption key.....	501, 510
Energy saving.....	452
Error (wireless connection).....	551
EV steps for exposure cntrl.....	363
Exposure comp. for flash.....	376
Exposure compensation.....	109
Exposure delay mode.....	368
Exposure indicators.....	98
Eye-detection AF.....	70

## F

---

Face-detection AF.....	70
File information.....	163
File naming.....	231, 334
File number sequence.....	370
Fill flash.....	139, 569
Filter effects (Set Picture Control).....	127
Fine-tune optimal exposure.....	364
Firmware version.....	459
Flange-back distance.....	80
Flash (White balance).....	84
Flash bracketing.....	270
Flash compensation.....	267, 572
Flash control.....	263
Flash control mode.....	566
Flash information display.....	576, 607
Flash mode.....	139, 569
Flash off.....	139, 570

Flash shutter speed.....	376
Flash sync speed.....	374
Flat (Set Picture Control).....	123
Flexible program.....	94
Flicker reduction.....	261, 340
Fluorescent (White balance).....	83
<b>Fn1</b> button.....	31, 81
<b>Fn2</b> button.....	31, 63
Focal plane mark.....	80
Focus indicator.....	79
Focus lock.....	118
Focus mode.....	63, 146, 157
Focus point options.....	359
Focus point wrap-around.....	358
Focus points used.....	69, 354
Focus ring.....	78
Focus shift shooting.....	322
Focus tracking with lock-on.....	352
Format memory card.....	415
Frame size/frame rate.....	150, 335
Framing grid display.....	372
Frequency response.....	343
Full-frame playback.....	158
Full-time AF.....	64
FV lock.....	573

## H

---

HDMI.....	437, 557
HDR (high dynamic range).....	291
Headphone volume.....	344
Hi (ISO).....	106
High ISO NR.....	258, 338
High sensitivity (Hi).....	106
Highlight display.....	412
Highlights.....	164
Highlight-weighted metering.....	140
Histogram.....	21, 22, 165
Hue (Set Picture Control).....	127

## I

---

Image comment.....	432
Image Dust Off ref photo .....	427
Image overlay.....	481
Image quality.....	234
Image review.....	211
Image size.....	138, 235
Images shot on selected dates... ..	189
Incandescent (White balance) .....	83
Information display .....	421
Infrastructure mode .....	500, 507
Interval timer shooting .....	297
IP address.....	511
ISO sensitivity .....	105
ISO sensitivity settings 107, 237, 336	

## L

---

Landscape (Set Picture Control) 123	
Language.....	416
Limit AF-area mode selection ....	358
Limit monitor mode selection ....	420
Lo (ISO).....	106
Location data.....	170, 437
Long exposure NR .....	257
Long time-exposures .....	99
Low sensitivity (Lo).....	106
Low-light AF .....	360

## M

---

MAC address.....	448
Main command dial .....	12
Manage Picture Control.....	250, 337
Manual (Shooting mode) .....	97
Manual focus.....	64, 78
Manual focus ring in AF mode... ..	362
Matrix metering.....	140

Max. continuous release.....	367
Memory buffer .....	114
Memory card.....	38, 690
Memory card capacity.....	692
Metering .....	140
<b>MF</b> (Manual Focus).....	64
Microphone sensitivity.....	152, 342
Mid-range sharpening (Set Picture Control).....	127
Mode dial.....	11, 49, 93
Modeling flash.....	377
Monitor brightness.....	417
Monitor color balance .....	418
Monochrome .....	480
Monochrome (Set Picture Control) ..	123
Movie file type.....	335
Movie quality .....	150, 335
Movie shooting menu.....	333
Movie-record button.....	54
Multiple exposure .....	281
My Menu .....	491

## N

---

Natural light auto (White balance)83	
NEF (RAW) processing.....	464
NEF (RAW) recording .....	236
Network settings .....	445, 501, 507
Neutral.....	123
Non-CPU lens data .....	426

## O

---

OK button.....	394, 410
Overflow (Role played by card in Slot 2).....	232
Overview .....	170



## P

---

Pairing (Bluetooth).....	442
Peaking highlights.....	80, 373
Perspective control.....	479
Photo information.....	162
Photo shooting menu.....	223
Photo/movie selector.....	49, 53
PIN-entry WPS.....	508
Pinpoint AF.....	66
Pixel mapping.....	430
Playback display options.....	210
Playback folder.....	209
Playback menu.....	208
Portrait (Set Picture Control).....	123
Power connector.....	657
Power off delay.....	52, 366
Preset manual (White balance).....	84, 132, 244
Press the shutter-release button all the way down.....	52
Press the shutter-release button halfway.....	51
Programmed auto.....	94
Protect.....	91
Push-button WPS.....	508

## Q

---

Quick crop.....	172
Quick sharp (Set Picture Control)	127

## R

---

Rating.....	89, 222
RAW Slot 1 - JPEG Slot 2 (Role played by card in Slot 2).....	232
Rear-curtain sync.....	139, 570
Recent settings.....	496

Rechargeable Li-ion battery.....	34
Red-eye correction.....	476
Red-eye reduction.....	139, 569
Release button to use dial.....	400
Release mode.....	111, 142
Remote flash photography.....	579
Remote photography.....	523
Reset all settings.....	459
Reset custom settings.....	351
Reset movie shooting menu.....	334
Reset photo shooting menu.....	224
Reset user settings.....	415
Resize.....	470
Retouch menu.....	460
Reverse indicators.....	401
Role played by card in Slot 2.....	232
Rotate tall.....	212

## S

---

Saturation (Set Picture Control).....	127
Save current frame.....	182
Save user settings.....	102, 415
Save/load menu settings.....	454
Search for Wi-Fi network.....	508
Select to send (Bluetooth).....	443
Select to send to computer.....	517
Selected images.....	188
Selecting Pictures for Upload.....	176
Self-timer.....	112, 115, 365
Send while off.....	444
Set Picture Control.....	123, 247
Set the clock.....	44
Setup menu.....	413
Shade (White balance).....	83
Sharpening (Set Picture Control)	127
Shooting data.....	167
Shutter spd & aperture lock.....	396
Shutter speed.....	95, 97

Shutter type.....	369
Shutter-release button AE-L.....	365
Silent photography.....	87, 332
Single AF.....	64
Single frame.....	112, 114
Single-point AF.....	67
Slide show.....	220
Slot empty release lock.....	453
Slow sync.....	139, 570
SnapBridge.....	522
Spot metering.....	140
SSID.....	501, 509
Standard (Set Picture Control) ...	123
Standby timer.....	52
Storage folder.....	225
Store points by orientation.....	355
Straighten.....	477
Sub-command dial.....	12
Subject-tracking AF.....	74
Sub-selector.....	23, 117
Sync. release mode options.....	368

## T

---

Thumbnail.....	159
Time.....	99
Time zone and date.....	44, 416
Timecode.....	345
Time-lapse movie.....	311
Toning (Set Picture Control).....	127
Touch controls.....	436
Touch shutter.....	76
Trim.....	469
Trim movie.....	490

## U

---

USB cable.....	iv
USB power delivery.....	450

User setting mode.....	102
------------------------	-----

## V

---

Vibration reduction.....	143
View all in continuous mode.....	373
View memory card info.....	141
Viewfinder.....	9
Viewfinder brightness.....	419
Viewfinder color balance.....	420
Vignette control.....	259, 339
Virtual horizon.....	21, 22
Vivid (Set Picture Control).....	123

## W

---

WB bracketing.....	275
White balance.....	81, 129, 239
Wide-area AF (L).....	67
Wide-area AF (S).....	67
Wi-Fi connection. 141, 155, 443, 445	
Wi-Fi mode.....	525
Wind noise reduction.....	344
Wireless remote (WR) options.....	438
Wireless Transmitter Utility.....	498
WR-R10.....	438, 581

## Z

---

Zoom.....	183
-----------	-----



A series of 20 horizontal lines, evenly spaced, providing a guide for handwriting practice.

# Changes Made via Firmware Updates

## Firmware Version Info

To view the camera firmware version or update the camera firmware, select [**Firmware version**] in the setup menu. The latest firmware for the Z 5 is available for download from the Nikon Download Center.

<https://downloadcenter.nikonimglib.com/>

## Features Available with “C” Firmware Version 1.10

The new features available with camera “C” firmware version 1.10 are described below.

### Saving the Focus Position

A [**Save focus position**] option has been added to the setup menu. If [**On**] is selected, the focus position in effect when the camera is turned off will be restored when the camera is next turned on.

- The focus position may change with adjustments to zoom or fluctuations in ambient temperature.
- This option applies only when the camera is used with Z mount autofocus lenses.
- Selecting [**On**] may increase camera startup times.

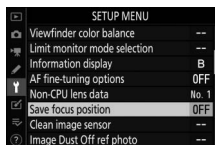

No reproduction in any form of this manual, in whole or in part (except for brief quotation in critical articles or reviews), may be made without written authorization from NIKON CORPORATION.

**NIKON CORPORATION**

---

© 2020 Nikon Corporation

SB2F09(11)  
6MOA5211-09