

# **Nikon**

DIGITAL CAMERA

# **Z 50**

## Reference Manual

This camera features updated firmware with added functions. For more information, see “Added Functions” (page 497).

- Read this manual thoroughly before using the camera.
- To ensure proper use of the camera, be sure to read “For Your Safety” (page xxiii).
- After reading this manual, keep it in a readily accessible place for future reference.

## Choose from 2 different manuals.

For a guide to all aspects of camera operation, read:

### The **Reference Manual** (this manual)

In addition to the material covered in the *User's Manual* supplied with the camera, the *Reference Manual* explores applied photography, details the options available in the camera menus, and covers such topics as connecting the camera to other devices.



### Among the topics covered in the Reference Manual are:

- Advanced shooting options
- The *i* Menu
- Menu guide
- Wireless connections to computers, smartphones, and tablets
- Connecting to other devices
- Flash photography using optional flash units

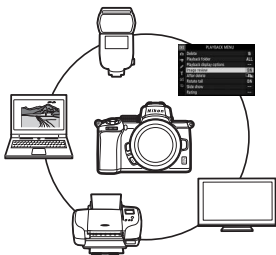

The Reference Manual can also be viewed online in html format.



<https://onlinemanual.nikonimglib.com/z50/en/>

**Z 50 Model Name: N1912**

✓ **For a guide to basic shooting and playback, read:**

## **The *User's Manual* (included)**

Master basic camera operations and features.



### **Outline:**

- Table of Contents
- Menu List
- Getting to Know the Camera
- First Steps
- Basic Photography and Playback
- Basic Settings
- Troubleshooting
- Technical Notes
- Index

## Package Contents

Be sure all items listed here were included with your camera.





*BF-N1 body cap*



*DK-30 rubber eyecup  
(comes attached to  
camera,  438)*

*Camera*

- EN-EL25 rechargeable Li-ion battery with terminal cover*
- MH-32 battery charger (plug adapter supplied in countries or regions where required; shape depends on country of sale)*
- Strap ( 30)*

- Warranty*
- User's Manual*
- UC-E21 USB cable ( 391)*

*Memory cards are sold separately.* Purchasers of the lens kit option should confirm that the package also includes a lens (manuals for the lens may also be provided).

### **The Nikon Download Center**

Visit the Nikon download center to download firmware updates, NX Studio and other Nikon software, and manuals for Nikon products including cameras, NIKKOR lenses, and flash units.

<https://downloadcenter.nikonimglib.com/>



# About This Manual

## Symbols and Conventions

To make it easier to find the information you need, the following symbols and conventions are used:



This icon marks notes, information that should be read before using this product.



This icon marks tips, additional information you may find helpful when using this product.



This icon marks references to other sections in this manual.

Menu items, options, and messages that appear in the camera displays are shown in **bold**. Throughout this manual, the display in camera monitor and viewfinder during shooting is referred to as the “shooting display”; in most cases, the illustrations show the monitor.

This camera uses SD, SDHC, and SDXC memory cards, referred to throughout this manual as “memory cards”.

Throughout this manual, smartphones and tablets are referred to as “smart devices”.

## Camera Settings

The explanations in this manual assume that default settings are used.



### **For Your Safety**







Before using the camera for the first time, read the safety instructions in “For Your Safety” (□ xxiii).

# Table of Contents

Package Contents .....	iv
Menu List .....	xix
For Your Safety .....	xxiii
Notices.....	xxvii

## **Getting to Know the Camera** **1**

---



























<b>Parts of the Camera</b> .....	<b>1</b>
Camera Body .....	1
The Monitor and Viewfinder.....	5
<b>Camera Controls</b> .....	<b>7</b>
The Viewfinder.....	7
The Monitor Mode Button.....	8
The Mode Dial.....	9
The Command Dials .....	9
The <b>ISO</b> (ISO Sensitivity) Button .....	10
The  (Exposure Compensation) Button.....	11
Touch Controls .....	12
The <b>DISP</b> Button.....	18
The  and  /? Buttons.....	20
The  (  ) Button .....	20
The <b>MENU</b> Button.....	21
The <b>i</b> Button (  Icon).....	24
The Function Buttons ( <b>Fn1</b> and <b>Fn2</b> ).....	27
The Flash Pop-Up Control.....	29

## **First Steps** **30**

---

<b>Attach the Camera Strap</b> .....	<b>30</b>
<b>Charge the Battery</b> .....	<b>31</b>
The Battery Charger .....	31

Insert the Battery and a Memory Card .....	32
Attach a Lens .....	36
Turn the Camera On .....	38
<b>Basic Photography and Playback</b> .....	<b>40</b>
<hr/>	
Taking Photographs (AUTO Mode) .....	40
Shooting Movies (AUTO Mode) .....	44
Basic Playback .....	48
Viewing Movies .....	48
Deleting Unwanted Pictures .....	50
<b>Basic Settings</b> .....	<b>51</b>
<hr/>	
Focus .....	51
Choosing a Focus Mode .....	51
AF-Area Mode .....	54
The Touch Shutter .....	63
Manual Focus .....	65
White Balance .....	67
Silent Photography .....	71
Rating Pictures .....	73
Protecting Pictures from Deletion .....	74
<b>Shooting Controls</b> .....	<b>75</b>
<hr/>	
The Mode Dial .....	75
P: Programmed Auto .....	76
S: Shutter-Priority Auto .....	76
A: Aperture-Priority Auto .....	77
M: Manual .....	78
User Settings: <b>U1</b> and <b>U2</b> Modes .....	82

<b>SCN (Scene Modes)</b> .....	84
 Portrait .....	85
 Landscape.....	85
 Child.....	85
 Sports.....	86
 Close up.....	86
 Night Portrait.....	86
 Night Landscape .....	87
 Party/Indoor .....	87
 Beach/Snow .....	87
 Sunset.....	88
 Dusk/Dawn.....	88
 Pet Portrait .....	88
 Candlelight.....	89
 Blossom.....	89
 Autumn Colors .....	89
 Food .....	90
<b>EFCT (Special Effect Modes)</b> .....	91
 Night Vision.....	92
<b>VI</b> Super Vivid.....	92
<b>POP</b> Pop .....	92
 Photo Illustration.....	93
 Toy Camera Effect .....	93
 Miniature Effect .....	94
 Selective Color .....	94
 Silhouette.....	95
 High Key .....	95
 Low Key .....	95
<b>The ISO (ISO Sensitivity) Button</b> .....	100
Auto ISO Sensitivity Control .....	101
<b>The  (Exposure Compensation) Button</b> .....	102
<b>The  (AE-L) Button</b> .....	104
Autoexposure (AE) Lock .....	104
Focus Lock .....	104

<b>The Built-In Flash</b> .....	<b>107</b>
Flash Modes.....	108
Flash Compensation.....	111
FV Lock.....	112
<b>The <i>i</i> Menu</b> .....	<b>114</b>
<hr/>	
<b>Using the <i>i</i> Menu</b> .....	<b>114</b>
<b>The Photo-Mode <i>i</i> Menu</b> .....	<b>115</b>
Set Picture Control.....	116
White Balance.....	120
Image Quality.....	126
Image Size.....	128
Flash Mode.....	129
Metering.....	131
Wi-Fi Connection.....	132
Active D-Lighting.....	133
Release Mode.....	135
Optical VR.....	139
AF-Area Mode.....	140
Focus Mode.....	140
<b>The Movie-Mode <i>i</i> Menu</b> .....	<b>141</b>
Set Picture Control.....	142
White Balance.....	142
Frame Size, Frame Rate, and Movie Quality.....	143
Microphone Sensitivity.....	145
Wind Noise Reduction.....	146
Metering.....	147
Wi-Fi Connection.....	147
Active D-Lighting.....	147
Electronic VR.....	147
Optical VR.....	148
AF-Area Mode.....	148
Focus Mode.....	148

---

<b>Viewing Pictures .....</b>	<b>149</b>
Full-Frame Playback .....	149
Thumbnail Playback.....	150
<b>Photo Information.....</b>	<b>151</b>
<b>The <i>i</i> Button: Playback.....</b>	<b>159</b>
Select to Send/Deselect .....	161
Choose Start/End Point.....	162
Save Current Frame .....	165
<b>Taking a Closer Look: Playback Zoom .....</b>	<b>166</b>
<b>Deleting Pictures .....</b>	<b>168</b>
During Playback.....	168
The Playback Menu .....	169

---

<b>Defaults .....</b>	<b>171</b>
<b>▶ The Playback Menu: Managing Images .....</b>	<b>182</b>
Delete .....	183
Playback Folder.....	183
Playback Display Options.....	183
Image Review .....	184
After Delete .....	184
Rotate Tall .....	185
Slide Show .....	186
Rating .....	187
<b>📷 The Photo Shooting Menu: Shooting Options .....</b>	<b>188</b>
Reset Photo Shooting Menu .....	189
Storage Folder.....	189
File Naming .....	193
Choose Image Area .....	193
Image Quality .....	194
Image Size.....	194
NEF (RAW) Recording .....	195



ISO Sensitivity Settings .....	196
White Balance .....	198
Set Picture Control .....	204
Manage Picture Control .....	206
Color Space .....	209
Active D-Lighting.....	209
Long Exposure NR .....	210
High ISO NR .....	210
Vignette Control .....	211
Diffraction Compensation.....	211
Auto Distortion Control.....	211
Flicker Reduction Shooting.....	212
Metering .....	212
Flash Control .....	213
Flash Mode.....	215
Flash Compensation.....	216
Release Mode .....	216
Focus Mode .....	216
AF-Area Mode .....	216
Optical VR .....	216
Auto Bracketing .....	217
Multiple Exposure .....	227
HDR (High Dynamic Range).....	234
Interval Timer Shooting .....	239
Time-Lapse Movie .....	249
Silent Photography .....	256
<b>▶ The Movie Shooting Menu: Movie Shooting Options ...</b>	<b>257</b>
Reset Movie Shooting Menu .....	258
File Naming.....	258
Frame Size/Frame Rate.....	258
Movie Quality .....	258
Movie File Type .....	258
ISO Sensitivity Settings.....	259
White Balance .....	259

Set Picture Control.....	260
Manage Picture Control.....	260
Active D-Lighting .....	260
High ISO NR.....	260
Vignette Control.....	261
Diffraction Compensation .....	261
Auto Distortion Control .....	261
Flicker Reduction.....	261
Metering.....	262
Release Mode (Save Frame) .....	262
Focus Mode.....	262
AF-Area Mode.....	262
Optical VR.....	263
Electronic VR.....	263
Microphone Sensitivity .....	263
Attenuator .....	264
Frequency Response.....	264
Wind Noise Reduction.....	264
 <b>Custom Settings: Fine-Tuning Camera Settings.....</b>	<b>265</b>
Reset Custom Settings .....	268
a: Autofocus.....	269
a1: AF-C Priority Selection.....	269
a2: Auto-Area AF Face/Eye Detection.....	269
a3: Focus Points Used .....	270
a4: AF Activation.....	270
a5: Focus Point Wrap-Around.....	270
a6: Focus Point Options .....	271
a7: Low-Light AF.....	271
a8: Built-in AF-Assist Illuminator.....	272
a9: Manual Focus Ring in AF Mode.....	273



b: Metering/Exposure .....	274
b1: EV Steps for Exposure Cntrl .....	274
b2: Easy Exposure Compensation .....	274
b3: Center-Weighted Area .....	275
b4: Fine-Tune Optimal Exposure .....	275
c: Timers/AE Lock .....	276
c1: Shutter-Release Button AE-L.....	276
c2: Self-Timer.....	276
c3: Power Off Delay.....	277
d: Shooting/Display.....	278
d1: CL Mode Shooting Speed.....	278
d2: Max. Continuous Release .....	278
d3: Exposure Delay Mode.....	278
d4: Shutter Type.....	279
d5: Limit Selectable Image Area.....	279
d6: File Number Sequence.....	280
d7: Apply Settings to Live View.....	281
d8: Framing Grid Display .....	281
d9: Peaking Highlights.....	281
d10: View All in Continuous Mode .....	281
e: Bracketing/Flash .....	282
e1: Flash Sync Speed .....	282
e2: Flash Shutter Speed.....	283
e3: Exposure Comp. for Flash.....	283
e4: Auto ⚡ ISO Sensitivity Control .....	283
e5: Bracketing Order.....	284
f: Controls.....	285
f1: Customize  Menu .....	285
f2: Custom Controls (Shooting).....	286
f3: Custom Controls (Playback).....	292
f4: Customize Command Dials.....	294
f5: Release Button to Use Dial .....	296
f6: Reverse Indicators .....	296

g: Movie .....	297
g1: Customize  Menu .....	297
g2: Custom Controls .....	298
g3: AF Speed .....	303
g4: AF Tracking Sensitivity .....	303
g5: Highlight Display .....	304
<b>Y The Setup Menu: Camera Setup .....</b>	<b>305</b>
Format Memory Card .....	306
Save User Settings .....	306
Reset User Settings .....	306
Language .....	306
Time Zone and Date .....	307
Monitor Brightness .....	307
Viewfinder Brightness .....	308
Viewfinder Color Balance .....	309
Information Display .....	310
AF Fine-Tune .....	311
Image Dust Off Ref Photo .....	312
Image Comment .....	314
Copyright Information .....	315
Beep Options .....	316
Touch Controls .....	316
Self-Portrait Mode .....	317
HDMI .....	317
Location Data Display .....	317
Airplane Mode .....	317
Connect to Smart Device .....	318
Connect to PC .....	320
Wireless Remote (ML-L7) Options .....	323
Conformity Marking .....	324
Energy Saving .....	325
Slot Empty Release Lock .....	325
Reset All Settings .....	326
Firmware Version .....	326

 <b>The Retouch Menu: Creating Retouched Copies .....</b>	<b>327</b>
NEF (RAW) Processing.....	330
Trim.....	333
Resize .....	334
D-Lighting .....	336
Quick Retouch .....	336
Red-Eye Correction .....	337
Straighten.....	337
Distortion Control.....	338
Perspective Control .....	339
Image Overlay.....	340
Trim Movie .....	343
Side-by-Side Comparison .....	343
 <b>My Menu/ Recent Settings.....</b>	<b>345</b>

## **Establishing Wireless Connections to Computers or Smart Devices**

**350**

---

<b>Network Options .....</b>	<b>350</b>
<b>Connecting to Computers via Wi-Fi.....</b>	<b>351</b>
What Wi-Fi Can Do for You.....	351
The Wireless Transmitter Utility .....	351
Infrastructure and Access-Point Modes.....	352
Connecting in Access-Point Mode .....	353
Connecting in Infrastructure Mode.....	357
Uploading Pictures.....	364
Disconnecting and Reconnecting .....	368
<b>Connecting to Smart Devices .....</b>	<b>369</b>
The SnapBridge App.....	369
What SnapBridge Can Do for You.....	369
Wireless Connections .....	370
Connecting via Wi-Fi (Wi-Fi Mode).....	371
Connecting via Bluetooth.....	377
<b>Troubleshooting.....</b>	<b>390</b>

---

**Connecting to Other Devices** **391**

---

<b>Connecting to Computers Via USB</b> .....	<b>391</b>
Installing NX Studio .....	392
Copying Pictures to a Computer Using NX Studio.....	393
<b>Connecting to Printers</b> .....	<b>396</b>
Printing Pictures One at a Time.....	397
Printing Multiple Pictures.....	398
<b>Connecting to HDMI Devices</b> .....	<b>399</b>
Connecting to Other HDMI Devices .....	400

---

**On-Camera Flash Photography** **401**

---

<b>“On-Camera” Versus “Remote”</b> .....	<b>401</b>
Camera-Mounted Flash Units.....	401
Remote Flash Photography .....	401
<b>Using an On-Camera Flash</b> .....	<b>402</b>
Flash Control Mode.....	404

---

**Remote Flash Photography** **405**

---

<b>About Remote Flash Photography</b> .....	<b>405</b>
<b>Controlling Remote Flash Units</b> .....	<b>406</b>
Using the SB-500 .....	406

---

**Troubleshooting** **409**

---

<b>Before Contacting Customer Support</b> .....	<b>409</b>
<b>Problems and Solutions</b> .....	<b>410</b>
Battery/Display.....	410
Shooting.....	411
Playback.....	415
Bluetooth and Wi-Fi (Wireless Networks).....	416
Miscellaneous .....	416
<b>Indicators and Error Messages</b> .....	<b>417</b>
Indicators.....	417
Error Messages .....	419

---

<b>Compatible Lenses</b> .....	<b>422</b>
<b>The Camera Display</b> .....	<b>423</b>
The Monitor: Photo Mode .....	423
The Monitor: Movie Mode .....	428
The Viewfinder: Photo Mode.....	429
The Viewfinder: Movie Mode.....	431
<b>The Nikon Creative Lighting System</b> .....	<b>432</b>
<b>Other Accessories</b> .....	<b>437</b>
Charging AC Adapters .....	439
<b>Software</b> .....	<b>442</b>
<b>Caring for the Camera</b> .....	<b>443</b>
Storage .....	443
Cleaning .....	443
Cleaning the Image Sensor .....	444
<b>Caring for the Camera and Battery: Cautions</b> .....	<b>446</b>
<b>Specifications</b> .....	<b>451</b>
<b>Approved Memory Cards</b> .....	<b>462</b>
<b>Memory Card Capacity</b> .....	<b>463</b>
<b>Battery Endurance</b> .....	<b>464</b>
<b>NIKKOR Z DX 16–50mm f/3.5–6.3 VR Lens</b>	
User’s Manual .....	465
<b>NIKKOR Z DX 50–250mm f/4.5–6.3 VR Lens</b>	
User’s Manual .....	475
<b>Lenses That May Block the Built-in Flash and AF-Assist</b>	
Illuminator.....	485
<b>Trademarks and Licenses</b> .....	<b>487</b>
<b>Index</b> .....	<b>490</b>

---

<b>Updating Camera Firmware .....</b>	<b>497</b>
<b>Features Available with "C" Firmware Version 2.10 .....</b>	<b>497</b>
Saving the Focus Position .....	497
<b>Features Available with "C" Firmware Version 2.30 .....</b>	<b>498</b>
New Options for Custom Setting f2 "Custom Controls (Shooting)": "Save Focus Position" and "Recall Focus Position" .....	498
<b>Features Available with "C" Firmware Version 2.40 .....</b>	<b>501</b>
Support for Eye-Detection AF in Movie Mode.....	501
<b>Features Available with "C" Firmware Version 2.50 .....</b>	<b>502</b>
Support for Power Zoom Lenses .....	502

## Menu List

The camera offers the following menus. For a more complete description of individual menu items, refer to the “Menu Guide” chapter in the *Reference Manual*.

### PLAYBACK MENU

- Delete
- Playback folder
- Playback display options
- Image review
- After delete
- Rotate tall
- Slide show
- Rating

### PHOTO SHOOTING MENU

- Reset photo shooting menu
- Storage folder
- File naming
- Choose image area
- Image quality
- Image size
- NEF (RAW) recording
- ISO sensitivity settings
- White balance
- Set Picture Control
- Manage Picture Control
- Color space

### PHOTO SHOOTING MENU

- Active D-Lighting
- Long exposure NR
- High ISO NR
- Vignette control
- Diffraction compensation
- Auto distortion control
- Flicker reduction shooting
- Metering
- Flash control
- Flash mode
- Flash compensation
- Release mode
- Focus mode
- AF-area mode
- Optical VR
- Auto bracketing
- Multiple exposure
- HDR (high dynamic range)
- Interval timer shooting
- Time-lapse movie
- Silent photography

<b>MOVIE SHOOTING MENU</b>
Reset movie shooting menu
File naming
Frame size/frame rate
Movie quality
Movie file type
ISO sensitivity settings
White balance
Set Picture Control
Manage Picture Control
Active D-Lighting
High ISO NR
Vignette control
Diffraction compensation
Auto distortion control
Flicker reduction
Metering
Release mode (save frame)
Focus mode
AF-area mode
Optical VR
Electronic VR
Microphone sensitivity
Attenuator
Frequency response
Wind noise reduction

<b>CUSTOM SETTING MENU</b>
Reset custom settings
a Autofocus
a1 AF-C priority selection
a2 Auto-area AF face/eye detection
a3 Focus points used
a4 AF activation
a5 Focus point wrap-around
a6 Focus point options
a7 Low-light AF
a8 Built-in AF-assist illuminator
a9 Manual focus ring in AF mode
b Metering/exposure
b1 EV steps for exposure cntrl
b2 Easy exposure compensation
b3 Center-weighted area
b4 Fine-tune optimal exposure
c Timers/AE lock
c1 Shutter-release button AE-L
c2 Self-timer
c3 Power off delay



**CUSTOM SETTING MENU****d Shooting/display**

- |     |                             |
|-----|-----------------------------|
| d1  | CL mode shooting speed      |
| d2  | Max. continuous release     |
| d3  | Exposure delay mode         |
| d4  | Shutter type                |
| d5  | Limit selectable image area |
| d6  | File number sequence        |
| d7  | Apply settings to live view |
| d8  | Framing grid display        |
| d9  | Peaking highlights          |
| d10 | View all in continuous mode |

**e Bracketing/flash**

- |    |  |
|----|--|
| e1 | Flash sync speed   |
| e2 | Flash shutter speed  |
| e3 | Exposure comp. for flash   |
| e4 | Auto  ISO sensitivity control |
| e5 | Bracketing order   |

**CUSTOM SETTING MENU****f Controls**

- |    |  |
|----|--|
| f1 | Customize  menu |
| f2 | Custom controls (shooting)   |
| f3 | Custom controls (playback)   |
| f4 | Customize command dials  |
| f5 | Release button to use dial   |
| f6 | Reverse indicators   |

**g Movie**

- |    |  |
|----|--|
| g1 | Customize  menu |
| g2 | Custom controls  |
| g3 | AF speed   |
| g4 | AF tracking sensitivity  |
| g5 | Highlight display  |

**SETUP MENU**

Format memory card  
Save user settings  
Reset user settings  
Language  
Time zone and date  
Monitor brightness  
Viewfinder brightness  
Viewfinder color balance  
Information display  
AF fine-tune  
Image Dust Off ref photo  
Image comment  
Copyright information  
Beep options  
Touch controls  
Self-portrait mode  
HDMI  
Location data display  
Airplane mode  
Connect to smart device  
Connect to PC  
Wireless remote (ML-L7) options  
Conformity marking  
Energy saving  
Slot empty release lock  
Reset all settings  
Firmware version

**RETOUCH MENU**

NEF (RAW) processing  
Trim  
Resize  
D-Lighting  
Quick retouch  
Red-eye correction  
Straighten  
Distortion control  
Perspective control  
Image overlay  
Trim movie  
Side-by-side comparison \*

**MY MENU**

Add items  
Remove items  
Rank items  
Choose tab

\* Can only be displayed by pressing **i** and selecting **Retouch** when a retouched image or original is displayed.

## For Your Safety

To prevent damage to property or injury to yourself or to others, read “For Your Safety” in its entirety before using this product.

Keep these safety instructions where all those who use this product will read them.

**⚠ DANGER:** Failure to observe the precautions marked with this icon carries a high risk of death or severe injury.

**⚠ WARNING:** Failure to observe the precautions marked with this icon could result in death or severe injury.

**⚠ CAUTION:** Failure to observe the precautions marked with this icon could result in injury or property damage.



### WARNING

- **Do not use while walking or operating a vehicle.**

Failure to observe this precaution could result in accidents or other injury.

- **Do not disassemble or modify this product. Do not touch internal parts that become exposed as the result of a fall or other accident.**

Failure to observe these precautions could result in electric shock or other injury.

- **Should you notice any abnormalities such as the product producing smoke, heat, or unusual odors, immediately disconnect the battery or power source.**

Continued operation could result in fire, burns or other injury.

- **Keep dry. Do not handle with wet hands. Do not handle the plug with wet hands.**

Failure to observe these precautions could result in fire or electric shock.

- **Do not let your skin remain in prolonged contact with this product while it is on or plugged in.**

Failure to observe this precaution could result in low-temperature burns.

- **Do not use this product in the presence of flammable dust or gas such as propane, gasoline or aerosols.**

Failure to observe this precaution could result in explosion or fire.

- **Do not directly view the sun or other bright light source through the lens.**

Failure to observe this precaution could result in visual impairment.

---

- **Do not aim the flash or AF-assist illuminator at the operator of a motor vehicle.**

Failure to observe this precaution could result in accidents.

---

- **Keep this product out of reach of children.**

Failure to observe this precaution could result in injury or product malfunction. In addition, note that small parts constitute a choking hazard. Should a child swallow any part of this product, seek immediate medical attention.

---

- **Do not entangle, wrap or twist the straps around your neck.**

Failure to observe this precaution could result in accidents.

---

- **Do not use batteries, chargers, AC adapters, or USB cables not specifically designated for use with this product. When using batteries, chargers, AC adapters, and USB cables designated for use with this product, do not:**

- **Damage, modify, forcibly tug or bend the cords or cables, place them under heavy objects, or expose them to heat or flame.**
- **Use travel converters or adapters designed to convert from one voltage to another or with DC-to-AC inverters.**

Failure to observe these precautions could result in fire or electric shock.

---

- **Do not handle the plug when charging the product or using the AC adapter during thunderstorms.**

Failure to observe this precaution could result in electric shock.

---

- **Do not handle with bare hands in locations exposed to extremely high or low temperatures.**

Failure to observe this precaution could result in burns, or frostbite.

---



## CAUTION

- **Do not leave the lens pointed at the sun or other strong light sources.**

Light focused by the lens could cause fire or damage to product's internal parts. When shooting backlit subjects, keep the sun well out of the frame. Sunlight focused into the camera when the sun is close to the frame could cause fire.

---

- **Turn this product off when its use is prohibited. Disable wireless features when the use of wireless equipment is prohibited.**

The radio-frequency emissions produced by this product could interfere with equipment onboard aircraft or in hospitals or other medical facilities.

---

- **Remove the battery and disconnect the AC adapter if this product will not be used for an extended period.**

Failure to observe this precaution could result in fire or product malfunction.

---

- **Do not fire the flash in contact with or in close proximity to the skin or objects.**

Failure to observe this precaution could result in burns or fire.

---

- **Do not leave the product where it will be exposed to extremely high temperatures, for an extended period such as in an enclosed automobile or in direct sunlight.**

Failure to observe this precaution could result in fire or product malfunction.

---

- **Do not look directly at the AF-assist illuminator.**

Failure to observe this precaution could have adverse effects on vision.

---

- **Do not transport cameras or lenses with tripods or similar accessories attached.**

Failure to observe this precaution could result in injury or product malfunction.

---



## **DANGER (Batteries)**

- **Do not mishandle batteries.**

Failure to observe the following precautions could result in the batteries leaking, overheating, rupturing, or catching fire:

- Use only rechargeable batteries approved for use in this product.
  - Do not expose batteries to flame or excessive heat.
  - Do not disassemble.
  - Do not short-circuit the terminals by touching them to necklaces, hairpins, or other metal objects.
  - Do not expose batteries or the products in which they are inserted to powerful physical shocks.
  - Do not step on batteries, pierce them with nails, or strike them with hammers.
-

- **Charge only as indicated.**

Failure to observe this precaution could result in the batteries leaking, overheating, rupturing, or catching fire.

---

- **If battery liquid comes into contact with the eyes, rinse with plenty of clean water and seek immediate medical attention.**

Delaying action could result in eye injuries.

---

- **Follow the instructions of airline personnel.**

Batteries left unattended at high altitudes in an unpressurized environment may leak, overheat, rupture, or catch fire.

---



## **WARNING (Batteries)**

- **Keep batteries out of reach of children.**

Should a child swallow a battery, seek immediate medical attention.

---

- **Keep batteries out of reach of household pets and other animals.**

The batteries could leak, overheat, rupture, or catch fire if bitten, chewed, or otherwise damaged by animals.

---

- **Do not immerse batteries in water or expose to rain.**

Failure to observe this precaution could result in fire or product malfunction. Immediately dry the product with a towel or similar object should it become wet.

---

- **Discontinue use immediately should you notice any changes in the batteries, such as discoloration or deformation. Cease charging EN-EL25 rechargeable batteries if they do not charge in the specified period of time.**

Failure to observe these precautions could result in the batteries leaking, overheating, rupturing, or catching fire.

---

- **When batteries are no longer needed, insulate the terminals with tape.**

Overheating, rupture, or fire may result should metal objects come into contact with the terminals.

---

- **If battery liquid comes into contact with a person's skin or clothing, immediately rinse the affected area with plenty of clean water.**

Failure to observe this precaution could result in skin irritation.

---

## Notices

- No part of the manuals included with this product may be reproduced, transmitted, transcribed, stored in a retrieval system, or translated into any language in any form, by any means, without Nikon's prior written permission.
- Nikon reserves the right to change the appearance and specifications of the hardware and software described in these manuals at any time and without prior notice.
- Nikon will not be held liable for any damages resulting from the use of this product.
- While every effort has been made to ensure that the information in these manuals is accurate and complete, we would appreciate it were you to bring any errors or omissions to the attention of the Nikon representative in your area (address provided separately).

## **Notice Concerning Prohibition of Copying or Reproduction**

Note that simply being in possession of material that has been digitally copied or reproduced by means of a scanner, digital camera, or other device may be punishable by law.

### **• Items prohibited by law from being copied or reproduced**

Do not copy or reproduce paper money, coins, securities, government bonds, or local government bonds, even if such copies or reproductions are stamped “Sample.”

The copying or reproduction of paper money, coins, or securities which are circulated in a foreign country is prohibited.

Unless the prior permission of the government has been obtained, the copying or reproduction of unused postage stamps or post cards issued by the government is prohibited.

The copying or reproduction of stamps issued by the government and of certified documents stipulated by law is prohibited.

### **• Cautions on certain copies and reproductions**

The government has issued cautions on copies or reproductions of securities issued by private companies (shares, bills, checks, gift certificates, etc.), commuter passes, or coupon tickets, except when a minimum of necessary copies are to be provided for business use by a company. Also, do not copy or reproduce passports issued by the government, licenses issued by public agencies and private groups, ID cards, and tickets, such as passes and meal coupons.

### **• Comply with copyright notices**

Under copyright law, photographs or recordings of copyrighted works made with the camera cannot be used without the permission of the copyright holder. Exceptions apply to personal use, but note that even personal use may be restricted in the case of photographs or recordings of exhibits or live performances.



## **Use Only Nikon Brand Electronic Accessories**

Nikon cameras are designed to the highest standards and include complex electronic circuitry. Only Nikon brand electronic accessories (including lenses, chargers, batteries, charging AC adapters, and flash accessories) certified by Nikon specifically for use with this Nikon digital camera are engineered and proven to operate within the operational and safety requirements of this electronic circuitry.

The use of non-Nikon electronic accessories could damage the camera and may void your Nikon warranty. The use of third-party rechargeable Li-ion batteries not bearing the Nikon holographic seal shown at right could interfere with normal operation of the camera or result in the batteries overheating, igniting, rupturing, or leaking.

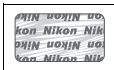

For more information about Nikon brand accessories, contact a local authorized Nikon dealer.

### **✔ Before Taking Important Pictures**

Before taking pictures on important occasions (such as at weddings or before taking the camera on a trip), take a test shot to ensure that the camera is functioning normally. Nikon will not be held liable for damages or lost profits that may result from product malfunction.

### **✔ Life-Long Learning**

As part of Nikon's "Life-Long Learning" commitment to ongoing product support and education, continually-updated information is available on-line at the following sites:

- **For users in the U.S.A.:** <https://www.nikonusa.com/>
- **For users in Europe:** <https://www.europe-nikon.com/support/>
- **For users in Asia, Oceania, the Middle East, and Africa:**  
<https://www.nikon-asia.com/>

Visit these sites to keep up-to-date with the latest product information, tips, answers to frequently-asked questions (FAQs), and general advice on digital imaging and photography. Additional information may be available from the Nikon representative in your area. See the following URL for contact information: <https://imaging.nikon.com/>



# Getting to Know the Camera

Take a few minutes to familiarize yourself with the names and functions of camera controls and displays. You may find it helpful to bookmark this section and refer to it as you read through the rest of the manual.

## Parts of the Camera

Refer to this section for the names and locations of camera controls and displays.

### Camera Body

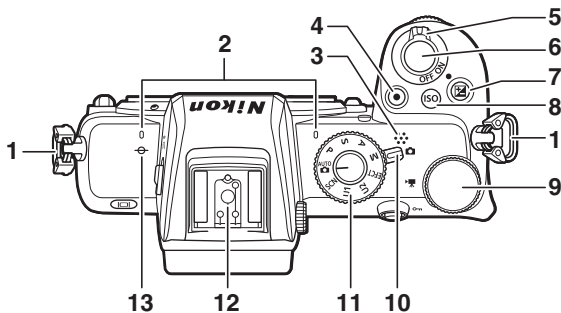

1	Eyelet for camera strap.....	30	8	ISO button .....	100
2	Stereo microphone.....	45	9	Main command dial .....	9
3	Speaker.....	49	10	Photo/movie selector .....	40, 44
4	Movie-record button .....	44	11	Mode dial.....	75
5	Power switch.....	38, 40	12	Accessory shoe (for optional flash unit).....	402, 432
6	Shutter-release button .....	40	13	Focal plane mark (⊖).....	66
7	☒ button.....	102			

## The Camera Body (Continued)

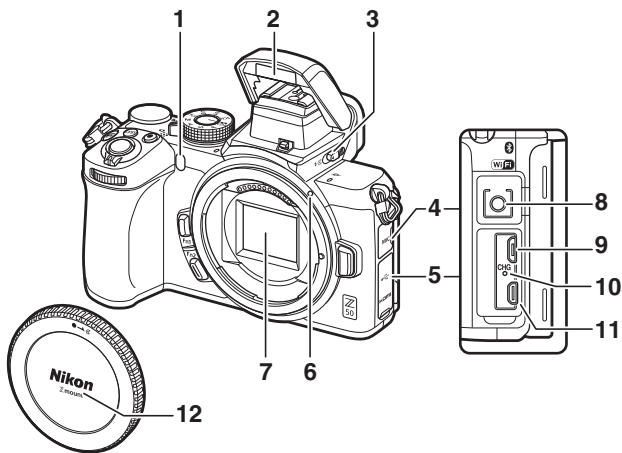

- |   |   |
|---|---|
| <p><b>1</b> AF-assist illuminator .....42, 272<br/>Red-eye reduction lamp... 108, 129<br/>Self-timer lamp ..... 138</p> | <p><b>6</b> Lens mounting mark .....36</p>                      |
| <p><b>2</b> Built-in flash .....29, 107</p>   | <p><b>7</b> Image sensor ..... 444</p>                          |
| <p><b>3</b> Flash pop-up control .....29, 107</p>   | <p><b>8</b> Connector for external<br/>microphone ..... 437</p> |
| <p><b>4</b> Cover for microphone connector</p>  | <p><b>9</b> USB connector ..... 391, 396</p>                    |
| <p><b>5</b> Cover for USB and HDMI<br/>connectors</p>   | <p><b>10</b> Charge lamp ..... 440</p>                          |
|   | <p><b>11</b> HDMI connector ..... 399</p>                       |
|   | <p><b>12</b> Body cap .....36, 437</p>                          |

### **✓ Do Not Touch the Image Sensor**

Under no circumstances should you exert pressure on the image sensor, poke it with cleaning tools, or subject it to powerful air currents from a blower. These actions could scratch or otherwise damage the sensor. For information on cleaning the image sensor, see “Cleaning the Image Sensor” (□ 444).

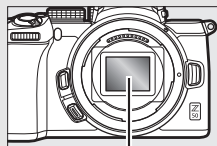

*Image sensor*

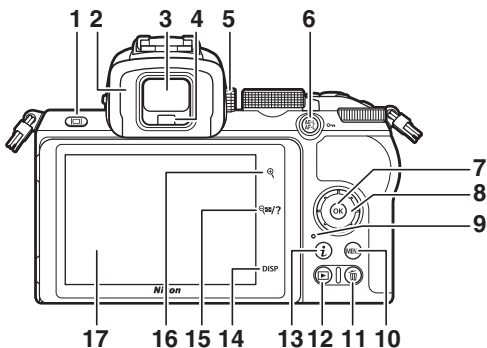

<b>1</b> Monitor mode button.....8	<b>10</b> MENU button..... 21, 171
<b>2</b> Viewfinder eyepiece.....438	<b>11</b> button ..... 50
<b>3</b> Viewfinder .....7	<b>12</b> button ..... 48
<b>4</b> Eye sensor .....7	<b>13</b> button..... 24, 114
<b>5</b> Diopter adjustment control .....7	<b>14</b> DISP button..... 18
<b>6</b> AE-L/AF-L () button .....20, 74, 104	<b>15</b> button..... 20, 23, 49, 150
<b>7</b> OK button ..... 21	<b>16</b> button ..... 20, 49, 65, 149, 166
<b>8</b> Multi selector ..... 21	<b>17</b> Monitor ..... 12, 63
<b>9</b> Memory card access lamp.... 43, 137	

**✓ The Monitor**

The angle of the monitor can be adjusted as shown.

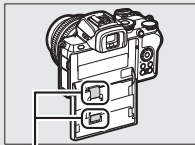
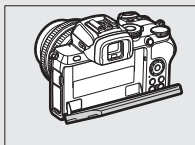

*Touching these parts could damage the product.*

## The Camera Body (Continued)

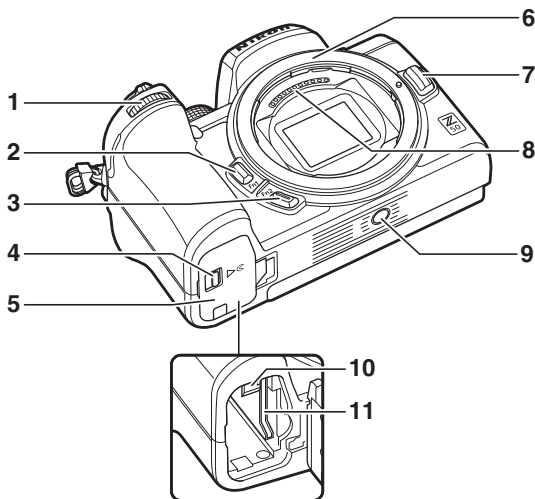

<b>1</b> Sub-command dial .....9, 294	<b>7</b> Lens release button .....37
<b>2</b> Fn1 button .....27, 67, 286, 298	<b>8</b> CPU contacts
<b>3</b> Fn2 button .....27, 51, 286, 298	<b>9</b> Tripod socket .....80
<b>4</b> Battery-chamber cover latch .....32	<b>10</b> Battery latch .....32
<b>5</b> Battery-chamber cover .....32	<b>11</b> Memory card slot .....32
<b>6</b> Lens mount .....36	

### **✔ Product Serial Number**

The serial number for this product can be found by opening the monitor.

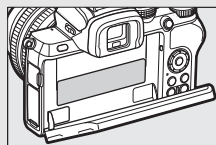

## The Monitor and Viewfinder

At default settings, the following indicators appear in the monitor and viewfinder in photo mode; for a full list of indicators, see “The Camera Display” (📖 423).

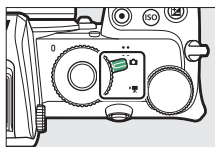

### Monitor

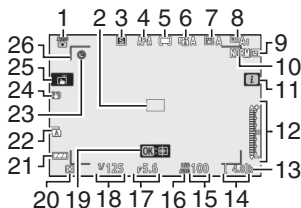

### Viewfinder

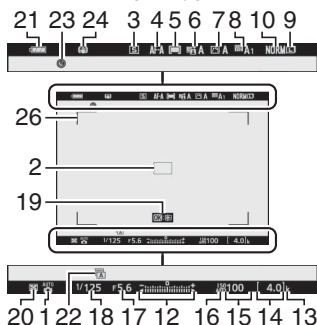

<b>1</b> Shooting mode .....	75	<b>12</b> Exposure indicator .....	79
<b>2</b> Focus point.....	42, 54	Exposure compensation display .....	102
<b>3</b> Release mode .....	135	<b>13</b> “k” (appears when memory remains for over 1000 exposures) .....	34
<b>4</b> Focus mode .....	51	<b>14</b> Number of exposures remaining .....	34, 463
<b>5</b> AF-area mode .....	54	<b>15</b> ISO sensitivity .....	100
<b>6</b> Active D-Lighting.....	133	<b>16</b> ISO sensitivity indicator .....	100
<b>7</b> Picture Control.....	116, 204	Auto ISO sensitivity indicator ..	101
<b>8</b> White balance.....	67, 120, 198		
<b>9</b> Image size.....	128, 194		
<b>10</b> Image quality.....	126, 194		
<b>11</b> ? icon.....	16, 24		

<b>17</b> Aperture.....77	<b>22</b> Shutter type..... 279
<b>18</b> Shutter speed .....76, 78	<b>23</b> “Clock not set” indicator .....39
<b>19</b> Subject tracking.....62	<b>24</b> Optical VR indicator ..... 139, 216
<b>20</b> Metering ..... 131, 212, 262	<b>25</b> Touch shooting ..... 12, 63
<b>21</b> Battery indicator .....34	<b>26</b> AF-area brackets.....56

The following items appear in movie mode.

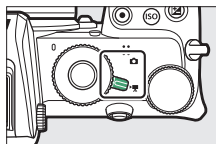

**Monitor**

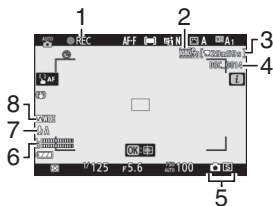

**Viewfinder**

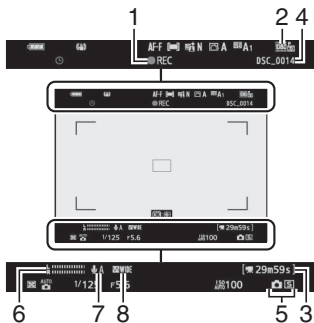

<b>1</b> Recording indicator .....44	<b>5</b> Release mode
Recording disabled .....45	(still photography) ..... 262
<b>2</b> Frame size and rate/ image quality ..... 143, 258	<b>6</b> Sound level ..... 145
<b>3</b> Time remaining.....44	<b>7</b> Microphone sensitivity .... 145, 263
<b>4</b> File name ..... 258	<b>8</b> Frequency response ..... 264



## Camera Controls

This section outlines how to use various camera controls and displays.

### The Viewfinder

Placing your eye to the viewfinder activates the eye sensor, switching the display from the monitor to the viewfinder (note that the eye sensor will also respond to other objects, such as your fingers). The viewfinder can be used for menus and playback if desired.

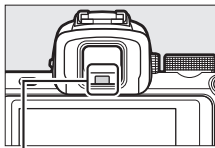

*Eye sensor*

#### **The Diopter Adjustment Control**

To focus the viewfinder, rotate the diopter adjustment control, being careful not to put your fingers or fingernails in your eye.

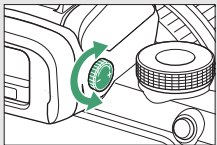

#### **Extended Use**

When using the viewfinder for extended periods, you can adjust viewfinder brightness and hue for ease of viewing by selecting **Off** for Custom Setting d7 (**Apply settings to live view**).

## **The Monitor Mode Button**

Press the monitor mode button to cycle between viewfinder and monitor displays.

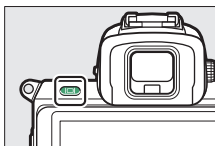

Press the monitor mode button to cycle through the displays as follows.

---

**Automatic display switch:** The display switches from the monitor to the viewfinder when you place your eye to the viewfinder, and from the viewfinder to the monitor when you take your eye away.

---



▼

---

**Viewfinder only:** The viewfinder is used for shooting, menus, and playback; the monitor remains blank.

---



▼

---

**Monitor only:** The monitor is used for shooting, menus, and playback; the viewfinder display will remain blank even if you put your eye to the viewfinder.

---



## The Mode Dial

Rotate the mode dial to choose from the following modes:

- ** Auto:** A “point-and-shoot” mode in which the camera sets exposure and hue (☐ 40, 44).
- **P Programmed auto:** The camera sets shutter speed and aperture for optimal exposure.
- **S Shutter-priority auto:** You choose the shutter speed; the camera selects the aperture for best results.
- **A Aperture-priority auto:** You choose the aperture; the camera selects the shutter speed for best results.
- **M Manual:** You control both shutter speed and aperture.
- **EFCT Special effects:** Take pictures with added special effects.
- **U1/U2 User settings modes:** Assign frequently-used settings.
- **SCN Scene:** Use for subjects of a selected type.

*Mode dial*

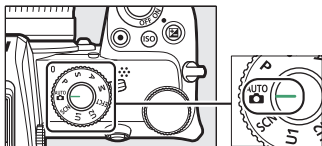

## The Command Dials

Use the command dials to adjust shutter speed or aperture or in combination with other buttons to change camera settings.

*Sub-command dial*

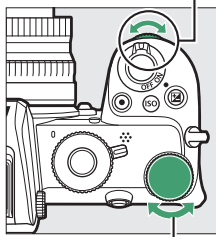

*Main command dial*

## The ISO (ISO Sensitivity) Button

The camera adjusts its sensitivity to light (ISO sensitivity) in response to the lighting conditions in effect at the time the picture is taken.

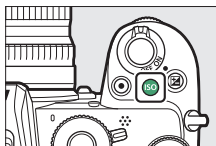

### ■ ■ *Adjusting ISO Sensitivity*

ISO sensitivity can be adjusted in all modes except **AUTO** and **[M]**.

- To adjust ISO sensitivity, hold the **ISO** button and rotate the main command dial.
- Choose from values of from ISO 100 to 51200, or select Hi 1 or Hi 2.
- In modes **P**, **S**, **A**, and **M**, auto ISO sensitivity control can be turned on or off by holding the **ISO** button and rotating the sub-command dial; **ISO AUTO** is displayed when auto ISO sensitivity control is on and **ISO** when it is not. In **SCN** modes and in **EFCT** modes other than **[M]**, auto ISO sensitivity control can be turned on or off by holding the **ISO** button and rotating the main command dial.

### ■ ■ *Movie Mode*

ISO sensitivity adjustment is available only in mode **M**.

- When **Off** is selected for **ISO sensitivity settings > Auto ISO control (mode M)**, ISO sensitivity will be set to the value selected for **ISO sensitivity settings > ISO sensitivity (mode M)**.
- Auto ISO sensitivity control can be turned on or off by holding the **ISO** button and rotating the sub-command dial; **ISO AUTO** is displayed when auto ISO sensitivity control is on and **ISO** when it is not.

## The (Exposure Compensation) Button

Exposure compensation alters exposure from the value chosen by the camera. Use it to make pictures brighter or darker.



*Exposure compensation: -1 EV*



*No exposure compensation*



*Exposure compensation: +1 EV*

- Exposure compensation can be adjusted by holding the  button and rotating either command dial.
- Choose higher values to make the picture brighter, lower values to make it darker.

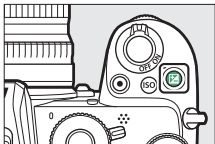

## **Touch Controls**

The touch-sensitive monitor can be used to adjust camera settings, focus and release the shutter, view photos and movies, enter text, and navigate the menus. Touch controls are not available while the viewfinder is in use.

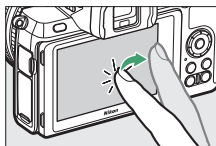

### **■ Focusing and Releasing the Shutter**



Touch the monitor to focus on the selected point (touch AF). In photo mode, the shutter will be released when you lift your finger from the display (touch shutter).

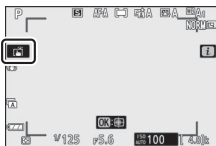

Touch AF settings can be adjusted by tapping the  icon (□ 63).



### **■ Adjusting Settings**

Tap highlighted settings in the display and choose the desired option by tapping icons or sliders. Tap  or press  to select the chosen option and return to the previous display.



## ■ ■ Taking Pictures in Self-Portrait Mode

- Self-portrait mode is selected automatically when the monitor is in the self-portrait position.

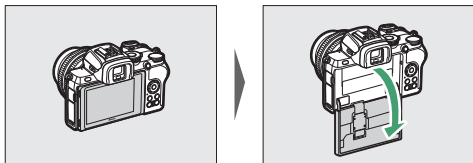

- In self-portrait mode, exposure compensation and self-timer settings can be adjusted using touch controls.
- Tap the self-timer icon to choose the shutter-release delay and the number of pictures taken.
- Tap the exposure compensation icon to adjust exposure.
- Press the shutter-release button halfway to focus. Press it the rest of the way down to take photographs.
- You can also focus and take photographs using touch controls.
- In movie mode, movies can be recorded using the movie-record button.
- To exit self-portrait mode, rotate the monitor out of the self-portrait position.

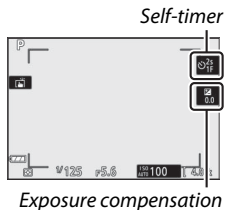

### ✔ Self-Portrait Mode

Note the following:

- Selecting self-portrait mode disables all controls except the power switch, shutter-release button, movie-record button, photo/movie selector, mode dial, and flash pop-up control.
- If the option selected for Custom Setting c3 (**Power off delay**) > **Standby timer** is less than a minute, the timer will expire if no operations are performed for about a minute; otherwise, the timer will expire normally.
- Rotating the monitor to the self-portrait position will not activate self-portrait mode if **Disable** is selected for **Self-portrait mode** (☞ 317).

### ■ Playback

Flick left or right to view other pictures during full-frame playback.

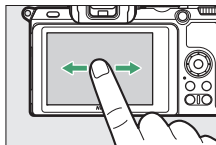

In full-frame view, touching the bottom of the display brings up a frame-advance bar. Slide your finger left or right over the bar to scroll rapidly to other pictures.

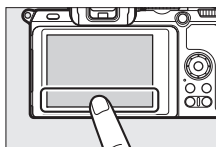

Frame advance bar



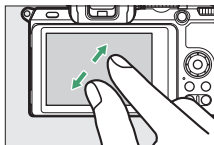

Use stretch and pinch gestures to zoom in and out and slide to scroll. You can also give the display two quick taps to zoom in from full-frame playback or cancel zoom.

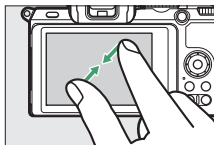

To “zoom out” to a thumbnail view, use a pinch gesture in full-frame playback. Use pinch and stretch to choose the number of images displayed from 4, 9, and 72 frames.



### ■■ **Movie Playback**

Tap the on-screen guide to start movie playback (movies are indicated by a  icon). Tap the display to pause or resume, or tap  to exit to full-frame playback.



Guide

## ■ ■ The *i* Menu

Tap the **i** icon to display the **i** menu during shooting (📖 24, 114).

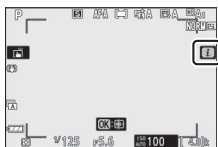

Tap items to view options.

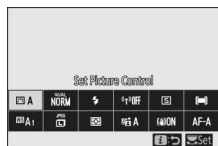

## ■ ■ Text Entry

When a keyboard is displayed, you can enter text by tapping the keys (to cycle through the upper- and lower-case and symbol keyboards, tap the keyboard selection button) or move the cursor by tapping in the text display area.

*Text display area*

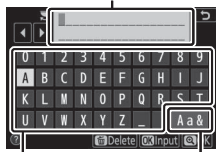

*Keyboard area*

*Keyboard selection*

## ■ Navigating the Menus

Slide up or down to scroll.

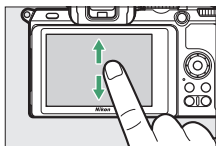

Tap a menu icon to choose a menu.

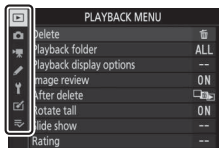

Tap menu items to display options and tap icons or sliders to change.

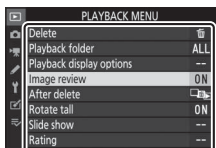

To exit without changing settings, tap ↶.

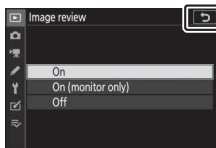

### ✓ The Touch Screen

The touch screen responds to static electricity and may not respond when covered with third-party protective films, when touched with fingernails or gloved hands, or when touched simultaneously in multiple locations. Do not use excessive force or touch the screen with sharp objects.

### ✓ Enabling or Disabling Touch Controls

Touch controls can be enabled or disabled using the **Touch controls** option in the setup menu.

## The DISP Button

Use the **DISP** button to view or hide indicators in the monitor or viewfinder.

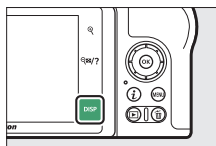

### ■ Photo Mode

In photo mode, tapping the **DISP** button cycles the display as follows:

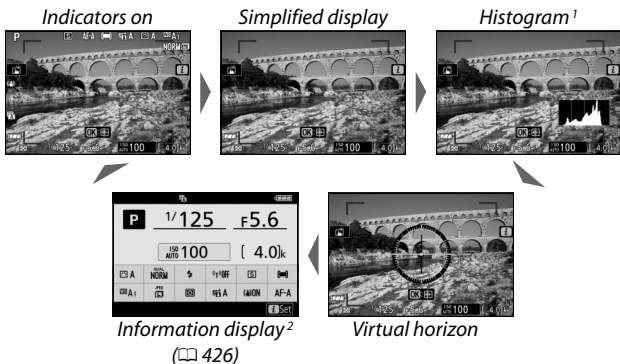



- 1 Not displayed during multiple exposure photography or when **Off** is selected for Custom Setting d7 (**Apply settings to live view**).
- 2 Not displayed in the viewfinder.

## ■■ Movie Mode

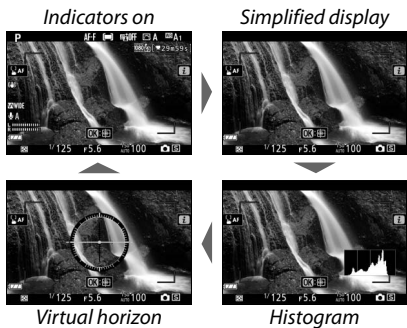
In movie mode, tapping the **DISP** button cycles the display as follows:





## The and /? Buttons

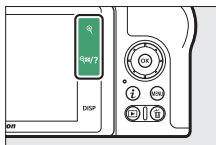



The  and /? buttons are used to zoom the display in the monitor in or out during shooting and playback.



### ■ Shooting

Tap  to zoom in on the display in the monitor. Tap  to increase the zoom ratio, /? to zoom out.

### ■ Playback

Tap  to zoom in on pictures during full-frame playback. Tap  to increase the zoom ratio, /? to zoom out. Tapping /? when the picture is displayed full frame “zooms out” to the thumbnail list.

## The $\overset{AE-L}{AF-L}$ () Button

The  $\overset{AE-L}{AF-L}$  () button can be used during shooting to lock focus and exposure and during playback to protect the current image.

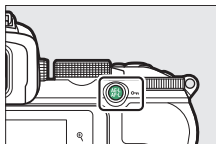

### ■ Shooting

Press the  $\overset{AE-L}{AF-L}$  () button to lock focus and exposure.

### ■ Playback

Protect the current image.

## The MENU Button

Press the MENU button to view the menus.

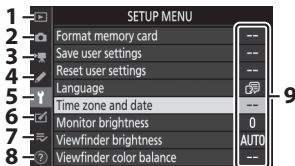
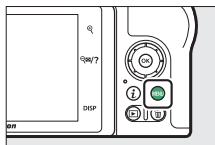

1	▶: Playback menu .....	182
2	📷: Photo shooting menu .....	188
3	🎬: Movie shooting menu .....	257
4	🔧: Custom Settings menu .....	265
5	⚙️: Setup menu .....	305
6	✍️: Retouch menu .....	327
7	🔄/🔄: My Menu or recent settings (defaults to My Menu) .....	345
8	🗉: Help icon .....	23
9	Current settings .....	171

## Using the Menus

You can navigate the menus using the multi selector and OK button.

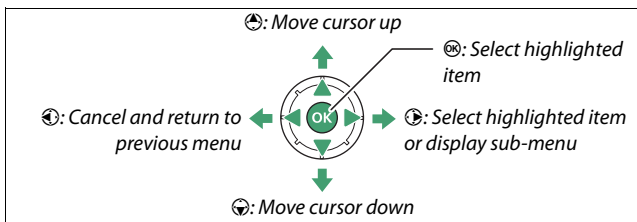

# 1 Highlight the icon for the current menu.

Press  to highlight the icon for the current menu.

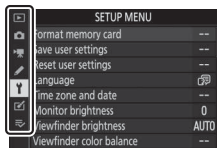

# 2 Select a menu.

Press  or  to select the desired menu.



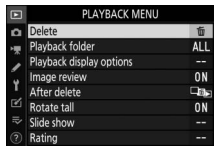

# 3 Position the cursor in the selected menu.

Press  to position the cursor in the selected menu.



# 4 Highlight a menu item.

Press  or  to highlight a menu item (items that are displayed in gray are not currently available and cannot be selected).

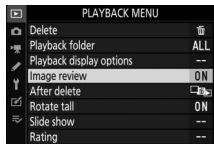



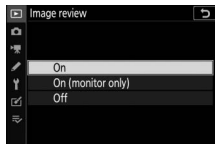

## 5 Display options.

Press  to display options for the selected menu item.



## 6 Highlight an option.

Press  or  to highlight an option (options that are displayed in gray are not currently available and cannot be selected).

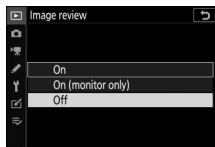





## 7 Select the highlighted item.

Press  to select the highlighted item. To exit without making a selection, press the MENU button. To exit the menus and return to shooting mode, press the shutter-release button halfway.



You can also navigate the menus using touch controls ([book 17](#)).

### The (Help) Icon

If a  icon appears at the bottom left corner of the display, you can view a description of the currently selected option or menu by tapping the  button. Press  or  to scroll the text, or tap  again to return to the menus.

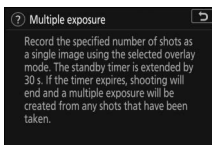
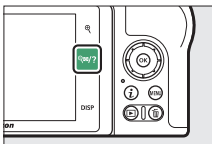

## The *i* Button (*i* Icon)

For quick access to frequently-used settings, press the *i* button or tap the *i* icon in the display.



Tap the desired item or highlight items and press **OK** to view options. You can also adjust settings by highlighting items and rotating the command dials. The items displayed in photo mode differ from those displayed in movie mode.

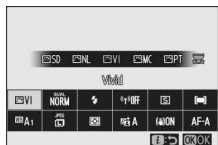

### The Playback *i* Menu

Pressing the *i* button during playback displays a context-sensitive menu of frequently-used playback options.

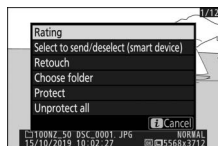

## ■ Customizing the *i* Menu

The items displayed in the photo-mode *i* menu can be chosen using Custom Setting f1 (**Customize *i* menu**).

### 1 Select Custom Setting f1.

In the Custom Settings menu, highlight Custom Setting f1 (**Customize *i* menu**) and press **OK** (for information on using the menus, see “The MENU Button”, [p 21](#)).

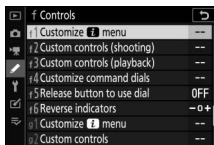

### 2 Choose a position.

Highlight a position in the menu you want to edit and press **OK**.



### 3 Choose an option.

Highlight an option and press **OK** to assign it to the selected position and return to the menu displayed in Step 2. Repeat Steps 2 and 3 as desired.

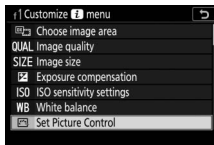

### 4 Exit.

Press the **MENU** button to save changes and exit.

### Options That Can Be Assigned to the **i** Menu

The following options can be assigned to the **i** menu for photo mode:

- Choose image area
- Image quality
- Image size
- Exposure compensation
- ISO sensitivity settings
- White balance
- Set Picture Control
- Color space
- Active D-Lighting
- Long exposure NR
- High ISO NR
- Metering
- Flash mode
- Flash compensation
- Focus mode
- AF-area mode
- Optical VR
- Auto bracketing
- Multiple exposure
- HDR (high dynamic range)
- Silent photography
- Release mode
- Custom controls (shooting)
- Exposure delay mode
- Shutter type
- Apply settings to live view
- Peaking highlights
- Monitor/viewfinder brightness
- Bluetooth connection
- Wi-Fi connection
- Wireless remote connection

The movie-mode **i** menu can be customized using Custom Setting g1 (**Customize **i** menu**); the options available differ from those for photo mode.

## The Function Buttons (Fn1 and Fn2)

The **Fn1** and **Fn2** buttons can also be used for quick access to selected settings during shooting. The settings assigned to these buttons can be chosen using Custom Setting f2 (**Custom controls (shooting)**) and the selected setting adjusted by pressing the button and rotating the command dials. At default settings, the **Fn1** button is used for white balance and the **Fn2** button to select focus and AF-area modes.

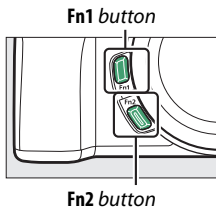

### ■ Customizing the Function Buttons

The function performed by the function buttons in photo mode are chosen using Custom Setting f2 (**Custom controls (shooting)**).

#### 1 Select Custom Setting f2.

In the Custom Settings menu, highlight Custom Setting f2 (**Custom controls (shooting)**) and press **OK** (for information on using the menus, see “The MENU Button”, p 21).

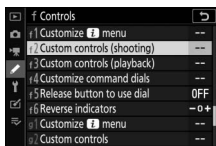

#### 2 Choose a button.

Highlight the option for the desired button and press **OK**. Select **Fn1 button** to choose the role played by the **Fn1 button**, **Fn2 button** to choose the role played by the **Fn2 button**.

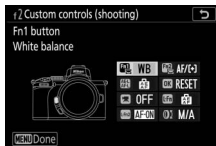

### 3 Choose an option.

Highlight an option and press **OK** to assign it to the selected button and return to the menu displayed in Step 2. Repeat Steps 2 and 3 to choose the role played by the remaining button.

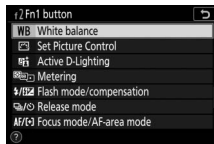

### 4 Exit.

Press the **MENU** button to save changes and exit.

#### Roles That Can Be Assigned to the Function Buttons

The following roles can be assigned to the function buttons in photo mode:

- AF-ON
- AF lock only
- AE lock (Hold)
- AE lock (Reset on release)
- AE lock only
- AE/AF lock
- FV lock
- Flash off
- Preview
- Bracketing burst
- + NEF (RAW)
- Subject tracking
- Framing grid display
- Zoom on/off
- MY MENU
- Access top item in MY MENU
- Playback
- Choose image area
- Image quality/size
- White balance
- Set Picture Control
- Active D-Lighting
- Metering
- Flash mode/compensation
- Release mode
- Focus mode/AF-area mode
- Auto bracketing
- Multiple exposure
- HDR (high dynamic range)
- Exposure delay mode
- Peaking highlights
- None

The roles played by the function buttons in movie mode can be chosen using Custom Setting g2 (**Custom controls**); the options available differ from those for photo mode.

## **The Flash Pop-Up Control**

Slide the flash pop-up control to raise the built-in flash.

- Raise the built-in flash for flash photography. The built-in flash will not fire while lowered.

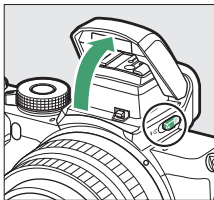

# First Steps

Complete the steps in this chapter before taking pictures for the first time.

## Attach the Camera Strap

A strap is supplied with the camera; additional straps are available separately. Attach the strap securely to the camera eyelets.

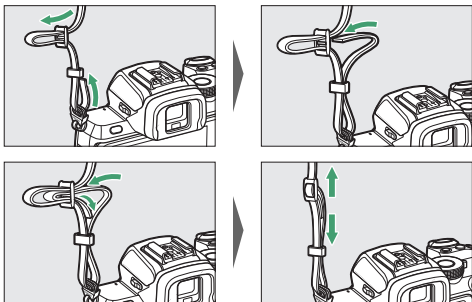



## Charge the Battery

The battery can be charged using the supplied battery charger.

### ✓ The Battery and Charger

Read and follow the warnings and cautions in "For Your Safety" (□ xxiii) and "Caring for the Camera and Battery: Cautions" (□ 446).

## The Battery Charger

Insert the battery and plug the charger in. An exhausted battery will fully charge in about 2 hours and 30 minutes.

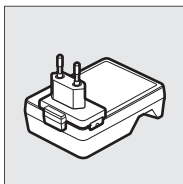

*In some countries or regions, charger may be supplied with adapter connected.*

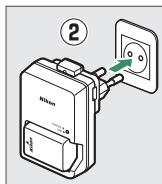
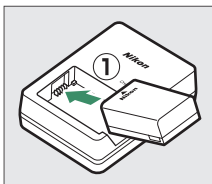

The **CHARGE** lamp will flash while the battery charges.

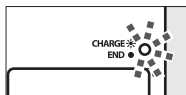

Battery charging  
(flashing)

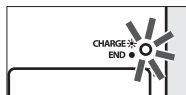

Charging complete  
(steady)

## Insert the Battery and a Memory Card

Before inserting or removing the battery or memory cards, confirm that the camera power switch is in the **OFF** position. Insert the battery in the orientation shown, using the battery to keep the orange battery latch pressed to one side. The latch locks the battery in place when the battery is fully inserted. Holding the memory card in the orientation shown, slide it straight into the slot until it clicks into place.

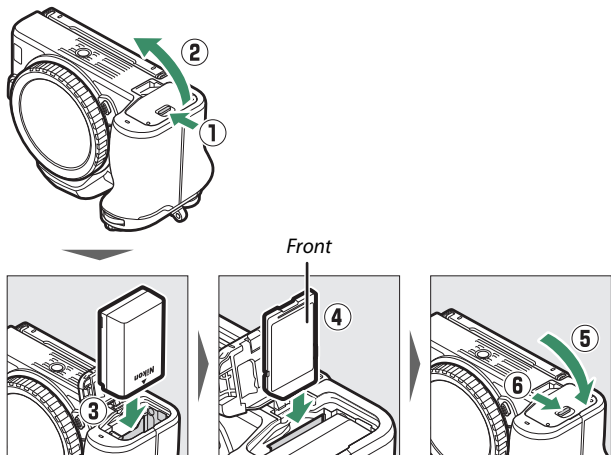

### ✔ Removing the Battery

To remove the battery, turn the camera off and open the battery-chamber cover. Press the battery latch in the direction shown by the arrow to release the battery and then remove the battery by hand.

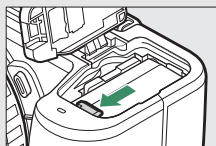

### ✔ Removing Memory Cards



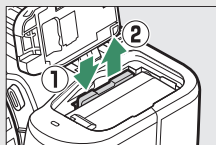

After confirming that the memory card access lamp is off, turn the camera off, open the battery-chamber cover, and press the card in to eject it (①). The card can then be removed by hand (②).

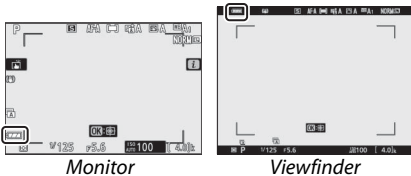

## **Battery Level**

The battery level is shown in the shooting display while the camera is on.



- The battery level display changes as the battery level diminishes, from  through  and finally to . When the battery level falls to , suspend shooting and charge the battery or ready a spare battery.
- If the message “Shutter release disabled. Recharge battery.” is displayed, charge or exchange the battery.

## **Number of Exposures Remaining**

When the camera is on, the shooting display show the number of photographs that can be taken at current settings (values over 1000 are rounded down to the nearest hundred; e.g., values between 1400 and 1499 are shown as 1.4 k).

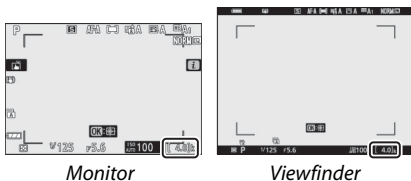

### ✔ Memory Cards

- Memory cards may be hot after use. Observe due caution when removing memory cards from the camera.
- Turn the power off before inserting or removing memory cards. Do not remove memory cards from the camera, turn the camera off, or remove the battery during formatting or while data are being recorded, deleted, or copied to a computer or other device. Failure to observe these precautions could result in loss of data or in damage to the camera or card.
- Do not touch the card terminals with your fingers or metal objects.
- Do not apply force to the card casing. Failure to observe this precaution could damage the card.
- Do not bend, drop, or subject to strong physical shocks.
- Do not expose to water, heat, high levels of humidity, or direct sunlight.
- Do not format memory cards in a computer.

### ✔ No Memory Card

If no memory card is inserted, a “no memory card” indicator and [–E–] will appear in the shooting display.

### ✔ The Write Protect Switch

SD memory cards are equipped with a write protect switch to prevent accidental loss of data. When this switch is in the “lock” position, the memory card cannot be formatted and photos cannot be deleted or recorded (a warning will be displayed in the monitor if you attempt to release the shutter). To unlock the memory card, slide the switch to the “write” position.

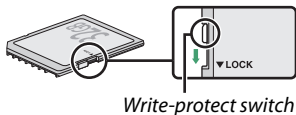

## Attach a Lens

The camera can be used with Z mount lenses. Before attaching or removing lenses, confirm that the camera power switch is in the **OFF** position. Be careful to prevent dust from entering the camera when the lens or body cap is removed, and be sure to remove the lens cap before taking pictures. The lens generally used in this manual for illustrative purposes is a NIKKOR Z DX 16–50mm f/3.5–6.3 VR.

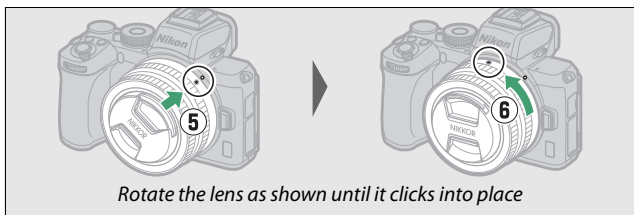
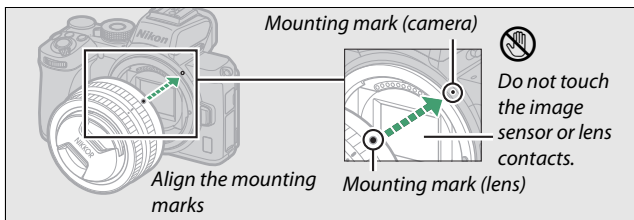
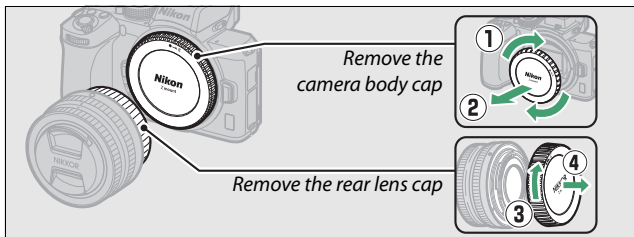

### ✓ F Mount Lenses

Be sure to attach the FTZ mount adapter (available separately) before using F mount lenses. Attempting to attach F mount lenses directly to the camera could damage the lens or image sensor.

### ✓ Detaching Lenses

Be sure the camera is off when removing or exchanging lenses. To remove the lens, press and hold the lens release button (①) while turning the lens clockwise (②). After removing the lens, replace the lens caps and camera body cap.

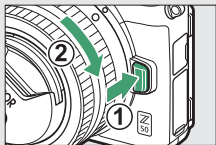

## Turn the Camera On

When you first turn the camera on, you will be prompted to choose a language using the multi selector and **OK** button.

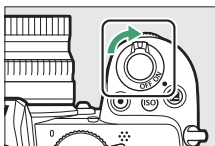

Press **MENU** and use the multi selector and **OK** button to set the camera clock. No other operations can be performed until the clock is set.

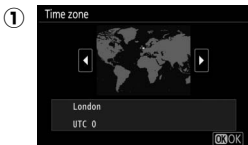
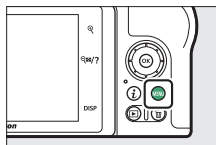

Select time zone

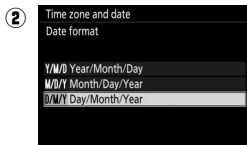

Select date format

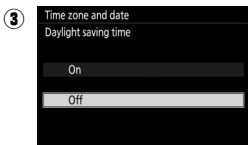

Select daylight saving time option

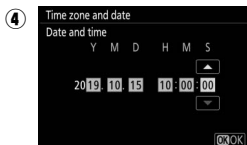

Set time and date (note that camera uses a 24-hour clock)



### ✔ The ☹ (“Clock Not Set”) Icon

The camera clock is powered by an independent, rechargeable power source, which is charged as necessary when the main battery is installed. Two days of charging will power the clock for about a month. If a ☹ icon flashes in the display, the clock has been reset and the date and time recorded with new photographs will not be correct. Use the **Time zone and date > Date and time** option in the setup menu to set the clock to the correct time and date (📖 307).

### ✔ SnapBridge

Use the SnapBridge app to synchronize the camera clock with the clock on a smartphone or tablet (smart device). See SnapBridge online help for details.

# Basic Photography and Playback

This chapter explains the basics of taking and viewing photos.

## Taking Photographs (AUTO Mode)

Follow the steps below to take photographs in <sup>AUTO</sup> (auto) mode, an automatic “point-and-shoot” mode in which the majority of settings are controlled by the camera in response to shooting conditions.

- 1 Turn the camera on.**  
The monitor will light.



- 2 Select photo mode.**  
Rotate the photo/movie selector to .

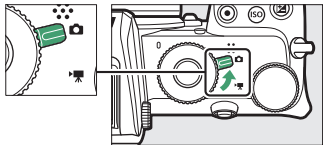

### Lenses with Retractable Barrels

Lenses with retractable barrels must be extended before use. Rotate the lens zoom ring as shown until the lens clicks into the extended position.

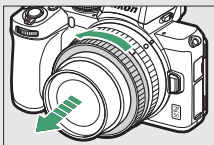

---

### 3 Select <sup>AUTO</sup> mode.

Rotate the mode dial to <sup>AUTO</sup> .

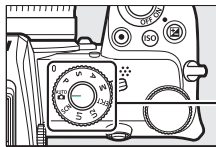

Mode dial

---

### 4 Ready the camera.

Hold the handgrip in your right hand and cradle the camera body or lens with your left. Bring your elbows in against the sides of your chest.

*Framing photos in the viewfinder*



*Landscape (wide) orientation*



*Portrait (tall) orientation*

*Framing photos in the monitor*



*Landscape (wide) orientation*



*Portrait (tall) orientation*

## 5 Frame the photograph.

Frame the shot with your subject in the AF-area brackets.



*AF-area brackets*

## 6 Press the shutter-release button halfway to focus.

- If the subject is stationary, the focus point will be displayed in green when the camera focuses. If the camera is unable to focus, the AF-area brackets will flash. If the subject is in motion, the camera will continue to adjust focus in response to changes in the distance to the subject while the shutter-release button is pressed halfway; focus will not lock.
- The AF-assist illuminator may light to assist the focus operation if the subject is poorly lit.

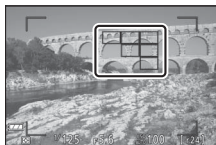

*Focus point*

### ✓ The AF-Assist Illuminator

Do not obstruct the AF-assist illuminator while it is lit.

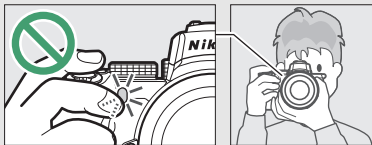

## 7 Shoot.

Smoothly press the shutter-release button the rest of the way down to take the photograph (you can also take a photograph by touching the monitor: touch your subject to focus and lift your finger to release the shutter). The memory card access lamp will light while the photo is recorded to the memory card. *Do not eject the memory card or remove the battery until the lamp has gone out and recording is complete.*

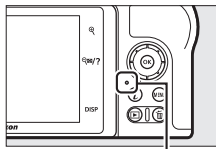
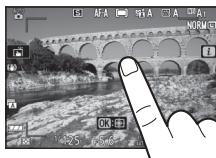

Memory card  
access lamp

### ✓ The Standby Timer

If no operations are performed for about 30 seconds, the display will dim before the monitor and viewfinder turn off to reduce the drain on the battery. Press the shutter-release button halfway to reactivate the display. The length of time before the standby timer expires automatically can be selected using Custom Setting c3 (**Power off delay**) > **Standby timer**.

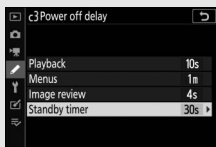

## Shooting Movies (AUTO Mode)

<sup>AUTO</sup> (auto) mode can also be used for simple, “point-and-shoot” movie recording.

- 1 Turn the camera on.**  
The monitor will light.



- 2 Select movie mode.**  
Rotate the photo/movie selector to . Note that the built-in flash and optional flash units cannot be used when the camera is in movie mode.

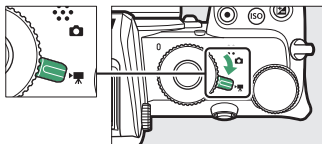

- 3 Select <sup>AUTO</sup> mode.**  
Rotate the mode dial to .

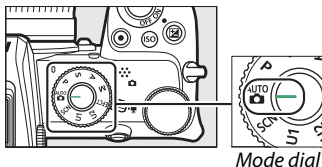

## 4 Start recording.

Press the movie-record button to start recording. While recording is in progress, the camera will display a recording indicator and the time remaining. The camera can be refocused at any time during recording by tapping your subject in the display. Sound is recorded via the built-in microphone; do not cover the microphone during recording.

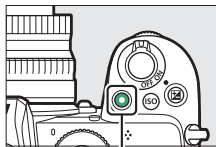

Movie-record button

Recording indicator



Time remaining

## 5 End recording.

Press the movie-record button again to end recording. The memory card access lamp will light while the camera finishes saving the movie to the memory card. *Do not eject the memory card or remove the battery until the lamp has gone out and recording is complete.*

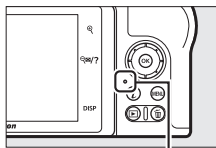
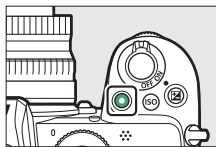

Memory card  
access lamp

### ✓ The Icon

A  icon indicates that movies cannot be recorded.

In movie mode, photos can be taken without interrupting recording by pressing the shutter-release button all the way down. The release mode (single-frame or continuous) can be selected before shooting begins using the



**Release mode (save frame)** option in the movie shooting menu (note that regardless of the option chosen, only one photo can be taken with each press while movie recording is in progress). A  icon will flash in the display when a photo is taken.

#### Taking Photos in Movie Mode

Note that photo-mode settings do not apply to photos taken in movie mode and that photos can be taken even when the subject is not in focus. Photos are recorded in fine-quality JPEG format at the dimensions currently selected for movie frame size. When **Continuous** is selected for **Release mode (save frame)** in the movie shooting menu, the frame advance rate while recording is paused varies with the option selected for **Frame size/frame rate**. Up to 40 photographs can be taken with each movie.



### ✔ During Shooting

Flicker, banding, or distortion may be visible in the display and in photos and movies shot under fluorescent, mercury vapor, or sodium lamps or with subjects that are in motion, particularly if the camera is panned horizontally or an object moves horizontally at high speed through the frame. Jagged edges, color fringing, *moiré*, and bright spots may also appear. Bright regions or bands may appear in some areas of the frame with flashing signs and other intermittent light sources or if the subject is briefly illuminated by a strobe or other bright, momentary light source, while noise (randomly-spaced bright pixels, fog, or lines) and unexpected colors may appear if you zoom in on the view through the lens. Flicker may occur when power aperture is used during movie recording.

Avoid pointing the camera at the sun or other strong light sources. Failure to observe this precaution could result in damage to the camera's internal circuitry.

### ✔ Recording Movies



Recording ends automatically when the maximum length is reached or if the lens is removed, another mode is selected, or the photo/movie selector is rotated to . Note that the built-in microphone may record sounds made by the camera or lens during optical vibration reduction, autofocus, or changes to aperture.

## Basic Playback

Photographs and movies can be viewed on the camera.

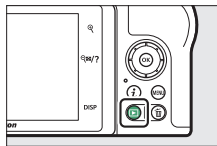

- 1 Press the  button.  
A picture will appear in the display.



- 2 View additional pictures.  
Press  or  to view additional pictures. When pictures are displayed in the monitor, you can view other pictures by flicking a finger left or right over the display. To end playback and return to shooting mode, press the shutter-release button halfway.







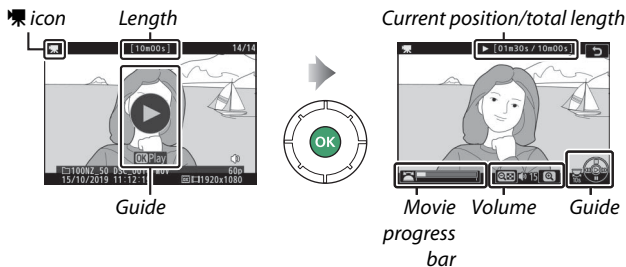







## Viewing Movies

Movies are indicated by a  icon. Tap the on-screen guide or press  to start playback; your current position is shown on the movie progress bar.



The following operations can be performed:

Operation	Description
Pause	Press  to pause playback.
Play	Press  to resume playback when playback is paused or during rewind/advance.
Rewind/advance	Press  to rewind,  to advance. Speed increases with each press, from 2x to 4x to 8x to 16x; keep the control pressed to skip to the beginning or end of the movie (the first frame is indicated by a  in the top right corner of the display, the last frame by a  ). If playback is paused, the movie rewinds or advances one frame at a time; keep the control pressed for continuous rewind or advance.
Start slow-motion playback	Press  while the movie is paused to start slow-motion playback.
Skip 10 s	Rotate the main command dial one stop to skip ahead or back 10 s.
Skip to last or first frame	Rotate the sub-command dial to skip to the last or first frame.
Adjust volume	Tap  to increase volume,  to decrease.
Trim movie	To view movie editing options, pause playback and press the  button.
Exit	Press  or  to exit to full-frame playback.
Return to shooting mode	Press the shutter-release button halfway to end playback.

## Deleting Unwanted Pictures



Press the  button to delete the current picture. *Note that pictures cannot be recovered once deleted.*

### 1 Display a picture you wish to delete.

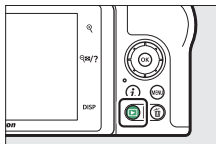
Display a photo or movie you wish to delete as described in “Basic Playback” ( 48).



### 2 Delete the picture.

Press the  button. A confirmation dialog will be displayed; press the  button again to delete the picture and return to playback. To exit without deleting the picture, press .

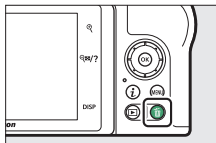

#### Delete

To delete selected pictures, all pictures taken on selected dates, or all pictures in a chosen location on the memory card, use the **Delete** option in the playback menu.

# Basic Settings

This chapter covers basic shooting and playback settings.

## Focus

Focus can be adjusted automatically, manually, or using touch controls. How the camera focuses is governed by your choice of focus mode and AF-area mode.

### Choosing a Focus Mode

The focus mode controls how the camera focuses. The focus mode can be selected using the **Focus mode** items in the **i** menu and the photo and movie shooting menus (📖 140, 216, 262).

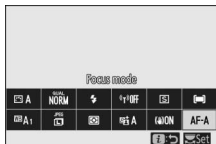

At default settings, the focus mode can also be selected by holding the **Fn2** button and rotating the main command dial (📖 27).

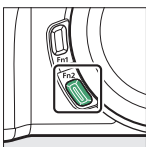

Option	Description
<b>AF mode auto-switch</b>	<ul style="list-style-type: none"><li>• The camera uses <b>AF-S</b> for stationary subjects, <b>AF-C</b> for subjects that are in motion.</li><li>• AF mode auto-switch is available only in photo mode.</li></ul>

Option	Description
<b>AF-S Single AF</b>	For stationary subjects. Press the shutter-release button halfway to focus. If the camera is able to focus, the focus point will turn from red to green; focus will lock while the shutter-release button is pressed halfway. If the camera fails to focus, the focus point will flash red and the shutter release will be disabled.
<b>AF-C Continuous AF</b>	For moving subjects. The camera focuses continuously while the shutter-release button is pressed halfway; if the subject moves, the camera will predict the final distance to the subject and adjust focus as necessary. At default settings, the shutter can only be released if the subject is in focus (focus priority), but this can be changed to allow the shutter to be released at any time (release priority) using Custom Setting a1 ( <b>AF-C priority selection</b> ).
<b>AF-F Full-time AF</b>	The camera adjusts focus continuously in response to subject movement or changes in composition. When the shutter-release button is pressed halfway, the focus point will turn from red to green and focus will lock. This option is only available in movie mode.
<b>MF Manual focus</b>	Focus manually (☐ 65). The shutter can be released whether or not the subject is in focus.

### ✔ Autofocus

The display may brighten or darken while the camera focuses and the focus point may sometimes be displayed in green when the camera is unable to focus. The camera may be unable to focus using autofocus in the following situations:

- The subject contains lines parallel to the long edge of the frame
- The subject lacks contrast
- The subject in the focus point contains areas of sharply contrasting brightness, or includes spot lighting or a neon sign or other light source that changes in brightness
- Flicker or banding appears under fluorescent, mercury-vapor, sodium-vapor, or similar lighting
- A cross (star) filter or other special filter is used
- The subject appears smaller than the focus point
- The subject is dominated by regular geometric patterns (e.g., blinds or a row of windows in a skyscraper)

### ✔ Turning the Camera Off

The focus position may change if you turn the camera off and then on again after focusing.

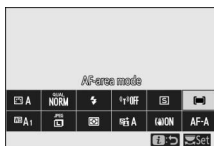

## AF-Area Mode

The focus point can be positioned using the multi selector. AF-area mode controls how the camera selects the focus-point for autofocus. The default setting is **Auto-area AF**, but other options can be selected using the **AF-area mode** items in the **i** menu and the photo and movie shooting menus (📖 140, 216, 262).



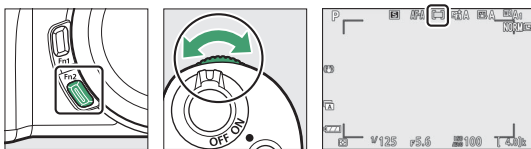



At default settings, AF-area mode can also be selected by holding the **Fn2** button and rotating the sub-command dial (📖 27).



Option	Description
 <b>Pinpoint AF</b>	Recommended for shots involving static subjects, such as buildings, in-studio product photography, or close-ups. Pinpoint AF is used for pinpoint focus on a selected spot in the frame. This option is only available when photo mode is selected and <b>Single AF</b> is chosen for <b>Focus mode</b> . Focusing may be slower than with single-point AF.
 <b>Single-point AF</b>	The camera focuses on a point selected by the user. Use with stationary subjects.



Option	Description
 <b>Dynamic-area AF</b>	<p>The camera focuses on a point selected by the user. If the subject briefly leaves the selected point, the camera will focus based on information from surrounding focus points. Use for photographs of athletes and other active subjects that are hard to frame using single-point AF. This option is only available when photo mode is selected and <b>AF mode auto-switch</b> or <b>Continuous AF</b> is chosen for <b>Focus mode</b>.</p>
 <b>Wide-area AF (S)</b>	<p>As for <b>Single-point AF</b>, except the camera focuses on a wider area, the focus areas for <b>Wide-area AF (L)</b> being larger than those for <b>Wide-area AF (S)</b>. Use for snapshots or photos of moving subjects that are hard to frame using single-point AF, or in movie mode for smooth focus during panning and tilting shots or when filming moving subjects. If the selected focus area contains subjects at different distances from the camera, the camera will assign priority to the closest subject.</p>
 <b>Wide-area AF (L)</b>	

Option	Description
<p> <b>Auto-area AF</b></p>	<ul style="list-style-type: none"> <li>• The camera automatically detects the subject and selects the focus area.</li> <li>• Use on occasions when you don't have time to select the focus point yourself, for portraits, or for snapshots and other spur-of-the-moment photos.</li> <li>• A yellow border indicating the focus point appears around the faces of human subjects detected by the camera. If eyes are detected, the yellow focus point will instead appear over one or the other of their eyes (face/eye-detection AF). This frees you to concentrate on framing and your subject's expression while photographing active portrait subjects (□ 58).</li> <li>• If <b>Animal detection on</b> is selected for Custom Setting a2 (<b>Auto-area AF face/eye detection</b>), a yellow focus point will appear over the faces of dogs or cats detected by the camera. If eyes are detected, the yellow focus point will instead appear over one or the other of their eyes (animal-detection AF, □ 60).</li> <li>• Subject tracking (□ 62) can be initiated by pressing the  button. Custom Setting f2 (<b>Custom controls (shooting)</b>) or g2 (<b>Custom controls</b>) can be used to configure the <b>Fn1</b> or <b>Fn2</b> button to start subject-tracking AF (□ 286, 298). Subject-tracking AF can also be assigned to the lens <b>Fn</b> or <b>Fn2</b> button using Custom Setting f2 (<b>Custom controls (shooting)</b>).</li> </ul>

 : **The Center Focus Point**

In all AF-area modes except **Auto-area AF**, a dot appears in the focus point when it is in the center of the frame.

 **Quick Focus-Point Selection**

For quicker focus-point selection, choose **Every other point** for Custom Setting a3 (**Focus points used**) to use only a quarter of the available focus points. The number of points available for **Pinpoint AF** and **Wide-area AF (L)** does not change.

## ■ Face/Eye-Detection AF

When photographing portrait subjects with **Auto-area AF**, use Custom Setting a2 (**Auto-area AF face/eye detection**) to choose whether the camera detects both faces and eyes (face/eye-detection AF) or only faces (face-detection AF) of human portrait subjects.

- If **Face and eye detection on** is selected and a human face is detected, a yellow border indicating the focus point will appear around the subject's face. If the camera detects the subject's eyes, the yellow focus point will instead appear over one or the other of their eyes. **Face and eye detection on** is enabled at all times in **AUTO** (auto) mode.
- Faces detected when **Face detection on** is selected are similarly indicated by a yellow focus point.
- If **AF-C** is selected for focus mode, or if the camera is shooting using **AF-C** when **AF-A** is selected for focus mode, the focus point will light yellow when faces or eyes are detected.
- If **AF-S** is selected for focus mode, or if the camera is shooting using **AF-S** when **AF-A** is selected for focus mode, the focus point will turn green when the camera focuses.
- If more than one human face or eye is detected, ◀ and ▶ icons will appear on the focus point. You will be able to position the focus point over a different face or eye by pressing ◀ or ▶.
- If the subject looks away after their face is detected, the focus point will move to track their motion.
- During playback, you can zoom in on the face or eye used for focus by pressing OK.

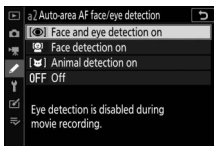



Focus point

### ✔ Face/Eye-Detection AF

- Eye detection is not available in movie mode.
- Eyes or faces may not be detected as expected if:
  - the subject's face occupies a very large or very small proportion of the frame,
  - the subject's face is lit too brightly or too poorly,
  - the subject is wearing glasses or sunglasses,
  - the subject's face or eyes are obscured by hair or other objects, or
  - the subject moves excessively during shooting.

## ■ ■ Animal-Detection AF

In modes other than <sup>AUTO</sup> , the camera will detect the faces and eyes of dogs and cats (animal-detection AF) when **Animal detection on** is selected for Custom Setting a2 (**Auto-area AF face/eye detection**). **Animal detection on** is enabled at all times in  (pet portrait) mode.

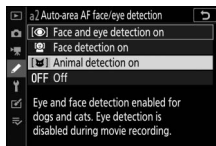

- When the camera detects a face of a dog or cat, a yellow border indicating the focus point will appear around the subject's face. If the camera detects the subject's eyes, the yellow focus point will instead appear over one or the other of their eyes.
- If **AF-C** is selected for focus mode, or if the camera is shooting using **AF-C** when **AF-A** is selected for focus mode, the focus point will light yellow when faces or eyes are detected.
- If **AF-S** is selected for focus mode, or if the camera is shooting using **AF-S** when **AF-A** is selected for focus mode, the focus point will turn green when the camera focuses.
- If more than one face or eye of a dog or cat is detected, ◀ and ▶ icons will appear on the focus point. You will be able to position the focus point over a different face or eye by pressing ⌚ or ⌚.
- During playback, you can zoom in on the face or eye used for focus by pressing .



*Focus point*

### ✔ **Animal-Detection AF**

- Depending on shooting conditions, the camera may fail to detect the faces or eyes of some breeds when **Animal detection on** is enabled. Alternatively, the camera may display a border around subjects that are not the faces or eyes of dogs or cats.
- Eyes or faces may not be detected as expected if:
  - the subject's face occupies a very large or very small proportion of the frame,
  - the subject's face is lit too brightly or too poorly,
  - the subject's face or eyes are obscured by fur or other objects,
  - the subject's eyes are similar in color to the rest of their face, or
  - the subject moves excessively during shooting.
- Eye detection is not available in movie mode.
- The light from the AF-assist illuminator may adversely affect the eyes of some animals; we recommend that you select **Off** for Custom Setting a8 (**Built-in AF-assist illuminator**).

## ■ Subject Tracking

When **Auto-area AF** is selected for AF-area mode, the camera can track the subject in the selected focus point.

- Press **OK** to enable focus tracking; the focus point will change to a targeting reticle.
- Position the reticle over the target and press **OK** again to start tracking; the focus point will track the selected subject as it moves through the frame. To end tracking and select the center focus point, press **OK** again. Note that if you press the shutter-release button halfway to start tracking during still photography when **AF-C** or **AF-A** is selected for focus mode, the camera will track the subject only while the shutter-release button is pressed halfway; when the button is released, tracking will end and the focus point in effect before tracking started will be restored.
- To exit subject-tracking mode, press the **Q/Menu/?** button.



### ✓ Subject Tracking

The camera may be unable to track subjects if they move quickly, leave the frame or are obscured by other objects, change visibly in size, color, or brightness, or are too small, too large, too bright, too dark, or similar in color or brightness to the background.



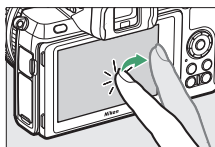

## The Touch Shutter

Touch controls can be used to focus and release the shutter. Touch the display to focus and lift your finger to release the shutter.



Tap the icon shown in the illustration to choose the operation performed by tapping the display in shooting mode. Choose from the following options:



	<ul style="list-style-type: none"><li>• Touch the display to focus on the selected point and lift your finger to release the shutter. If an option other than <b>Off</b> is selected for Custom Setting a2 (<b>Auto-area AF face/eye detection</b>) and the camera detects human faces or eyes or the faces or eyes of dogs or cats, the camera will focus on the face or eye * closest to the selected point.</li><li>• Available only in photo mode.</li></ul>
	<ul style="list-style-type: none"><li>• Touch the display to focus on the selected point. Lifting your finger from the display does not release the shutter.</li><li>• If auto-area AF is selected for AF-area mode, the camera will track the selected subject as it moves through the frame. To switch to a different subject, tap it in the display. If an option other than <b>Off</b> is selected for Custom Setting a2 (<b>Auto-area AF face/eye detection</b>) and the camera detects human faces or eyes or the faces or eyes of dogs or cats, the camera will focus on and track the face or eye * closest to the selected point.</li></ul>
	Touch shutter disabled.

\* When choosing an eye using touch controls, note that the camera may not focus on the eye on the side you intend. Use the multi selector to choose the desired eye.

### ✓ Taking Pictures Using Touch Shooting Options

- Touch controls cannot be used for manual focus.
- The shutter-release button can be used to take pictures when the  icon is displayed.
- Touch controls cannot be used to take photographs during movie recording.
- During burst photography, touch controls can be used only to take one picture at a time. Use the shutter-release button for burst photography.
- In self-timer mode, focus locks on the selected subject when you touch the monitor and the shutter is released about 10 seconds after you lift your finger from the display. If the number of shots selected is greater than 1, the remaining shots will be taken in a single burst.

## Manual Focus

Manual focus can be used when autofocus does not produce the desired results. Position the focus point over your subject and rotate the focus or control ring until the subject is in focus.

For greater precision, tap the  button to zoom in on the view through the lens.

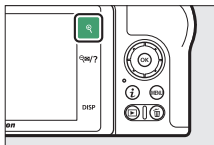
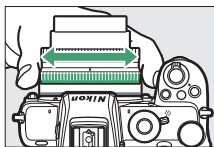

When the subject is in focus, the focus point will light green and the in-focus indicator (●) will appear in the display (electronic rangefinding).

### Focus distance indicator

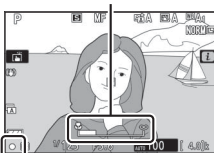

### In-focus indicator

In-focus indicator	Description
●	Subject in focus.
▶	Focus point is between camera and subject.
◀	Focus point is behind subject.
▶ ◀ (flashes)	Camera unable to determine whether subject is in focus.

When using manual focus with subjects not suited to autofocus, note that the in-focus indicator (●) may be displayed when the subject is not in focus. Zoom in on the view through the lens and check focus. Use of a tripod is recommended when the camera is having trouble focusing.

### ✓ Lenses with Focus-Mode Selection

Manual focus can be selected using the controls on the lens.

### ✓ Focal Plane Position

To determine the distance between your subject and the camera, measure from the focal plane mark (∅) on the camera body. The distance between the lens mounting flange and the focal plane is 16 mm (0.63 in.).

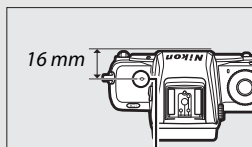

*Focal plane mark*

### ✓ Focus Peaking

If focus peaking is enabled using Custom Setting d9 (**Peaking highlights**), objects that are in focus will be indicated by colored outlines in manual focus mode. Note that peaking highlights may not be displayed if the camera is unable to detect outlines, in which case focus can be checked using the view through the lens in the display.

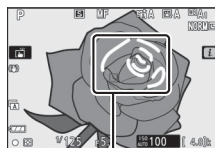

*Area in focus*

## White Balance

White balance ensures that white objects appear white, regardless of the color of the light source. The default setting (**WB A<sub>1</sub>**) is recommended with most light sources. If the desired results cannot be achieved with auto white balance, choose another option as described below.

White balance can be selected using the **White balance** items in the **i** menu and the photo and movie shooting menus (📖 120, 198, 259).

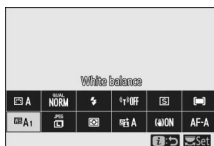



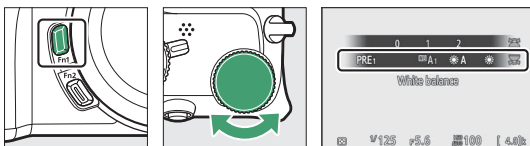

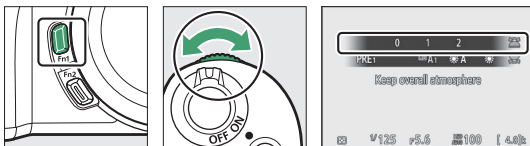

At default settings, white balance can also be selected by holding the **Fn1** button and rotating the main command dial (📖 27).



When **WB A (Auto)**, **☀ (Fluorescent)**, **🏠 (Choose color temperature)**, or **PRE (Preset manual)** is selected, you can choose a sub-option by holding the **Fn1** button and rotating the sub-command dial.



Option	K*	Description
 <b>A Auto</b>		White balance is adjusted automatically for optimal results with most light sources. When the built-in flash or an optional flash unit is used, white balance will be adjusted according to the lighting produced by the flash.
<b>Keep white (reduce warm colors)</b>	3500–8000	Eliminate warm color cast produced by incandescent lighting.
<b>Keep overall atmosphere</b>		Partially preserve warm color cast produced by incandescent lighting.
<b>Keep warm lighting colors</b>		Preserve warm color cast produced by incandescent lighting.
 <b>A Natural light auto</b>	4500–8000	When used under natural light, this option produces colors closer to those seen by the naked eye.
 <b>Direct sunlight</b>	5200	Use with subjects lit by direct sunlight.
 <b>Cloudy</b>	6000	Use in daylight under overcast skies.
 <b>Shade</b>	8000	Use in daylight with subjects in shade.
 <b>Incandescent</b>	3000	Use under incandescent lighting.
 <b>Fluorescent</b>		Use under fluorescent lighting; choose bulb type according to light source.
<b>Sodium-vapor lamps</b>	2700	
<b>Warm-white fluorescent</b>	3000	
<b>White fluorescent</b>	3700	
<b>Cool-white fluorescent</b>	4200	
<b>Day white fluorescent</b>	5000	
<b>Daylight fluorescent</b>	6500	
<b>High temp. mercury-vapor</b>	7200	

\* Color temperature. All values are approximate and do not reflect fine-tuning (if applicable).

Option	K*	Description
<b>WB</b> ⚡ Flash	5400	Use with studio strobe lighting and other large flash units.
<b>K</b> Choose color temperature	2500–10,000	Choose color temperature from list of values or by holding <b>Fn1</b> button and rotating sub-command dial.
<b>PRE</b> Preset manual	—	Measure white balance for subject or light source (press and hold <b>Fn1</b> button to enter direct measurement mode,  123), copy white balance from existing photograph, or choose existing value by holding <b>Fn1</b> button and rotating sub-command dial.



\* Color temperature. All values are approximate and do not reflect fine-tuning (if applicable).

### **WB A** (“Auto”)

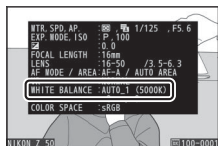
The photo info for pictures shot using auto white balance lists the color temperature selected by the camera at the time the picture was taken. You can use this as reference when choosing a value for **Choose color temperature**. To view shooting data during playback, go to **Playback display options** in the playback menu and select **Shooting data** for **Additional photo info**.





✔  **A** (“Natural Light Auto”)

 **A (Natural light auto)** may not produce the desired results under artificial light. Choose  **A (Auto)** or an option that matches the light source.

✔ **White Balance Fine-Tuning**

At settings other than **Choose color temperature**, white balance can be fine-tuned using the **White balance** items in the **i** menu and the photo and movie shooting menus (📖 121).

✔ **Studio Flash Lighting**

 **A (Auto)** may not produce the desired results with large studio flash units. Use preset white balance or set white balance to  **(Flash)** and use fine-tuning to adjust white balance.

✔ **Color Temperature**

The perceived color of a light source varies with the viewer and other conditions. Color temperature is an objective measure of the color of a light source, defined with reference to the temperature to which an object would have to be heated to radiate light in the same wavelengths. While light sources with a color temperature in the neighborhood of 5000–5500 K appear white, light sources with a lower color temperature, such as incandescent light bulbs, appear slightly yellow or red. Light sources with a higher color temperature appear tinged with blue.

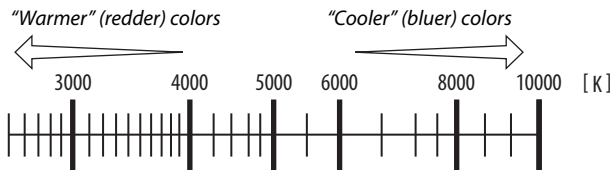

In general, choose lower values if your pictures have a red cast or to intentionally make colors colder, higher values if your pictures are tinged blue or to intentionally make colors warmer.



## Silent Photography

To enable the electronic shutter and eliminate the noise and vibration caused by operation of the mechanical shutter, select **On** for **Silent photography** in the photo shooting menu. Regardless of the setting chosen for **Beep options** in the setup menu, no beep will sound when the camera focuses or while the self-timer is counting down. Note that the electronic shutter will be used regardless of the option selected for Custom Setting d4 (**Shutter type**).

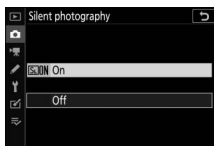

An icon is displayed while silent photography is in effect. In release modes other than **Continuous H (extended)**, the display will briefly go dark when the shutter is released to signal that a photo has been taken.



Enabling silent photography changes the frame advance rates for continuous release modes and disables some features, including high ISO sensitivity (Hi 1, Hi 2), the flash, long exposure noise reduction, and flicker reduction.

### ✔ Silent Photography

Selecting **On** for **Silent photography** mutes the shutter, but this does not absolve photographers of the need to respect their subjects' privacy and image rights. Although the noise of the mechanical shutter is muted, other sounds may still be audible, for example during autofocus or aperture adjustment. During silent photography, flicker, banding, or distortion may be visible in the display and in the final picture under fluorescent, mercury vapor, or sodium lamps or if the camera or subject moves during shooting. Jagged edges, color fringing, *moiré*, and bright spots may also appear. Bright regions or bands may appear in some areas of the frame with flashing signs and other intermittent light sources or if the subject is briefly illuminated by a strobe or other bright, momentary light source.

## Rating Pictures

Selected pictures can be rated or marked as candidates for later deletion. Ratings can also be viewed in NX Studio. Protected pictures cannot be rated.

### 1 Select an image.

Press the  button to start playback and display a picture you want to rate.

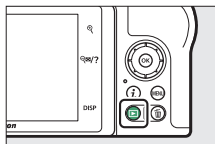

### 2 Display the *i* menu.

Press the *i* button to view the *i* menu.

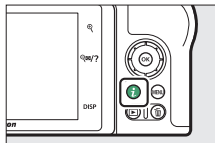

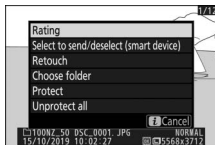

### 3 Select Rating.

Highlight **Rating** and press .



### 4 Choose a rating.

Use the multi selector to choose a rating of from zero to five stars, or select  to mark the picture as a candidate for later deletion. Press  to complete the operation.



## Protecting Pictures from Deletion

Use the  $\text{AE-L/AF-L}$  (O-n) button to protect pictures from accidental deletion. Note that this does NOT prevent pictures being deleted when the memory card is formatted.

### 1 Select an image.

Press the  $\blacktriangleright$  button to start playback and display a picture you want to protect.

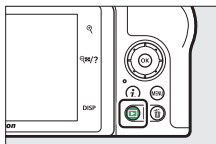

### 2 Press the $\text{AE-L/AF-L}$ (O-n) button.

Protected pictures are indicated by a  icon; to remove protection, display the picture and press the  $\text{AE-L/AF-L}$  (O-n) button again.

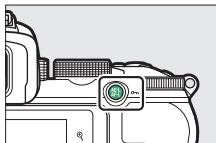

### Removing Protection from All Pictures

To remove protection from all pictures in the folder or folders currently selected for **Playback folder** in the playback menu, select **Unprotect all** in the  $\mathbf{i}$  menu.

# Shooting Controls

This chapter describes controls that can be used during shooting.

## The Mode Dial

Rotate the mode dial to choose from the following modes:

- **AUTO** **Auto:** A “point-and-shoot” mode in which the camera sets exposure and hue (📖 40, 44).
- **P Programmed auto:** The camera sets shutter speed and aperture for optimal exposure. Recommended for snapshots and in other situations in which there is little time to adjust camera settings.
- **S Shutter-priority auto:** You choose the shutter speed; the camera selects the aperture for best results. Use to freeze or blur motion.
- **A Aperture-priority auto:** You choose the aperture; the camera selects the shutter speed for best results. Use to blur backgrounds or bring both foreground and background into focus.
- **M Manual:** You control both shutter speed and aperture. Set shutter speed to “bulb” or “time” for long time-exposures.
- **EFCT Special effects:** Take pictures with added special effects.
- **U1/U2 User settings modes:** Assign frequently-used settings to these positions for quick recall.
- **SCN Scene:** Use for subjects of a selected type.

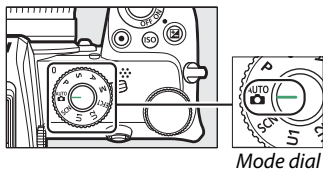

Mode dial

## **P: Programmed Auto**

In this mode, the camera automatically adjusts shutter speed and aperture according to a built-in program to ensure optimal exposure in most situations. Different combinations of shutter speed and aperture that

produce the same exposure can be selected by rotating the main command dial (“flexible program”). While flexible program is in effect, a flexible program indicator (\*) is displayed. To restore default shutter speed and aperture settings, rotate the main command dial until the indicator is no longer displayed, choose another mode, or turn the camera off.

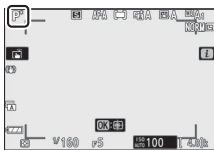

## **S: Shutter-Priority Auto**

In shutter-priority auto, you choose the shutter speed while the camera automatically selects the aperture that will produce the optimal exposure. To choose a shutter speed, rotate the main command dial. Shutter speed can be set to values between 30 s and  $\frac{1}{4000}$  s.



## A: Aperture-Priority Auto

In aperture-priority auto, you choose the aperture while the camera automatically selects the shutter speed that will produce the optimal exposure. To choose an aperture between the minimum and maximum values for the lens, rotate the sub-command dial.



### **Movie Mode Exposure Settings**

The following exposure settings can be adjusted in movie mode:

	Aperture	Shutter speed	ISO sensitivity
P, S <sup>1</sup>	—	—	— <sup>2</sup>
A	✓	—	— <sup>2</sup>
M	✓	✓	✓ <sup>3</sup>

- 1 Exposure for mode **S** is equivalent to mode **P**.
- 2 The upper limit for ISO sensitivity can be selected using the **ISO sensitivity settings > Maximum sensitivity** option in the movie shooting menu.
- 3 If **On** is selected for **ISO sensitivity settings > Auto ISO control (mode M)** in the movie shooting menu, the upper limit for ISO sensitivity can be selected using the **Maximum sensitivity** option.

## **M: Manual**



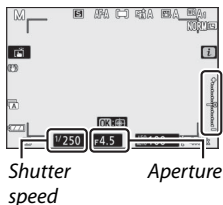



In manual exposure mode, you control both shutter speed and aperture. Rotate the main command dial to choose a shutter speed, and the sub-command dial to set aperture. Shutter speed can be set to values between 30 s and  $\frac{1}{4000}$  s, or the shutter can be held open indefinitely for a long time-exposure (80). Aperture can be set to values between the minimum and maximum values for the lens. Use the exposure indicators to check exposure.



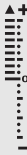

### ✔ Exposure Indicators

The exposure indicators show whether the photograph would be under- or over-exposed at current settings. Depending on the option chosen for Custom Setting b1 (**EV steps for exposure ctrl**), the amount of under- or overexposure is shown in increments of  $\frac{1}{3}$  or  $\frac{1}{2}$  EV. If the limits of the exposure metering system are exceeded, the displays will flash.

Custom Setting b1 set to "1/3 step"			
	Optimal exposure	Underexposed by $\frac{1}{3}$ EV	Overexposed by over 3 EV
Monitor			
Viewfinder			

### ✔ Auto ISO Sensitivity Control (Mode M)

If auto ISO sensitivity control (☐ 101) is enabled, ISO sensitivity will automatically be adjusted for optimal exposure at the selected shutter speed and aperture.

## ■ Long Time-Exposures

Select the following shutter speeds for long time-exposures of moving lights, the stars, night scenery, or fireworks.

- **Bulb:** The shutter remains open while the shutter-release button is held down (note that this option functions in the same way as “time” when the camera is used with an optional ML-L7 remote control).
- **Time:** The exposure starts when the shutter-release button is pressed and ends when the button is pressed a second time.



- **Shutter speed:** Bulb (35-second exposure)
- **Aperture:** f/25

To prevent blur, mount the camera on a tripod. Nikon also recommends using a fully-charged battery to prevent loss of power while the shutter is open. Note that noise (bright spots, randomly-spaced bright pixels, or fog) may be present in long exposures. Bright spots and fog can be reduced by choosing **On** for **Long exposure NR** in the photo shooting menu.

---

### 1 Ready the camera.

Mount the camera on a tripod or place it on a stable, level surface.

---

### 2 Select mode M.

Rotate the mode dial to **M**.

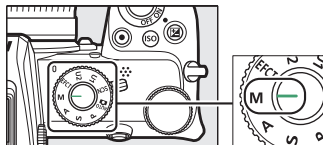

---

### 3 Choose a shutter speed.

Rotate the main command dial to choose a shutter speed of **Bulb** or **Time**.

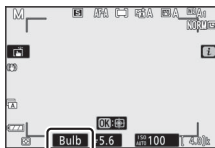

*Bulb*



*Time*

---

### 4 Open the shutter.

**Bulb:** After focusing, press the shutter-release button all the way down. Keep the shutter-release button pressed until the exposure is complete.

**Time:** After focusing, press the shutter-release button all the way down.

---

### 5 Close the shutter.

**Bulb:** Take your finger off the shutter-release button.

**Time:** Press the shutter-release button all the way down.

## User Settings: U1 and U2 Modes

Assign frequently-used settings to the **U1** and **U2** positions on the mode dial.

### ■ *Saving User Settings*

Follow the steps below to save settings:

---

#### 1 Adjust settings.

Make the desired adjustments to camera settings, including:

- photo shooting menu options,
  - movie shooting menu options,
  - Custom Settings, and
  - shooting mode, shutter speed (modes **S** and **M**), aperture (modes **A** and **M**), flexible program (mode **P**), exposure compensation, and auto bracketing.
- 

#### 2 Select **Save user settings**.

Highlight **Save user settings** in the setup menu and press **▶**.

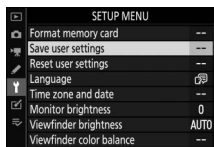

#### 3 Select a position.

Highlight **Save to U1** or **Save to U2** and press **▶**.

---

#### 4 Save user settings.

Highlight **Save settings** and press **OK** to assign the settings selected in Step 1 to the mode dial position selected in Step 3.

## ■ ■ Recalling User Settings

Rotating the mode dial to **U1** or **U2** recalls the settings last saved to that position.

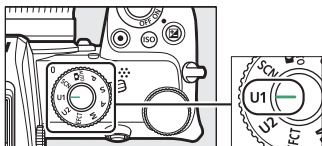

## ■ ■ Resetting User Settings

To reset settings for **U1** or **U2** to default values:

### 1 Select Reset user settings.

Highlight **Reset user settings** in the setup menu and press .



### 2 Select a position.

Highlight **Reset U1** or **Reset U2** and press .

### 3 Reset user settings.

Highlight **Reset** and press  to restore default settings for the selected position. The camera will function in mode **P**.

#### ✓ User Settings

The following cannot be saved to **U1** or **U2**.

##### Photo shooting menu:

- Storage folder
- Choose image area
- Manage Picture Control
- Multiple exposure
- Interval timer shooting
- Time-lapse movie

##### Movie shooting menu:

- Manage Picture Control

## SCN (Scene Modes)

The camera offers a choice of “scene” modes. Choosing a scene mode automatically optimizes settings to suit the selected scene, making creative photography as simple as selecting a mode, framing a picture, and shooting as described in “Taking Photographs (AUTO Mode)” (□ 40).

The following scenes can be selected by rotating the mode dial to **SCN** and rotating the main command dial until the desired scene appears in the monitor.

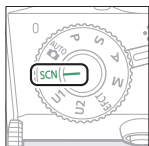

Mode dial

+



Main command dial

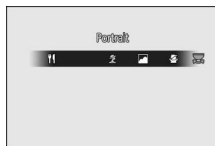

Monitor

Portrait	Beach/Snow
Landscape	Sunset
Child	Dusk/Dawn
Sports	Pet Portrait
Close up	Candlelight
Night Portrait	Blossom
Night Landscape	Autumn Colors
Party/Indoor	Food

## **Portrait**



Use for portraits with soft, natural-looking skin tones. If the subject is far from the background or a telephoto lens is used, background details will be softened to lend the composition a sense of depth.

## **Landscape**

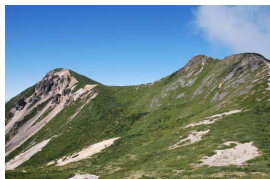

Use for vivid landscape shots in daylight.

### **Note**

The built-in flash and AF-assist illuminator turn off.

## **Child**



Use for snapshots of children. Clothing and background details are vividly rendered, while skin tones remain soft and natural.

## Sports



Fast shutter speeds freeze motion for dynamic sports shots in which the main subject stands out clearly.

### Note

The built-in flash and AF-assist illuminator turn off.

## Close up



Use for close-up shots of flowers, insects, and other small objects.

## Night Portrait

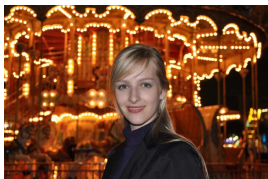

Use for a natural balance between the main subject and the background in portraits taken under low light.



## **Night Landscape**

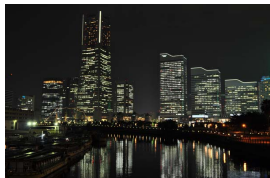

Reduce noise and unnatural colors when photographing night landscapes, including street lighting and neon signs.

### **Note**

The built-in flash and AF-assist illuminator turn off.

## **Party/Indoor**



Capture the effects of indoor background lighting. Use for parties and other indoor scenes.

## **Beach/Snow**



Capture the brightness of sunlit expanses of water, snow, or sand.

### **Note**

The built-in flash and AF-assist illuminator turn off.

## **Sunset**

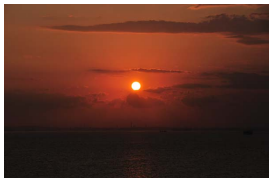

Preserves the deep hues seen in sunsets and sunrises.

### **Note**

The built-in flash and AF-assist illuminator turn off.

## **Dusk/Dawn**



Preserves the colors seen in the weak natural light before dawn or after sunset.

### **Note**

The built-in flash and AF-assist illuminator turn off.

## **Pet Portrait**



Use for portraits of active pets.

### **Note**

The AF-assist illuminator turns off.

## **Candlelight**



For photographs taken by candlelight.

### **Note**

The built-in flash turns off.

## **Blossom**



Use for fields of flowers, orchards in bloom, and other landscapes featuring expanses of blossoms.

### **Note**

The built-in flash turns off.

## **Autumn Colors**



Captures the brilliant reds and yellows in autumn leaves.

### **Note**

The built-in flash turns off.



Use for vivid photographs of food.

 **Note**

If raised, the built-in flash will fire with every shot.

 **Preventing Blur**

Use a tripod to prevent blur caused by camera shake at slow shutter speeds.

 **Scene Modes**

Some settings—for example, Picture Controls, white balance, or Custom Settings—cannot be changed depending on the mode selected.

## **EFCT (Special Effect Modes)**

Special effects can be used when taking photographs and shooting movies.

The following effects can be selected by rotating the mode dial to **EFCT** and rotating the main command dial until the desired option appears in the monitor.

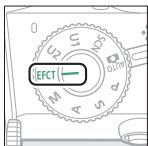

*Mode dial*

+



*Main command dial*



*Monitor*

---

 Night Vision

---

 Miniature Effect

---

 Super Vivid

---

 Selective Color

---

 Pop

---

 Silhouette

---

 Photo Illustration

---

 High Key

---

 Toy Camera Effect

---

 Low Key

---

Movie frame sizes of 1920 × 1080 120p, 1920 × 1080 100p, and 1920 × 1080 slow-motion are not available in **EFCT** mode.

## **Night Vision**

---

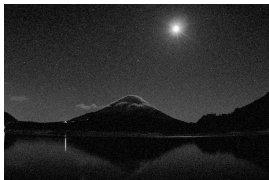

Use under conditions of darkness to record monochrome images at high ISO sensitivities.

### **Note**

Manual focus can be used if the camera is unable to focus. The built-in flash turns off; optional flash units will not fire.

## **VI** *Super Vivid*

---



Overall saturation and contrast are increased for a more vibrant image.

## **POP** *Pop*



---



Overall saturation is increased for a more lively image.

## **Photo Illustration**





Sharpen outlines and simplify coloring for a poster effect. Press  to adjust settings ( 96).

### **Notes**

- Movies shot in this mode play back like a slide show made up of a series of stills.
- Autofocus is not available during movie recording.

## **Toy Camera Effect**



Create photos and movies with saturation and peripheral illumination similar to pictures shot with a toy camera. Press  to adjust settings ( 96).

## **Miniature Effect**



Create photos that appear to be pictures of dioramas. Works best when shooting from a high vantage point. Press **OK** to adjust settings (☞ 97).

### **Notes**

- The built-in flash does not fire.
- The AF-assist illuminator does not light.
- Miniature effect movies play back at high speed.
- Sound is not recorded with movies.

## **Selective Color**



All colors other than the selected colors are recorded in black and white. Press **OK** to adjust settings (☞ 98).

### **Note**

The built-in flash and optional flash units are disabled.



## **Silhouette**



Silhouette subjects against bright backgrounds.

### **Note**

The built-in flash turns off.

## **High Key**



Use with bright scenes to create bright images that seem filled with light.

### **Note**

The built-in flash turns off.

## **Low Key**



Use with dark scenes to create dark, low-key images with prominent highlights.







### **Note**

The built-in flash turns off.



## Preventing Blur



Use a tripod to prevent blur caused by camera shake at slow shutter speeds.

## Special Effect Modes

- NEF (RAW) image quality options cannot be selected in , **VI**, **POP**, , , , and  modes.
- Some settings—for example, AF-area mode, Picture Controls, or white balance—cannot be changed depending on the mode selected.
- In  and  modes, the shooting display refresh rate will drop.



## ■■ Adjusting (Photo Illustration) Settings







To adjust line thickness, select  in special effects mode and then press .

- Press  to thin outlines or  to make them thicker.
- Press  to save changes; the selected effect will be applied during shooting.





## ■■ Adjusting (Toy Camera Effect) Settings

To adjust settings, select  in special effects mode and then press .

- Press  or  to highlight the desired setting.
- **Vividness:** Press  for more saturation,  for less.
- **Vignetting:** Press  for more vignetting,  for less.
- Press  to save changes; the selected effect will be applied during shooting.



## ■ Adjusting (Miniature Effect) Settings



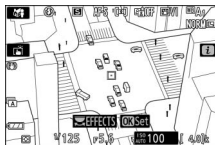

To adjust settings, select  in special effects mode and then press .

### 1 Position the focus point.

- Use the multi selector to position the focus point in the area that you want to be in focus.
- To check focus, press the shutter-release button halfway.



### 2 Choose the orientation and size of the area that will be in focus.

- Press  to view miniature effect options.
- Press  or  to choose the orientation of the area that will be in focus.
- Press  or  to choose the width of the area that will be in focus.

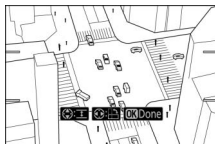



### 3 Save changes.

- Press  to save changes; the selected effect will be applied during shooting.





#### Movies

Miniature effect movies play back at high speed. For example, approximately 15 minutes of footage shot with 1920 × 1080/30p selected for **Frame size/frame rate** in the movie shooting menu ( 258) will play back in about a minute.

## ■ ■ Adjusting *(Selective Color) Settings*

To adjust settings, select  in special effects mode and then press .



### 1 Select colors.

- Press  to view selective color options.
- Frame an object of the desired color in the white square at the center of the display.
- To zoom in on the center of the display for more precise color selection, tap the  button. Tap the  button to zoom out.
- Press  to choose the color of the object in the white square as one that will be recorded in color when photographs are taken; the selected color will appear in the first of the numbered color boxes.
- All colors other than those selected in the color boxes will appear in black and white.

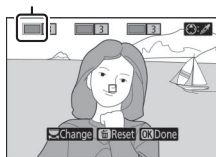
*Selected color*



### 2 Choose the color range.



- Press  or  to increase or decrease the range of similar hues that will be included in photographs; choose from values between **1** and **7**. The higher the value, the wider the range of colors that will be included; the lower the value, the lower the range of colors that will be included.

*Color range*



---

### 3 Select additional colors.

- To select additional colors, rotate the main command dial to highlight another of the numbered color boxes and repeat Steps 1 and 2.
- Up to 3 colors can be selected.
- To deselect the highlighted color, press .
- To remove all colors, press and hold . A confirmation dialog will be displayed; select **Yes**.



---

### 4 Save changes.

- Press  to save changes; the selected effect will be applied during shooting.

#### **Note: Selective Color**

- The camera may have difficulty detecting some colors. Saturated colors are recommended.
- Higher values for color range may include hues from other colors.

## The ISO (ISO Sensitivity) Button

Hold the **ISO** button and rotate the main command dial to adjust the camera's sensitivity to light according to the amount of light available. The current setting is shown in the shooting display. Choose from settings of from ISO 100 to ISO 51200; settings about 1 and 2 EV above 51200 are also available for special situations. **SCN** mode and all **EFCT** modes apart from  offer an additional **ISO-A** (auto) option.

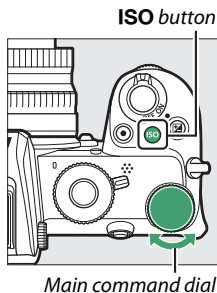

### ✓ ISO Sensitivity

The higher the ISO sensitivity, the less light needed to make an exposure, allowing faster shutter speeds or smaller apertures, but the more likely the image is to be affected by noise (randomly-spaced bright pixels, fog, or lines). Noise is particularly likely at settings of **Hi 1** and **Hi 2**.

### ✓ Hi 1 and Hi 2

**Hi 1** and **Hi 2** correspond respectively to ISO sensitivities 1 and 2 EV over the highest numerical value. **Hi 1** is equivalent to ISO 102400, **Hi 2** to ISO 204800.

## Auto ISO Sensitivity Control

In modes **P**, **S**, **A**, and **M**, auto ISO sensitivity control can be enabled or disabled by holding the **ISO** button and rotating the sub-command dial. When auto ISO sensitivity control is enabled, ISO sensitivity will automatically be adjusted if optimal exposure cannot be achieved at the value selected with the **ISO** button and main command dial. To prevent ISO sensitivity going too high, you can choose an upper limit of from ISO 200 to Hi 2 using the **ISO sensitivity settings** > **Maximum sensitivity** item in the photo shooting menu.

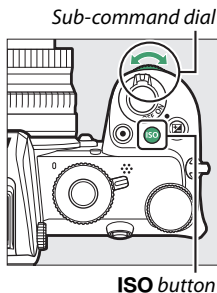

When auto ISO sensitivity control is enabled, the shooting display will show **ISO AUTO**. When sensitivity is altered from the value selected by the user, the altered value is shown in the display.



### **✓ Auto ISO Sensitivity Control**

If the ISO sensitivity selected by the user is higher than that chosen for **Maximum sensitivity** when auto ISO sensitivity control is enabled, the value selected by the user will be used instead. When a flash is used, shutter speed will be restricted to values between the speed selected for Custom Setting e1 (**Flash sync speed**) and the speed selected for Custom Setting e2 (**Flash shutter speed**).

## The (Exposure Compensation) Button

In modes other than **AUTO**, exposure compensation can be used to alter exposure from the value suggested by the camera, making pictures brighter or darker. Choose from values between  $-5$  EV (underexposure) and  $+5$  EV (overexposure) for photographs, or between  $-3$  and  $+3$  EV for movies. By default, adjustments to exposure compensation are made in increments of  $\frac{1}{3}$  EV. This can be changed to  $\frac{1}{2}$  EV using Custom Setting b1 (**EV steps for exposure cntrl**). In general, positive values make the subject brighter while negative values make it darker.



$-1$  EV



No exposure  
compensation



$+1$  EV



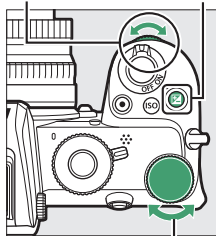

To choose a value for exposure compensation, press the  button and rotate a command dial until the desired value is displayed.

Sub-  
command  
dial  button



Main command dial



At values other than  $\pm 0.0$ , the camera displays a  icon (movie mode) or a  icon and the exposure indicator (photo mode) after you release the  button. The current value for exposure compensation can be confirmed by pressing the .

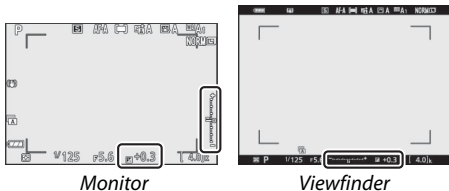

Normal exposure can be restored by setting exposure compensation to  $\pm 0$ . Except in **SCN** and **EFCT** modes, exposure compensation is not reset when the camera is turned off (in **SCN** and **EFCT** modes, exposure compensation will be reset when another mode is selected or the camera is turned off).

#### Mode M

In mode **M**, exposure compensation affects only the exposure indicator; shutter speed and aperture do not change. The exposure indicator and the current value for exposure compensation can be displayed by pressing the .

#### Flash Photography

When the built-in flash or an optional flash unit is used, exposure compensation affects both flash level and exposure, altering the brightness of both the main subject and the background. Custom Setting e3 (**Exposure comp. for flash**) can be used to restrict the effects of exposure compensation to the background only.

## The $\overset{\text{AE-L}}{\underset{\text{AF-L}}{\text{O}}}$ (O) Button

Press the  $\overset{\text{AE-L}}{\underset{\text{AF-L}}{\text{O}}}$  (O) button to lock focus and exposure.

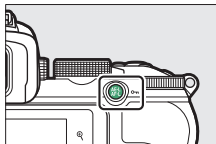

### Autoexposure (AE) Lock

Pressing the  $\overset{\text{AE-L}}{\underset{\text{AF-L}}{\text{O}}}$  (O) button locks exposure at the current setting. AE lock can be used to recompose shots after metering a subject that will not be in the selected focus area in the final composition, and is particularly effective with spot or center-weighted metering.

### Focus Lock

Press the  $\overset{\text{AE-L}}{\underset{\text{AF-L}}{\text{O}}}$  (O) button to lock focus on the current subject when **AF-C** is selected for focus mode. When using focus lock, choose an AF-area mode other than auto-area AF.

## ■ ■ Locking Focus and Exposure

Follow the steps below to use focus and exposure lock.

### 1 Set focus and exposure.

Position the subject in the selected focus point and press the shutter-release button halfway to set focus and exposure.

### 2 Lock focus and exposure.

With the shutter-release button pressed halfway, press the  $\text{AE-L/AF-L}$  ( $\text{O-m}$ ) button to lock both focus and exposure (an **AE-L** icon will be displayed).

Shutter-release button

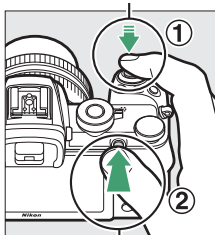

$\text{AE-L/AF-L}$  ( $\text{O-m}$ ) button

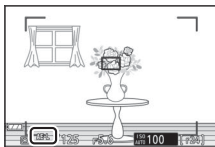

### 3 Recompose the photograph and shoot.

Focus will remain locked between shots if you keep the shutter-release button pressed halfway (**AF-S**) or keep the  $\text{AE-L/AF-L}$  (**○/■**) button pressed, allowing several photographs in succession to be taken at the same focus setting.

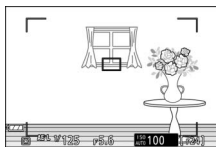

Do not change the distance between the camera and the subject while focus lock is in effect. If the subject moves, focus again at the new distance.

#### ✓ **AF-S**

When **AF-S** is selected for focus mode, or if the camera is shooting using **AF-S** when **AF-A** is selected for focus mode, the focus will lock while the shutter-release button is pressed halfway (focus will also lock while the  $\text{AE-L/AF-L}$  (**○/■**) button is pressed).

#### ✓ **Using the Shutter-Release Button for Exposure Lock**

If **On (half press)** is selected for Custom Setting c1 (**Shutter-release button AE-L**), exposure will lock while the shutter-release button is pressed halfway.

## The Built-In Flash

You'll find that the built-in flash enhances the photographic experience in a variety of situations, including when lighting is poor or when you need to fill in shadows and backlit subjects. Before using the built-in flash, raise it by sliding the flash pop-up control.

- 1 Slide the flash pop-up control to raise the built-in flash.

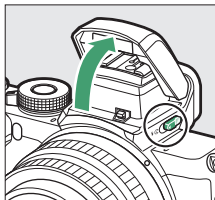

























- 2 Choose a flash mode. Select **Flash mode** in the *i* or photo shooting menu and choose a flash mode.













- 3 Take a picture after pressing the shutter-release button halfway to focus.

## Flash Modes

Use the **Flash mode** option in the **i** or photo shooting menu to choose the effect produced by the flash. The options available vary with the shooting mode selected.

Option	Description	Available in
	<b>Fill flash</b> (front-curtain sync): The flash fires with every shot.	P, S, A, M
	<b>Red-eye reduction:</b> Use for portraits. The red-eye reduction lamp lights before the flash fires to help reduce “red-eye”.	P, S, A, M
	<b>Slow sync:</b> As for “fill flash”, except that shutter speed slows automatically to capture background lighting at night or under low light.	P, A
	<b>Slow sync + red-eye:</b> Use for portraits or similar shots taken against a night or evening backdrop. In addition to performing red-eye reduction, the camera uses slow shutter speeds to capture background lighting.	P, A
	<b>Rear-curtain sync:</b> Normally the flash fires as the shutter opens (front-curtain sync); in rear-curtain sync, the flash fires just before the shutter closes. Slow sync is automatically enabled in modes P and A.	P, S, A, M
	<b>Auto:</b> The flash fires automatically as required when lighting is poor or the subject is backlit.	AUTO,  ,  ,  ,  ,  ,  ,  , VI, POP,  , 
	<b>Auto + red-eye reduction:</b> As for “red-eye reduction”, except that the flash fires only as required.	AUTO,  ,  ,  ,  ,  ,  ,  , VI, POP,  , 

Option	Description	Available in
	<b>Auto slow sync:</b> As for “slow sync”, except that the flash fires only as required.	
	<b>Auto slow sync + red-eye:</b> As for “slow-sync + red-eye”, except that the flash fires only as required.	
	<b>Flash off:</b> The flash does not fire.	AUTO, P, S, A, M,  ,  ,  ,  , VI, POP,  , 

### Lowering the Built-In Flash

To save power when the flash is not in use, press it gently downward until the latch clicks into place.

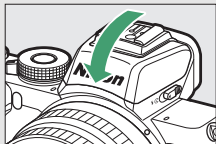













### Using the Built-In Flash

- Remove lens hoods to prevent shadows.
- If the built-in flash is used with continuous low-speed or continuous high-speed selected for release mode, only one picture will be taken each time the shutter-release button is pressed. Selecting continuous high-speed (extended) enables burst photography and disables the built-in flash.
- The shutter release may be briefly disabled to protect the flash after it has been used for several consecutive shots. The flash can be used again after a short pause.

### ✓ Shutter Speeds Available with the Built-In Flash

Shutter speed can be set as follows when the built-in-flash unit is used:

Mode	Shutter speed
         	Set automatically by camera ( $\frac{1}{200}$ s– $\frac{1}{60}$ s)
	Set automatically by camera ( $\frac{1}{200}$ s– $\frac{1}{30}$ s)
	Set automatically by camera ( $\frac{1}{200}$ s–2 s)
P, A	Set automatically by camera ( $\frac{1}{200}$ s– $\frac{1}{60}$ s)*
S	$\frac{1}{200}$ s–30 s
M	$\frac{1}{200}$ s–30 s, <b>Bulb, Time</b>

\* Shutter speed may be set as slow as 30 s if slow sync, rear-curtain sync, or slow sync with red-eye reduction is selected for flash mode.

### ✓ Aperture, Sensitivity, and Flash Range

Flash range varies with sensitivity (ISO equivalency) and aperture.

Aperture at ISO equivalent of											Approximate range	
100	200	400	800	1600	3200	6400	12800	25600	51200		m	ft
1.4	2	2.8	4	5.6	8	11	16	22	32	0.7–5.0	2 ft 4 in.–16 ft 5 in.	
2	2.8	4	5.6	8	11	16	22	32	—	0.6–3.5	2 ft–11 ft 6 in.	
2.8	4	5.6	8	11	16	22	32	—	—	0.6–2.5	2 ft–8 ft 3 in.	
4	5.6	8	11	16	22	32	—	—	—	0.6–1.8	2 ft–5 ft 11 in.	
5.6	8	11	16	22	32	—	—	—	—	0.6–1.3	2 ft–4 ft 3 in.	
8	11	16	22	32	—	—	—	—	—	0.6–0.9	2 ft–3 ft	

\* The flash has a minimum range of about 0.6 m (2 ft).



## Flash Compensation

Flash compensation is used to alter flash output by from  $-3$  EV to  $+1$  EV, changing the brightness of the main subject relative to the background. By default, adjustments to exposure compensation are made in increments of  $\frac{1}{3}$  EV. This can be changed to  $\frac{1}{2}$  EV using Custom Setting b1 (**EV steps for exposure cntrl**). Flash output can be increased to make the main subject appear brighter, or reduced to prevent unwanted highlights or reflections. In general, choose positive values to make the main subject brighter, negative values to make it darker.

To choose a value for flash compensation, use the **Flash compensation** item in the photo shooting menu. At values other than  $\pm 0.0$ , a  icon will appear in the shooting display.



Normal flash output can be restored by setting flash compensation to  $\pm 0.0$ . Flash compensation is not reset when the camera is turned off.

## **FV Lock**

This feature is used to lock flash output, allowing photographs to be recomposed without changing the flash level and ensuring that flash output is appropriate to the subject even when the subject is not positioned in the center of the frame. Flash output is adjusted automatically for any changes in ISO sensitivity and aperture. FV lock is not available in **AUTO**, **SCN**, and **EFCT** modes.

To use FV lock:

- 1 Assign FV lock to a camera control.**  
Assign **FV lock** to a control using Custom Setting f2 (**Custom controls (shooting)**).

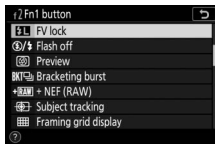

- 2 Raise the flash.**  
Slide the flash pop-up control to raise the built-in flash.

- 3 Focus.**  
Position the subject in the center of the frame and press the shutter-release button halfway to focus.



---

## 4 Lock flash level.

After confirming that the flash-ready indicator (⚡) appears in the camera display, press the control selected in Step 1. The flash unit will emit a monitor pre-flash to determine the appropriate flash level. Flash output will be locked at this level and FV lock icon (🔒) will appear in the camera display.



---

## 5 Recompose the photograph.

Flash output will remain locked at the value metered in Step 4.



---

## 6 Take the photograph.

Press the shutter-release button the rest of the way down to shoot. If desired, additional pictures can be taken without releasing FV lock.

---

## 7 Release FV lock.

Press the control selected in Step 1 to release FV lock. Confirm that the FV lock icon (🔒) is no longer displayed.

### Optional Flash Units

Turn the flash unit on and select **TTL for Flash control > Flash control mode (external)** (SB-500, SB-400, or SB-300) or set the flash control mode to TTL, monitor pre-flash , or monitor pre-flash A (other flash units; see the documentation provided with the flash unit for details).

# The *i* Menu

Pressing the *i* button displays the *i* menu: a menu of frequently-used settings for the current mode.

## Using the *i* Menu

Press the *i* button to display the *i* menu.

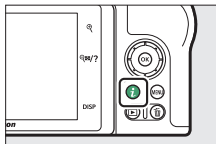

Highlight items using the multi selector and press **OK** to view options, then highlight an option and press **OK** to select it and return to the *i* menu (to exit to the previous display without changing settings, press the *i* button).

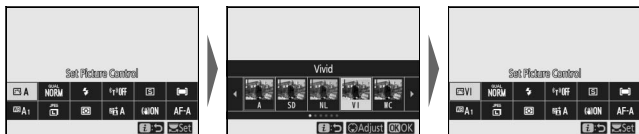

### The Command Dials

You can also adjust settings for highlighted items by rotating the main command dial to choose an option and then pressing **OK** (sub-options, if available, can be selected by rotating the sub-command dial; in some cases, the same options can be selected using either dial). The current option will also be selected if you highlight another item with the multi selector or press the shutter-release button halfway.



## The Photo-Mode *i* Menu



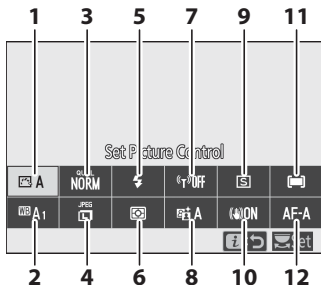







At default settings, the following items appear in the *i* menu for photo mode.





<b>1</b> Set Picture Control.....	116	<b>7</b> Wi-Fi connection.....	132
<b>2</b> White balance.....	120	<b>8</b> Active D-Lighting .....	133
<b>3</b> Image quality.....	126	<b>9</b> Release mode .....	135
<b>4</b> Image size.....	128	<b>10</b> Optical VR.....	139
<b>5</b> Flash mode .....	129	<b>11</b> AF-area mode .....	140
<b>6</b> Metering .....	131	<b>12</b> Focus mode.....	140

## Set Picture Control

Choose a Picture Control according to the subject or type of scene.

Option	Description
 <b>A Auto</b>	The camera automatically adjusts hues and tones based on the <b>Standard</b> Picture Control. The complexions of portrait subjects will appear softer, and such elements as the foliage and sky in outdoor shots more vivid, than in pictures taken with the <b>Standard</b> Picture Control.
 <b>SD Standard</b>	Standard processing for balanced results. Recommended for most situations.
 <b>NL Neutral</b>	Minimal processing for natural results. Choose for photographs that will later be processed or retouched.
 <b>VI Vivid</b>	Pictures are enhanced for a vivid, photoprint effect. Choose for photographs that emphasize primary colors.
 <b>MC Monochrome</b>	Take monochrome photographs.
 <b>PT Portrait</b>	Process portraits for skin with natural texture and a rounded feel.
 <b>LS Landscape</b>	Produces vibrant landscapes and cityscapes.
 <b>FL Flat</b>	Details are preserved over a wide tone range, from highlights to shadows. Choose for photographs that will later be extensively processed or retouched.
 <b>01– Creative Picture Control</b>  <b>20</b>	Choose from the following Picture Controls, each a unique combination of hue, tone, saturation, and other settings tuned for a particular effect: <b>Dream, Morning, Pop, Sunday, Sombre, Dramatic, Silence, Bleached, Melancholic, Pure, Denim, Toy, Sepia, Blue, Red, Pink, Charcoal, Graphite, Binary, and Carbon.</b>

To view Picture Control settings, highlight a Picture Control and press . Changes to settings can be previewed in the display ( 118).

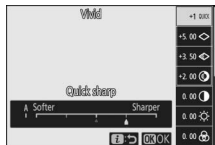

The current Picture Control is indicated by an icon in the display during shooting.



## ■ Modifying Picture Controls

Picture Controls can be modified to suit the scene or the photographer's creative intent. Highlight **Set Picture Control** in the **i** menu and press **OK** to display the Picture Control list, then highlight a Picture Control and press **▼** to display Picture Control settings. Press **▲** or **▼** to highlight the desired setting and press **◀** or **▶** to choose a value in increments of 1, or rotate the sub-command dial to choose a value in increments of 0.25 (the options available vary with the Picture Control selected). Default settings can be restored by pressing the **🗑️** button.

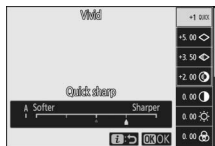

After adjusting settings to your satisfaction, press **OK** to put the changes into effect and return to the **i** menu. Picture Controls that have been modified from default settings are indicated by an asterisk ("**\***").

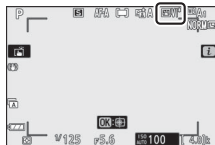

### ✓ Previous Settings

The **Δ** indicator under the value display in the Picture Control setting menu indicates the previous value for the setting.



### ✓ "A" (Auto)

Selecting the **A** (auto) option available for some settings lets the camera adjust the setting automatically. Results vary with exposure and the position of the subject in the frame.

### ✓ The "A Auto" Picture Control

If **A Auto** is selected for Set Picture Control, settings can be adjusted in the range **A-2** to **A+2**.

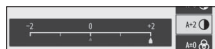



The following settings are available:

Option	Description
<b>Effect level</b>	Mute or heighten the effect of Creative Picture Control.
<b>Quick sharp</b>	Quickly adjust levels for balanced <b>Sharpening</b> , <b>Mid-range sharpening</b> , and <b>Clarity</b> . You can also make individual adjustments to the following parameters:
<b>Sharpening</b>	<ul style="list-style-type: none"> <li>• <b>Sharpening</b>: Control the sharpness of details and outlines.</li> </ul>
<b>Mid-range sharpening</b>	<ul style="list-style-type: none"> <li>• <b>Mid-range sharpening</b>: Adjust sharpness according to the fineness of the patterns and lines in mid-tones affected by <b>Sharpening</b> and <b>Clarity</b>.</li> </ul>
<b>Clarity</b>	<ul style="list-style-type: none"> <li>• <b>Clarity</b>: Adjust overall sharpness and the sharpness of thicker outlines without affecting brightness or dynamic range.</li> </ul>
<b>Contrast</b>	Adjust contrast.
<b>Brightness</b>	Raise or lower brightness without loss of detail in highlights or shadows.
<b>Saturation</b>	Control the vividness of colors.
<b>Hue</b>	Adjust hue.
<b>Filter effects</b>	Simulate the effect of color filters on monochrome pictures.
<b>Toning</b>	Choose the tint used in monochrome pictures. Pressing  when an option other than <b>B&amp;W</b> (black-and-white) is selected displays saturation options.
<b>Toning</b> (Creative Picture Control)	Adjust the shade of color used for Creative Picture Controls.









### Filter Effects

Choose from the following:

Mode	Setting
<b>Y</b> (yellow)	These options enhance contrast and can be used to tone down the brightness of the sky in landscape photographs. Orange produces more contrast than yellow, red more contrast than orange.
<b>O</b> (orange)	
<b>R</b> (red)	
<b>G</b> (green)	Green softens skin tones and can be used for portraits.

## White Balance

Adjust white balance (for more information, see “White Balance”, □ 67).

Option	Option
 <b>A</b> Auto	 <b>Fluorescent</b>
Keep white (reduce warm colors)	Sodium-vapor lamps
Keep overall atmosphere	Warm-white fluorescent
Keep warm lighting colors	White fluorescent
 <b>A</b> Natural light auto	Cool-white fluorescent
 <b>Direct sunlight</b>	Day white fluorescent
 <b>Cloudy</b>	Daylight fluorescent
 <b>Shade</b>	High temp. mercury-vapor
 <b>Incandescent</b>	 <b>Flash</b>
	 <b>Choose color temperature</b>
	<b>PRE</b> Preset manual

Pressing  when **Auto** or **Fluorescent** is highlighted displays sub-options for the highlighted item.



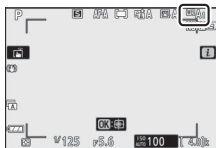

The current white balance option is indicated by an icon in the display during shooting.

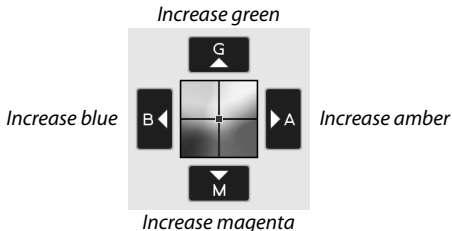

## ■ Fine-Tuning White Balance

Selecting **White balance** in the **i** menu displays a list of white balance options. If an option other than **Choose color temperature** is highlighted, fine-tuning options can be displayed by pressing . Any changes to fine-tuning options can be previewed in the display.



Tap the arrows in the display or use the multi selector to fine-tune white balance. Press  to save settings and return to the **i** menu.

An asterisk ("**\***") next to the white balance icon in the shooting display indicates that fine-tuning is in effect.

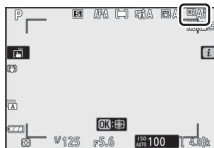

## ■ Choosing a Color Temperature



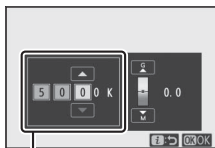

Selecting **White balance** in the **i** menu displays a list of white balance options. When **Choose color temperature** is highlighted, color temperature options can be viewed by pressing .



Value for  
Amber-Blue axis



Value for  
Green-Magenta axis

Press  or  to highlight digits on the **Amber-Blue** or **Green-Magenta** axis and press  or  to change. Press  to save settings and return to the **i** menu. If a value other than zero is selected for the **Green-Magenta** axis, an asterisk (“\*”) will be displayed next to the white balance icon.

### Choose Color Temperature

Note that the desired results will not be obtained with fluorescent lighting. Choose  (**Fluorescent**) for fluorescent light sources. With other light sources, take a test shot to determine if the selected value is appropriate.

## ■ Preset Manual

Preset manual is used to record and recall up to six custom white balance settings for shooting under mixed lighting or to compensate for light sources with a strong color cast. Follow the steps below to measure a value for preset manual white balance.

### 1 Display white balance presets.

Highlight **Preset manual** in the **i** menu white balance display and press  $\odot$  to display a list of white balance presets.



### 2 Select a preset.

Highlight the desired white balance preset (d-1 to d-6) and press  $\odot$  to select the highlighted preset and return to the **i** menu.



#### ✓ Protected Presets

Presets indicated by a **⊞** icon are protected and cannot be changed.

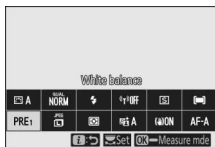

### 3 Select direct measurement mode.

Highlight **White balance** in the **i** menu and press and hold  $\odot$  until the **PRE** icon in the shooting display starts to flash and the white balance target ( $\square$ ) appears in the center of the frame.



---

## 4 Measure white balance.

To measure white balance, tap a white or gray object, or use the multi-selector to position the  over a white or gray area of the display and either press  or press the shutter-release button all the way down (note that the  cannot be repositioned when the built-in flash is enabled or an optional flash unit is attached, in which case you will need to measure white balance with a white or gray object positioned in the center of the frame).



If the camera is unable to measure white balance, a message will be displayed. Try measuring white balance again with a different target.



---

## 5 Exit direct measurement mode.

Press the  button to exit direct measurement mode.

### ✔ Measuring Preset Manual White Balance

Preset manual white balance cannot be measured while HDR or multiple exposure shooting is in progress.

### ✔ Direct Measurement Mode

Direct measurement mode will end if no operations are performed in the time selected for Custom Setting c3 (**Power off delay**) > **Standby timer**.

### ✔ Managing Presets

The **White balance** > **Preset manual** option in the photo shooting menu can be used to copy white balance from an existing photograph to a selected preset, add comments, or to protect presets.

### ✔ Preset Manual: Selecting a Preset

To choose a preset, select **White balance** > **Preset manual** in the photo shooting menu, then highlight a preset and press **OK**. If no value currently exists for the selected preset, white balance will be set to 5200 K, the same as **Direct sunlight**.



## Image Quality

Choose a file format for photographs.

Option	Description
<b>NEF (RAW) + JPEG fine</b>	Record two copies of each photo: an NEF (RAW) image and a JPEG copy. Only the JPEG copy is displayed during playback, but deleting the JPEG copy also deletes the NEF (RAW) image. The NEF (RAW) image can only be viewed using a computer.
<b>NEF (RAW) + JPEG normal</b>	
<b>NEF (RAW) + JPEG basic</b>	
<b>NEF (RAW)</b>	Record photos in NEF (RAW) format.
<b>JPEG fine</b>	Record photos in JPEG format. Compression increases and file size decreases as quality progresses from “fine” through “normal” to “basic”.
<b>JPEG normal</b>	
<b>JPEG basic</b>	

The option currently selected is shown in the display during shooting.

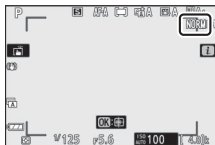



### NEF (RAW)

- NEF (RAW) files have the extension “\*.nef”.
- The process of converting NEF (RAW) pictures to other highly-portable formats such as JPEG is referred to as “NEF (RAW) processing”. During this process, Picture Controls and settings such as exposure compensation and white balance can be freely adjusted.
- The RAW data themselves are unaffected by NEF (RAW) processing and their quality will remain intact even if the pictures are processed multiple times at different settings.
- NEF (RAW) processing can be performed in-camera using the **NEF (RAW) processing** item in the retouch menu or on a computer using Nikon’s NX Studio software. NX Studio is available free-of-charge from the Nikon Download Center.

## Image Size

Choose the size at which photographs are recorded.

The option currently selected is shown in the display during shooting.

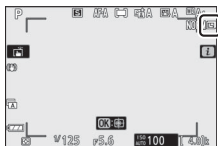

The physical dimensions of the photos in pixels vary with the option selected for **Choose image area** in the photo shooting menu.

		Image size		
		Large	Medium	Small
Image area	DX (24 × 16)	5568 × 3712	4176 × 2784	2784 × 1856
	1 : 1 (16 × 16)	3712 × 3712	2784 × 2784	1856 × 1856
	16 : 9 (24 × 14)	5568 × 3128	4176 × 2344	2784 × 1560

## Flash Mode

Choose a flash mode for the built-in flash. The options available depend on the mode selected with the mode dial.

















































Option	Available in	Option	Available in
<b>Fill flash</b>	P, S, A, M	<b>Auto + red-eye reduction</b>	AUTO,       VI, POP,   TOY
<b>Red-eye reduction</b>			
<b>Slow sync</b>	P, A	<b>Auto slow sync</b>	
<b>Slow sync + red-eye</b>			
<b>Rear-curtain sync</b>	P, S, A, M	<b>Flash off</b>	AUTO, P, S, A, M,       VI, POP,   TOY
<b>Auto</b>	AUTO,       VI, POP,   TOY		

The option currently selected is indicated by an icon in the display during shooting.







## Flash Modes Available with Optional Flash Units

The flash modes available when an optional flash unit is attached vary with the mode selected with the mode dial.

	Option	Available in
	Fill flash	AUTO, P, S, A, M,  ,  ,  ,  ,  ,  ,  ,  ,  ,  ,  ,  , VI, POP,  ,  ,  ,  ,  , 
	Red-eye reduction	AUTO, P, S, A, M,  ,  ,  ,  ,  ,  ,  ,  ,  ,  ,  ,  , VI, POP,  ,  ,  ,  , 
	Slow sync	P, A, 
	Slow sync + red-eye	P, A, 
	Rear-curtain sync	P, S, A, M
	Auto	—
	Auto + red-eye reduction	—
	Auto slow sync	—
	Auto slow sync + red-eye	—
	Flash off	AUTO,  , P, S, A, M

## Metering

Metering determines how the camera sets exposure. The following options are available:

Option	Description
 <b>Matrix metering</b>	The camera meters a wide area of the frame and sets exposure according to tone distribution, color, composition, and distance for results close to those seen by the naked eye.
 <b>Center-weighted metering</b>	The camera meters the entire frame but assigns the greatest weight to an area in the center of the frame, the size of which can be chosen using Custom Setting b3 ( <b>Center-weighted area</b> ). This is the classic meter for portraits and is also recommended when using filters with an exposure factor (filter factor) over 1x.
 <b>Spot metering</b>	The camera meters a $\phi 3.5$ mm circle (equivalent to approximately 2.5% of the frame) centered on the current focus point, making it possible to meter off-center subjects (if auto-area AF is in effect, the camera will instead meter the center focus point). Spot metering ensures that the subject will be correctly exposed, even when the background is much brighter or darker.
 * <b>Highlight-weighted metering</b>	The camera assigns the greatest weight to highlights. Use this option to reduce loss of detail in highlights, for example when photographing spotlight performers on-stage.

The option currently selected is indicated by an icon in the display during shooting.



## **Wi-Fi Connection**

Enable or disable Wi-Fi. Enable Wi-Fi to establish wireless connections to computers or between the camera and smartphones or tablets (smart devices) running the SnapBridge app.

The camera displays a Wi-Fi icon when Wi-Fi is enabled.

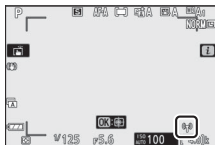

To turn Wi-Fi off, highlight **Wi-Fi connection** in the **i** menu and press **OK**. If Wi-Fi is currently enabled, a **Close Wi-Fi connection** prompt will be displayed; press **OK** to end the connection.

## Active D-Lighting

Active D-Lighting preserves details in highlights and shadows, creating photographs with natural contrast. Use for high-contrast scenes, for example when photographing brightly lit outdoor scenery through a door or window or taking pictures of shaded subjects on a sunny day. It is most effective when used with matrix metering.

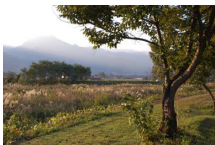

*Off*



**☺ A Auto**

Option	Description
<b>☺ A Auto</b>	The camera automatically adjusts Active D-Lighting in response to shooting conditions (in mode M, however, <b>☺ A Auto</b> is equivalent to <b>☺ N Normal</b> ).
<b>☺ H<sup>+</sup> Extra high</b>	Choose the amount of Active D-Lighting performed from <b>☺ H<sup>+</sup> Extra high</b> , <b>☺ H High</b> , <b>☺ N Normal</b> , and <b>☺ L Low</b> .
<b>☺ H High</b>	
<b>☺ N Normal</b>	
<b>☺ L Low</b>	
<b>☺ OFF Off</b>	Active D-Lighting off.

The option currently selected is indicated by an icon in the display during shooting.

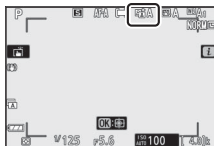







### **Active D-Lighting**

Noise (randomly-spaced bright pixels, fog, or lines) may appear in photos taken with Active D-Lighting. Uneven shading may be visible with some subjects. Active D-Lighting does not apply at high ISO sensitivities (Hi 1 and Hi 2), including high sensitivities selected via auto ISO sensitivity control.



## Release Mode

Choose the operation performed when the shutter-release button is pressed all the way down.

Option	Description
 <b>Single frame</b>	The camera takes one photograph each time the shutter-release button is pressed.
 <b>Continuous L</b>	While the shutter-release button is held down, the camera records 1–4 frames per second. The frame rate can be chosen by rotating the sub-command dial when <b>Continuous L</b> is highlighted in the release-mode menu.
 <b>Continuous H</b>	While the shutter-release button is held down, the camera records up to about 5 frames per second.
 <b>Continuous H (extended)</b>	While the shutter-release button is held down, the camera records up to about 11 frames per second. The built-in flash and optional flash units cannot be used. Flicker reduction has no effect.
 <b>Self-timer</b>	Take pictures with the self-timer (  138).

Pressing  when **Continuous L** is highlighted displays frame advance rate options.



The current release mode is shown by an icon in the shooting display.

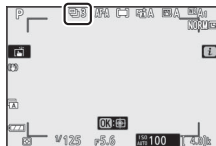

### ✔ The Shooting Display

In continuous low-speed and continuous high-speed modes, the display is updated in real time even while shooting is in progress.

### ✔ Frame Advance Rate

Frame advance rate varies with camera settings. The approximate maximum rates at different settings are given in the table below.

Release mode	Image quality	Bit depth	Silent photography	
			Off	On
Continuous L	JPEG	—	User-selected	
	NEF (RAW)/ NEF (RAW) + JPEG	12		
		14		
Continuous H	JPEG	—	5 fps	4.5 fps
	NEF (RAW)/ NEF (RAW) + JPEG	12		4 fps
		14		
Continuous H (extended)	JPEG	—	11 fps*	11 fps
	NEF (RAW)/ NEF (RAW) + JPEG	12		8.5 fps
		14		

\* 10 fps when **Electronic front-curtain shutter** is selected for Custom Setting d4 (**Shutter type**).

### ✔ Continuous H (Extended)

Depending on camera settings, exposure may vary erratically during each burst. This can be prevented by locking exposure (☐ 105).

### ✓ The Memory Buffer

The camera is equipped with a memory buffer for temporary storage, allowing shooting to continue while photographs are being saved to the memory card. The approximate number of images that can be stored in the buffer at current settings is shown in the exposure-count displays while the shutter-release button is pressed halfway.



While photographs are being recorded to the memory card, the memory card access lamp will light. Depending on shooting conditions and memory card performance, recording may take from a few seconds to a few minutes. *Do not remove the memory card or remove the battery until the access lamp has gone out.* If the camera is switched off while data remain in the buffer, the power will not turn off until all images in the buffer have been recorded. If the battery is exhausted while images remain in the buffer, the shutter release will be disabled and the images transferred to the memory card.

## ■ The Self-Timer

In self-timer mode, pressing the shutter-release button starts a timer, and a photo is taken when the timer expires.

- 1 **Select Release mode in the *i* menu, highlight Self-timer, and press .**

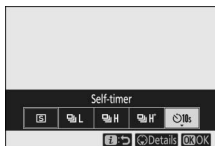

- 2 **Choose the self-timer release delay and number of shots.**

Press  when settings complete.

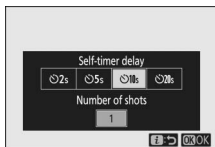

- 3 **Frame the photograph and focus.**

In release-priority focus modes, including **AF-S**, the timer will not start unless the camera is able to focus.



- 4 **Start the timer.**

Press the shutter-release button all the way down to start the timer. A  icon will appear in the display and the self-timer lamp will start to flash, stopping two seconds before the photograph is taken.

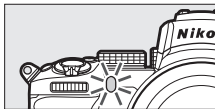



### Taking Multiple Shots

Use Custom Setting c2 (**Self-timer**) to choose the number of shots taken, and the interval between the shots taken, when the self-timer finishes counting down.

## Optical VR

Choose whether to enable optical vibration reduction. The options available vary with the lens.

Option	Description
 <b>Normal</b> (VR enabled)	Choose for enhanced optical vibration reduction when photographing static subjects.
 <b>Sport</b>	Choose when photographing athletes and other subjects that are moving rapidly and unpredictably.
 <b>Off</b>	Optical vibration reduction off.

Options other than **Off** are shown by an icon in the display during shooting.

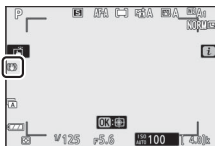





### Optical VR

**Optical VR** may be unavailable with some lenses. When using vibration reduction, wait for the image in the display to stabilize before shooting. With some lenses, the image in the display may also jiggle after the shutter is released; this is normal and does not indicate a malfunction. Note that the settings for lenses with optical vibration reduction mounted on a tripod or monopod may vary with the lens; see the lens manual for details.

**Normal** or **Sport** is recommended for panning shots. In **Normal** and **Sport** modes, optical vibration reduction applies only to motion that is not part of the pan (if the camera is panned horizontally, for example, optical vibration reduction will be applied only to vertical shake).

## AF-Area Mode

AF-area mode controls how the camera selects the focus-point for autofocus. For more information, see “AF-Area Mode” ( 54).

Option	Option
 <b>Pinpoint AF</b>	 <b>Wide-area AF (S)</b>
 <b>Single-point AF</b>	 <b>Wide-area AF (L)</b>
 <b>Dynamic-area AF</b>	 <b>Auto-area AF</b>

The option currently selected is shown by an icon in the display during shooting.

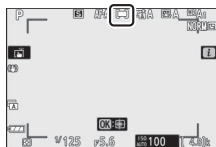

## Focus Mode

The focus mode controls how the camera focuses. For more information, see “Choosing a Focus Mode” ( 51).

Option	Option
<b>AF-A</b> AF mode auto-switch	<b>AF-C</b> Continuous AF
<b>AF-S</b> Single AF	<b>MF</b> Manual focus

The option currently selected is shown by an icon in the display during shooting.

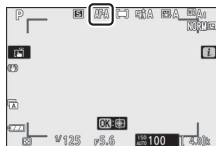

## The Movie-Mode *i* Menu

At default settings, the following items appear in the *i* menu for movie mode.

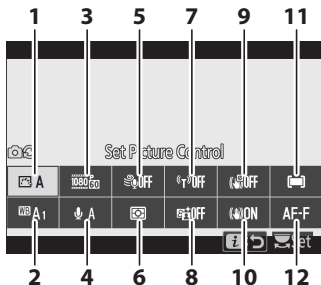

1	Set Picture Control.....	142	7	Wi-Fi connection.....	147
2	White balance.....	142	8	Active D-Lighting .....	147
3	Frame size and rate/ image quality .....	143	9	Electronic VR.....	147
4	Microphone sensitivity.....	145	10	Optical VR.....	148
5	Wind noise reduction .....	146	11	AF-area mode .....	148
6	Metering .....	147	12	Focus mode.....	148

### "Same as Photo Settings"

If **Same as photo settings** is selected for **Set Picture Control**, **White balance**, **Active D-Lighting**, or **Optical VR** in the movie shooting menu, a  icon will appear at the top left corner of the *i* menu, indicating that the options selected for these settings in photo mode also apply in movie mode and vice versa.



## **Set Picture Control**

Choose a Picture Control for movie recording. For more information, see “Set Picture Control” (📖 116).

## **White Balance**

Adjust white balance for movie recording. For more information, see “White Balance” (📖 67, 120).



## Frame Size, Frame Rate, and Movie Quality

Select the movie frame size (in pixels) and frame rate. You can also choose from two **Movie quality** options: **High quality** (indicated by frame size/rate icons with “★”) and **Normal**. Together, these options determine the maximum bit rate, as shown in the following table.

Frame size/frame rate <sup>1</sup>	Max. bit rate (Mbps)		Max. recording time
	High quality	Normal	
3840 × 2160 (4K UHD); 30p	144	— <sup>2</sup>	29 min. 59 s <sup>4</sup>
3840 × 2160 (4K UHD); 25p			
3840 × 2160 (4K UHD); 24p			
1920 × 1080; 120p <sup>3</sup>			
1920 × 1080; 100p <sup>3</sup>			
1920 × 1080; 60p	56	28	
1920 × 1080; 50p			
1920 × 1080; 30p	28	14	
1920 × 1080; 25p			
1920 × 1080; 24p			
1920 × 1080; 30p ×4 (slow-motion) <sup>3</sup>	36	— <sup>2</sup>	3 min.
1920 × 1080; 25p ×4 (slow-motion) <sup>3</sup>			
1920 × 1080; 24p ×5 (slow-motion) <sup>3</sup>			

1 Actual frame rates for values listed as 120p, 60p, 30p, and 24p are respectively 119.88 fps, 59.94 fps, 29.97 fps, and 23.976 fps.

2 **Movie quality** fixed at **High quality**.

3 The following cannot be used:

- Face detection (auto-area AF selected for AF-area mode)
- Flicker reduction
- Electronic VR

4 Each movie may be recorded across up to 8 files of up to 4 GB each. The number of files and the length of each file vary with the options selected for **Frame size/frame rate** and **Movie quality**. Movies recorded to memory cards formatted in the camera will however be recorded as a single file regardless of size if the card has a capacity over 32 GB.

The option currently selected is shown by an icon in the display.

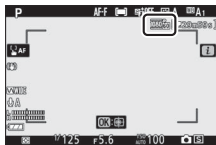

## ■ Slow-Motion Movies

To record silent slow-motion movies, select a “slow-motion” option for **Frame size/frame rate**. Slow-motion movies are recorded at 4 or 5 times the rated speed and play back at the rated speed. Movies shot at **1920 × 1080; 30p ×4 (slow-motion)**, for example, are recorded at a frame rate of roughly 120 fps and play back at around 30 fps, meaning that 10 seconds recording produces about 40 seconds of footage.

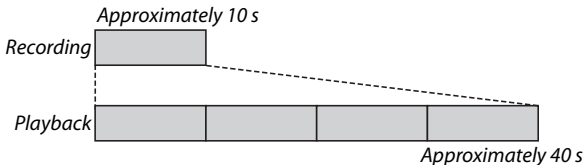

Recording and playback speeds are shown below.

	Frame size/frame rate	Recording speed	Normal
	1920 × 1080; 30p ×4 (slow-motion)	120p (119.88 fps)	30p (29.97 fps)
	1920 × 1080; 25p ×4 (slow-motion)	100p (100 fps)	25p (25 fps)
	1920 × 1080; 24p ×5 (slow-motion)	120p (119.88 fps)	24p (23.976 fps)

## Microphone Sensitivity

Turn the built-in or external microphones on or off or adjust microphone sensitivity. Choose **Auto** to adjust sensitivity automatically or **Microphone off** to turn sound recording off or adjust microphone sensitivity manually by choosing a value between **1** and **20** (the higher the value, the higher the sensitivity).

At settings other than **Auto**, the option currently selected is shown by an icon in the display.

If the sound level is displayed in red, the volume is too high. Reduce microphone sensitivity.

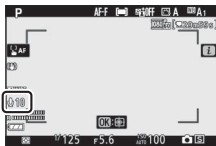

### **The Icon**

Movies recorded with **Microphone off** selected for **Microphone sensitivity** are indicated by a  icon.



## Wind Noise Reduction

Choose whether to enable wind-noise reduction during movie recording.

Option	Description
<b>On</b>	Enable the built-in microphone's low-cut filter, reducing noise produced by wind blowing over the microphone. Note that other sounds may also be affected.
<b>Off</b>	Disable wind noise reduction.

An icon appears in the shooting display when **On** is selected for wind-noise reduction.



Selecting **On** for **Wind noise reduction** has no effect on optional stereo microphones. Wind-noise reduction for units that support this feature can be enabled or disabled using microphone controls.

## Metering

Choose how the camera sets exposure in movie mode. For more information, see “Metering” (📖 131), but note that spot metering is not available.

## Wi-Fi Connection

Enable or disable Wi-Fi. For more information, see “Wi-Fi Connection” (📖 132).

## Active D-Lighting

Choose an Active D-Lighting option for movie mode. For more information, see “Active D-Lighting” (📖 133). Note that if **Same as photo settings** is selected for **Active D-Lighting** in the movie shooting menu and **Auto** is selected in the photo shooting menu, movies will be shot at a setting equivalent to **Normal**.

## Electronic VR

Select **On** to enable electronic vibration reduction in movie mode. Electronic vibration reduction is not available in **EFCT** mode or at frame sizes of **1920 × 1080; 120p**, **1920 × 1080; 100p**, or 1920 × 1080 (slow-motion). Note that when electronic vibration reduction is on, the angle of view will be reduced, slightly increasing the apparent focal length.

An icon appears in the display while **On** is selected.

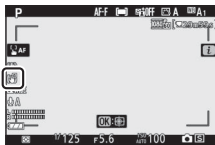





## **Optical VR**

Choose an optical vibration reduction option for movie mode. For more information, see “Optical VR” (📖 139).

## **AF-Area Mode**

Choose how the camera selects the focus point when autofocus is enabled in movie mode. For more information, see “AF-Area Mode” (📖 54).

Option	Option
 <b>Single-point AF</b>	 <b>Wide-area AF (L)</b>
 <b>Wide-area AF (S)</b>	 <b>Auto-area AF</b>

## **Focus Mode**

Choose how the camera focuses in movie mode. For more information, see “Choosing a Focus Mode” (📖 51).

Option	Option
<b>AF-S</b> Single AF	<b>AF-F</b> Full-time AF
<b>AF-C</b> Continuous AF	<b>MF</b> Manual focus

# More About Playback

Learn more about viewing pictures and image information, the playback **i** menu, playback zoom, and deleting pictures.

## Viewing Pictures

Use the **Q** and **Q/??/?** buttons to cycle between full-frame and thumbnail playback.

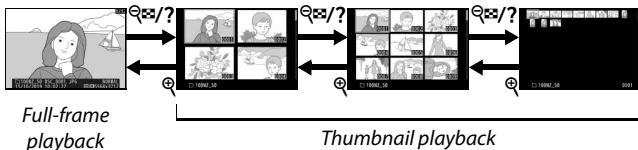

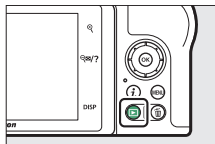

## Full-Frame Playback

Press the **▶** button to view the most recent picture full frame in the display. Additional pictures can be displayed by pressing **◀** or **▶**; to view additional information on the current photograph, press **⊙** or **⊙** or tap the **DISP** button (📖 151).



## Thumbnail Playback

To view multiple images, tap the  button when a picture is displayed full frame. The number of images displayed increases from 4 to 9 to 72 each time you tap the  button and decreases each time you tap the  button. Use the multi selector to highlight images.

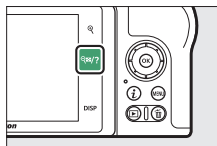

### ✔ Touch Controls

Touch controls can be used when pictures are displayed in the monitor ( 14).

### ✔ Rotate Tall

To display “tall” (portrait-orientation) photographs in tall orientation, select **On** for **Rotate tall** in the playback menu.





### ✔ Image Review

When **On** is selected for **Image review** in the playback menu, photographs are automatically displayed after shooting (because the camera is already in the correct orientation, images are not rotated automatically during image review). If **On (monitor only)** is selected, photos will not be displayed in the viewfinder. In continuous release modes, display begins when shooting ends, with the first photograph in the current series displayed.



# Photo Information

Photo information is superimposed on images displayed in full-frame playback. Press  or  or tap the **DISP** button to cycle through photo information as shown below.

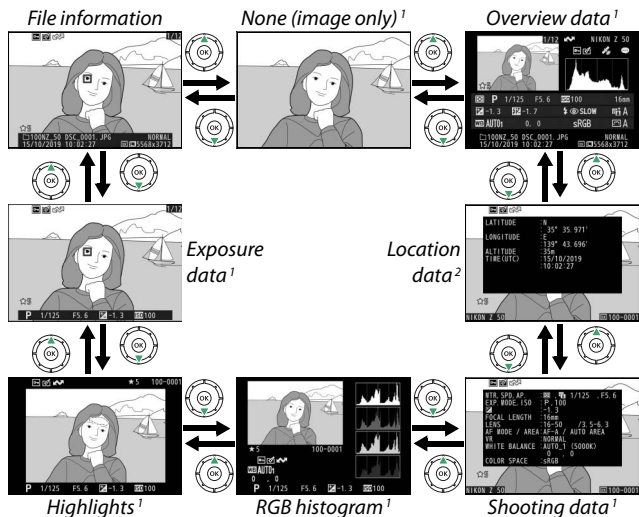

- 1 Displayed only if the corresponding option is selected for **Playback display options** in the playback menu.
- 2 Displayed only if embedded in the picture ( 317).

## File Information

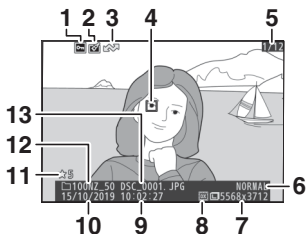

1	Protect status .....	74
2	Retouch indicator .....	327
3	Upload marking .....	161
4	Focus point* .....	54
5	Frame number/ total number of frames	
6	Image quality .....	126
7	Image size .....	128
8	Image area .....	193
9	Time of recording .....	307
10	Date of recording .....	307
11	Rating .....	73
12	Folder name .....	183
13	File name .....	193, 258

\* Displayed only if **Focus point** is selected for **Playback display options**.

## Exposure Data

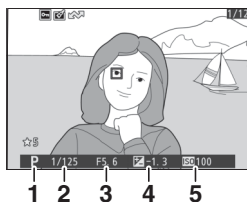

1	Shooting mode .....	75
2	Shutter speed .....	76, 78
3	Aperture .....	77
4	Exposure compensation .....	102
5	ISO sensitivity* .....	100

\* Displayed in red if photo was taken in mode **P**, **S**, **A**, or **M** with auto ISO sensitivity control on.

## Highlights

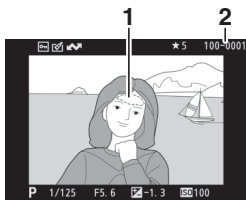

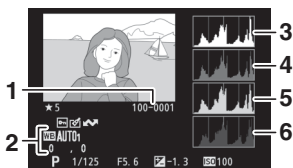

- 1 Highlights (areas that may be overexposed)
- 2 Folder number-frame number ..... 189

## RGB Histogram



- 1 Folder number-frame number ..... 189
- 2 White balance..... 67, 120
  - Color temperature ..... 122
  - Preset manual ..... 123
  - White balance fine-tuning ..... 121
- 3 Histogram (RGB channel) ..... 154
- 4 Histogram (red channel)..... 154
- 5 Histogram (green channel) ..... 154
- 6 Histogram (blue channel)..... 154

## ✔ Playback Zoom

To zoom in on the photograph when the histogram is displayed, tap . Use the  and  buttons to zoom in and out and scroll the image with the multi selector. The histogram will be updated to show only the data for the portion of the image visible in the display.



## ✔ Histograms

Histograms show tone distribution, with pixel brightness (tone) plotted on the horizontal axis and the number of pixels on the vertical axis. Camera histograms are intended as a guide only and may differ from those displayed in imaging applications. Some sample histograms are shown below:

If the image contains objects with a wide range of brightnesses, the distribution of tones will be relatively even.



If the image is dark, tone distribution will be shifted to the left.



If the image is bright, tone distribution will be shifted to the right.



Increasing exposure compensation shifts the distribution of tones to the right, while decreasing exposure compensation shifts the distribution to the left. Histograms can provide a rough idea of overall exposure when bright ambient lighting makes it difficult to see pictures in the display.

## Shooting Data

Depending on settings at the time the picture was taken, there may be up to five pages of shooting data: general, flash info, Picture Control, advanced, and copyright information.

### ■ Shooting Data, Page 1 (General)

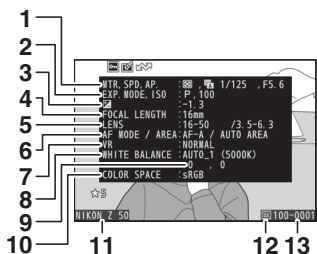

1	Metering .....	131
2	Shutter type .....	279
3	Shutter speed .....	76, 78
	Aperture.....	77
2	Shooting mode .....	75
	ISO sensitivity <sup>1</sup> .....	100
3	Exposure compensation .....	102
	Optimal exposure tuning <sup>2</sup> .....	275
4	Focal length	
5	Lens data	
6	Focus mode.....	51
	AF-area mode.....	54
7	Optical VR.....	139
8	White balance <sup>3</sup> .....	67, 120
9	White balance fine-tuning .....	121
10	Color space.....	209
11	Camera name	
12	Image area .....	193
13	Folder number-frame number .....	189

- 1 Displayed in red if photo was taken in mode **P**, **S**, **A**, or **M** with auto ISO sensitivity control on.
- 2 Displayed if Custom Setting b4 (**Fine-tune optimal exposure**) has been set to a value other than zero for any metering method.
- 3 Also includes color temperature of photos taken using auto white balance.

## ■ Shooting Data, Page 2 (Flash Info)

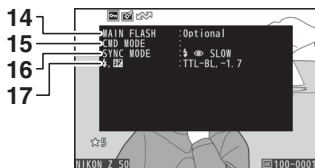

14	Flash type	
15	Remote flash control .....	405
16	Flash mode .....	108
17	Flash control mode .....	213
	Flash compensation .....	216

## ■ Shooting Data, Page 3 (Picture Control)

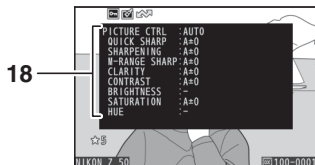

18	Picture Control <sup>4</sup> .....	116, 204
----	------------------------------------	----------

4 The items displayed vary with the Picture Control selected when the picture was taken.

## ■ Shooting Data, Page 4 (Advanced)

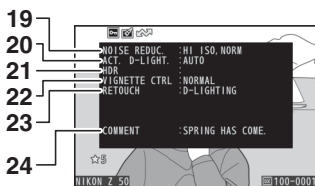

19	High ISO noise reduction .....	210
	Long exposure noise reduction .....	210
20	Active D-Lighting .....	133
21	HDR exposure differential .....	234
	HDR smoothing .....	234
22	Vignette control .....	211
23	Retouch history .....	327
24	Image comment .....	314

## ■■ Shooting Data, Page 5 (Copyright Information)<sup>5</sup>

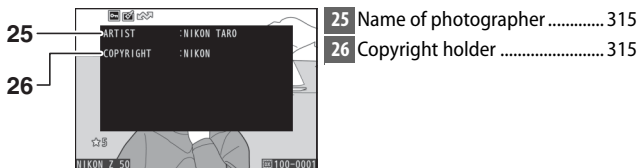

- 5 Copyright information is only displayed if recorded with the photograph using the **Copyright information** option in the setup menu.

## Location Data

The latitude, longitude, and other location data are supplied by and vary with the smart device (📖 317). In the case of movies, the data give the location at the start of recording.

## Overview Data

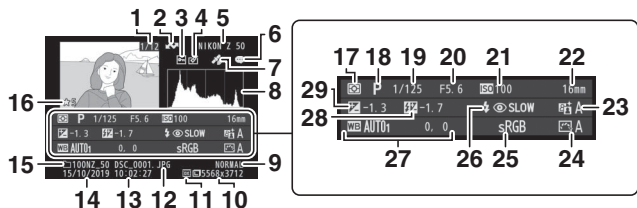

<b>1</b> Frame number/ total number of frames	<b>17</b> Metering.....	131
<b>2</b> Upload marking.....	<b>18</b> Shooting mode.....	75
<b>3</b> Protect status.....	<b>19</b> Shutter speed.....	76, 78
<b>4</b> Retouch indicator.....	<b>20</b> Aperture.....	77
<b>5</b> Camera name	<b>21</b> ISO sensitivity <sup>1</sup> .....	100
<b>6</b> Image comment indicator.....	<b>22</b> Focal length	
<b>7</b> Location data indicator.....	<b>23</b> Active D-Lighting.....	133
<b>8</b> Histogram.....	<b>24</b> Picture Control.....	116, 204
<b>9</b> Image quality.....	<b>25</b> Color space.....	209
<b>10</b> Image size.....	<b>26</b> Flash mode.....	108
<b>11</b> Image area.....	<b>27</b> White balance.....	67, 120
<b>12</b> File name.....	Color temperature.....	122
<b>13</b> Time of recording.....	Preset manual.....	123
<b>14</b> Date of recording.....	White balance fine-tuning	
<b>15</b> Folder name.....	.....	121
<b>16</b> Rating.....	<b>28</b> Flash compensation.....	216
	Commander mode <sup>2</sup>	
	<b>29</b> Exposure compensation.....	102

1 Displayed in red if photo was taken in mode **P**, **S**, **A**, or **M** with auto ISO sensitivity control on.

2 Displayed only if photo was taken with optional flash unit (☐ 432).



## The **i** Button: Playback

Pressing the **i** button during playback zoom or full-frame or thumbnail playback displays the **i** menu for playback mode. Select options using the multi selector and **OK** button and press the **i** button to exit the menu and return to playback.

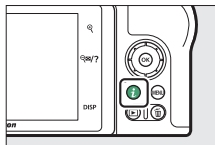

The options available in the playback **i** menu vary with the type of picture.

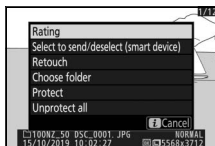

**Photos:** Pressing the **i** button when a photo is selected displays the options listed below.

- **Quick crop** (displayed only during playback zoom): Save a copy of the current image cropped to the area visible in the display. This option is not available when histograms are displayed.
- **Rating:** Rate the current picture (📖 73).
- **Select to send/deselect (smart device/PC):** Select the current picture for upload. The option displayed varies with the type of device connected (📖 161).
- **Retouch:** Use the options in the retouch menu (📖 327) to create a retouched copy of the current photograph.
- **Choose folder:** Choose a folder for playback. Highlight a folder and press **OK** to view the pictures in the highlighted folder.
- **Protect:** Add protection to or remove protection from the current picture (📖 74).
- **Unprotect all** (not available during playback zoom): Remove protection from all pictures in the folder currently selected for **Playback folder** in the playback menu.

**Movies:** The options below are available when a movie is selected.

- **Rating:** Rate the current picture (📖 73).
- **Select to send/deselect (PC):** Select the current picture for upload. The option displayed varies with the type of device connected (📖 161).
- **Volume control:** Adjust playback volume.
- **Trim movie:** Trim footage from the current movie and save the edited copy in a new file (📖 162).
- **Choose folder:** Choose a folder for playback. Highlight a folder and press Ⓞ to view the pictures in the highlighted folder.
- **Protect:** Add protection to or remove protection from the current picture (📖 74).
- **Unprotect all:** Remove protection from all pictures in the folder currently selected for **Playback folder** in the playback menu.

**Movies (playback paused):** The options below are available when movie playback is paused.

- **Choose start/end point:** Trim footage from the current movie and save the edited copy in a new file (📖 162).
- **Save current frame:** Save a selected frame as a JPEG still (📖 165).

## Select to Send/Deselect

Follow the steps below to select the current picture for upload to a smart device or computer. The **i** menu options used to select pictures for upload vary with the type of device connected:

- **Select to send/deselect (smart device)**: Displayed when the camera is connected to a smart device via built-in Bluetooth using the **Connect to smart device** item in the setup menu (📖 318).
- **Select to send/deselect (PC)**: Displayed when the camera is connected to a computer via built-in Wi-Fi using the **Connect to PC** item in the setup menu (📖 320).

### 1 Select a picture.

Display a picture in full-frame playback or playback zoom or select it in the thumbnail list.

### 2 Choose **Select to send/deselect**.

Press the **i** button to display the **i** menu, then highlight **Select to send/deselect** and press **OK**. Pictures selected for upload are indicated by a  icon; to deselect, repeat Steps 1 and 2.

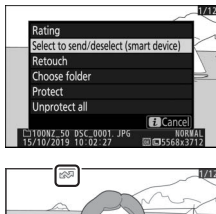

#### Movies

Movies cannot be selected for upload when the camera is connected to a smart device via the SnapBridge app. The maximum file size for movies uploaded by other means is 4 GB.

## Choose Start/End Point

Follow the steps below to create trimmed copies of movies.



**1** Display a movie full frame.

**2** Pause the movie on the new opening frame.

Play the movie back as described in “Viewing Movies” (48), pressing **OK** to start and resume playback and **⏸** to pause, and pressing **⏪** or **⏩** or rotating the main command dial to locate the desired frame. Your approximate position in the movie can be ascertained from the movie progress bar. Pause playback when you reach the new opening frame.



*Movie progress bar*

**3** Select **Choose start/end point**. Press the **i** button to display the **i** menu, then highlight **Choose start/end point** and press **OK**.



## 4 Select Start point.

To create a copy that begins from the current frame, highlight **Start point** and press **OK**. The frames before the current frame will be removed when you save the copy in Step 9.

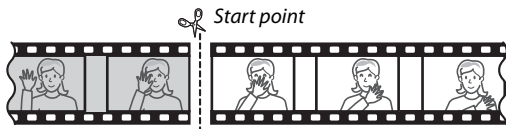
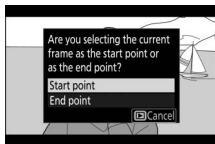

## 5 Confirm the new start point.

If the desired frame is not currently displayed, press **Left Arrow** or **Right Arrow** to advance or rewind (to skip to 10 s ahead or back, rotate the main command dial; to skip to the first or last frame, rotate the sub-command dial).



## 6 Choose the end point.

Press the **AE-L/AF-L** (**OK**) button to switch from the start point (**Start point**) to the end point (**End point**) selection tool and then select the closing frame as described in Step 5. The frames after the selected frame will be removed when you save the copy in Step 9.

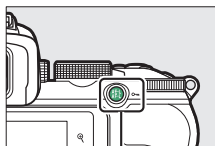

**AE-L/AF-L** (**OK**) button

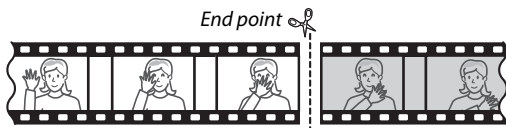



---

## 7 Create the copy.

Once the desired frame is displayed, press .

---



## 8 Preview the movie.

To preview the copy, highlight **Preview** and press  (to interrupt the preview and return to the save options menu, press ). To abandon the current copy and select a new start point or end point as described above, highlight **Cancel** and press ; to save the copy, proceed to Step 9.



---

## 9 Save the copy.

Highlight **Save as new file** and press  to save the copy to a new file. To replace the original movie file with the edited copy, highlight **Overwrite existing file** and press .







### Trimming Movies

Movies must be at least two seconds long. The copy will not be saved if there is insufficient space available on the memory card.

Copies have the same time and date of creation as the original.

### Removing Opening or Closing Footage

To remove only the opening footage from the movie, proceed to Step 7 without pressing the  () button in Step 6. To remove only the closing footage, select **End point** in Step 4, select the closing frame, and proceed to Step 7 without pressing the  () button in Step 6.

### "Trim Movie"

Movies can also be edited using the **Trim movie** option in the retouch menu.

## Save Current Frame

To save a copy of a selected frame as a JPEG still:

### 1 Pause the movie on the desired frame.

Play the movie back as described in “Viewing Movies” (📖 48), pressing **OK** to start and resume playback and **⏸** to pause. Pause the movie at the frame you intend to copy.



### 2 Choose **Save current frame**.



Press the **i** button to display the **i** menu, then highlight **Save current frame** and press **OK** to create a JPEG copy of the current frame. The image will be recorded at the dimensions selected for **Frame size/frame rate** in the movie shooting menu.



#### ✔ Save Current Frame



JPEG movie stills created with the **Save current frame** option cannot be retouched. JPEG movie stills lack some categories of photo information.

## Taking a Closer Look: Playback Zoom

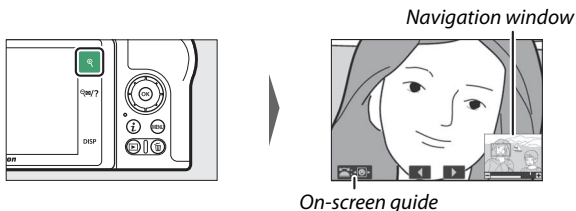
To zoom in during full-frame playback, tap  or press .



While zoom is in effect, you can:

- **Zoom in or out/view other areas of the image:** Tap  or use stretch gestures to zoom in to a maximum of approximately 21× for large images, 16× for medium images, and 10× for small images created with **DX (24×16)** selected for image area. Tap  or use pinch gestures to zoom out. While the photo is zoomed in, use the multi selector or slide a finger over the screen to view areas not currently visible in the display. Keep the multi selector pressed to scroll rapidly to other areas of the frame. A navigation window is displayed for a few seconds after the zoom ratio is altered; the area currently visible in the display is indicated by a yellow border. The bar under the navigation window shows the zoom ratio, turning green at 1 : 1.
- **Select faces:** Faces detected during zoom are indicated by white borders in the navigation window. Rotate the sub-command dial or tap the on-screen guide to view other faces.



- **View other images:** Rotate the main command dial or tap the ◀ or ▶ icons at the bottom of the display to view the same location in other photos at the current zoom ratio. Playback zoom is cancelled when a movie is displayed.
- **Return to shooting mode:** Press the shutter-release button halfway or press the  button to exit to shooting mode.
- **Display the menus:** Press MENU to view the menus.

## Deleting Pictures



Press the  button to delete the current picture or use the **Delete** option in the playback menu to delete multiple selected pictures, all pictures taken on a selected date, or all pictures in the current playback folder (protected pictures cannot be deleted). Exercise caution when deleting pictures, as pictures cannot be recovered once deleted.

### During Playback

Press the  button to delete the current photograph.

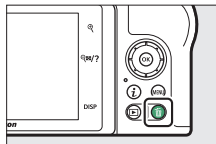

- 1 Press the  button.**  
A confirmation dialog will be displayed.



- 2 Press the  button again.**  
To delete the picture, press the  button again. To exit without deleting the picture, press .

## The Playback Menu



The **Delete** item in the playback menu contains the following options. Note that depending on the number of images, some time may be required for deletion.

Option	Description
 <b>Selected</b>	Delete selected pictures.
 <b>Select date</b>	Delete all pictures taken on selected dates (📅 170).
<b>ALL All</b>	Delete all pictures in the folder currently selected for playback (📅 183).

### ■ ■ Selected: Deleting Selected Pictures



To delete multiple selected pictures, choose **Selected** and follow the steps below.

#### 1 Select pictures.

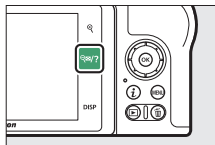
Use the multi selector to highlight a picture and tap the  button to select or deselect. Selected pictures are marked by a  icon (to view the highlighted picture full screen, touch and hold the  button). Repeat as desired to select additional pictures.



#### 2 Delete the selected pictures.



Press . A confirmation dialog will be displayed; highlight **Yes** and press .



## ■ Select Date: Deleting Pictures Taken on Selected Dates



To delete all unprotected pictures taken on selected dates, choose **Delete** > **Select date** in the playback menu and follow the steps below.

### 1 Select dates.

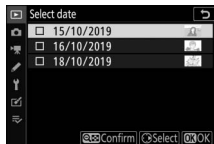
Highlight a date and press  to select all pictures taken on the highlighted date. Selected dates are marked with a  icon. Repeat as desired to select additional dates; to deselect a date, highlight it and press .



### 2 Delete the pictures taken on the selected dates.

Press . A confirmation dialog will be displayed; highlight **Yes** and press .

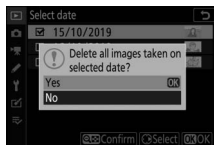

# Menu Guide

Learn more about camera menus.

## Defaults











The default settings for the options in the camera menus are listed below.

### Playback Menu Defaults

Option	Default
Delete	—
Playback folder	All
<b>Playback display options</b>	
Focus point	<input type="checkbox"/>
Exposure info	<input type="checkbox"/>
Highlights	<input type="checkbox"/>
RGB histogram	<input type="checkbox"/>
Shooting data	<input type="checkbox"/>
Overview	<input type="checkbox"/>
None (image only)	<input type="checkbox"/>
Image review	On
After delete	Show next
Rotate tall	On
<b>Slide show</b>	
Image type	Still images and movies
Frame interval	2 s
Rating	—

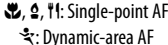
## Photo Shooting Menu Defaults

Option	Default	
Reset photo shooting menu	—	
<b>Storage folder</b>		
Rename	NZ_50	
Select folder by number	100	
<b>File naming</b>	DSC	
Choose image area	DX (24×16)	
Image quality	JPEG normal	
Image size	Large	
NEF (RAW) recording	14-bit	
<b>ISO sensitivity settings</b>		
ISO sensitivity	SCN, EFCT (excluding 	Same as without flash
Minimum shutter speed	Auto	
<b>White balance</b>	Auto > Keep overall atmosphere	
Fine-tuning	A-B: 0, G-M: 0	
Choose color temperature	5000 K	
Preset manual	d-1	
Set Picture Control	Auto	
Manage Picture Control	—	
Color space	sRGB	
Active D-Lighting	Auto	
Long exposure NR	Off	
High ISO NR	Normal	
Vignette control	Normal	
Diffraction compensation	On	
Auto distortion control	On	
Flicker reduction shooting	Off	
Metering	Matrix metering	



Option	Default
<b>Flash control</b>	
Flash control mode (built-in)/Flash control mode (external)	TTL
Wireless flash options	Off
<b>Flash mode</b>	 : Auto  : Auto slow sync  : Auto + red-eye reduction  : Flash off <b>P, S, A, M</b> : Fill flash
<b>Flash compensation</b>	0.0
<b>Release mode</b>	 : Continuous H Other modes: Single frame
<b>Focus mode</b>	 : Single AF Other modes: AF mode auto-switch
<b>AF-area mode</b>	 : Single-point AF  : Dynamic-area AF <b>P, S, A, M</b> ,  : Auto-area AF  : Auto-area AF
<b>Optical VR</b>	(Varies with lens)
<b>Auto bracketing</b>	
Auto bracketing set	AE bracketing
Number of shots	0F
Increment	1.0
<b>Multiple exposure*</b>	
Multiple exposure mode	Off
Number of shots	2
Overlay mode	Average
Keep all exposures	On
Overlay shooting	On
Select first exposure (NEF)	—











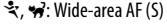



Option	Default
<b>HDR (high dynamic range)</b>	
HDR mode	Off
Exposure differential	Auto
Smoothing	Normal
Save individual images (NEF)	Off
<b>Interval timer shooting</b>	
Choose start day/time	Now
Interval	1 minute
Intervals×shots/interval	0001×1
Exposure smoothing	Off
Silent photography	Off
Interval priority	Off
<b>Starting storage folder</b>	
New folder	<input type="checkbox"/>
Reset file numbering	<input type="checkbox"/>
<b>Time-lapse movie</b>	
Interval	5 s
Shooting time	25 minutes
Exposure smoothing	On
Silent photography	Off
Frame size/frame rate	1920×1080; 60p
Interval priority	Off
<b>Silent photography</b>	Off

\* Photo shooting menu reset is not available while shooting is in progress.



## Movie Shooting Menu Defaults



Option	Default
Reset movie shooting menu	—
File naming	DSC
Frame size/frame rate	1920×1080; 60p
Movie quality	Normal
Movie file type	MOV
<b>ISO sensitivity settings</b>	
Maximum sensitivity	25600
Auto ISO control (mode M)	On
ISO sensitivity (mode M)	100
<b>White balance</b>	
	Same as photo settings
Fine-tuning	A-B: 0, G-M: 0
Choose color temperature	5000 K
Preset manual	d-1
Set Picture Control	Same as photo settings
Manage Picture Control	—
Active D-Lighting	Off
High ISO NR	Normal
Vignette control	Normal
Diffraction compensation	On
Auto distortion control	On
Flicker reduction	Auto
Metering	Matrix metering
Release mode (save frame)	  : Continuous Other modes: Single frame
Focus mode	 <b>P, S, A, M, SCN</b> : Full-time AF <b>EFCT</b> : Single AF

Option	Default
AF-area mode	 : Single-point AF  : Wide-area AF (S) P, S, A, M,  ,  ,  ,  ,  ,  ,  ,  ,  ,  , VI, POP,  ,  ,  : Auto-area AF
Optical VR	Same as photo settings
Electronic VR	Off
Microphone sensitivity	Auto
Attenuator	Disable
Frequency response	Wide range
Wind noise reduction	Off

## Custom Settings Menu Defaults

Option	Default
Reset custom settings	—
a1 AF-C priority selection	Focus
a2 Auto-area AF face/eye detection	Face and eye detection on
a3 Focus points used	All points
a4 AF activation	Shutter/AF-ON
a5 Focus point wrap-around	No wrap
a6 Focus point options	
Manual focus mode	On
Dynamic-area AF assist	On
a7 Low-light AF	On
a8 Built-in AF-assist illuminator	On
a9 Manual focus ring in AF mode	Enable
b1 EV steps for exposure cntrl	1/3 step
b2 Easy exposure compensation	Off
b3 Center-weighted area	Ø 8 mm

	Option	Default	
b4	<b>Fine-tune optimal exposure</b>		
	Matrix metering	0	
	Center-weighted metering	0	
	Spot metering	0	
c1	<b>Highlight-weighted metering</b>	0	
	<b>Shutter-release button AE-L</b>	Off	
	c2	<b>Self-timer</b>	
		Self-timer delay	10 s
Number of shots		1	
c3	Interval between shots	0.5 s	
	<b>Power off delay</b>		
	Playback	10 s	
	Menus	1 min	
d1	Image review	4 s	
	Standby timer	30 s	
	<b>CL mode shooting speed</b>	3 fps	
	d2	<b>Max. continuous release</b>	100
d3	<b>Exposure delay mode</b>	Off	
d4	<b>Shutter type</b>	Auto	
d5	<b>Limit selectable image area</b>		
	DX (24×16)	<input checked="" type="checkbox"/> (cannot be deselected)	
	1:1 (16×16)	<input checked="" type="checkbox"/>	
	16:9 (24×14)	<input checked="" type="checkbox"/>	
d6	<b>File number sequence</b>	On	
d7	<b>Apply settings to live view</b>	On	
d8	<b>Framing grid display</b>	Off	
d9	<b>Peaking highlights</b>		
	Peaking level	Off	
	Peaking highlight color	Red	
d10	<b>View all in continuous mode</b>	On	

	Option	Default
e1	Flash sync speed	1/200 s
e2	Flash shutter speed	1/60 s
e3	Exposure comp. for flash	Entire frame
e4	Auto  ISO sensitivity control	Subject and background
e5	Bracketing order	MTR > under > over
f1	Customize  menu	Set Picture Control; White balance; Image quality; Image size; Flash mode; Metering; Wi-Fi connection; Active D-Lighting; Release mode; Optical VR; AF-area mode; Focus mode
f2	<b>Custom controls (shooting)</b>	
	<b>Fn1 button</b>	White balance
	<b>Fn2 button</b>	Focus mode/AF-area mode
	<b>AE-L/AF-L button</b>	AE/AF lock
	<b>OK button</b>	Select center focus point
	<b>Movie record button</b>	None
	<b>Lens Fn button</b>	AE/AF lock
	<b>Lens Fn2 button</b>	AF-ON
	<b>Lens control ring</b>	(Varies with lens)
f3	<b>Custom controls (playback)</b>	
	<b>AE-L/AF-L button</b>	Protect
	<b>OK button</b>	Zoom on/off
f4	<b>Customize command dials</b>	
	<b>Reverse rotation</b>	Exposure compensation: <input type="checkbox"/> Shutter speed/aperture: <input type="checkbox"/>
	<b>Change main/sub</b>	Exposure setting: Off Autofocus setting: Off
	<b>Menus and playback</b>	Off
	<b>Sub-dial frame advance</b>	10 frames
f5	Release button to use dial	No
f6	Reverse indicators	

	<b>Option</b>	<b>Default</b>
g1	<b>Customize  menu</b>	Set Picture Control; White balance; Frame size and rate/Image quality; Microphone sensitivity; Wind noise reduction; Metering; Wi-Fi connection; Active D-Lighting; Electronic VR; Optical VR; AF-area mode; Focus mode
g2	<b>Custom controls</b>	
	<b>Fn1 button</b>	White balance
	<b>Fn2 button</b>	Focus mode/AF-area mode
	<b>AE-L/AF-L button</b>	AE/AF lock
	<b>OK button</b>	Select center focus point
	<b>Lens control ring</b>	(Varies with lens)
g3	<b>AF speed</b>	0
	<b>When to apply</b>	Always
g4	<b>AF tracking sensitivity</b>	4
g5	<b>Highlight display</b>	
	<b>Display pattern</b>	Off
	<b>Highlight display threshold</b>	248

## Setup Menu Defaults

Option	Default
Format memory card	—
Save user settings	—
Reset user settings	—
Language	(Default varies with country of purchase)
<b>Time zone and date</b>	
Time zone	(Default varies with country of purchase)
Date and time	(Default varies with country of purchase)
Date format	(Default varies with country of purchase)
Daylight saving time	Off
Monitor brightness	0
Viewfinder brightness	Auto
Viewfinder color balance	A-B: 0, G-M: 0
Information display	Dark on light
<b>AF fine-tune</b>	
AF fine-tune (On/Off)	Off
Saved value	—
Default	0
List saved values	—
Image Dust Off ref photo	—
<b>Image comment</b>	
Attach comment	<input type="checkbox"/>
<b>Copyright information</b>	
Attach copyright information	<input type="checkbox"/>
<b>Beep options</b>	
Beep on/off	On
Volume	2
Pitch	Low

Option	Default
<b>Touch controls</b>	
Enable/disable touch controls	Enable
Full-frame playback flicks	Left → Right
Self-portrait mode	Enable
<b>HDMI</b>	
Output resolution	Auto
Output range	Auto
Location data display	—
Airplane mode	Disable
<b>Connect to smart device</b>	
Pairing (Bluetooth)	—
Select to send (Bluetooth)	—
Wi-Fi connection	—
Send while off	On
<b>Connect to PC</b>	
Wi-Fi connection	Disable
Network settings	—
Options	—
MAC address	—
<b>Wireless remote (ML-L7) options</b>	
Wireless remote connection	Disable
Save wireless remote controller	—
Delete wireless remote controller	—
Assign Fn1 button	Same as camera  button
Assign Fn2 button	Same as camera MENU button
Conformity marking	—
Energy saving	Enable
Slot empty release lock	Release locked
Reset all settings	—
Firmware version	—

## ▶ The Playback Menu: *Managing Images*

To view playback options, select the ▶ tab in the camera menus.

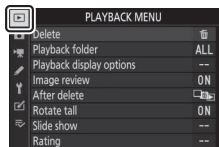

Option	📖
<b>Delete</b>	183
<b>Playback folder</b>	183
<b>Playback display options</b>	183
<b>Image review</b>	184

Option	📖
<b>After delete</b>	184
<b>Rotate tall</b>	185
<b>Slide show</b>	186
<b>Rating</b>	187

### ✔ See Also



For menu defaults, see "Playback Menu Defaults" (📖 171).



## Delete

MENU button →  (playback menu)

Delete multiple images.

Option	Description
 <b>Selected</b>	Delete selected pictures.
 <b>Select date</b>	Delete all pictures taken on selected dates.
<b>ALL All</b>	Delete all pictures in the folder currently selected for playback.

## Playback Folder



MENU button →  (playback menu)

Choose a folder for playback.

Option	Description
(Folder name)	Pictures in all folders with the selected name will be visible during playback. Folders can be renamed using the <b>Storage folder &gt; Rename</b> option in the photo shooting menu (  189).
<b>All</b>	Pictures in all folders will be visible during playback.
<b>Current</b>	Only pictures in the current folder will be visible during playback.

## Playback Display Options

MENU button →  (playback menu)

Choose the information available in the playback photo information display. Highlight options and press  to select or deselect; items selected for display during full-frame playback are indicated by  icons. To return to the playback menu, press .

## Image Review

MENU button →  (playback menu)



Choose whether pictures are displayed automatically immediately after shooting.

Option	Description
On	Pictures appear in the currently-selected display (monitor or viewfinder) as they are taken.
On (monitor only)	Pictures are displayed after shooting only when the monitor is used to frame shots. Pictures are not displayed in the viewfinder during shooting.
Off	Pictures can only be viewed by pressing the  button.

## After Delete

MENU button →  (playback menu)

Choose the picture displayed after an image is deleted.

Option	Description
 <b>Show next</b>	The following picture is displayed (if there is no following picture—i.e., if the deleted image was the last picture—the preceding picture will be displayed).
 <b>Show previous</b>	The preceding picture is displayed (if there is no preceding picture—i.e., if the deleted image was the first picture—the next picture will be displayed).
 <b>Continue as before</b>	If you were scrolling through pictures in the order recorded, the following picture will be displayed as described for <b>Show next</b> . If you were scrolling through pictures in reverse order, the preceding picture will be displayed as described for <b>Show previous</b> .

## Rotate Tall

MENU button →  (playback menu)

If **On** is selected, “tall” (portrait-orientation) pictures will be automatically rotated for display during playback. Note that because the camera itself is already in the appropriate orientation during shooting, images are not rotated automatically during image review.









## Slide Show

MENU button →  (playback menu)

View a slide show of the pictures in the current playback folder ( 183).

Option	Description
<b>Start</b>	Start slide show.
<b>Image type</b>	Choose the type of image displayed from <b>Still images and movies</b> , <b>Still images only</b> , and <b>Movies only</b> , or select <b>By rating</b> to view only pictures with selected ratings (highlight ratings and press  to select or deselect).
<b>Frame interval</b>	Choose how long each picture will be displayed.

To start the slide show, highlight **Start** and press . The following operations can be performed while the show is in progress:

- **Skip back/skip ahead:** Press  to return to the previous frame,  to skip to the next frame.
- **View additional photo info:** Press  or  to change or hide the photo info displayed (still images only).
- **Pause:** Press  to pause the slide show. To restart, highlight **Restart** and press .
- **Adjust volume:** Tap  during movie playback to increase the volume,  to decrease.
- **Exit to the playback menu:** Press MENU to end the slide show and return to the playback menu.
- **Exit to playback mode:** Press  to end the slide show and exit to playback mode.
- **Exit to shooting mode:** Press the shutter-release button halfway to return to shooting mode.

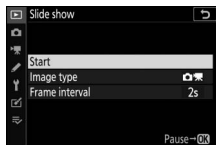



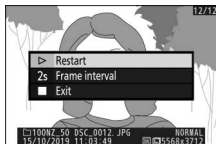



A dialog is displayed when the show ends. Select **Restart** to restart or **Exit** to return to the playback menu.



## Rating

MENU button →  (playback menu)

Rate pictures or mark them as candidates for later deletion. Press  or  to highlight pictures and press  or  to choose a rating of from zero to five stars, or select  to mark the picture as a candidate for later deletion (to view the highlighted picture full screen, touch and hold the  button). Press  to exit when the operation is complete.



## The Photo Shooting Menu: *Shooting Options*

To view the photo shooting menu, select the  tab in the camera menus.



Option	
Reset photo shooting menu	189
Storage folder	189
File naming	193
Choose image area	193
Image quality	194
Image size	194
NEF (RAW) recording	195
ISO sensitivity settings	196
White balance	198
Set Picture Control	204
Manage Picture Control	206
Color space	209
Active D-Lighting	209
Long exposure NR	210
High ISO NR	210
Vignette control	211
Diffraction compensation	211

Option	
Auto distortion control	211
Flicker reduction shooting	212
Metering	212
Flash control	213
Flash mode	215
Flash compensation	216
Release mode	216
Focus mode	216
AF-area mode	216
Optical VR	216
Auto bracketing	217
Multiple exposure	227
HDR (high dynamic range)	234
Interval timer shooting	239
Time-lapse movie	249
Silent photography	256

### See Also

For menu defaults, see “Photo Shooting Menu Defaults” ( 172).

## Reset Photo Shooting Menu

MENU button → 📷 (photo shooting menu)

Select **Yes** to restore photo shooting menu options to their default values (📖 172).

## Storage Folder

MENU button → 📷 (photo shooting menu)

Rename folders and select the folder in which subsequent pictures will be stored.

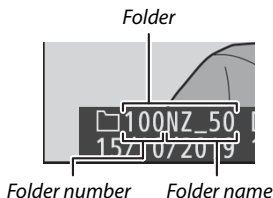

## Rename

Folders are identified by a 5-character folder name preceded by a 3-digit folder number assigned automatically by the camera. The default folder name is "NZ\_50"; to change the name assigned to new folders, select **Rename**. If desired, the default name can be restored by pressing and holding the 🗑️ button while the keyboard is displayed. Existing folders cannot be renamed.

## ✔ Text Entry

A keyboard is displayed when text entry is required. Tap letters on the screen or use the multi selector to highlight characters and press **OK** to insert them at the current cursor position (note that if a character is entered when the field is full, the last character in the field will be deleted). To delete the character under the cursor, press the **delete** button. To move the cursor to a new position, tap the display or rotate the main command dial. To complete entry and return to the previous menu, tap **OK**. To exit without completing text entry, press **MENU**.









## Select Folder by Number



To select folders by number or create a new folder with the current folder name and a new folder number:

### 1 Choose **Select folder by number**.

Highlight **Select folder by number** and press .

### 2 Choose a folder number.

Press  or  to highlight digits and press  or  to change. If a folder with the selected number already exists, one of the following icons will be displayed:

- : Folder is empty.
- : Folder is partially full.
- : Folder contains 5000 pictures or a picture numbered 9999. No further pictures can be stored in this folder.



### 3 Save changes and exit.

Press  to complete the operation and return to the main menu (to exit without changing the storage folder, press the **MENU** button). If a folder with the specified number does not already exist, a new folder will be created. Subsequent photographs will be stored in the selected folder unless it is already full.

## Select Folder from List

To choose from a list of existing folders:

### 1 Choose **Select folder from list**.

Highlight **Select folder from list** and press  $\odot$ .

### 2 Highlight a folder.

Press  $\odot$  or  $\odot$  to highlight a folder.

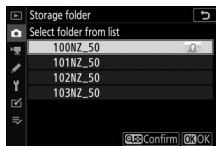

### 3 Select the highlighted folder.

Press  $\odot$  to select the highlighted folder and return to the main menu. Subsequent photographs will be stored in the selected folder.

#### ✔ Folder and File Numbers

Once the folder number has reached 999, no new folders will be created (and the shutter release will consequently be disabled) after the file number reaches 9999 or the number of files in the folder reaches 5000, or if you attempt to record a movie when the camera calculates that the number of files needed for a movie of maximum length would result in the creation of a file numbered higher than 9999 or the folder holding over 5000 files. To continue shooting, create a folder with a number less than 999 or try changing the options selected for **Frame size/frame rate** and **Movie quality**.

#### ✔ Startup Time

Additional time may be required for camera startup if the memory card contains a very large number of files or folders.

## File Naming

MENU button →  (photo shooting menu)

Photographs are saved using file names consisting of “DSC\_” or, in the case of images that use the Adobe RGB color space (📖 209), “\_DSC”, followed by a four-digit number and a three-letter extension (e.g., “DSC\_0001.JPG” or “\_DSC0002.JPG”). The **File naming** option is used to select three letters to replace the “DSC” portion of the file name as described in “Text Entry” (📖 190).



### ✓ Extensions

The following extensions are used: “.NEF” for NEF (RAW) images, “.JPG” for JPEG images, “.MOV” for MOV movies, “.MP4” for MP4 movies, and “.NDF” for dust off reference data. In each pair of photographs recorded at image-quality settings of NEF (RAW)+JPEG, the NEF and JPEG images have the same file names but different extensions.

## Choose Image Area

MENU button →  (photo shooting menu)

The camera offers a choice of the following image areas:

Option	Description
 <b>DX (24×16)</b>	Pictures are recorded using a 23.5 × 15.7 mm image area (DX format).
 <b>1 : 1 (16×16)</b>	Pictures are recorded with an aspect ratio of 1 : 1.
 <b>16 : 9 (24×14)</b>	Pictures are recorded with an aspect ratio of 16 : 9.

## Image Quality

MENU button →  (photo shooting menu)

Choose a file format for photographs. For more information, see “Image Quality” (📖 126).

## Image Size

MENU button →  (photo shooting menu)

Choose the size, in pixels, of photographs recorded with the camera. The dimensions vary with the option selected for image area.

Image area	Option	Size (pixels)	Print size (cm/in.)*
DX (24×16) DX format	Large	5568 × 3712	47.1 × 31.4/18.6 × 12.4
	Medium	4176 × 2784	35.4 × 23.6/13.9 × 9.3
	Small	2784 × 1856	23.6 × 15.7/9.3 × 6.2
1:1 (16×16)	Large	3712 × 3712	31.4 × 31.4/12.4 × 12.4
	Medium	2784 × 2784	23.6 × 23.6/9.3 × 9.3
	Small	1856 × 1856	15.7 × 15.7/6.2 × 6.2
16:9 (24×14)	Large	5568 × 3128	47.1 × 26.5/18.6 × 10.4
	Medium	4176 × 2344	35.4 × 19.8/13.9 × 7.8
	Small	2784 × 1560	23.6 × 13.2/9.3 × 5.2

\* Approximate size when printed at 300 dpi. Print size in inches equals image size in pixels divided by printer resolution in dots per inch (dpi; 1 inch = approximately 2.54 cm).

## NEF (RAW) Recording

MENU button →  (photo shooting menu)



Choose the bit depth at which NEF (RAW) photographs are recorded.

Option	Description
12-bit 12-bit	NEF (RAW) images are recorded at a bit depth of 12 bits.
14-bit 14-bit	NEF (RAW) images are recorded at a bit depth of 14 bits, producing files larger than those with a bit depth of 12 bits but increasing the color data recorded.

## ISO Sensitivity Settings

MENU button →  (photo shooting menu)

Adjust ISO sensitivity settings for photographs.

Option	Description
<b>ISO sensitivity</b>	Choose from settings of ISO 100 to 51200, Hi 1, and Hi 2. <b>SCN</b> and all <b>EFCT</b> modes except  also offer an <b>Auto</b> option.
<b>Auto ISO sensitivity control</b>	<p>If <b>On</b> is selected, the camera will automatically adjust ISO sensitivity when optimal exposure cannot be achieved at the value selected for <b>ISO sensitivity</b>. The options listed below are available for fine-tuning auto ISO sensitivity control.</p> <ul style="list-style-type: none"><li>• <b>Maximum sensitivity:</b> Choose an upper limit for ISO sensitivity to prevent it being raised too high.</li><li>• <b>Maximum sensitivity with </b>: Choose the upper ISO sensitivity limit for photos taken using an optional flash unit.</li><li>• <b>Minimum shutter speed:</b> Choose the shutter speed below which auto ISO sensitivity control will kick in to prevent underexposure in modes <b>P</b> and <b>A</b>. Options range from <math>\frac{1}{4000}</math> s to 30 s. An <b>Auto</b> option is also available ( 197).</li></ul>

 **“Minimum Shutter Speed” > “Auto”**

If **Auto** is selected for **Auto ISO sensitivity control > Minimum shutter speed**, the camera will choose the minimum shutter speed based on the focal length of the lens. For example, the camera will automatically select fast minimum shutter speeds to reduce the blur that commonly occurs with telephoto lenses.

Auto shutter-speed selection can be fine-tuned for faster or slower minimum values by highlighting **Auto** and pressing ; choosing fast minimum shutter speeds when photographing fast-moving objects reduces blur.

Shutter speeds may drop below the selected minimum if optimum exposure cannot be achieved at the ISO sensitivity chosen for **Maximum sensitivity**.

## White Balance

MENU button →  (photo shooting menu)

Adjust white balance. For more information, see the “White Balance” sections in “Basic Settings” (📖 67) and “The **i** Menu” (📖 120).

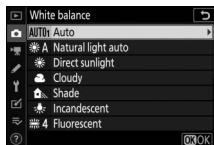

### The White Balance Menu: Fine-Tuning

Fine-tuning is available via the camera menus. For more information on fine-tuning, see “Fine-Tuning White Balance” (📖 121). For information on fine-tuning preset manual white balance, see “Fine-Tuning Preset White Balance” (📖 203).

- 1** Display fine-tuning options.  
Go to **White balance** in the photo shooting menu, highlight a white balance option, and press .

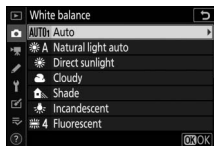



---

## 2 Fine-tune white balance.

Use the multi selector to fine-tune white balance. White balance can be fine-tuned on the **Amber–Blue** axis in steps of 0.5 and the **Green–Magenta** axis in steps of 0.25. The horizontal (**Amber–Blue**) axis corresponds to color temperature, while the vertical (**Green–Magenta**) axis has the similar effects to the corresponding color compensation (CC) filters. The horizontal axis is ruled in increments equivalent to about 5 mired, the vertical axis in increments of about 0.05 diffuse density units.

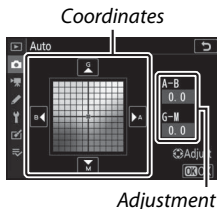

---

## 3 Save changes and exit.

Press **OK** to save settings and return to the photo shooting menu. If white balance has been fine-tuned, an asterisk ("**\***") will appear next to the white balance icon in the shooting display.

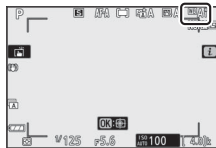

### ✔ **White Balance Fine-Tuning**

The colors on the fine-tuning axes are relative, not absolute. For example, moving the cursor to **B** (blue) when a “warm” setting such as  (**Incandescent**) is selected for white balance will make photographs slightly “colder” but will not actually make them blue.

### ✔ **“Mired”**

Any given change in color temperature produces a greater difference in color at low color temperatures than it would at higher color temperatures. For example, a change of 1000 K produces a much greater change in color at 3000 K than at 6000 K. Mired, calculated by multiplying the inverse of the color temperature by  $10^6$ , is a measure of color temperature that takes such variation into account, and as such is the unit used in color-temperature compensation filters. E.g.:

- 4000 K–3000 K (a difference of 1000 K)=83 mired
- 7000 K–6000 K (a difference of 1000 K)=24 mired

## The White Balance Menu: Choosing a Color Temperature

Color temperature can be selected using the **White balance > Choose color temperature** option in the photo shooting menu. Enter values for the amber–blue and green–magenta axes as described below.

---

### **1** Select **Choose color temperature**.

Go to **White balance** in the photo shooting menu, highlight **Choose color temperature** and press .

- 
- 2** Select values for amber–blue and green–magenta.  
Press  $\odot$  or  $\odot$  to highlight digits on the Amber–Blue or Green–Magenta axis and press  $\odot$  or  $\odot$  to change.

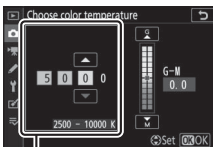

Value for  
Amber–Blue axis

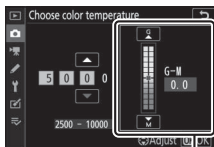

Value for  
Green–Magenta axis

- 
- 3** Save changes and exit.  
Press  $\odot$  to save settings and return to the photo shooting menu. If a value other than zero is selected for the Green–Magenta axis, an asterisk ("\*") will appear next to the white balance icon in the shooting display.

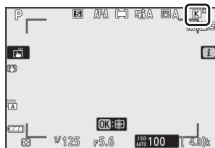

**✓ Choose Color Temperature**

Note that the desired results will not be obtained with fluorescent lighting. Choose  $\text{☀}$  (**Fluorescent**) for fluorescent light sources. With other light sources, take a test shot to determine if the selected value is appropriate.

## Preset Manual: Copying White Balance from a Photograph

The **Preset manual** option in the white balance menu can be used to copy a white balance value from an existing photograph. For more information on preset manual white balance, see “Preset Manual” (📖 123).

### 1 Select Preset manual.

Go to **White balance** in the photo shooting menu, highlight **Preset manual**, and press ⏏.

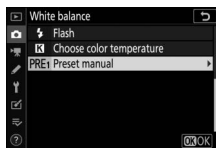

### 2 Select a destination.

Highlight the destination preset (d-1 to d-6) and tap Ⓜ.



### 3 Choose Select image.

The preset manual white balance menu will be displayed; highlight **Select image** and press ⏏.

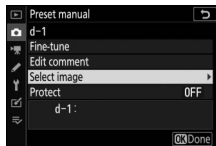

### 4 Highlight a source image.

Highlight the source image. To view the highlighted image full frame, touch and hold the Ⓜ button.



## 5 Copy white balance.

Press **OK** to copy the white balance value from the highlighted photograph to the selected preset. If the highlighted photograph has a comment, the comment will be copied to the comment for the selected preset.

### ✓ Fine-Tuning Preset White Balance

The current preset can be fine-tuned by selecting **Fine-tune** in the preset manual white balance menu and adjusting white balance as described in “The White Balance Menu: Fine-Tuning” (198).

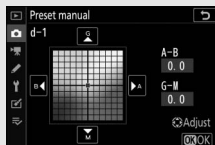

### ✓ Edit Comment

To enter a descriptive comment of up to 36 characters for the current white-balance preset, select **Edit comment** in the preset manual white balance menu.



### ✓ Protect

To protect the current white-balance preset, select **Protect** in the preset manual white balance menu, then highlight **On** and press **OK**. Protected presets cannot be modified and the **Fine-tune** and **Edit comment** options cannot be used.

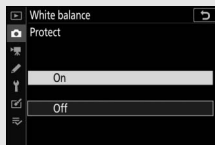

## Set Picture Control

MENU button → 📷 (photo shooting menu)

Choose how new photos will be processed. For more information, see “Set Picture Control” (📖 116).

### Set Picture Control: Modifying Picture Controls







Existing preset or custom Picture Controls can be modified to suit the scene or the user’s creative intent.

#### 1 Select a Picture Control.

Highlight the desired Picture Control in the Picture Control list and press .



#### 2 Adjust settings.

Press  or  to highlight the desired setting and press  or  to choose a value in increments of 1, or rotate the sub-command dial to choose a value in increments of 0.25 (the options available vary with the Picture Control selected). To quickly adjust levels for balanced **Sharpening**, **Mid-range sharpening**, and **Clarity**, highlight **Quick sharp** and press  or . Repeat this step until all settings have been adjusted. Default settings can be restored by pressing the  button.



#### 3 Save changes and exit.

Press  to save changes and return to the Picture Control list.

### ✔ Custom Picture Controls

Modifications to existing Picture Controls can be saved as custom Picture Controls using the **Manage Picture Control** option in the photo or movie shooting menu. Custom Picture Controls can be copied to a memory card and used in compatible software or shared among cameras of the same model.

### ✔ The *i* Menu

Modifying Picture Controls from the *i* menu allows the effect to be previewed in the display. Highlight **Set Picture Control** in the *i* menu and press  $\text{OK}$ , then press  $\leftarrow$  and  $\rightarrow$  to choose a Picture Control and press  $\downarrow$  to display Picture Control settings.

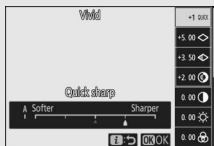

## Manage Picture Control

MENU button →  (photo shooting menu)

Save modified Picture Controls as custom Picture Controls.

Option	Description
<b>Save/edit</b>	Create a new custom Picture Control based on an existing preset or custom Picture Control, or edit existing custom Picture Controls.
<b>Rename</b>	Rename custom Picture Controls.
<b>Delete</b>	Delete custom Picture Controls.
<b>Load/save</b>	<p>Use the following options to copy custom Picture Controls to and from the memory card. Once copied to the memory card, Picture Controls can be used with other cameras or compatible software.</p> <ul style="list-style-type: none"><li>• <b>Copy to camera:</b> Copy custom Picture Controls from the memory card to custom Picture Controls C-1 through C-9 on the camera and name them as desired.</li><li>• <b>Delete from card:</b> Delete selected custom Picture Controls from the memory card.</li><li>• <b>Copy to card:</b> Copy a custom Picture Control (C-1 through C-9) from the camera to a selected destination (1 through 99) on the memory card.</li></ul>



## Creating Custom Picture Controls



The Picture Controls supplied with the camera can be modified and saved as custom Picture Controls.

### 1 Select **Save/edit**.

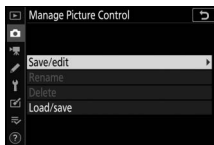
Highlight **Save/edit** and press .



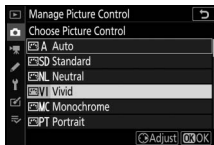

### 2 Select a Picture Control.

Highlight an existing Picture Control and press , or press  to proceed to Step 4 to save a copy of the highlighted Picture Control without further modification.



### 3 Edit the selected Picture Control.

To abandon any changes and start over from default settings, press the  button. Press  when settings are complete.



### 4 Select a destination.

Choose a destination for the custom Picture Control (C-1 through C-9) and press .



## 5 Name the Picture Control.

A text-entry dialog will be displayed. By default, new Picture Controls are named by adding a two-digit number (assigned automatically) to the name of the existing Picture Control; to choose a different name, rename the Picture Control as described in “Text Entry” (☞ 190). Tap the keyboard selection button to cycle through the upper-case, lower-case, and symbol keyboards. Custom Picture Control names can be up to nineteen characters long. Any characters after the nineteenth will be deleted. When entry is complete, tap  to add the new Picture Control to the Picture Control list.

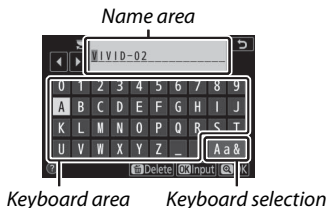

### Custom Picture Control Options

The options available with custom Picture Controls are the same as those on which the custom Picture Control was based.

### The Original Picture Control Icon

The original preset Picture Control on which the custom Picture Control is based is indicated by an icon in the top right corner of the edit display.

*Original  
Picture Control icon*



## Color Space

MENU button →  (photo shooting menu)

The color space determines the gamut of colors available for color reproduction. **sRGB** is recommended for general-purpose printing and display, **Adobe RGB**, with its broader gamut of colors, for professional publication and commercial printing.

### ✔ Adobe RGB

For accurate color reproduction, Adobe RGB images require applications, displays, and printers that support color management.

### ✔ Color Space

The selected color space may be overwritten when pictures are opened in third-party software. NX Studio can open pictures in the color space selected on the camera.

## Active D-Lighting

MENU button →  (photo shooting menu)

Preserve details in highlights and shadows, creating pictures with natural contrast. For more information, see “Active D-Lighting” (📖 133).

## Long Exposure NR

MENU button →  (photo shooting menu)

If **On** is selected, photographs taken at shutter speeds slower than 1 s will be processed to reduce noise (bright spots or fog). The time required for processing roughly doubles; during processing, the message “Performing noise reduction” will be displayed and pictures cannot be taken (if the camera is turned off before processing is complete, the picture will be saved but noise reduction will not be performed).

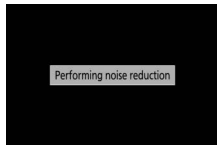

## High ISO NR

MENU button →  (photo shooting menu)

Photographs taken at high ISO sensitivities can be processed to reduce “noise”.

Option	Description
High/ Normal/ Low	Reduce noise (randomly-spaced bright pixels), particularly in pictures taken at high ISO sensitivities. Choose the amount of noise reduction performed from <b>High</b> , <b>Normal</b> , and <b>Low</b> .
Off	Noise reduction is performed only as required and never at an amount as high as when <b>Low</b> is selected.

## Vignette Control

MENU button →  (photo shooting menu)

Vignette control reduces the drop in brightness that occurs at the edges of the frame. Its effects vary from lens to lens and are most noticeable at maximum aperture. Choose from **High**, **Normal**, **Low**, and **Off**.

### Vignette Control

Depending on the scene, shooting conditions, and type of lens, JPEG images may exhibit noise (fog) or variations in peripheral brightness, while custom Picture Controls and preset Picture Controls that have been modified from default settings may not produce the desired effect. Take test shots and view the results in the display.

## Diffraction Compensation

MENU button →  (photo shooting menu)

Select **On** to reduce diffraction at small apertures (high f/-numbers).

## Auto Distortion Control

MENU button →  (photo shooting menu)

Select **On** as required to reduce barrel distortion when shooting with wide-angle lenses and to reduce pin-cushion distortion when shooting with long lenses (note that **On** may be selected automatically with some lenses, in which case the **Auto distortion control** option will be grayed out and unavailable).

## Flicker Reduction Shooting

MENU button →  (photo shooting menu)

When **On** is selected, the camera will time photographs to reduce banding, areas of under- or over-exposure, or (in photographs taken in continuous release modes) uneven coloration caused by the flicker of such light sources as fluorescent or mercury-vapor lamps (note that the frame rate may drop while flicker reduction is in effect, and that the frame rate may slow or become erratic during burst shooting).

### "Flicker Reduction Shooting" in the Photo Shooting Menu

Flicker reduction can detect flicker at 100 and 120 Hz (associated respectively with AC power supplies of 50 and 60 Hz). Flicker may not be detected or the desired results may not be achieved with dark backgrounds, bright light sources, or decorative lighting displays and other non-standard lighting. Depending on the light source, there may be a slight delay before the shutter is released. The desired results may not be achieved if the frequency of the power supply changes during shooting.

Flicker detection will not take effect when **Continuous H (extended)** is selected for release mode or silent photography, HDR, or exposure delay mode is enabled.

## Metering

MENU button →  (photo shooting menu)

Metering determines how the camera sets exposure. For more information, see "Metering" (📖 131).

## Flash Control

MENU button →  (photo shooting menu)

Adjust flash settings for the built-in flash, optional flash units, and wireless flash photography.

- For information on using optional flash units for on-camera flash photography, see “On-Camera Flash Photography” (📖 401).
- For information on using optional flash units for wireless flash photography, see “Remote Flash Photography” (📖 405).

### Flash Control Mode (Built-in)

Choose the flash control mode for the built-in flash.

- **TTL:** i-TTL mode. Flash level is adjusted automatically in response to shooting conditions.
- **Manual:** Choose the flash level (Manual output amount) manually.

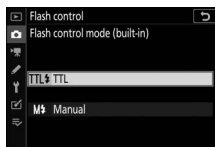

### **Flash Control Mode (External)**

When an optional flash is attached and turned on, the **Flash control mode (built-in)** option is replaced by **Flash control mode (external)**.

### **The Built-In Flash: Metering and Flash Control**

The camera uses i-TTL balanced fill-flash flash control with matrix, center-weighted, and highlight-weighted metering, standard i-TTL fill-flash flash control with spot metering. In i-TTL modes, flash output is adjusted based on monitor preflashes emitted by the built-in flash when the shutter-release button is pressed.

- **i-TTL balanced fill-flash:** The built-in flash emits a series of nearly invisible preflashes (monitor preflashes) immediately before the main flash. The camera analyzes preflashes reflected from objects in all areas of the frame and adjusts flash output for a natural balance between the main subject and ambient background lighting.
- **Standard i-TTL fill-flash:** Flash output is adjusted to bring lighting in the frame to standard level; the brightness of the background is not taken into account. Recommended for shots in which the main subject is emphasized at the expense of background details, or when exposure compensation is used.



## Wireless Flash Options

Adjust settings for simultaneous wireless control of multiple remote flash units. This option is available only when an SB-500 flash unit is mounted on the camera.

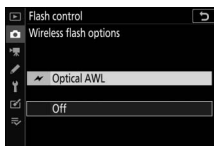

Option	Description
 <b>Optical AWL</b>	The remote flash units are controlled using low-intensity flashes emitted by the master flash (☞ 406).
<b>Off</b>	Remote flash photography disabled.

## Group Flash Options

Adjust settings for the flash units in each group when using optional flash units (☞ 405).

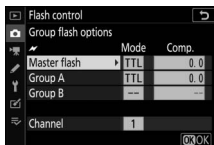

## Flash Mode

MENU button →  (photo shooting menu)

Choose the flash mode for the built-in flash or optional flash units mounted on the camera accessory shoe. For more information, see “Flash Modes” (☞ 108).

## Flash Compensation

MENU button →  (photo shooting menu)

Adjust flash output for the built-in flash or optional flash units mounted on the camera accessory shoe to control the brightness of the main subject relative to the background (📖 111). Flash output can be increased to make the main subject appear brighter or reduced to prevent unwanted highlights or reflections.

## Release Mode

MENU button →  (photo shooting menu)

Choose the operation performed when the shutter is released. For more information, see “Release Mode” (📖 135).

## Focus Mode

MENU button →  (photo shooting menu)

The focus mode controls how the camera focuses. For more information, see “Choosing a Focus Mode” (📖 51).

## AF-Area Mode

MENU button →  (photo shooting menu)

Choose how the camera selects the focus-point for autofocus. For more information, see “AF-Area Mode” (📖 54).

## Optical VR

MENU button →  (photo shooting menu)

Choose whether to enable optical vibration reduction. For more information, see “Optical VR” (📖 139).

## Auto Bracketing

MENU button →  (photo shooting menu)

Vary exposure, Active D-Lighting (ADL), or white balance slightly with each shot, “bracketing” the current value. Bracketing can be used in situations in which getting the right settings is difficult and there is not time to check results and adjust settings with each shot, or to experiment with different settings for the same subject. The following options are available:

- **Auto bracketing set:** Choose the setting or settings bracketed when auto bracketing is in effect. Choose **AE bracketing** to perform exposure bracketing, **WB bracketing** to perform white-balance bracketing, or **ADL bracketing** to perform bracketing using Active D-Lighting.
- **Number of shots:** Choose the number of shots in the bracketing sequence.
- **Increment:** Choose the amount the selected settings vary with each shot (ADL bracketing excluded).
- **Amount:** Choose how Active D-Lighting varies with each shot (ADL bracketing only).

## Exposure Bracketing

Vary exposure over a series of photographs.



Exposure modified by:  
0 EV



Exposure modified by:  
-1 EV





Exposure modified by:  
+1 EV

### 1 Select AE bracketing for Auto bracketing set.

The camera will display **Number of shots** and **Increment** options.

### 2 Choose the number of shots.

Highlight **Number of shots** and press  or  to choose the number of shots in the bracketing sequence.



At settings other than **0F**, a bracketing icon will appear in the display.

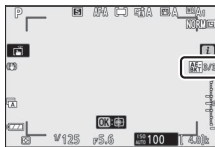

**3 Choose a bracketing increment.**  
 Highlight **Increment** and press  $\odot$  or  $\odot$  to choose the bracketing increment. When **1/3 step** is selected for Custom Setting b1 (**EV steps for exposure cntrl**), the size of the increment can be chosen from 0.3 ( $\frac{1}{3}$ ), 0.7 ( $\frac{2}{3}$ ), 1, 2, and 3 EV. The bracketing programs with an increment of 0.3 ( $\frac{1}{3}$ ) EV are listed below.



"Number of shots"	Bracketing indicator	No. of shots	Bracketing order (EVs)
0F	-.....0.....+	0	0
+3F	-.....0.....+	3	0/+0.3/+0.7
-3F	-.....0.....+	3	0/-0.7/-0.3
+2F	-.....0.....+	2	0/+0.3
-2F	-.....0.....+	2	0/-0.3
3F	-.....0.....+	3	0/-0.3/+0.3
5F	-.....0.....+	5	0/-0.7/-0.3/+0.3/+0.7
7F	-.....0.....+	7	0/-1.0/-0.7/-0.3/+0.3/+0.7/+1.0
9F	-.....0.....+	9	0/-1.3/-1.0/-0.7/-0.3/+0.3/+0.7/+1.0/+1.3

Note that for exposure increments of 2 EV or more, the maximum number of shots is 5; if a higher value was selected in Step 2, the number of shots will automatically be set to 5.

## 4 Frame a photograph, focus, and shoot.

The camera will vary exposure shot-by-shot according to the bracketing program selected; the modified values for shutter speed and aperture are shown in the display. Modifications to exposure are added to those made with exposure compensation.



While bracketing is in effect, the display shows a bracketing icon, a bracketing progress indicator, and the number of shots remaining in the bracketing sequence. After each shot, a segment will disappear from the indicator and the number of shots remaining will be reduced by one.

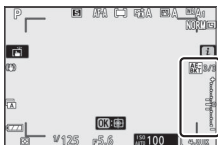

*No. shots: 3; increment: 0.7*

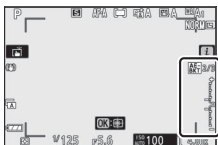

*Display after first shot*

### ■ ■ Canceling Bracketing

To cancel bracketing, select **0F** for **Number of shots**.

## Exposure Bracketing

In continuous release modes, shooting will pause after the number of shots specified in the bracketing program have been taken. Shooting will resume the next time the shutter-release button is pressed.

If the memory card fills before all shots in the sequence have been taken, shooting can be resumed from the next shot in the sequence after the memory card has been replaced or shots have been deleted to make room on the memory card. If the camera is turned off before all shots in the sequence have been taken, bracketing will resume from the next shot in the sequence when the camera is turned on.

The camera modifies exposure by varying shutter speed and aperture (mode **P**), aperture (mode **S**), or shutter speed (modes **A** and **M**). If **On** is selected for **ISO sensitivity settings > Auto ISO sensitivity control** in modes **P**, **S**, and **A**, the camera will automatically vary ISO sensitivity for optimum exposure when the limits of the camera exposure system are exceeded; in mode **M**, the camera will first use auto ISO sensitivity control to bring exposure as close as possible to the optimum and then bracket this exposure by varying shutter speed.



## White Balance Bracketing

The camera creates multiple copies of each photograph, each with a different white balance.

### 1 Choose WB bracketing.

Select **WB bracketing** for **Auto bracketing set**.

### 2 Choose the number of shots.

Highlight **Number of shots** and press  or  to choose the number of shots in the bracketing sequence.

At settings other than **0F**, a bracketing icon will appear in the display.

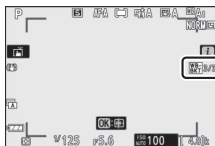



### 3 Choose a bracketing increment.

Highlight **Increment** and press  $\odot$  or  $\odot$  to choose the bracketing increment. Each increment is roughly equivalent to 5 mired. Choose from increments of 1 (5 mired), 2 (10 mired), or 3 (15 mired). Higher **B** values correspond to increased amounts of blue, higher **A** values to increased amounts of amber. The bracketing programs with an increment of 1 are listed below.



"Number of shots"	Bracketing indicator	No. of shots	Increment	Bracketing order
0F	+.....0.....+	0	1	0
B3F	+.....;0.....+	3	1B	0/B1/B2
A3F	+.....;0.....+	3	1A	0/A2/A1
B2F	+.....;0.....+	2	1B	0/B1
A2F	+.....;0.....+	2	1A	0/A1
3F	+.....;0.....+	3	1A, 1B	0/A1/B1
5F	+.....;0.....+	5		0/A2/A1/B1/B2
7F	+.....;0.....+	7		0/A3/A2/A1/ B1/B2/B3
9F	+.....;0.....+	9		0/A4/A3/A2/A1/ B1/B2/B3/B4

## 4 Frame a photograph, focus, and shoot.

Each shot will be processed to create the number of copies specified in the bracketing program, and each copy will have a different white balance.



Modifications to white balance are added to the white balance adjustment made with white balance fine-tuning.

If the number of shots in the bracketing program is greater than the number of exposures remaining, the shutter release will be disabled. Shooting can begin when a new memory card is inserted.

### ■ ■ *Canceling Bracketing*

To cancel bracketing, select **0F** for **Number of shots**.

#### ✓ **White Balance Bracketing**

White balance bracketing is not available at an image quality of NEF (RAW). Selecting an NEF (RAW) or NEF (RAW) + JPEG option cancels white balance bracketing.

White balance bracketing affects only color temperature (the amber-blue axis in the white balance fine-tuning display). No adjustments are made on the green-magenta axis.

In self-timer mode, the number of copies specified in the bracketing program will be created each time the shutter is released, regardless of the option selected for Custom Setting c2 (**Self-timer**) > **Number of shots**.

If the camera is turned off while the memory card access lamp is lit, the camera will power off only after all photographs in the sequence have been recorded.

## ADL Bracketing

The camera varies Active D-Lighting over a series of exposures.

### 1 Choose ADL bracketing.

Select **ADL bracketing** for **Auto bracketing set**.

### 2 Choose the number of shots.

Highlight **Number of shots** and press  $\leftarrow$  or  $\rightarrow$  to choose the number of shots in the bracketing sequence. Choose two shots to take one photograph with Active D-Lighting

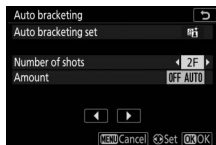

off and another at the value selected in Step 3. Choose three to five shots to take a series of photographs with Active D-Lighting set to **Off**, **Low**, and **Normal** (three shots), **Off**, **Low**, **Normal**, and **High** (four shots), or **Off**, **Low**, **Normal**, **High**, and **Extra high** (five shots). If you choose more than two shots, proceed to Step 4.

At settings other than **0F**, a bracketing icon will appear in the display.

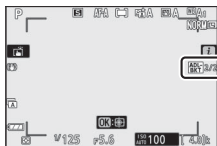

### 3 Choose a value for Active D-Lighting.

Highlight **Amount** and press  $\leftarrow$  or  $\rightarrow$  to choose an option. The chosen setting applies when **2F** is selected for **Number of shots**.

Amount	Bracketing order
OFF L	Off/Low
OFF N	Off/Normal
OFF H	Off/High
OFF H+	Off/Extra high
OFF AUTO	Off/Auto

## 4 Frame a photograph, focus, and shoot.

The camera will vary Active D-Lighting shot-by-shot according to the bracketing program selected.



While bracketing is in effect, the display shows an ADL bracketing icon and the number of shots remaining in the bracketing sequence. After each shot, the number of shots remaining will be reduced by one.

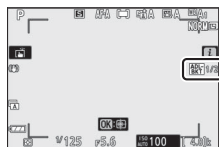

### ■ Canceling Bracketing

To cancel bracketing, select **0F** for **Number of shots**.

#### ADL Bracketing

In continuous release modes, shooting will pause after the number of shots specified in the bracketing program have been taken. Shooting will resume the next time the shutter-release button is pressed.

If the memory card fills before all shots in the sequence have been taken, shooting can be resumed from the next shot in the sequence after the memory card has been replaced or shots have been deleted to make room on the memory card. If the camera is turned off before all shots in the sequence have been taken, bracketing will resume from the next shot in the sequence when the camera is turned on.

## Multiple Exposure

MENU button →  (photo shooting menu)

Record two to ten NEF (RAW) exposures as a single photograph. The following options are available:

- **Multiple exposure mode:** Choose from **On (series)** (take a series of multiple exposures, ending when **Off** is selected), **On (single photo)** (take one multiple exposure), or **Off** (exit without creating additional multiple exposures).
- **Number of shots:** Choose the number of exposures that will be combined to form a single photograph.
- **Overlay mode:** Choose from the options below.
  - **Add:** The exposures are overlaid without modification; gain is not adjusted.
  - **Average:** Before the exposures are overlaid, the gain for each is divided by the total number of exposures (the gain for each exposure is set to  $\frac{1}{2}$  for 2 exposures,  $\frac{1}{3}$  for 3 exposures, etc).
  - **Lighten:** The camera compares the pixels in each exposure and uses only the brightest.

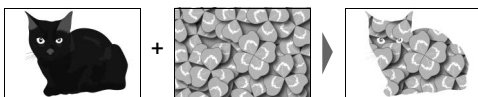

- **Darken:** The camera compares the pixels in each exposure and uses only the darkest.

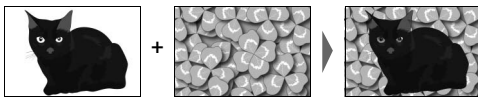

- **Keep all exposures:** Choose **On** to save the individual shots that make up each multiple exposure, **Off** to discard the individual shots and save only the multiple exposure.
- **Overlay shooting:** If **On** is selected, earlier exposures will be superimposed on the view through the lens during shooting.
- **Select first exposure (NEF):** Choose the first exposure from the NEF (RAW) images on the memory card.

## Creating a Multiple Exposure



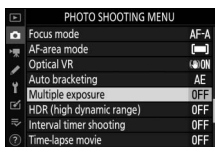

Follow the steps below to shoot a multiple exposure.

### 1 Select Multiple exposure.

Highlight **Multiple exposure** in the photo shooting menu and press .



### 2 Select a mode.

Highlight **Multiple exposure mode** and press , then press  or  to choose the desired mode and press  to select.



If **On (series)** or **On (single photo)** is selected, an icon will appear in the display.

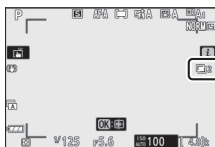

---

### 3 Choose the number of shots.

Highlight **Number of shots** and press . Press or to choose the number of exposures that will be combined to form a single photograph and press .

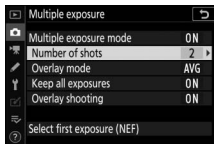

---

### 4 Choose the overlay mode.

Highlight **Overlay mode** and press , then press or to choose the desired mode and press to select.

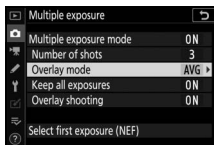

---

### 5 Choose whether to keep individual exposures.

To choose whether to keep or delete the individual shots that make up the multiple exposure, highlight **Keep all exposures** and press , then press or to choose the desired option and press to select.

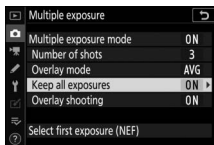

---

### 6 Choose whether to view progress in the display.

To choose whether earlier exposures are superimposed over the view through the lens as shooting progresses, highlight **Overlay shooting** and press , then press or to choose the desired option and press to select.

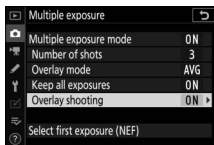

## 7 Choose the first exposure.

To choose the first exposure from existing NEF (RAW) photos, highlight **Select first exposure (NEF)** and press . Use the multi selector to highlight the desired image and press to select (to view the highlighted image full screen, touch and hold the button).

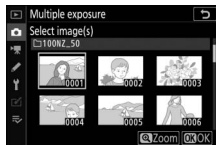

## 8 Frame a photograph, focus, and shoot.

Continue shooting until all exposures have been taken and the final photograph has been recorded (if you selected an existing NEF (RAW) image as the first exposure in Step 7, shooting will start from the second exposure). If **On (single photo)** was selected in Step 2, multiple exposure shooting will end when the photo is recorded; otherwise, you can continue taking multiple exposures until multiple exposure shooting is turned off.

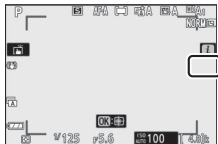





### ✔ Release Mode

In continuous release modes, the camera records all exposures in a single burst. If **On (series)** is selected, a new multiple exposure will start as each previous multiple exposure ends; if **On (single photo)** is selected, multiple exposure shooting will end after the first multiple exposure is recorded. In self-timer mode, the camera will automatically record the number of exposures selected in Step 3, regardless of the option selected for Custom Setting c2 (**Self-timer**) > **Number of shots**; the interval between shots is however controlled by Custom Setting c2 (**Self-timer**) > **Interval between shots**. In other release modes, one photograph will be taken each time the shutter-release button is pressed; continue shooting until all exposures have been recorded.

### ✔ Image Quality

Multiple exposures shot with an NEF (RAW) option selected for image quality will be recorded in JPEG fine format.

## The *i* Menu

The options listed below can be accessed during multiple exposure shooting by pressing the  button followed by the *i* button. Highlight items and press  to select.

- **View progress:** View a preview created from the exposures recorded to the current point.
- **Retake last exposure:** Retake the most recent exposure.
- **Save and exit:** Create a multiple exposure from the exposures taken to current point.
- **Discard and exit:** Exit without recording a multiple exposure. If **On** is selected for **Keep all exposures**, the individual exposures will be kept.

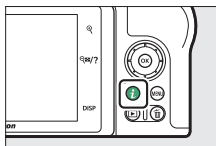

### Multiple Exposure

Shooting may also end if camera settings are changed before the exposure is complete. The shooting settings and photo info for multiple exposure photographs are those for the first exposure.



Do not remove or replace the memory card while recording a multiple exposure.

Multiple exposures may be affected by noise (randomly-spaced bright pixels, fog, or lines).

### Other Settings

While a multiple exposure is being shot, memory cards cannot be formatted and some menu items are grayed out and cannot be changed.

## Ending Multiple Exposures

To end a multiple exposure before the specified number of exposures have been taken, select **Off** for **Multiple exposure mode** or press the  button followed by the  button and select either **Save and exit** or **Discard and exit**. If shooting ends or you select **Save and exit** before the specified number of exposures have been taken, a multiple exposure will be created from the exposures that have been recorded to that point. If **Average** is selected for **Overlay mode**, gain will be adjusted to reflect the number of exposures actually recorded. Note that shooting will end automatically if the standby timer expires.

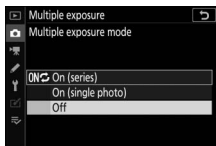

### **The Standby Timer**

Menus and playback can be used between exposures, but note that if no operations are performed for about 40 seconds during playback or 90 seconds while menus are displayed, shooting will end and a multiple exposure will be created from the exposures recorded to that point. The time available to record the next exposure can be extended by choosing longer times for Custom Setting c3 (**Power off delay**) > **Playback** and **Menus**.

## HDR (High Dynamic Range)

MENU button → 📷 (photo shooting menu)

Used with high contrast subjects, High Dynamic Range (HDR) preserves details in highlights and shadows by combining two shots taken at different exposures. HDR is most effective when used with matrix metering (with spot or center-weighted metering, an exposure differential of **Auto** is equivalent to about 2 EV). It cannot be combined with some camera features, including NEF (RAW) or NEF (RAW)+ image quality settings, flash photography, bracketing, multiple exposure, shutter speeds of **Bulb** and **Time**, or interval timer, or time-lapse recording.



First exposure (darker)

+



Second exposure  
(brighter)



Combined HDR image

The following options are available:

- **HDR mode:** Choose from **On (series)** (take a series of HDR photographs, ending when **Off** is selected), **On (single photo)** (take one HDR photograph), and **Off** (exit without taking additional HDR photographs).
- **Exposure differential:** Choose the difference in exposure between the two shots that are combined to make an HDR photograph. Choose larger values for high-contrast subjects, or select **Auto** to let the camera adjust the exposure differential according to the scene.
- **Smoothing:** Choose how much to smooth the boundaries between the shots that make up each HDR photograph.

- **Save individual images (NEF):** Choose **On** to save each of the individual shots used to create the HDR image. The photos are saved as NEF (RAW) files regardless of the options selected for image quality in the photo shooting menu.

# Taking HDR Photographs

Follow the steps below to shoot HDR photographs.

- 1 Select HDR (high dynamic range).**  
Highlight **HDR (high dynamic range)** in the photo shooting menu and press .

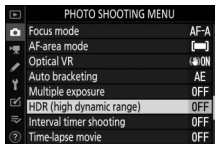

- 2 Select a mode.**  
Highlight **HDR mode** and press .

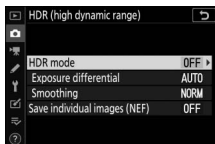

Highlight one of the following and press .

- **To take a series of HDR photographs,** select **ON (series)**. HDR shooting will continue until you select **Off** for **HDR mode**.
- **To take one HDR photograph,** select **On (single photo)**. Normal shooting will resume automatically after you have created a single HDR photograph.
- **To exit without creating additional HDR photographs,** select **Off**.

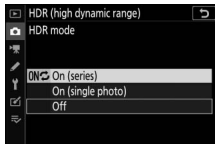

If **On (series)** or **On (single photo)** is selected, an icon will appear in the display.

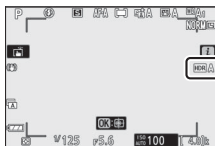

---

### 3 Choose the exposure differential.

To choose the difference in exposure between the two shots, highlight **Exposure differential** and press .

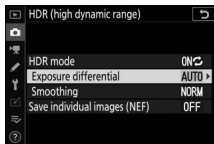

Highlight an option and press . Choose higher values for high-contrast subjects, but note that choosing a value higher than required may not produce the desired results; if **Auto** is selected, the camera will automatically adjust exposure to suit the scene.

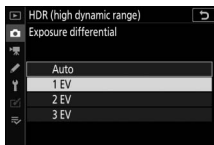

---

### 4 Choose the amount of smoothing.

To choose how much the boundaries between the two images are smoothed, highlight **Smoothing** and press .

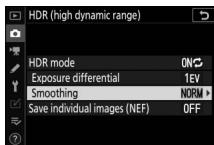



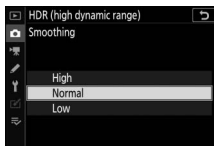

Highlight an option and press . Higher values produce a smoother composite image. Uneven shading may be visible with some subjects.



---

## 5 Choose whether to keep individual exposures.

To choose whether to save the individual NEF (RAW) images that make up the HDR photograph, highlight **Save individual images**

(NEF) and press , then press  or  to choose the desired option and press  to select.

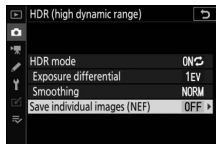

---

## 6 Frame a photograph, focus, and shoot.

The camera takes two exposures when the shutter-release button is pressed all the way down. Regardless of the option currently selected for release mode, only one photograph will be taken each time the shutter-release button is pressed.

If **On (series)** is selected, HDR will only turn off when **Off** is selected for HDR mode; if **On (single photo)** is selected, HDR turns off automatically after the photograph is taken.

### Framing HDR Photographs

The edges of the image will be cropped out. The desired results may not be achieved if the camera or subject moves during shooting. Use of a tripod is recommended. Depending on the scene, shadows may appear around bright objects or halos may appear around dark objects; this effect can be reduced by adjusting the amount of smoothing.



## Interval Timer Shooting

MENU button →  (photo shooting menu)

Take photographs at the selected interval until the specified number of shots has been recorded. Select a release mode other than **Self-timer** (⊙) when using the interval timer.

Selecting **Interval timer shooting** displays the options below.

- **Start:** Start interval timer shooting, either after 3 s (**Now** selected for **Choose start day/time**) or at a selected date and time (**Choose day/time**). Shooting will continue at the selected interval until all shots have been taken.
- **Choose start day/time:** Choose a start option. To start shooting immediately, select **Now**. To start shooting at a chosen date and time, select **Choose day/time**.
- **Interval:** Choose the interval (hours, minutes, and seconds) between shots.
- **Intervals×shots/interval:** Choose the number of intervals and the number of shots per interval.
- **Exposure smoothing:** Selecting **On** allows the camera to adjust exposure to match previous shot in modes other than **M** (note that exposure smoothing only takes effect in mode **M** if auto ISO sensitivity control is on). Large changes in subject brightness during shooting may result in apparent variations in exposure, in which case it may be necessary to shorten the interval between shots.
- **Silent photography:** Select **On** to silence the shutter during shooting.

- **Interval priority:** Select **On** to ensure that photos shot in modes **P** and **A** are taken at the chosen interval, **Off** to ensure that photos are correctly exposed. If **On** is selected, choose a focus mode of **MF** or **AF-C** and check that the minimum shutter speed chosen for **ISO sensitivity settings > Auto ISO sensitivity control** in the photo shooting menu is faster than the interval. If **AF-C** is selected for focus mode, check that **Release** is chosen for Custom Setting a1 (**AF-C priority selection**).
- **Starting storage folder:** Highlight options and press  to select or deselect. Choose **New folder** to create a new folder for each new sequence, **Reset file numbering** to reset file numbering to 0001 when a new folder is created.

# Interval Timer Photography

## ✔ Before Shooting

Before beginning interval timer photography, take a test shot at current settings and view the results. Before choosing a starting time, select **Time zone and date** in the setup menu and make sure that the camera clock is set to the correct time and date. To ensure that shooting is not interrupted, be sure the camera battery is fully charged. If in doubt, charge the battery before use.

## 1 Select Interval timer shooting.

Highlight **Interval timer shooting** in the photo shooting menu and press .

Interval timer shooting options will be displayed.

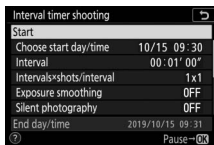
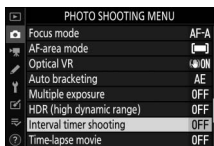

## 2 Adjust interval timer settings.

Adjust the following settings:

- **Choose start day/time:** Choose the starting date and time.

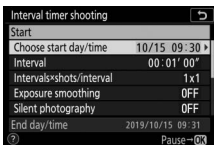

Highlight **Choose start day/time** and press .

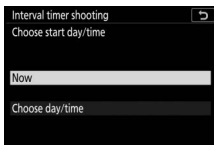

Highlight an option and press .

To start shooting immediately, select **Now**. To start shooting at a chosen date and time, select **Choose day/time**, then choose the date and time and press .

- **Interval:** Choose the interval, in hours, minutes, and seconds.

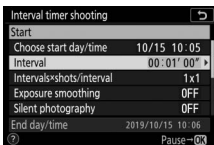

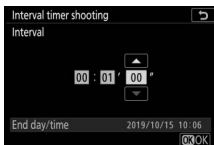

Highlight **Interval** and press .



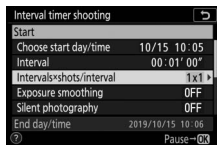

Choose an interval and press .

- **Intervals×shots/interval:** Choose the number of intervals and the number of shots per interval.

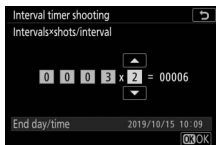

Highlight **Intervals×shots/interval** and press .



Choose the number of intervals and shots/interval and press .

In single frame release mode, the photographs for each interval will be taken at the rate for continuous high-speed release mode. When silent photography is enabled, the number of shots per interval is fixed at one.

- **Exposure smoothing:** Enable or disable exposure smoothing.

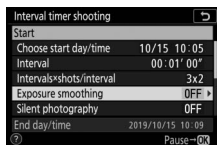

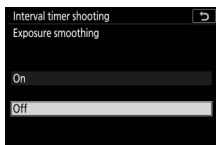

Highlight **Exposure smoothing** and press .



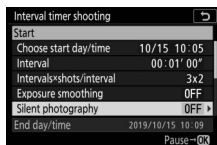

Highlight an option and press .

- **Silent photography:** Enable or disable silent photography.

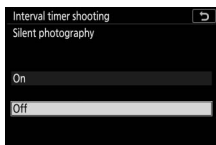

Highlight **Silent photography** and press .



Highlight an option and press .

- **Interval priority:** Enable or disable **Interval priority**.

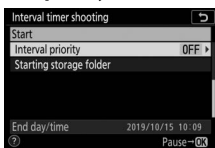

Highlight **Interval priority** and press  $\downarrow$ .

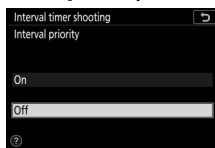

Highlight an option and press  $\odot$ .

- **Starting storage folder:** Choose starting folder options.

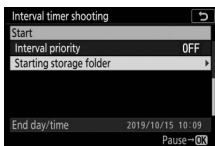

Highlight **Starting storage folder** and press  $\downarrow$ .



Highlight options and press  $\downarrow$  to select or deselect; press  $\odot$  to proceed.

### 3 Start shooting.

Highlight **Start** and press  $\odot$ . The first series of shots will be taken at the specified starting time, or after about 3 s if **Now** was selected for **Choose start day/time** in Step 2. The display turns off during shooting; shooting will continue at the selected interval until all shots have been taken.

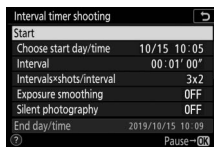

### ✔ During Shooting

During interval timer photography, the memory card access lamp will flash.

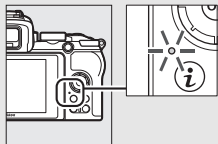

If the display is turned on by pressing the shutter-release button halfway, the message “Interval timer shooting” will be displayed and the **INTVL** icon will flash. Settings can be adjusted, the menus used, and pictures played back while interval timer photography is in progress. The display will turn off automatically shortly before each interval. Note that changing camera settings while the interval timer is active may cause shooting to end.

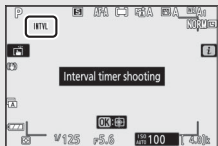

## ■ Pausing Interval Timer Photography

Interval timer photography can be paused between intervals as follows:

- If **Now** is selected for **Choose start day/time**, interval timer photography can be paused by pressing **OK** (pressing **OK** between shots may have no effect if the time selected for **Interval** is very short, in which case interval timer photography can be paused by turning the camera off)
- If **Choose day/time** is selected for **Choose start day/time**, interval timer photography can be paused by selecting **Interval timer shooting** in the photo shooting menu, highlighting **Pause**, and pressing **OK**

## ■ Resuming Interval Timer Photography

To resume shooting immediately, select **Restart**.

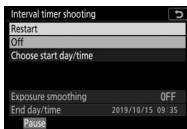

Highlight **Restart** and press **OK**.

To resume shooting at a specified time:

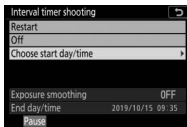

In the interval timer menu, highlight **Choose day/time** and press **OK**.

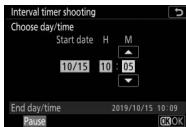

Choose a starting date and time and press **OK**.

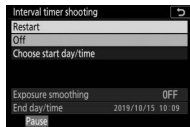

Highlight **Restart** and press **OK**.

## ■ Ending Interval Timer Shooting

Interval timer photography can be ended as follows:

- If **Now** is selected for **Choose start day/time**, interval timer photography can be ended by pressing **OK** between shots to pause shooting and then highlighting **Off** in the **Interval timer shooting** menu and pressing **OK** (pressing **OK** between shots may have no effect if the time selected for **Interval** is very short, in which case interval timer photography can be paused by turning the camera off)
- If **Choose day/time** is selected for **Choose start day/time**, interval timer photography can be paused by selecting **Interval timer shooting** in the photo shooting menu, highlighting **Pause**, and pressing **OK**



## ■ ■ **No Photograph**

Photographs will not be taken at the selected interval if the current interval ends before the photograph or photographs for the previous interval have been taken or the memory card is full.

### ✔ **Out of Memory**

If the memory card is full, the interval timer will remain active but no pictures will be taken. Resume shooting after deleting some pictures or turning the camera off and inserting another memory card.

### ✔ **Interval Timer Photography**

Choose an interval longer than the time needed to take the selected number of shots and, if you are using a flash, the time needed for the flash to charge. If the interval is too short, the number of photos taken may be less than the total listed in Step 2 (the number of intervals multiplied by the number of shots per interval) or the flash may fire at less than the power needed for full exposure. Interval timer photography will not start if the interval is set to **00:00'0.5"** and both **Silent photography** and **Interval priority** are enabled. Interval timer photography cannot be combined with some camera features, including movie recording, time-lapse movies, long time-exposures (bulb or time photography), multiple exposure, and HDR (high dynamic range). Note that because the shutter speed, frame rate, and time needed to record images may vary from one interval to the next, the time between the end of one interval and the beginning of the next may vary. If shooting cannot proceed or changes cannot be applied at current settings (for example, if a shutter speed of **Bulb** or **Time** is currently selected in mode **M**, the interval is zero, or the start time is in less than a minute), a warning will be displayed.

Interval timer shooting will pause when **Self-timer** (☺) is selected for release mode or if the camera is turned off and then on again (when the camera is off, batteries and memory cards can be replaced without ending interval timer photography). Pausing shooting does not affect interval timer settings.

### ✔ Release Mode

Regardless of the release mode selected, the camera will take the specified number of shots at each interval.

### ✔ Bracketing

Adjust bracketing settings before starting interval timer photography. If exposure or ADL bracketing is active while interval timer photography is in effect, the camera will take the number of shots in the bracketing program at each interval, regardless of the number of shots specified in the interval timer menu. If white balance bracketing is active while interval timer photography is in effect, the camera will take one shot at each interval and process it to create the number of copies specified in the bracketing program. Note that bracketing cannot be used during interval timer photography when **On** is selected for **Interval priority**.

### ✔ Silent Photography

Selecting **On** for **Silent photography** disables some camera features, including:

- ISO sensitivities of Hi 1 and Hi 2
- Flash photography
- Long exposure noise reduction
- Flicker reduction

## Time-Lapse Movie

MENU button →  (photo shooting menu)





The camera automatically takes photos at selected intervals to create a silent time-lapse movie.

Selecting **Time-lapse movie** displays the options below.

- **Start:** Start time-lapse recording. Shooting starts after about 3 s and continues at the selected interval for the selected shooting time.
- **Interval:** Choose the interval between shots in minutes and seconds.
- **Shooting time:** Choose how long the camera will continue to take pictures (hours and minutes).
- **Exposure smoothing:** Selecting **On** smooths abrupt changes in exposure in modes other than **M** (note that exposure smoothing only takes effect in mode **M** if auto ISO sensitivity control is on). Large changes in subject brightness during shooting may result in apparent variations in exposure, in which case it may be necessary to shorten the interval between shots.
- **Silent photography:** Select **On** to silence the shutter during shooting.
- **Frame size/frame rate:** Choose the frame size and rate for the final movie.
- **Interval priority:** Select **On** to ensure that frames shot in modes **P** and **A** are taken at the chosen interval, **Off** to ensure that photos are correctly exposed. If **On** is selected, choose a focus mode of **MF** or **AF-C** and check that the minimum shutter speed chosen for **ISO sensitivity settings** > **Auto ISO sensitivity control** in the photo shooting menu is faster than the interval. If **AF-C** is selected for focus mode, check that **Release** is chosen for Custom Setting a1(**AF-C priority selection**).

## Recording Time-Lapse Movies

### ✔ Before Shooting

Before shooting a time-lapse movie, select **Time zone and date** in the setup menu and make sure that the camera clock is set to the correct time and date, and then take a test shot at current settings and view the results. Time-lapse movies are shot using the movie crop; to check the composition, tap the  button in the **Time-lapse movie** display (to return to the **Time-lapse movie** display, tap the  button). For consistent coloration, choose a white balance setting other than  **A** (auto) or  **A** (natural light auto).

To ensure that shooting is not interrupted, be sure the camera battery is fully charged. If in doubt, charge the battery before use.

### 1 Select Time-lapse movie.

Highlight **Time-lapse movie** in the photo shooting menu and press .

Time-lapse movie options will be displayed.

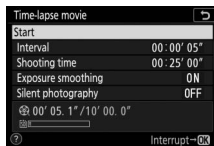
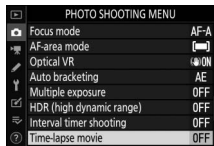

## 2 Adjust time-lapse movie settings.

Adjust the following settings:

- **Interval:** The interval (in minutes and seconds) should be longer than the slowest anticipated shutter speed.

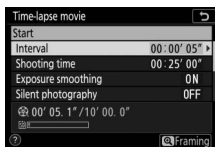

Highlight **Interval** and press

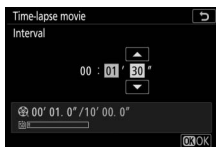

Choose an interval and press

- **Shooting time:** The total shooting time (in hours and minutes) can be up to 7 hours and 59 minutes.



Highlight **Shooting time** and press

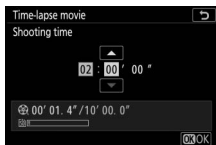

Choose a shooting time and press

- **Exposure smoothing:** Enable or disable exposure smoothing.

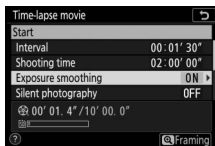

Highlight **Exposure smoothing** and press

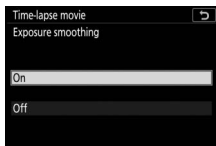

Highlight an option and press

- **Silent photography:** Enable or disable silent photography.

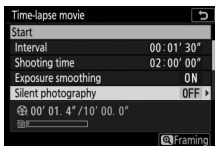

Highlight **Silent photography** and press  $\odot$ .

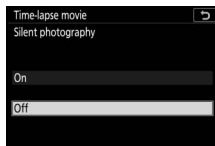

Highlight an option and press  $\odot$ .

- **Frame size/frame rate:** Choose the frame size and rate at which the final movie will play back.

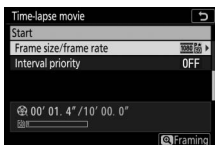

Highlight **Frame size/frame rate** and press  $\odot$ .

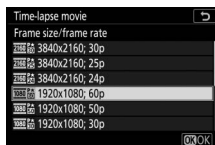

Highlight an option and press  $\odot$ .

- **Interval priority:** Enable or disable **Interval priority**.

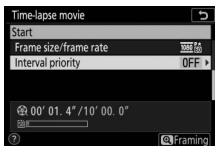

Highlight **Interval priority** and press  $\odot$ .

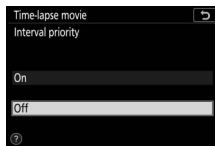

Highlight an option and press  $\odot$ .

### 3 Start shooting.

Highlight **Start** and press **OK**.

Shooting starts after about 3 s. The display turns off and the camera takes photographs at the selected interval for the selected shooting time.

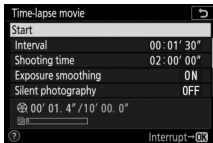

#### ✔ During Shooting

During shooting, the memory card access lamp will light. Regardless of the option selected for Custom Setting c3 (**Power off delay**, 277) > **Standby timer**, the standby timer will not expire during shooting.

#### ✔ Adjusting Settings Between Shots

Shooting and menu settings can be adjusted between shots. Note, however, that the monitor will turn off approximately 2 s before the next shot is taken.

## ■ Ending Shooting

To end shooting before all the photos are taken, press  $\odot$  between shots. You also have the option of pressing the **MENU** button to display the **Time-lapse movie** menu, highlighting **Off**, and pressing  $\odot$ . If, however, the time selected for **Interval** is very short, pressing  $\odot$  between shots may have no effect or the **Time-lapse movie** menu may not be displayed when the **MENU** button is pressed, in which case you will need to turn the camera off.

- When shooting ends, a movie will be created from the frames shot to that point and the camera will exit to shooting mode. Note that if the battery is removed or the memory card is ejected, shooting ends (but no beep will sound) and no movie will be recorded.

### ✓ Calculating the Length of the Final Movie

The total number of frames in the final movie can be calculated by dividing the shooting time by the interval, rounding up, and adding 1. The length of the final movie can then be calculated by dividing the number of shots by the frame rate selected for **Frame size/frame rate**. A 48-frame movie recorded at 1920 × 1080; 24p, for example, will be about two seconds long. The maximum length for time-lapse movies is 20 minutes.

#### Frame size/frame rate

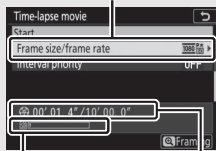

Memory card indicator

Length recorded/  
maximum length



### ✔ Time-Lapse Movies

Time-lapse cannot be combined with some camera features, including movie recording, long time-exposures (bulb or time photography), the self-timer, bracketing, HDR (high dynamic range), multiple exposure, and interval timer photography. Active D-Lighting is disabled automatically. Note that because shutter speed and the time needed to record the image to the memory card may vary from shot to shot, the interval between a shot being recorded and the start of the next shot may vary. Changes to settings will not be applied and shooting will not begin if a time-lapse movie cannot be recorded at current settings (for example, if the memory card is full, the interval or shooting time is zero, or the interval is longer than the shooting time).

Shooting may end if camera controls are used or settings are changed or HDMI cable is connected. A movie will be created from the frames shot to the point where shooting ended.

### ✔ Image Review

The  button cannot be used to view pictures while shooting is in progress, but the current frame will be displayed for a few seconds after each shot if **On** or **On (monitor only)** is selected for **Image review** in the playback menu (the frame may not be displayed if the interval is very short). Other playback operations cannot be performed while the frame is displayed.

### ✔ Silent Photography

Selecting **On** for **Silent photography** disables some camera features, including:

- ISO sensitivities of Hi 1 and Hi 2
- Flash photography
- Long exposure noise reduction
- Flicker reduction

## Silent Photography

MENU button →  (photo shooting menu)

Select **On** to reduce vibrations caused by the shutter when shooting landscapes and other static subjects (📖 71). Use of a tripod is recommended. Pictures are taken using the electronic shutter, regardless of the option selected for Custom Setting d4 (**Shutter type**). Regardless of the option selected for **Beep options** in the setup menu, a beep will not sound when the camera focuses or the self-timer is counting down, and both the flash and long-exposure noise reduction will be disabled. In continuous release modes, the frame advance rate will change (📖 136).

## 🎬 The Movie Shooting Menu: *Movie Shooting Options*

To view the movie shooting menu, select the 🎬 tab in the camera menus.

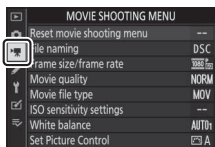

Option	
Reset movie shooting menu	258
File naming	258
Frame size/frame rate	258
Movie quality	258
Movie file type	258
ISO sensitivity settings	259
White balance	259
Set Picture Control	260
Manage Picture Control	260
Active D-Lighting	260
High ISO NR	260
Vignette control	261
Diffraction compensation	261

Option	
Auto distortion control	261
Flicker reduction	261
Metering	262
Release mode (save frame)	262
Focus mode	262
AF-area mode	262
Optical VR	263
Electronic VR	263
Microphone sensitivity	263
Attenuator	264
Frequency response	264
Wind noise reduction	264

### ✔ See Also

For menu defaults, see "Movie Shooting Menu Defaults" (📖 175).

## Reset Movie Shooting Menu

MENU button →  (movie shooting menu)

Select **Yes** to restore movie shooting menu options to their default values (📖 175).

## File Naming

MENU button →  (movie shooting menu)

Choose the three-letter prefix used in naming the image files in which movies are stored. The default prefix is “DSC” (📖 193).

## Frame Size/Frame Rate

MENU button →  (movie shooting menu)

Choose the movie frame size (in pixels) and frame rate. For more information, see “Frame Size, Frame Rate, and Movie Quality” (📖 143).

## Movie Quality

MENU button →  (movie shooting menu)

Choose from **High quality** and **Normal**.

## Movie File Type

MENU button →  (movie shooting menu)

Record movies in MOV or MP4 format.

## ISO Sensitivity Settings

MENU button →  (movie shooting menu)

Adjust the following ISO sensitivity settings.

- **Maximum sensitivity:** Choose the upper limit for auto ISO sensitivity control from values between ISO 200 and 25600. Auto ISO sensitivity control is used in modes **P**, **S**, and **A** and when **On** is selected for **Auto ISO control (mode M)** in mode **M**.
- **Auto ISO control (mode M):** Select **On** to enable auto ISO sensitivity control in mode **M**, **Off** to use the value selected for **ISO sensitivity (mode M)**.
- **ISO sensitivity (mode M):** Choose the ISO sensitivity for mode **M** from values between ISO 100 and 25600. Auto ISO sensitivity control is used in other modes.

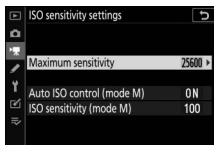

### Auto ISO Sensitivity Control

At high ISO sensitivities, the camera may have difficulty focusing and noise (randomly-spaced bright pixels, fog, or lines) may increase. This can be prevented by choosing a lower value for **ISO sensitivity settings > Maximum sensitivity**.

## White Balance

MENU button →  (movie shooting menu)

Choose the white balance for movies ( 67). Select **Same as photo settings** to use the option currently selected for photos.

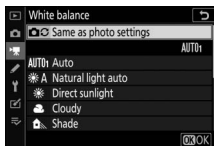

## Set Picture Control

MENU button →  (movie shooting menu)

Choose a Picture Control for movies (📖 116). Select **Same as photo settings** to use the option currently selected for photos.

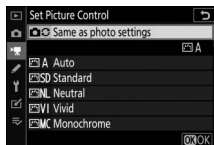

## Manage Picture Control

MENU button →  (movie shooting menu)

Create custom Picture Controls (📖 206).

## Active D-Lighting

MENU button →  (movie shooting menu)

Preserve details in highlights and shadows, creating movies with natural contrast. Select **Same as photo settings** to use the option currently selected for photos (📖 133, 147).

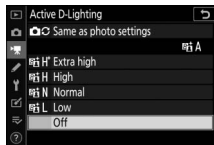



## High ISO NR

MENU button →  (movie shooting menu)

Reduce “noise” (randomly-spaced bright pixels) in movies recorded at high ISO sensitivities (📖 210).

## Vignette Control

MENU button →  (movie shooting menu)

Reduce vignetting in movies ( 211). Select **Same as photo settings** to use the option currently selected for photos.

## Diffraction Compensation

MENU button →  (movie shooting menu)

Reduce diffraction in movies ( 211).

## Auto Distortion Control

MENU button →  (movie shooting menu)

Reduce barrel and pin-cushion distortion in movies ( 211).

## Flicker Reduction

MENU button →  (movie shooting menu)

Reduce flicker and banding when shooting movies under fluorescent or mercury-vapor lighting. Choose **Auto** to allow the camera to automatically choose the correct frequency, or manually match the frequency to that of the local AC power supply.

### “Flicker Reduction” in the Movie Shooting Menu

If **Auto** fails to produce the desired results and you are unsure as to the frequency of the local power supply, test both the 50 and 60 Hz options and choose the one that produces the best results. Flicker reduction may not produce the desired results if the subject is very bright, in which case you should try choosing a smaller aperture (higher f-number). To prevent flicker, select mode **M** and choose a shutter speed adapted to the frequency of the local power supply:  $\frac{1}{125}$  s,  $\frac{1}{60}$  s, or  $\frac{1}{30}$  s for 60 Hz;  $\frac{1}{100}$  s,  $\frac{1}{50}$  s, or  $\frac{1}{25}$  s for 50 Hz.

## Metering



MENU button →  (movie shooting menu)

Choose how the camera meters exposure in movie mode (📖 131). Spot metering is not available.

## Release Mode (Save Frame)

MENU button →  (movie shooting menu)

You can choose the release mode for photographs taken in movie mode (📖 44).

Option	Description
 <b>Single frame</b>	The camera takes one photograph each time the shutter-release button is pressed. Regardless of the option selected, a maximum of 40 photos can be taken with each movie.
 <b>Continuous</b>	The camera takes photographs while the shutter-release button is held down; the length of time available for the burst is shown in the shooting display. The frame rate varies with the option selected for <b>Frame size/frame rate</b> in the movie shooting menu. Only one photograph can be taken at a time while movie recording is in progress.

## Focus Mode

MENU button →  (movie shooting menu)

Choose a focus mode for movie recording (📖 51).

## AF-Area Mode

MENU button →  (movie shooting menu)

Choose how the camera focuses in movie mode (📖 54).



## Optical VR

MENU button →  (movie shooting menu)

Choose an optical vibration reduction option for movie recording (📖 139). Select **Same as photo settings** to use the option currently selected for photos.

## Electronic VR

MENU button →  (movie shooting menu)

Choose whether to enable electronic vibration reduction in movie mode.

## Microphone Sensitivity

MENU button →  (movie shooting menu)

Turn built-in or external microphones on or off or adjust microphone sensitivity. Choose **Auto** to adjust sensitivity automatically or **Microphone off** to turn sound recording off; to select microphone sensitivity manually, select **Manual** and choose a sensitivity.

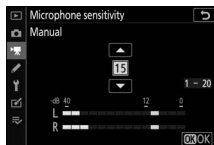

### ✓ The icon

Movies recorded with **Microphone off** selected for **Microphone sensitivity** are indicated by a  icon.





## Attenuator

MENU button →  (movie shooting menu)

Select **Enable** to reduce microphone gain and prevent audio distortion when recording movies in loud environments.

## Frequency Response

MENU button →  (movie shooting menu)

If  **Wide range** is selected, built-in and external microphones will respond to a wide range of frequencies, from music to the bustling hum of a city street. Choose  **Vocal range** to bring out human voices.

## Wind Noise Reduction

MENU button →  (movie shooting menu)

Choose whether to enable wind-noise reduction during movie recording. For more information, see “Wind Noise Reduction” ( 146).

## Custom Settings: Fine-Tuning Camera Settings

To view Custom Settings, select the  tab in the camera menus.

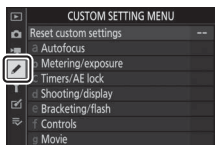

Custom Settings are used to customize camera settings to suit individual preferences.

Main menu

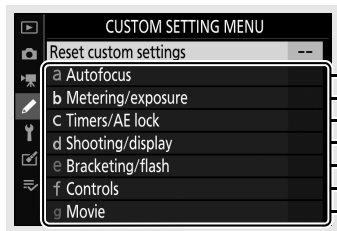



Custom Setting groups



The following Custom Settings are available:

Custom Setting <sup>1</sup>		
<b>Reset custom settings</b>		268
<b>a Autofocus</b>		
a1	AF-C priority selection	269
a2	Auto-area AF face/eye detection	269
a3	Focus points used	270
a4	AF activation	270
a5	Focus point wrap-around	271
a6	Focus point options	271
a7	Low-light AF	271
a8	Built-in AF-assist illuminator	272
a9	Manual focus ring in AF mode <sup>2</sup>	273
<b>b Metering/exposure</b>		
b1	EV steps for exposure cntrl	274
b2	Easy exposure compensation	274
b3	Center-weighted area	275
b4	Fine-tune optimal exposure	275
<b>c Timers/AE lock</b>		
c1	Shutter-release button AE-L	276
c2	Self-timer	276
c3	Power off delay	277



<b>d Shooting/display</b>		
d1	CL mode shooting speed	278
d2	Max. continuous release	278
d3	Exposure delay mode	278
d4	Shutter type	279
d5	Limit selectable image area	279
d6	File number sequence	280
d7	Apply settings to live view	281
d8	Framing grid display	281
d9	Peaking highlights	281
d10	View all in continuous mode	281
<b>e Bracketing/flash</b>		
e1	Flash sync speed	282
e2	Flash shutter speed	283
e3	Exposure comp. for flash	283
e4	Auto  ISO sensitivity control	283
e5	Bracketing order	284
<b>f Controls</b>		
f1	Customize  menu	285
f2	Custom controls (shooting)	286
f3	Custom controls (playback)	292
f4	Customize command dials	294
f5	Release button to use dial	296
f6	Reverse indicators	296

## Custom Setting<sup>1</sup>



### g Movie

g1	Customize  menu	297
g2	Custom controls	298
g3	AF speed	303
g4	AF tracking sensitivity	303
g5	Highlight display	304

1 Items modified from default values are indicated by asterisks (“\*”).

2 Available with compatible lenses only.

### See Also

For menu defaults, see “Custom Settings Menu Defaults” (📖 176).

## Reset Custom Settings

MENU button → (Custom Settings menu)



Select **Yes** to restore Custom Settings to their default values (📖 176).

## a: Autofocus

### a1: AF-C Priority Selection

MENU button →  (Custom Settings menu)

Choose whether photos can be taken before the camera focuses in focus mode **AF-C**.

Option	Description
 <b>Release</b>	Photos can be taken whenever the shutter-release button is pressed ( <i>release priority</i> ).
 <b>Focus</b>	Photos can be taken only when the camera is in focus ( <i>focus priority</i> ).

Regardless of the option selected, focus will not lock when **AF-C** is selected for focus mode. The camera will continue to adjust focus until the shutter is released.

### a2: Auto-Area AF Face/Eye Detection

MENU button →  (Custom Settings menu)

Choose whether the camera detects and focuses on faces or eyes, either of human portrait subjects or of dogs and cats, when auto-area AF is selected for AF-area mode.

Option	Description
<b>Face and eye detection on</b>	When the camera detects a portrait subject, it automatically focuses on one or the other of the subject's eyes, or on the subject's face if the eyes are not detected.
<b>Face detection on</b>	When the camera detects a portrait subject, it automatically focuses on the subject's face.
<b>Animal detection on</b>	When the camera detects a face of a dog or cat, it automatically focuses on one or the other of the subject's eyes. If the eyes are not detected, the camera will instead focus on the subject's face.
<b>Off</b>	Face and eye detection disabled.

### a3: Focus Points Used

MENU button →  (Custom Settings menu)

Choose the number of focus points available for manual focus-point selection.

Option	Description
ALL All points	Every focus point available in the current AF-area mode can be selected.
1/2 Every other point	The number of available focus points is reduced by three quarters (the number of focus points available in <b>Wide-area AF (L)</b> mode does not change). Use for quick focus-point selection.

### a4: AF Activation

MENU button →  (Custom Settings menu)

Choose whether the shutter-release button can be used to focus (**Shutter/AF-ON**) or if focus can only be adjusted using the controls to which AF-ON has been assigned (**AF-ON only**).

### a5: Focus Point Wrap-Around

MENU button →  (Custom Settings menu)

Choose whether focus-point selection “wraps around” from one edge of the display to another. If **Wrap** is selected, focus-point selection will “wrap around” from top to bottom, bottom to top, right to left, and left to right, so that, for example, pressing the  when a focus point at the right edge of the display is highlighted selects the corresponding focus point at the left edge of the display.



## a6: Focus Point Options

MENU button →  (Custom Settings menu)

Choose from the following focus point display options:

- **Manual focus mode:** Choose **On** to display the active focus point in manual focus mode, **Off** to display the focus point only during focus point selection.
- **Dynamic-area AF assist:** If **On** is selected, both the selected focus point and the surrounding focus points will be displayed in dynamic-area AF mode. Choose **Off** to display only the selected focus point.

## a7: Low-Light AF

MENU button →  (Custom Settings menu)

Choose **On** for more accurate focus under low light (applies only when **AF-S** is selected for focus mode or when **AF-A** is selected and the camera is shooting using **AF-S**).

- This option only takes effect in photo mode.
- In , **SCN**, and **EFCT** modes, **Low-light AF** is fixed at **On**.
- The camera may require more time to focus when **On** is selected.
- While low-light AF is in effect, “Low-light” will appear in the display and the display refresh rate may drop.



## a8: Built-in AF-Assist Illuminator

MENU button →  (Custom Settings menu)

Choose whether the built-in AF-assist illuminator lights to assist the focus operation in photo mode when lighting is poor.

Option	Description
On	The illuminator lights as required when <b>AF-S</b> is selected for focus mode or <b>AF-A</b> is selected and the camera is shooting using <b>AF-S</b> .
Off	The illuminator does not light to assist the focus operation. The camera may not be able to focus when lighting is poor.

### The AF-Assist Illuminator

The AF-assist illuminator has a range of about 1–3 m (3 ft 4 in.–9 ft 10 in.); when using the illuminator, remove the lens hood. Do not obstruct the AF-assist illuminator while it is lit.

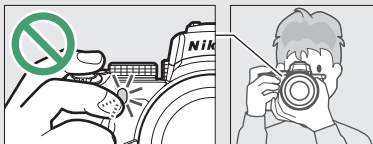

## a9: Manual Focus Ring in AF Mode

MENU button →  (Custom Settings menu)

Choose whether the lens focus ring can be used for manual focus in autofocus mode. Choose from the options below.

- **Enable:** Autofocus can be over-ridden by rotating the lens focus ring while the shutter-release button is pressed halfway (autofocus with manual override). To refocus using autofocus, lift your finger from the shutter-release button and then press it halfway again.
- **Disable:** The lens focus ring cannot be used for manual focus while autofocus mode is selected.

## b: Metering/Exposure

### b1: EV Steps for Exposure Cntrl



MENU button →  (Custom Settings menu)

Select the increments used for adjustments to shutter speed, aperture, ISO sensitivity, bracketing, and exposure and flash compensation.

### b2: Easy Exposure Compensation

MENU button →  (Custom Settings menu)

Choose whether the  button is needed for exposure compensation.

- **On (auto reset):** In modes **P**, **S**, and **A**, exposure compensation can be set by rotating the command dial not currently used for shutter speed or aperture (easy exposure compensation is not available in other modes). The setting selected using the command dial is reset when the camera turns off or the standby timer expires (exposure compensation settings selected using the  button are not reset).
- **On:** As above, except that the exposure compensation value selected using the command dial is not reset when the camera turns off or the standby timer expires.
- **Off:** Exposure compensation is set by pressing the  button and rotating the main command dial.

### b3: Center-Weighted Area

MENU button →  (Custom Settings menu)

Choose the size of the area given the most weight in center-weighted metering.

### b4: Fine-Tune Optimal Exposure

MENU button →  (Custom Settings menu)

Use this option to fine-tune the exposure value selected by the camera. Exposure can be fine-tuned separately for each metering method by from +1 to -1 EV in steps of  $\frac{1}{6}$  EV.

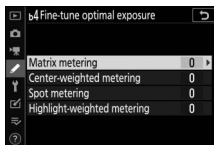

#### Fine-Tuning Exposure



The exposure compensation () icon is not displayed when exposure fine-tuning is in effect. The only way to determine how much exposure has been altered is to view the amount in the fine-tuning menu.

## c: Timers/AE Lock

### c1: Shutter-Release Button AE-L

MENU button →  (Custom Settings menu)



Choose whether exposure locks when the shutter-release button is pressed.

Option	Description
 ON On (half press)	Pressing the shutter-release button halfway locks exposure.
 ON On (burst mode)	Exposure only locks while the shutter-release button is pressed all the way down.
Off	Pressing the shutter-release button does not lock exposure.

### c2: Self-Timer

MENU button →  (Custom Settings menu)

Choose the length of the shutter release delay, the number of shots taken, and the interval between shots in self-timer mode.

- **Self-timer delay:** Choose the length of the shutter-release delay.
- **Number of shots:** Press  and  to choose the number of shots taken each time the shutter-release button is pressed.
- **Interval between shots:** Choose the interval between shots when **Number of shots** is more than 1.

### c3: Power Off Delay

MENU button →  (Custom Settings menu)

Choose how long the camera displays remain on when no operations are performed. Different settings can be chosen for **Playback**, **Menus**, **Image review**, and **Standby timer**; note that each of these delays is extended by one minute in self-timer mode. **Standby timer** determines how long the monitor or viewfinder display remains on when no operations are performed during shooting (the monitor and viewfinder dim a few seconds before the standby timer expires). Choose shorter power-off delays for longer battery life.

## d: Shooting/Display

### d1: CL Mode Shooting Speed

MENU button →  (Custom Settings menu)

Choose the frame advance rate for low-speed continuous release mode.

### d2: Max. Continuous Release

MENU button →  (Custom Settings menu)

The maximum number of shots that can be taken in a single burst in continuous release modes can be set to any value between 1 and 100. Note that regardless of the option selected, there is no limit to the number of photos that can be taken in a single burst when a shutter speed of 1 s or slower is selected in mode **S** or **M**.

#### The Memory Buffer

Regardless of the option selected for Custom Setting d2, shooting will slow when the memory buffer fills (**r00**).

### d3: Exposure Delay Mode

MENU button →  (Custom Settings menu)



In situations where the slightest camera movement can blur pictures, shutter release can be delayed by from about 0.2 to 3 seconds after the shutter-release button is pressed.



## d4: Shutter Type

MENU button →  (Custom Settings menu)

Choose the type of shutter used for photographs.

Option	Description
 <b>Auto</b>	The camera chooses the shutter type automatically according to shutter speed. The electronic front-curtain shutter is used to reduce blur caused by camera shake at slow shutter speeds.
 <b>Mechanical shutter</b>	The camera uses the mechanical shutter for all photos.
 <b>Electronic front-curtain shutter</b>	The camera uses the electronic front-curtain shutter for all photos.

### “Mechanical Shutter”



**Mechanical shutter** is not available with some lenses.

### “Electronic Front-Curtain Shutter”

The fastest shutter speed available when **Electronic front-curtain shutter** is selected is  $\frac{1}{2000}$  s.

## d5: Limit Selectable Image Area

MENU button →  (Custom Settings menu)

Choose the options available when image-area selection is assigned to the  menu or to the command dials and a camera control. Highlight the desired options and press  to select or deselect. Press  to save changes when settings are complete.



## d6: File Number Sequence

MENU button →  (Custom Settings menu)

When a picture is taken, the camera names the file by adding one to the last file number used. This option controls whether file numbering continues from the last number used when a new folder is created, the memory card is formatted, or a new memory card is inserted in the camera.

Option	Description
<b>On</b>	File numbering continues from the last number used. This simplifies file management by minimizing the occurrence of duplicate file names.
<b>Off</b>	File numbering restarts from 0001 or from the largest file number in the current folder (if you turn sequential file numbering off and then on again, file numbering will resume from the last number used).
<b>Reset</b>	As for <b>On</b> , except that the next picture taken after <b>Reset</b> is selected is assigned a file number by adding one to the largest file number in the current folder. If the folder is empty, file numbering is reset to 0001.

### File Number Sequence

If a picture is taken when the current folder contains 5000 pictures or a picture numbered 9999, a new folder will be created and file numbering will restart from 0001. The new folder is assigned a number one higher than current folder number or, if a folder with that number already exists, the lowest available folder number. If the current folder is numbered 999, the camera will not be able to create a new folder and the shutter release will be disabled (in addition, movie recording may be disabled if the camera calculates that the number of files needed to record a movie of the maximum length would result in the folder containing over 5000 files or a file with a number over 9999). To resume shooting, choose **Reset** for Custom Setting d6 (**File number sequence**) and then either format the current memory card or insert a new memory card.

## d7: Apply Settings to Live View

MENU button →  (Custom Settings menu)

Choose **On** to preview how changes to such settings as white balance, Picture Controls, and exposure compensation affect color and brightness in photo mode, or select **Off** to adjust brightness and hue for ease of viewing (regardless of the option selected, the effects of the aforementioned settings are always visible in movie mode). A  icon is displayed when **Off** is selected.

## d8: Framing Grid Display

MENU button →  (Custom Settings menu)

Choose **On** to display a grid for reference when framing shots.

## d9: Peaking Highlights

MENU button →  (Custom Settings menu)

When focus peaking is enabled in manual focus mode, objects that are in focus are indicated by colored outlines in the display. Choose the peaking level and outline color.

- **Peaking level:** Choose from **3 (high sensitivity)**, **2 (standard)**, **1 (low sensitivity)**, and **Off**; the higher the value, the greater the depth that will be shown as being in focus.
- **Peaking highlight color:** Choose the highlight color.

## d10: View All in Continuous Mode

MENU button →  (Custom Settings menu)

If **Off** is selected, the display will go blank during burst photography.

## e: Bracketing/Flash

### e1: Flash Sync Speed

MENU button →  (Custom Settings menu)

Choose the flash sync speed.

- **1/200 s (Auto FP)**: Selecting this option (available only when an optional flash unit is attached) enables auto FP high-speed sync with compatible flash units; the maximum sync speed for other flash units is set to  $\frac{1}{200}$  s. When the camera shows a shutter speed of  $\frac{1}{200}$  s in mode **P** or **A**, auto FP high-speed sync will be activated if the actual shutter speed is faster than  $\frac{1}{200}$  s, and shutter speeds as fast as  $\frac{1}{4000}$  s can be selected by the camera (modes **P** and **A**) or by the user (modes **S** and **M**).
- **1/200 s–1/60 s**: Set the maximum flash sync speed to the selected value.

#### Auto FP High-Speed Sync

Auto FP high-speed sync allows optional flash units to be used at the highest shutter speed supported by the camera, making it possible to choose the maximum aperture for reduced depth of field even in bright sunlight.

## e2: Flash Shutter Speed



MENU button →  (Custom Settings menu)

Choose the slowest shutter speed available when front- or rear-curtain sync or red-eye reduction is used in mode **P** or **A** (regardless of the setting chosen, shutter speeds can be as slow as 30 s in modes **S** and **M** or at flash settings of slow sync, slow rear-curtain sync, or red-eye reduction with slow sync).

## e3: Exposure Comp. for Flash

MENU button →  (Custom Settings menu)



Choose how the camera adjusts flash level when exposure compensation is used.

Option	Description
 <b>Entire frame</b>	Both flash level and exposure compensation are adjusted to modify exposure over the entire frame.
 <b>Background only</b>	Exposure compensation applies to background only.

## e4: Auto ISO Sensitivity Control



MENU button →  (Custom Settings menu)

Choose how the camera adjusts flash level when auto ISO sensitivity control is enabled.

Option	Description
 <b>Subject and background</b>	The camera takes both the main subject and background lighting into account when adjusting ISO sensitivity.
 <b>Subject only</b>	ISO sensitivity is adjusted only to ensure that the main subject is correctly exposed.

## e5: Bracketing Order



MENU button →  (Custom Settings menu)























At the default setting of **MTR > under > over** ()<sup>(N)</sup>, exposure, flash, and white balance bracketing are performed in the following order: the unmodified shot is taken first, followed by the shot with the lowest value, followed by the shot with the highest value. If **Under > MTR > over** ()<sup>(-→+)</sup> is selected, shooting will proceed in order from the lowest to the highest value. This setting has no effect on ADL bracketing.

## f: Controls

### f1: Customize Menu

MENU button →  (Custom Settings menu)

Choose the options displayed in the  menu for photo mode. The following options can be assigned to any position in the menu by highlighting the desired position, pressing , and choosing the desired option.









Option		Option	
 Choose image area	193	<b>BKT</b> Auto bracketing	217
<b>QUAL</b> Image quality	126	 Multiple exposure	227
<b>SIZE</b> Image size	128	<b>HDR</b> HDR (high dynamic range)	234
 Exposure compensation	102	 Silent photography	71
<b>ISO</b> ISO sensitivity settings	100, 196	 Release mode	135
<b>WB</b> White balance	67, 120	 Custom controls (shooting)	286
 Set Picture Control	116	<b>DLY</b> Exposure delay mode	278
<b>RGB</b> Color space	209	 Shutter type	279
 Active D-Lighting	133	 Apply settings to live view	281
 Long exposure NR	210	<b>PEAK</b> Peaking highlights	281
<b>ISO NR</b> High ISO NR	210	 Monitor/viewfinder brightness	307, 308
 Metering	131	 Bluetooth connection	318
 Flash mode	108	 Wi-Fi connection	132
 Flash compensation	216	 Wireless remote connection	323
<b>AF/MF</b> Focus mode	51, 140		
 AF-area mode	54, 140		
 Optical VR	139		

## f2: Custom Controls (Shooting)























MENU button →  (Custom Settings menu)

To choose the functions assigned to the following controls in photo mode, whether used individually or in combination with the command dials, highlight the desired option and press .



	<b>Fn1 button</b>		<b>Fn2 button</b>
	<b>AE-L/AF-L button</b>		<b>OK button</b>
	<b>Movie record button</b>		<b>Lens Fn button</b>
	<b>Lens Fn2 button</b>		<b>Lens control ring</b>

The roles that can be assigned to these controls are as follows:

Option								
 <b>RESET</b> Select center focus point	—	—	—	✓	—	—	—	—
 <b>AF-ON</b>	✓	✓	✓	—	—	✓	✓	—
 <b>AF lock only</b>	✓	✓	✓	—	—	✓	✓	—
 <b>AE lock (Hold)</b>	✓	✓	✓	—	✓	✓	✓	—
 <b>AE lock (Reset on release)</b>	✓	✓	✓	—	✓	✓	✓	—
 <b>AE lock only</b>	✓	✓	✓	—	—	✓	✓	—
 <b>AE/AF lock</b>	✓	✓	✓	—	—	✓	✓	—
 <b>FV lock</b>	✓	✓	✓	—	—	✓	✓	—
 <b>Flash off</b>	✓	✓	—	—	—	✓	✓	—
 <b>Preview</b>	✓	✓	—	—	✓	✓	✓	—
 <b>Bracketing burst</b>	✓	✓	—	—	—	✓	✓	—
 <b>+RAW</b> + NEF (RAW)	✓	✓	—	—	✓	✓	✓	—
 <b>Subject tracking</b>	✓	✓	—	—	—	✓	✓	—
 <b>Framing grid display</b>	✓	✓	—	—	✓	✓	✓	—











Option								
Zoom on/off	✓	✓	✓	✓	✓	✓	✓	—
MY MENU	✓	✓	—	—	✓	✓	✓	—
Access top item in MY MENU	✓	✓	—	—	✓	✓	✓	—
Playback	✓	✓	—	—	—	✓	✓	—
Choose image area	✓	✓	—	—	✓	—	—	—
<b>QUAL</b> Image quality/size	✓	✓	—	—	✓	—	—	—
<b>WB</b> White balance	✓	✓	—	—	✓	—	—	—
Set Picture Control	✓	✓	—	—	✓	—	—	—
Active D-Lighting	✓	✓	—	—	✓	—	—	—
Metering	✓	✓	—	—	✓	—	—	—
Flash mode/compensation	✓	✓	—	—	✓	—	—	—
Release mode	✓	✓	—	—	✓	—	—	—
<b>AF/[+]</b> Focus mode/AF-area mode	✓	✓	—	—	✓	—	—	—
<b>BKT</b> Auto bracketing	✓	✓	—	—	✓	—	—	—
Multiple exposure	✓	✓	—	—	✓	—	—	—
<b>HDR</b> HDR (high dynamic range)	✓	✓	—	—	✓	—	—	—
<b>DLY</b> Exposure delay mode	✓	✓	—	—	✓	—	—	—
<b>PEAK</b> Peaking highlights	✓	✓	—	—	—	—	—	—
<b>M/A</b> Focus (M/A)	—	—	—	—	—	—	—	✓ <sup>1, 2</sup>
Aperture	—	—	—	—	—	—	—	✓ <sup>2</sup>
Exposure compensation	—	—	—	—	—	—	—	✓ <sup>2</sup>
<b>ISO</b> ISO sensitivity	—	—	—	—	—	—	—	✓ <sup>2</sup>
<b>None</b>	✓	✓	✓	✓	✓	✓	✓	✓ <sup>2</sup>









1 Available only with compatible lenses.



2 Regardless of the option selected, in manual focus mode the control ring can only be used to adjust focus.

The following options are available:

Option	Description
<b>RESET</b> Select center focus point	Pressing the control selects the center focus point.
<b>AF-ON</b> AF-ON	Pressing the control initiates autofocus.
<b>AF</b> AF lock only	Focus locks while the control is pressed.
<b>AE</b> AE lock (Hold)	Exposure locks when the control is pressed, and remains locked until the control is pressed a second time or the standby timer expires.
<b>AE</b> AE lock (Reset on release)	Exposure locks when the control is pressed, and remains locked until the control is pressed a second time, the shutter is released, or the standby timer expires.
<b>AE</b> AE lock only	Exposure locks while the control is pressed.
<b>AE</b> AE/AF lock	Focus and exposure lock while the control is pressed.
<b>FV</b> FV lock	Press the control to lock flash value for the built-in flash or optional flash units. Press again to cancel FV lock.
<b>Flash off</b>	If the flash is currently enabled, it will be disabled while the control is pressed.
<b>Preview</b>	Keep the control pressed to preview color, exposure, and depth of field.
<b>BKT</b> Bracketing burst	If the control is pressed while exposure or ADL bracketing is active in single frame release mode, all shots in the current bracketing program will be taken each time the shutter-release button is pressed. If white balance bracketing is active or a continuous release mode is selected, the camera will repeat the bracketing burst while the shutter-release button is held down.



Option	Description
 + NEF (RAW)	If a JPEG option is currently selected for image quality, "RAW" will be displayed and an NEF (RAW) copy will be recorded with the next picture taken after the control is pressed (the original image quality setting will be restored when you remove your finger from the shutter-release button). NEF (RAW) copies are recorded at the setting currently selected for <b>NEF (RAW) recording</b> in the photo shooting menu. To exit without recording an NEF (RAW) copy, press the control again.
 <b>Subject tracking</b>	Pressing the control during auto-area AF enables subject tracking; the focus point will change to a targeting reticle and the monitor and viewfinder to subject-tracking displays. <ul style="list-style-type: none"> <li>• To end subject-tracking AF, press the control again.</li> </ul>
 <b>Framing grid display</b>	Press the control to turn the framing grid display on or off.
 <b>Zoom on/off</b>	Press the control to zoom the display in on the area around the current focus point. Press the control again to zoom out.
 <b>MY MENU</b>	Pressing the control displays "MY MENU".
 <b>Access top item in MY MENU</b>	Press the control to jump to the top item in "MY MENU." Select this option for quick access to a frequently-used menu item.
 <b>Playback</b>	Press the control to start playback.
 <b>Choose image area</b>	Press the control and rotate a command dial to choose the image area.
<b>QUAL</b> <b>Image quality/size</b>	Press the control and rotate the main command dial to choose an image quality option and the sub-command dial to select image size.
<b>WB</b> <b>White balance</b>	Press the control and rotate the main command dial to choose a white balance option (in some cases, a sub-option can be selected using the sub-command dial).

Option	Description
 <b>Set Picture Control</b>	Press the control and rotate a command dial to choose a Picture Control.
 <b>Active D-Lighting</b>	Press the control and rotate a command dial to adjust Active D-Lighting.
 <b>Metering</b>	Press the control and rotate a command dial to choose a metering option.
 <b>Flash mode/compensation</b>	Press the control and rotate the main command dial to choose a flash mode and the sub-command dial to adjust flash output.
 <b>Release mode</b>	Press the control and rotate the main command dial to choose a release mode. In <b>Continuous L</b> or <b>Self-timer</b> mode, you can rotate the sub-command dial to choose the frame advance rate or release delay.
 <b>Focus mode/AF-area mode</b>	Press the control and rotate the main and sub-command dials to choose the focus and AF-area modes.
 <b>Auto bracketing</b>	Press the control and rotate the main command dial to choose the number of shots and the sub-command dial to select the bracketing increment or Active D-Lighting amount.
 <b>Multiple exposure</b>	Press the control and rotate the main command dial to choose the mode and the sub-command dial to choose the number of shots.
<b>HDR</b> <b>HDR (high dynamic range)</b>	Press the control and rotate the main command dial to choose the mode and the sub-command dial to choose the exposure differential.
 <b>Exposure delay mode</b>	Press the control and rotate a command dial to choose the shutter-release delay.

Option	Description
 <b>Peaking highlights</b>	Press the control and rotate the main command dial to choose a peaking level and the sub-command dial to select the peaking color.
<b>M/A Focus (M/A)</b>	Autofocus can be over-ridden by rotating the control ring while the shutter-release button is pressed halfway (autofocus with manual override). To refocus using autofocus, lift your finger from the shutter-release button and then press it halfway again.
 <b>Aperture</b>	Use the control to adjust aperture.
 <b>Exposure compensation</b>	Use the control to adjust exposure compensation.
<b>ISO ISO sensitivity</b>	Rotate the lens control ring to adjust ISO sensitivity.
<b>None</b>	The control has no effect.

## f3: Custom Controls (Playback)





MENU button →  (Custom Settings menu)

Choose the roles assigned to the <sup>AE-L</sup>/<sub>AF-L</sub> () and  buttons during playback. Highlight the desired control and press .











### AE-L/AF-L Button

The following roles can be assigned to the <sup>AE-L</sup>/<sub>AF-L</sub> () button:

Option	Description
  Same as <sup>AE-L</sup> / <sub>AF-L</sub> when shooting	The control performs the function selected for Custom Setting f2 ( <b>Custom controls (shooting)</b> ) > <sup>AE-L</sup> / <sub>AF-L</sub> <b>AE-L/AF-L button</b> .
 Protect	Press the control during playback to protect the current picture.
 Rating	Press the control and then use the multi selector to rate the current picture during playback.

## OK Button



Choose from the options below. Regardless of the option selected, pressing  when a movie is displayed full frame starts movie playback.

Option	Description
 <b>Thumbnail on/off</b>	Toggle between full-frame and thumbnail playback.
 <b>View histograms</b>	In both full-frame and thumbnail playback, a histogram is displayed while the  button is pressed.
 <b>Zoom on/off</b>	Toggle between full-frame or thumbnail playback and playback zoom (to choose the zoom ratio, highlight <b>Zoom on/off</b> and press  ). The zoom display is centered on the active focus point.
 <b>Choose folder</b>	A folder-selection dialog will be displayed; highlight a folder and press  to view the pictures in the selected folder.

## f4: Customize Command Dials

MENU button →  (Custom Settings menu)

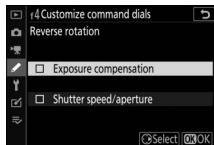

Customize the operation of the main and sub-command dials.

- **Reverse rotation:** Reverse the direction of rotation of the command dials for selected operations. Highlight options and press  to select or deselect, and then press  to save changes and exit.



- **Change main/sub:** Choose the roles played by the command dials for exposure and focus operations.
  - **Exposure setting:** If **On** is selected, the main command dial will control aperture and the sub-command dial shutter speed. If **On (Mode A)** is selected, the main command dial will be used to set aperture in mode **A** only.
  - **Autofocus setting:** This option applies to the control assigned **Focus mode/AF-area mode** using Custom Setting f2 (**Custom controls (shooting)**). If **On** is selected, the focus mode can be chosen by keeping the control pressed and rotating the sub-command dial, AF-area mode by keeping the control pressed and rotating the main command dial.



- **Menus and playback:** Select **Off** to use the multi selector for menus and playback. If **On** or **On (image review excluded)** is selected, the main command dial can be used to choose the picture displayed during full-frame playback and to highlight thumbnails and menu items. The sub-command dial is used in full-frame playback to skip forward or back according to the option selected for **Sub-dial frame advance** and in thumbnail playback to page up or down. While menus are displayed, rotating the sub-command dial right displays the sub-menu for the highlighted option, while rotating it left displays the previous menu. To make a selection, press  or . Select **On (image review excluded)** to prevent the command dials from being used for playback during image review.
- **Sub-dial frame advance:** When **On** or **On (image review excluded)** is selected for **Menus and playback**, the sub-command dial can be rotated during full-frame playback to select a folder, to skip forward or back 10 or 50 frames at a time, or to skip to the next or previous protected picture, the next or previous photo, the next or previous movie, or the next or previous picture with a selected rating (to choose the rating, highlight **Rating** and press ).

## f5: Release Button to Use Dial



MENU button →  (Custom Settings menu)

Selecting **Yes** allows adjustments that are normally made by holding a button and rotating a command dial to be made by rotating the command dial after the button is released. This ends when the button is pressed again, the shutter-release button is pressed halfway, or the standby timer expires.

- **Release button to use dial** applies to the  and **ISO** buttons.
- **Release button to use dial** also applies to controls to which the following roles have been assigned using Custom Settings f2 (**Custom controls (shooting)**) or g2 (**Custom controls**):  
**Choose image area, Image quality/size, White balance, Set Picture Control, Active D-Lighting, Metering, Flash mode/compensation, Release mode, Focus mode/AF-area mode, Auto bracketing, Multiple exposure, HDR (high dynamic range), Exposure delay mode, Peaking highlights, and Microphone sensitivity.**



## f6: Reverse Indicators





















MENU button →  (Custom Settings menu)

If  (-0+) is selected, the exposure indicator is displayed with negative values on the left and positive values on the right. Select  (+0-) to display positive values on the left and negative values on the right.

## g1: Customize Menu

MENU button →  (Custom Settings menu)

Choose the options displayed in the  menu for movie mode. The following options can be assigned to any position in the menu by highlighting the desired position, pressing , and choosing the desired option.





Option		Option	
 <b>Frame size and rate/ Image quality</b>	143	 <b>Microphone sensitivity</b>	145
 <b>Exposure compensation</b>	102	 <b>Attenuator</b>	264
<b>ISO</b> <b>ISO sensitivity settings</b>	259	 <b>Frequency response</b>	264
<b>WB</b> <b>White balance</b>	67, 120	 <b>Wind noise reduction</b>	264
 <b>Set Picture Control</b>	116	 <b>Release mode (save frame)</b>	262
 <b>Active D-Lighting</b>	133, 147	 <b>Peaking highlights</b>	281
 <b>Metering</b>	131, 147	 <b>Highlight display</b>	304
<b>AF/MF</b> <b>Focus mode</b>	51, 148	 <b>Monitor/viewfinder brightness</b>	307, 308
 <b>AF-area mode</b>	54, 148	 <b>Bluetooth connection</b>	318
 <b>Optical VR</b>	139	 <b>Wi-Fi connection</b>	132
 <b>Electronic VR</b>	147	 <b>Wireless remote connection</b>	323

## g2: Custom Controls

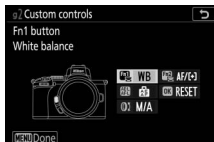

















MENU button →  (Custom Settings menu)

















To choose the functions assigned to the following controls in movie mode, whether used individually or in combination with the command dials, highlight the desired option and press .



	<b>Fn1 button</b>		<b>Fn2 button</b>
	<b>AE-L/AF-L button</b>		<b>OK button</b>
	<b>Lens control ring</b>		

The roles that can be assigned to these controls are as follows:









Option					
 <b>Power aperture (open)</b>	✓	—	—	—	—
 <b>Power aperture (close)</b>	—	✓	—	—	—
 <b>Exposure compensation +</b>	✓	—	—	—	—
 <b>Exposure compensation -</b>	—	✓	—	—	—
 <b>Subject tracking</b>	✓	✓	—	—	—
 <b>Framing grid display</b>	✓	✓	—	—	—
<b>RESET</b> Select center focus point	—	—	—	✓	—
 <b>AF-ON</b>	—	—	✓	—	—
 <b>AF lock only</b>	—	—	✓	—	—
 <b>AE lock (Hold)</b>	—	—	✓	—	—
 <b>AE lock only</b>	—	—	✓	—	—
 <b>AE/AF lock</b>	—	—	✓	—	—
 <b>Zoom on/off</b>	—	—	✓	✓	—
 <b>Record movies</b>	—	—	✓	✓	—
<b>WB</b> White balance	✓	✓	—	—	—











Option					
 Set Picture Control	✓	✓	—	—	—
 Active D-Lighting	✓	✓	—	—	—
 Metering	✓	✓	—	—	—
 Release mode (save frame)	✓	✓	—	—	—
 Focus mode/AF-area mode	✓	✓	—	—	—
 Microphone sensitivity	✓	✓	—	—	—
 Peaking highlights	✓	✓	—	—	—
 Focus (M/A)	—	—	—	—	✓ <sup>1, 2</sup>
 Power aperture	—	—	—	—	✓ <sup>2</sup>
 Exposure compensation	—	—	—	—	✓ <sup>2</sup>
 ISO sensitivity	—	—	—	—	✓ <sup>2</sup>
None	✓	✓	✓	✓	✓ <sup>2</sup>



1 Available only with compatible lenses.

2 Regardless of the option selected, in manual focus mode the control ring can only be used to adjust focus.

The following options are available:

Option	Description
 <b>Power aperture (open)</b>	Aperture widens while the control is pressed. Use in combination with Custom Setting g2 ( <b>Custom controls</b> ) > <b>Fn2 button</b> > <b>Power aperture (close)</b> for button-controlled aperture adjustment.
 <b>Power aperture (close)</b>	Aperture narrows while the control is pressed. Use in combination with Custom Setting g2 ( <b>Custom controls</b> ) > <b>Fn1 button</b> > <b>Power aperture (open)</b> for button-controlled aperture adjustment.
 <b>Exposure compensation +</b>	Exposure compensation increases while the control is pressed. Use in combination with Custom Setting g2 ( <b>Custom controls</b> ) > <b>Fn2 button</b> > <b>Exposure compensation –</b> for button-controlled exposure compensation.
 <b>Exposure compensation –</b>	Exposure compensation decreases while the control is pressed. Use in combination with Custom Setting g2 ( <b>Custom controls</b> ) > <b>Fn1 button</b> > <b>Exposure compensation +</b> for button-controlled exposure compensation.
 <b>Subject tracking</b>	Pressing the control during auto-area AF enables subject tracking; the focus point will change to a targeting reticle and the monitor and viewfinder to subject-tracking displays. <ul style="list-style-type: none"> <li>• To end subject-tracking AF, press the control again.</li> </ul>
 <b>Framing grid display</b>	Press the control to turn the framing grid display on or off.
<b>RESET</b> <b>Select center focus point</b>	Pressing the control selects the center focus point.
 <b>AF-ON</b>	Pressing the control initiates autofocus.
 <b>AF lock only</b>	Focus locks while the control is pressed.
 <b>AE lock (Hold)</b>	Exposure locks when the control is pressed, and remains locked until the control is pressed a second time or the standby timer expires.

Option	Description
 <b>AE lock only</b>	Exposure locks while the control is pressed.
 <b>AE/AF lock</b>	Focus and exposure lock while the control is pressed.
 <b>Zoom on/off</b>	Press the control to zoom the display in on the area around the current focus point. Press the control again to zoom out.
 <b>Record movies</b>	Press the control to start movie recording. Recording ends when the control is pressed again.
<b>WB</b> <b>White balance</b>	Press the control and rotate the main command dial to choose a white balance option (in some cases, a sub-option can be selected using the sub-command dial).
 <b>Set Picture Control</b>	Press the control and rotate a command dial to choose a Picture Control.
 <b>Active D-Lighting</b>	Press the control and rotate a command dial to adjust Active D-Lighting.
 <b>Metering</b>	Press the control and rotate a command dial to choose a metering option.
 <b>Release mode (save frame)</b>	Press the control and rotate a command dial to choose the release mode for photographs taken during movie recording.
<b>AF/[+]</b> <b>Focus mode/ AF-area mode</b>	Press the control and rotate the main and sub-command dials to choose the focus and AF-area modes.
 <b>Microphone sensitivity</b>	Press the control and rotate a command dial to adjust microphone sensitivity.
 <b>Peaking highlights</b>	Press the control and rotate the main command dial to choose a peaking level and the sub-command dial to select the peaking color.

Option	Description
M/A <b>Focus (M/A)</b>	Use the control to focus manually, independent of the option selected for focus mode. To refocus using autofocus, press the shutter-release button halfway or press a control to which <b>AF-ON</b> has been assigned.
 <b>Power aperture</b>	Use the control to adjust aperture.
 <b>Exposure compensation</b>	Use the control to adjust exposure compensation.
ISO <b>ISO sensitivity</b>	Use the control to adjust ISO sensitivity.
<b>None</b>	The control has no effect.

#### **Power Aperture**

Power aperture is available only in modes **A** and **M** (a  icon indicates that power aperture cannot be used). The display may flicker while aperture is adjusted.



### g3: AF Speed

MENU button →  (Custom Settings menu)

Choose the focus speed for movie mode.

To choose when the selected option applies, highlight **When to apply** and press . Choose from **Always** (the selected option applies whenever the camera is in movie mode) and **Only**

**while recording** (the selected option applies only while recording is in progress; at other times, the focus speed is “+5”, or in other words as fast possible).

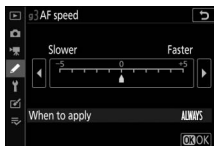

### g4: AF Tracking Sensitivity

MENU button →  (Custom Settings menu)

Choose how quickly focus responds when your subject leaves the focus point or something passes between the subject and the camera in movie mode.

Choose from values between **7 (Low)** and **1 (High)**. The higher the value, the slower the response and the less likely you are to lose focus on your original subject when something passes between the subject and the camera. The lower the value, the quicker the camera is to respond to the subject leaving the focus area by shifting focus to a new subject in the same area.

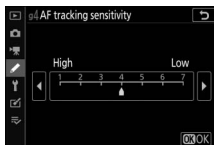

## g5: Highlight Display

MENU button →  (Custom Settings menu)

Choose whether shading is used to indicate highlights (bright areas of the frame) and select the level of brightness needed to trigger the highlight display.

- **Display pattern:** To enable the highlight display, select **Pattern 1** or **Pattern 2**.

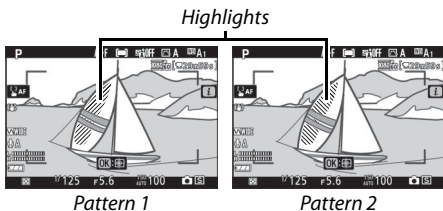

- **Highlight display threshold:** Choose the brightness needed to trigger the movie highlight display. The lower the value, the greater the range of brightnesses that will be shown as highlights. If **255** is selected, the highlight display will show only areas that are potentially overexposed.

### **Highlight Display**

If both the highlight display and peaking highlights are enabled, only peaking highlights will be displayed in manual focus mode. To view the highlight display, select **Off** for Custom Setting d9 (**Peaking highlights**) > **Peaking level**.

## Y The Setup Menu: Camera Setup

To view the setup menu, select the Y tab in the camera menus.

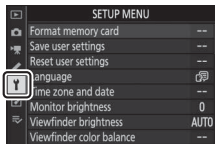

Option	📖
Format memory card	306
Save user settings	306
Reset user settings	306
Language	306
Time zone and date	307
Monitor brightness	307
Viewfinder brightness	308
Viewfinder color balance	309
Information display	310
AF fine-tune	311
Image Dust Off ref photo	312
Image comment	314
Copyright information	315
Beep options	316

Option	📖
Touch controls	316
Self-portrait mode	317
HDMI	317
Location data display	317
Airplane mode	317
Connect to smart device	318
Connect to PC	320
Wireless remote (ML-L7) options	323
Conformity marking	324
Energy saving	325
Slot empty release lock	325
Reset all settings	326
Firmware version	326

### ✔ See Also

For menu defaults, see “Setup Menu Defaults” (📖 180).

## Format Memory Card

MENU button →  (setup menu)

Select **Yes** to format the memory card.

*Note that formatting permanently deletes all pictures and other data on the card.*

Before formatting, be sure to make backup copies as required.



### During Formatting

*Do not turn the camera off or remove memory cards during formatting.*

## Save User Settings

MENU button →  (setup menu)

Frequently-used combinations of settings can be assigned to the **U1** and **U2** positions on the mode dial (📖 82).

## Reset User Settings

MENU button →  (setup menu)

Reset settings for **U1** and **U2** to default values (📖 83).

## Language

MENU button →  (setup menu)

Choose a language for camera menus and messages. The languages available vary with the country or region in which the camera was originally purchased.

## Time Zone and Date

MENU button →  (setup menu)



Change time zones, set the camera clock, choose the date display order, and turn daylight saving time on or off. Be sure to check the camera clock regularly against more accurate timepieces and adjust time and date settings as necessary.

Option	Description
Time zone	Choose a time zone. The camera clock is automatically set to the time in the new time zone.
Date and time	Set the camera clock.
Date format	Choose the order in which the day, month, and year are displayed.
Daylight saving time	Turn daylight saving time on or off. The camera clock will automatically be advanced or set back one hour. The default setting is <b>Off</b> .

If the clock is reset, a  indicator will be displayed.

## Monitor Brightness

MENU button →  (setup menu)

Press  or  to adjust monitor brightness. Choose higher values for increased brightness, lower values for reduced brightness.



- Monitor brightness can only be adjusted when the monitor is the active display; it cannot be adjusted in the “viewfinder only” monitor mode or when your eye is to the viewfinder.
- Higher values increase the drain on the battery.

## Viewfinder Brightness

MENU button →  (setup menu)

Adjust viewfinder brightness.





- Viewfinder brightness can only be adjusted when the viewfinder is the active display; it cannot be adjusted when the viewfinder is off or in the “monitor only” monitor mode.
- Higher values increase the drain on the battery.

Option	Description
<b>Auto</b>	Viewfinder brightness is adjusted automatically in response to lighting conditions.
<b>Manual</b>	Press  or  to adjust brightness manually. Choose higher values for increased brightness, lower values for reduced brightness.

## Viewfinder Color Balance

MENU button → Y (setup menu)

Adjust viewfinder color balance to your taste. Adjustments made using **Viewfinder color balance** must be made using the viewfinder. They cannot be made in the monitor or when **Monitor only** is selected for monitor mode.

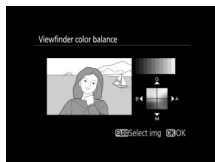

- Viewfinder color balance is adjusted using the multi selector. Press , , , and  to adjust color balance as shown below. Press  to exit when adjustments are complete.



*Increase green*



*Increase magenta*

- Viewfinder color balance applies only to the menu, playback, and shooting displays; pictures taken with the camera are not affected.
- The reference image is either the last picture taken or, in playback mode, the picture last displayed. If the memory card contains no pictures, an empty frame will be displayed instead.
- To choose a different image, tap the /? button. Highlight the desired picture and press  to select it as the reference image.
- To view the highlighted image full frame, touch and hold the  button.



## Information Display

MENU button →  (setup menu)

Adjust the color of the lettering in the information display for ease of viewing. Choose **Dark on light (B)** to display black letters on a white background or **Light on dark (W)** to display white letters on a dark background.

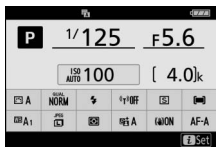

*Dark on light*

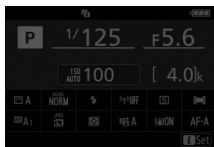









*Light on dark*

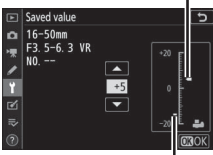

## AF Fine-Tune

MENU button →  (setup menu)

Fine-tune focus for up to 30 lens types. Use only as required. We recommend that you perform fine-tuning at a focus distance you use frequently; if you perform focus-tuning at a short focus distance, for example, you may find it less effective at longer distances.

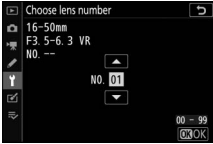
- **AF fine-tune (On/Off):** Choose **On** to turn AF tuning on, **Off** to turn it off.
- **Saved value:** Tune AF for the current lens. Press  to move focal point away from camera or  to move focal point toward camera; choose from values between +20 and -20. The camera can store values for up to 30 lens types. Only one value can be stored for each type of lens.
- **Default:** Choose the AF tuning value used when no previously saved value exists for the current lens.
- **List saved values:** List previously saved AF tuning values. To delete a lens from the list, highlight the desired lens and press . To change a lens identifier (for example, to choose an identifier that is the same as the last two digits of the lens serial number to distinguish it from other lenses of the same type in light of the fact that **Saved value** can be used with only one lens of each type), highlight the desired lens and press . A menu will be displayed; press  or  to choose an identifier and press  to save changes and exit.

## Image Dust Off Ref Photo

MENU button → **Y** (setup menu)

Acquire reference data for the Image Dust Off option in NX Studio. Image Dust Off processes NEF (RAW) pictures to mitigate effects caused by dust adhering in front of the camera image sensor. For more information, refer to NX Studio's online help.

A lens with a focal length of at least 50 mm is recommended when recording Image Dust Off reference data. When using a zoom lens, zoom all the way in.

### 1 Select Start.

Highlight **Start** and press **OK**. A message will be displayed.

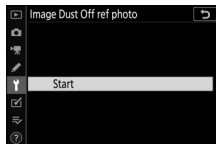

### 2 Frame a featureless white object in the display.

With the lens about ten centimeters (four inches) from a well-lit, featureless white object, frame the object so that it fills the display and then press the shutter-release button halfway.

In autofocus mode, focus will automatically be set to infinity; in manual focus mode, set focus to infinity manually.

### 3 Acquire dust off reference data.

Press the shutter-release button the rest of the way down to acquire Image Dust Off reference data. The monitor turns off when the shutter-release button is pressed.

If the reference object is too bright or too dark, the camera may be unable to acquire Image Dust Off reference data and a message will be displayed. Choose another reference object and repeat the process from Step 1.

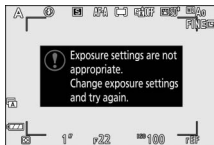

#### ✓ Image Dust Off Reference Data

The same reference data can be used for photographs taken with different lenses or at different apertures. Reference images cannot be viewed using computer imaging software. A grid pattern is displayed when reference images are viewed on the camera.

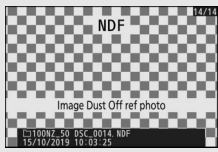

## Image Comment

MENU button → Y (setup menu)

Add a comment to new photographs as they are taken. Comments can be viewed in the NX Studio **Info** tab.

- **Input comment:** Input a comment as described in “Text Entry” (📖 190). Comments can be up to 36 characters long.
- **Attach comment:** Select this option to attach the comment to all subsequent photographs. Highlight **Attach comment** and press  $\odot$  to turn it on or off. After choosing the desired setting, press  $\odot$  to exit.

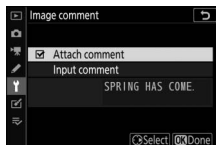

## Copyright Information

MENU button → Y (setup menu)

Add copyright information to new photographs as they are taken. Copyright information can be viewed in the NX Studio **Info** tab.

- **Artist:** Enter a photographer name as described in “Text Entry” (📖 190). Photographer names can be up to 36 characters long.
- **Copyright:** Enter the name of the copyright holder as described in “Text Entry” (📖 190). Copyright holder names can be up to 54 characters long.
- **Attach copyright information:** Select this option to attach copyright information to all subsequent photographs. Highlight **Attach copyright information** and press **Y** to turn it on or off. After choosing the desired setting, press **OK** to exit.



### ✔ Copyright Information

To prevent unauthorized use of the artist or copyright holder names, make sure that **Attach copyright information** is not selected and that the **Artist** and **Copyright** fields are blank before lending or transferring the camera to another person. Nikon does not accept liability for any damages or disputes arising from the use of the **Copyright information** option.

## Beep Options

MENU button →  (setup menu)

Choose the pitch and volume of the beep that sounds when:

- The self-timer is in operation
- Time-lapse recording ends
- The camera focuses in photo mode (note that a beep will not sound if **AF-C** is selected for focus mode or if **AF-A** is selected and the camera is shooting using **AF-C**)
- The touch screen is used

Note that a beep will not sound while the self-timer is in operation or when the focuses if **On** is selected for **Silent photography** in the photo shooting menu.

The **Beep options** menu contains the following items:

- **Beep on/off**: Turn the beep speaker on or off, or select **Off (touch controls only)** to disable the beep during keyboard entry while enabling it for other purposes.
- **Volume**: Adjust beep volume.
- **Pitch**: Choose the pitch of the beep from **High** and **Low**.

## Touch Controls

MENU button →  (setup menu)

Adjust settings for monitor touch controls.

- **Enable/disable touch controls**: Select **Disable** to prevent accidental use of touch-screen controls, or **Playback only** to enable touch-screen controls in playback mode only.
- **Full-frame playback flicks**: Choose whether the next image in full-frame playback is displayed by flicking left or by flicking right.

## Self-Portrait Mode

MENU button →  (setup menu)

Select **Disable** to prevent the camera entering self-portrait mode when the monitor is in the self-portrait position.

## HDMI

MENU button →  (setup menu)

Adjust settings for connection to HDMI devices (📄 400).

## Location Data Display

MENU button →  (setup menu)

View location data downloaded from smart devices using the SnapBridge app. The items displayed vary with the smart device.

## Airplane Mode

MENU button →  (setup menu)

Select **Enable** to disable the camera's built-in Bluetooth and Wi-Fi functions.

## Connect to Smart Device

MENU button →  (setup menu)

Connect to smartphones or tablets (smart devices) via Bluetooth or Wi-Fi.

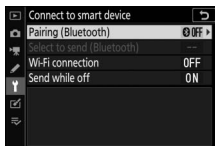

## Pairing (Bluetooth)

Pair with or connect to smart devices using Bluetooth.

Option	Description
<b>Start pairing</b>	Pair the camera with a smart device (📄 377).
<b>Paired devices</b>	List paired smart devices or switch from one device to another.
<b>Bluetooth connection</b>	Select <b>Enable</b> to enable Bluetooth.

## Select to Send (Bluetooth)

Select pictures for upload to a smart device or choose whether to mark pictures for upload as they are taken. Upload begins immediately when a connection is established.

Option	Description
<b>Auto select to send</b>	If <b>On</b> is selected, photos will be marked for upload to a smart device as they are taken (this does not apply to photos taken in movie mode, which must be selected for upload manually). Regardless of the option selected with the camera, photos are uploaded in JPEG format at a size of 2 megapixels.
<b>Manual select to send</b>	Mark selected pictures for upload.
<b>Deselect all</b>	Remove transfer marking from all images.



## **Wi-Fi Connection**

Connect to smart devices via Wi-Fi.

### **■ ■ Establish Wi-Fi Connection**

Initiate a Wi-Fi connection to a smart device. To connect, select the camera SSID on the smart device and enter the password (□ 371). Once a connection is established, this option will change to **Close Wi-Fi connection**, which can be used to end the connection when desired.

### **■ ■ Wi-Fi Connection Settings**

Access the following Wi-Fi settings:

- **SSID:** Set the camera SSID.
- **Authentication/encryption:** Choose **OPEN** or **WPA2-PSK-AES**.
- **Password:** Set the camera password.
- **Channel:** Select **Auto** to have the camera choose the channel automatically, or select **Manual** and choose the channel manually.
- **Current settings:** View current Wi-Fi settings.
- **Reset connection settings:** Select **Yes** to reset Wi-Fi settings to default values.

## **Send While Off**

If **On** is selected, upload of images to smart devices connected via Bluetooth will continue even when the camera is off.

## Connect to PC

MENU button → 🗝 (setup menu)

Connect to computers via Wi-Fi.



### Wi-Fi Connection

Select **Enable** to connect using the settings currently selected for **Network settings**.

## **Network Settings**

Select **Create profile** to create a new network profile (☰ 353, 357). If more than one profile already exists, you can press Ⓞ to select a profile from a list. To edit an existing profile, highlight it and press Ⓞ. The following options will be displayed:

- **General:** The profile name and password. Select **Profile name** to rename the profile (by default, the profile name is the same as the network SSID). To require that a password be entered before the profile can be changed select **On** for **Password protection** (to change the password, highlight **On** and press Ⓞ).
- **Wireless:** Adjust settings for connection to a network via a router (infrastructure mode) or for direct wireless connection to the camera (access-point mode).
  - **Infrastructure mode:** Enter the network SSID and password and choose the type of authentication/encryption used on the network (**OPEN** or **WPA2-PSK-AES**). The channel is selected automatically.
  - **Access-point mode:** Enter the SSID and choose a channel (select **Auto** for automatic channel selection or **Manual** to choose the channel manually) and authentication/encryption type (**OPEN** or **WPA2-PSK-AES**) used for connection to the camera. If **WPA2-PSK-AES** is selected for **Authentication/encryption**, you can also set the camera password.
- **TCP/IP:** If **Enable** is selected for **Obtain automatically**, the IP address and sub-net mask for infrastructure mode connections will be acquired via a DHCP server or automatic IP addressing. Select **Disable** manually to enter the IP address (**Address**) and sub-net mask (**Mask**). Note that an IP address is required for infrastructure mode connections.

## **Options**

Adjust upload settings.

### **■ Auto Send**

Select **On** to upload new photos as they are taken. Upload begins only after the photo has been recorded to the memory card; be sure a memory card is inserted in the camera. Movies and photos taken in movie mode are not uploaded automatically when recording is complete but must instead be uploaded from the playback display (📖 364).

### **■ Delete After Send**

Select **Yes** to delete photographs from the camera memory card automatically once upload is complete (files marked for transfer before this option is selected are not deleted). Deletion may be suspended during some camera operations.

### **■ Send File As**

When uploading NEF+JPEG images, choose whether to upload both the NEF (RAW) and JPEG files or only the JPEG copy.

### **■ Deselect All?**

Select **Yes** to remove transfer marking from all images. Upload of images with a “sending” icon will immediately be terminated.

## **MAC Address**

View the MAC address.

## Wireless Remote (ML-L7) Options

MENU button →  (setup menu)

Establish a Bluetooth connection to an optional ML-L7 remote control. You can also choose the roles assigned to the **Fn1** and **Fn2** buttons on the remote.

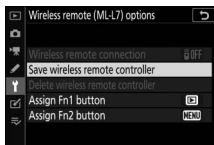

## Wireless Remote Connection

Option	Description
Enable	Connect to a paired ML-L7. Any existing connection to a smart device or computer will end.
Disable	End the connection to the ML-L7.

## Save Wireless Remote Controller

Ready the camera for pairing with an ML-L7 remote control. When the camera is ready, press the power button on the remote controller for over three seconds until the devices are paired. The remote controller's status lamp will flash green approximately once every three seconds when pairing is complete.

The camera can be paired with only one remote controller at a time. It can only be used with the controller with which it was most recently paired.

## Delete Wireless Remote Controller

End an existing pairing connection between the camera and an ML-L7.

## Assign Fn1 Button/Assign Fn2 Button

Choose the roles assigned to the ML-L7's **Fn1** and **Fn2** buttons.

Option	Description
Same as camera ▶ button	The button performs the same function as the camera ▶ button.
Same as camera MENU button	The button performs the same function as the camera MENU button.
Same as camera i button	The button performs the same function as the camera i button.
None	Pressing the button has no effect.

### The Remote Controller Status LED

The status of an ML-L7 interacting with the camera is shown by the controller status lamp:

Color	Behavior	Status
Green	Flashes approximately once a second	Searching for paired camera.
	Flashes quickly (approximately twice a second)	Pairing.
	Flashes approximately once every three seconds	Connected to camera.
Orange	Flashes once	Photography started.
	Flashes twice	Photography ended.
Red	Flashes once	Movie recording started.
	Flashes twice	Movie recording ended.

## Conformity Marking

MENU button →  (setup menu)

View some of the standards with which the camera complies.



## Energy Saving

MENU button →  (setup menu)

In photo mode, the shooting display will turn off to save power approximately 15 seconds before the standby timer expires.

Option	Description
<b>Enable</b>	Enable energy saving. The display refresh rate may drop.
<b>Disable</b>	Disable energy saving. Note selecting <b>Disable</b> does not stop the shooting display dimming a few seconds before the standby expires.

### **Note: Energy Saving**

- Note that even when **Enable** is selected, energy saving will not function:
  - If **No limit** is selected for Custom Setting c3 (**Power off delay**) > **Standby timer** or if the delay selected is less than 30 seconds
  - In self-portrait mode
  - In  or  mode
  - During display zoom
  - While the camera is connected to another device via HDMI or USB
- Selecting **Disable** increases the drain on the battery.

## Slot Empty Release Lock

MENU button →  (setup menu)

Selecting **Enable release** allows the shutter to be released when no memory card is inserted, although no pictures will be recorded (they will however be displayed in demo mode). If **Release locked** is selected, the shutter-release button is only enabled when a memory card is inserted in the camera.

## Reset All Settings

MENU button →  (setup menu)

Reset all settings except **Language** and **Time zone and date** to their default values. Copyright information and other user-generated entries are also reset. Once reset, settings cannot be restored.

## Firmware Version

MENU button →  (setup menu)

View the current camera firmware version.







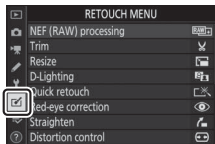







## **The Retouch Menu: *Creating Retouched Copies***

To view the retouch menu, select the  tab in the camera menus.



The options in the retouch menu are used to create trimmed or retouched copies of existing pictures. The retouch menu is only displayed when a memory card containing photographs is inserted in the camera.

Option		Option	
 NEF (RAW) processing	330	 Straighten	337
 Trim	333	 Distortion control	338
 Resize	334	 Perspective control	339
 D-Lighting	336	 Image overlay <sup>1</sup>	340
 Quick retouch	336	 Trim movie	343
 Red-eye correction	337	 Side-by-side comparison <sup>2</sup>	343

- 1 Can only be selected by pressing **MENU** and selecting  tab.
- 2 Can only be displayed by pressing **i** and selecting **Retouch** when a retouched image or original is displayed.

# Creating Retouched Copies

To create a retouched copy:

## 1 Select an item in the retouch menu.

Press or to highlight an item, to select.

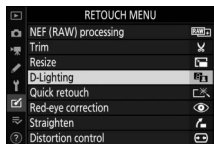

## 2 Select a picture.

Highlight a picture and press . To view the highlighted picture full screen, touch and hold the button.



### Retouch

In the case of images recorded at image quality settings of NEF + JPEG, only the NEF (RAW) image will be retouched. The camera may not be able to display or retouch images created with other devices.

## 3 Select retouch options.

For more information, see the section for the selected item. To exit without creating a retouched copy, press **MENU**.

### Power off Delay

The display will turn off and the operation will be cancelled if no actions are performed for a brief period. Any unsaved changes will be lost. To increase the time the display remains on, choose a longer menu display time using Custom Setting c3 (**Power off delay**) > **Menus**.

## 4 Create a retouched copy.

Press **OK** to create a retouched copy. Retouched copies are indicated by a  icon.



### Retouching the Current Image

To create a retouched copy of the current image, press **i** and select **Retouch**.

### Retouching Copies

Most options can be applied to copies created using other retouch options, although (with the exception of **Trim movie**) each option can be applied only once (note that multiple edits may result in loss of detail). Options that cannot be applied to the current image are grayed out and unavailable.

### Image Quality

- Cropped and resized copies created from NEF (RAW) images are saved at an **Image quality** of **JPEG fine**.
- Copies created from JPEG images are the same quality as the original.

### Image Size

Except in the case of copies created with **NEF (RAW) processing**, **Trim**, and **Resize**, copies are the same size as the original.

“NEF (RAW) processing” is used to convert NEF (RAW) photographs to other formats, such as JPEG. To create JPEG copies of NEF (RAW) photographs on the camera, follow the steps below.

### 1 Select NEF (RAW) processing.

Highlight **NEF (RAW) processing** in the retouch menu and press .

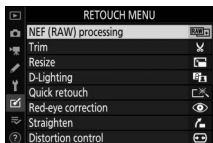



### 2 Choose how images are selected.

Choose from the following options:

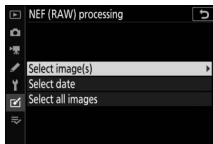

- **Select image(s)**: Select one or more images manually.
- **Select date**: Create JPEG copies of all the NEF (RAW) images taken on selected dates.
- **Select all images**: Create JPEG copies of all the NEF (RAW) images on the memory card (proceed to Step 4).

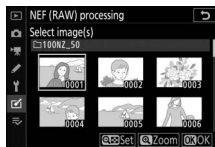

### 3 Select photographs.

If you chose **Select image(s)** in Step 2, a picture selection dialog will be displayed listing only NEF (RAW) images created with this camera. Highlight images using the multi selector and tap the  button to select or deselect; selected images are indicated by a ✓ icon. To view the highlighted image full screen, touch and hold the  button. Press  to proceed to Step 4 when your selection is complete.



If you chose **Select date** in Step 2, a list of dates will be displayed. Highlight dates using the multi selector and press  to select or deselect. Press  to select all NEF (RAW) pictures taken on the chosen dates and proceed to Step 4.



## 4 Choose settings for the JPEG copies.

Adjust the settings listed below, or select **Original** (if available) to use the setting in effect when the photograph was taken (the original settings are listed below the preview). Note that exposure compensation can only be set to values between  $-2$  and  $+2$  EV.

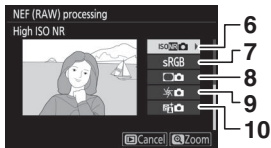
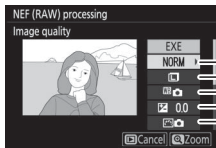

1 Image quality ..... 126

2 Image size ..... 128

3 White balance ..... 67, 120

4 Exposure compensation ..... 102

5 Set Picture Control ..... 116, 204

6 High ISO NR ..... 210

7 Color space ..... 209

8 Vignette control ..... 211

9 Diffraction compensation ..... 211

10 Active D-Lighting ..... 133

## 5 Copy the photographs.



Highlight **EXE** and press **OK** to create a JPEG copy of the selected photograph (if multiple photos are selected, a confirmation dialog will be displayed; highlight **Yes** and press **OK** to create JPEG copies of the selected photos). To exit without copying the photographs, press the **▶** button.



## Trim

MENU button →  (retouch menu)

Create a cropped copy of the selected photograph. The selected photograph is displayed with the selected crop shown in yellow; create a cropped copy as described below.

- **To reduce size of the crop:** Tap /?.
- **To increase size of the crop:** Tap .
- **To change the crop aspect ratio:** Rotate the main command dial.
- **To position the crop:** Use the multi selector.
- **To create a cropped copy:** Press  to save the current crop as a separate file. The size of the copy varies with crop size and aspect ratio and appears at upper left in the crop display.

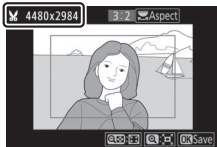

### Viewing Cropped Copies



Depending on the dimensions of the cropped copy, playback zoom may not be available when the copy is displayed.

## Resize

MENU button →  (retouch menu)

Use the **Resize** option in the camera menu  tab to create small copies of selected photographs.

### 1 Select **Resize**.

Highlight **Resize** in the  tab and press .

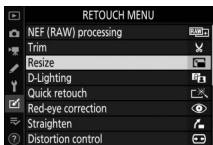

### 2 Choose a size.

Highlight **Choose size** and press .

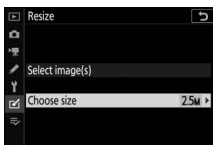

Highlight the desired size and press .

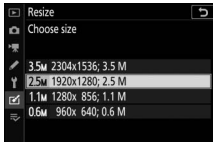



### 3 Choose pictures.

Highlight **Select image(s)** and press



Highlight pictures and tap /? to select or deselect (to view the highlighted picture full screen, touch and hold the button). Selected pictures are marked by a icon.

Press when the selection is

complete. Note that photographs taken at an image-area setting of **1 : 1 (16×16)** or **16 : 9 (24×14)** cannot be resized.



### 4 Save the resized copies.

A confirmation dialog will be displayed. Highlight **Yes** and press to save the resized copies.



#### Viewing Resized Copies



Depending on the dimensions of the resized copy, playback zoom may not be available when the resized copy is displayed.

## D-Lighting

MENU button →  (retouch menu)

D-Lighting brightens shadows, making it ideal for dark or backlit photographs.





Press  or  to choose the amount of correction performed. The effect can be previewed in the edit display. Press  to save the retouched copy.



## Quick Retouch

MENU button →  (retouch menu)

Create copies with enhanced saturation and contrast. D-Lighting is applied as required to brighten dark or backlit subjects.

Press  or  to choose the amount of enhancement. Press  to copy the photograph.

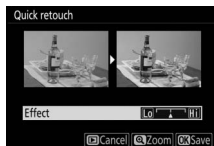



## Red-Eye Correction

MENU button →  (retouch menu)

This option is used to correct “red-eye” and is available only with photographs taken using a flash. The photograph selected for red-eye correction can be previewed in the edit display. Confirm the effects of red-eye correction and press **OK** to create a copy. Note that red-eye correction may not always produce the expected results and may in very rare circumstances be applied to portions of the image that are not affected by red-eye; check the preview thoroughly before proceeding.

## Straighten

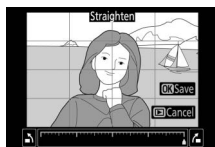

MENU button →  (retouch menu)

Create a straightened copy of the selected image. Press  to rotate the image clockwise by up to five degrees in increments of approximately 0.25 degrees,  to rotate it counter-clockwise (the effect can be previewed in the edit display; note that edges of the image will be trimmed to create a square copy). Press **OK** to save the retouched copy.



## Distortion Control

MENU button →  (retouch menu)

Create copies with reduced peripheral distortion. Select **Auto** to let the camera correct distortion automatically and then make fine adjustments using the multi selector, or select **Manual** to reduce distortion manually. Note that **Auto** is not available with photos taken using the **Auto distortion control** option in the photo shooting menu or copies previously processed using **Auto**, and that distortion control cannot be performed again on copies created using **Manual**. Press  to reduce barrel distortion,  to reduce pincushion distortion (the effect can be previewed in the edit display; note that greater amounts of distortion control result in more of the edges being cropped out). Press  to save the retouched copy.

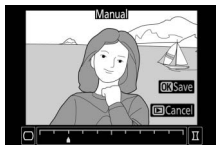

## Perspective Control

MENU button →  (retouch menu)

Create copies that reduce the effects of perspective in photos taken looking up from the base of a tall object. Use the multi selector to adjust perspective (note that greater amounts of perspective control result in more of the edges being cropped out). The results can be previewed in the edit display. Press  to save the retouched copy.



*Before*



*After*

## Image Overlay



MENU button →  (retouch menu)

Image overlay combines two existing NEF (RAW) photographs to create a new picture that is saved separately from the originals.



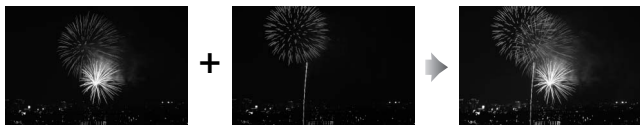

### 1 Select Image overlay.

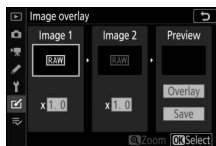
Highlight **Image overlay** in the retouch menu and press . Image overlay options will be displayed, with **Image 1** highlighted; press  to display a picture selection dialog listing only NEF (RAW) images created with this camera.



### 2 Select the first image.

Use the multi selector to highlight the first photograph in the overlay. To view the highlighted photograph full frame, touch and hold the  button. Press  to select the highlighted photograph and return to the preview display.



---

### 3 Select the second image.

The selected image will appear as **Image 1**. Highlight **Image 2** and press **OK**, then select the second photo as described in Step 2.

---

### 4 Adjust gain.

Highlight **Image 1** or **Image 2** and optimize exposure for the overlay by pressing **▲** or **▼** to select the gain from values between 0.1 and 2.0. Repeat for the second image. The default value is 1.0; select 0.5 to halve gain or 2.0 to double it. The effects of gain are visible in the **Preview** column.

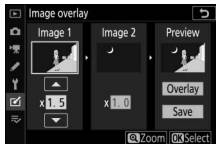

---

### 5 Preview the overlay.

To preview the composition, press **◀** or **▶** to place the cursor in the **Preview** column, then press **▲** or **▼** to highlight **Overlay** and press **OK** (note that colors and brightness in the preview may differ from the final image). To save the overlay without displaying a preview, select **Save**. To return to Step 4 and select new photos or adjust gain, tap **Q/??/?**.



---

### 6 Save the overlay.

Press **OK** while the preview is displayed to save the overlay. After an overlay is created, the resulting image will be displayed full-frame.





### **Image Overlay**

Only NEF (RAW) photographs with the same image area and bit-depth can be combined. The overlay is saved in JPEG fine format and has the same photo info (including date of recording, metering, shutter speed, aperture, shooting mode, exposure compensation, focal length, and image orientation) and values for white balance and Picture Control as the photograph selected for **Image 1**. The current image comment is appended to the overlay when it is saved; copyright information, however, is not copied.



## Trim Movie

MENU button →  (retouch menu)

Create a copy from which unwanted footage has been removed ( 162).

## Side-by-Side Comparison

(see below)

Compare retouched copies to the original photographs. This option can only be accessed by pressing the  button and selecting **Retouch** when a copy or original is displayed.

- 1 Select a retouched copy (shown by a  icon) or an original that has been retouched.







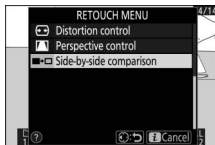

- 2 Display retouch options.  
Press  and select **Retouch**.



- 3 Select **Side-by-side comparison**.  
Highlight **Side-by-side comparison** and press .



## 4 Compare the copy with the original.

The source image is displayed on the left, the retouched copy on the right, with the options used to create the copy listed at the top of the display. Press  or  to switch between the source image and the retouched copy. To view the highlighted picture full frame, touch and hold the  button. If the copy was created from two source images using **Image overlay**, or if the source has been copied multiple times, press  or  to view the other images. To exit to playback, press the  button, or press  to exit to full-frame playback with the highlighted image displayed.

*Options used to create copy*

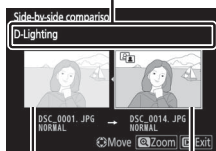

*Source image*

*Retouched copy*

### Side-by-Side Comparison

The source image will not be displayed if the copy was created from a photograph that was protected or has since been deleted.

## ☰ My Menu/⌚ Recent Settings

To view My Menu, select the ☰ tab in the camera menus.

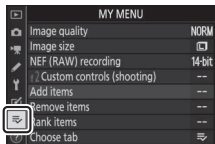

The **MY MENU** option can be used to create and edit a customized list of up to 20 items from the playback, photo shooting, movie shooting, Custom Settings, setup, and retouch menus. If desired, recent settings can be displayed in place of My Menu.

Options can be added, deleted, and reordered as described below.

### Adding Options to My Menu

#### 1 Select **Add items**.

In My Menu (☰), highlight **Add items** and press ⏪.

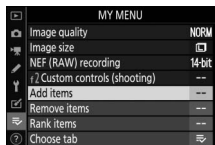

#### 2 Select a menu.

Highlight the name of the menu containing the option you wish to add and press ⏪.

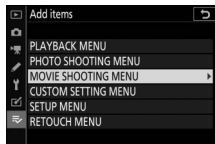

### 3 Select an item.

Highlight the desired menu item and press **OK**.

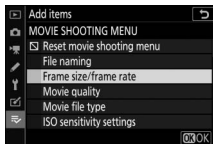

### 4 Position the new item.

Press **▲** or **▼** to move the new item up or down in My Menu. Press **OK** to add the new item.

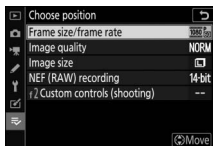

### 5 Add more items.

The items currently displayed in My Menu are indicated by a check mark. Items indicated by a  icon cannot be selected. Repeat Steps 1–4 to select additional items.

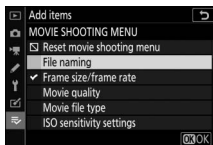

## Deleting Options from My Menu

### 1 Select Remove items.

In My Menu (⇨), highlight **Remove items** and press (⏏).

### 2 Select items.

Highlight items and press (⏏) to select or deselect. Selected items are indicated by a check mark.

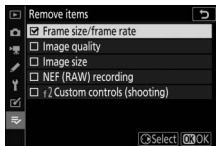

### 3 Delete the selected items.

Press (OK). A confirmation dialog will be displayed; press (OK) again to delete the selected items.



#### **✓** Deleting Items in My Menu

To delete the item currently highlighted in My Menu, press the (⏏) button. A confirmation dialog will be displayed; press (⏏) again to remove the selected item from My Menu.

## Reordering Options in My Menu

### 1 Select Rank items.



In My Menu (≡), highlight **Rank items** and press .

### 2 Select an item.

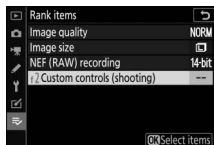
Highlight the item you wish to move and press .



### 3 Position the item.

Press  or  to move the item up or down in My Menu and press . Repeat Steps 2–3 to reposition additional items.



### 4 Exit to My Menu.

Press the **MENU** button to return to My Menu.

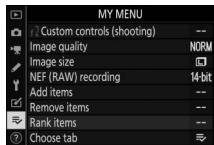
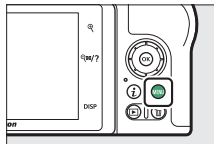

## Recent Settings

To display the twenty most recently used settings, select **RECENT SETTINGS** for **MY MENU** > **Choose tab**.

### 1 Select **Choose tab**.

In My Menu (⇨), highlight **Choose tab** and press **OK**.

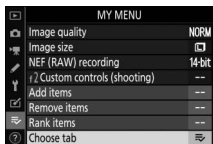

### 2 Select **RECENT SETTINGS**.

Highlight **RECENT SETTINGS** and press **OK**. The name of the menu will change from "MY MENU" to "RECENT SETTINGS."

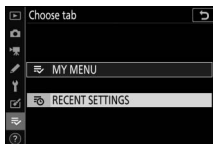

Menu items will be added to the top of the recent settings menu as they are used. To view My Menu again, select **MY MENU** for **RECENT SETTINGS** > **Choose tab**.

#### **✓ Removing Items from the Recent Settings Menu**

To remove an item from the recent settings menu, highlight it and press the **trash** button. A confirmation dialog will be displayed; press **trash** again to delete the selected item.

# Establishing Wireless Connections to Computers or Smart Devices

## Network Options

The types of network connection available with the camera are shown below.

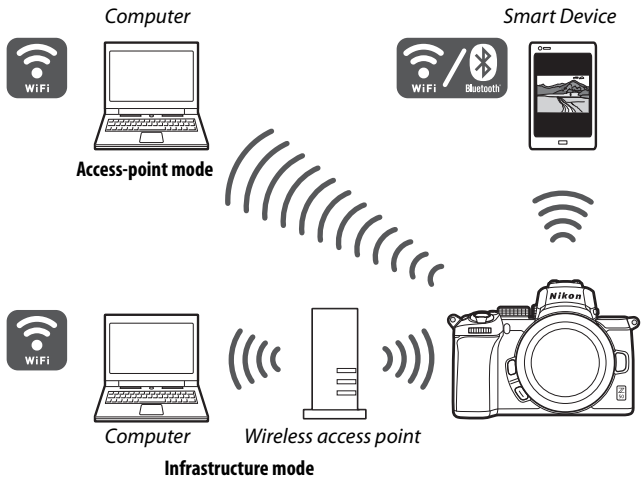



## Connecting to Computers via Wi-Fi

### What Wi-Fi Can Do for You

Connect via Wi-Fi to upload selected pictures to a computer.

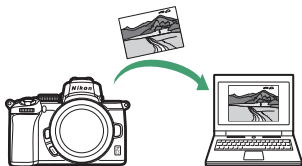

### The Wireless Transmitter Utility

After configuring the camera for connection, you will need to pair it with the computer using the Wireless Transmitter Utility before you will be able to upload images via Wi-Fi. Once the devices are paired, you will be able to connect to the computer from the camera.

The Wireless Transmitter Utility is a computer application available for download from the Nikon Download Center:  
<https://downloadcenter.nikonimglib.com>

Be sure to download the latest version after reading the release notes and system requirements.

#### Illustrations

The appearance and content of the software and operating system dialogs, messages, and displays shown in this guide may vary with the operating system used. For information on basic computer operations, see the documentation provided with the computer or operating system.

## **Infrastructure and Access-Point Modes**

The camera can connect either via a wireless router on an existing network (infrastructure mode) or by direct wireless link (access-point mode).

### **■ Access-Point Mode**

The camera and computer connect via direct wireless link, with the camera acting as a wireless LAN access point and without the need for



*Access-point mode*

complicated adjustments to settings. Choose this option when working outdoors or in other situations in which the computer is not already connected to a wireless network. The computer cannot access the Internet while connected to the camera.

### **■ Infrastructure Mode**

The camera connects to a computer on an existing network (including home networks) via a wireless router.



*Infrastructure mode*

The computer can still access the Internet while connected to the camera.

#### **✓ Infrastructure Mode**

This guide assumes you are connecting via an existing wireless network. Connection to computers beyond the local area network is not supported.

## Connecting in Access-Point Mode

Follow the steps below to create a direct wireless link to a computer in access-point mode.

### 1 Display network settings.

Select **Connect to PC** in the camera setup menu, then highlight **Network settings** and press **▶**.



### 2 Select Create profile.

Highlight **Create profile** and press **OK**.

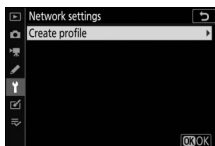

### 3 Select Direct connection to PC.

Highlight **Direct connection to PC** and press **OK**.

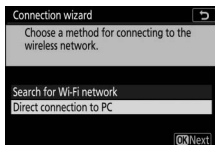

The camera SSID and encryption key will be displayed.

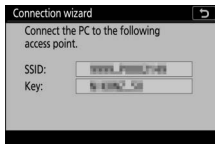

---

## 4 Connect from the computer.

**Windows:** Click the wireless LAN icon in the taskbar and select the SSID displayed by the camera in Step 3. When prompted to enter the network security key, enter the encryption key displayed by the camera in Step 3.

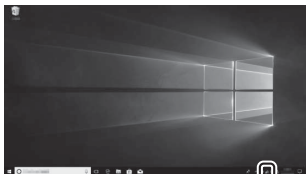

**macOS/OS X:** Click the wireless LAN icon in the menu bar and select the SSID displayed by the camera in Step 3. When prompted to supply a password, enter the encryption key displayed by the camera in Step 3.



---

## 5 Launch the Wireless Transmitter Utility.

When prompted, launch the Wireless Transmitter Utility on the computer.



## 6 Select the camera.

In the Wireless Transmitter Utility, select the camera name displayed in Step 5 and click **Next**.

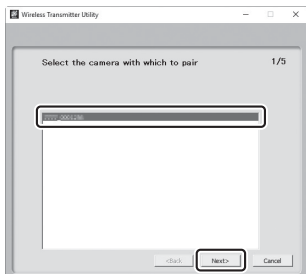

## 7 Enter the authentication code.

The camera will display an authentication code.



Enter the authentication code in the dialog displayed by the Wireless Transmitter Utility and click **Next**.

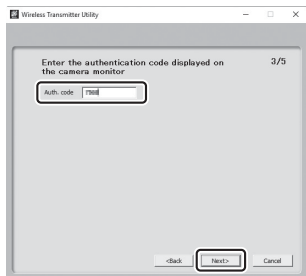

## 8 Complete the pairing process.

When the camera displays a message stating that pairing is complete, press

OK.



In the Wireless Transmitter Utility, click **Next**. You will be prompted to choose the destination folder; for more information, see online help for the Wireless Transmitter Utility.

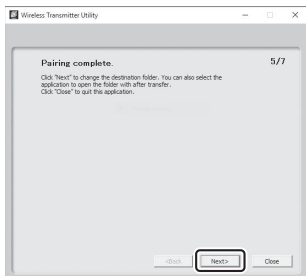

When you exit the Wireless Transmitter Utility after pairing is complete, a wireless connection will be established between the camera and computer.

## 9 Check the connection.

When a connection is established, the network SSID will be displayed in green in the camera **Connect to PC** menu.

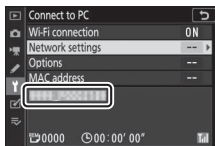

If the camera SSID is not displayed in green, connect to the camera via the wireless network list on your computer.

Now that a wireless connection has been established, you can upload images to the computer as described in "Uploading Pictures" (□ 364).

## Connecting in Infrastructure Mode

Follow the steps below to connect to a computer on an existing network in infrastructure mode.

---

### 1 Display network settings.

Select **Connect to PC** in the camera setup menu, then highlight **Network settings** and press **▶**.



### 2 Select Create profile.

Highlight **Create profile** and press **OK**.

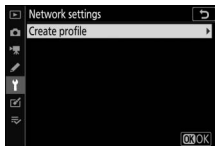

### 3 Search for existing networks.

Highlight **Search for Wi-Fi network** and press **OK**. The camera will search for networks currently active in the vicinity and list them by name (SSID).

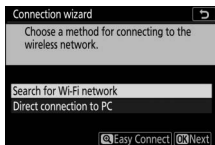

#### ✔ "Easy Connect"

To connect without entering an SSID or encryption key, tap **Easy Connect** in Step 3, then press **OK** and choose from the following options:

- **Push-button WPS:** For routers that support push-button WPS. Press the camera **Easy Connect** button to connect.
- **PIN-entry WPS:** The camera will display a PIN; to connect, use a computer to enter the PIN into the router (for more information, see the documentation provided with the router).

After connecting, proceed to Step 6.

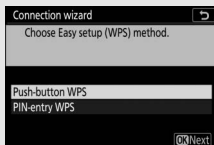



## 4 Choose a network.

Highlight a network SSID and press **OK** (if the desired network is not displayed, tap **Q** to search again).

Encrypted networks are indicated by a **lock** icon; if the selected network is encrypted, you will be prompted to enter the encryption key as described in Step 5. If the network is not encrypted, proceed to Step 6.

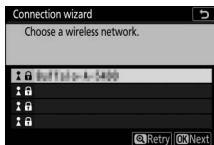

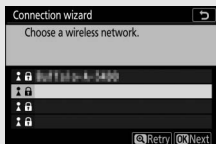

### ✓ Hidden SSIDs

Networks with hidden SSIDs are indicated by blank entries in the network list. If you highlight a blank entry and press **OK**, you will be prompted to provide the network name; press **OK**, enter a name, and then tap **Q**. Tap **Q** again to proceed to Step 5.



## 5 Enter the encryption key.

When prompted to enter the encryption key for the wireless router, press ...

...and enter the key as described below. For information on the encryption key, see the documentation for the wireless router. Tap  when entry is complete.

Tap  again to initiate the connection. The message shown in the illustration will be displayed for a few seconds when the connection is established.

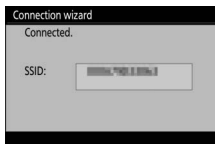
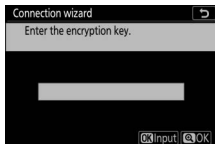

---

## 6 Obtain or select an IP address.

Highlight one of the following options and press **OK**.

- **Obtain automatically:** Select this option if the network is configured to supply the IP address automatically.
- **Enter manually:** When prompted, enter an IP address by rotating the main command dial to highlight segments, pressing **Left** and **Right** to change and pressing **OK** to accept. Tap **Q** to exit to the “IP address configuration complete” dialog when entry is complete. Tapping **Q** again displays the sub-net mask, which you can edit by pressing **Up** and **Down**, pressing **OK** to exit when entry is complete.

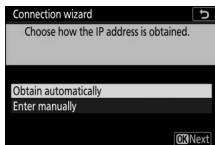

Confirm the IP address and press **OK** to proceed.

---

## 7 Launch the Wireless Transmitter Utility.

When prompted, launch the Wireless Transmitter Utility on the computer.



## 8 Select the camera.

In the Wireless Transmitter Utility, select the camera name displayed in Step 7 and click **Next**.

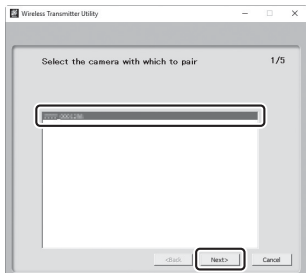

## 9 Enter the authentication code.

The camera will display an authentication code.



Enter the authentication code in the dialog displayed by the Wireless Transmitter Utility and click **Next**.

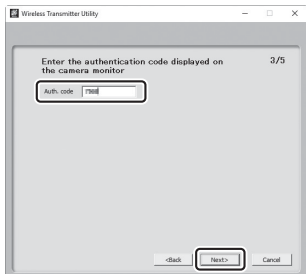

---

## 10 Complete the pairing process.

Press **OK** when the camera displays the message shown in the illustration.



In the Wireless Transmitter Utility, click **Next**. You will be prompted to choose the destination folder; for more information, see the Wireless Transmitter Utility online help.

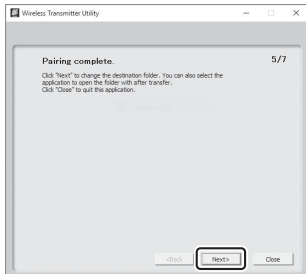

When you exit the Wireless Transmitter Utility after pairing is complete, a wireless connection will be established between the camera and computer.

---

## 11 Check the connection.

When a connection is established, the network SSID will be displayed in green in the camera **Connect to PC** menu.

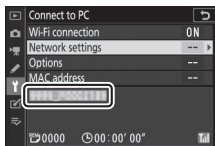

If the camera SSID is not displayed in green, connect to the camera via the wireless network list on your computer.

Now that a wireless connection has been established, you can upload images to the computer as described in "Uploading Pictures" (□ 364).

## Uploading Pictures

You can select pictures for upload in the camera playback display or upload pictures as they are taken.

### ✔ Destination Folders

By default, images are uploaded to the following folders:

- **Windows:** \Users\<(user name)\Pictures\Wireless Transmitter Utility
- **Mac:** /Users/(user name)/Pictures/Wireless Transmitter Utility

The destination folder can be selected using the Wireless Transmitter Utility. For more information, see the utility's online help.

### ✔ Access Point Mode

Computers cannot access the Internet while connected to the camera in access point mode. To access the Internet, terminate the connection to the camera and then reconnect to a network with Internet access.

## ■ Selecting Pictures for Upload

Follow the steps below to select pictures for upload.

### 1 Start playback.

Press the  button on the camera and select full-frame or thumbnail playback.

### 2 Press the *i* button.

Select a picture and press the *i* button to display the playback *i* menu.

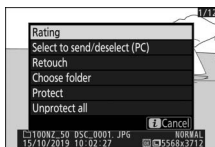

### 3 Choose **Select to send/deselect (PC)**.

Highlight **Select to send/deselect (PC)** and press **OK**. A white transfer icon will appear on the picture. If the camera is currently connected to a network, upload will begin immediately; otherwise, upload will begin when a connection is established. The transfer icon turns green during upload. Repeat Steps 2–3 to upload additional images.



#### **✓** Deselecting Pictures

To remove transfer marking from the current picture, highlight **Select to send/deselect (PC)** and press **OK**. To remove transfer marking from all pictures, select **Connect to PC > Options > Deselect all?** in the setup menu.



### ■■ **Uploading Photos as They Are Taken**

To upload new photos as they are taken, select **On** for **Connect to PC > Options > Auto send**. Upload begins only after the photo has been recorded to the memory card; be sure a memory card is inserted in the camera. Movies and photographs taken in movie mode are not uploaded automatically when recording is complete but must instead be uploaded from the playback display.



## ■ ■ The Transfer Icon

Upload status is indicated by the transfer icon.

-  (white): **Send**. The picture has been selected for upload but upload has not yet begun.
-  (green): **Sending**. Upload in progress.
-  (blue): **Sent**. Upload complete.





## ■ The “Connect to PC” Status Display

The **Connect to PC** display shows the following information:

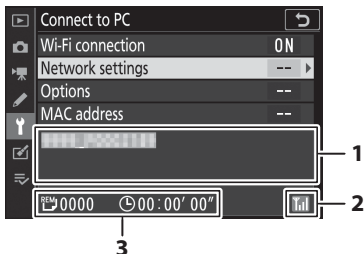

1 <b>Status</b>	<p>The status of the connection to the host. The host name is displayed in green when a connection is established.</p> <ul style="list-style-type: none"><li>• While files are being transferred, the status display shows “Now sending” preceded by the name of the file being sent.</li><li>• Any errors that occur during transfer are also displayed here.</li></ul>
2 <b>Signal strength</b>	Wireless signal strength.
3 <b>Pictures/time remaining</b>	The estimated time required to send the remaining pictures.

### ✓ Loss of Signal

Wireless transmission may be interrupted if the signal is lost, but can be resumed by turning the camera off and then on again.

## **Disconnecting and Reconnecting**

The camera's link to an existing network can be suspended or resumed as described below.

### **■ Disconnecting**

You can disconnect by turning the camera off, selecting **Disable** for **Connect to PC > Wi-Fi connection** in the setup menu, or selecting **Wi-Fi connection > Close Wi-Fi connection** in the **i** menu for shooting mode. The connection to the computer will also end if you use Wi-Fi to connect to a smart device.

#### **✓ Access-Point Mode**

A communication error will occur if the computer's wireless connection is disabled before the camera's. Disable camera Wi-Fi first.

### **■ Reconnecting**

To reconnect to an existing network, either:

- select **Enable** for **Connect to PC > Wi-Fi connection** in the setup menu, or
- choose **Wi-Fi connection > Establish Wi-Fi connection with PC** in the **i** menu for shooting mode.

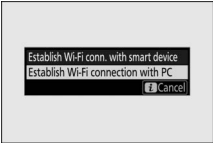

Establish Wi-Fi conn. with smart device  
Establish Wi-Fi connection with PC  
Cancel

#### **✓ Access-Point Mode**

Enable camera Wi-Fi before connecting.

#### **✓ Multiple Network Profiles**

If the camera has profiles for more than one network, it will reconnect to the last network used. Other networks can be selected using the **Connect to PC > Network settings** option in the setup menu.

## Connecting to Smart Devices

To connect to the camera from a smartphone or tablet (below, “smart device”), download the SnapBridge app.

### The SnapBridge App

Use the SnapBridge app for wireless connections between the camera and smart devices.



The SnapBridge app is available free of charge from the Apple App Store® and on Google Play™. Visit the Nikon website for the latest SnapBridge news.



### What SnapBridge Can Do for You

Using the SnapBridge app, you can:

- **Download pictures from the camera**

Download existing pictures or download new pictures as they are taken.

- **Control the camera remotely (remote photography)**

Control the camera and take pictures from the smart device.

For details, see the SnapBridge app online help:

<https://nikonimglib.com/snbr/onlinehelp/en/index.html>

## Wireless Connections

Using the SnapBridge app, you can connect via Wi-Fi (📖 371) or Bluetooth (📖 377). Connecting the camera and smart device via the SnapBridge app allows you to set the camera clock and update location data using information provided by the smart device.

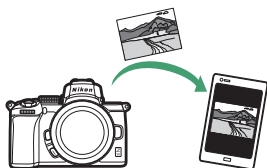

*Wi-Fi*

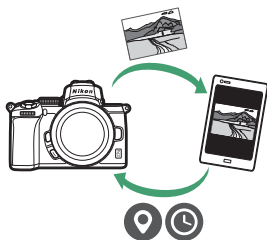

*Bluetooth*

## Connecting via Wi-Fi (Wi-Fi Mode)

Follow the steps below to connect to the camera via Wi-Fi.



### ✔ Before Connecting

Before connecting, enable Wi-Fi on the smart device (for details, see the documentation provided with the device), check that there is space available on the camera memory card, and ensure that the batteries in the camera and smart device are fully charged to prevent the devices turning off unexpectedly.

## 1 Smart device: Launch the SnapBridge app.

*If this is the first time you have launched the app, tap **Connect to camera** and proceed to Step 2.*



If you have launched the app before, open the  tab and tap  > **Wi-Fi mode** before proceeding to Step 3.

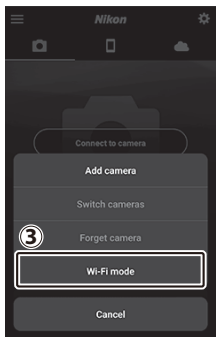

## 2 Smart device: Choose the camera and connection type.

When prompted to choose the camera type, tap **mirrorless camera** and then tap **Wi-Fi connection**.



### 3 Camera/Smart device: Turn the camera on.

The smart device will instruct you to ready the camera. Turn the camera on. Do NOT tap **Next** until you have completed Step 4.

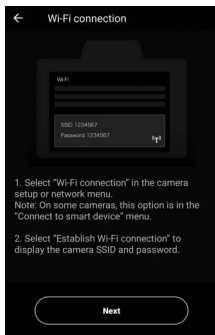

### 4 Camera: Enable Wi-Fi.

Select **Connect to smart device** > **Wi-Fi connection** in the setup menu, then highlight **Establish Wi-Fi connection** and press **OK**.



The camera SSID and password will be displayed.



#### ✓ Enabling Wi-Fi

You can also enable Wi-Fi by selecting **Wi-Fi connection** > **Establish Wi-Fi conn. with smart device** in the **i** menu for shooting mode.

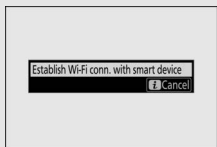

## 5 Smart device: Tap **Next**.

Tap **Next** once you have enabled Wi-Fi on the camera as described in the preceding step.

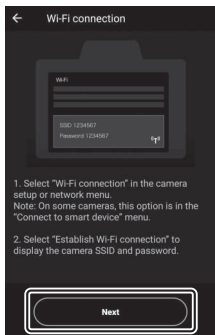

## 6 Smart device: Tap **View options**.

After reading the instructions displayed by the smart device, tap **Open the device settings app**.

- **Android devices:** Wi-Fi settings will be displayed.
- **iOS devices:** The "Settings" app will launch. Tap < **Settings** to open the "Settings" app. Next, scroll up and tap **Wi-Fi**, which you'll find near the top of the settings list.

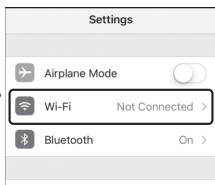
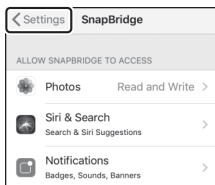



## 7 Smart device: Enter the camera SSID and password.

Enter the SSID and password displayed by the camera in Step 4.

*Android device  
(actual displays  
may differ)*

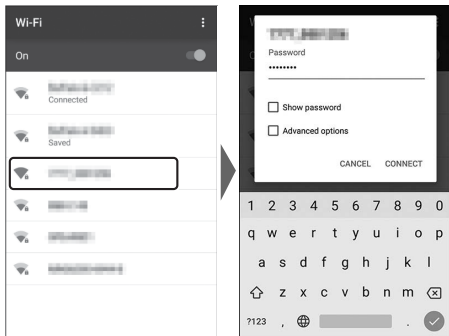

*iOS device  
(actual displays  
may differ)*

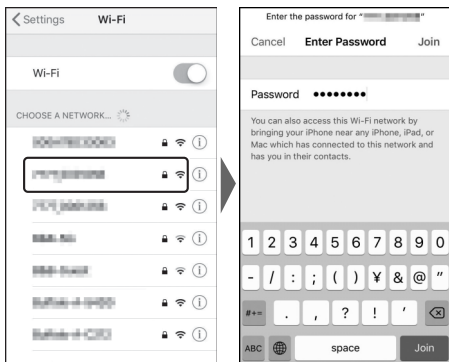



You will not be required to enter the password when next you connect to the camera.

## 8 Smart device: Return to the SnapBridge app.

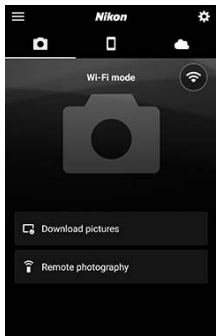
After a Wi-Fi connection is established, Wi-Fi mode options will be displayed. See online help for information on using the SnapBridge app.



### ✓ Ending Wi-Fi Connections

To end the Wi-Fi connection, tap . When the icon changes to , tap  and select **Exit Wi-Fi mode**.

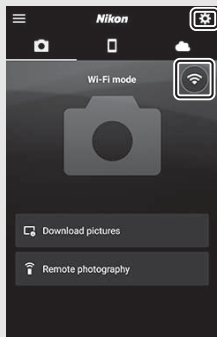

## Connecting via Bluetooth

For information on pairing the camera and smart device when connecting for the first time, see “Connecting for the First Time: Pairing”, below. For information on connecting once pairing is complete, see “Connecting to a Paired Device” (📖 389).

### ■ **Connecting for the First Time: Pairing**

Before connecting via Bluetooth for the first time, you will need to pair the camera and smart device as described below. See “Android”, below, if you are using an Android device, or “iOS” (📖 383) for information on pairing with iOS devices.

#### ✔ **Before Pairing**

Before beginning pairing, enable Bluetooth on the smart device (for details, see the documentation provided with the device), check that there is space available on the camera memory card, and ensure that the batteries in the camera and smart device are fully charged to prevent the devices turning off unexpectedly.

#### **Android**

Follow the steps below to pair the camera with an Android device.

### **1** **Camera: Ready the camera.**

Select **Connect to smart device** > **Pairing (Bluetooth)** in the setup menu, then highlight **Start pairing** and press Ⓞ...

...to display the camera name.

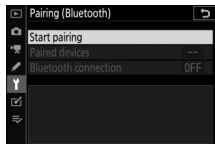

## 2 Android device: Launch the SnapBridge app.

If this is the first time you have launched the app, tap **Connect to camera** and proceed to Step 3.



If you have launched the app before, open the  tab and tap **Connect to camera**.

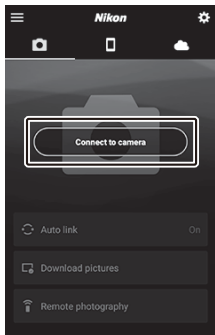

---

### 3 Android device: Tap mirrorless camera to display connection options and then tap Pairing (Bluetooth).

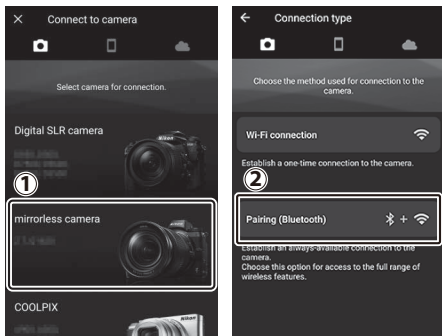

**Note:** This step will not be required the next time the devices are paired.

**Note:** You must enable location services when using Bluetooth. Be sure to grant location access if prompted.

---

### 4 Android device: Choose the camera.

Tap the camera name.

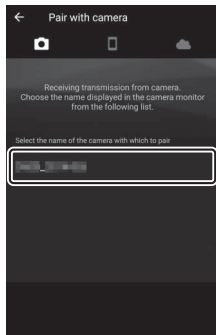

## 5 Camera/Android device: Check the authentication code.

Confirm that the camera and Android device display the same authentication code (circled in the illustration).

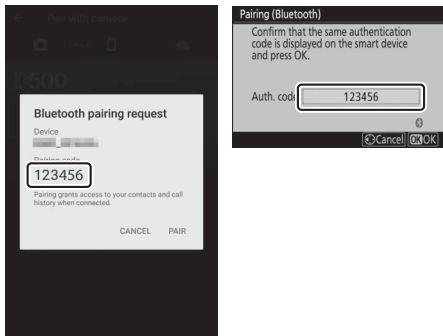

## 6 Camera/Android device: Initiate pairing.

**Camera:** Press **OK**.

**Android device:** Tap the button indicated in the illustration (the label may differ depending on the version of Android you are using).

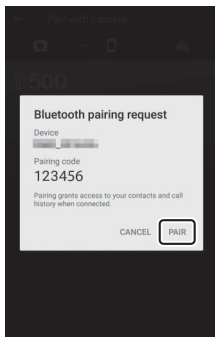
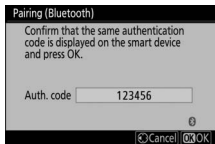

### ✔ Pairing Error

If you wait too long between pressing the button on the camera and tapping the button on the Android device, pairing will fail and an error will be displayed.

- **Camera:** Press **OK** and return to Step 1.
- **Android device:** Tap **OK** and return to Step 2.

## 7 Camera/Android device: Follow the on-screen instructions.

**Camera:** Press **OK**. The camera will display a message stating that the devices are connected.



**Android device:** Pairing is complete. Tap **OK** to exit to the  tab.

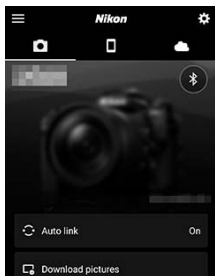
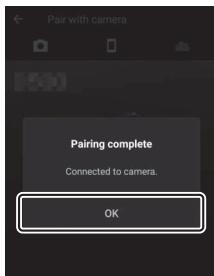

### ✓ Pairing for the First Time

The first time you pair the Android device with a camera after installing the SnapBridge app, you will be prompted to select auto link (auto upload and auto clock and location synchronization) options. This prompt will not appear again, but auto link settings can be accessed at any time using **Auto link** in the  tab.

Pairing is now complete. The next time you use the SnapBridge app, you can connect as described in “Connecting to a Paired Device” (📖 389).

### ✓ Ending Bluetooth Connections

To end the connection to the smart device, select **Disable** for **Connect to smart device > Pairing (Bluetooth) > Bluetooth connection** in the camera setup menu.



Follow the steps below to pair the camera with an iOS device. For information on Android devices, see “Android” (📖 377).

## 1 Camera: Ready the camera.

Select **Connect to smart device** > **Pairing (Bluetooth)** in the setup menu, then highlight **Start pairing** and press ⓄK...

...to display the camera name.

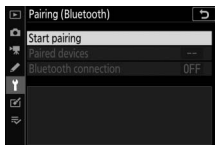

## 2 iOS device: Launch the SnapBridge app.

If this is the first time you have launched the app, tap **Connect to camera** and proceed to Step 3.

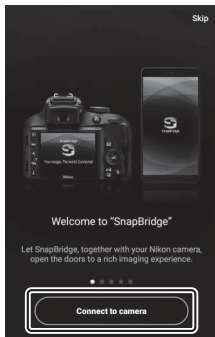

If you have launched the app before, open the  tab and tap **Connect to camera**.

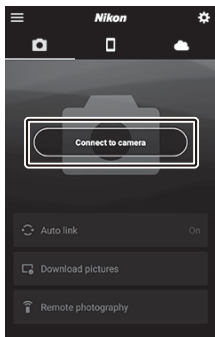

### 3 iOS device: Tap **mirrorless camera** to display connection options and then tap **Pairing (Bluetooth)**.

This step can be omitted once the devices have been paired.

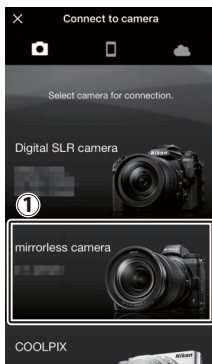

---

## 4 iOS device: Choose the camera.

Tap the camera name.

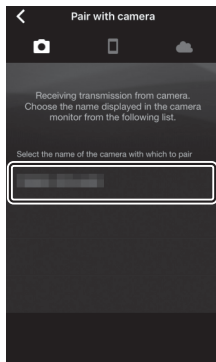

---

## 5 iOS device: Read the instructions.

Read the pairing instructions carefully and tap **Understood**.

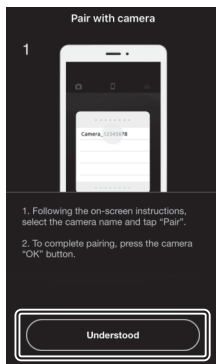

---

**6 iOS device: Select an accessory.**

When prompted to select an accessory, tap the camera name again.

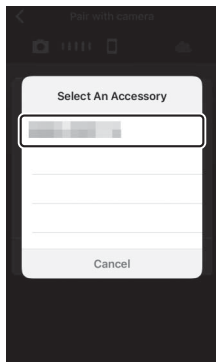

## 7 Camera/iOS device: Initiate pairing.

**Camera:** Press .

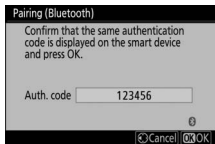

**iOS device:** Tap the button indicated in the illustration (the label may differ depending on the version of iOS you are using).

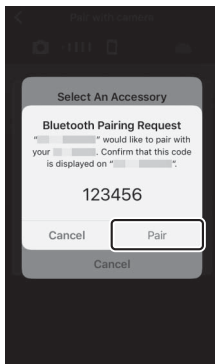

### Pairing Error

If you wait too long between pressing the button on the camera and tapping the button on the iOS device, pairing will fail and an error will be displayed.

- **Camera:** Press  and return to Step 1.
- **iOS device:** Dismiss the SnapBridge app and check that it is not running in the background, then open the iOS "Settings" app and request iOS to "forget" the camera as shown in the illustration before returning to Step 1.



## 8 Camera/iOS device: Follow the on-screen instructions.

**Camera:** Press **OK**. The camera will display a message stating that the devices are connected.



**iOS device:** Pairing is complete. Tap **OK** to exit to the  tab.

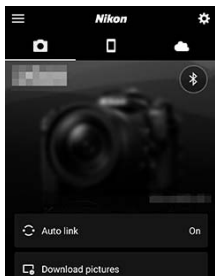
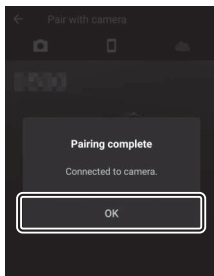

### ✓ Pairing for the First Time

The first time you pair the iOS device with a camera after installing the SnapBridge app, you will be prompted to select auto link (auto upload and auto clock and location synchronization) options. This prompt will not appear again, but auto link settings can be accessed at any time using **Auto link** in the  tab.

Pairing is now complete. The next time you use the SnapBridge app, you can connect as described in “Connecting to a Paired Device” (📖 389).

### ✓ Ending Bluetooth Connections

To end the connection to the smart device, select **Disable** for **Connect to smart device > Pairing (Bluetooth) > Bluetooth connection** in the camera setup menu.

## ■ ■ Connecting to a Paired Device

Connecting to a smart device that has already been paired with the camera is quick and easy.

---

### 1 Camera: Enable Bluetooth.

In the setup menu, select **Connect to smart device > Pairing (Bluetooth) > Bluetooth connection**, then highlight **Enable** and press **OK**.

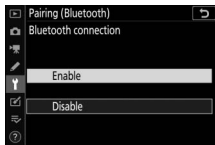

### 2 Smart device: Launch the SnapBridge app.

A Bluetooth connection will be established automatically.

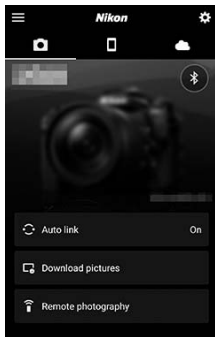

## Troubleshooting

Solutions to some common issues are listed below.

Troubleshooting information for the SnapBridge app can be found in the app's online help, which can be viewed at: <https://nikonimglib.com/snbr/onlinehelp/en/index.html>

For information on the Wireless Transmitter Utility or Camera Control Pro 2, see the online help for the application in question.

Problem	Solution	
The camera displays a TCP/IP error.	Check settings for the host computer or wireless router and adjust camera settings appropriately.	321
The camera displays a "no memory card" error.	Confirm that the memory card is correctly inserted.	32
Upload is interrupted and fails to resume.	Upload will resume if the camera is turned off and then on again.	364
The connection is unreliable.	If <b>Auto</b> is selected for <b>Channel</b> , choose <b>Manual</b> and select the channel manually.	319
	If the camera is connected to a computer in infrastructure mode, check that the router is set to a channel between 1 and 8.	321



# Connecting to Other Devices

Expand your photographic horizons by connecting the camera to other devices via USB or HDMI.

## Connecting to Computers Via USB

If the supplied USB cable is used to connect the camera to a computer running NX Studio, you can copy pictures to the computer, where they can be viewed, edited, and organized. For information on establishing wireless connections to computers, see “Connecting to Computers via Wi-Fi” (📖 351) in “Establishing Wireless Connections to Computers or Smart Devices”.

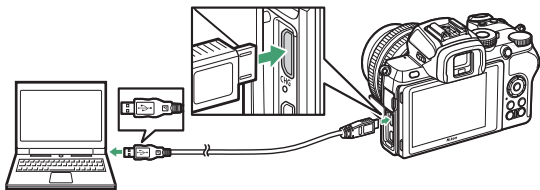

## **Installing NX Studio**

You will need an Internet connection when installing NX Studio. Visit the Nikon website for the latest information, including system requirements.

- Download the latest NX Studio installer from the website below and follow the on-screen instructions to complete installation.

*<https://downloadcenter.nikonimglib.com/>*

- Note that you may be unable to download pictures from the camera using earlier versions of NX Studio.

## **Copying Pictures to a Computer Using NX Studio**

See online help for detailed instructions.

---

### **1 Connect the camera to the computer.**

After turning the camera off and ensuring that a memory card is inserted, connect the supplied USB cable as shown.

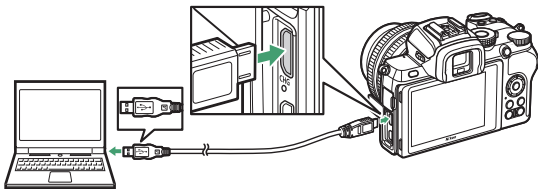

#### **✔ Using a Card Reader**

Pictures can also be copied from a memory card inserted in a third-party card reader. You should however check that the card is compatible with the card reader.

### **2 Turn the camera on.**

- The Nikon Transfer 2 component of NX Studio will start. Nikon Transfer 2 image transfer software is installed as part of NX Studio.
- If a message is displayed prompting you to choose a program, select Nikon Transfer 2.
- If Nikon Transfer 2 does not start automatically, launch NX Studio and click the “Import” icon.

- 3 Click Start Transfer.**  
Pictures on the memory card will be copied to the computer.

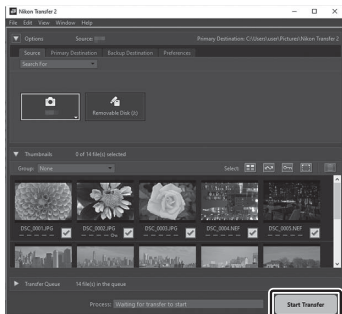

- 4 Turn the camera off.**  
Disconnect the USB cable when transfer is complete.

**✓ Windows 10 and Windows 8.1**

Windows 10 and Windows 8.1 may display an AutoPlay prompt when the camera is connected.

Click the dialog and then click **Nikon Transfer 2** to select Nikon Transfer 2.

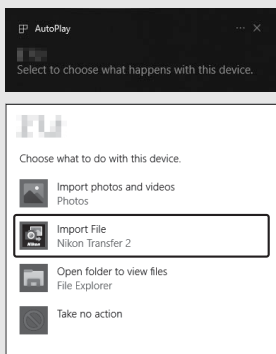

### ✔ macOS

If Nikon Transfer 2 does not start automatically, confirm that the camera is connected and then launch Image Capture (an application that comes with macOS) and select Nikon Transfer 2 as the application that opens when the camera is detected.

### ✔ Caution: Transferring Videos

Do not attempt to transfer videos from the memory card while it is inserted in a camera of a different make or model. Doing so could result in the videos being deleted without being transferred.

### ✔ Cautions: Connecting to Computers

- Do not turn the camera off or disconnect the USB cable while transfer is in progress.
- Do not use force or attempt to insert the connectors at an angle. Be sure also to keep the connectors straight when disconnecting the cable.
- Always turn the camera off before connecting or disconnecting a cable.
- To ensure that data transfer is not interrupted, be sure the camera battery is fully charged.

### ✔ USB Hubs

Connect the camera directly to the computer; do not connect the cable via a USB hub or keyboard. Connect the camera to a pre-installed USB port.

## Connecting to Printers

Selected JPEG images can be printed on a PictBridge printer connected directly to the camera using the supplied USB cable. When connecting the cable, do not use force or attempt to insert the connectors at an angle.

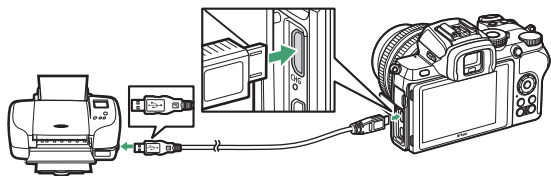

When the camera and printer are turned on, a welcome screen will be displayed, followed by a PictBridge playback display.

### ✔ Selecting Photographs for Printing

Images created at image quality settings of NEF (RAW) cannot be selected for printing. JPEG copies of NEF (RAW) images can be created using the **NEF (RAW) processing** option in the retouch menu.

### ✔ Printing Via Direct USB Connection

Be sure the battery is fully charged. When taking photographs to be printed via direct USB connection, set **Color space** to **sRGB**.

### ✔ USB Hubs

Operation is not guaranteed if the camera and printer are connected via a USB hub.







### ✔ See Also

See “Error Messages” (📖 419) for information on what to do if an error occurs during printing.

## Printing Pictures One at a Time





---







### 1 Display the desired picture.

Press  or  to view additional pictures. Tap the  button to zoom in on the current frame (press  to exit zoom). To view six pictures at a time, tap the /? button. Use the multi selector to highlight pictures, or tap the  button to display the highlighted picture full frame.

---

### 2 Adjust printing options.

Press  to display the following items, then press  or  to highlight an item and press  to view options (only options supported by the current printer are listed; to use the default option, select **Printer default**). After selecting an option, press  to return to the printer settings menu.

- **Page size:** Choose a page size.
- **No. of copies:** This option is listed only when pictures are printed one at a time. Press  or  to choose number of copies (maximum 99).
- **Border:** Choose whether to frame photos in white borders.
- **Print date:** Choose whether to print the dates of recording on photos.
- **Cropping:** This option is listed only when pictures are printed one at a time. To exit without cropping, highlight **No cropping** and press . To crop the current picture, highlight **Crop** and press . A crop selection dialog will be displayed; tap  to increase the size of the crop, /? to decrease, and use the multi selector to position the crop. Note that print quality may drop if small crops are printed at large sizes.

---

### 3 Start printing.

Select **Start printing** and press **OK** to start printing. To cancel printing before all copies have been printed, press **OK**.

## Printing Multiple Pictures

---

### 1 Display the PictBridge menu.

Press the **MENU** button in the PictBridge playback display.

### 2 Choose an option.

Highlight one of the following options and press **Enter**.

- **Print select:** Select pictures for printing. Press **Left** or **Right** to scroll through pictures (to view the highlighted picture full screen, touch and hold the **Q** button) and press **Up** or **Down** to choose the number of prints. To deselect a picture, set the number of prints to zero.
- **Index print:** Create an index print of all JPEG pictures on the memory card. Note that if the memory card contains more than 256 pictures, only the first 256 images will be printed. A warning will be displayed if the page size selected in Step 3 is too small for an index print.

### 3 Adjust printing options.

Adjust printer settings as described in Step 2 of "Printing Pictures One at a Time" (□ 397).

### 4 Start printing.

Select **Start printing** and press **OK** to start printing. To cancel printing before all copies have been printed, press **OK**.



## Connecting to HDMI Devices

The camera can be connected to high-definition video devices using a third-party HDMI cable (type D). Always turn the camera off before connecting or disconnecting an HDMI cable.

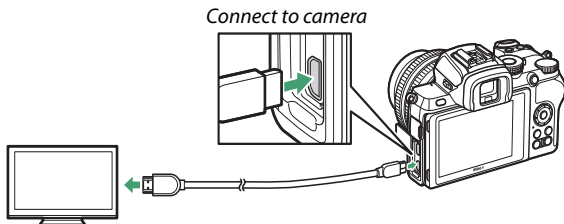

*Connect to high-definition device  
(choose cable with connector for  
HDMI device)*

### ■ ■ Connecting to HDMI TVs

After connecting the camera to an HDMI television or other display, tune the device to the HDMI channel, then turn the camera on and press the  button. During playback, images will be displayed on the television screen. Volume can be adjusted using television controls; the camera controls cannot be used.

## Connecting to Other HDMI Devices

Use the **HDMI** option in the setup menu to adjust settings for HDMI output.

- **Output Resolution:** Choose the format for images output to the HDMI device. If **Auto** is selected, the camera will automatically select the appropriate format.
- **Output range:** **Auto** is recommended in most situations. If the camera is unable to determine the correct RGB video signal output range for the HDMI device, you can choose **Limited range** for devices with an RGB video signal input range of 16 to 235 or **Full range** for devices with an RGB video signal input range of 0 to 255. Choose **Limited range** if you notice a loss of detail in shadows, **Full range** if shadows are “washed out” or too bright.



### **HDMI Output**

HDMI output is not available while movies are being recorded at movie frame sizes of 1920 × 1080 120p, 1920 × 1080 100p, or 1920 × 1080 slow-motion or when the camera is connected to a computer running Camera Control Pro 2.

# On-Camera Flash Photography

## “On-Camera” Versus “Remote”

You can take pictures using a flash unit mounted on the camera accessory shoe or one or more remote flash units.

### Camera-Mounted Flash Units

Take pictures using a flash unit mounted on the camera as described in “Using an On-Camera Flash” (📖 402).



### Remote Flash Photography

Take pictures with one or more remote flash units using wireless flash control (Advanced Wireless Lighting, or AWL) as described in “Remote Flash Photography” (📖 405).

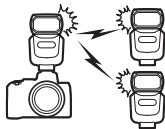

## Using an On-Camera Flash

Follow the steps below to mount an optional flash unit on the camera and take photographs using the flash.

---

### 1 Mount the unit on the accessory shoe.

See the manual provided with the unit for details.

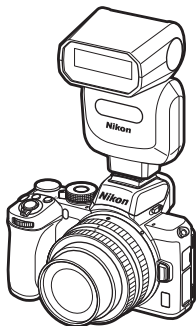

### 2 Turn on the camera and flash unit.

The flash will begin charging; the flash-ready indicator (⚡) will be displayed when charging is complete.

---

### 3 Adjust flash settings.

Choose the flash control mode (☐ 404) and flash mode (☐ 130).

---

### 4 Adjust shutter speed and aperture.

### 5 Take pictures.

### ✔ **Third-Party Flash Units**

The camera cannot be used with flash units that would apply voltages over 250 V to the camera's X contacts or short-circuit contacts on the accessory shoe. Use of such flash units could not only interfere with normal operation of the camera but also damage the flash sync circuits of the camera and/or flash.

### ✔ **i-TTL Flash Control**

When an optional flash unit that supports the Nikon Creative Lighting System is mounted on the camera and set to TTL, it will operate in i-TTL mode, employing monitor preflashes for flash photography using i-TTL balanced fill-flash and the like. i-TTL flash control is not available with flash units that do not support the Nikon Creative Lighting System.

### ✔ **Studio Strobe Lighting**

Rear-curtain sync cannot be used with large studio strobe lighting units, as they will not sync correctly.

## Flash Control Mode

When an SB-500, SB-400, or SB-300 flash unit is mounted on the camera, the **Flash control mode (built-in)** option displayed when **Flash control** is selected in the photo shooting menu is replaced by **Flash control mode (external)**.

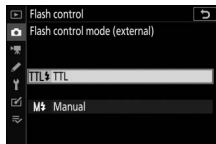

In modes **P**, **S**, **A**, and **M**, this option can be used to choose the flash control mode and adjust the flash level and other flash settings. Settings for other flash units can only be adjusted using flash unit controls.

- **TTL**: Flash output is adjusted automatically in response to shooting conditions.
- **Manual**: Choose the flash level (**Manual output amount**) manually.

# Remote Flash Photography

## About Remote Flash Photography

The camera can be used with one or more remote flash units (Advanced Wireless Lighting, or AWL). For information on using a flash unit mounted on the camera accessory shoe, see “On-Camera Flash Photography” (📖 401).

Throughout this chapter, operations involving an accessory connected to the camera are indicated by 📷, operations involving remote flash units by 📷. For more information on 📷, see the manual provided with the flash unit.

## Controlling Remote Flash Units

Remote flash units can be controlled via optical signals from an optional flash unit mounted on the camera accessory shoe and functioning as a master flash (optical AWL). For information on compatible flash units, see

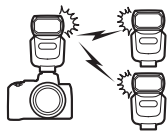

“The Nikon Creative Lighting System” (□ 432). If the flash unit in question is an SB-500, settings can be adjusted from the camera (see below); otherwise settings must be adjusted using flash unit controls as described in the documentation provided with the unit. For information on flash placement and other topics, see the documentation provided with the flash units. The built-in flash unit cannot be used as a master flash.

### Using the SB-500

When an optional SB-500 flash unit is mounted on the camera accessory shoe, **Wireless flash options** will appear under **Flash control** in the photo shooting menu. Selecting **Optical AWL** in the **Wireless flash options** menu enables group flash photography.

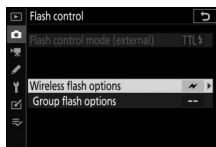

#### 1 Select Group flash options.

Highlight **Group flash options** in the flash control display and press .

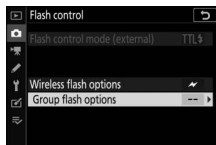



---

## 2 : Adjust settings for the master flash.

Choose the flash control mode and flash level for the master flash and the flash units in each group:

- **TTL**: i-TTL flash control
- **A**: Auto aperture (available only with compatible flash units)
- **M**: Choose the flash level manually
- **-- (off)**: The units do not fire and the flash level cannot be adjusted

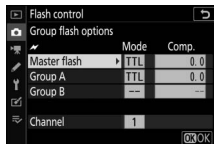

Set the master flash to channel 3.

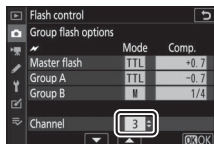

---

## 3 : Set the remote flash units to channel 3.

---

## 4 : Group the remote flash units.

Choose a group (A or B) for each remote flash unit. Although there is no limit on the number of remote flash units that may be used, the practical maximum is three per group. With more than this number, the light emitted by the remote flash units will interfere with performance.

---

## 5 : Compose the shot.

Compose the shot and arrange the flash units. See the documentation provided with the flash units for more information. After arranging the units, press the test button on the master flash to test-fire the flash and confirm that the units are functioning normally.

---

## 6 : Take the photograph.

Take the photograph after confirming that the flash-ready lights for all flash units are lit.

### **Note: Remote Flash Photography**

Position the sensor windows on the remote flash units to pick up the light from the master flash (particular care is required if the camera is not mounted on a tripod). Be sure that direct light or strong reflections from the remote flash units do not enter the camera lens (in TTL mode) or the photocells on the remote flash units (⊗A mode), as this may interfere with exposure. To prevent low-intensity timing flashes emitted by the master flash from appearing in photographs taken at short range, choose low ISO sensitivities or small apertures (high f-numbers). After positioning the remote flash units, take a test shot and view the results in the camera display.

# Troubleshooting

## Before Contacting Customer Support

You may be able to resolve any issues with the camera by following the steps below. Check this list before consulting your retailer or Nikon-authorized service representative.

**STEP 1**

*Check the common problems listed in the following sections:*

- “Problems and Solutions” (□ 410)
- “Indicators and Error Messages” (□ 417)

**STEP 2**

*Turn the camera off and remove the battery. After waiting for about a minute, re-insert the battery and turn the camera on.*

- ✓ If you have just finished shooting, wait at least a minute before removing the battery, as the camera may still be writing data to the memory card.

**STEP 3**

*Search Nikon websites.*

For support information and answers to frequently asked questions, visit the website for your country or region (□ xxix). To download the latest firmware for your camera, visit:  
<https://downloadcenter.nikonimglib.com>

**STEP 4**

*Consult a Nikon-authorized service representative.*

### ✓ Restoring Default Settings

Depending on current settings, some menu items and other features may be unavailable. To access menu items that are grayed out or features that are otherwise unavailable, try restoring default settings using the **Reset all settings** item in the setup menu (□ 326). Note, however, that wireless network profiles, copyright information, and other user-generated entries will also be reset. Once reset, settings cannot be restored.

## Problems and Solutions

Solutions to some common issues are listed below.

### **Battery/Display**

---

**The camera is on but does not respond:** Wait for recording to end. If the problem persists, turn the camera off. If the camera does not turn off, remove and reinsert the battery. Note that although any data currently being recorded will be lost, data that have already been recorded will not be affected by removing the battery.

---

**The camera takes time to turn off:** The camera is performing an image sensor check. Do not remove the battery until the camera has turned off.

---

**The viewfinder or monitor does not turn on:**

- Choose a different monitor mode using the monitor mode button.
- Dust, lint, or other foreign matter on the eye sensor may prevent it functioning normally. Clean the eye sensor with a blower.

---

**The viewfinder is out of focus:** Rotate the diopter adjustment control to focus the viewfinder. If this does not correct the problem, select **AF-S**, single-point AF, and the center focus point, and then frame a high-contrast subject in the center focus point and press the shutter-release button halfway to focus the camera. With the camera in focus, use the diopter adjustment control to bring the subject into clear focus in the viewfinder.

---

**The displays turn off without warning:** Choose longer delays for Custom Setting c3 (**Power off delay**).

---

## Shooting

---

**The camera takes time to turn on:** Delete files or folders.

---

**The shutter-release is disabled:**

- The memory card is full.
  - The memory card is write-protected (“locked”).
  - Mode **S** selected after **Bulb** or **Time** is chosen for shutter speed in mode **M**.
  - **Release locked** is selected for **Slot empty release lock** in the setup menu and no memory card is inserted.
- 

**The camera is slow to respond to the shutter-release button:** Select **Off** for Custom Setting d3 (**Exposure delay mode**).

---

**Only one shot is taken each time the shutter-release button is pressed in continuous release modes:**

- Turn HDR off.
  - If the built-in flash is used with continuous low-speed or continuous high-speed selected for release mode, only one picture will be taken each time the shutter-release button is pressed. Selecting continuous high-speed (extended) enables burst photography and disables the built-in flash.
- 

**Photos are out of focus:** To focus using autofocus, select **AF-A**, **AF-S**, **AF-C**, or **AF-F** for focus mode. If the camera is unable to focus using autofocus (□ 53), use manual focus or focus lock.

---

**Beeps do not sound if:**

- **Off** is selected for **Beep options** > **Beep on/off** in the setup menu.
  - **AF-C** is selected for focus mode or **AF-A** is selected and the camera is shooting using **AF-C**.
  - **On** is selected for **Silent photography** in the photo shooting menu.
  - The camera is in movie mode.
-

---

**The full range of shutter speeds is not available:** A flash in use. Flash sync speed can be selected using Custom Setting e1 (**Flash sync speed**); when using compatible flash units, choose **1/200 s (Auto FP)** to access the full range of shutter speeds.

---

**Focus does not lock when the shutter-release button is pressed halfway:** When **AF-C** is selected for focus mode or **AF-A** is selected and the camera is shooting using **AF-C**, focus can be locked by pressing the  $\frac{\text{AF-ON}}{\text{AF-L}} (\text{O-n})$  button.

---

**The focus point cannot be changed:** Focus-point selection is unavailable in auto-area AF; choose another AF-area mode.

---

**The camera is slow to record photos:** Turn long exposure noise reduction off.

---

**Photographs and movies do not appear to have the same exposure as the preview shown in the display:** To preview the effects of changes to settings that affect exposure and color, select **On** for Custom Setting d7 (**Apply settings to live view**). Note that changes to **Monitor brightness** and **Viewfinder brightness** have no effect on images recorded with the camera.

---

**Flicker or banding appears in movie mode:** Select **Flicker reduction** in the movie shooting menu and choose an option that matches the frequency of the local AC power supply.

---

**Bright regions or bands appear in the view through the lens:** The shot is being framed under flashing sign, flash, or other light source with brief duration.

---

**Smudges appear in photographs:** Clean the front and rear lens elements. If the problem persists, clean the image sensor as described in “Cleaning the Image Sensor” (□ 444) or consult a Nikon-authorized service representative.

---

---

**Bokeh is irregular:** With fast shutter speeds and/or fast lenses, you may notice irregularities in how *bokeh* is shaped. The effect can be mitigated by choosing slower shutter speeds and/or higher f-numbers.

---

**Pictures are affected by noticeable ghosting or flare:** You may notice ghosting or flare in shots that include the sun or other bright light sources. These effects can be mitigated by attaching a lens hood or by composing shots with bright light sources well out of the frame. You can also try such techniques as removing lens filters, choosing a different shutter speed, or using silent photography.

---

**Shooting ends unexpectedly or does not start:** Shooting may end automatically to prevent damage to the camera's internal circuits if the ambient temperature is high or the camera has been used extensively for burst shooting, movie recording, or the like. If you are unable to shoot because the camera has overheated, wait for the internal circuits to cool and then try again. Note that the camera may feel warm to the touch, but this does not indicate a malfunction.

---

**Image artifacts appear in the display during shooting:** "Noise" (randomly-spaced bright pixels, fog, or lines) and unexpected colors may appear if you zoom in on the view through the lens. Randomly-spaced bright pixels, fog, or bright spots may also arise as a result of increases in the temperature of the camera's internal circuits during shooting; turn the camera off when it is not in use. At high ISO sensitivities, noise may become more noticeable in long exposures or in pictures recorded when the camera temperature is elevated. Note that the distribution of noise in the display may differ from that in the final picture. To reduce noise, adjust settings such as ISO sensitivity, shutter speed, or Active D-Lighting.

---

**The camera cannot measure white balance:** The subject is too dark or too bright.

---

**Images cannot be selected as source for preset white balance:** The images in question were created with a different model of camera.

---

**White balance bracketing is unavailable:**

- An NEF (RAW) or NEF+JPEG image quality option is selected for image quality.
  - Multiple exposure or HDR (high dynamic range) photography is on.
-

---

**The effects of Picture Controls differ from image to image:** **Auto** is selected for **Set Picture Control**, a Picture Control based on **Auto** is selected, or **A** (auto) is selected for **Quick sharp**, contrast, or saturation. For consistent results over a series of photographs, choose another setting.

---

**Metering cannot be changed:** Autoexposure lock is in effect.

---

**Exposure compensation cannot be used:** In mode **M**, exposure compensation affects only the display in the exposure indicator; shutter speed and aperture are not affected.

---

**Noise (colored splotches or other artifacts) appears in long time-exposures:** Enable long exposure noise reduction.

---

**The AF-assist illuminator does not light:**

- Select **On** for Custom Setting a8 (**Built-in AF-assist illuminator**).
- The illuminator does not light in movie mode.
- The illuminator does not light in the following focus modes: **AF-C** (including when **AF-A** is selected and the camera is shooting using **AF-C**) and **MF**.

---

**Sound is not recorded with movies:**

- **Microphone off** is selected for **Microphone sensitivity** in the movie shooting menu.
  - **Manual** is selected for **Microphone sensitivity** in the movie shooting menu and a low value is selected.
-



## **Playback**

---

**NEF (RAW) images are not played back:** The pictures were taken at image qualities of NEF + JPEG.

---

**The camera does not display pictures recorded with other cameras:** Pictures recorded with other makes of camera may not be displayed correctly.

---

**Some photos are not displayed during playback:** Select **All** for **Playback folder**.

---

**“Tall” (portrait) orientation photos are displayed in “wide” (landscape) orientation:**

- Select **On** for **Rotate tall** in the playback menu.
- The photos are displayed in image review.
- The camera was pointed up or down when photo was taken.

---

**Pictures cannot be deleted:**

- The memory card is write-protected (“locked”).
- The pictures are protected.

---

**Pictures cannot be retouched:** The picture cannot be edited with this camera.

---

**The camera displays a message stating that the folder contains no images:** Select **All** for **Playback folder**.

---

**Pictures cannot be printed:** NEF (RAW) photos cannot be printed by direct USB connection. Transfer the photos to a computer and print them using NX Studio. NEF (RAW) photos can be saved in JPEG format using the **NEF (RAW) processing** option in the retouch menu.

---

**Pictures are not displayed on HDMI devices:** Confirm that an HDMI cable (available separately) is connected.

---

**Output to HDMI devices does not function as expected:**

- Check that the HDMI cable is correctly connected.
- Check again after selecting **Reset all settings** in the setup menu.

---

**Computers do not display NEF (RAW) images the same way as the camera does:** Third-party software does not display effects of Picture Controls, Active D-Lighting, vignette control, or the like. Use NX Studio.

---

**Pictures cannot be transferred to a computer:** The computer operating system is not compatible with the camera or image transfer software. Use a card reader or card slot to copy the pictures to a computer.

---

## **Bluetooth and Wi-Fi (Wireless Networks)**

---

**Smart devices do not display the camera SSID (network name):**

- Confirm that **Disable** is selected for **Airplane mode** in the camera setup menu.
  - Confirm that **Enable** is selected for **Connect to smart device > Pairing (Bluetooth) > Bluetooth connection** in the camera setup menu.
  - Confirm that Wi-Fi has been enabled using the **Connect to smart device > Wi-Fi connection** option in the setup menu.
  - Try turning the smart device Wi-Fi off and then on again.
- 

**The camera cannot connect to wireless printers and other wireless devices:** This camera can connect only to computers and smart devices.

---

## **Miscellaneous**

---

**The date of recording is not correct:** The camera clock is less accurate than most watches and household clocks. Check the clock regularly against more accurate timepieces and reset as necessary.

---

**Some menu items cannot be selected:** Some options are not available at certain combinations of settings or when no memory card is inserted.

---

**The camera does not respond to the ML-L7 remote control:**

- The optional ML-L7 remote control has not established a connection to the camera. Press the power button on the remote control. If  does not appear in the camera shooting display, pair the camera with the remote control again.
  - Confirm that **Enable** is selected for **Wireless remote (ML-L7) options > Wireless remote connection** in the setup menu.
  - In the setup menu, confirm that: **Disable** is selected for **Airplane mode**, **Disable** is selected for **Connect to smart device > Pairing (Bluetooth) > Bluetooth connection**, and **Disable** is selected for **Connect to PC > Wi-Fi connection**.
- 

**The camera cannot be paired with the ML-L7 remote control:** Confirm that **Disable** is selected for **Airplane mode** in the setup menu.



---

## Indicators and Error Messages

This section lists the indicators and error messages that appear in the camera display.

### Indicators

The following indicators appear in the camera display:

Indicator	Problem	Solution
	Low battery.	Ready a fully-charged spare battery.
F--	Lens is not correctly attached.	Ensure that the lens is correctly attached and that retractable lenses are extended. This indicator is also displayed when a non-CPU lens is attached via a mount adapter, but in this case no action need be taken.
<b>Bulb</b> (flashes)	<b>Bulb</b> selected in mode <b>S</b> .	Change shutter speed or select mode <b>M</b> .
<b>Time</b> (flashes)	<b>Time</b> selected in mode <b>S</b> .	
 (flashes)	Built-in or optional flash has fired full power; photo may be underexposed.	Check photo in display; if underexposed, adjust settings and try again.
	Subjects appear dark and underexposed.	Use built-in or optional flash.

Indicator	Problem	Solution
(Exposure indicators and shutter speed or aperture display flash)	Subject too bright; photo will be overexposed.	<ul style="list-style-type: none"> <li>• Decrease ISO sensitivity.</li> <li>• Use optional ND filter. In mode:  <b>S</b> Increase shutter speed  <b>A</b> Choose a smaller aperture (higher f-number)</li> <li>•  Choose another shooting mode</li> </ul>
	Subject too dark; photo will be underexposed.	<ul style="list-style-type: none"> <li>• Increase ISO sensitivity.</li> <li>• Use built-in or optional flash. In mode:  <b>S</b> Lower shutter speed  <b>A</b> Choose larger aperture (lower f-number)</li> </ul>
<b>Full</b> (flashes)	Memory insufficient to record further pictures at current settings, or camera has run out of file or folder numbers.	<ul style="list-style-type: none"> <li>• Reduce quality or size.</li> <li>• Delete pictures after copying important images to computer or other device.</li> <li>• Insert new memory card.</li> </ul>
<b>Err</b> (flashes)	Camera malfunction.	Release shutter. If error persists or appears frequently, consult Nikon-authorized service representative.

## **Error Messages**

The following error messages may appear in the camera display:

<b>Message</b>	<b>Problem</b>	<b>Solution</b>
<b>Shutter release disabled. Recharge battery.</b>	Battery exhausted.	<ul style="list-style-type: none"><li>• Replace with spare battery.</li><li>• Charge battery.</li></ul>
<b>This battery cannot be used. It does not communicate properly with this camera. To use the camera safely, choose a battery designated for use in this camera.</b>	Battery info not available.	<ul style="list-style-type: none"><li>• Battery cannot be used. Contact Nikon-authorized service representative.</li><li>• Battery level is extremely low; charge battery.</li></ul>
	Battery cannot supply data to camera.	Replace third-party batteries with genuine Nikon batteries.
<b>No memory card.</b>	Camera cannot detect memory card.	Turn camera off and confirm that card is correctly inserted.
<b>Cannot access this memory card. Insert another card.</b>	Error accessing memory card.	<ul style="list-style-type: none"><li>• Use Nikon-approved card.</li><li>• If error persists after card has been repeatedly ejected and reinserted, card may be damaged. Contact retailer or Nikon-authorized service representative.</li></ul>
	Unable to create new folder.	Delete files or insert new memory card after copying important pictures to computer or other device.

Message	Problem	Solution
<b>Memory card is locked. Slide lock to “write” position.</b>	The memory card is write-protected (“locked”).	Slide the lock switch to the “write” position (📖 35).
<b>This card is not formatted. Format the card.</b>	Memory card has not been formatted for use in camera.	Format memory card or insert new memory card.
<b>Recording interrupted. Please wait.</b>	Memory card does not support required movie write speed.	Use card that supports required write speed or change option selected for <b>Frame size/frame rate</b> in movie shooting menu.
<b>The camera is too hot. It cannot be used until it cools. Please wait. Camera will turn itself off.</b>	The internal temperature of the camera is high.	Wait for the internal circuits to cool before resuming shooting.
	High battery temperature.	Remove battery and wait for it to cool.
<b>Folder contains no images.</b>	No viewable pictures on memory card.	Insert memory card containing viewable pictures.
	No viewable pictures in folder(s) selected for playback.	Use <b>Playback folder</b> item in playback menu to select folder containing viewable pictures.
<b>Cannot display this file.</b>	File was edited on computer or does not comply with DCF standards, or file is corrupt.	File cannot be viewed on camera.
<b>Cannot select this file.</b>	Selected picture cannot be retouched.	Pictures created with other devices cannot be retouched.

Message	Problem	Solution
<b>This movie cannot be edited.</b>	Selected movie cannot be edited.	<ul style="list-style-type: none"> <li>• Movies created with other devices cannot be edited.</li> <li>• Movies must be at least two seconds long.</li> </ul>
<b>Check printer.</b>	Printer error.	Check printer. To resume, select <b>Continue</b> (if available)*.
<b>Check paper.</b>	Paper in printer is not of selected size.	Insert paper of correct size and select <b>Continue</b> *.
<b>Paper jam.</b>	Paper is jammed in printer.	Clear jam and select <b>Continue</b> *.
<b>Out of paper.</b>	Printer is out of paper.	Insert paper of selected size and select <b>Continue</b> *.
<b>Check ink supply.</b>	Ink error.	Check ink. To resume, select <b>Continue</b> *.
<b>Out of ink.</b>	Printer is out of ink.	Replace ink and select <b>Continue</b> *.

\* See printer manual for more information.

# Technical Notes

## Compatible Lenses

The camera can be used with all Z mount lenses.

**NIKKOR Z DX 16–50mm f/3.5–6.3 VR**

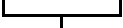
  
*Confirm that the lens name includes "NIKKOR Z".*

### Compatible F Mount Lenses

F mount lenses can be mounted on Z mount cameras using an FTZ mount adapter.

- Some features may not be available depending on the lens used.

Information on the F mount lenses that can be used with Z mount cameras and on any restrictions that may apply can be found in *Compatible F Mount Lenses*, available from the Nikon Download Center: <https://downloadcenter.nikonimglib.com/en/products/491/FTZ.html>



## The Camera Display

Refer to this section for information on the indicators in the camera display (monitor and viewfinder). For illustrative purposes, the displays are shown with all indicators lit.

### The Monitor: Photo Mode

The following indicators appear in the monitor in photo mode.

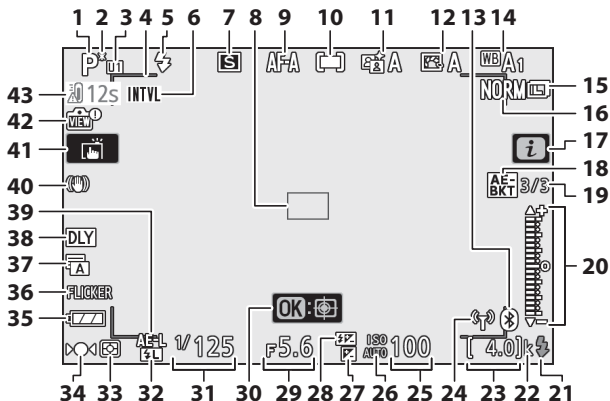

1 Shooting mode .....	75	7 Release mode .....	135
2 Flexible program indicator .....	76	8 Focus point.....	42, 54
3 User setting mode .....	82	9 Focus mode.....	51, 216, 262
4 AF-area brackets .....	54	10 AF-area mode.....	54, 216, 262
5 Flash mode .....	108	11 Active D-Lighting .....	133, 209, 260
6 Interval timer indicator .....	239	12 Picture Control .....	116, 204, 260
"Clock not set" indicator .....	39	13 Bluetooth connection	
"No memory card"		indicator.....	318
indicator .....	32, 35	Airplane mode .....	317

<b>14</b>	White balance .....67, 120, 198, 259	<b>23</b>	Number of exposures remaining .....34, 463
<b>15</b>	Image size..... 128, 194	<b>24</b>	Wi-Fi connection indicator..... 132
<b>16</b>	Image quality ..... 126, 194		Remote-control connection indicator..... 323
<b>17</b>	 icon..... 16, 24	<b>25</b>	ISO sensitivity ..... 100
<b>18</b>	Exposure bracketing indicator ..... 218	<b>26</b>	ISO sensitivity indicator ..... 100
	WB bracketing indicator ..... 222		Auto ISO sensitivity indicator.. 101
	ADL bracketing indicator..... 225	<b>27</b>	Exposure compensation indicator..... 102
	HDR indicator ..... 234	<b>28</b>	Flash compensation indicator.... 111
	Multiple exposure indicator..... 227	<b>29</b>	Aperture .....77
<b>19</b>	Number of shots remaining in exposure bracketing sequence..... 218	<b>30</b>	Subject tracking.....62
	Number of shots remaining in white balance bracketing sequence..... 222	<b>31</b>	Shutter speed..... 76, 78
	Number of shots remaining in ADL bracketing sequence..... 225	<b>32</b>	FV lock indicator ..... 112
	HDR exposure differential ..... 234	<b>33</b>	Metering..... 131, 212, 262
	Number of exposures (multiple exposure) ..... 227	<b>34</b>	Focus indicator.....65
<b>20</b>	Exposure indicator .....79	<b>35</b>	Battery indicator.....34
	Exposure compensation display ..... 102	<b>36</b>	Flicker detection ..... 212
	Bracketing progress indicator: Exposure bracketing..... 218	<b>37</b>	Shutter type..... 279
			Silent photography .....71, 256
<b>21</b>	Flash-ready indicator ..... 435	<b>38</b>	Exposure delay mode..... 278
<b>22</b>	"k" (appears when memory remains for over 1000 exposures) .....34	<b>39</b>	Autoexposure (AE) lock.... 104, 105
		<b>40</b>	Optical VR indicator ..... 139, 216
		<b>41</b>	Touch shooting ..... 12, 63
		<b>42</b>	Live view preview indicator ..... 281
		<b>43</b>	Temperature warning ..... 425

### **Temperature Warnings**

If the camera temperature becomes elevated, a temperature warning will be displayed together with a count-down timer (the timer turns red when the thirty second mark is reached). In some cases, the timer may be displayed immediately after the camera is turned on. When the timer reaches zero, the shooting display will turn off automatically to protect the camera's internal circuits.

## ■ The Information Display

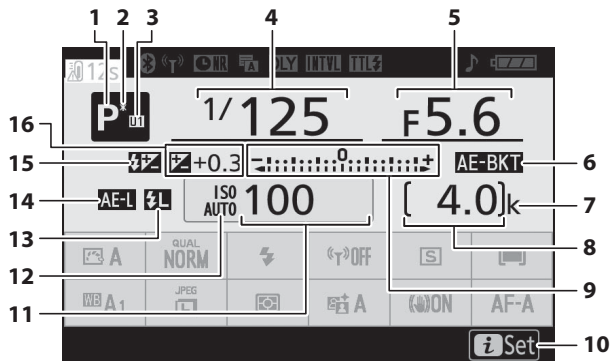

<p><b>1</b> Shooting mode .....75</p> <p><b>2</b> Flexible program indicator .....76</p> <p><b>3</b> User setting mode .....82</p> <p><b>4</b> Shutter speed .....76, 78</p> <p><b>5</b> Aperture .....77</p> <p><b>6</b> Exposure bracketing indicator ..... 218</p> <p>WB bracketing indicator ..... 222</p> <p>ADL bracketing indicator ..... 225</p> <p>HDR indicator ..... 234</p> <p>Multiple exposure indicator ..... 227</p> <p><b>7</b> "k" (appears when memory remains for over 1000 exposures) .....34</p> <p><b>8</b> Number of exposures remaining .....34, 463</p>	<p><b>9</b> Exposure indicator .....79</p> <p>Exposure compensation display ..... 102</p> <p>Bracketing progress indicator:</p> <p>Exposure bracketing ..... 218</p> <p>WB bracketing ..... 222</p> <p>ADL bracketing ..... 225</p> <p><b>10</b> <b>i</b> icon ..... 16, 24</p> <p><b>11</b> ISO sensitivity ..... 100</p> <p><b>12</b> ISO sensitivity indicator ..... 100</p> <p>Auto ISO sensitivity indicator .. 101</p> <p><b>13</b> FV lock indicator ..... 112</p> <p><b>14</b> Autoexposure (AE) lock .... 104, 105</p> <p><b>15</b> Flash compensation indicator .... 111</p> <p><b>16</b> Exposure compensation indicator ..... 102</p> <p>Exposure compensation value ..... 102</p>
---	--

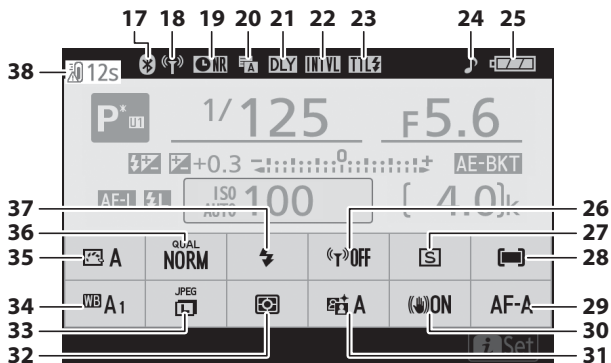

<b>17</b>	Bluetooth connection indicator ..... 318	<b>25</b>	Battery indicator ..... 34
	Airplane mode ..... 317	<b>26</b>	Built-in Wi-Fi ..... 132
<b>18</b>	Wi-Fi connection indicator ..... 132	<b>27</b>	Release mode ..... 135
	Remote-control connection indicator ..... 323	<b>28</b>	AF-area mode ..... 54, 216, 262
<b>19</b>	Long exposure noise reduction indicator ..... 210	<b>29</b>	Focus mode ..... 51, 216, 262
<b>20</b>	Shutter type ..... 279	<b>30</b>	Optical VR ..... 139, 216
	Silent photography ..... 71, 256	<b>31</b>	Active D-Lighting ..... 133, 209, 260
<b>21</b>	Exposure delay mode ..... 278	<b>32</b>	Metering ..... 131, 212, 262
<b>22</b>	Interval timer indicator ..... 239	<b>33</b>	Image size ..... 128, 194
	"Clock not set" indicator ..... 39	<b>34</b>	White balance ..... 67, 120, 198, 259
<b>23</b>	Flash control mode ..... 213	<b>35</b>	Picture Control ..... 116, 204, 260
<b>24</b>	"Beep" indicator ..... 316	<b>36</b>	Image quality ..... 126, 194
		<b>37</b>	Flash mode ..... 108
		<b>38</b>	Temperature warning ..... 425

## The Monitor: Movie Mode

The following indicators appear in the monitor in movie mode.

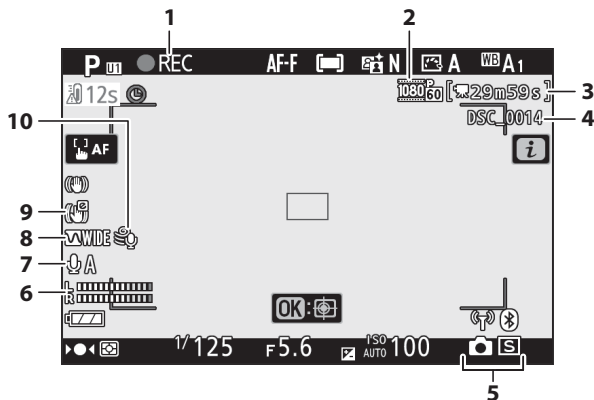

1	Recording indicator .....	44	6	Sound level .....	145
	"No movie" indicator .....	45	7	Microphone sensitivity ....	145, 263
2	Frame size and rate/image quality .....	143, 258	8	Frequency response .....	264
3	Time remaining .....	44	9	Electronic VR indicator .....	147, 263
4	File name .....	258	10	Wind noise reduction .....	264
5	Release mode (still photography) .....	262			

## The Viewfinder: Photo Mode

The following indicators appear in the viewfinder in photo mode.

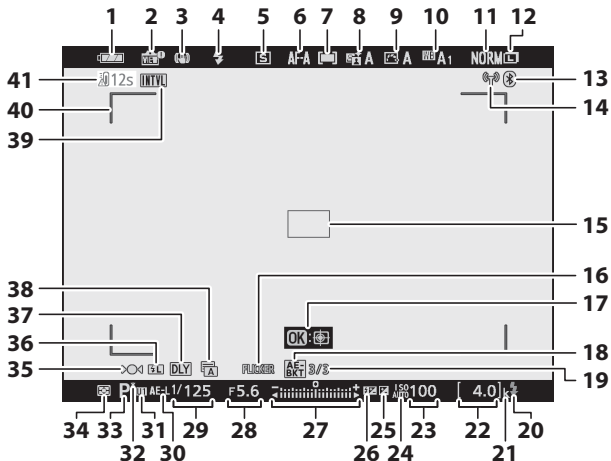

<b>1</b> Battery indicator ..... 34	<b>11</b> Image quality ..... 126, 194
<b>2</b> Live view preview indicator ..... 281	<b>12</b> Image size ..... 128, 194
<b>3</b> Optical VR indicator ..... 139, 216	<b>13</b> Bluetooth connection indicator ..... 318
<b>4</b> Flash mode ..... 108	Airplane mode ..... 317
<b>5</b> Release mode ..... 135	<b>14</b> Wi-Fi connection indicator ..... 132
<b>6</b> Focus mode ..... 51, 216, 262	Remote-control connection indicator ..... 323
<b>7</b> AF-area mode ..... 54, 216, 262	<b>15</b> Focus point ..... 42, 54
<b>8</b> Active D-Lighting indicator ..... 133, 209, 260	<b>16</b> Flicker detection ..... 212
<b>9</b> Picture Control indicator ..... 116, 204, 260	<b>17</b> Subject tracking ..... 62
<b>10</b> White balance ..... 67, 120, 198, 259	

18	Exposure bracketing indicator ... 218	26	Flash compensation indicator.... 111
	WB bracketing indicator ..... 222	27	Exposure indicator .....79
	ADL bracketing indicator ..... 225		Exposure compensation
	HDR indicator ..... 234		display ..... 102
	Multiple exposure indicator..... 227		Bracketing progress indicator:
19	Number of shots remaining in exposure bracketing sequence..... 218		Exposure bracketing..... 218
	Number of shots remaining in white balance bracketing sequence..... 222	28	Aperture .....77
	Number of shots remaining in ADL bracketing sequence..... 225	29	Shutter speed ..... 76, 78
	HDR exposure differential ..... 234	30	Autoexposure (AE) lock.... 104, 105
	Number of exposures (multiple exposure) ..... 227	31	User setting mode.....82
20	Flash-ready indicator ..... 435	32	Flexible program indicator.....76
21	“k” (appears when memory remains for over 1000 exposures) .....34	33	Shooting mode .....75
22	Number of exposures remaining .....34, 463	34	Metering ..... 131, 212, 262
23	ISO sensitivity ..... 100	35	Focus indicator.....65
24	ISO sensitivity indicator ..... 100	36	FV lock indicator ..... 112
	Auto ISO sensitivity indicator... 101	37	Exposure delay mode..... 278
25	Exposure compensation indicator ..... 102	38	Shutter type..... 279
			Silent photography .....71, 256
		39	Interval timer indicator ..... 239
			“Clock not set” indicator .....39
			“No memory card” indicator..... 32, 35
		40	AF-area brackets.....54
		41	Temperature warning ..... 425



## The Viewfinder: Movie Mode

The following indicators appear in the viewfinder in movie mode.

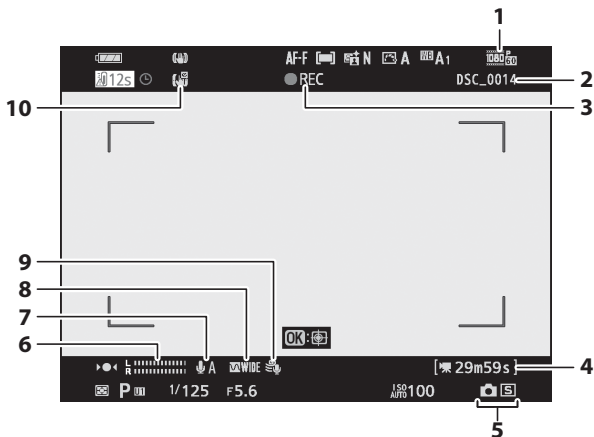

<b>1</b> Frame size and rate/image quality..... 143, 258	<b>5</b> Release mode (still photography)..... 262
<b>2</b> File name ..... 193	<b>6</b> Sound level ..... 145
<b>3</b> Recording indicator..... 44	<b>7</b> Microphone sensitivity..... 145, 263
“No movie” indicator..... 45	<b>8</b> Frequency response..... 264
<b>4</b> Time remaining ..... 44	<b>9</b> Wind noise reduction ..... 264
	<b>10</b> Electronic VR indicator ..... 147, 263



## The Nikon Creative Lighting System





Nikon's advanced Creative Lighting System (CLS) offers improved communication between the camera and compatible flash units for improved flash photography.

### CLS-Compatible Flash Units

The following features are available with CLS-compatible flash units:

		SB-5000	SB-800	SB-900	SB-910	SB-700	SB-600	SB-500	SU-800	SB-R200	SB-400	SB-300
Single flash	i-TTL	i-TTL balanced fill flash <sup>1</sup>	✓	✓	✓	✓	✓	✓	—	—	✓	✓
		Standard i-TTL fill flash	✓ <sup>2</sup>	✓ <sup>2</sup>	✓	✓ <sup>2</sup>	✓	—	—	—	✓	✓
	 A	Auto aperture	✓	✓ <sup>3</sup>	—	—	—	—	—	—	—	—
	A	Non-TTL auto	—	✓ <sup>3</sup>	—	—	—	—	—	—	—	—
	GN	Distance-priority manual	✓	✓	✓	—	—	—	—	—	—	—
	M	Manual	✓	✓	✓	✓	✓ <sup>4</sup>	—	—	—	✓ <sup>4</sup>	✓ <sup>4</sup>
	RPT	Repeating flash	✓	✓	—	—	—	—	—	—	—	—

		SB-5000	SB-800	SB-900	SB-910	SB-700	SB-600	SB-500	SU-800	SB-R200	SB-400	SB-300	
Optical Advanced Wireless Lighting	Master	Remote flash control	✓	✓	✓	—	✓ <sup>4</sup>	✓	—	—	—	—	
		i-TTL	✓	✓	✓	—	✓ <sup>4</sup>	—	—	—	—	—	
		[A:B]	Quick wireless flash control	✓	—	✓	—	—	✓ <sup>5</sup>	—	—	—	—
		 A	Auto aperture	✓	✓	—	—	—	—	—	—	—	—
		A	Non-TTL auto	—	—	—	—	—	—	—	—	—	—
		M	Manual	✓	✓	✓	—	✓ <sup>4</sup>	—	—	—	—	—
		RPT	Repeating flash	✓	✓	—	—	—	—	—	—	—	—
	Remote	i-TTL	✓	✓	✓	✓	✓	✓	—	✓	—	—	—
		[A:B]	Quick wireless flash control	✓	✓	✓	✓	✓	—	✓	—	—	—
		 A/A	Auto aperture/ Non-TTL auto	✓ <sup>6</sup>	✓ <sup>6</sup>	—	—	—	—	—	—	—	—
		M	Manual	✓	✓	✓	✓	✓	—	✓	—	—	—
		RPT	Repeating flash	✓	✓	✓	✓	✓	—	—	—	—	—
	Radio-controlled Advanced Wireless Lighting		—	—	—	—	—	—	—	—	—	—	—
	Color information communication (flash)		✓	✓	✓	✓	✓	✓	—	—	✓	✓	—
	Color information communication (LED light)		—	—	—	—	—	✓	—	—	—	—	—
Auto FP High-Speed Sync <sup>7</sup>		✓	✓	✓	✓	✓	✓	✓	✓	—	—	—	
FV lock <sup>8</sup>		✓	✓	✓	✓	✓	✓	✓	✓	✓	✓	✓	
Red-eye reduction		✓	✓	✓	✓	✓	✓	—	—	✓	—	—	
Camera modeling illumination		—	—	—	—	—	—	—	—	—	—	—	
Unified flash control		—	—	—	—	—	—	—	—	—	—	—	
Camera flash unit firmware update		✓	✓ <sup>9</sup>	✓	—	✓	—	—	—	—	—	✓	

- 1 Not available with spot metering.
- 2 Can also be selected with flash unit.
- 3 A/A mode selection performed on flash unit using custom settings.
- 4 Can only be selected using the camera **Flash control** option.
- 5 Available only during close-up photography.
- 6 Choice of A and **A** depends on the option selected with the master flash.
- 7 Available only in i-TTL, , **A**, **GN**, and **M** flash-control modes.
- 8 Available only in i-TTL flash control mode or when the flash is set to emit monitor pre-flashes in A or **A** flash control mode.
- 9 Firmware updates for the SB-910 and SB-900 can be performed from the camera.

## The SU-800 Wireless Speedlight Commander

When mounted on a CLS-compatible camera, the SU-800 can be used as a commander for SB-5000, SB-910, SB-900, SB-800, SB-700, SB-600, SB-500, or SB-R200 flash units in up to three groups. The SU-800 itself is not equipped with a flash.

### **Flash Compensation**

In i-TTL and auto aperture () flash control modes, the flash compensation selected with the optional flash unit or the camera **Flash control** option is added to the flash compensation selected with the **Flash compensation** option in the photo shooting menu.

### ✔ Notes on Optional Flash Units

Refer to the flash unit manual for detailed instructions. If the unit supports CLS, refer to the section on CLS-compatible digital SLR cameras. Note that this camera is not included in the “digital SLR” category in the SB-80DX, SB-28DX, and SB-50DX manuals.

i-TTL flash control can be used at ISO sensitivities between 100 and 12800. At values over 12800, the desired results may not be achieved at some ranges or aperture settings. If the flash-ready indicator (⚡) flashes for about three seconds after a photograph is taken in i-TTL or non-TTL auto mode, the flash has fired at full power and the photograph may be underexposed (CLS-compatible flash units only).

When an SC-series 17, 28, or 29 sync cable is used for off-camera flash photography, correct exposure may not be achieved in i-TTL mode. We recommend that you select standard i-TTL fill-flash. Take a test shot and view the results in the camera display.

In i-TTL, use the flash panel or bounce adapter provided with the flash unit. Do not use other panels such as diffusion panels, as this may produce incorrect exposure.

In mode **P**, the maximum aperture (minimum f-number) is limited according to ISO sensitivity, as shown below:

Maximum aperture at ISO equivalent of:							
100	200	400	800	1600	3200	6400	12800
4	5	5.6	7.1	8	10	11	13

If the maximum aperture of the lens is smaller than given above, the maximum value for aperture will be the maximum aperture of the lens.

AF-assist illumination is provided by the camera, not the flash unit; the SB-5000, SB-910, SB-900, SB-800, SB-700, SB-600, SB-500, and SB-400 do, however, provide red-eye reduction.

Noise in the form of lines may appear in flash photographs taken with an SD-9 or SD-8A high-performance battery pack attached directly to the camera. Reduce ISO sensitivity or increase the distance between the camera and the power pack.

### ✔ Other Flash Units

The following flash units can be used in non-TTL auto and manual modes.



Flash unit		SB-80DX, SB-28DX, SB-28, SB-26, SB-25, SB-24	SB-50DX, SB-23, SB-29, SB-21B, SB-29S	SB-30, SB-27 <sup>1</sup> , SB-22S, SB-22, SB-20, SB-16B, SB-15
<b>A</b>	Non-TTL auto	✔	—	✔
<b>M</b>	Manual	✔	✔	✔
	Repeating flash	✔	—	—
<b>REAR</b>	Rear-curtain sync <sup>2</sup>	✔	✔	✔

1 Flash mode is automatically set to TTL and shutter-release is disabled. Set flash unit to **A** (non-TTL auto flash).

2 Available when camera is used to select flash mode.

### ✔ FV Lock

The area metered for FV lock is as follows:

Flash unit	Flash mode	Metered area
Stand-alone flash unit	<b>i-TTL</b>	6-mm circle in center of frame
	 <b>A</b>	Area metered by flash exposure meter
Used with other flash units (Advanced Wireless Lighting)	<b>i-TTL</b>	Entire frame
	 <b>A</b>	Area metered by flash exposure meter
	<b>A</b>	

### ✔ Studio Strobe Lighting

To adjust the color and brightness of the view through the lens so that shots are easier to frame, select **Off** for Custom Setting d7 (**Apply settings to live view**).

## Other Accessories

A variety of accessories are available for your Nikon camera.

<b>Power sources</b>	<ul style="list-style-type: none"><li>• <b>EN-EL25 Rechargeable Li-ion Battery:</b> Additional EN-EL25 batteries are available from local retailers and Nikon service representatives.</li><li>• <b>MH-32 Battery Charger:</b> The MH-32 can be used to recharge EN-EL25 batteries.</li><li>• <b>EH-73P Charging AC Adapter:</b> The EH-73P can be used to charge EN-EL25 batteries inserted in the camera (the battery only charges when the camera is off).</li></ul>
<b>Filters</b>	<ul style="list-style-type: none"><li>• Neutral Color (NC) filters can be used to protect the lens.</li><li>• To prevent ghosting, avoid using filters when the subject is framed against a bright light, or when a bright light source is in the frame.</li><li>• Center-weighted metering is recommended if matrix metering fails to produce the desired results for filters with exposure factors (filter factors) over 1× (Y44, Y48, Y52, O56, R60, X0, X1, C-PL, ND2S, ND4, ND4S, ND8, ND8S, ND400, A2, A12, B2, B8, B12). See the filter manual for details.</li><li>• Filters intended for special-effects photography may interfere with autofocus or the in-focus indicator (●).</li></ul>
<b>USB cables</b>	<b>UC-E21 USB cable:</b> A USB cable with a Micro-B connector for connection to the camera and a type A connector for connection to the USB device.
<b>Hot shoe adapters</b>	<b>AS-15 Sync Terminal Adapter:</b> Mount the AS-15 on the camera hot shoe to connect studio strobe lights or other flash equipment via a sync terminal.
<b>Accessory shoe covers</b>	<b>BS-1 Accessory Shoe Cover:</b> A cover protecting the accessory shoe when no flash unit is attached.
<b>Body caps</b>	<b>BF-N1 Body Cap:</b> The body cap prevents dust entering the camera when a lens is not in place.

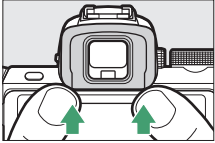
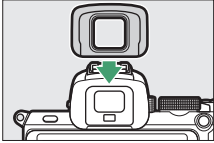
<b>Viewfinder eyepiece accessories</b>	<p><b>DK-30 Rubber Eyecup:</b> The DK-30 makes the image in the viewfinder easier to see, preventing eye fatigue.</p> <div style="display: flex; justify-content: space-around; align-items: center;"> <div style="text-align: center;">  <p><i>Remove</i></p> </div> <div style="text-align: center;">  <p><i>Replace</i></p> </div> </div>
<b>Mount adapters</b>	<p><b>FTZ Mount Adapter:</b> An adapter that allows NIKKOR F mount lenses to be used with digital cameras that support interchangeable Z mount lenses. The picture angle is equivalent to that of a lens with a 35 mm format-equivalent focal length approximately 1.5 times longer.</p> <ul style="list-style-type: none"> <li>• For information on attaching, removing, maintaining, and using FTZ mount adapters, refer to the mount adapter manual.</li> </ul>
<b>Microphones</b>	<ul style="list-style-type: none"> <li>• <b>ME-1 Stereo Microphone:</b> Connect the ME-1 to the camera microphone jack to record stereo sound and reduce the chance of picking up equipment noise (such as the sounds produced by the lens during autofocus).</li> <li>• <b>ME-W1 Wireless Microphone:</b> Use this wireless Bluetooth microphone for off-camera recording.</li> </ul>



## Remote controls

**ML-L7 Remote Control:** Once paired with the camera, the ML-L7 can be used to take photographs and record movies remotely.

- Use the **Wireless remote (ML-L7) options > Save wireless remote controller** option in the camera setup menu to pair the camera with the remote.
- The camera can be paired with only one remote at a time. If paired successively with more than one remote, the camera will respond only to the remote with which it was last paired.
- To reactivate the camera after the standby timer has expired and the monitor and viewfinder displays have turned off, turn the remote control on and press and hold the remote-control shutter-release or movie-record button.
- For more information, see the remote control manual or the section on the setup menu **Wireless remote (ML-L7) options** item in the “Menu Guide” chapter of the *Reference Manual*.

Availability may vary with country or region. See our website or brochures for the latest information.

## Charging AC Adapters

When inserted in the camera, EN-EL25 rechargeable Li-ion batteries will charge while the camera is connected to an optional EH-73P charging AC adapter. An exhausted battery will fully charge in about 3 hours and 30 minutes. Note that in countries or regions where required, charging AC adapters are supplied with a plug adapter attached; the shape of the plug adapter varies with the country of sale.

- 1** Insert the EN-EL25 into the camera (📖 32).

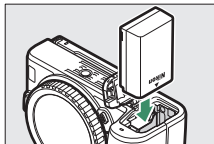

- 
- 2** After confirming that the camera is off, connect the charging AC adapter using the USB cable supplied with the camera and plug the adapter in. Use only a UC-E21 USB cable and an EH-73P charging adapter; do not use other charging adapters or third-party USB-AC adapters or smartphone chargers. Insert the plug or plug adapter straight into the socket rather than at an angle, and observe the same precaution when unplugging the charging AC adapter.

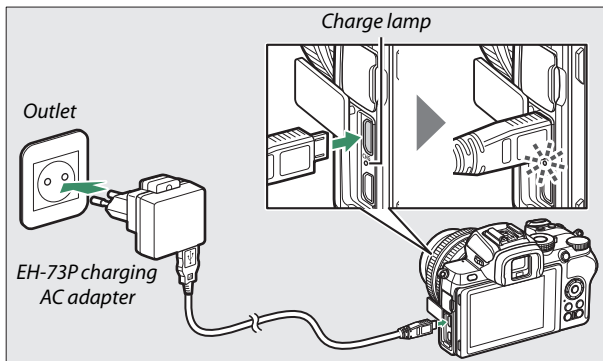

The camera charge lamp lights amber while charging is in progress and turns off when charging is complete. Note that although the camera can be used while connected, the battery will not charge and the camera will not draw power from the charging AC adapter while the camera is on.

- 
- 3** Unplug and disconnect the charging AC adapter when charging is complete.

### **The Charge Lamp**

If the battery cannot be charged using the charging AC adapter, for example because the battery is not compatible or the temperature of the camera is elevated, the charge lamp will flash rapidly for about 30 seconds and then turn off. If the charge lamp is off and you did not observe the battery charging, turn the camera on and check the battery level.

## Software

The following Nikon software can be used with the camera:

<b>Computer software</b>	<ul style="list-style-type: none"><li>• <b>Camera Control Pro 2</b> (available for purchase): Control the camera remotely from a computer and save photographs directly to the computer hard disk.</li><li>• <b>NX Tether</b>: Use for tethered photography when the camera is connected to a computer. Exposure, white balance, and other camera settings can be adjusted remotely using controls in the computer display.</li><li>• <b>NX Studio</b><sup>*</sup>: View and edit photos and videos shot with Nikon digital cameras. NX Studio can be used to fine-tune files in Nikon's unique NEF/NRW (RAW) format and convert them to JPEG or TIFF (NEF/RAW processing). It supports not only NEF/NRW (RAW) pictures but also JPEG and TIFF photos shot with Nikon digital cameras for such tasks as editing tone curves and enhancing brightness and contrast.<ul style="list-style-type: none"><li>* Existing users should be sure to download the latest version, as earlier versions may be unable to download pictures from the camera or open NEF (RAW) pictures.</li></ul></li><li>• <b>Wireless Transmitter Utility</b>: The Wireless Transmitter Utility is required if the camera is to be connected to a network. Pair the camera with the computer and download pictures via Wi-Fi.</li><li>• Nikon computer software is available from the Nikon Download Center. Check the version and system requirements and be sure to download the latest version. <a href="https://downloadcenter.nikonimglib.com/">https://downloadcenter.nikonimglib.com/</a></li></ul>
<b>Smartphone (tablet) apps</b>	<ul style="list-style-type: none"><li>• <b>SnapBridge</b>: Download photos and movies from the camera to your smart device via a wireless connection.</li><li>• The SnapBridge app is available from the Apple App Store® and on Google Play™.</li><li>• Visit our website for the latest information on the SnapBridge app.</li></ul>

## Caring for the Camera

Learn how to store, clean, and care for your camera.

### Storage

When the camera will not be used for an extended period, remove the battery and store it in a cool, dry area with the terminal cover in place. To prevent mold or mildew, store the camera in a dry, well-ventilated area. Do not store your camera with naphtha or camphor moth balls or in locations that:

- are poorly ventilated or subject to humidities of over 60%,
- are next to equipment that produces strong electromagnetic fields, such as televisions or radios, or
- are exposed to temperatures above 50 °C (122 °F) or below -10 °C (14 °F)

### Cleaning

*Do not use alcohol, thinner, or other volatile chemicals.*

- **Camera body:** Use a blower to remove dust and lint, then wipe gently with a soft, dry cloth. After using the camera at the beach or seaside, wipe off sand or salt with a cloth lightly dampened in distilled water and dry thoroughly. **Important:** *Dust or other foreign matter inside the camera may cause damage not covered under warranty.*
- **Lenses, viewfinder:** Glass surfaces are easily damaged. Remove dust and lint with a blower. If using an aerosol blower, keep the can vertical to prevent the discharge of liquid. To remove fingerprints and other stains, apply a small amount of lens cleaner to a soft cloth and clean with care.
- **Monitor:** Remove dust and lint with a blower. When removing fingerprints and other stains, wipe the surface lightly with a soft cloth or chamois leather. Do not apply pressure, as this could result in damage or malfunction.

## **Cleaning the Image Sensor**

Dirt or dust entering the camera when lenses are exchanged or the body cap is removed may adhere to the image sensor and affect your photographs. The image sensor can be cleaned as described below. Note, however, that the sensor is extremely delicate and easily damaged; we recommend that manual cleaning be performed only by a Nikon-authorized service representative.

---

### **1 Remove the lens.**

Turn the camera off and remove the lens or body cap.

---

### **2 Examine the image sensor.**

Holding the camera so that light falls on the image sensor, examine the sensor for dust or lint. If no foreign objects are present, proceed to Step 4.

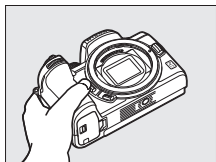

### **3 Clean the sensor.**

Remove any dust and lint from the sensor with a blower. Do not use a blower-brush, as the bristles could damage the sensor. Dirt that cannot be removed with a blower can only be removed by Nikon-authorized service personnel. Under no circumstances should you touch or wipe the sensor.

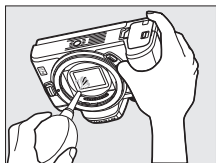

### **4 Replace the lens or body cap.**

---

### ✔ Foreign Matter on the Image Sensor

Foreign matter entering the camera when lenses or body caps are removed or exchanged (or in rare circumstances lubricant or fine particles from the camera itself) may adhere to the image sensor, where it may appear in photographs taken under certain conditions. To protect the camera when no lens is in place, be sure to replace the body cap provided with the camera, being careful to first remove all dust and other foreign matter that may be adhering to the camera mount, lens mount, and body cap. Avoid attaching the body cap or exchanging lenses in dusty environments.

Should foreign matter find its way onto the image sensor, clean the sensor manually (☞ 444) or have the sensor cleaned by authorized Nikon service personnel. Photographs affected by the presence of foreign matter on the sensor can be retouched using the clean image options available in some imaging applications.

### ✔ Servicing the Camera and Accessories

The camera is a precision device and requires regular servicing. Nikon recommends that the camera be inspected by the original retailer or a Nikon-authorized service representative once every one to two years, and that it be serviced once every three to five years (note that fees apply to these services). Frequent inspection and servicing are particularly recommended if the camera is used professionally. Any accessories regularly used with the camera, such as lenses or optional flash units, should be included when the camera is inspected or serviced.

## Caring for the Camera and Battery: Cautions

**Do not drop:** The product may malfunction if subjected to strong shocks or vibration.

**Keep dry:** This product is not waterproof, and may malfunction if immersed in water or exposed to high levels of humidity. Rusting of the internal mechanism can cause irreparable damage.

**Avoid sudden changes in temperature:** Sudden changes in temperature, such as those that occur when entering or leaving a heated building on a cold day, can cause condensation inside the device. To prevent condensation, place the device in a carrying case or plastic bag before exposing it to sudden changes in temperature.

**Keep away from strong magnetic fields:** Do not use or store this device in the vicinity of equipment that generates strong electromagnetic radiation or magnetic fields. Static charges or the magnetic fields produced by equipment such as radio transmitters could interfere with the display, damage data stored on the memory card, or affect the product's internal circuitry.

**Do not leave the lens pointed at the sun:** Do not leave the lens pointed at the sun or other strong light source for an extended period. Intense light may cause the image sensor to deteriorate or produce a white blur effect in photographs.

**Lasers and other bright light sources:** Do not direct lasers or other extremely bright light sources toward the lens, as this could damage the camera's image sensor.

**Turn the product off before removing the battery:** Do not remove the battery while the product is on or while images are being recorded or deleted. Forcibly cutting power in these circumstances could result in loss of data or in damage to product memory or internal circuitry.



**Cleaning:** When cleaning the camera body, use a blower to gently remove dust and lint, then wipe gently with a soft, dry cloth. After using the camera at the beach or seaside, wipe off any sand or salt using a cloth lightly dampened in pure water and then dry the camera thoroughly.

Lenses, viewfinders, and other glass elements are easily damaged. Dust and lint should be gently removed with a blower. When using an aerosol blower, keep the can vertical to prevent discharge of liquid. To remove fingerprints and other stains from glass surfaces, apply a small amount of lens cleaner to a soft cloth and wipe the glass carefully.

**Do not touch the image sensor:** Under no circumstances should you exert pressure on the image sensor, poke it with cleaning tools, or subject it to powerful air currents from a blower. These actions could scratch or otherwise damage the sensor. For information on cleaning the image sensor, see “Cleaning the Image Sensor” (□ 444).

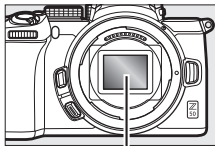

*Image sensor*

**Lens contacts:** Keep the lens contacts clean and be careful not to touch them with your fingers or with tools or other objects.

**Storage:** To prevent mold or mildew, store the camera in a dry, well-ventilated area. If the product will not be used for an extended period, remove the battery to prevent leakage and store the camera in a plastic bag containing a desiccant. Do not, however, store the camera case in a plastic bag, as this may cause the material to deteriorate. Note that desiccant gradually loses its capacity to absorb moisture and should be replaced at regular intervals.

To prevent mold or mildew, take the camera out of storage at least once a month. Turn the camera on and release the shutter a few times before putting it away.

Store the battery in a cool, dry place. Replace the terminal cover before putting the battery away.

**Notes on the monitor and viewfinder:** These displays are constructed with extremely high precision; at least 99.99% of pixels are effective, with no more than 0.01% being missing or defective. Hence while these displays may contain pixels that are always lit (white, red, blue, or green) or always off (black), this is not a malfunction and has no effect on images recorded with the device.

Images in the monitor may be difficult to see in a bright light. Do not apply pressure to the monitor, as this could cause damage or malfunction. Dust or lint can be removed with a blower. Stains can be removed by wiping lightly with a soft cloth or chamois leather. Should the monitor break, care should be taken to avoid injury from broken glass and to prevent liquid crystal from the monitor touching the skin or entering the eyes and mouth.

Should you feel unwell or experience any of the following symptoms while framing shots in the viewfinder, discontinue use until your condition improves: nausea, eye pain, eye fatigue, dizziness, headache, stiffness in your neck or shoulders, carsickness, or loss of hand-eye coordination. The same applies should you start to feel unwell when watching the shooting display flicker rapidly on and off during burst photography.

Noise in the form of lines may in rare cases appear in pictures that include bright lights or back-lit subjects.

**The battery and charger:** Batteries may leak or explode if improperly handled. Observe the following precautions when handling batteries and chargers:

- Use only batteries approved for use in this equipment.
- Do not expose the battery to flame or excessive heat.
- Keep the battery terminals clean.
- Turn the product off before replacing the battery.
- The battery may become hot while in use. Observe caution when handling the battery immediately after use.

- Remove the battery from the camera or charger when not in use and replace the terminal cover. These devices draw minute amounts of charge even when off and could draw the battery down to the point that it will no longer function. If the battery will not be used for some time, insert it in the camera and run it flat before removing it from the camera for storage. The battery should be stored in a cool location with an ambient temperature of 15 °C to 25 °C (59 °F to 77 °F; avoid hot or extremely cold locations). Repeat this process at least once every six months.
- Turning the camera on or off repeatedly when the battery is fully discharged will shorten battery life. Batteries that have been fully discharged must be charged before use.
- The internal temperature of the battery may rise while the battery is in use. Attempting to charge the battery while the internal temperature is elevated will impair battery performance, and the battery may not charge or charge only partially. Wait for the battery to cool before charging.
- Charge the battery indoors at ambient temperatures of 5 °C to 35 °C (41 °F to 95 °F). Do not use the battery at ambient temperatures below 0 °C (32 °F) or above 40 °C (104 °F); failure to observe this precaution could damage the battery or impair its performance. Capacity may be reduced and charging times increase at battery temperatures from 0 °C (32 °F) to 15 °C (59 °F) and from 45 °C (113 °F) to 60 °C (140 °F). The battery will not charge if its temperature is below 0 °C (32 °F) or above 60 °C (140 °F).
- If the charge lamp flashes quickly (about eight times a second) during charging, confirm that the temperature is in the correct range and then unplug the charger and remove and reinsert the battery. If the problem persists, cease use immediately and take battery and charger to your retailer or a Nikon-authorized service representative.
- Do not move the charger or touch the battery during charging. Failure to observe this precaution could in very rare instances result in the charger showing that charging is complete when the battery is only partially charged. Remove and reinsert the battery to begin charging again.

- Battery capacity may temporarily drop if the battery is charged at low temperatures or used at a temperature below the temperature at which it was charged.
- Continuing to charge the battery after it is fully charged can impair battery performance.
- A marked drop in the time a fully charged battery retains its charge when used at room temperature indicates that it requires replacement. Purchase a new battery.
- Use the charger with compatible batteries only. Unplug when not in use.
- Do not short the charger terminals. Failure to observe this precaution could result in overheating and damage to the charger.
- Charge the battery before use. When taking photographs on important occasions, ready a spare battery and keep it fully charged. Depending on your location, it may be difficult to purchase replacement batteries on short notice. Note that on cold days, the capacity of batteries tends to decrease. Be sure the battery is fully charged before taking photographs outside in cold weather. Keep a spare battery in a warm place and exchange the two as necessary. Once warmed, a cold battery may recover some of its charge.
- Recycle rechargeable batteries in accord with local regulations, being sure to first insulate the terminals with tape.
- Do not use chargers with damage that leaves the interior exposed or that produce unusual sounds when used.

**The charging AC adapter:** Observe the precautions below when using the charging AC adapter.

- Do not move the camera during charging. Failure to observe this precaution could in very rare instances result in the camera showing that charging is complete when the battery is only partially charged. Disconnect and reconnect the adapter to begin charging again.
- Do not short the adapter terminals. Failure to observe this precaution could result in overheating and damage to the adapter.
- Unplug the adapter when it is not in use.
- Do not use adapters with damage that leaves the interior exposed or that produce unusual sounds when used.

# Specifications

## Nikon Z 50 Digital Camera

Type	
Type	Digital camera with support for interchangeable lenses
Lens mount	Nikon Z mount
Lens	
Compatible lenses	<ul style="list-style-type: none"><li>• Z mount NIKKOR lenses</li><li>• F mount NIKKOR lenses with mount adapter; restrictions may apply</li></ul>
Effective pixels	
Effective pixels	20.9 million
Image sensor	
Image sensor	23.5 × 15.7 mm CMOS sensor (Nikon DX format)
Total pixels	21.51 million
Dust-Reduction System	Image Dust Off reference data (requires NX Studio)
Storage	
Image size (pixels)	<ul style="list-style-type: none"><li>• <b>DX (24×16) image area</b> 5568 × 3712 (Large: 20.7 M) 4176 × 2784 (Medium: 11.6 M) 2784 × 1856 (Small: 5.2 M)</li><li>• <b>1 : 1 (16×16) image area</b> 3712 × 3712 (Large: 13.8 M) 2784 × 2784 (Medium: 7.8 M) 1856 × 1856 (Small: 3.4 M)</li><li>• <b>16 : 9 (24×14) image area</b> 5568 × 3128 (Large: 17.4 M) 4176 × 2344 (Medium: 9.8 M) 2784 × 1560 (Small: 4.3 M)</li><li>• <b>Photographs taken during movie recording at a frame size of 3840 × 2160:</b> 3840 × 2160</li><li>• <b>Photographs taken during movie recording at a frame size of 1920 × 1080:</b> 1920 × 1080</li></ul>

Storage	
<b>File format</b>	<ul style="list-style-type: none"> <li>• <b>NEF (RAW):</b> 12 or 14 bit</li> <li>• <b>JPEG:</b> JPEG-Baseline compliant with fine (approx. 1 : 4), normal (approx. 1 : 8), or basic (approx. 1 : 16) compression</li> <li>• <b>NEF (RAW)+JPEG:</b> Single photograph recorded in both NEF (RAW) and JPEG formats</li> </ul>
<b>Picture Control System</b>	Auto, Standard, Neutral, Vivid, Monochrome, Portrait, Landscape, Flat, Creative Picture Controls (Dream, Morning, Pop, Sunday, Somber, Dramatic, Silence, Bleached, Melancholic, Pure, Denim, Toy, Sepia, Blue, Red, Pink, Charcoal, Graphite, Binary, Carbon); selected Picture Control can be modified; storage for custom Picture Controls
<b>Media</b>	SD (Secure Digital) and UHS-I compliant SDHC and SDXC memory cards
<b>File system</b>	DCF 2.0, Exif 2.31, PictBridge
Viewfinder	
<b>Viewfinder</b>	0.99-cm/0.39-in. approx. 2360k-dot (XGA) OLED electronic viewfinder with color balance and auto and 7-level manual brightness controls
<b>Frame coverage</b>	Approx. 100% horizontal and 100% vertical
<b>Magnification</b>	Approx. 1.02× (50 mm lens at infinity, $-1.0 \text{ m}^{-1}$ )
<b>Eyepoint</b>	19.5 mm ( $-1.0 \text{ m}^{-1}$ ; from center surface of viewfinder eyepiece lens)
<b>Diopter adjustment</b>	$-3 - +3 \text{ m}^{-1}$
<b>Eye sensor</b>	Automatically switches between monitor and viewfinder displays
Monitor	
<b>Monitor</b>	8-cm/3.2-in., approx. 1040k-dot tilting TFT touch-sensitive LCD with 170° viewing angle, approximately 100% frame coverage, and 11-level manual brightness controls



Shutter	
Type	Electronically-controlled vertical-travel focal-plane mechanical shutter; electronic front-curtain shutter; electronic shutter
Speed	$\frac{1}{4000}$ – 30 s (choose from step sizes of $\frac{1}{3}$ and $\frac{1}{2}$ EV), bulb, time
Flash sync speed	X = $\frac{1}{200}$ s; synchronizes with shutter at $\frac{1}{200}$ s or slower; Auto FP High-Speed sync supported
Release	
Release mode	Single frame, low-speed continuous, high-speed continuous, high-speed continuous (extended), self-timer
Approximate maximum frame advance rate (measured under Nikon-specified test conditions)	<ul style="list-style-type: none"> <li>• <b>Low-speed continuous:</b> 1–4 fps</li> <li>• <b>High-speed continuous:</b> 5 fps</li> <li>• <b>High-speed continuous (extended):</b> 11 fps</li> </ul>
Self-timer	2 s, 5 s, 10 s, 20 s; 1–9 exposures at intervals of 0.5, 1, 2, or 3 s
Exposure	
Metering system	TTL metering using camera image sensor
Metering mode	<ul style="list-style-type: none"> <li>• <b>Matrix metering</b></li> <li>• <b>Center-weighted metering:</b> Weight of 75% given to 8 mm circle in center of frame; weighting can instead be based on average of entire frame</li> <li>• <b>Spot metering:</b> Meters 3.5 mm circle (about 2.5% of frame) centered on selected focus point</li> <li>• <b>Highlight-weighted metering</b></li> </ul>
Range (ISO 100, f/2.0 lens, 20 °C/68 °F)	–4 – +17 EV

Exposure	
<b>Mode</b>	<ul style="list-style-type: none"> <li>•  <b>AUTO</b>: <b>P</b>: programmed auto with flexible program, <b>S</b>: shutter-priority auto, <b>A</b>: aperture-priority auto, <b>M</b>: manual</li> <li>• <b>Scene modes</b>:  portrait;  landscape;  child;  sports;  close up;  night portrait;  night landscape;  party/indoor;  beach/snow;  sunset;  dusk/dawn;  pet portrait;  candlelight;  blossom;  autumn colors;  food</li> <li>• <b>Special effect modes</b>:  night vision; <b>VI</b> super vivid; <b>POP</b> pop;  photo illustration;  toy camera effect;  miniature effect;  selective color;  silhouette;  high key;  low key</li> <li>• <b>U1 and U2</b>: user settings</li> </ul>
<b>Exposure compensation</b>	-5 – +5 EV (choose from step sizes of 1/3 and 1/2 EV) available in <b>P, S, A, M, SCN,</b> and <b>EFCT</b> modes
<b>Exposure lock</b>	Luminosity locked at detected value
<b>ISO sensitivity (Recommended Exposure Index)</b>	ISO 100 – 51200 (choose from step sizes of 1/3 and 1/2 EV); can also be set to approx. 1 or 2 EV (ISO 204800 equivalent) above ISO 51200; auto ISO sensitivity control available
<b>Active D-Lighting</b>	Can be selected from <b>Auto, Extra high, High, Normal, Low, or Off</b>
<b>Multiple exposure</b>	Add, average, lighten, darken
<b>Other options</b>	HDR (high dynamic range), photo mode flicker reduction
Focus	
<b>Autofocus</b>	Hybrid phase-detection/contrast AF with AF assist
<b>Detection range (single-servo AF, photo mode, ISO 100, f/2.0 lens, 20 °C/68 °F)</b>	-4 – +19 EV <ul style="list-style-type: none"> <li>• <b>Without low-light AF</b>: -2 – +19 EV</li> </ul>



Focus	
<b>Lens servo</b>	<ul style="list-style-type: none"> <li>• <b>Autofocus (AF):</b> Single-servo AF (<b>AF-S</b>); continuous-servo AF (<b>AF-C</b>); AF mode auto-switch (<b>AF-A</b>; available only in photo mode); full-time AF (<b>AF-F</b>; available only in movie mode); predictive focus tracking</li> <li>• <b>Manual focus (M):</b> Electronic rangefinder can be used</li> </ul>
<b>Focus points (single-point AF, photo mode, DX image area)</b>	209
<b>AF-area mode</b>	Pinpoint, single-point, and dynamic-area AF (pinpoint and dynamic-area AF available in photo mode only); wide-area AF (S); wide-area AF (L); auto-area AF
<b>Focus lock</b>	Focus can be locked by pressing shutter-release button halfway (single-servo AF) or by pressing $\text{AE-L/AF-L}$ ( <b>○/□</b> ) button
Flash	
<b>Built-in flash</b>	Manual pop-up flash raised via flash pop-up control <b>Guide Number:</b> Approx. 7/22, 7/22 with manual flash (m/ft, ISO 100, 20 °C/68 °F)
<b>Charging time</b>	Approx. 3 s
<b>Flash control</b>	<b>TTL:</b> i-TTL flash control; i-TTL balanced fill-flash is used with matrix, center-weighted, and highlight-weighted metering, standard i-TTL fill-flash with spot metering
<b>Flash mode</b>	Fill flash, red-eye reduction, slow sync, slow sync + red-eye, rear-curtain sync, auto, auto + red-eye reduction, auto slow sync, auto slow sync + red-eye, flash off
<b>Flash compensation</b>	-3 – +1 EV (choose from step sizes of $\frac{1}{3}$ and $\frac{1}{2}$ EV) available in <b>P</b> , <b>S</b> , <b>A</b> , <b>M</b> , and <b>SCN</b> modes

Flash	
<b>Flash-ready indicator</b>	Lights when built-in flash or optional flash unit is fully charged; flashes as underexposure warning after flash is fired at full output
<b>Accessory shoe</b>	ISO 518 hot-shoe with sync and data contacts and safety lock
<b>Nikon Creative Lighting System (CLS)</b>	i-TTL flash control, optical Advanced Wireless Lighting, FV lock, Color Information Communication, Auto FP High-Speed Sync
White balance	
<b>White balance</b>	Auto (3 types), natural light auto, direct sunlight, cloudy, shade, incandescent, fluorescent (7 types), flash, choose color temperature (2500 K–10,000 K), preset manual (up to 6 values can be stored), all except choose color temperature with fine-tuning
Bracketing	
<b>Bracketing types</b>	Exposure, white balance, and ADL
Movie	
<b>Metering system</b>	TTL metering using camera image sensor
<b>Metering mode</b>	Matrix, center-weighted, or highlight-weighted
<b>Frame size (pixels) and frame rate</b>	<ul style="list-style-type: none"> <li>• 3840 × 2160 (4K UHD); 30p (progressive), 25p, 24p</li> <li>• 1920 × 1080; 120p, 100p, 60p, 50p, 30p, 25p, 24p</li> <li>• 1920×1080 (slow-motion); 30p ×4, 25p ×4, 24p ×5</li> </ul> <p>Actual frame rates for 120p, 100p, 60p, 50p, 30p, 25p, and 24p are 119.88, 100, 59.94, 50, 29.97, 25, and 23.976 fps respectively; quality selection available except at sizes of 3840 × 2160, 1920 × 1080 120p/100p, and 1920 × 1080 slow-motion, in which case quality is fixed at ★ (high)</p>

Movie	
File format	MOV, MP4
Video compression	H.264/MPEG-4 Advanced Video Coding
Audio recording format	Linear PCM, AAC
Audio recording device	Built-in stereo or external microphone with attenuator option; sensitivity adjustable
Exposure compensation	-3 – +3 EV (choose from step sizes of 1/3 and 1/2 EV) available in <b>P, S, A, M, SCN</b> , and <b>EFCT</b> modes
ISO sensitivity (Recommended Exposure Index)	<ul style="list-style-type: none"> <li>• <b>M</b>: Manual selection (ISO 100 to 25600; choose from step sizes of 1/3 and 1/2 EV); auto ISO sensitivity control (ISO 100 to 25600) available with selectable upper limit</li> <li>• <b>P, S, A</b>: Auto ISO sensitivity control (ISO 100 to 25600) with selectable upper limit</li> <li>• <b>auto, SCN, EFCT (excluding </b>): Auto ISO sensitivity control (ISO 100 to 25600)</li> <li>• <b></b>: Auto ISO sensitivity control (ISO 100 to Hi 4)</li> </ul>
Active D-Lighting	Can be selected from <b>Same as photo settings, Extra high, High, Normal, Low, or Off</b>
Other options	Time-lapse movies, electronic vibration reduction
Playback	
Playback	Full-frame and thumbnail (4, 9, or 72 images) playback with playback zoom, playback zoom cropping, movie playback, photo and/or movie slide shows, histogram display, highlights, photo information, location data display, auto image rotation, and picture rating
Interface	
USB	Hi-Speed USB with Micro-B connector; connection to built-in USB port is recommended
HDMI output	Type D HDMI connector
Audio input	Stereo mini-pin jack (3.5 mm diameter; plug-in power supported)

**Wi-Fi/Bluetooth**

<b>Wi-Fi</b>	<ul style="list-style-type: none"><li>• <b>Standards:</b><ul style="list-style-type: none"><li>- IEEE 802.11 b/g/n (Africa, Asia, Oceania, and the following European countries: Albania, Armenia, Georgia, Kyrgyzstan, Moldova, and Tajikistan)</li><li>- IEEE 802.11 b/g/n/a/ac (other European countries, Uzbekistan, U.S.A., Canada, Mexico)</li><li>- IEEE 802.11 b/g/n/a (other countries in the Americas)</li></ul></li><li>• <b>Operating frequency:</b><ul style="list-style-type: none"><li>- 2412–2462 MHz (channel 11) (Africa, Asia, Oceania, and the following European countries: Albania, Armenia, Georgia, Kyrgyzstan, Moldova, and Tajikistan)</li><li>- 2412–2462 MHz (channel 11) and 5180–5320 MHz (other European countries, Uzbekistan)</li><li>- 2412–2462 MHz (channel 11) and 5180–5825 MHz (U.S.A., Canada, Mexico)</li><li>- 2412–2462 MHz (channel 11) and 5180–5805 MHz (other countries in the Americas)</li></ul></li><li>• <b>Maximum output power (EIRP):</b><ul style="list-style-type: none"><li>2.4 GHz band: 6.9 dBm</li><li>5 GHz band: 10.2 dBm</li></ul></li><li>• <b>Authentication:</b> Open system, WPA2-PSK</li></ul>
<b>Bluetooth</b>	<ul style="list-style-type: none"><li>• <b>Communication protocols:</b> Bluetooth Specification Version 4.2</li><li>• <b>Operating frequency:</b><ul style="list-style-type: none"><li>Bluetooth: 2402–2480 MHz</li><li>Bluetooth Low Energy: 2402–2480 MHz</li></ul></li><li>• <b>Maximum output power (EIRP):</b><ul style="list-style-type: none"><li>Bluetooth: 1.4 dBm</li><li>Bluetooth Low Energy: –0.1 dBm</li></ul></li></ul>
<b>Range (line of sight)</b>	Approximately 10 m (32 ft) without interference; range may vary with signal strength and presence or absence of obstacles

<b>Power source</b>	
<b>Battery</b>	One EN-EL25 rechargeable Li-ion battery
<b>Charging AC adapter</b>	EH-73P charging AC adapter
<b>Tripod socket</b>	
<b>Tripod socket</b>	0.635cm (1/4 in., ISO 1222)
<b>Dimensions/weight</b>	
<b>Dimensions (W × H × D)</b>	Approx. 126.5 × 93.5 × 60 mm (5 × 3.7 × 2.4 in.)
<b>Weight</b>	Approx. 450 g (15.9 oz.) with battery and memory card but without body cap; approx. 395 g/14 oz. (camera body only)
<b>Operating environment</b>	
<b>Temperature</b>	0 °C–40 °C (+32 °F–104 °F)
<b>Humidity</b>	85% or less (no condensation)

- Unless otherwise stated, all measurements are performed in conformity with Camera and Imaging Products Association (CIPA) standards or guidelines.
- All figures are for a camera with a fully-charged battery.
- The sample images displayed on the camera and the images and illustrations in the manuals are for expository purposes only.
- Nikon reserves the right to change the appearance and specifications of the hardware and software described in this manual at any time and without prior notice. Nikon will not be held liable for damages that may result from any mistakes that this manual may contain.

## ■ ■ MH-32 Battery Charger

<b>Rated input</b>	AC 100–240 V, 50/60 Hz, 0.21 A
<b>Rated output</b>	DC 8.4 V/1.12 A (MAX)
<b>Supported batteries</b>	Nikon EN-EL25 rechargeable Li-ion batteries
<b>Charging time</b>	Approx. 2 hours and 30 minutes at an ambient temperature of 25 °C (77 °F) when no charge remains
<b>Operating temperature</b>	0 °C–40 °C (+32 °F–104 °F)
<b>Dimensions (W × H × D)</b>	Approx. 67 × 94 × 28 mm (2.7 × 3.8 × 1.2 in.), excluding plug adapter
<b>Weight</b>	Approx. 99 g (3.5 oz), excluding plug adapter

The symbols on this product represent the following:

~ AC, --- DC,  Class II equipment (The construction of the product is double-insulated.)

## ■ ■ EN-EL25 Rechargeable Li-ion Battery

<b>Type</b>	Rechargeable lithium-ion battery
<b>Rated capacity</b>	7.6 V/1120 mAh
<b>Operating temperature</b>	0 °C–40 °C (+32 °F–104 °F)
<b>Dimensions (W × H × D)</b>	Approx. 34 × 50.5 × 18 mm (1.4 × 2.0 × 0.8 in.)
<b>Weight</b>	Approx. 53 g (1.9 oz), excluding terminal cover

Nikon reserves the right to change the appearance and specifications of the hardware and software described in this manual at any time and without prior notice. Nikon will not be held liable for damages that may result from any mistakes that this manual may contain.

## **Disposing of Data Storage Devices**

Please note that deleting images or formatting memory cards or other data storage devices does not completely erase the original image data. Deleted files can sometimes be recovered from discarded storage devices using commercially available software, potentially resulting in the malicious use of personal image data. Ensuring the privacy of such data is the user's responsibility.

Before discarding a data storage device or transferring ownership to another person, erase all data using commercial deletion software, or format the device and then completely refill it with images containing no private information (for example, pictures of empty sky). Care should be taken to avoid injury when physically destroying data storage devices.

Before discarding the camera or transferring ownership to another person, you should also use the **Reset all settings** option in the camera setup menu to delete network settings and other personal information.

## **Supported Standards**

- **DCF Version 2.0:** The **Design Rule for Camera File System (DCF)** is a standard widely used in the digital camera industry to ensure compatibility among different makes of camera.
- **Exif version 2.31:** The camera supports Exif (**Exchangeable Image File Format for Digital Still Cameras**) version 2.31, a standard in which information stored with photographs is used for optimal color reproduction when the images are output on Exif-compliant printers.
- **PictBridge:** A standard developed through cooperation with the digital camera and printer industries, allowing photographs to be output directly to a printer without first transferring them to a computer.
- **HDMI:** **High-Definition Multimedia Interface** is a standard for multimedia interfaces used in consumer electronics and AV devices capable of transmitting audiovisual data and control signals to HDMI-compliant devices via a single cable connection.

## Approved Memory Cards

The camera supports SD, SDHC, and SDXC memory cards, including SDHC and SDXC cards compliant with UHS-I. Cards rated UHS Speed Class 3 or better are recommended for movie recording and playback; using slower cards may result in recording or playback being interrupted. When choosing cards for use in card readers, be sure they are compatible with the device. Contact the manufacturer for information on features, operation, and limitations on use.





## Memory Card Capacity

The following table shows the approximate number of pictures that can be stored on a 32 GB SanDisk SDSDXVE-032G-JNJIP card at different image quality and size settings when **DX (24 × 16)** is selected for **Choose image area** (as of April 2019).

	Image quality	Image size	File size <sup>1</sup>	No. of images <sup>1</sup>	Buffer capacity <sup>1,2</sup>
NEF (RAW)	12-bit	—	19.9 MB	846	35
	14-bit		24.7 MB	743	30
JPEG	Fine	Large	9.2 MB	2100	71
		Medium	6.3 MB	3400	100
		Small	3.5 MB	6200	100
	Normal	Large	5.5 MB	4100	100
		Medium	3.3 MB	6600	100
		Small	1.8 MB	11,800	100
	Basic	Large	2.3 MB	8000	100
		Medium	1.6 MB	12,600	100
		Small	1.0 MB	21,600	100

- 1 All figures are approximate. File size, and with it the buffer capacity and number of images that can be recorded, varies with scene recorded.
- 2 Maximum number of exposures that can be stored in memory buffer at ISO 100. May drop if auto distortion control is on.

## Battery Endurance

The approximate length of footage or number of shots that can be recorded with a fully-charged EN-EL25 battery varies with the monitor mode.<sup>1</sup> The figures for photographs<sup>2</sup> are as follows:

- **Viewfinder only:** 280 shots
- **Monitor only:** 320 shots

The figures for movies<sup>3</sup> are:

- **Viewfinder only:** 75 minutes
- **Monitor only:** 75 minutes

Actions such as the following can reduce battery endurance:

- Keeping the shutter-release button pressed halfway
- Repeated autofocus operations
- Taking NEF (RAW) photographs
- Slow shutter speeds
- Using camera Wi-Fi (wireless LAN) and Bluetooth features
- Using the camera with optional accessories connected
- Repeatedly zooming in and out
- Taking pictures at low ambient temperatures

To ensure that you get the most from rechargeable Nikon EN-EL25 batteries:

- Keep the battery contacts clean. Soiled contacts can reduce battery performance.
- Use batteries immediately after charging. Batteries will lose their charge if left unused.

- 1 Endurance varies with the condition of the battery, the temperature, the interval between shots, and the length of time menus are displayed.
- 2 CIPA standard. Measured at 23 °C/73.4 °F ( $\pm 2$  °C/3.6 °F) with a NIKKOR Z DX 16–50mm f/3.5–6.3 VR lens under the following test conditions: one photograph taken at default settings once every 30 s.
- 3 Measured at 23 °C/73.4 °F ( $\pm 2$  °C/3.6 °F) with the camera at default settings and a NIKKOR Z DX 16–50mm f/3.5–6.3 VR lens under conditions specified by the Camera and Imaging Products Association (CIPA). Individual movies can be up to 29 minutes 59 seconds in length; recording may end before these limits are reached if the camera temperature rises.

# NIKKOR Z DX 16–50mm f/3.5–6.3 VR Lens User's Manual

This section is included as a lens manual for purchasers of the NIKKOR Z DX 16–50mm f/3.5–6.3 VR lens kit. Note that lens kits may not be available in some countries or regions.

## Using the Lens

### Parts of the Lens: Names and Functions

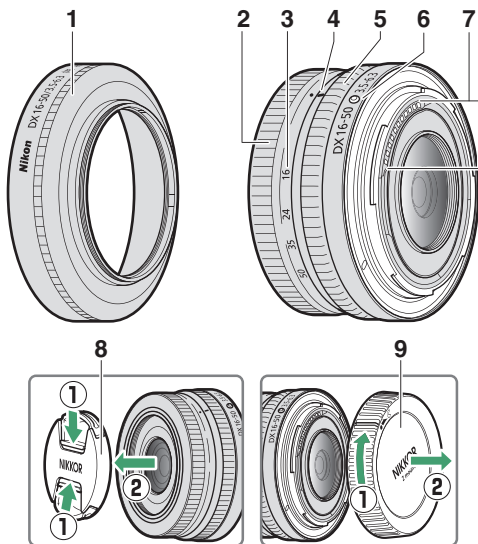

**Note:** The rear cap included with the lens that comes with the lens kit may differ from that shown, in which case it can be removed without performing Step ①.

<b>1 Lens hood*</b>	Lens hoods block stray light that would otherwise cause flare or ghosting. They also serve to protect the lens.
<b>2 Zoom ring</b>	Rotate to zoom in or out. Be sure to extend the lens before use.
<b>3 Focal length scale</b>	Determine the approximate focal length when zooming the lens in or out.
<b>4 Focal length mark</b>	
<b>5 Control ring</b>	<b>Autofocus mode selected:</b> In autofocus mode, rotate the ring to adjust a setting such as <b>Focus (M/A)</b> or <b>Aperture</b> assigned using the camera. For more information, see the description of <b>Custom control assignment/Custom controls (shooting)</b> in the camera manual.
	<b>Manual focus mode selected:</b> Rotate the ring to focus.
<b>6 Lens mounting mark</b>	Use when mounting the lens on the camera.
<b>7 CPU contacts</b>	Used to transfer data to and from the camera.
<b>8 Front lens cap</b>	—
<b>9 Rear lens cap</b>	—

\* Available separately.

## ■ ■ *Attachment and Removal*

### Attaching the Lens

---

- 1** Turn the camera off, remove the body cap, and detach the rear lens cap.
- 
- 2** Position the lens on the camera body, keeping the mounting mark on the lens aligned with the mounting mark on the camera body, and then rotate the lens counterclockwise until it clicks into place.

### Removing the Lens

---

- 1** Turn the camera off.
- 
- 2** Press and hold the lens release button while turning the lens clockwise.

## ■ Before Use

The lens is retractable and must be extended before use. Rotate the zoom ring as shown until the lens clicks into the extended position. Pictures can only be taken when the focal length mark points to positions between 16 and 50 on the focal length scale.

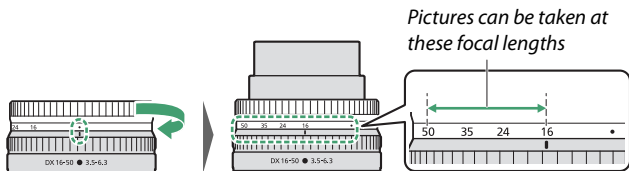

To retract the lens, rotate the zoom ring in the opposite direction, stopping when you reach the (●) position on the focal length scale.

If the camera is turned on with the lens retracted, a warning will be displayed. Extend the lens before use.

## ■ ■ Attaching and Removing Optional Lens Hoods

Lens hoods (available separately) screw directly into the threads in front of the lens. Do not touch the glass surface of the lens or use excessive force.

To remove the hood, unscrew it from the lens.

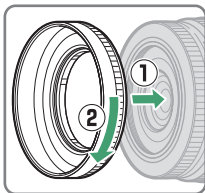

## ■ ■ Using Built-in Flash Units

- Shadows will be visible in photos where the light from the built-in flash is obscured by the lens or lens hood. Remove the lens hood before shooting. Note, however, that even if the hood is removed, shadows may still be visible at some focal lengths and subject distances.
- The focal lengths at which built-in flash units can be used vary with the camera; see the camera manual for details. The flash may be unable to light the entire subject at focal lengths shorter than those specified.

## ■ ■ *Vibration Reduction (VR)*

The lens's on-board vibration reduction can be enabled or disabled using camera controls; see the camera manual for details. Vibration reduction reduces blur caused by camera shake, allowing shutter speeds up to 4.5 stops slower than would otherwise be the case and increasing the range of shutter speeds available.

**Note:** The effects of VR on shutter speed are measured according to Camera and Imaging Products Association (CIPA) standards. DX-format lenses are measured using a DX-format camera with on-camera VR set to **Normal**. Zoom lenses are measured at maximum zoom.



## ■ ■ *When the Lens Is Attached*

- The focus position may change if you turn the camera off and then on again after focusing. If you have focused on a pre-selected location while waiting for your subject to appear, we recommend that you do not turn the camera off until the picture is taken.
- Mounting this lens on an FX-format camera:
  - selects the DX image area, reducing the available focus points and number of pixels recorded, and
  - disables the **Image Dust Off ref photo** option in the setup menu.
- Movies shot with the lens mounted on a Z 6 and 1920 × 1080 120p, 1920 × 1080 100p, or 1920 × 1080 slow-motion selected for **Frame size/frame rate** in the movie shooting menu will be recorded at the following frame sizes and rates:
  - 1920 × 1080; 120p → 1920 × 1080; 60p
  - 1920 × 1080; 100p → 1920 × 1080; 50p
  - 1920 × 1080; 30p ×4 (slow-motion) → 1920 × 1080; 30p
  - 1920 × 1080; 25p ×4 (slow-motion) → 1920 × 1080; 25p
  - 1920 × 1080; 24p ×5 (slow-motion) → 1920 × 1080; 24p

## **Precautions for Use**

- Do not pick up or hold the lens or camera using only the lens hood.
- Keep the CPU contacts clean.
- Due to the design of the vibration reduction system, the lens may rattle when shaken. This does not indicate a malfunction.
- Replace the front and rear lens caps when the lens is not in use.
- To protect the interior of the lens, store it out of direct sunlight.
- Do not leave the lens in humid locations or in locations in which it may be exposed to moisture. Rusting of the internal mechanism can cause irreparable damage.
- Do not leave the lens next to open flames or in other extremely hot locations. Extreme heat could damage or warp exterior parts made from reinforced plastic.
- Rapid changes in temperature may cause damaging condensation inside and outside the lens. Before taking the lens from a warm to a cold environment or vice versa, place it in a bag or plastic case to slow the change in temperature.
- We recommend that you place the lens in a case (available separately) to protect it from scratches during transport.

## **Lens Care**

- Removing dust is normally sufficient to clean the glass surfaces of the lens.
- Smudges, fingerprints, and other oily stains can be removed from the lens surface using a soft, clean cotton cloth or lens cleaning tissue lightly dampened with a small amount of ethanol or lens cleaner. Wipe gently from the center outwards in a circular motion, taking care not to leave smears or touch the lens with your fingers.
- Never use organic solvents such as paint thinner or benzene to clean the lens.
- Neutral Color (NC) filters (available separately) and the like can be used to protect the front lens element.
- If the lens will not be used for an extended period, store it in a cool, dry location to prevent mold and rust. Do not store in direct sunlight or with naphtha or camphor moth balls.

## **Accessories**

### **■ ■ *Supplied Accessories***

- LC-46B 46 mm snap-on Front Lens Cap
- LF-N1 Rear Lens Cap (a different cap may be supplied with lens kits)

### **■ ■ *Compatible Accessories***

- CL-C4 Lens Case
- HN-40 Screw-on Lens Hood
- 46 mm screw-on filters

#### **✓ Filters**

- Use only one filter at a time.
- Remove the lens hood before attaching filters.

## Specifications

<b>Mount</b>	Nikon Z mount
<b>Focal length</b>	16 – 50 mm
<b>Maximum aperture</b>	f/3.5 – 6.3
<b>Lens construction</b>	9 elements in 7 groups (including 1 ED element and 4 aspherical elements)
<b>Angle of view</b>	83°–31° 30' (DX image area)
<b>Focal length scale</b>	Graduated in millimeters (16, 24, 35, 50)
<b>Focusing system</b>	Internal focusing system
<b>Vibration reduction</b>	Lens shift using voice coil motors (VCMs)
<b>Minimum focus distance (measured from focal plane)</b>	<ul style="list-style-type: none"><li>• 16 mm zoom position: 0.25 m (0.82 ft)</li><li>• 24 mm zoom position: 0.2 m (0.66 ft)</li><li>• 35 mm zoom position: 0.23 m (0.76 ft)</li><li>• 50 mm zoom position: 0.3 m (0.99 ft)</li></ul>
<b>Maximum reproduction ratio</b>	0.2×
<b>Diaphragm blades</b>	7 (rounded diaphragm opening)
<b>Aperture range</b>	<ul style="list-style-type: none"><li>• 16 mm zoom position: f/3.5 – 22</li><li>• 50 mm zoom position: f/6.3 – 40</li></ul>
<b>Filter-attachment size</b>	46 mm (P = 0.75 mm)
<b>Dimensions</b>	Approx. 70 mm/2.8 in. maximum diameter × 32 mm/1.3 in. (distance from camera lens mount flange when lens is retracted)
<b>Weight</b>	Approx. 135 g (4.8 oz)

Nikon reserves the right to change the appearance, specifications, and performance of this product at any time and without prior notice.

# NIKKOR Z DX 50–250mm f/4.5–6.3 VR Lens User's Manual

This section is included as a lens manual for purchasers of the NIKKOR Z DX 50–250mm f/4.5–6.3 VR lens kit. Note that lens kits may not be available in some countries or regions.

## Using the Lens

### Parts of the Lens: Names and Functions

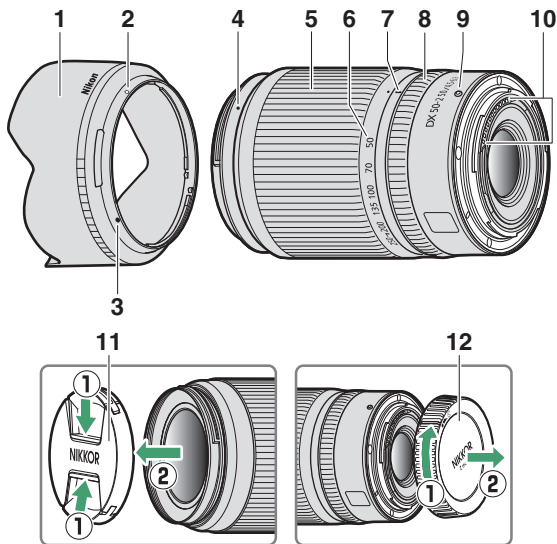

**Note:** The rear cap included with the lens that comes with the lens kit may differ from that shown, in which case it can be removed without performing Step ①.

1	<b>Lens hood*</b>	Lens hoods block stray light that would otherwise cause flare or ghosting. They also serve to protect the lens.
2	<b>Lens hood lock mark</b>	Use when attaching the lens hood.
3	<b>Lens hood alignment mark</b>	
4	<b>Lens hood mounting mark</b>	
5	<b>Zoom ring</b>	Rotate to zoom in or out. Be sure to extend the lens before use.
6	<b>Focal length scale</b>	Determine the approximate focal length when zooming the lens in or out.
7	<b>Focal length mark</b>	
8	<b>Control ring</b>	<b>Autofocus mode selected:</b> In autofocus mode, rotate the ring to adjust a setting such as <b>Focus (M/A)</b> or <b>Aperture</b> assigned using the camera. For more information, see the description of <b>Custom control assignment/Custom controls (shooting)</b> in the camera manual.
		<b>Manual focus mode selected:</b> Rotate the ring to focus.
9	<b>Lens mounting mark</b>	Use when mounting the lens on the camera.
10	<b>CPU contacts</b>	Used to transfer data to and from the camera.
11	<b>Front lens cap</b>	—
12	<b>Rear lens cap</b>	—

\* Available separately.

## ■■ Attachment and Removal

### Attaching the Lens

---

- 1** Turn the camera off, remove the body cap, and detach the rear lens cap.
- 
- 2** Position the lens on the camera body, keeping the mounting mark on the lens aligned with the mounting mark on the camera body, and then rotate the lens counterclockwise until it clicks into place.

### Removing the Lens

---

- 1** Turn the camera off.
- 
- 2** Press and hold the lens release button while turning the lens clockwise.

## ■ Before Use

The lens is retractable and must be extended before use. Rotate the zoom ring as shown until the lens clicks into the extended position. Pictures can only be taken when the focal length mark points to positions between 50 and 250 on the focal length scale.

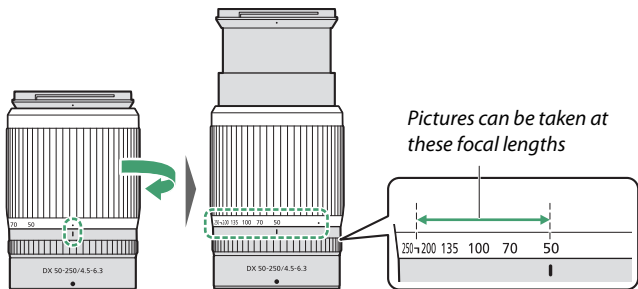

To retract the lens, rotate the zoom ring in the opposite direction, stopping when you reach the (●) position on the focal length scale.

If the camera is turned on with the lens retracted, a warning will be displayed. Extend the lens before use.



## ■ ■ Attaching and Removing Optional Lens Hoods

Align the lens hood mounting mark with the lens hood alignment mark (1) and then rotate the hood (2) until the mounting mark is aligned with the lens hood lock mark (3).

To remove the hood, reverse the above steps.

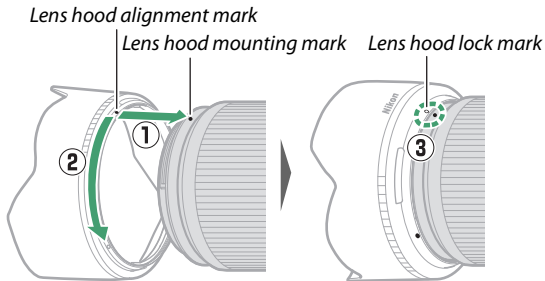

When attaching or removing the hood, hold it near the lens hood alignment mark (●) and avoid gripping the front of the hood too tightly. The hood can be reversed and mounted on the lens when not in use.

## ■ ■ Using Built-in Flash Units

Shadows will be visible in photos where the light from the built-in flash is obscured by the lens or lens hood. Remove the lens hood before shooting. Note, however, that even if the hood is removed, shadows may still be visible at some focal lengths and subject distances.

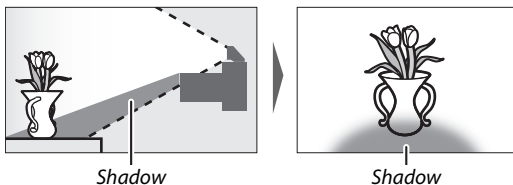

## ■ ■ Vibration Reduction (VR)

The lens's on-board vibration reduction can be enabled or disabled using camera controls; see the camera manual for details. Vibration reduction reduces blur caused by camera shake, allowing shutter speeds up to 5.0 stops slower than would otherwise be the case and increasing the range of shutter speeds available.

**Note:** The effects of VR on shutter speed are measured according to Camera and Imaging Products Association (CIPA) standards. DX-format lenses are measured using a DX-format camera with on-camera VR set to **Normal**. Zoom lenses are measured at maximum zoom.

## ■ ■ *When the Lens Is Attached*

- The focus position may change if you turn the camera off and then on again after focusing. If you have focused on a pre-selected location while waiting for your subject to appear, we recommend that you do not turn the camera off until the picture is taken.
- Mounting this lens on an FX-format camera:
  - selects the DX image area, reducing the available focus points and number of pixels recorded, and
  - disables the **Image Dust Off ref photo** option in the setup menu.
- Movies shot with the lens mounted on a Z 6 and 1920 × 1080 120p, 1920 × 1080 100p, or 1920 × 1080 slow-motion selected for **Frame size/frame rate** in the movie shooting menu will be recorded at the following frame sizes and rates:
  - 1920 × 1080; 120p → 1920 × 1080; 60p
  - 1920 × 1080; 100p → 1920 × 1080; 50p
  - 1920 × 1080; 30p ×4 (slow-motion) → 1920 × 1080; 30p
  - 1920 × 1080; 25p ×4 (slow-motion) → 1920 × 1080; 25p
  - 1920 × 1080; 24p ×5 (slow-motion) → 1920 × 1080; 24p

## **Precautions for Use**

- Do not pick up or hold the lens or camera using only the lens hood.
- Keep the CPU contacts clean.
- Due to the design of the vibration reduction system, the lens may rattle when shaken. This does not indicate a malfunction.
- Replace the front and rear lens caps when the lens is not in use.
- To protect the interior of the lens, store it out of direct sunlight.
- Do not leave the lens in humid locations or in locations in which it may be exposed to moisture. Rusting of the internal mechanism can cause irreparable damage.
- Do not leave the lens next to open flames or in other extremely hot locations. Extreme heat could damage or warp exterior parts made from reinforced plastic.
- Rapid changes in temperature may cause damaging condensation inside and outside the lens. Before taking the lens from a warm to a cold environment or vice versa, place it in a bag or plastic case to slow the change in temperature.
- We recommend that you place the lens in a case (available separately) to protect it from scratches during transport.

## **Lens Care**

- Removing dust is normally sufficient to clean the glass surfaces of the lens.
- Smudges, fingerprints, and other oily stains can be removed from the lens surface using a soft, clean cotton cloth or lens cleaning tissue lightly dampened with a small amount of ethanol or lens cleaner. Wipe gently from the center outwards in a circular motion, taking care not to leave smears or touch the lens with your fingers.
- Never use organic solvents such as paint thinner or benzene to clean the lens.
- Neutral Color (NC) filters (available separately) and the like can be used to protect the front lens element.
- If the lens will not be used for an extended period, store it in a cool, dry location to prevent mold and rust. Do not store in direct sunlight or with naphtha or camphor moth balls.

## **Accessories**

### **■ ■ *Supplied Accessories***

- LC-62B 62 mm snap-on Front Lens Cap
- LF-N1 Rear Lens Cap (a different cap may be supplied with lens kits)

### **■ ■ *Compatible Accessories***

- CL-C1 Lens Case
- HB-90A Bayonet Hood
- 62 mm screw-on filters

#### **✓ Filters**

- Use only one filter at a time.
- Remove the lens hood before attaching filters or rotating circular polarizing filters.

## Specifications

<b>Mount</b>	Nikon Z mount
<b>Focal length</b>	50 – 250 mm
<b>Maximum aperture</b>	f/4.5 – 6.3
<b>Lens construction</b>	16 elements in 12 groups (including 1 ED element)
<b>Angle of view</b>	31° 30'–6° 30' (DX image area)
<b>Focal length scale</b>	Graduated in millimeters (50, 70, 100, 135, 200, 250)
<b>Focusing system</b>	Internal focusing system
<b>Vibration reduction</b>	Lens shift using voice coil motors (VCMs)
<b>Minimum focus distance (measured from focal plane)</b>	<ul style="list-style-type: none"><li>• 50 mm zoom position: 0.5 m (1.64 ft)</li><li>• 70 mm zoom position: 0.52 m (1.71 ft)</li><li>• 100 mm zoom position: 0.58 m (1.91 ft)</li><li>• 135 mm zoom position: 0.65 m (2.14 ft)</li><li>• 200 mm zoom position: 0.83 m (2.73 ft)</li><li>• 250 mm zoom position: 1.0 m (3.29 ft)</li></ul>
<b>Maximum reproduction ratio</b>	0.23×
<b>Diaphragm blades</b>	7 (rounded diaphragm opening)
<b>Aperture range</b>	<ul style="list-style-type: none"><li>• 50 mm zoom position: f/4.5 – 22</li><li>• 250 mm zoom position: f/6.3 – 32</li></ul>
<b>Filter-attachment size</b>	62 mm (P = 0.75 mm)
<b>Dimensions</b>	Approx. 74 mm/3 in. maximum diameter × 110 mm/4.4 in. (distance from camera lens mount flange when lens is retracted)
<b>Weight</b>	Approx. 405 g (14.3 oz)

Nikon reserves the right to change the appearance, specifications, and performance of this product at any time and without prior notice.

## Lenses That May Block the Built-in Flash and AF-Assist Illuminator

The lenses listed in this section may block the built-in flash or AF-assist illuminator under some conditions.

### AF-Assist Illumination

The AF-assist illuminator has a range of about 1.0–3.0 m (3 ft 4 in.–9 ft 10 in.); when using the illuminator, use a lens with a focal length of 16–300 mm. Some lenses may block the illuminator at certain focus distances.

- Remove lens hoods when using the illuminator.
- The following lenses interfere with AF-assist illumination:

#### Lenses that prevent the use of AF-assist illumination for autofocus

NIKKOR Z 14–30mm f/4 S

#### Lenses that limit the range at which AF-assist illumination can be used for autofocus

NIKKOR Z 24–70mm f/2.8 S

AF-assist illumination cannot be used for autofocus at distances under 2.5 m (8 ft 3 in.)

## The Built-in Flash

The built-in flash can be used with lenses with focal lengths of 16–300 mm, although in some cases the flash may be unable to entirely light the subject at some ranges or focal lengths due to shadows cast by the lens.

- Peripheral illumination may drop at focal lengths under 16 mm.
- The NIKKOR Z 14–30mm f/4 S casts shadows in photos taken with the built-in flash at all focal lengths. Other lenses that restrict use of the built-in flash are as follows:

Lens	Minimum shadow-free focal length/ minimum shadow-free focus distance
NIKKOR Z DX 16–50mm f/3.5–6.3 VR	16 mm/0.6 m (2 ft) 24–50 mm/No vignetting
NIKKOR Z 24–70mm f/2.8 S	70 mm/1 m (3 ft 4 in.)
NIKKOR Z DX 50–250mm f/4.5–6.3 VR	50 mm/1 m (3 ft 4 in.) 70 mm/0.8 m (2 ft 8 in.) 100–250 mm/No vignetting

### ✓ Red-Eye Reduction

Lenses that block the subject's view of the red-eye reduction lamp may interfere with red-eye reduction.

### ✓ More on the Built-in Flash

- The built-in flash has a minimum range of about 0.6 m (2 ft).
- Remove lens hoods to prevent shadows.

**Note:** Shadows appear in photographs when the lens blocks the light from the flash.

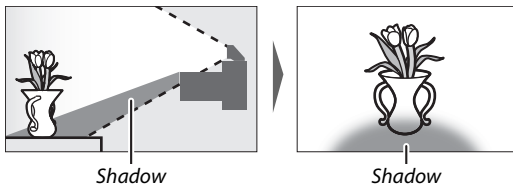



# Trademarks and Licenses

## Trademark Information

IOS is a trademark or registered trademark of Cisco Systems, Inc., in the United States and/or other countries and is used under license. Windows is either a registered trademark or a trademark of Microsoft Corporation in the United States and/or other countries. Mac, macOS, OS X, Apple®, App Store®, the Apple logos, iPhone®, iPad®, and iPod touch® are trademarks of Apple Inc. registered in the U.S. and/or other countries. Android, Google Play and the Google Play logo are trademarks of Google LLC. The Android robot is reproduced or modified from work created and shared by Google and used according to terms described in the Creative Commons 3.0 Attribution License. PictBridge is a trademark of the Camera and Imaging Products Association (CIPA). The SD, SDHC, and SDXC logos are trademarks of the SD-3C, LLC. HDMI, the HDMI logo and High-Definition Multimedia Interface are trademarks or registered trademarks of HDMI Licensing, LLC.

## **HDMI**

Wi-Fi and the Wi-Fi logo are trademarks or registered trademarks of the Wi-Fi Alliance. The Bluetooth® word mark and logos are registered trademarks owned by Bluetooth SIG, Inc. and any use of such marks by Nikon Corporation is under license.

All other trade names mentioned in this manual or the other documentation provided with your Nikon product are trademarks or registered trademarks of their respective holders.

Use of the Made for Apple badge means that an accessory has been designed to connect specifically to the Apple products identified in the badge, and has been certified by the developer to meet Apple performance standards. Apple is not responsible for the operation of this device or its compliance with safety and regulatory standards. Please note that the use of this accessory with an Apple product may affect wireless performance.

### **FreeType License (FreeType2)**

Portions of this software are copyright © 2012 The FreeType Project (<https://www.freetype.org>). All rights reserved.

### **MIT License (HarfBuzz)**

Portions of this software are copyright © 2018 The HarfBuzz Project (<https://www.freedesktop.org/wiki/Software/HarfBuzz>). All rights reserved.

### **AVC Patent Portfolio License**

THIS PRODUCT IS LICENSED UNDER THE AVC PATENT PORTFOLIO LICENSE FOR THE PERSONAL AND NON-COMMERCIAL USE OF A CONSUMER TO (i) ENCODE VIDEO IN COMPLIANCE WITH THE AVC STANDARD (“AVC VIDEO”) AND/OR (ii) DECODE AVC VIDEO THAT WAS ENCODED BY A CONSUMER ENGAGED IN A PERSONAL AND NON-COMMERCIAL ACTIVITY AND/OR WAS OBTAINED FROM A VIDEO PROVIDER LICENSED TO PROVIDE AVC VIDEO. NO LICENSE IS GRANTED OR SHALL BE IMPLIED FOR ANY OTHER USE. ADDITIONAL INFORMATION MAY BE OBTAINED FROM MPEG LA, L.L.C. SEE <https://www.mpegla.com>

## Unicode® Character Database License (Unicode® Character Database)

This software incorporates Unicode® Character Database open-source code. The license for this open-source code is given below.

### COPYRIGHT AND PERMISSION NOTICE

Copyright © 1991-2019 Unicode, Inc. All rights reserved.

Distributed under the Terms of Use in

<https://www.unicode.org/copyright.html>.

Permission is hereby granted, free of charge, to any person obtaining a copy of the Unicode data files and any associated documentation (the "Data Files") or Unicode software and any associated documentation (the "Software") to deal in the Data Files or Software without restriction, including without limitation the rights to use, copy, modify, merge, publish, distribute, and/or sell copies of the Data Files or Software, and to permit persons to whom the Data Files or Software are furnished to do so, provided that either

- (a) this copyright and permission notice appear with all copies of the Data Files or Software, or
- (b) this copyright and permission notice appear in associated Documentation.

THE DATA FILES AND SOFTWARE ARE PROVIDED "AS IS", WITHOUT WARRANTY OF ANY KIND, EXPRESS OR IMPLIED, INCLUDING BUT NOT LIMITED TO THE WARRANTIES OF MERCHANTABILITY, FITNESS FOR A PARTICULAR PURPOSE AND NONINFRINGEMENT OF THIRD PARTY RIGHTS.

IN NO EVENT SHALL THE COPYRIGHT HOLDER OR HOLDERS INCLUDED IN THIS NOTICE BE LIABLE FOR ANY CLAIM, OR ANY SPECIAL INDIRECT OR CONSEQUENTIAL DAMAGES, OR ANY DAMAGES WHATSOEVER RESULTING FROM LOSS OF USE, DATA OR PROFITS, WHETHER IN AN ACTION OF CONTRACT, NEGLIGENCE OR OTHER TORTIOUS ACTION, ARISING OUT OF OR IN CONNECTION WITH THE USE OR PERFORMANCE OF THE DATA FILES OR SOFTWARE.

Except as contained in this notice, the name of a copyright holder shall not be used in advertising or otherwise to promote the sale, use or other dealings in these Data Files or Software without prior written authorization of the copyright holder.

# Index

## Symbols

(Auto mode) .....	40, 44
<b>P</b> (Programmed auto) .....	75, 76
<b>S</b> (Shutter-priority auto) .....	75, 76
<b>A</b> (Aperture-priority auto) .....	75, 77
<b>M</b> (Manual) .....	75, 78
<b>U1/U2</b> .....	75, 82
<b>SCN</b> (Scene) .....	75, 84
(Portrait) .....	85
(Landscape) .....	85
(Child) .....	85
(Sports) .....	86
(Close up) .....	86
(Night portrait) .....	86
(Night landscape) .....	87
(Party/indoor) .....	87
(Beach/snow) .....	87
(Sunset) .....	88
(Dusk/dawn) .....	88
(Pet portrait) .....	88
(Candlelight) .....	89
(Blossom) .....	89
(Autumn colors) .....	89
(Food) .....	90
<b>EFCT</b> (Special effects) .....	75, 91
(Night vision) .....	92
<b>VI</b> (Super vivid) .....	92
<b>POP</b> (Pop) .....	92
(Photo illustration) .....	93, 96
(Toy camera effect) .....	93, 96
(Miniature effect) .....	94, 97
(Selective color) .....	94, 98
(Silhouette) .....	95
(High key) .....	95
(Low key) .....	95
(Single frame) .....	135, 262
<b>L</b> (Continuous L) .....	135

<b>H</b> (Continuous H) .....	135
<b>H'</b> (Continuous H (extended)) ..	135
(Self-timer) .....	135, 138
(Silent photography) .....	71
(Electronic front-curtain shutter) ...	279
(Mechanical shutter) .....	279
(Pinpoint AF) .....	54
(Single-point AF) .....	54
(Dynamic-area AF) .....	55
(Wide-area AF (S)) .....	55
(Wide-area AF (L)) .....	55
(Auto-area AF) .....	56
(Matrix) .....	131
(Center-weighted) .....	131
(Spot) .....	131
(Highlight-weighted) .....	131
(Red-eye reduction) .....	108, 129
(Slow sync) .....	108, 129
(Rear-curtain sync) .....	108, 129
(Exposure compensation) .....	102
button .....	48, 149
button .....	50, 168
<b>MENU</b> button .....	21
<b>ISO</b> button .....	100, 101
(AF-ON) button .....	20, 74, 104
button .....	20, 23, 149
button .....	20, 149, 166
<b>i</b> button .....	24, 114
button .....	21
(In-focus indicator) .....	65
(Flash-ready indicator) .....	435
icon .....	39

## Numerics

1 : 1 (16 × 16) .....	128
16 : 9 (24 × 14) .....	128

**A**

Accessories .....	437
Access-point mode.....	352, 353
Active D-Lighting .....	133
ADL bracketing .....	225
AE bracketing .....	218
AE lock.....	104, 105
AF .....	51, 269
AF activation .....	270
AF fine-tune.....	311
AF lock.....	104, 105
AF speed.....	303
AF tracking sensitivity .....	303
AF-area mode .....	54
AF-assist.....	42, 272
<b>AF-C</b> .....	52
AF-C priority selection.....	269
<b>AF-F</b> .....	52, 148
<b>AF-S</b> .....	52
After delete.....	184
Airplane mode.....	317
Android .....	377
Aperture .....	77
Aperture-priority auto.....	77
Apply settings to live view.....	281
Attaching the lens.....	36
Attenuator .....	264
Authentication/encryption.....	319
Auto (Set Picture Control) .....	116
Auto (White balance) .....	68, 120
Auto bracketing.....	217
Auto  ISO sensitivity control .....	283
Auto distortion control .....	211, 261
Auto FP high-speed sync.....	282
Auto ISO sensitivity control .	101, 196
Auto send.....	322, 365
Auto-area AF .....	56
Auto-area AF face/eye detection	269
Autoexposure lock.....	104, 105
Autofocus.....	51, 269

Automatic display switch .....	8
--------------------------------	---

**B**

Battery.....	31, 32
Battery charger .....	31, 460
Battery endurance.....	464
Battery level .....	34
Beep options .....	316
Bluetooth .....	377
Body cap .....	36, 437
Bracketing order.....	284
Built-in flash .....	29, 107
Bulb.....	80

**C**

Camera Control Pro 2 .....	442
Center-weighted.....	131, 275
Charge lamp .....	439, 440
Charging AC adapter....	437, 439, 450
Charging the battery .....	31
Choose color temp. (White balance) 69, 122, 200	
Choose image area.....	193
Choose start/end point .....	162
CL mode shooting speed.....	278
Clock.....	39
Clock battery .....	39
Cloudy (White balance) .....	68, 120
Color space.....	209
Color temperature.....	69, 122, 200
Command dial .....	9, 294
Compatible lenses.....	422, 451
Conformity marking .....	324
Connect to computers.....	351
Connect to PC .....	320, 391
Connect to smart device .....	318
Connect to smart devices .....	369
Continuous.....	262
Continuous H .....	135
Continuous H (extended) .....	135
Continuous L .....	135

Continuous release mode....	135, 262
Control ring.....	65, 466, 476
Copyright information .....	315
CPU contacts.....	466, 476
Creative Lighting System (CLS)...	432
Creative Picture Control .....	116
Crop .....	159
Custom control assignment. 27, 286, 298	
Custom controls .....	298
Custom controls (playback) .....	292
Custom controls (shooting) .....	286
Custom Picture Control	205, 206, 260
Custom Settings .....	176, 265
Customize command dials .....	294
Customize <b>Fn</b> menu .....	25, 285, 297

## D

Date and time.....	307
Date format .....	307
Daylight saving time.....	307
DCF .....	461
Default settings .....	171, 409
Delete.....	50, 168, 183
Delete all images.....	169
Delete current image.....	50, 168
Delete selected images.....	169
Deselecting pictures .....	365
Diffraction compensation....	211, 261
Diopter adjustment control .....	7
Direct connection to PC.....	353
Direct sunlight (White balance)....	68, 120
Disconnecting and reconnecting .....	368
<b>DISP</b> button.....	18
Distortion control.....	338
D-Lighting.....	336
Download center .....	iv
DX .....	128
Dynamic-area AF.....	55, 140

## E

Easy connect.....	358
Edit movie .....	162, 343
Electronic VR.....	147, 263
Energy saving.....	325
Error messages .....	417, 419
Errors (Wireless connections) .....	390
Establish Wi-Fi connection.....	319
EV steps for exposure cntrl.....	274
Exif.....	461
Exposure .....	102, 274
Exposure comp. for flash .....	283
Exposure compensation ....	102, 274, 283
Exposure data .....	152
Exposure delay mode .....	278
Exposure indicator .....	79
Exposure lock.....	104, 105
Exposures remaining.....	34
Extensions .....	193
External microphone.....	145, 438
Eye sensor.....	7
Eye-detection AF.....	58

## F

Face-detection AF .....	58
File information.....	152
File naming .....	193, 258
File number sequence .....	280
Filter effects .....	119
Fine-tune optimal exposure .....	275
Fine-tuning white balance ..	121, 198
Firmware version .....	326
Flash .....	129, 401, 432
Flash (White balance).....	69, 120
Flash compensation .....	111, 216
Flash control.....	213, 404
Flash mode.....	108, 129
Flash off.....	109, 129
Flash pop-up control.....	29, 107

Flash ready indicator.....	435	Image Dust Off ref photo.....	312
Flash shutter speed .....	283	Image overlay.....	340
Flash sync speed.....	282	Image quality .....	126, 194
Flat (Set Picture Control).....	116	Image review .....	150, 184
Flexible program .....	76	Image sensor .....	2, 447
Flick .....	14	Image size.....	128, 194
Flicker reduction.....	212, 261	Incandescent (White balance).....	68, 120
Fluorescent (White balance) .	68, 120	In-focus indicator.....	65
<b>Fn1</b> button .....	27	Information display.....	18, 310, 426
<b>Fn2</b> button .....	27	Infrastructure mode.....	352, 357
Focal length.....	468, 478	Interval timer shooting.....	239
Focal length scale.....	468, 478	iOS .....	383
Focal plane mark .....	66	IP address.....	321, 361
Focus indicator.....	65	ISO sensitivity .....	100, 196, 259
Focus lock .....	104, 105	i-TTL .....	403, 404, 432
Focus mode.....	51	<b>J</b>	
Format memory card .....	306	<hr/>	
Frame rate.....	136, 143	JPEG .....	126
Frame size/frame rate.....	143, 258	<b>L</b>	
Framing grid display .....	281	<hr/>	
Frequency response.....	264	L (large) .....	128
Full-frame playback.....	14, 48, 149	Landscape (Set Picture Control) ..	116
Function buttons.....	27	Language .....	306
FV lock.....	112, 436	Lens.....	36, 465, 475
<b>H</b>		Lens mount .....	36
<hr/>		Lens mounting mark .....	36
HDMI .....	317, 399, 461	Limit selectable image area .....	279
HDMI connector .....	399	Location data .....	157, 317
HDMI recorders .....	400	Location data display .....	317
Help .....	23	Long exposure NR.....	210
Hi .....	100	Low-light AF .....	271
High Dynamic Range (HDR) .....	234	<b>M</b>	
High ISO NR.....	210, 260	<hr/>	
Highlight display .....	304	M (medium) .....	128
Highlights.....	66, 131, 153	MAC address.....	322
Highlight-weighted.....	131	Main command dial .....	9
Histogram .....	153, 154	Manage Picture Control .....	206, 260
<b>I</b>		Manual.....	78, 404
<hr/>		Manual focus.....	52, 65
Image area .....	193	Manual focus ring in AF mode.....	273
Image comment .....	314		

Matrix metering.....	131
Max. continuous release.....	278
Maximum aperture.....	435
Maximum sensitivity.....	101, 196
Memory buffer.....	137
Memory card.....	32, 462, 463
Memory card capacity.....	463
Menu guide.....	171
Metering.....	131
<b>MF</b> .....	52
Microphone.....	145, 438
Microphone sensitivity.....	145, 263
Miniature effect.....	97
Minimum shutter speed.....	196
Mired.....	200
Mode dial.....	9, 75
Monitor.....	5, 12, 423
Monitor brightness.....	307
Monitor mode button.....	8
Monitor pre-flash.....	113
Monochrome (Set Picture Control) ...	116
Movie file type.....	258
Movie quality.....	143, 258
Movie shooting menu.....	175, 257
Movie-record button.....	45
Movies.....	44, 48, 141
Multi selector.....	21
Multiple exposure.....	227
My Menu.....	345

## N

---

Natural light auto (White balance) ....	68, 120
NEF (RAW).....	126, 195
NEF (RAW) processing.....	330
NEF (RAW) recording.....	195
Network settings.....	321, 353, 357
Neutral (Set Picture Control).....	116
Number of focus points.....	270
Number of shots.....	464

NX Studio.....	73, 392, 442
----------------	--------------

## O

---

OK button.....	292
Optical AWL.....	406, 408
Optical VR.....	139, 216, 263
Overview data.....	158

## P

---

Pairing.....	389
Peaking highlights.....	281
Perspective control.....	339
Photo Illustration.....	96
Photo information.....	151
Photo shooting menu.....	172, 188
Photo/movie selector.....	40, 44
PictBridge.....	396, 461
Picture Controls.....	116, 204, 260
PIN-entry WPS.....	358
Pinpoint AF.....	54, 140
Playback.....	14, 48, 149
Playback display options.....	183
Playback folder.....	183
Playback menu.....	171, 182
Playback zoom.....	15, 154, 166
Portrait (Set Picture Control).....	116
Power off delay.....	277
Preset manual (White balance).....	69, 123, 202

Press the shutter-release button all the way down..... 43

Press the shutter-release button halfway..... 42

Problems and solutions..... 410

Product serial number..... 4

Programmed auto..... 76

Protecting photographs..... 74

Push-button WPS..... 358

## Q

---

Quick crop.....	159
-----------------	-----



Quick retouch ..... 336  
Quick sharp..... 119

## R

---

Rating ..... 187  
Rear-curtain sync.....108, 129  
Recent settings.....345, 349  
Rechargeable Li-ion battery. 31, 437, 460  
Red-eye correction ..... 337  
Red-eye reduction ..... 108, 129  
Release button to use dial..... 296  
Release mode ..... 135  
Remote flash photography..401, 405  
Remote photography ..... 369  
Removing the lens from the camera 37  
Reset ..... 189, 258, 268, 326  
Reset all settings..... 326  
Reset custom settings ..... 268  
Reset movie shooting menu ..... 258  
Reset photo shooting menu ..... 189  
Reset user settings..... 83, 306  
Resize..... 334  
Restoring default settings..... 409  
Retouch menu..... 327  
Reverse indicators..... 296  
RGB..... 153, 193, 209  
Rotate tall..... 150, 185

## S

---

S (small) ..... 128  
Same as photo settings..... 141  
Save current frame ..... 165  
Save user settings ..... 82, 306  
Scene mode .....84  
Search for Wi-Fi network ..... 358  
Select date ..... 169, 170  
Select to send to smart device .... 161  
Select to send/deselect..... 161  
Selecting pictures for upload..... 364

Selective color..... 98  
Self-portrait mode ..... 13, 317  
Self-timer ..... 135, 138, 276  
Send while off .....319  
Sensitivity ..... 100  
Set Picture Control ..... 116, 204, 260  
Setup menu ..... 180, 305  
Shade (White balance)..... 120  
Shooting data ..... 155  
Shutter speed..... 76, 78  
Shutter type .....279  
Shutter-priority auto..... 76  
Shutter-release button ..... 42, 43  
Shutter-release button AE-L .....276  
Side-by-side comparison .....343  
Silent photography..... 71, 256  
Single frame..... 135, 262  
Single-point AF..... 54, 140, 148  
Size ..... 128, 194  
Slide show .....186  
Slot empty release lock.....325  
Slow sync ..... 108, 129  
Slow-motion movies.....144  
Smart device ..... 132, 318, 369  
SnapBridge..... 39, 369  
Special effects mode ..... 91  
Specifications ..... 451  
Spot..... 131  
SSID..... 319, 353, 358  
Standard (Set Picture Control) ..... 116  
Standard i-TTL fill-flash ..... 432  
Standby timer ..... 43, 277  
Storage folder ..... 189  
Straighten.....337  
Sub-command dial..... 9  
Subject tracking ..... 62

## T

---

Text entry..... 16, 190  
Thumbnail ..... 15, 150  
Tilting monitor..... 3

Time .....	80	Wireless remote (ML-L7) options	323
Time zone .....	307	Wireless Transmitter Utility .....	351
Time zone and date.....	307		
Time-lapse movie.....	249		
Touch controls .....	12, 63, 316		
Touch screen .....	12, 63		
Touch shutter .....	12, 63		
Trademark Information.....	487		
Trim .....	333		
Trim movie.....	343		
Trimming movies .....	162, 343		
Tripod.....	80		
Troubleshooting.....	409		

## U

---

USB .....	396
User settings .....	82, 306
Using an on-camera flash .....	402

## V

---

View all in continuous mode .....	281
Viewfinder .....	7, 429
Viewfinder brightness .....	308
Viewfinder color balance .....	309
Viewfinder eyepiece .....	7, 438
Viewfinder eyepiece cap .....	438
Viewfinder focus.....	7
Vignette control .....	211, 261
Virtual horizon.....	18, 19
Vivid (Set Picture Control).....	116
Volume.....	49, 316

## W

---

WB (White balance) .....	67, 120
WB bracketing .....	222
White balance .....	67, 120
Wide-area AF .....	55, 140, 148
Wi-Fi .....	132, 351
Wi-Fi connection .....	320
Wi-Fi mode .....	371
Wind noise reduction .....	264

# Added Functions

## Updating Camera Firmware

To view the camera firmware version or update the camera firmware, select **Firmware version** in the setup menu. The latest firmware for the Z 50 is available for download from the Nikon Download Center.

<https://downloadcenter.nikonimglib.com/>

## Features Available with “C” Firmware Version 2.10

The new features available with camera “C” firmware version 2.10 are described below.

### Saving the Focus Position

A **Save focus position** option has been added to the setup menu. If **On** is selected, the focus position in effect when the camera is turned off will be restored when the camera is next turned on.

- The focus position may change with adjustments to zoom or fluctuations in ambient temperature.
- This option applies only when the camera is used with Z mount autofocus lenses.
- Selecting **On** may increase camera startup times.



## Features Available with “C” Firmware Version 2.30

### New Options for Custom Setting f2 “Custom Controls (Shooting)”: “Save Focus Position” and “Recall Focus Position”

**Save focus position** and **Recall focus position** have been added to the roles that can be assigned to camera controls using Custom Setting f2 (**Custom controls (shooting)**). You can save the current focus position by assigning **Save focus position** to **Lens Fn button** and then pressing and holding the lens **Fn** button. The saved position can be instantly restored by assigning **Recall focus position** to **Lens Fn2 button** and pressing the lens **Fn2** button (“memory recall”). You may find this useful if you frequently return to subjects at a fixed focus distance.

- Memory recall is available only when an autofocus Z mount lens equipped with **Fn** and **Fn2** buttons is mounted on the camera. If the lens is not equipped with an **Fn2** button, the camera cannot save the focus position even if the **Save focus position** is assigned to the lens **Fn** button.
- Focus positions can be saved and recalled in both photo and movie modes.
- Focus positions can be saved in any focus mode.
- The stored focus position is reset when the lens is detached.

- 1 Select **Save focus position for Custom Setting f2 (Custom controls (Shooting)) > Lens Fn button.**

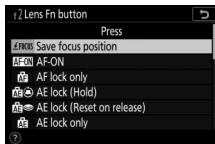

- 2 Select **Recall focus position for Custom Setting f2 (Custom controls (Shooting)) > Lens Fn2 button.**

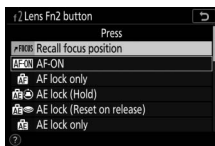

- 3 Focus on the desired subject in the shooting display and press and hold the lens Fn button.

If the operation is successful, an icon will appear in the shooting display to indicate that the focus position has been saved.

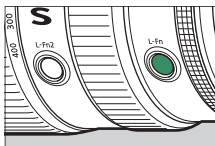

- 4 Press the lens Fn2 button.

- The saved focus position will be restored.
- Holding the lens **Fn2** button activates manual focus, and the camera will not refocus if the shutter-release button is pressed halfway while the control is pressed.

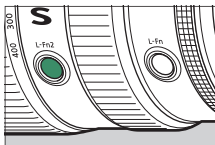

### ✔ Cautions: Memory Recall

- Focus positions cannot be saved while shooting information is displayed.
- Changes in ambient temperature may result in focus being recalled to a position different from that at which it was saved.
- Previously-saved focus positions tend to change if recalled after lens focal length is adjusted via zoom. If a saved focus position is recalled after the lens focal length is adjusted, the camera will sound four short beeps, provided that an option other than **Off** is selected for **Beep options > Beep on/off** in the setup menu.

### ✔ Beep

- If an option other than **Off** is selected for **Beep options > Beep on/off** in the setup menu, the camera will sound two short beeps when a focus position is saved or recalled in photo mode.
- A beep does not sound in silent photography, movie mode or when **Off** is selected for **Beep options > Beep on/off**.

## Features Available with “C” Firmware Version 2.40

### Support for Eye-Detection AF in Movie Mode

Updating to “C” firmware version 2.40 allows the use of eye-detection AF (a feature that detects and focuses on the eyes of humans, dogs, and cats) in movie mode, a mode in which it was not supported in earlier versions (“C” firmware versions 2.30 and earlier).

“C” firmware versions 2.30  
and earlier

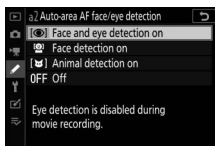

“C” firmware version 2.40

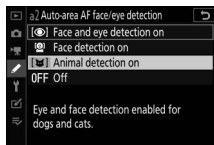
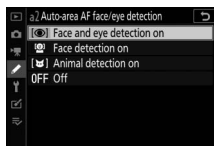

## Features Available with “C” Firmware Version 2.50

### Support for Power Zoom Lenses

#### ■ ■ *New Options for Custom Settings f2 “Custom Controls (Shooting)” and g2 “Custom Controls”: “Power Zoom +” and “Power Zoom –”*





**Power zoom +** and **Power zoom –** have been added to the roles that can be assigned to camera controls for Custom Settings f2 **Custom controls (shooting)** and g2 **Custom controls**. If you assign **Power zoom +** to **Fn1 button**, you can zoom in electronically (power zoom) while pressing the **Fn1 button**. If you assign **Power zoom –** to **Fn2 button**, you can zoom out electronically while pressing the **Fn2 button**.

- These options apply only with power zoom lenses.
- When **Fn1 button** in Custom Setting f2 **Custom controls (shooting)** or g2 **Custom controls** is set to **Power zoom +**, **Power zoom –** is selected for **Fn2 button**.
- When **Fn2 button** in Custom Setting f2 **Custom controls (shooting)** or g2 **Custom controls** is set to **Power zoom –**, **Power zoom +** is selected for **Fn1 button**.
- In self-portrait mode, power zoom operation using the **Fn1** and **Fn2** buttons is disabled.



## ■ ■ New Options for Custom Settings: f7 and g5 “Power Zoom (PZ) Button Options”

**Power zoom (PZ) button options** has been added as Custom Settings f7 and g5. Adjust the power zoom settings.

Item	Description
<b>Use / buttons</b>	<p>If <b>On</b> is selected, you can zoom in electronically while pressing the  button and zoom out while pressing the  button (power zoom).</p> <ul style="list-style-type: none"><li>• If the ML-L7 Remote Control is connected to the camera, you can also zoom with the remote control's + button (telephoto) and - button (wide-angle) when <b>On</b> is selected.</li></ul>
<b>Power zoom speed</b>	<p>You can select the speed at which the lens zooms in and out using buttons assigned with the power zoom role by selecting negative values for a slower speed, or positive values for a faster speed.</p> <ul style="list-style-type: none"><li>• In Custom Setting g5 <b>Power zoom (PZ) button options</b>, you can set <b>Pre/post recording</b> and <b>During recording</b> separately.</li></ul>

- These options apply only with power zoom lenses.
- The addition of this menu item has changed the number of Custom Setting **Highlight display** from g5 to g6.

### ✔ Lens Noise

Noise from the lens during zoom may be audible in video footage. If you notice lens noise when you use buttons assigned with the power zoom role, setting Custom Setting g5 **Power zoom (PZ) button options > Power zoom speed > During recording** to slower zoom speeds is recommended.

### ✔ Camera Operation Sounds

Operation sounds when pressing the camera buttons to zoom may be audible in video footage. If you are concerned about operation sounds when using buttons for power zoom, we recommend using the following to zoom.

- A smart device with the SnapBridge app installed (power zoom operation may not be available depending on the version of the SnapBridge app)
- ML-L7 Remote Control

### ■ ■ *New Option for the Setup Menu: “Save Zoom Position (PZ Lenses)”*

A **Save zoom position (PZ lenses)** option has been added to the setup menu. If **On** is selected, the camera will save the zoom position in effect when the camera is turned off and restore it when the camera is turned on.

- This option applies only with power zoom lenses.
- The zoom position is reset if the lens is replaced by one with a different product name.

### ■ ■ *New Indicator for Focal Length in the Shooting Display*

A focal length indicator has been added to the shooting display. Displayed only with power zoom lenses.

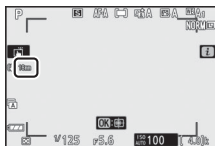

No reproduction in any form of this manual, in whole or in part (except for brief quotation in critical articles or reviews), may be made without written authorization from NIKON CORPORATION.

**NIKON CORPORATION**

---

© 2019 Nikon Corporation



SB3F08(11)  
6MOA3011-08