

Nikon

DIGITAL CAMERA

D_f

User's Manual



Nikon Manual Viewer 2

Use the Nikon Manual Viewer 2 app to view manuals anytime, anywhere on your smartphone or tablet.

En

Thank you for your purchase of a Nikon single-lens reflex (SLR) digital camera. To get the most from your camera, please be sure to read all instructions thoroughly and keep them where they will be read by all who use the product.

Symbols and Conventions

To make it easier to find the information you need, the following symbols and conventions are used:



This icon marks cautions; information that should be read before use to prevent damage to the camera.



This icon marks notes; information that should be read before using the camera.



This icon marks references to other pages in this manual.

Menu items, options, and messages displayed in the camera monitor are shown in **bold**.

Camera Settings

The explanations in this manual assume that default settings are used.

Help

Use the camera's on-board help feature for help on menu items and other topics. See page 15 for details.

Nikon Manual Viewer 2



Install the Nikon Manual Viewer 2 app on your smartphone or tablet to view Nikon digital camera manuals, anytime, anywhere. Nikon Manual Viewer 2 can be downloaded free of charge from the App Store and Google Play. Download of the app and any product manuals requires an Internet connection, for which fees may be levied by your phone or Internet service provider.

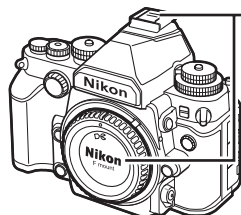


For Your Safety

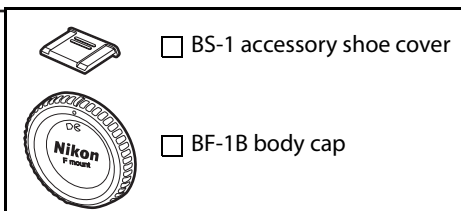
Before using the camera for the first time, read the safety instructions in "For Your Safety" (📖 x–xii).

Package Contents

Confirm that the package contains the following items:

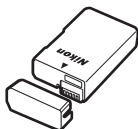


Df camera



BS-1 accessory shoe cover

BF-1B body cap



EN-EL14a
rechargeable Li-ion
battery (with terminal
cover)



MH-24 battery charger
(plug adapter supplied
in countries or regions
where required; shape
depends on country of
sale.)



DK-26 eyepiece
cap (☞ 23)

AN-DC9 strap (☞ 18)

UC-E6 USB cable

String for eyepiece cap (☞ 23)

ViewNX 2 CD

Warranty

User's Manual (this manual)

Purchasers of the lens kit option should confirm that the package also includes a lens. *Memory cards are sold separately* (☞ 363). Cameras purchased in Japan display menus and messages in English and Japanese only; other languages are not supported. We apologize for any inconvenience this may cause.

Table of Contents

For Your Safety	x
Notices.....	xiii
Introduction	1
<hr/>	
Getting to Know the Camera.....	1
Camera Menus.....	15
First Steps	18
Basic Photography and Playback	29
<hr/>	
Taking Photographs	29
Basic Playback.....	34
Deleting Unwanted Photographs	35
Exposure Mode	36
<hr/>	
P: Programmed Auto	38
S: Shutter-Priority Auto	39
1/3 STEP (Exposure Modes S and M)	40
A: Aperture-Priority Auto.....	41
M: Manual.....	42
Long Time-Exposures (M Mode Only)	44
Release Mode	46
<hr/>	
Choosing a Release Mode	46
Self-Timer Mode.....	48
Mirror up Mode	50

Image Recording Options **51**

Image Area	51
Image Quality and Size	55
Image Quality	55
Image Size	58

Focus **59**

Autofocus	59
Autofocus Mode	59
AF-Area Mode	62
Focus Point Selection	64
Focus Lock	66
Manual Focus	68

ISO Sensitivity **70**

The ISO Sensitivity Dial	70
Auto ISO Sensitivity Control	72

Exposure **75**

Metering	75
Autoexposure Lock	77
Exposure Compensation	79

White Balance **81**

White Balance Options	81
Fine-Tuning White Balance	84
Choosing a Color Temperature	88
Preset Manual	90
Viewfinder Photography	90
Live View (Spot White Balance)	93
Managing Presets	96

Image Enhancement **100**

Picture Controls	100
Creating Custom Picture Controls	106
Preserving Detail in Highlights and Shadows	110
Active D-Lighting	110
High Dynamic Range (HDR)	112

Flash Photography **116**

Using a Flash	116
i-TTL Flash Control	124
Flash Modes	125
Flash Compensation	128
FV Lock	130

Other Shooting Options **133**

Two-Button Reset: Restoring Default Settings	133
Bracketing	136
Multiple Exposure	149
Interval Timer Photography	156
Non-CPU Lenses	163
Non-AI Lenses	167
Location Data	170

Live View Photography

172

Focusing in Live View	175
Using the i Button	179
The Live View Display: Live View Photography	180
The Information Display: Live View Photography.....	182
Manual Focus	183

More on Playback

185



Full-Frame Playback	185
Photo Information	188
Thumbnail Playback	196
Calendar Playback.....	197
Taking a Closer Look: Playback Zoom.....	199
Protecting Photographs from Deletion.....	201
Deleting Photographs	203
Full-Frame, Thumbnail, and Calendar Playback	203
The Playback Menu	205




Connections

208

Installing ViewNX 2	208
Using ViewNX 2.....	211
Copy Pictures to the Computer	211
View Pictures	213
Printing Photographs.....	214
Viewing Photographs on TV.....	222

Defaults	224
▶ The Playback Menu: Managing Images	229
Playback Folder.....	230
Hide Image	230
Playback Display Options.....	232
Image Review	232
After Delete	233
Rotate Tall	233
Slide Show	234
📷 The Shooting Menu: Shooting Options	235
Shooting Menu Bank	236
Storage Folder.....	237
File Naming	239
Color Space	240
Vignette Control.....	241
Auto Distortion Control	241
Long Exposure NR (Long Exposure Noise Reduction).....	242
High ISO NR.....	242
✍ Custom Settings: Fine-Tuning Camera Settings.....	243
Custom Settings Bank	245
a: Autofocus.....	246
a1: AF-C Priority Selection.....	246
a2: AF-S Priority Selection	246
a3: Focus Tracking with Lock-On	247
a4: AF Activation	247
a5: Focus Point Illumination.....	248
a6: Focus Point Wrap-Around	249
a7: Number of Focus Points	249
b: Metering/Exposure	250
b1: Center-Weighted Area	250
b2: Fine-tune Optimal Exposure.....	250
c: Timers/AE Lock.....	251
c1: Shutter-Release Button AE-L.....	251
c2: Standby timer	251
c3: Self-Timer	252
c4: Monitor off Delay	253

d: Shooting/Display.....	253
d1: Beep	253
d2: Viewfinder Grid Display	253
d3: ISO Display.....	254
d4: Screen Tips.....	254
d5: CL Mode Shooting Speed	254
d6: Max. Continuous Release	254
d7: File Number Sequence.....	255
d8: Information Display.....	256
d9: LCD Illumination.....	256
d10: Exposure Delay Mode	256
e: Bracketing/Flash	257
e1: Flash Sync Speed	257
e2: Flash Shutter Speed.....	258
e3: Optional Flash.....	258
e4: Exposure Comp. for Flash.....	259
e5: Modeling Flash.....	259
e6: Auto Bracketing Set.....	259
e7: Auto Bracketing (Mode M)	260
e8: Bracketing Order.....	260
f: Controls.....	261
f1:  Button.....	261
f2: OK Button.....	261
f3: Multi Selector	262
f4: Assign Fn Button.....	263
f5: Assign Preview Button.....	266
f6: Assign AE-L/AF-L Button.....	267
f7: Customize Command Dials	267
f8: Release Button to Use Dial	269
f9: Slot Empty Release Lock	269
f10: Reverse Indicators.....	269
f11: Easy Shutter-Speed Shift	270
 The Setup Menu: Camera Setup.....	271
Format Memory Card.....	272
Monitor Brightness	273
Auto Info Display	273
Image Dust Off Ref Photo.....	274
Flicker Reduction	276
Time Zone and Date.....	276

Language	277
Auto Image Rotation	277
Image Comment	278
Copyright Information	279
Save/Load Settings.....	280
Virtual Horizon	282
AF Fine-tune	283
Assign Remote Fn Button	284
Wireless Mobile Adapter	284
Eye-Fi Upload	285
Firmware Version	286
 The Retouch Menu: Creating Retouched Copies	287
Creating Retouched Copies	289
D-Lighting.....	291
Red-Eye Correction.....	292
Trim	293
Monochrome	294
Filter Effects.....	295
Color Balance.....	296
Image Overlay	297
NEF (RAW) Processing	300
Resize.....	302
Quick Retouch.....	304
Straighten	304
Distortion Control.....	305
Fisheye	305
Color Outline	306
Color Sketch.....	306
Perspective Control.....	307
Miniature Effect	308
Selective Color	309
Side-by-side Comparison.....	311
 My Menu/  Recent Settings.....	313
Recent Settings	317

Compatible Lenses	318
Other Accessories	323
Attaching a Power Connector and AC Adapter	326
Caring for the Camera.....	328
Storage.....	328
Cleaning	328
The Low-Pass Filter	329
“Clean Now”	329
“Clean at Startup/Shutdown”	330
Manual Cleaning.....	331
Caring for the Camera and Battery: Cautions.....	335
Exposure Program (Mode P)	339
Troubleshooting	340
Battery/Display	340
Shooting.....	341
Playback	343
Miscellaneous.....	345
Error Messages	346
Specifications	352
AF-S NIKKOR 50mm f/1.8G (Special Edition)	360
Approved Memory Cards	363
Memory Card Capacity	364
Battery Life	367
Index.....	368

For Your Safety

To prevent damage to your Nikon product or injury to yourself or to others, read the following safety precautions in their entirety before using this equipment. Keep these safety instructions where all those who use the product will read them.

The consequences that could result from failure to observe the precautions listed in this section are indicated by the following symbol:



This icon marks warnings. To prevent possible injury, read all warnings before using this Nikon product.

■ ■ WARNINGS

Keep the sun out of the frame

Keep the sun well out of the frame when shooting backlit subjects. Sunlight focused into the camera when the sun is in or close to the frame could cause a fire.

Do not look at the sun through the viewfinder

Viewing the sun or other strong light source through the viewfinder could cause permanent visual impairment.

Using the viewfinder diopter adjustment control

When operating the viewfinder diopter adjustment control with your eye to the viewfinder, care should be taken not to put your finger in your eye accidentally.

Do not use in the presence of flammable gas

Do not use electronic equipment in the presence of flammable gas, as this could result in explosion or fire.

Turn off immediately in the event of malfunction

Should you notice smoke or an unusual smell coming from the equipment or AC adapter (available separately), unplug the AC adapter and remove the battery immediately, taking care to avoid burns. Continued operation could result in injury. After removing the battery, take the equipment to a Nikon-authorized service center for inspection.

Do not disassemble

Touching the product's internal parts could result in injury. In the event of malfunction, the product should be repaired only by a qualified technician. Should the product break open as the result of a fall or other accident, remove the battery and/or AC adapter and then take the product to a Nikon-authorized service center for inspection.

- ⚠ Keep out of reach of children**
Failure to observe this precaution could result in injury. In addition, note that small parts constitute a choking hazard. Should a child swallow any part of this equipment, consult a physician immediately.
- ⚠ Do not place the strap around the neck of an infant or child**
Placing the camera strap around the neck of an infant or child could result in strangulation.
- ⚠ Do not remain in contact with the camera, battery, or charger for extended periods while the devices are on or in use**
Parts of the device become hot. Leaving the device in direct contact with the skin for extended periods may result in low-temperature burns.
- ⚠ Do not leave the product where it will be exposed to extremely high temperatures, such as in an enclosed automobile or in direct sunlight**
Failure to observe this precaution could cause damage or fire.
- ⚠ Observe proper precautions when handling batteries**
Batteries may leak or explode if improperly handled. Observe the following precautions when handling batteries for use in this product:
- Use only batteries approved for use in this equipment.
 - Do not short or disassemble the battery.
 - Be sure the product is off before replacing the battery. If you are using an AC adapter, be sure it is unplugged.
 - Do not attempt to insert the battery upside down or backwards.
 - Do not expose the battery to flame or to excessive heat.
 - Do not immerse in or expose to water.
 - Replace the terminal cover when transporting the battery. Do not transport or store the battery with metal objects such as necklaces or hairpins.
 - Batteries are prone to leakage when fully discharged. To avoid damage to the product, be sure to remove the battery when no charge remains.
 - When the battery is not in use, attach the terminal cover and store in a cool, dry place.
 - The battery may be hot immediately after use or when the product has been used on battery power for an extended period. Before removing the battery turn the camera off and allow the battery to cool.
 - Discontinue use immediately should you notice any changes in the battery, such as discoloration or deformation.

⚠ Observe proper precautions when handling the charger

- Keep dry. Failure to observe this precaution could result in injury or product malfunction due to fire or electric shock.
- Dust on or near the metal parts of the plug should be removed with a dry cloth. Continued use could result in fire.
- Do not go near the charger during thunderstorms. Failure to observe this precaution could result in electric shock.
- Do not handle the plug or charger with wet hands. Failure to observe this precaution could result in injury or product malfunction due to fire or electric shock.
- Do not use with travel converters or adapters designed to convert from one voltage to another or with DC-to-AC inverters. Failure to observe this precaution could damage the product or cause overheating or fire.

⚠ Use appropriate cables

When connecting cables to the input and output jacks, use only the cables provided or sold by Nikon for the purpose to maintain compliance with product regulations.

⚠ CD-ROMs

CD-ROMs containing software or manuals should not be played back on audio CD equipment. Playing CD-ROMs on an audio CD player could cause hearing loss or damage the equipment.

⚠ Do not aim a flash at the operator of a motor vehicle

Failure to observe this precaution could result in accidents.

⚠ Observe caution when using the flash

- Using optional flash units in close contact with the skin or other objects could cause burns.
- Using optional flash units close to the subject's eyes could cause temporary visual impairment. The flash should be no less than one meter (3 ft 4 in.) from the subject. Particular care should be observed when photographing infants.

⚠ Avoid contact with liquid crystal

Should the monitor break, care should be taken to avoid injury due to broken glass and to prevent the liquid crystal from the monitor touching the skin or entering the eyes or mouth.

⚠ Do not carry tripods with a lens or camera attached

You could trip or accidentally strike others, resulting in injury.

⚠ Follow the instructions of airline and hospital personnel

This camera transmits radio frequencies that could interfere with medical equipment or aircraft navigation. Disable the wireless network feature and remove all wireless accessories from the camera before boarding an aircraft, and turn the camera off during take off and landing. In medical facilities, follow staff instructions regarding the use of wireless devices.

Notices

- No part of the manuals included with this product may be reproduced, transmitted, transcribed, stored in a retrieval system, or translated into any language in any form, by any means, without Nikon's prior written permission.
- Nikon reserves the right to change the specifications of the hardware and software described in these manuals at any time and without prior notice.
- Nikon will not be held liable for any damages resulting from the use of this product.
- While every effort has been made to ensure that the information in these manuals is accurate and complete, we would appreciate it were you to bring any errors or omissions to the attention of the Nikon representative in your area (address provided separately).

Notices for Customers in Canada

CAN ICES-3 B / NMB-3 B

Notices for Customers in Europe

CAUTION

RISK OF EXPLOSION IF BATTERY IS REPLACED BY AN INCORRECT TYPE. DISPOSE OF USED BATTERIES ACCORDING TO THE INSTRUCTIONS.

This symbol indicates that electrical and electronic equipment is to be collected separately.



The following apply only to users in European countries:

- This product is designated for separate collection at an appropriate collection point. Do not dispose of as household waste.
- Separate collection and recycling helps conserve natural resources and prevent negative consequences for human health and the environment that might result from incorrect disposal.
- For more information, contact the retailer or the local authorities in charge of waste management.

This symbol on the battery indicates that the battery is to be collected separately.



The following apply only to users in European countries:

- All batteries, whether marked with this symbol or not, are designated for separate collection at an appropriate collection point. Do not dispose of as household waste.
- For more information, contact the retailer or the local authorities in charge of waste management.

Notices for Customers in the U.S.A.

The Battery Charger

IMPORTANT SAFETY INSTRUCTIONS—SAVE THESE INSTRUCTIONS

DANGER—TO REDUCE THE RISK OF FIRE OR ELECTRIC SHOCK, CAREFULLY FOLLOW THESE INSTRUCTIONS

For connection to a supply not in the U.S.A., use an attachment plug adapter of the proper configuration for the power outlet if needed. This power unit is intended to be correctly oriented in a vertical or floor mount position.

Federal Communications Commission (FCC) Radio Frequency Interference Statement

This equipment has been tested and found to comply with the limits for a Class B digital device, pursuant to Part 15 of the FCC rules.

These limits are designed to provide reasonable protection against harmful interference in a residential installation. This equipment generates, uses, and can radiate radio frequency energy and, if not installed and used in accordance with the instructions, may cause harmful interference to radio communications. However, there is no guarantee that interference will not occur in a particular installation. If this equipment does cause harmful interference to radio or television reception, which can be determined by turning the equipment off and on, the user is encouraged to try to correct the interference by one or more of the following measures:

- Reorient or relocate the receiving antenna.
- Increase the separation between the equipment and receiver.
- Connect the equipment into an outlet on a circuit different from that to which the receiver is connected.
- Consult the dealer or an experienced radio/television technician for help.



Nikon
Df

CAUTIONS

Modifications

The FCC requires the user to be notified that any changes or modifications made to this device that are not expressly approved by Nikon Corporation may void the user's authority to operate the equipment.

Interface Cables

Use the interface cables sold or provided by Nikon for your equipment. Using other interface cables may exceed the limits of Class B Part 15 of the FCC rules.

Nikon Inc., 1300 Walt Whitman Road,
Melville, New York 11747-3064, U.S.A.
Tel.: 631-547-4200

Disposing of Data Storage Devices

Please note that deleting images or formatting memory cards or other data storage devices does not completely erase the original image data. Deleted files can sometimes be recovered from discarded storage devices using commercially available software, potentially resulting in the malicious use of personal image data. Ensuring the privacy of such data is the user's responsibility.

Before discarding a data storage device or transferring ownership to another person, erase all data using commercial deletion software, or format the device and then completely refill it with images containing no private information (for example, pictures of empty sky). Be sure to also replace any pictures selected for preset manual (☐ 90). Care should be taken to avoid injury when physically destroying data storage devices.

Notice Concerning Prohibition of Copying or Reproduction

Note that simply being in possession of material that has been digitally copied or reproduced by means of a scanner, digital camera, or other device may be punishable by law.

• Items prohibited by law from being copied or reproduced

Do not copy or reproduce paper money, coins, securities, government bonds, or local government bonds, even if such copies or reproductions are stamped "Sample."

The copying or reproduction of paper money, coins, or securities which are circulated in a foreign country is prohibited.

Unless the prior permission of the government has been obtained, the copying or reproduction of unused postage stamps or post cards issued by the government is prohibited.

The copying or reproduction of stamps issued by the government and of certified documents stipulated by law is prohibited.

• Cautions on certain copies and reproductions

The government has issued cautions on copies or reproductions of securities issued by private companies (shares, bills, checks, gift certificates, etc.), commuter passes, or coupon tickets, except when a minimum of necessary copies are to be provided for business use by a company. Also, do not copy or reproduce passports issued by the government, licenses issued by public agencies and private groups, ID cards, and tickets, such as passes and meal coupons.

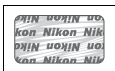
• Comply with copyright notices

The copying or reproduction of copyrighted creative works such as books, music, paintings, woodcuts, prints, maps, drawings, movies, and photographs is governed by national and international copyright laws. Do not use this product for the purpose of making illegal copies or to infringe copyright laws.

Use Only Nikon Brand Electronic Accessories

Nikon cameras are designed to the highest standards and include complex electronic circuitry. Only Nikon brand electronic accessories (including chargers, batteries, AC adapters, and flash accessories) certified by Nikon specifically for use with this Nikon digital camera are engineered and proven to operate within the operational and safety requirements of this electronic circuitry.

The use of non-Nikon electronic accessories could damage the camera and may void your Nikon warranty. The use of third-party rechargeable Li-ion batteries not bearing the Nikon holographic seal shown at right could interfere with normal operation of the camera or result in the batteries overheating, igniting, rupturing, or leaking.



For more information about Nikon brand accessories, contact a local authorized Nikon dealer.

Use Only Nikon Brand Accessories

Only Nikon brand accessories certified by Nikon specifically for use with your Nikon digital camera are engineered and proven to operate within its operational and safety requirements. THE USE OF NON-NIKON ACCESSORIES COULD DAMAGE YOUR CAMERA AND MAY VOID YOUR NIKON WARRANTY.

Servicing the Camera and Accessories

The camera is a precision device and requires regular servicing. Nikon recommends that the camera be inspected by the original retailer or a Nikon-authorized service representative once every one to two years, and that it be serviced once every three to five years (note that fees apply to these services). Frequent inspection and servicing are particularly recommended if the camera is used professionally. Any accessories regularly used with the camera, such as lenses or optional flash units, should be included when the camera is inspected or serviced.

Before Taking Important Pictures

Before taking pictures on important occasions (such as at weddings or before taking the camera on a trip), take a test shot to ensure that the camera is functioning normally. Nikon will not be held liable for damages or lost profits that may result from product malfunction.

Life-Long Learning

As part of Nikon's "Life-Long Learning" commitment to ongoing product support and education, continually-updated information is available on-line at the following sites:

- **For users in the U.S.A.:** <http://www.nikonusa.com/>
- **For users in Europe and Africa:** <http://www.europe-nikon.com/support/>
- **For users in Asia, Oceania, and the Middle East:** <http://www.nikon-asia.com/>

Visit these sites to keep up-to-date with the latest product information, tips, answers to frequently-asked questions (FAQs), and general advice on digital imaging and photography. Additional information may be available from the Nikon representative in your area. See the following URL for contact information: <http://imaging.nikon.com/>

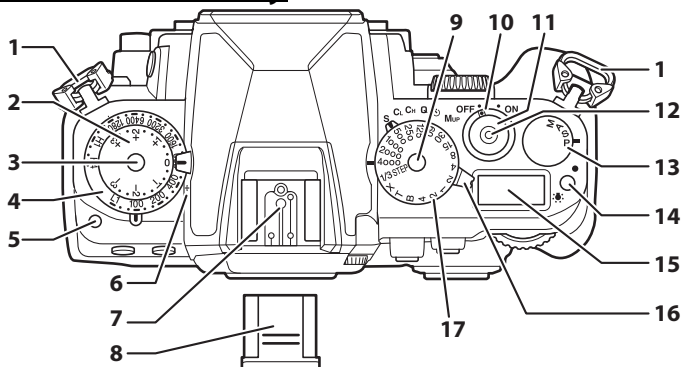


Introduction

Getting to Know the Camera

Take a few moments to familiarize yourself with camera controls and displays. You may find it helpful to bookmark this section and refer to it as you read through the rest of the manual.

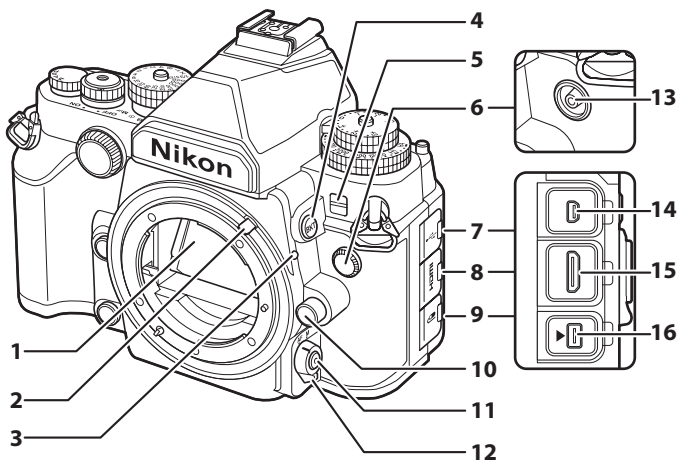
The Camera Body



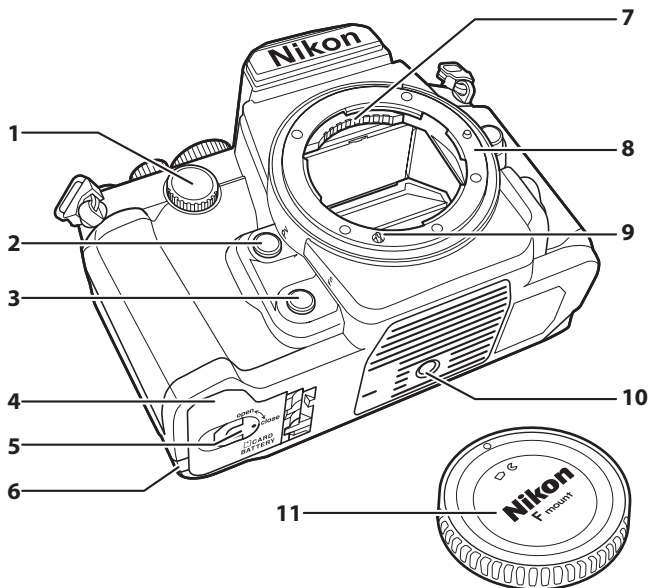
1 Eyelet for camera strap	10 Power switch.....5
2 Exposure compensation dial79	11 Shutter-release button.....31
3 Exposure compensation dial lock release79	12 Release socket 323
4 ISO sensitivity dial70	13 Exposure mode dial 6
5 ISO sensitivity dial lock release ...70	14 * button
6 Focal plane mark (☉)69	LCD illuminator.....5
7 Accessory shoe (for optional flash unit)..... 116	Two-button reset 133
8 Accessory shoe cover..... 116	15 Control panel.....8
9 Shutter-speed dial lock release...39	16 Release mode dial 7
	17 Shutter-speed dial39



The Camera Body (Continued)



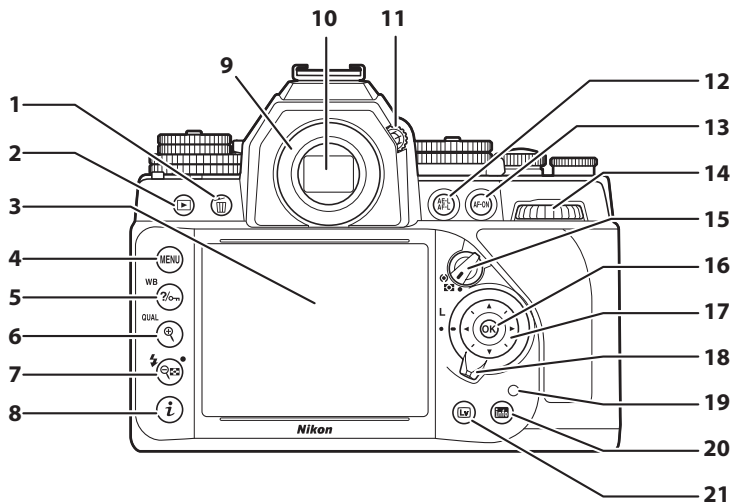
1	Mirror.....	50	9	Cover for accessory terminal	325
2	Metering coupling lever	167	10	Lens release button	25
3	Lens mounting mark	24	11	AF-mode button....	60, 63, 175, 176
4	BKT button Bracketing	137, 141, 145	12	Focus-mode selector	59, 68, 175
5	Self-timer lamp	48	13	Flash sync terminal	117
6	Flash sync terminal cap		14	USB connector	211, 214
7	USB connector cover		15	HDMI mini-pin connector	222
8	HDMI connector cover		16	Accessory terminal.....	325



1	Sub-command dial.....	267	6	Power connector cover	326
2	Pv button Using the Pv button.....	41, 174, 266	7	CPU contacts	
3	Fn button Using the Fn button.....	263	8	Lens mount	24
4	Battery-chamber/memory card slot cover	19	9	AF coupling	
5	Battery-chamber/memory card slot cover latch	19	10	Tripod socket	
			11	Body cap	24, 324



The Camera Body (Continued)



1	🗑️ button Delete..... 35, 203
2	▶ button Playback..... 34, 185
3	Monitor Viewing settings 11 Viewing pictures 34 Live view 172 Full-frame playback 185
4	MENU button Menu 15, 224
5	WB/Protect button Help 15 Protect.....201 White balance 82
6	QUAL button Playback zoom in..... 199 Image quality/size.....56, 58

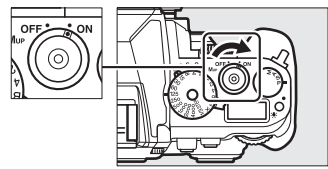
7	Playback zoom out/ thumbnails..... 196, 197 Two-button reset.....133 Flash mode.....126 Flash compensation.....128
8	i button Changing settings in the information display..... 14 Changing settings during live view.....179 Retouching pictures290
9	Viewfinder eyepiece 23
10	Viewfinder.....28
11	Diopter adjustment control 28
12	AE-L AF-L button Using the AE/AF lock button 66, 77, 267

13	AF-ON button AF-ON60	18	Focus selector lock64
14	Main command dial 267	19	Memory card access lamp 20, 32
15	Metering selector76	20	info (info) button 11
16	OK (OK) button 16, 261	21	Lv button 172
17	Multi selector 16		

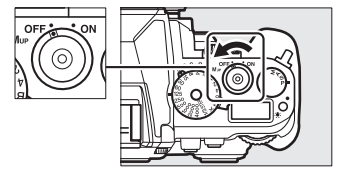


 The Power Switch



Rotate the power switch as shown to turn the camera on.

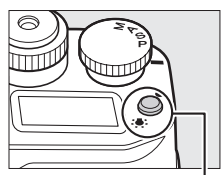


Rotate the power switch as shown to turn the camera off.



 The LCD Illuminator

Pressing the  button while the camera is on activates the control panel backlight (LCD illuminator), allowing the display to be read in the dark. The backlight will remain lit for about 6 seconds or until the shutter is released or the  button is pressed again.

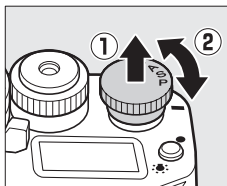


 button

The Exposure Mode Dial

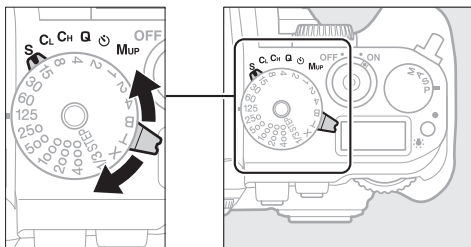
To choose from the modes listed below, lift and rotate the exposure mode dial.

- **P**—**Programmed auto** (📖 38)
- **S**—**Shutter-priority auto** (📖 39)
- **A**—**Aperture-priority auto** (📖 41)
- **M**—**Manual** (📖 42)

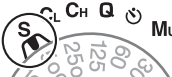







The Release-Mode Dial

Rotate the release mode dial to choose a release mode (📖 46).

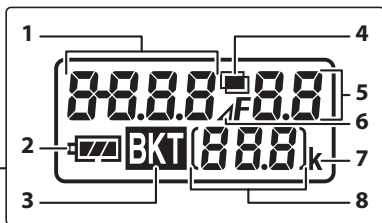
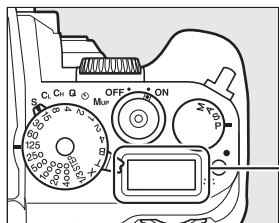


Release mode dial

Mode	Description
 S Single frame	One photograph is taken each time the shutter-release button is pressed.
 CL Continuous low speed	The camera takes photographs at a slow rate while the shutter-release button is pressed.
 CH Continuous high speed	The camera takes photographs at a fast rate while the shutter-release button is pressed.
 Q Quiet shutter-release	As for single-frame, except that camera noise is reduced.
 Self-timer	Take pictures with the self-timer.
 MUP Mirror up	Raise the mirror before taking photographs.

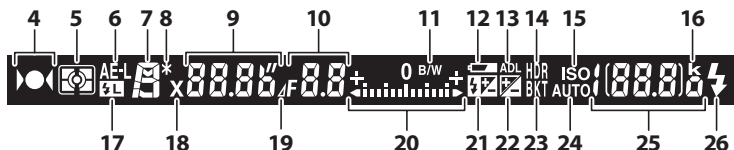
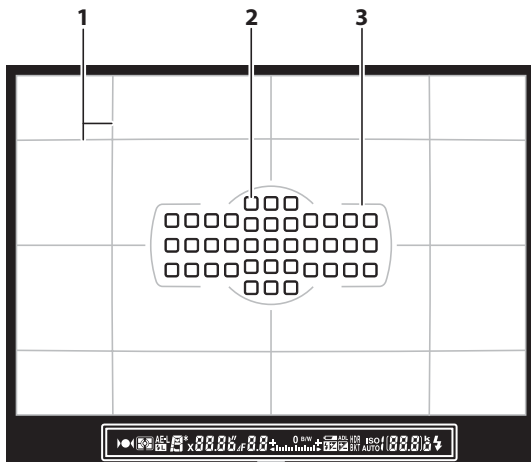


The Control Panel



<p>1 Shutter speed39, 42 Number of intervals for interval timer photography 158</p>	<p>6 Aperture stop indicator 37</p>
<p>2 Battery indicator..... 29</p>	<p>7 “k” (appears when memory remains for over 1000 exposures)..... 30</p>
<p>3 Exposure and flash bracketing indicator 137 WB bracketing indicator 141 ADL bracketing indicator 145</p>	<p>8 Number of exposures remaining 30 Number of shots remaining before memory buffer fills 47 Preset white balance recording indicator 91 Capture mode indicator.....325 HDMI-CEC connection indicator223</p>
<p>4 Multiple exposure indicator 150</p>	
<p>5 Aperture (f-number).....41, 42 Aperture (number of stops)..... 37 Number of shots per interval 158 PC mode indicator325</p>	

The Viewfinder



Note: Display shown with all indicators lit for illustrative purposes.

<p>1 Framing grid (displayed when On is selected for Custom Setting d2) 253</p> <p>2 Focus points 64, 249 AF-area mode 62</p> <p>3 AF area brackets 28, 189</p> <p>4 Focus indicator 32, 69</p> <p>5 Metering 75</p> <p>6 Autoexposure (AE) lock 77</p> <p>7 Exposure mode 36</p>	<p>8 Flexible program indicator 38</p> <p>9 Shutter speed 39, 42 Autofocus mode 59</p> <p>10 Aperture (f-number) 41, 42 Aperture (number of stops) 37</p> <p>11 Monochrome indicator 100 (displayed when the Monochrome Picture Control or a Picture Control based on Monochrome is selected)</p> <p>12 Low battery warning 29</p>
---	---

<p>13 Active D-Lighting indicator 111</p> <p>14 HDR indicator 112</p> <p>15 ISO sensitivity indicator 70</p> <p>16 "k" (appears when memory remains for over 1000 exposures)..... 30</p> <p>17 FV lock indicator 131</p> <p>18 Flash sync indicator 257</p> <p>19 Aperture stop indicator 37</p> <p>20 Exposure indicator 43</p> <p>Exposure compensation display..... 80</p> <p>Roll indicator 265</p> <p>21 Flash compensation indicator... 128</p> <p>22 Exposure compensation indicator 80</p>	<p>23 Exposure and flash bracketing indicator 137</p> <p>WB bracketing indicator 141</p> <p>ADL bracketing indicator 145</p> <p>24 Auto ISO sensitivity indicator 72</p> <p>25 Number of exposures remaining 30</p> <p>Number of shots remaining before memory buffer fills 47</p> <p>Preset white balance recording indicator 91</p> <p>Exposure compensation value... 80</p> <p>Flash compensation value 128</p> <p>ISO sensitivity 70</p> <p>AF-area mode..... 62</p> <p>26 Flash-ready indicator * 121</p>
--	--

* Displayed when an optional flash unit is attached (📖 118). The flash-ready indicator lights when the flash is charged.

✔ No Battery

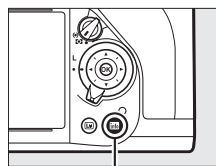
When the battery is totally exhausted or no battery is inserted, the display in the viewfinder will dim. This is normal and does not indicate a malfunction. The viewfinder display will return to normal when a fully-charged battery is inserted.

✔ The Control Panel and Viewfinder Displays

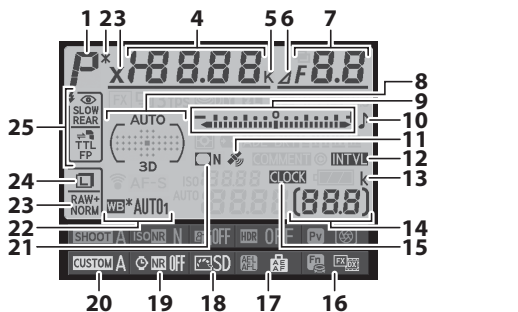
The brightness of the control panel and viewfinder displays varies with temperature, and the response times of the displays may drop at low temperatures. This is normal and does not indicate a malfunction.

The Information Display

Press the **info** button to display shutter speed, aperture, the number of exposures remaining, AF-area mode, and other shooting information in the monitor. The display lights automatically when settings such as white balance and image quality are changed by pressing a button and rotating a command dial.



info button




Note: Display shown with all indicators lit for illustrative purposes.

1 Exposure mode36	5 Color temperature indicator88
2 Flexible program indicator.....38	6 Aperture stop indicator37
3 Flash sync indicator..... 257	Non-AI lens indicator 168
4 Shutter speed 39, 42	7 Aperture (f-number) 41, 42
Number of shots in exposure and flash bracketing sequence 137	Aperture (number of stops)37
Number of shots in WB bracketing sequence 141	Bracketing increment 138, 142
Number of exposures (multiple exposure)..... 151	Number of shots in ADL bracketing sequence..... 145
Focal length (non-CPU lenses) ... 163	Multiple exposure mode..... 150
Color temperature88	Maximum aperture (non-CPU lenses)..... 166





8	Auto-area AF indicator.....	64	15	“Clock not set” indicator.....	27, 276
	Focus points indicator.....	64	16	Fn button assignment.....	263
	AF-area mode indicator.....	64	17	AE-L/AF-L button assignment.....	267
	3D-tracking indicator.....	64	18	Picture Control indicator.....	101
9	Exposure indicator.....	43	19	Long exposure noise reduction indicator.....	242
	Exposure compensation display.....	80	20	Custom settings bank.....	245
	Bracketing progress indicator Exposure and flash bracketing.....	137	21	Vignette control indicator.....	241
	WB bracketing.....	141	22	White balance.....	81
10	“Beep” indicator.....	253		White balance fine-tuning indicator.....	85
11	Satellite signal indicator.....	171	23	Image quality.....	55
12	Interval timer indicator.....	160	24	Image size.....	58
13	“k” (appears when memory remains for over 1000 exposures).....	30	25	Flash mode.....	125
14	Number of exposures remaining.....	30			
	Multiple exposure auto gain indicator.....	152			
	Manual lens number.....	166			

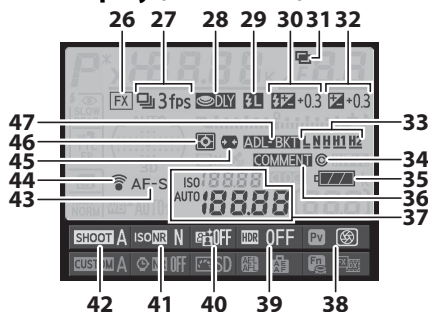
Turning the Monitor Off

To clear shooting information from the monitor, press the  button or press the shutter-release button halfway. The monitor will turn off automatically if no operations are performed for about 10 seconds.

See Also

For information on choosing how long the monitor stays on, see Custom Setting c4 (**Monitor off delay**,  253). For information on changing the color of the lettering in the information display, see Custom Setting d8 (**Information display**,  256). The information display can be set to turn on automatically when the shutter-release button is pressed halfway; for more information, see page 273.

The Information Display (Continued)

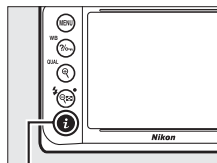


26	Image area indicator.....	52	38	Pv button assignment.....	266
27	Release mode	7, 46	39	HDR indicator.....	113
	Continuous shooting speed.....	254		HDR exposure differential	114
28	Exposure delay mode	256	40	Active D-Lighting indicator	111
29	FV lock indicator	131	41	High ISO noise reduction	
30	Flash compensation indicator..	128		indicator	242
	Flash compensation value.....	128	42	Shooting menu bank.....	236
31	Multiple exposure indicator.....	153	43	Autofocus mode	59
32	Exposure compensation		44	Eye-Fi connection indicator	285
	indicator	80	45	Auto distortion control.....	241
	Exposure compensation value....	80	46	Metering	75
33	ADL bracketing amount.....	111	47	Exposure and flash bracketing	
34	Copyright information	279		indicator	137
35	Camera battery indicator.....	29		WB bracketing indicator	141
36	Image comment indicator.....	278		ADL bracketing indicator	145
37	ISO sensitivity indicator	70			
	ISO sensitivity	70			
	Auto ISO sensitivity indicator	72			

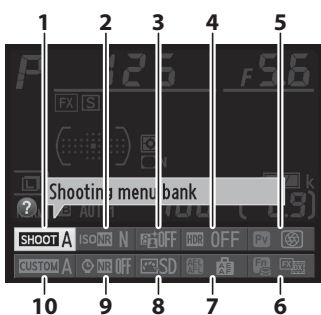


The *i* button

Use the *i* button for quick access to frequently-used settings in playback mode and during viewfinder and live view photography. During viewfinder photography, you can press the *i* button to change the settings listed at the bottom of the information display. Highlight items using the multi selector and press **OK** to view options for the highlighted item.




i button



1	Shooting menu bank	236
2	High ISO noise reduction	242
3	Active D-Lighting	110
4	HDR (High Dynamic Range).....	112
5	Pv button assignment	266
6	Fn button assignment	263
7	AE-L/AF-L button assignment	267
8	Picture Control	100
9	Long exposure noise reduction.....	242
10	Custom settings bank	245

Tool Tips

A tool tip giving the name of the selected item appears in the information display. Tool tips can be turned off using Custom Setting d4 (**Screen Tips**;  254).

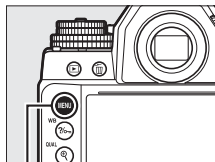
See Also

For information on using the *i* button to access settings during live view photography, see page 179, or see page 290 for information on displaying the retouch options during full-frame playback.



Camera Menu

Most shooting, playback, and setup options can be accessed from the camera menu. To view the menus, press the **MENU** button.

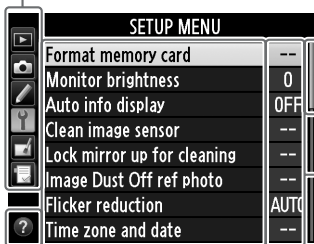


MENU button

Tabs

Choose from the following menus:

- ▶: **Playback** (229)
- 📷: **Shooting** (235)
- 🔧: **Custom Settings** (243)
- ⚙️: **Setup** (271)
- 🖌️: **Retouch** (287)
- 📄/📄: **MY MENU** or **RECENT SETTINGS** (defaults to **MY MENU**; 313)



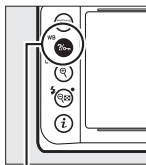
Slider shows position in current menu.

Current settings are shown by icons.

Menu options
Options in current menu.



If a **?** icon is displayed at the bottom left corner of the monitor, help can be displayed by pressing the **?/WB (WB)** button. A description of the currently selected option or menu will be displayed while the button is pressed. Press **▲** or **▼** to scroll through the display.



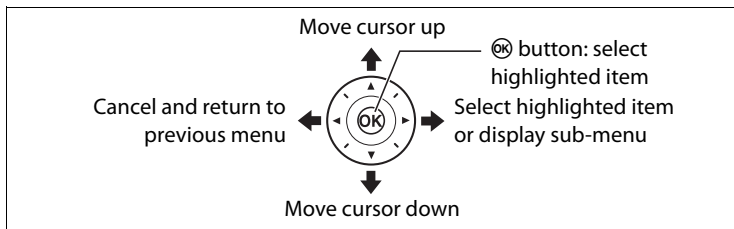
?/WB (WB) button

? Multiple exposure

Record the specified number of shots as a single image. The standby timer is extended by 30 s. If the timer expires, shooting will end and a multiple exposure will be created from any shots that have been taken.

■ Using Camera Menus

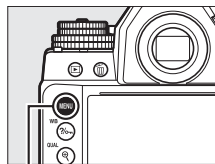
The multi selector and **OK** button are used to navigate the camera menus.



Follow the steps below to navigate the menus.

1 Display the menus.

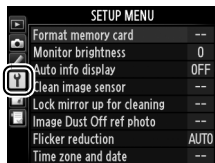
Press the **MENU** button to display the menus.



MENU button

2 Highlight the icon for the current menu.

Press **◀** to highlight the icon for the current menu.



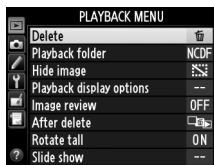
3 Select a menu.

Press **▲** or **▼** to select the desired menu.



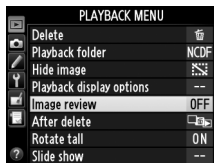
4 Position the cursor in the selected menu.

Press **▶** to position the cursor in the selected menu.



5 Highlight a menu item.

Press **▲** or **▼** to highlight a menu item.



6 Display options.

Press **▶** to display options for the selected menu item.



7 Highlight an option.

Press **▲** or **▼** to highlight an option.



8 Select the highlighted item.

Press **OK** to select the highlighted item.
To exit without making a selection, press the **MENU** button.



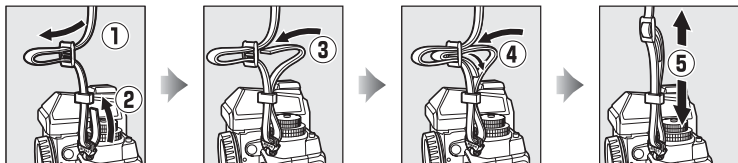
Note the following:

- Menu items that are displayed in gray are not currently available.
- While pressing **▶** generally has the same effect as pressing **OK**, there are some cases in which selection can only be made by pressing **OK**.
- To exit the menus and return to shooting mode, press the shutter-release button halfway (□ 33).

First Steps

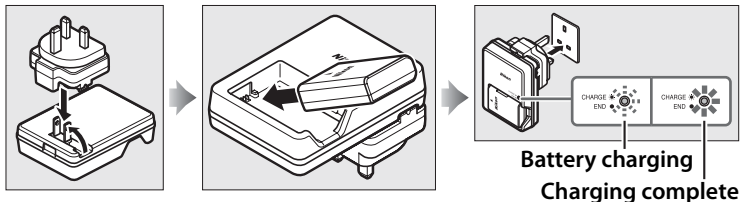
Attach the Camera Strap

Attach the strap securely to the camera eyelets.



Charge the Battery

The camera is powered by an EN-EL14a rechargeable Li-ion battery (supplied). To maximize shooting time, charge the battery in the supplied MH-24 battery charger before use. If a plug adapter is supplied, raise the wall plug and connect the adapter, making sure the plug is fully inserted, then insert the battery and plug the charger in.



About an hour and 50 minutes are required to fully recharge the battery when no charge remains. Unplug the charger and remove the battery when charging is complete.

Charging the Battery

Charge the battery indoors at ambient temperatures between 5 °C–35 °C (41 °F–95 °F). The battery will not charge if its temperature is below 0 °C (32 °F) or above 60 °C (140 °F).

Insert the Battery and a Memory Card

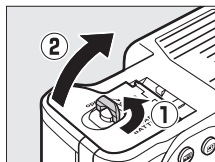
Before inserting batteries or memory cards, rotate the power switch to **OFF**.

✔ Inserting and Removing Batteries and Memory Cards

Always turn the camera off before inserting or removing batteries or memory cards.

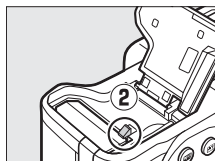
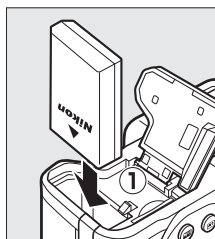
1 Open the battery-chamber/memory card slot cover.

Unlatch (1) and open (2) the battery-chamber/memory card slot cover.



2 Insert the battery.

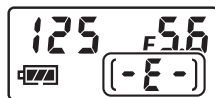
Insert the battery in the orientation shown (1), using the battery to keep the battery latch pressed to one side. The latch locks the battery in place when the battery is fully inserted (2).



Battery latch

✎ No Memory Card

If the camera is turned off with a charged EN-EL14a battery and no memory card inserted, (-E-) will be displayed in the control panel and viewfinder.



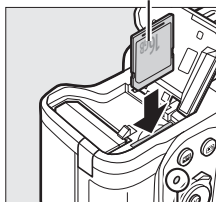
3 Insert the memory card.

Holding the memory card as shown at right, slide it in until it clicks into place. The memory card access lamp will light for a few seconds.

Inserting Memory Cards

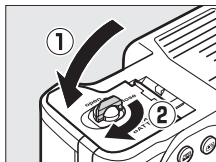
Inserting memory cards upside down or backwards could damage the camera or the card. Check to be sure the card is in the correct orientation. The cover will not close if the card is not correctly inserted.

Front



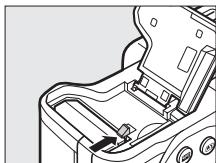
Memory card access lamp

4 Close the battery-chamber/memory card slot cover.



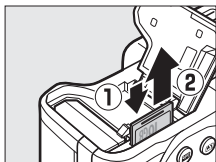
Removing the Battery

Turn the camera off and open the battery-chamber/memory card slot cover. Press the battery latch in the direction shown by the arrow to release the battery and then remove the battery by hand.



Removing Memory Cards

After confirming that the memory card access lamp is off, turn the camera off, open the battery-chamber/memory card slot cover, and press the card in to eject it (1). The card can then be removed by hand (2).



The Battery and Charger

Read and follow the warnings and cautions on pages x–xii and 335–338 of this manual. Do not use the battery at ambient temperatures below 0 °C (32 °F) or above 40 °C (104 °F); failure to observe this precaution could damage the battery or impair its performance. Capacity may be reduced and charging times may increase at battery temperatures from 0 °C (32 °F) to 15 °C (59 °F) and from 45 °C (113 °F) to 60 °C (140 °F).

If the **CHARGE** lamp flashes quickly (about eight times a second) during charging, confirm that the temperature is in the correct range and then unplug the charger and remove and reinsert the battery. If the problem persists, cease use immediately and take battery and charger to your retailer or a Nikon-authorized service representative.

Do not short the charger terminals; failure to observe this precaution could result in overheating and damage to the charger. Do not move the charger or touch the battery during charging. Failure to observe this precaution could in very rare instances result in the charger showing that charging is complete when the battery is only partially charged. Remove and reinsert the battery to begin charging again.

Use the charger with compatible batteries only. Unplug when not in use.



Formatting Memory Cards

If this is the first time the memory card will be used in the camera or if the card has been formatted in another device, select **Format memory card** in the setup menu and follow the on-screen instructions to format the card (☞ 272). *Note that this permanently deletes any data the card may contain.* Be sure to copy any photographs and other data you wish to keep to a computer before proceeding.

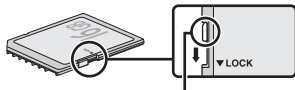


Memory Cards

- Memory cards may be hot after use. Observe due caution when removing memory cards from the camera.
- Turn the power off before inserting or removing memory cards. Do not remove memory cards from the camera, turn the camera off, or remove or disconnect the power source during formatting or while data are being recorded, deleted, or copied to a computer. Failure to observe these precautions could result in loss of data or in damage to the camera or card.
- Do not touch the card terminals with your fingers or metal objects.
- Do not bend, drop, or subject to strong physical shocks.
- Do not apply force to the card casing. Failure to observe this precaution could damage the card.
- Do not expose to water, high levels of humidity, or direct sunlight.
- Do not format memory cards in a computer.

The Write Protect Switch

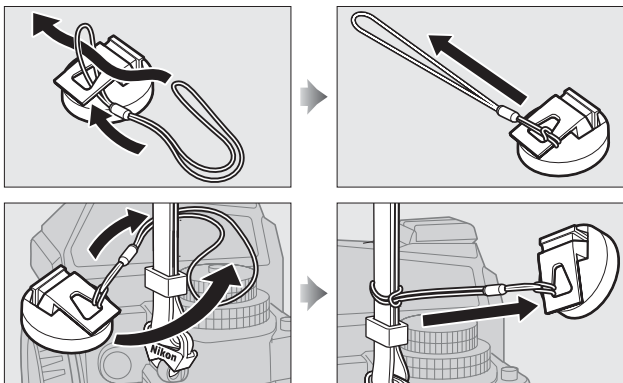
SD memory cards are equipped with a write protect switch to prevent accidental loss of data. When this switch is in the “lock” position, the memory card can not be formatted and photos can not be deleted or recorded (a warning will be displayed in the monitor if you attempt to release the shutter). To unlock the memory card, slide the switch to the “write” position.



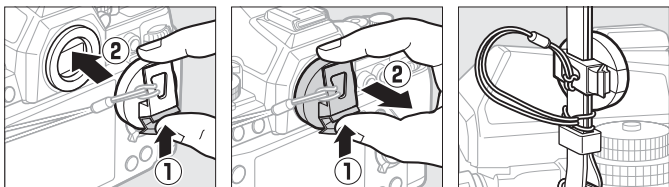
Write-protect switch

The Eyepiece Cap

Use the supplied string to attach the eyepiece cap to the camera strap as shown.

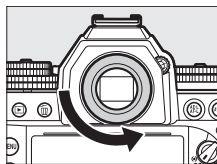


To prevent light entering via the viewfinder interfering with exposure, attach the eyepiece cap during live view, long time-exposures, self-timer photography, and on other occasions in which you will not be looking through the viewfinder while the shutter is open. To remove the cap, press the clips and lift.



Removing the Viewfinder Eyepiece

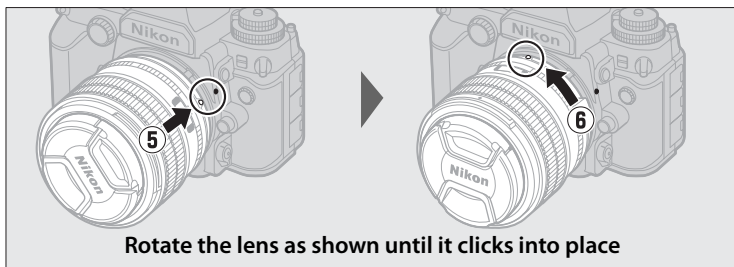
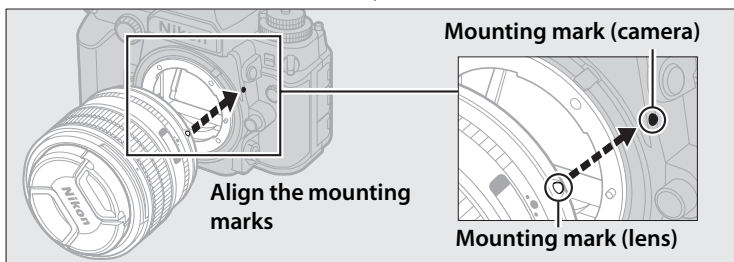
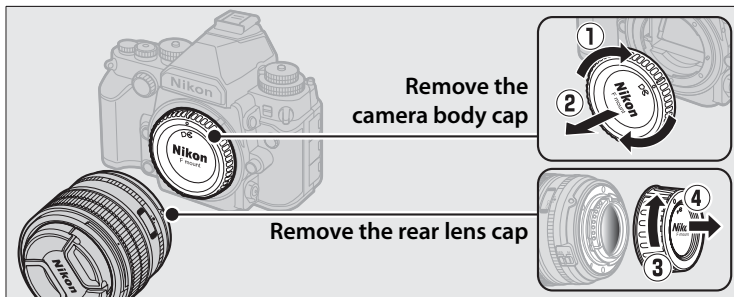
The viewfinder eyepiece must be removed before optional diopter adjustment viewfinder lenses can be attached. To remove the eyepiece, grasp it lightly between your finger and thumb and rotate it as shown.



Attach a Lens

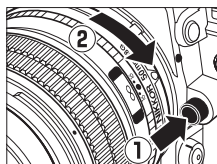
Care should be taken to prevent dust from entering the camera when the lens is removed. The lens generally used in this manual for illustrative purposes is an AF-S NIKKOR 50mm f/1.8G (Special Edition).

Attach the lens as shown.



Detaching the Lens

Be sure the camera is off when removing or exchanging lenses. To remove the lens, press and hold the lens release button (1) while turning the lens clockwise (2). After removing the lens, replace the lens caps and camera body cap.



Lens Focus Mode

If the lens is equipped with a focus mode switch, select autofocus mode (A, M/A, or A/M).



CPU Lenses with Aperture Rings

In the case of CPU lenses equipped with an aperture ring (☞ 320), lock aperture at the minimum setting (highest f-number).

Non-CPU/Non-AI Lenses

The camera can be used with non-CPU lenses and lenses not equipped with AI mechanisms (non-AI lenses; ☞ 163).

Image Area

The DX format image area is automatically selected when a DX lens is attached (☞ 51).



Image area

Basic Setup

A language-selection dialog will be displayed the first time the camera is turned on. Choose a language and set the time and date. Photographs can not be taken until you have set the time and date.

1 Turn the camera on.

A language-selection dialog will be displayed.

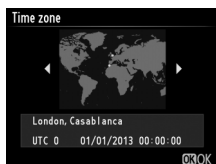
2 Select a language.

Press ▲ or ▼ to highlight the desired language and press **OK**.



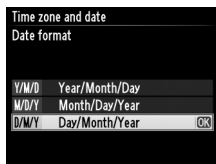
3 Choose a time zone.

A time-zone selection dialog will be displayed. Press ◀ or ▶ to highlight the local time zone (the **UTC** field shows the difference between the selected time zone and Coordinated Universal Time, or UTC, in hours) and press **OK**.



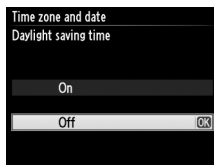
4 Choose a date format.

Press ▲ or ▼ to choose the order in which the year, month, and day will be displayed. Press **OK** to proceed to the next step.



5 Turn daylight saving time on or off.

Daylight saving time options will be displayed. Daylight saving time is off by default; if daylight saving time is in effect in the local time zone, press ▲ to highlight **On** and press **OK**.



6 Set the date and time.

The dialog shown at right will be displayed. Press ◀ or ▶ to select an item, ▲ or ▼ to change. Press **OK** to set the clock and exit to shooting mode (note that the camera uses a 24-hour clock).



Setting the Clock

Language and date/time settings can be changed at any time using the **Language** (□ 277) and **Time zone and date** (□ 276) options in the setup menu. The camera clock can also be set using data provided by an optional GPS unit (□ 170).

The Clock Battery

The camera clock is powered by an independent, rechargeable power source, which is charged as necessary when the main battery is installed or the camera is powered by an optional power connector and AC adapter (□ 323). Two days of charging will power the clock for about three months. If the camera displays a warning at startup stating that the clock is not set and a **CLOCK** icon flashes in the information display, the clock battery is exhausted and the clock has been reset. Set the clock to the correct time and date.

The Camera Clock

The camera clock is less accurate than most watches and household clocks. Check the clock regularly against more accurate time pieces and reset as necessary.

Adjust Viewfinder Focus

The camera is equipped with diopter adjustment to accommodate individual differences in vision. Check that the display in the viewfinder is in focus before framing pictures in the viewfinder.

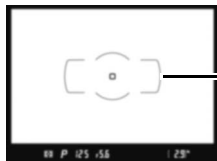
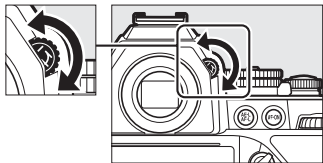
1 Turn the camera on.

Remove the lens cap and turn the camera on.

2 Focus the viewfinder.

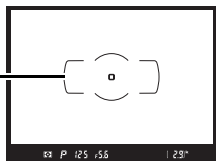
Rotate the diopter adjustment control until the AF area brackets are in sharp focus.

When operating the diopter adjustment control with your eye to the viewfinder, be careful not to put your fingers or fingernails in your eye.







Viewfinder not in focus

AF area brackets



Viewfinder in focus

Adjusting Viewfinder Focus

If you are unable to focus the viewfinder as described above, select single-servo autofocus (**AF-S**;  59), single-point AF ( 62), and the center focus point ( 65), and then frame a high-contrast subject in the center focus point and press the shutter-release button halfway to focus the camera. With the camera in focus, use the diopter adjustment control to bring the subject into clear focus in the viewfinder. If necessary, viewfinder focus can be further adjusted using optional corrective lenses ( 324).

Basic Photography and Playback

Taking Photographs

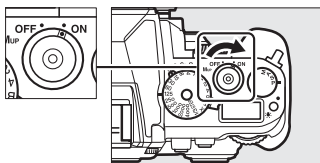
Turn the Camera On

Before taking photographs, turn the camera on and check the battery level and number of exposures remaining as described below.

1 Turn the camera on.

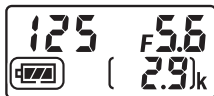
Turn the camera on. The control panel will turn on and the display in the viewfinder will light.

Power switch




2 Check the battery level.

Check the battery level in the control panel or viewfinder.



Icon		Description
Control panel	Viewfinder	
	—	Battery fully charged.
	—	Battery partially discharged.
		Low battery. Charge battery or ready spare battery.
 (flashes)	 (flashes)	Battery exhausted; shutter release disabled. Charge or exchange battery.

3 Check the number of exposures remaining.

The control panel shows the number of photographs that can be taken at current settings (values over 1000 are rounded down to the nearest hundred; e.g., values between 2900 and 2999 are shown as 2.9 k). When this number reaches zero,  will flash in the exposure-count displays while the shutter-speed displays will show a flashing **F u L L** or **F u L**. Insert another memory card or delete some photos.



Choose an Exposure Mode

Lift the exposure mode dial and rotate it to the desired setting.

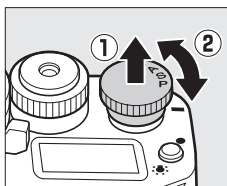

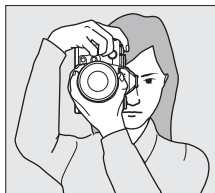
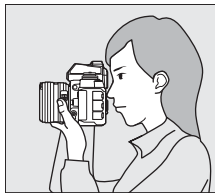
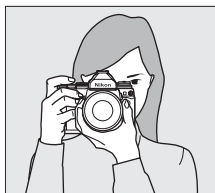


Image Sensor Cleaning

The camera vibrates the low-pass filter covering the image sensor to remove dust when the camera is turned on or off ( 329).

Ready the Camera

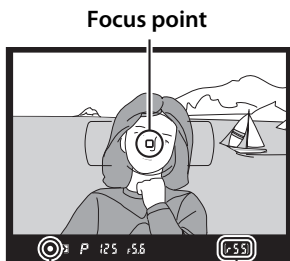
When framing photographs in the viewfinder, hold the handgrip in your right hand and cradle the camera body or lens with your left. Keep your elbows propped lightly against your torso for support and place one foot half a pace ahead of the other to keep your upper body stable. When framing photographs in portrait (tall) orientation, hold the camera as shown in the bottom of the three illustrations at right.



Focus and Shoot

- 1 Press the shutter-release button halfway.**

Press the shutter-release button halfway to focus. The active focus point will be displayed.



Focus indicator

Buffer capacity

2 Check indicators in the viewfinder.

When the focus operation is complete, the in-focus indicator (●) will appear in the viewfinder.

Viewfinder display	Description
●	Subject in focus.
▶	Focus point is between camera and subject.
◀	Focus point is behind subject.
▶ ◀ (flashes)	Camera unable to focus on subject in focus point using autofocus.

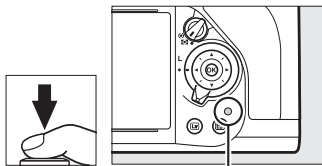
While the shutter-release button is pressed halfway, focus will lock and the number of exposures that can be stored in the memory buffer ("r"; □ 47) will be shown in the viewfinder display.



For information on what to do if the camera is unable to focus using autofocus, see "Getting Good Results with Autofocus" (□ 61).

3 Shoot.

Smoothly press the shutter-release-button the rest of the way down to release the shutter and record the photograph. While the photograph is being recorded to the memory card, the memory card access lamp will light. *Do not eject the memory card or remove or disconnect the power source until the lamp has gone out and recording is complete.*



Memory card access lamp

The Shutter-Release Button


The camera has a two-stage shutter-release button. The camera focuses when the shutter-release button is pressed halfway. To take the photograph, press the shutter-release button the rest of the way down.

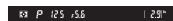
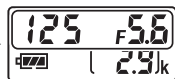
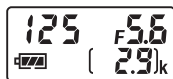


Focus: press halfway

Shoot: press all the way down

The Standby Timer

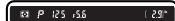
The viewfinder and the control panel shutter speed and aperture displays will turn off if no operations are performed for about 6 seconds, reducing the drain on the battery. Press the shutter-release button halfway to reactivate the display. The length of time before the standby timer expires automatically can be selected using Custom Setting c2 (**Standby timer**,  251).



Exposure meters
on



Exposure meters
off



Exposure meters
on

Camera Off Display


If a battery and memory card are inserted, the number of exposures remaining will be displayed when the camera is turned off.

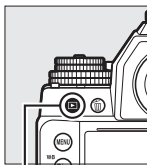


Control panel




Basic Playback

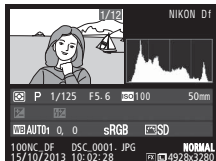
- 1 Press the  button.
A photograph will be displayed in the monitor.



 button




- 2 View additional pictures.
Additional pictures can be displayed by pressing  or .
To view additional information on the current photograph, press  and  ( 188).




To end playback and return to shooting mode, press the shutter-release button halfway.



Image Review

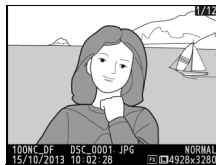
When **On** is selected for **Image review** in the playback menu ( 232), photographs are automatically displayed in the monitor for a few seconds after shooting.

Deleting Unwanted Photographs




To delete the photograph currently displayed in the monitor, press the  button. *Note that photographs can not be recovered once deleted.*

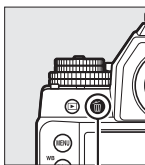
1 Display the photograph.

Display the photograph you wish to delete as described on the preceding page.



2 Delete the photograph.




Press the  button. A confirmation dialog will be displayed; press the  button again to delete the image and return to playback. To exit without deleting the picture, press .



 button

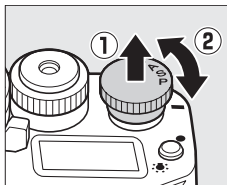


Delete

To delete selected images ( 205), all images taken on a selected date ( 206), or all images in the current folder ( 205), use the **Delete** option in the playback menu.

PS Exposure Mode

To choose an exposure mode, lift and rotate the exposure mode dial.



Mode	Description
P	Programmed auto (☞ 38): Camera sets shutter speed and aperture for optimal exposure. Recommended for snapshots and in other situations in which there is little time to adjust camera settings.
S	Shutter-priority auto (☞ 39): User chooses shutter speed; camera selects aperture for best results. Use to freeze or blur motion.
A	Aperture-priority auto (☞ 41): User chooses aperture; camera selects shutter speed for best results. Use to blur background or bring both foreground and background into focus.
M	Manual (☞ 42): User controls both shutter speed and aperture. Set shutter speed to Bulb (B) or Time (T) for long time-exposures.

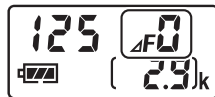
Lens Types

When using a CPU lens equipped with an aperture ring (☐ 320), lock the aperture ring at the minimum aperture (highest f-number). Type G and E lenses are not equipped with an aperture ring.

When using non-CPU lenses (☐ 163), select exposure mode **A** or **M** and adjust aperture using the lens aperture ring. If exposure mode **P** or **S** is selected with a non-CPU lens, the camera will function in exposure mode **A** and **A** will appear in the viewfinder. See page 318 for more information.

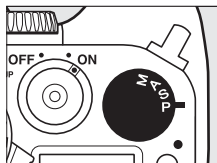
Non-CPU Lenses (☐ 163)

Use the lens aperture ring to adjust aperture. If the maximum aperture of the lens has been specified using the **Non-CPU lens data** item in setup menu (☐ 163) when a non-CPU lens is attached, the current f-number will be displayed in the viewfinder and control panel, rounded to the nearest full stop. Otherwise the aperture displays will show only the number of stops (ΔF , with maximum aperture displayed as ΔF_{max}) and the f-number must be read from the lens aperture ring. Aperture for lenses not equipped with AI mechanisms (non-AI lenses) is adjusted using the lens aperture ring. Changes to aperture are not shown in the camera displays; use the sub-command dial to set the camera to the aperture selected with the aperture ring (☐ 168).



P: Programmed Auto

In this mode, the camera automatically adjusts shutter speed and aperture according to a built-in program to ensure optimal exposure in most situations.

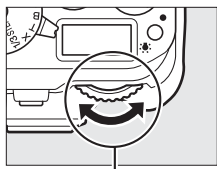


PS
AM

Flexible Program

In exposure mode **P**, different combinations of shutter speed and aperture can be selected by rotating the main command dial while the exposure meters are on (“flexible program”). Rotate the dial to the right for large apertures (low f-numbers) that blur background details or fast shutter speeds that “freeze” motion. Rotate the dial to the left for small apertures (high f-numbers) that increase depth of field or slow shutter speeds that blur motion. All combinations produce the same exposure.

While flexible program is in effect, a * indicator appears in the viewfinder. To restore default shutter speed and aperture settings, rotate the main command dial until the indicator is no longer displayed, choose another exposure mode, or turn the camera off.



Main command dial



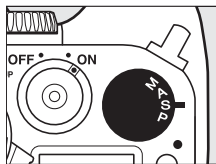
Viewfinder

See Also

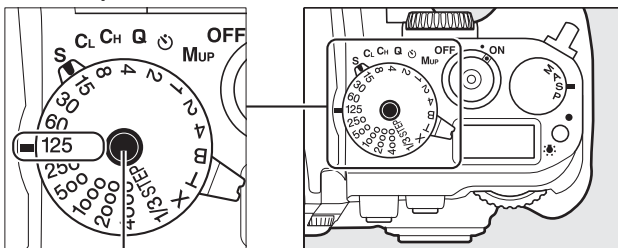
See page 339 for information on the built-in exposure program.

S: Shutter-Priority Auto

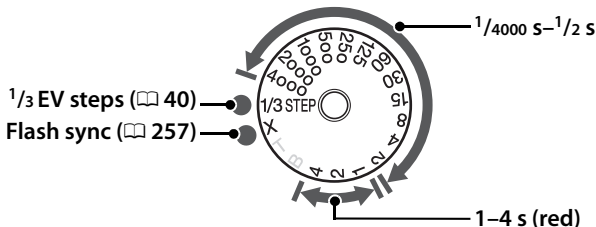
In shutter-priority auto, you rotate the shutter-speed dial to choose the shutter speed while the camera automatically selects the aperture that will produce the optimal exposure. The dial locks at settings of **1/3 STEP**, **X**, and **T**; to choose another setting, keep the shutter-speed dial lock release pressed while rotating the dial.



Shutter-speed dial



Shutter-speed dial lock release



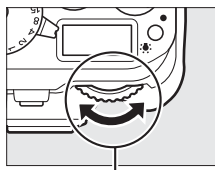
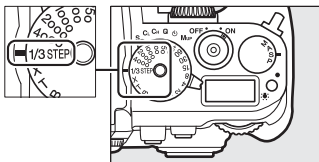
- Settings of **T** (time, [book 44](#)) and **B** (bulb, [book 44](#)) take effect only in exposure mode **M**.

See Also

For information on using the command dial to fine-tune the shutter speed selected with the shutter-speed dial, see Custom Setting f11 (**Easy shutter-speed shift**; [book 270](#)). See page 347 for information on what to do if flashing “**b**” or “**-**” indicator appears in the shutter-speed displays.

1/3 STEP (Exposure Modes S and M)

When the shutter-speed dial is rotated to **1/3 STEP**, shutter speed can be adjusted in increments of $1/3$ EV by rotating the main command dial; the selected shutter speed is displayed in the control panel and viewfinder. Choose from values between $1/4000$ and 30 s. In exposure mode **M**, speeds of “Bulb” and “Time” can be used to record long time-exposures.

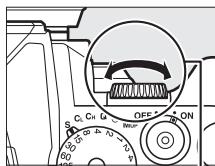
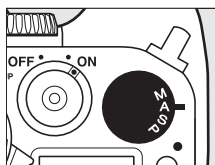


Main command dial



A: Aperture-Priority Auto

In aperture-priority auto, you choose the aperture while the camera automatically selects the shutter speed that will produce the optimal exposure. To choose an aperture between the minimum and maximum values for the lens, rotate the sub-command dial while the exposure meters are on; the selected aperture is shown in the control panel and viewfinder.



Sub-command dial



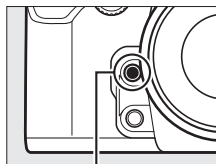
PS
AM

Lenses with Aperture Rings

If **Aperture ring** is selected for Custom Setting f7 (**Customize command dial**) > **Aperture setting** (☐ 268), aperture can be set using the lens aperture ring.

Depth-of-Field Preview

To preview the effects of aperture, press and hold the **Pv** button. The lens will be stopped down to the aperture value selected by the camera (exposure modes **P** and **S**) or the value chosen by the user (exposure modes **A** and **M**), allowing depth of field to be previewed in the viewfinder.



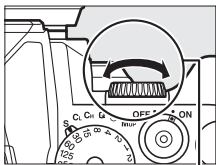
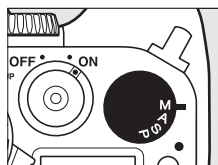
Pv button

Custom Setting e5—Modeling Flash

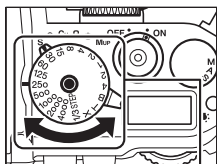
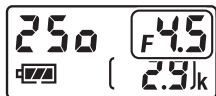
This setting controls whether optional flash units that support the Nikon Creative Lighting System (CLS; ☐ 118) will emit a modeling flash when the **Pv** button is pressed. See page 259 for more information.

M: Manual

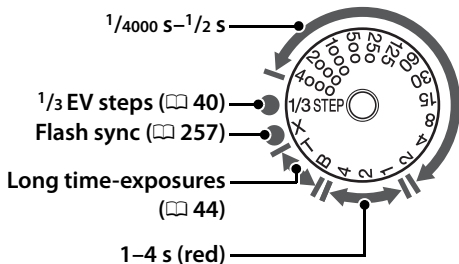
In manual exposure mode, you control both shutter speed and aperture. While the exposure meters are on, rotate the sub-command dial to set aperture to values between the minimum and maximum for the lens; to set shutter speed, keep the shutter-speed dial lock release pressed while rotating the shutter-speed dial. Use the exposure indicators to check exposure.



Sub-command dial



Shutter-speed dial




Lenses with Aperture Rings

If **Aperture ring** is selected for Custom Setting f7 (**Customize command dial**) > **Aperture setting** (☞ 268), aperture can be set using the lens aperture ring.

The Exposure Indicator

If a shutter speed other than “bulb” or “time” is selected, the exposure indicator in the viewfinder shows whether the photograph would be under- or over-exposed at current settings. If the limits of the exposure metering system are exceeded, the displays will flash.

Optimal exposure	Underexposed by $\frac{1}{3}$ EV	Overexposed by over 2 EV
- . . 0 . . . +	- . . 0 . . . +	- . . 0  +

See Also

For information on using the command dial to fine-tune the shutter speed selected with the shutter-speed dial, see Custom Setting f11 (**Easy shutter-speed shift**; ☞ 270). For information reversing the exposure indicators so that negative values are displayed on the right and positive values on the left, see Custom Setting f10 (**Reverse indicators**, ☞ 269).

■ Long Time-Exposures (M Mode Only)

Select the following shutter speeds for long time-exposures of moving lights, the stars, night scenery, or fireworks.

- **Bulb (B):** The shutter remains open while the shutter-release button is held down. To prevent blur, use a tripod or an optional wireless remote controller (☐ 325) or remote cord (☐ 325).
- **Time (T):** Start the exposure by using the shutter-release button on the camera or on an optional remote cord, or wireless remote controller. The shutter remains open for thirty minutes or until the button is pressed a second time.



Length of exposure:

35 s

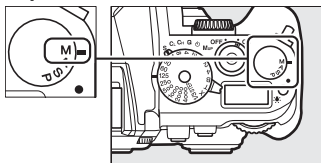
Aperture: f/25

PS
AM

Before proceeding, mount the camera on a tripod or place it on a stable, level surface. To prevent loss of power before the exposure is complete, use a fully charged battery or an optional AC adapter and power connector. Note that noise (bright spots, randomly-spaced bright pixels, or fog) may be present in long exposures; before shooting, choose **On** for **Long exposure NR** in the shooting menu (☐ 242). To prevent light entering via the viewfinder interfering with photographs or exposure, cover the viewfinder with the supplied eyepiece cap (☐ 23).

1 Rotate the exposure mode dial to M.

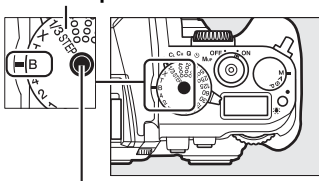
Exposure mode dial



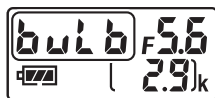
2 Choose a shutter speed.

Keeping the shutter-speed dial lock release pressed, rotate the shutter-speed dial to **B** (bulb) or **T** (time; if the shutter-speed dial is rotated to **1/3 STEP**, you can choose the shutter speed by rotating the main command dial). At a shutter speed of “bulb”, the control panel and viewfinder show **b u l b**, while - - is displayed when “time” is selected.

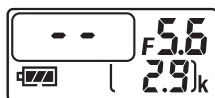
Shutter-speed dial



Shutter-speed dial lock release



Bulb



Time

PS
AM

3 Open the shutter.

Bulb: After focusing, press the shutter-release button on the camera or optional remote cord or wireless remote controller all the way down. Keep the shutter-release button pressed until the exposure is complete.

Time: Press the shutter-release button all the way down.

4 Close the shutter.

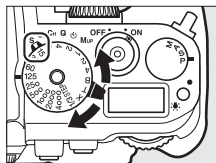
Bulb: Take your finger off the shutter-release button.

Time: Press the shutter-release button all the way down. Shooting ends automatically after thirty minutes.

Release Mode

Choosing a Release Mode

To choose a release mode, rotate the release mode dial to the desired setting (📖 7).



Mode	Description
S	Single frame: Camera takes one photograph each time shutter-release button is pressed.
CL	Continuous low speed: While shutter-release button is held down, camera records 1–5 frames per second. ¹ Frame rate can be chosen using Custom Setting d5 (CL mode shooting speed , 📖 254).
CH	Continuous high speed: While shutter-release button is held down, camera records up to 5.5 frames per second. ²
Q	Quiet shutter-release: As for single frame, except that mirror does not click back into place while shutter-release button is fully pressed, allowing user to control timing of click made by mirror, which is also quieter than in single frame mode. In addition, beep does not sound regardless of setting selected for Custom Setting d1 (Beep ; 📖 253).
🕒	Self-timer: Take pictures with the self-timer (📖 48).
MUP	Mirror up: Choose this mode to minimize camera shake in telephoto or close-up photography or in other situations in which the slightest camera movement can result in blurred photographs.

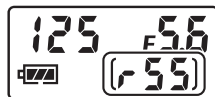
1 Average frame rate with an EN-EL14a battery, continuous-servo AF, manual or shutter-priority auto exposure, a shutter speed of $1/200$ s or faster, remaining settings other than Custom Setting d5 at default values, and memory remaining in memory buffer.

2 Average frame rate with an EN-EL14a battery, continuous-servo AF, manual or shutter-priority auto exposure, a shutter speed of $1/200$ s or faster, other settings at default values, and memory remaining in memory buffer.

Frame rate drops at slow shutter speeds or very small apertures (high f-numbers), when vibration reduction (available with VR lenses) or auto ISO sensitivity control is on (☐ 70, 72), or when the battery is low.

The Memory Buffer

The camera is equipped with a memory buffer for temporary storage, allowing shooting to continue while photographs are being saved to the memory card. Up to 100 photographs can be taken in succession; note, however, that the frame rate will drop when the buffer is full (r 00).



The approximate number of images that can be stored in the buffer at current settings is shown in the exposure-count displays in the viewfinder and control panel while the shutter-release button is pressed. The illustration at right shows the display when space remains in the buffer for about 55 pictures.

While photographs are being recorded to the memory card, the memory card access lamp will light. Depending on shooting conditions and memory card performance, recording may take from a few seconds to a few minutes. *Do not remove the memory card or remove or disconnect the power source until the access lamp has gone out.* If the camera is switched off while data remain in the buffer, the power will not turn off until all images in the buffer have been recorded. If the battery is exhausted while images remain in the buffer, the shutter release will be disabled and the images transferred to the memory card.

Live View

If a continuous release mode is used during live view photography (☐ 172), photographs will be displayed in place of the view through the lens while the shutter-release button is pressed.

See Also

For information on choosing the maximum number of photographs that can be taken in a single burst, see Custom Setting d6 (**Max. continuous release**, ☐ 254). For information on the number of pictures that can be taken in a single burst, see page 364.




Self-Timer Mode

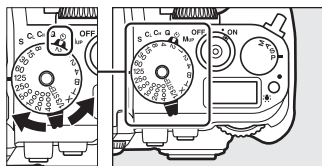
The self-timer can be used to reduce camera shake or for self-portraits.

1 Mount the camera on a tripod.

Mount the camera on a tripod or place the camera on a stable, level surface.

2 Select self-timer mode.


Rotate the release-mode dial to .



Release mode dial

3 Frame the photograph.

Cover the Viewfinder


To prevent light entering via the viewfinder interfering with photographs and exposure, cover the viewfinder with the supplied DK-26 eyepiece cap ( 23).



4 Take the photograph.

Press the shutter-release button halfway to focus, and then press the button the rest of the way



down to start the self-timer (note that the timer will not start if the camera is unable to focus or in other situations in which the shutter can not be released). The self-timer lamp will start to flash. Two seconds before the photograph is taken, the self-timer lamp will stop flashing. The shutter will be released ten seconds after the timer starts. To cancel shooting, select another release mode.

 **See Also**

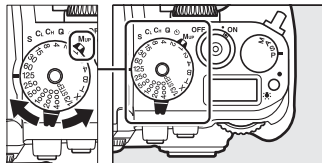
For information on choosing the duration of the self-timer, the number of shots taken, and the interval between shots, see Custom Setting c3 (**Self-timer**;  252). For information on controlling the beeps that sound when the self-timer is used, see Custom Setting d1 (**Beep**;  253).



Mirror up Mode

Choose this mode to minimize blurring caused by camera movement when the mirror is raised. Use of a tripod is recommended.

- 1 Select mirror up mode.**
Rotate the release-mode dial to **MUP**.



Release mode dial

- 2 Raise the mirror.**
Frame the picture, focus, and then press the shutter-release button the rest of the way down to raise the mirror.



Mirror Up

While the mirror is raised, photos can not be framed in the viewfinder and autofocus and metering will not be performed.

- 3 Take a picture.**
Press the shutter-release button all the way down again to take a picture. To prevent blurring caused by camera movement, press the shutter-release button smoothly. The mirror lowers when shooting ends.



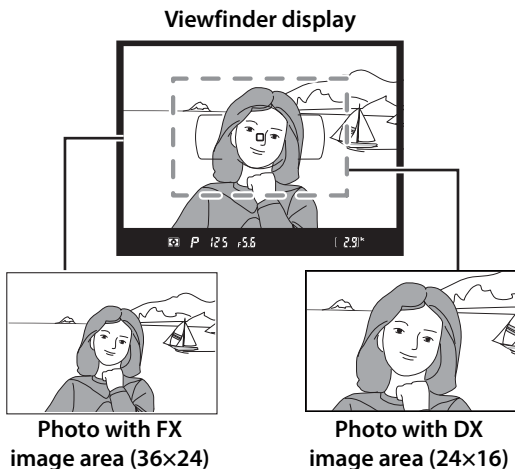
Mirror up Mode

A picture will be taken automatically if no operations are performed for about 30 s after the mirror is raised.

Image Recording Options

Image Area

Choose an image area from FX (36×24) 1.0× and DX (24×16) 1.5×.





DX Lenses

DX lenses are designed for use with DX format cameras and have a smaller angle of view than lenses for 35mm format cameras. If **Auto DX crop** is off and **FX (36×24) 1.0×** (FX format) is selected for **Choose image area** when a DX lens is attached, the edges of the image may be eclipsed. This may not be apparent in the viewfinder, but when the images are played back you may notice a drop in resolution or that the edges of the picture are blacked out.

■ Choose Image Area

Choose the image area used when a non-DX lens is attached or a DX-lens is attached with **Off** selected for **Auto DX crop** (📖 53).



Option	Description
FX (36×24)  1.0× (FX format)	Images are recorded in FX format using the full area of the image sensor (36.0 × 23.9 mm), producing an angle of view equivalent to a NIKKOR lens on a 35 mm format camera.
DX (24×16)  1.5× (DX format)	An area at the center of the image sensor 23.4 × 15.5 mm is used to record pictures in DX format. To calculate the approximate focal length of the lens in 35mm format, multiply by 1.5.



■ Auto DX Crop

Choose whether to automatically select a DX crop when a DX lens is attached.



Option	Description
On	Camera automatically selects DX crop when DX lens is attached. If another lens is attached, the crop selected for Choose image area will be used.
Off	Crop selected for Choose image area is used.

The Viewfinder Display

The DX format crop is shown at right; the area outside the crop can be viewed in gray when **Off** is selected for Custom Setting a5 (**Focus point illumination**) > **AF point illumination** (📖 248).

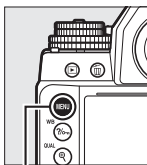


DX format

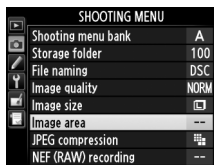
Image area can be set using the **Image area** option in the shooting menu or by pressing a control and rotating a command dial.

■ The Image Area Menu

- 1 Select Image area in the shooting menu.**
Press **MENU** to display the menus. Highlight **Image area** in the shooting menu (☞ 235) and press **▶**.



MENU button



- 2 Choose an option.**
Highlight **Auto DX crop** or **Choose image area** and press **▶**.

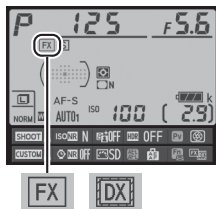


- 3 Adjust settings.**
Choose an option and press **OK**.
The selected crop is displayed in the viewfinder (☞ 52).



Image Area

The selected option is shown in the information display.



1 Assign image area selection to a camera control.

Select **Choose image area** as the “press + command dials” option for a camera control in the Custom Settings menu (☞ 266). Image area selection can be assigned to the **Fn** button (Custom Setting f4, **Assign Fn button**, ☞ 263), the **Pv** button (Custom Setting f5, **Assign preview button**, ☞ 266), or the **AE-L/AF-L** button (Custom Setting f6, **Assign AE-L/AF-L button**, ☞ 267).

2 Use the selected control to choose an image area.

The image area can be selected by pressing the selected button and rotating the main or sub-command dial until the desired crop is displayed in the viewfinder (☞ 51).

The option currently selected for image area can be viewed by pressing the button to display the image area in the viewfinder or information display. FX format is displayed as “36 – 24” and DX format as “24 – 16”.



Auto DX Crop

The selected control can not be used to choose the image area when a DX lens is attached and **Auto DX crop** is on.

Image Size

Image size varies with the option selected for image area (☞ 58).

Image Quality and Size

Together, image quality and size determine how much space each photograph occupies on the memory card. Larger, higher quality images can be printed at larger sizes but also require more memory, meaning that fewer such images can be stored on the memory card (📖 364).


Image Quality

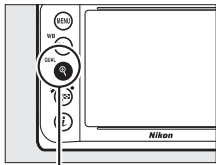
Choose a file format and compression ratio (image quality).


Option	File type	Description
NEF (RAW)	NEF	Raw data from the image sensor are saved directly to the memory card. Settings such as white balance and contrast can be adjusted after shooting.
TIFF (RGB)	TIFF (RGB)	Record uncompressed TIFF-RGB images at a bit depth of 8 bits per channel (24-bit color). TIFF is supported by a wide variety of imaging applications.
JPEG fine	JPEG	Record JPEG images at a compression ratio of roughly 1:4 (fine quality).*
JPEG normal		Record JPEG images at a compression ratio of roughly 1:8 (normal quality).*
JPEG basic		Record JPEG images at a compression ratio of roughly 1:16 (basic quality).*
NEF (RAW)+ JPEG fine	NEF/ JPEG	Two images are recorded, one NEF (RAW) image and one fine-quality JPEG image.
NEF (RAW)+ JPEG normal		Two images are recorded, one NEF (RAW) image and one normal-quality JPEG image.
NEF (RAW)+ JPEG basic		Two images are recorded, one NEF (RAW) image and one basic-quality JPEG image.

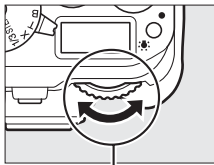
* **Size priority** selected for **JPEG compression**.



Image quality can be set by pressing the  (QUAL) button and rotating the main command dial until the desired setting is displayed in the information display.



 (QUAL) button




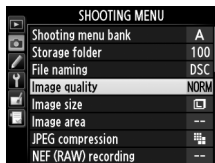
Main command dial






Information display

The Shooting Menu

Image quality can also be adjusted using the **Image quality** option in the shooting menu ( 235).



NEF (RAW) Images

NEF (RAW) images can be viewed on the camera or using software such as Capture NX 2 (available separately;  325) or ViewNX 2 (available on the supplied ViewNX 2 CD). Note that the option selected for image size does not affect the size of NEF (RAW) images; when viewed on a computer, NEF (RAW) images have the dimensions given for large (-size) images in the table on page 58. JPEG copies of NEF (RAW) images can be created using the **NEF (RAW) processing** option in the retouch menu ( 300).



NEF+JPEG

When photographs taken at settings of NEF (RAW) + JPEG are viewed on the camera, only the JPEG image will be displayed. When photographs taken at these settings are deleted, both NEF and JPEG images will be deleted.

The following options can be accessed from the shooting menu. Press the **MENU** button to display the menus, highlight the desired option and press **▶**.

■■ **JPEG Compression**

Choose the type of compression for JPEG images.

Option	Description
 Size priority	Images are compressed to produce relatively uniform file size.
 Optimal quality	Optimal image quality. File size varies with scene recorded.

■■ **NEF (RAW) Recording > Type**

Choose the type of compression for NEF (RAW) images.

Option	Description
<input checked="" type="checkbox"/> Lossless compressed	NEF images are compressed using a reversible algorithm, reducing file size by about 20–40% with no effect on image quality.
<input checked="" type="checkbox"/> Compressed	NEF images are compressed using a non-reversible algorithm, reducing file size by about 35–55% with almost no effect on image quality.
Uncompressed	NEF images are not compressed.

■■ **NEF (RAW) Recording > NEF (RAW) Bit Depth**

Choose a bit depth for NEF (RAW) images.

Option	Description
12-bit 12-bit	NEF (RAW) images are recorded at a bit-depth of 12 bits.
14-bit 14-bit	NEF (RAW) images are recorded at a bit depth of 14 bits, producing files larger than those with a bit depth of 12 bits but increasing the color data recorded.



Image Size






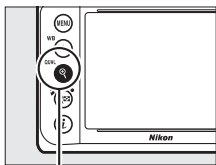

Image size is measured in pixels. Choose from  Large,  Medium, or  Small (note that image size varies depending on the option selected for **Image area**,  51):

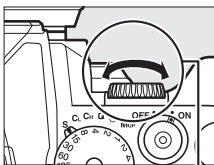
Image area	Option	Size (pixels)	Print size (cm/in.)*
FX (36×24) 1.0× (FX format)	Large	4928 × 3280	41.7 × 27.8/16.4 × 10.9
	Medium	3696 × 2456	31.3 × 20.8/12.3 × 8.2
	Small	2464 × 1640	20.9 × 13.9/ 8.2 × 5.5
DX (24×16) 1.5× (DX format)	Large	3200 × 2128	27.1 × 18.0/10.7 × 7.1
	Medium	2400 × 1592	20.3 × 13.5/ 8.0 × 5.3
	Small	1600 × 1064	13.5 × 9.0/ 5.3 × 3.5

* Approximate size when printed at 300 dpi. Print size in inches equals image size in pixels divided by printer resolution in dots per inch (dpi); 1 inch=approximately 2.54 cm).

Image size can be set by pressing the  (QUAL) button and rotating the sub-command dial until the desired setting is displayed in the information display.



 (QUAL) button




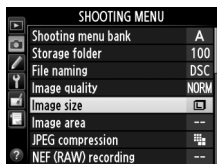
Sub command dial



Information display

The Shooting Menu

Image size can also be adjusted using the **Image size** option in the shooting menu ( 235).



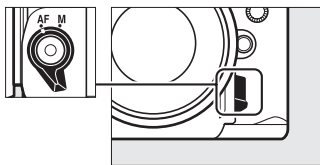
Focus

This section describes the focus options available when photographs are framed in the viewfinder. Focus can be adjusted automatically (see below) or manually (□ 68). The user can also select the focus point for automatic or manual focus (□ 64) or use focus lock to focus to recompose photographs after focusing (□ 66).

Autofocus

To use autofocus, rotate the focus-mode selector to **AF**.

Focus-mode selector

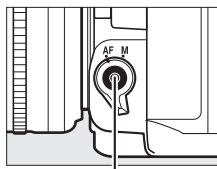


Autofocus Mode

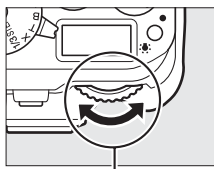
Choose from the following autofocus modes:

Mode	Description
AF-S	Single-servo AF: For stationary subjects. Focus locks when shutter-release button is pressed halfway. At default settings, shutter can only be released when in-focus indicator (●) is displayed (<i>focus priority</i> ; □ 246).
AF-C	Continuous-servo AF: For moving subjects. Camera focuses continuously while shutter-release button is pressed halfway; if subject moves, camera will engage <i>predictive focus tracking</i> (□ 60) to predict final distance to subject and adjust focus as necessary. At default settings, shutter can be released whether or not subject is in focus (<i>release priority</i> ; □ 246).

Autofocus mode can be selected by pressing the AF-mode button and rotating the main command dial until the desired setting is displayed in the viewfinder.



AF-mode button



Main command dial



AF-S

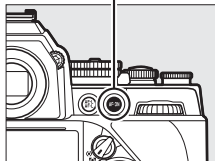


AF-C

The AF-ON Button

For the purpose of focusing the camera, pressing the **AF-ON** button has the same effect as pressing the shutter-release button halfway.



AF-ON button



Predictive Focus Tracking

In **AF-C** mode, the camera will initiate predictive focus tracking if the subject moves toward or away from the camera while the shutter-release button is pressed halfway or the **AF-ON** button is pressed. This allows the camera to track focus while attempting to predict where the subject will be when the shutter is released.

See Also

For information on using focus priority in continuous-servo AF, see Custom Setting a1 (**AF-C priority selection**,  246). For information on using release priority in single-servo AF, see Custom Setting a2 (**AF-S priority selection**,  246). See page 175 for information on the autofocus options available in live view.

Getting Good Results with Autofocus

Autofocus does not perform well under the conditions listed below. The shutter release may be disabled if the camera is unable to focus under these conditions, or the in-focus indicator (●) may be displayed and the camera may sound a beep, allowing the shutter to be released even when the subject is not in focus. In these cases, focus manually (☐ 68) or use focus lock (☐ 66) to focus on another subject at the same distance and then recompose the photograph.



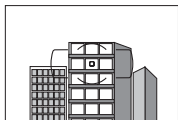
There is little or no contrast between the subject and the background.

Example: Subject is the same color as the background.



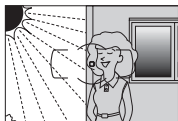
The focus point contains objects at different distances from the camera.

Example: Subject is inside a cage.



The subject is dominated by regular geometric patterns.

Example: Blinds or a row of windows in a skyscraper.



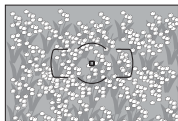
The focus point contains areas of sharply contrasting brightness.

Example: Subject is half in the shade.



Background objects appear larger than the subject.

Example: A building is in the frame behind the subject.



The subject contains many fine details.

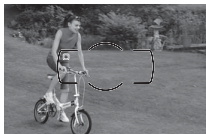
Example: A field of flowers or other subjects that are small or lack variation in brightness.



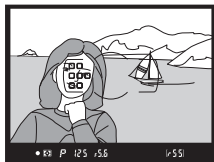
AF-Area Mode

Choose how the focus point for autofocus is selected.

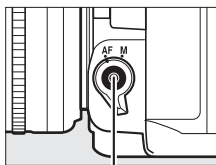
- **Single-point AF:** Select the focus point as described on page 64; the camera will focus on the subject in the selected focus point only. Use with stationary subjects.
- **Dynamic-area AF:** Select the focus point as described on page 64. In **AF-C** focus mode, the camera will focus based on information from surrounding focus points if the subject briefly leaves the selected point. The number of focus points varies with the mode selected:
 - **9-point dynamic-area AF:** Choose when there is time to compose the photograph or when photographing subjects that are moving predictably (e.g., runners or race cars on a track).
 - **21-point dynamic-area AF:** Choose when photographing subjects that are moving unpredictably (e.g., players at a football game).
 - **39-point dynamic-area AF:** Choose when photographing subjects that are moving quickly and can not be easily framed in the viewfinder (e.g., birds).
- **3D-tracking:** Select the focus point as described on page 64. In **AF-C** focus mode, the camera will track subjects that leave the selected focus point and select new focus points as required. Use to quickly compose pictures with subjects that are moving erratically from side to side (e.g., tennis players). If the subject leaves viewfinder, remove your finger from the shutter-release button and recompose the photograph with the subject in the selected focus point.



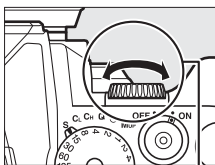
- **Auto-area AF:** The camera automatically detects the subject and selects the focus point. If a type G, E, or D lens is used (☞ 320), the camera can distinguish human subjects from the background for improved subject detection. The active focus points are highlighted briefly after the camera focuses; in **AF-C** mode, the main focus point remains highlighted after the other focus points have turned off.



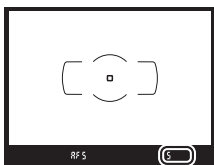
AF-area mode can be selected by pressing the AF-mode button and rotating the sub-command dial until the desired setting is displayed in the viewfinder.



AF-mode button



Sub-command dial









Viewfinder

3D-tracking

When the shutter-release button is pressed halfway, the colors in the area surrounding the focus point are stored in the camera. Consequently 3D-tracking may not produce the desired results with subjects that are the same color as the background or that occupy a very small area of the frame.

AF-Area Mode

AF-area mode is shown in the viewfinder.


AF-area mode	Viewfinder	AF-area mode	Viewfinder
Single-point AF		39-point dynamic-area AF*	
9-point dynamic-area AF*		3D-tracking	
21-point dynamic-area AF*		Auto-area AF	

* Only active focus point is displayed in the viewfinder. Remaining focus points provide information to assist focus operation.

Manual Focus

Single-point AF is automatically selected when manual focus is used.


See Also

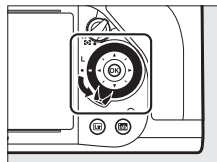
For information on adjusting how long the camera waits before refocusing when an object moves in front of the camera, see Custom Setting a3 (**Focus tracking with lock-on**,  247). See page 177 for information on the autofocus options available in live view.



Focus Point Selection

The camera offers a choice of 39 focus points that can be used to compose photographs with the main subject positioned almost anywhere in the frame.

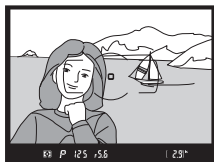
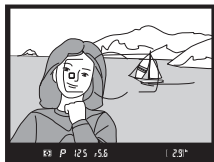
- 1 Rotate the focus selector lock to .**
This allows the multi selector to be used to select the focus point.



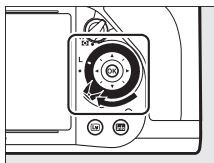
Focus selector lock

2 Select the focus point.

Use the multi selector to select the focus point in the viewfinder while the exposure meters are on. Press **OK** to select the center focus point.



The focus selector lock can be rotated to the locked (L) position following selection to prevent the selected focus point from changing when the multi selector is pressed.



Auto-area AF

The focus point for auto-area AF is selected automatically; manual focus-point selection is not available.

See Also

For information on choosing when the focus point is illuminated, see Custom Setting a5 (**Focus point illumination**, [□ 248](#)). For information on setting focus-point selection to “wrap around,” see Custom Setting a6 (**Focus point wrap-around**, [□ 249](#)). For information on choosing the number of focus points that can be selected using the multi selector, see Custom Setting a7 (**Number of focus points**, [□ 249](#)). For information on changing the role of the **OK** button, see Custom Setting f2 (**OK button**, [□ 261](#)).

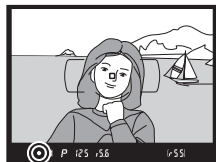


Focus Lock

Focus lock can be used to change the composition after focusing, making it possible to focus on a subject that will not be in a focus point in the final composition. If the camera is unable to focus using autofocus (□ 61), focus lock can also be used to recompose the photograph after focusing on another object at the same distance as your original subject. Focus lock is most effective when an option other than auto-area AF is selected for AF-area mode (□ 62).

1 Focus.

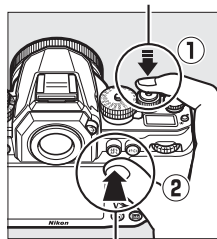
Position the subject in the selected focus point and press the shutter-release button halfway to initiate focus. Check that the in-focus indicator (●) appears in the viewfinder.



2 Lock focus.

AE-C focus mode: With the shutter-release button pressed halfway (①), press the **AE-L/AF-L** button (②) to lock both focus and exposure (an **AE-L** icon will be displayed in the viewfinder). Focus will remain locked while the **AE-L/AF-L** button is pressed, even if you later remove your finger from the shutter-release button.

Shutter-release button



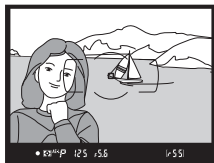
AE-L/AF-L button



AE-S focus mode: Focus locks automatically when the in-focus indicator (●) appears, and remain locked until you remove your finger from the shutter-release button. Focus can also be locked by pressing the **AE-L/AF-L** button (see above).

3 Recompose the photograph and shoot.

Focus will remain locked between shots if you keep the shutter-release button pressed halfway (**AF-S**) or keep the **AE-L/AF-L** button pressed, allowing several photographs in succession to be taken at the same focus setting.



Do not change the distance between the camera and the subject while focus lock is in effect. If the subject moves, focus again at the new distance.

Locking Focus with the AF-ON Button

During viewfinder photography, the **AF-ON** button can be used in place of the shutter-release button to lock focus (□ 60). If **AF-ON only** is selected for Custom Setting a4 (**AF activation**, □ 247), the camera will not focus when the shutter-release button is pressed halfway; instead, the camera will focus when the **AF-ON** button is pressed, at which point focus will lock and remain locked until the button is pressed again. The shutter can be released at any time, regardless of the options selected for Custom Settings a1 (**AF-C priority selection**, □ 246) and a2 (**AF-S priority selection**, □ 246), and the in-focus indicator (●) will not be displayed in the viewfinder.

See Also

See Custom setting c1 (**Shutter-release button AE-L**, □ 251) for information on using the shutter-release button to lock exposure, Custom Setting f6 (**Assign AE-L/AF-L button**, □ 267) for information on choosing the role played by the **AE-L/AF-L** button.



Manual Focus

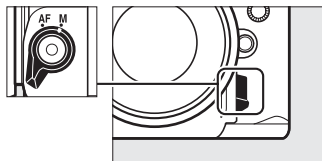
Manual focus is available for lenses that do not support autofocus (non-AF NIKKOR lenses) or when the autofocus does not produce the desired results (▢ 61).

- **AF-S lenses:** Set the lens focus mode switch to **M**.
- **AF lenses:** Set the lens focus mode switch (if present) and camera focus-mode selector to **M**.

✓ AF Lenses

Do not use AF lenses with the lens focus mode switch set to **M** and the camera focus-mode selector set to **AF**. Failure to observe this precaution could damage the camera or lens.

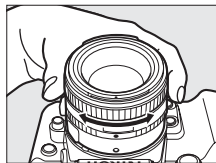
Focus-mode selector



- **Manual focus lenses:** Set the camera focus-mode selector to **M**.

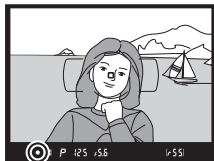
To focus manually, adjust the lens focus ring until the image displayed on the clear matte field in the viewfinder is in focus.

Photographs can be taken at any time, even when the image is not in focus.



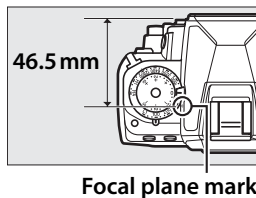
■ The Electronic Rangefinder

The viewfinder focus indicator can be used to confirm whether the subject in the selected focus point is in focus (the focus point can be selected from any of the 39 focus points). After positioning the subject in the selected focus point, press the shutter-release button halfway and rotate the lens focus ring until the in-focus indicator (●) is displayed. Note that with the subjects listed on page 61, the in-focus indicator may sometimes be displayed when the subject is not in focus; confirm focus in the viewfinder before shooting. For information on using the electronic rangefinder with optional AF-S/AF-I teleconverters, see page 321.



Focal Plane Position

To determine the distance between your subject and the camera, measure from the focal plane mark (⊖) on the camera body. The distance between the lens mounting flange and the focal plane is 46.5 mm (1.83 in.).



ISO

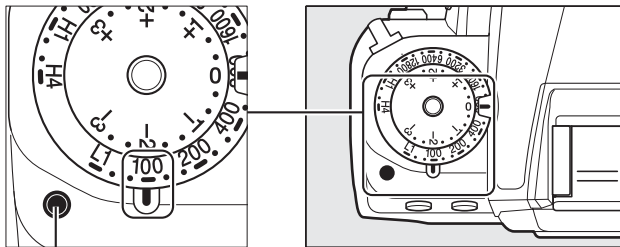
ISO Sensitivity

The ISO Sensitivity Dial

ISO sensitivity can be set to values between ISO 100 and ISO 12800 in increments of $\frac{1}{3}$ EV, or choose from settings of from about 0.3 to 1 EV below ISO 100 and 0.3 to 4 EV above ISO 12800 for special situations.

ISO sensitivity is selected using the ISO sensitivity dial. Keeping the ISO sensitivity dial lock release pressed, rotate the dial to the desired setting.

ISO sensitivity dial



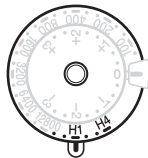
ISO sensitivity dial lock release

The selected value is displayed in the viewfinder while the dial is in motion.



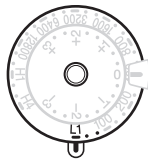
Hi 0.3–Hi 4

The settings Hi 0.3 through Hi 4 correspond to ISO sensitivities 0.3–4 EV over ISO 12800 (ISO 16000–204800 equivalent). Pictures taken at these settings are more likely to be subject to noise (randomly-spaced bright pixels, fog, or lines).



Lo 0.3–Lo 1

The settings Lo 0.3 through Lo 1 correspond to ISO sensitivities 0.3–1 EV below ISO 100 (ISO 80–50 equivalent). Use for larger apertures when lighting is bright. Contrast is slightly higher than normal; in most cases, ISO sensitivities of ISO 100 or above are recommended.



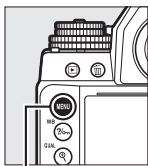
See Also

For information on using the **High ISO NR** option in the shooting menu to reduce noise at high ISO sensitivities, see page 242.

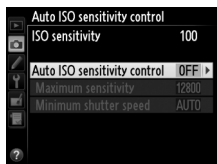
Auto ISO Sensitivity Control

If **On** is selected for **Auto ISO sensitivity control** > **Auto ISO sensitivity control** in the shooting menu, ISO sensitivity will automatically be adjusted if optimal exposure can not be achieved at the value selected by the user (ISO sensitivity is adjusted appropriately when the flash is used).

1 Select Auto ISO sensitivity control for Auto ISO sensitivity control in the shooting menu.



MENU button



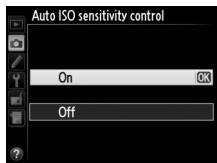
To display the menus, press the MENU button. Select

Auto ISO sensitivity control in the shooting menu, highlight **Auto ISO sensitivity control** and press ►. **ISO sensitivity** shows the value selected with the ISO sensitivity dial.

ISO

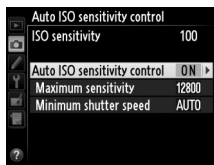
2 Select On.

Highlight **On** and press **OK** (if **Off** is selected, ISO sensitivity will remain fixed at the value selected with the ISO sensitivity dial).



3 Adjust settings.

The maximum value for auto ISO sensitivity can be selected using **Maximum sensitivity** (the minimum value for auto ISO sensitivity is automatically





set to ISO 100; note that if the ISO sensitivity selected by the user is higher than that chosen for **Maximum sensitivity**, the value selected by the user will be used instead). In exposure modes **P** and **A**, sensitivity will only be adjusted if underexposure would result at the shutter speed selected for **Minimum shutter speed** ($1/2000$ –1 s, or **Auto**; in exposure modes **S** and **M**, ISO sensitivity will be adjusted for optimal exposure at the shutter speed selected by the user). If **Auto** is selected, the camera will choose the minimum shutter speed based on the focal length of the lens. Press **OK** to exit when settings are complete.

Minimum Shutter Speed

Auto shutter-speed selection can be fine-tuned by highlighting **Auto** and pressing **▶**: for example, values faster than those usually selected automatically can be used with telephoto lenses to reduce blur. Note, however, that **Auto** is available only with CPU lenses or when lens data are provided for non-CPU lenses; if a non-CPU lens is used without lens data, minimum shutter speed is fixed at $1/30$ s. Shutter speeds may drop below the selected minimum if optimum exposure can not be achieved at the ISO sensitivity chosen for **Maximum sensitivity**.

Auto ISO Sensitivity Control




Noise (randomly-spaced bright pixels, fog, or lines) is more likely at higher sensitivities. Use the **High ISO NR** option in the shooting menu to reduce noise (see page 242). When a flash is used, the value selected for **Minimum shutter speed** is ignored in favor of the option selected for Custom Setting e1 (**Flash sync speed**,  257). Note that ISO sensitivity may be raised automatically when auto ISO sensitivity control is used in combination with slow sync flash modes (available with optional flash units;  116), possibly preventing the camera from selecting slow shutter speeds.



Exposure

Metering

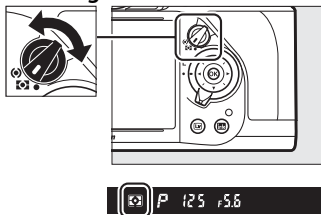
Metering determines how the camera sets exposure. The following options are available:

Option	Description
	<p>Matrix: Produces natural results in most situations. Camera meters a wide area of the frame and set exposure according to tone distribution, color, composition, and, with type G, E, or D lenses (☐ 320), distance information (3D color matrix metering II; with other CPU lenses, camera uses color matrix metering II, which does not include 3D distance information). With non-CPU lenses, camera uses color matrix metering if focal length and maximum aperture are specified using Non-CPU lens data option in setup menu (☐ 164); otherwise camera uses center-weighted metering.</p>
	<p>Center-weighted: Camera meters entire frame but assigns greatest weight to center area (if CPU lens is attached, size of area can be selected using Custom Setting b1, Center-weighted area, ☐ 250; if non-CPU lens is attached, area is 12 mm in diameter). Classic meter for portraits; recommended when using filters with an exposure factor (filter factor) over 1×.</p>
	<p>Spot: Camera meters circle 4 mm (0.16 in.) in diameter (approximately 1.5% of frame). Circle is centered on current focus point, making it possible to meter off-center subjects (if non-CPU lens is used or if auto-area AF is in effect, camera will meter center focus point). Ensures that subject will be correctly exposed, even when background is much brighter or darker.</p>





To choose a metering method, rotate the metering selector until the desired setting is displayed in the viewfinder.

Metering selector



See Also

For information on choosing the size of the area assigned the greatest weight in center-weighted metering, see Custom Setting b1 (**Center-weighted area**,  250). For information on making separate adjustments to optimal exposure for each metering method, see Custom Setting b2 (**Fine-tune optimal exposure**,  250).

Autoexposure Lock

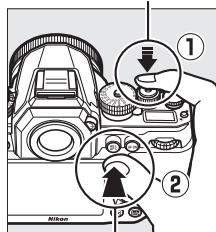
Use autoexposure lock to recompose photographs after using center-weighted metering and spot metering to meter exposure. Note that matrix metering will not produce the desired results.

1 Lock exposure.

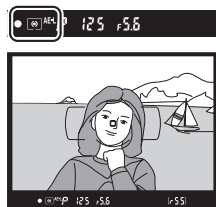
Position the subject in the selected focus point and press the shutter-release button halfway. With the shutter-release button pressed halfway and the subject positioned in the focus point, press the **AE-L/AF-L** button to lock focus and exposure (if you are using autofocus, confirm that the ● in-focus indicator appears in the viewfinder).

While exposure lock is in effect, an **AE-L** indicator will appear in the viewfinder.

Shutter-release button



AE-L/AF-L button



2 Recompose the photograph.

Keeping the **AE-L/AF-L** button pressed, recompose the photograph and shoot.




Metered Area

In spot metering, exposure will be locked at the value metered in a 4-mm (0.16 in.) circle centered on the selected focus point. In center-weighted metering, exposure will be locked at the value metered in a 12-mm circle in the center of the viewfinder.




Adjusting Shutter Speed and Aperture

While exposure lock is in effect, the following settings can be adjusted without altering the metered value for exposure:

Exposure mode	Setting
P	Shutter speed and aperture (flexible program;  38)
S	Shutter speed
A	Aperture

The new values can be confirmed in the viewfinder and control panel. Note that metering can not be changed while exposure lock is in effect.

See Also

If **On** is selected for Custom Setting c1 (**Shutter-release button AE-L**,  251), exposure will lock when the shutter-release button is pressed halfway. For information on changing the role of the  **AE-L/AF-L button**, see Custom Setting f6 (**Assign AE-L/AF-L button**,  267).



Exposure Compensation

Exposure compensation is used to alter exposure from the value suggested by the camera, making pictures brighter or darker. It is most effective when used with center-weighted or spot metering (☐ 75). Choose from values between -3 EV (underexposure) and $+3$ EV (overexposure) in increments of $1/3$ EV. In general, positive values make the subject brighter while negative values make it darker.



-1 EV



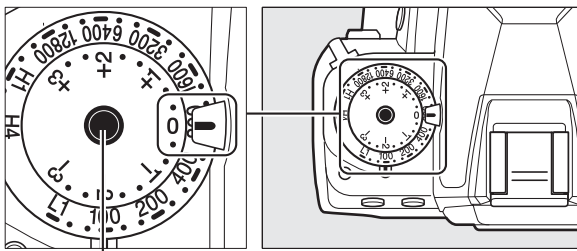
No exposure compensation



$+1$ EV

Exposure compensation is adjusted using the exposure compensation dial. Keeping the exposure compensation dial lock release pressed, rotate the exposure compensation dial to the desired setting.

Exposure compensation dial




Exposure compensation dial lock release



The selected value is shown in the viewfinder while the dial is in motion.



At values other than 0, the 0 at the center of the exposure indicators will flash (exposure modes **P**, **S**, and **A** only) and a  icon will be displayed once a value is selected.




Normal exposure can be restored by setting exposure compensation to 0.



Exposure Mode M

In exposure mode **M**, exposure compensation affects only the exposure indicator; shutter speed and aperture do not change.

Using a Flash

When a flash is used, exposure compensation affects both flash level and exposure, altering the brightness of both the main subject and the background. Custom Setting e4 (**Exposure comp. for flash**,  259) can be used to restrict the effects of exposure compensation to the background only.




See Also

For information on automatically varying exposure, flash level, white balance, or Active D-Lighting, see page 136.

White Balance

White Balance Options

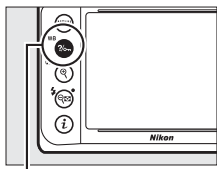
White balance ensures that colors are unaffected by the color of the light source. Auto white balance is recommended with most light sources. If the desired results can not be achieved with auto white balance, choose an option from the list below or use preset white balance.

	Option	Color temp.*	Description
AUTO	Auto	3500– 8000 K	White balance is adjusted automatically. For best results, use type G, E, or D lens. If optional flash fires, results are adjusted appropriately.
	Normal		
	Keep warm lighting colors		
	Incandescent	3000 K	Use under incandescent lighting.
	Fluorescent		Use with:
	Sodium-vapor lamps	2700 K	• Sodium-vapor lighting (found in sports venues).
	Warm-white fluorescent	3000 K	• Warm-white fluorescent lights.
	White fluorescent	3700 K	• White fluorescent lights.
	Cool-white fluorescent	4200 K	• Cool-white fluorescent lights.
	Day white fluorescent	5000 K	• Daylight white fluorescent lights.
	Daylight fluorescent	6500 K	• Daylight fluorescent lights.
	High temp. mercury-vapor	7200 K	• High color temperature light sources (e.g. mercury-vapor lamps).
	Direct sunlight	5200 K	Use with subjects lit by direct sunlight.

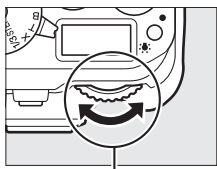
Option	Color temp.*	Description
Flash	5400 K	Use with optional flash units.
Cloudy	6000 K	Use in daylight under overcast skies.
Shade	8000 K	Use in daylight with subjects in the shade.
Choose color temp.	2500–10,000 K	Choose color temperature from list of values (☐ 88).
PRE Preset manual	—	Use subject, light source, or existing photograph as reference for white balance (☐ 90).

* All values are approximate and do not reflect fine-tuning (if applicable).

White balance is set by pressing the (**WB**) button and rotating the main command dial until the desired setting is displayed in the information display.



(**WB**) button



Main command dial



Information display

WB

The Shooting Menu

White balance can also be adjusted using the **White balance** option in the shooting menu (☐ 235), which also can be used to fine-tune white balance (☐ 84) or measure a value for preset white balance (☐ 90). The **Auto** option in the **White balance** menu offers a choice of **Normal** and **Keep warm lighting colors**,

which preserves the warm colors produced by incandescent lighting, while the **Fluorescent** option can be used to select the light source from the bulb types.













SHOOTING MENU	
White balance	AUTO
Set Picture Control	CS
Manage Picture Control	--
Color space	sRGB
Active D-Lighting	OFF
HDR (high dynamic range)	OFF
Vignette control	☐ N
Auto distortion control	OFF

Studio Flash Lighting

Auto white balance may not produce the desired results with large studio flash units. Use preset white balance or set white balance to **Flash** and use fine tuning to adjust white balance.

Color Temperature

The perceived color of a light source varies with the viewer and other conditions. Color temperature is an objective measure of the color of a light source, defined with reference to the temperature to which an object would have to be heated to radiate light in the same wavelengths. While light sources with a color temperature in the neighborhood of 5000–5500 K appear white, light sources with a lower color temperature, such as incandescent light bulbs, appear slightly yellow or red. Light sources with a higher color temperature appear tinged with blue. The camera white balance options are adapted to the following color temperatures:

-  (sodium-vapor lamps): **2700 K**
-  (incandescent)/
 (warm-white fluorescent):
3000 K
-  (white fluorescent): **3700 K**
-  (cool-white fluorescent):
4200 K
-  (day white fluorescent): **5000 K**
-  (direct sunlight): **5200 K**
-  (flash): **5400 K**
-  (cloudy): **6000 K**
-  (daylight fluorescent): **6500 K**
-  (high temp. mercury-vapor):
7200 K
-  (shade): **8000 K**

Fine-Tuning White Balance

White balance can be “fine-tuned” to compensate for variations in the color of the light source or to introduce a deliberate color cast into an image. White balance is fine-tuned using the **White balance** option in the shooting menu or by pressing the **WB** button and rotating the sub-command dial.

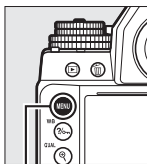
■ The White Balance Menu

1 Select a white balance option in the shooting menu.

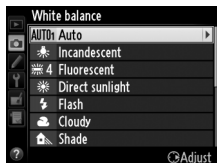
To display the menus, press the **MENU** button. Select

White balance in the shooting menu, then

highlight a white balance option and press **▶**. If an option other than **Auto**, **Fluorescent**, **Choose color temp.**, or **Preset manual** is selected, proceed to Step 2. If **Auto** or **Fluorescent** is selected, highlight the desired setting and press **▶**. For information on fine-tuning preset white balance, see page 97.



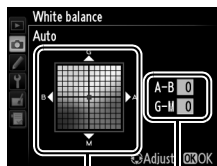
MENU button



2 Fine tune white balance.

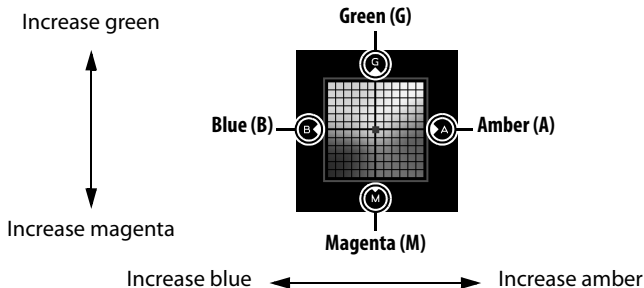
Use the multi selector to fine-tune white balance. White balance can be fine-tuned on the amber (A)–blue (B) axis and the green (G)–magenta (M) axis. The horizontal (amber-blue) axis corresponds to color

temperature, with each increment equivalent to about 5 mired. The vertical (green-magenta) axis has the similar effects to the corresponding color compensation (CC) filters.



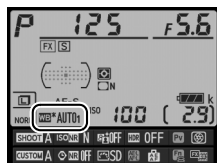
Coordinates

Adjustment




3 Press **OK**.

Press **OK** to save settings and return to the shooting menu. Fine-tuning is indicated by an asterisk ("*") in the information display.



WB

White Balance Fine-Tuning



The colors on the fine-tuning axes are relative, not absolute. For example, moving the cursor to **B** (blue) when a “warm” setting such as  (incandescent) is selected for white balance will make photographs slightly “colder” but will not actually make them blue.

“Mired”

Any given change in color temperature produces a greater difference in color at low color temperatures than it would at higher color temperatures. For example, a change of 1000 K produces a much greater change in color at 3000 K than at 6000 K. Mired, calculated by multiplying the inverse of the color temperature by 10^6 , is a measure of color temperature that takes such variation into account, and as such is the unit used in color-temperature compensation filters. E.g.:

- 4000 K–3000 K (a difference of 1000 K)=83 mired
- 7000 K–6000 K (a difference of 1000 K)=24 mired

See Also

When **WB bracketing** is selected for Custom Setting e6 (**Auto bracketing set**,  259), the camera will create several images each time the shutter is released. White balance will be varied with each image, “bracketing” the value currently selected for white balance ( 141).

Choosing a Color Temperature

When **☑ (Choose color temp.)** is selected for white balance, color temperature can be selected using the **White balance** option in the shooting menu or by using the **WB** button, multi selector, and sub-command dial.

☑ Choose Color Temperature

Note that the desired results will not be obtained with flash or fluorescent lighting. Choose **⚡ (Flash)** or **☀ (Fluorescent)** for these sources. With other light sources, take a test shot to determine if the selected value is appropriate.

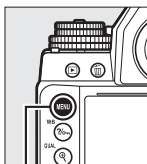
■ The White Balance Menu

Enter values for the amber-blue and green-magenta axes (☞ 85).

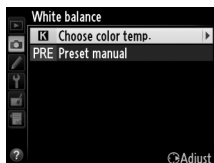
1 Select Choose color temp.

Press the **MENU** button and select **White balance** in the shooting menu.

Highlight **Choose color temp.** and press **▶**.



MENU button



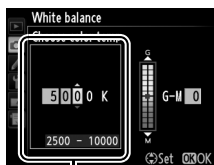
WB

2 Select a value for amber-blue.

Press **◀** or **▶** to highlight digits and press **▲** or **▼** to change.

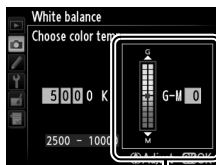


Value for amber (A)-blue (B) axis



3 Select a value for green-magenta.

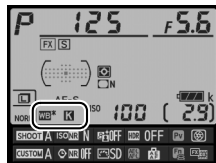
Press ◀ or ▶ to highlight the **G** (green) or **M** (magenta) axis and press ▲ or ▼ to select a value.



Value for green (G)-magenta (M) axis

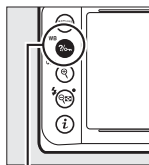
4 Press **OK**.

Press **OK** to save changes and return to the shooting menu. If a value other than 0 is selected for the green (G)–magenta (M) axis, an asterisk (“*”) will be displayed in the information display.

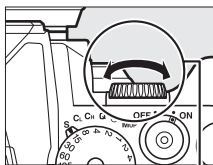


■ The **WB** Button

The **WB** button can be used to select the color temperature for the amber (A)–blue (B) axis only. Press the **WB** button and rotate the sub-command dial until the desired value is displayed in the information display (adjustments are made in mireds; □ 87). To enter a color temperature directly in increments of 10 K, press the **WB** button and press ◀ or ▶ to highlight a digit and press ▲ or ▼ to change.



WB button



Sub-command dial



Information display

Preset Manual

Preset manual is used to record and recall custom white balance settings for shooting under mixed lighting or to compensate for light sources with a strong color cast. The camera can store up to four values for preset white balance in presets d-1 through d-4. Two methods are available for setting preset white balance:

Method	Description
Direct measurement	Neutral gray or white object is placed under lighting that will be used in final photo and white balance measured by camera. In live view photography (☞ 172), white balance can be measured in a selected area of the frame (spot white balance, ☞ 93).
Copy from existing photograph	White balance is copied from photo on memory card (☞ 96).

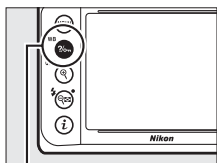
Viewfinder Photography

1 Light a reference object.

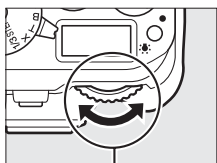
Place a neutral gray or white object under the lighting that will be used in the final photograph. In studio settings, a standard gray panel can be used as a reference object. Note that exposure is automatically increased by 1 EV when measuring white balance; in exposure mode **M**, adjust exposure so that the exposure indicator shows ± 0 (☞ 43).

2 Set white balance to PRE (Preset manual).

Press the **WB** button and rotate the main command dial until **PRE** appears in the information display.



WB button



Main command dial



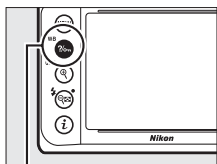
Information display

Measuring Preset White Balance (Viewfinder Photography)

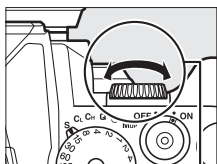
Preset manual white balance can not be measured during HDR photography or multiple exposure (112, 149).

3 Select a preset.

Press the **WB** button and rotate the sub-command dial until the desired white balance preset (d-1 to d-4) is displayed in the information display.



WB button



Sub-command dial



Information display

4 Select direct measurement mode.

Release the **WB** button briefly and then press the button until **PrE** starts to flash in the control panel and viewfinder.



Control panel



Viewfinder

5 Measure white balance.

Before the indicators stop flashing, frame the reference object so that it fills the viewfinder and press the shutter-release button all the way down. The camera will measure a value for white balance and store it in the preset selected in Step 3. No photograph will be recorded; white balance can be measured accurately even when the camera is not in focus.



6 Check the results.

If the camera was able to measure a value for white balance, **Good** will flash in the control panel for about six seconds, while the viewfinder will show a flashing **ūd**.



Control panel



Viewfinder

If lighting is too dark or too bright, the camera may be unable to measure white balance. A flashing **no ūd** will appear in the control panel and viewfinder for about six seconds. Press the shutter-release button halfway to return to Step 5 and measure white balance again.



Control panel



Viewfinder

Protected Presets

If the current preset is protected (🔒 99), **PrE** will flash in the control panel and viewfinder if you attempt to measure a new value.

✔ Direct Measurement Mode

If no operations are performed during viewfinder photography while the displays are flashing, direct measurement mode will end after the sum of the times selected for Custom Settings c4 (**Monitor off delay**) > **Information display** (☰ 253) and Custom Setting c2 (**Standby timer**, ☰ 251).

✎ Selecting a Preset

Selecting **Preset manual** for the **White balance** option in the shooting menu displays the dialog shown at right; highlight a preset and press **OK**. If no value currently exists for the selected preset, white balance will be set to 5200 K, the same as **Direct sunlight**.

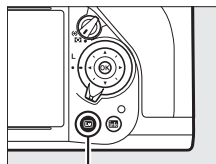


Live View (Spot White Balance)

In live view, white balance can be measured in a selected area of the frame, eliminating the need to prepare a reference object or change lenses during telephoto photography.

1 Press the **Lv** button.

The mirror will be raised and the view through the lens will be displayed in the camera monitor.

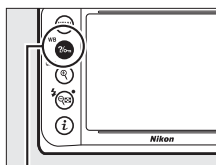


Lv button

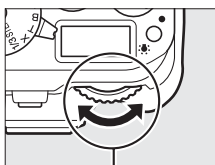
WB

2 Set white balance to PRE (Preset manual).

Press the **WB** button and rotate the main command dial until **PRE** is displayed in the monitor.



WB button



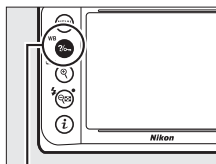
Main command dial



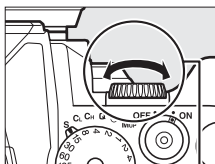
Monitor

3 Select a preset.

Press the **WB** button and rotate the sub-command dial until the desired white balance preset (d-1 to d-4) is displayed in the monitor.



WB button



Sub-command dial



Monitor


4 Select direct measurement mode.

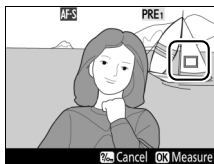
Release the **WB** button briefly and then press the button until the **PRE** icon in the monitor starts to flash. A spot white balance target (□) will be displayed at the selected focus point.



Monitor

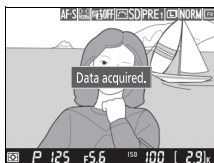
5 Position the target over a white or grey area.

While **P-E** flashes in the display, use the multi selector to position the  over a white or grey area of the subject.



6 Measure white balance.

Press **OK** or press the shutter-release button all the way down to measure white balance. The time available to measure white balance is that selected for Custom Setting c4 (**Monitor off delay**) > **Live view** (📖 253).



If the camera is unable to measure white balance, the message shown at right will be displayed. Choose a new white balance target and repeat the process from Step 4.



When **Preset manual** is selected for **White balance** in the shooting menu, the position of the target used to measure preset white balance will be displayed on presets recorded during live view photography.



Measuring Preset White Balance (Live View Photography)

Preset manual white balance can not set while an HDR exposure is in progress (📖 112).

Managing Presets

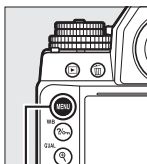
■ Copying White Balance from a Photograph

Follow the steps below to copy a value for white balance from an existing photograph to a selected preset.

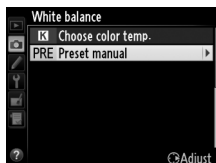
1 Select PRE (Preset manual) for White balance in the shooting menu.

Press the MENU button and select **White balance** in the shooting menu.


Highlight **Preset manual** and press ►.

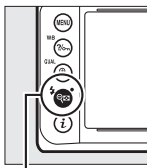



MENU button



2 Select a destination.

Highlight the destination preset (d-1 to d-4) and press  (⚡).



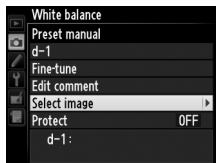
 (⚡) button



WB

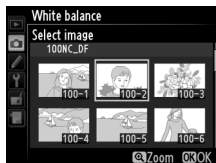
3 Choose Select image.

Highlight **Select image** and press ►.





4 Highlight a source image.

Highlight the source image.




5 Press .



Press  to copy the white balance value for the highlighted photograph to the selected preset. If the highlighted photograph has a comment ( 278), the comment will be copied to the comment for the selected preset.

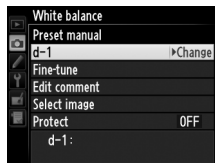


Choosing a Source Image

To view the image highlighted in Step 4 full frame, press and hold the  (**QUAL**) button.

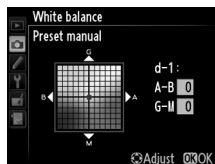
Choosing a White Balance Preset

Press  to highlight the current white balance preset (d-1 – d-4) and press  to select another preset.



Fine-Tuning Preset White Balance

The selected preset can be fine-tuned by selecting **Fine-tune** and adjusting white balance as described on page 85.

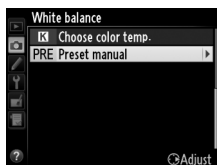


■ Entering a Comment

Follow the steps below to enter a descriptive comment of up to thirty-six characters for a selected white balance preset.

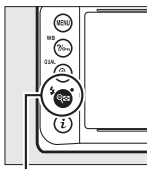
1 Select PRE (Preset manual).

Highlight **Preset manual** in the white balance menu and press



2 Select a preset.

Highlight the desired preset and press (Fn) button.

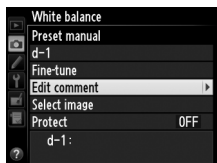


(Fn) button



3 Select Edit comment.

Highlight **Edit comment** and press .



4 Edit the comment.

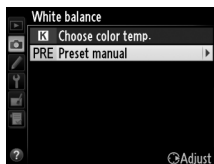
Edit the comment as described on page 107.



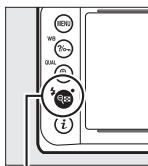
■ Protecting a White Balance Preset

Follow the steps below to protect the selected white balance preset. Protected presets can not be modified and the **Fine-tune** and **Edit comment** options can not be used.

- 1 Select PRE (Preset manual).**
Highlight **Preset manual** in the white balance menu and press **▶**.



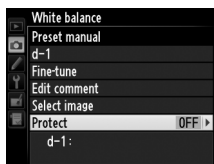
- 2 Select a preset.**
Highlight the desired preset and press **Q/Ⓜ (⚡)**.



Q/Ⓜ (⚡) button



- 3 Select Protect.**
Highlight **Protect** and press **▶**.



- 4 Select On.**
Highlight **On** and press **OK** to protect the selected white balance preset. To remove protection, select **Off**.

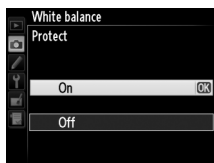










Image Enhancement

Picture Controls

Nikon's unique Picture Control system makes it possible to share image processing settings, including sharpening, contrast, brightness, saturation, and hue, among compatible devices and software.

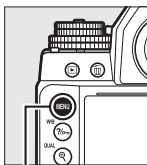
Selecting a Picture Control

The camera offers a choice of preset Picture Controls. Choose a Picture Control according to the subject or type of scene.

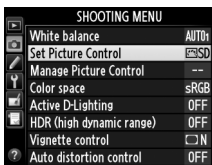
Option	Description
 Standard	Standard processing for balanced results. Recommended for most situations.
 Neutral	Minimal processing for natural results. Choose for photographs that will later be extensively processed or retouched.
 Vivid	Pictures are enhanced for a vivid, photoprint effect. Choose for photographs that emphasize primary colors.
 Monochrome	Take monochrome photographs.
 Portrait	Process portraits for skin with natural texture and a rounded feel.
 Landscape	Produces vibrant landscapes and cityscapes.

1 Display Picture Controls.

To display the menus, press the **MENU** button. Highlight **Set Picture Control** in the shooting menu and press **▶** to display a list of Picture Controls.

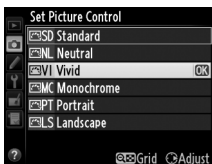


MENU button



2 Choose a Picture Control.

Highlight the desired Picture Control and press **OK**.

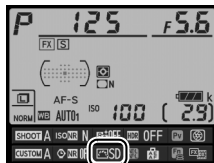


Custom Picture Controls

Custom Picture Controls are created through modifications to existing Picture Controls using the **Manage Picture Control** option in the shooting menu (106). Custom Picture Controls can be saved to a memory card for sharing among other cameras of the same model and compatible software (109).

The Picture Control Indicator

The current Picture Control is shown in the information display when the **info** button is pressed.



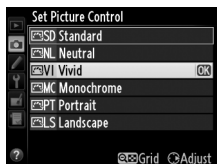
Picture Control indicator

Modifying Picture Controls

Existing preset or custom Picture Controls (📖 106) can be modified to suit the scene or the user's creative intent. Choose a balanced combination of settings using **Quick adjust**, or make manual adjustments to individual settings.

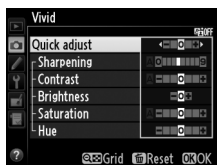
1 Select a Picture Control.

Highlight the desired Picture Control in the Picture Control list (📖 100) and press ▶.



2 Adjust settings.

Press ▲ or ▼ to highlight the desired setting (📖 103) and press ◀ or ▶ to choose a value. Repeat this step until all settings have been adjusted, or select **Quick adjust** to choose a preset combination of settings. Default settings can be restored by pressing the 🗑️ button.



3 Press (OK).



Modifications to Original Picture Controls

Picture Controls that have been modified from default settings are indicated by an asterisk ("*").



Picture Control Settings

Option	Description	
Quick adjust	Choose from options between -2 and +2 to reduce or exaggerate the effect of the selected Picture Control (note that this resets all manual adjustments). For example, choosing positive values for Vivid makes pictures more vivid. Not available with Neutral or Monochrome Picture Controls.	
Manual adjustments (all Picture Controls)	Sharpening	Control the sharpness of outlines. Select A to adjust sharpening automatically according to the type of scene, or choose from values between 0 (no sharpening) and 9 (the higher the value, the greater the sharpening).
	Contrast	Select A to adjust contrast automatically according to the type of scene, or choose from values between -3 and +3 (choose lower values to prevent highlights in portrait subjects from being “washed out” in direct sunlight, higher values to preserve detail in misty landscapes and other low-contrast subjects).
	Brightness	Choose -1 for reduced brightness, +1 for enhanced brightness. Does not affect exposure.
Manual adjustments (non-monochrome only)	Saturation	Control the vividness of colors. Select A to adjust saturation automatically according to the type of scene, or choose from values between -3 and +3 (lower values reduce saturation and higher values increase it).
	Hue	Choose negative values (to a minimum of -3) to make reds more purple, blues more green, and greens more yellow, positive values (up to +3) to make reds more orange, greens more blue, and blues more purple.
Manual adjustments (monochrome only)	Filter effects	Simulate the effect of color filters on monochrome photographs. Choose from Off , yellow, orange, red, and green (☞ 105).
	Toning	Choose the tint used in monochrome photographs from B&W (black-and-white), Sepia , Cyanotype (blue-tinted monochrome), Red , Yellow , Green , Blue Green , Blue , Purple Blue , Red Purple (☞ 105).





✔ "A" (Auto)

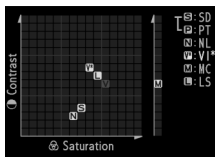
Results for auto sharpening, contrast, and saturation vary with exposure and the position of the subject in the frame. Use a type G, E, or D lens for best results.

✎ Custom Picture Controls

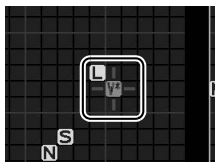
The options available with custom Picture Controls are the same as those on which the custom Picture Control was based.

✎ The Picture Control Grid

Pressing the  (⚡) button in Step 2 on page 102 displays a Picture Control grid showing the contrast and saturation for the selected Picture Control in relation to the other Picture Controls (only contrast is displayed when **Monochrome** is selected). Release the  (⚡) button to return to the Picture Control menu.

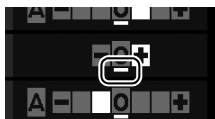


The icons for Picture Controls that use auto contrast and saturation are displayed in green in the Picture Control grid, and lines appear parallel to the axes of the grid.



✎ Previous Settings

The line under the value display in the Picture Control setting menu indicates the previous value for the setting. Use this as a reference when adjusting settings.



Filter Effects (Monochrome Only)

The options in this menu simulate the effect of color filters on monochrome photographs. The following filter effects are available:

Option		Description
Y	Yellow	Enhances contrast. Can be used to tone down the brightness of the sky in landscape photographs. Orange produces more contrast than yellow, red more contrast than orange.
O	Orange	
R	Red	
G	Green	Softens skin tones. Can be used for portraits.

Note that the effects achieved with **Filter effects** are more pronounced than those produced by physical glass filters.

Toning (Monochrome Only)

Pressing ▼ when **Toning** is selected displays saturation options. Press ◀ or ▶ to adjust saturation. Saturation control is not available when **B&W** (black-and-white) is selected.

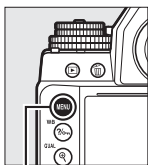


Creating Custom Picture Controls

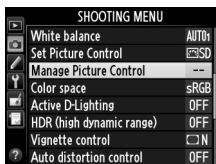
The Picture Controls supplied with the camera can be modified and saved as custom Picture Controls.

1 Select Manage Picture Control in the shooting menu.

To display the menus, press the MENU button. Highlight **Manage Picture Control** in the shooting menu and press ►.



MENU button



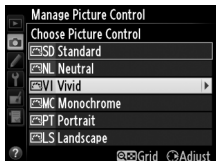
2 Select Save/edit.

Highlight **Save/edit** and press ►.





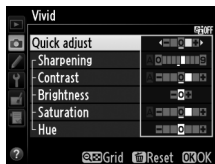
3 Select a Picture Control.

Highlight an existing Picture Control and press ►, or press **OK** to proceed to Step 5 to save a copy of the highlighted Picture Control without further modification.




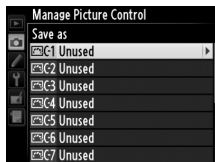
4 Edit the selected Picture Control.

See page 103 for more information. To abandon any changes and start over from default settings, press the  button. Press  when settings are complete.









5 Select a destination.

Choose a destination for the custom Picture Control (C-1 through C-9) and press .



6 Name the Picture Control.

The text-entry dialog shown at right will be displayed. By default, new Picture Controls are named by adding a two-digit number (assigned automatically) to the name of the existing Picture Control; to use the default name, proceed to Step 7. To move the cursor in the name area, hold the  () button and press  or . To enter a new letter at the current cursor position, use the multi selector to highlight the desired character in the keyboard area and press . To delete the character at the current cursor position, press the  button.





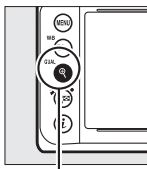
Keyboard area


Name area

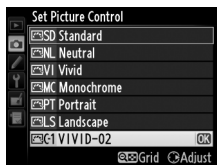
Custom Picture Control names can be up to nineteen characters long. Any characters after the nineteenth will be deleted.



- 7 Press  (QUAL).**
Press the  (**QUAL**) button to save changes and exit. The new Picture Control will appear in the Picture Control list.

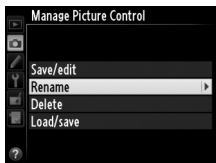


 (**QUAL**) button



Manage Picture Control > Rename

Custom Picture Controls can be renamed at any time using the **Rename** option in the **Manage Picture Control** menu.



Manage Picture Control > Delete

The **Delete** option in the **Manage Picture Control** menu can be used to delete selected custom Picture Controls when they are no longer needed.

The Original Picture Control Icon

The original preset Picture Control on which the custom Picture Control is based is indicated by an icon in the top right corner of the edit display.

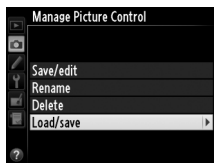
Original Picture Control icon



Sharing Custom Picture Controls

Custom Picture Controls created using the Picture Control Utility available with ViewNX 2 or optional software such as Capture NX 2 can be copied to a memory card and loaded into the camera, or custom Picture Controls created with the camera can be copied to the memory card to be used in other Df cameras and software and then deleted when no longer needed.

To copy custom Picture Controls to or from the memory card, or to delete custom Picture Controls from the memory card, highlight **Load/save** in the **Manage Picture Control** menu and press **▶**. The following options will be displayed:



- **Copy to camera:** Copy custom Picture Controls from the memory card to custom Picture Controls C-1 through C-9 on the camera and name them as desired.

- **Delete from card:** Delete selected custom Picture Controls from the memory card. The confirmation dialog shown at right will be displayed before a Picture Control is deleted; to delete the selected Picture Control, highlight **Yes** and press **OK**.



- **Copy to card:** Copy a custom Picture Control (C-1 through C-9) from the camera to a selected destination (1 through 99) on the memory card.

Saving Custom Picture Controls

Up to 99 custom Picture Controls can be stored on the memory card at any one time. The memory card can only be used to store user-created custom Picture Controls. The preset Picture Controls supplied with the camera (100) can not be copied to the memory card, renamed, or deleted.

Preserving Detail in Highlights and Shadows

Active D-Lighting

Active D-Lighting preserves details in highlights and shadows, creating photographs with natural contrast. Use for high contrast scenes, for example when photographing brightly lit outdoor scenery through a door or window or taking pictures of shaded subjects on a sunny day. It is most effective when used with matrix metering (☞ 75).



Active D-Lighting off



Active D-Lighting: 晒 A Auto



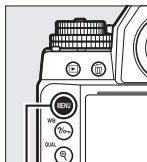
“Active D-Lighting” Versus “D-Lighting”

The **Active D-Lighting** option in the shooting menu adjusts exposure before shooting to optimize the dynamic range, while the **D-Lighting** option in the retouch menu (☞ 291) brightens shadows in images after shooting.

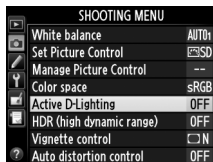
To use Active D-Lighting:

1 Select Active D-Lighting in the shooting menu.

To display the menus, press the **MENU** button. Highlight **Active D-Lighting** in the shooting menu and press



MENU button



2 Choose an option.



Highlight the desired option and press **OK**. If **Auto** is selected, the camera will automatically adjust Active D-Lighting according to shooting conditions (in exposure mode **M**, however, **Auto** is equivalent to **Normal**).



Active D-Lighting

Noise (randomly-spaced bright pixels, fog, or lines) may appear in photographs taken with Active D-Lighting. Uneven shading may be visible with some subjects. Active D-Lighting can not be used at ISO sensitivities of Hi 0.3 or above.

See Also

When **ADL bracketing** is selected for Custom Setting e6 (**Auto bracketing set**,  259), the camera varies Active D-Lighting over a series of shots ( 145).



High Dynamic Range (HDR)

Used with high-contrast subjects, High Dynamic Range (HDR) preserves details in highlights and shadows by combining two shots taken at different exposures. HDR is most effective when used with matrix metering (☞ 75; with other metering methods and a non-CPU lens, an exposure differential of **Auto** is equivalent to about 2 EV). It can not be used to record NEF (RAW) images. HDR can not be used with flash lighting, bracketing (☞ 136), multiple exposure (☞ 149), or shutter speeds of **B** (bulb) or **T** (time).



First exposure
(darker)

+



Second exposure
(brighter)

➔

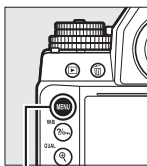


Combined HDR image

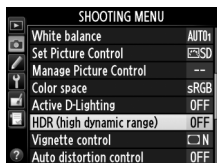
1 Select HDR (high dynamic range).

Press the **MENU** button to display the menus.

Highlight **HDR (high dynamic range)** in the shooting menu and press

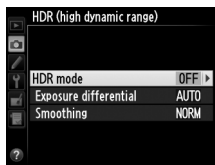



MENU button




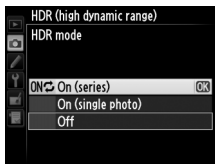
2 Select a mode.

Highlight **HDR mode** and press



Highlight one of the following and press .

- **To take a series of HDR photographs,** select **ON  On (series)**. HDR shooting will continue until you select **Off** for **HDR mode**.
- **To take one HDR photograph,** select **On (single photo)**. Normal shooting will resume automatically after you have created a single HDR photograph.
- **To exit without creating additional HDR photographs,** select **Off**.

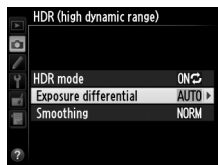


HDR appears in the viewfinder when HDR is enabled.

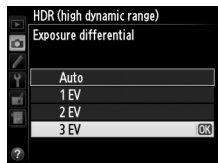


3 Choose the exposure differential.

To choose the difference in exposure between the two shots, highlight **Exposure differential** and press ►.

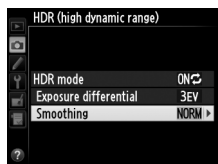


The options shown at right will be displayed. Highlight an option and press **OK**. Choose higher values for high-contrast subjects, but note that choosing a value higher than required may not produce the desired results; if **Auto** is selected, the camera will automatically adjust exposure to suit the scene.



4 Choose the amount of smoothing.

To choose how much the boundaries between the two images are smoothed, highlight **Smoothing** and press ►.

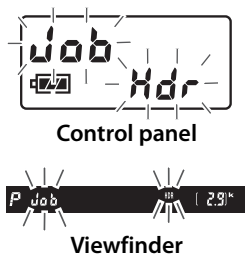


The options shown at right will be displayed. Highlight an option and press **OK**. Higher values produce a smoother composite image. Uneven shading may be visible with some subjects.



5 Frame a photograph, focus, and shoot.

The camera takes two exposures when the shutter-release button is pressed all the way down. **Job Hdr** will be displayed in the control panel and **Job HDR** in the viewfinder while the images are combined; no photographs can be taken until recording is complete. Regardless of the option currently selected for release mode, only one photograph will be taken each time the shutter-release button is pressed.



If **On (series)** is selected, HDR will only turn off when **Off** is selected for **HDR mode**; if **On (single photo)** is selected, HDR turns off automatically after the photograph is taken. The HDR icon clears from the display when HDR shooting ends.

Framing HDR Photographs

The edges of the image will be cropped out. The desired results may not be achieved if the camera or subject moves during shooting. Use of a tripod is recommended. Depending on the scene, shadows may appear around bright objects or halos may appear around dark objects; this effect can be reduced by adjusting the amount of smoothing.

Interval Timer Photography

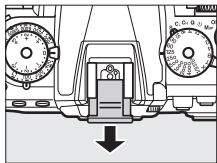
If **On (series)** is selected for **HDR mode** before interval timer shooting begins, the camera will continue to shoot HDR photographs at the selected interval (if **On (single photo)** is selected, interval timer shooting will end after a single shot).

Flash Photography

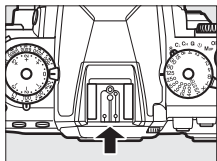
Using a Flash

The camera supports the Nikon Creative Lighting System (CLS) and can be used with CLS-compatible flash units. Optional flash units can be attached directly to the camera accessory shoe as described below. The accessory shoe is equipped with a safety lock for flash units with a locking pin.

- 1 Remove the accessory shoe cover.**



- 2 Mount the flash unit on the accessory shoe.**
See the manual provided with the flash unit for details.



The Sync Terminal

A sync cable can be connected to the sync terminal as required. Do not connect another flash unit via a sync cable when performing rear-curtain sync flash photography with a flash unit mounted on the camera accessory shoe.



Use Only Nikon Flash Accessories

Use only Nikon flash units. Negative voltages or voltages over 250 V applied to the accessory shoe could not only prevent normal operation, but damage the sync circuitry of the camera or flash. Before using a Nikon flash unit not listed in this section, contact a Nikon-authorized service representative for more information.



The Nikon Creative Lighting System (CLS)


Nikon's advanced Creative Lighting System (CLS) offers improved communication between the camera and compatible flash units for improved flash photography.

■ CLS-Compatible Flash Units

The camera can be used with the following CLS-compatible flash units:

• The SB-910, SB-900, SB-800, SB-700, SB-600, SB-400, SB-300, and SB-R200:

Flash unit		Feature							
		SB-910 ¹	SB-900 ¹	SB-800	SB-700 ¹	SB-600	SB-400 ²	SB-300 ²	SB-R200 ³
Guide No. ⁴	ISO 100	34/111	34/111	38/125	28/92	30/98	21/69	18/59	10/33
	ISO 200	48/157	48/157	53/174	39/128	42/138	30/98	25/82	14/46

1 If a color filter is attached to the SB-910, SB-900, or SB-700 when AUTO or  (flash) is selected for white balance, the camera will automatically detect the filter and adjust white balance appropriately.

2 Wireless flash control is not available.

3 Controlled remotely with optional SB-910, SB-900, SB-800, or SB-700 flash unit or SU-800 wireless Speedlight commander.

4 m/ft, 20 °C (68 °F), SB-910, SB-900, SB-800, SB-700, and SB-600 at 35 mm zoom head position; SB-910, SB-900, and SB-700 with standard illumination.

- **SU-800 Wireless Speedlight Commander:** When mounted on a CLS-compatible camera, the SU-800 can be used as a commander for remote SB-910, SB-900, SB-800, SB-700, SB-600, or SB-R200 flash units in up to three groups. The SU-800 itself is not equipped with a flash.



Guide Number

To calculate the range of the flash at full power, divide the Guide Number by the aperture. If, for example, the flash unit has a Guide Number of 34 m or 111 ft (ISO 100, 20 °C/68 °F); its range at an aperture of f/5.6 is $34 \div 5.6$ or about 6.1 meters (or in feet, $111 \div 5.6 =$ approximately 19 ft 10 in.). For each twofold increase in ISO sensitivity, multiply the Guide Number by the square root of two (approximately 1.4).

The following features are available with CLS-compatible flash units:

		CLS-compatible flash units									
		SB-910 SB-900 SB-800	SB-700	SB-600	SU-800			SB-R200	SB-400	SB-300	
					Commander	Close-up photography					
Single flash	i-TTL	i-TTL balanced fill-flash for digital SLR ¹	✓	✓	✓	—	—	—	✓	✓	
		Standard i-TTL flash for digital SLR	✓ ²	✓	✓ ²	—	—	—	✓	✓	
	AA	Auto aperture	✓ ³	—	—	—	—	—	—	—	
	A	Non-TTL auto	✓ ³	—	—	—	—	—	—	—	
	GN	Distance-priority manual	✓	✓	—	—	—	—	—	—	
	M	Manual	✓	✓	✓	—	—	—	✓ ⁴	✓ ⁴	
	RPT	Repeating flash	✓	✓	—	—	—	—	—	—	
Advanced Wireless Lighting	Master	Remote flash control	✓	✓	—	✓	✓	—	—	—	
		i-TTL i-TTL	✓	✓	—	—	—	—	—	—	
		[A:B]	Quick wireless flash control	—	✓	—	—	✓	—	—	—
		AA	Auto aperture	✓ ⁵	—	—	—	—	—	—	—
		A	Non-TTL auto	✓	—	—	—	—	—	—	—
		M	Manual	✓	✓	—	—	—	—	—	—
		RPT	Repeating flash	✓	✓	—	—	—	—	—	—
	Remote	i-TTL	i-TTL	✓	✓	✓	—	—	✓	—	—
		[A:B]	Quick wireless flash control	✓	✓	✓	—	—	✓	—	—
		AA	Auto aperture	✓ ⁵	—	—	—	—	—	—	—
		A	Non-TTL auto	✓	—	—	—	—	—	—	—
		M	Manual	✓	✓	✓	—	—	✓	—	—
		RPT	Repeating flash	✓	✓	✓	—	—	—	—	—
		Flash Color Information Communication	✓	✓	✓	—	—	—	✓	✓	
		Auto FP High-Speed Sync ⁶	✓	✓	✓	✓	✓	✓	—	—	
		FV lock ⁷	✓	✓	✓	✓	✓	✓	✓	✓	
		AF-assist for multi-area AF	✓	✓	✓	✓	—	—	—	—	
		Red-eye reduction	✓	✓	✓	—	—	—	✓	—	
		Camera modeling illumination	✓	✓	✓	✓	✓	✓	—	—	
		Camera flash mode selection	—	—	—	—	—	—	✓	✓	
		Camera flash unit firmware update	✓ ⁸	✓	—	—	—	—	—	✓	



- 1 Not available with spot metering.
- 2 Can also be selected with flash unit.
- 3 AA/A mode selection performed on flash unit using custom settings. Unless lens data have been provided using the **Non-CPU lens data** option in the setup menu, "A" will be selected when a non-CPU lens is used.
- 4 Can only be selected with camera.
- 5 Unless lens data have been provided using the **Non-CPU lens data** option in the setup menu, non-TTL auto (A) is used with non-CPU lenses, regardless of mode selected with flash unit.
- 6 Available only in i-TTL, AA, A, GN, and M flash-control modes.
- 7 Available only in i-TTL, AA, and A flash-control modes.
- 8 Firmware updates for the SB-910 and SB-900 can be performed from the camera.




Modeling Illumination

CLS-compatible flash units such as the SB-910, SB-900, SB-800, SB-700, and SB-600 emit a modeling flash when the camera **Pv** button is pressed. This feature can be used with Advanced Wireless Lighting to preview the total lighting effect achieved with multiple flash units. Modeling illumination can be turned off using Custom Setting e5 **Modeling flash** (☐ 259).

■ Other Flash Units

The following flash units can be used in non-TTL auto and manual modes.

Flash unit	SB-80DX, SB-28DX, SB-28, SB-26, SB-25, SB-24	SB-50DX	SB-30, SB-27 ¹ , SB-22S, SB-22, SB-20, SB-16B, SB-15	SB-23, SB-29 ² , SB-21B ² , SB-29S ²
A Non-TTL auto	✓	—	✓	—
M Manual	✓	✓	✓	✓
 Repeating flash	✓	—	—	—
REAR Rear-curtain sync ³	✓	✓	✓	✓

- 1 Flash mode is automatically set to TTL and shutter-release is disabled. Set flash unit to **A** (non-TTL auto flash).
- 2 Autofocus is available with AF-S VR Micro-Nikkor 105mm f/2.8G IF-ED and AF-S Micro NIKKOR 60mm f/2.8G ED lenses only.
- 3 Available when camera is used to select flash mode.

✓ Notes on Optional Flash Units

Refer to the Speedlight manual for detailed instructions. If the flash unit supports CLS, refer to the section on CLS-compatible digital SLR cameras. The Df is not included in the “digital SLR” category in the SB-80DX, SB-28DX, and SB-50DX manuals.

i-TTL flash control can be used at ISO sensitivities between 100 and 12800. At values over 12800, the desired results may not be achieved at some ranges or aperture settings. If the flash-ready indicator flashes for about three seconds after a photograph is taken, the flash has fired at full power and the photograph may be underexposed.


When an SC-series 17, 28, or 29 sync cable is used for off-camera flash photography, correct exposure may not be achieved in i-TTL mode. We recommend that you select standard i-TTL flash control. Take a test shot and view the results in the monitor.

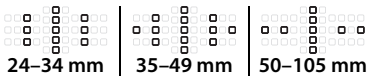
In i-TTL, use the flash panel or bounce adapter provided with the flash unit. Do not use other panels such as diffusion panels, as this may produce incorrect exposure.




The SB-910, SB-900, SB-800, SB-700, SB-600, and SB-400 provide red-eye reduction, while the SB-910, SB-900, SB-800, SB-700, SB-600, and SU-800 provide AF-assist illumination with the following restrictions:

- SB-910 and SB-900:** AF-assist illumination is available with 17–135 mm AF lenses, however, autofocus is available only with the focus points shown at right.


- SB-800, SB-600, and SU-800:** AF-assist illumination is available with 24–105 mm AF lenses, however, autofocus is available only with the focus points shown at right.


- SB-700:** AF-assist illumination is available with 24–135 mm AF lenses, however, autofocus is available only with the focus points shown at right.



In exposure mode **P**, the maximum aperture (minimum f-number) is limited according to ISO sensitivity, as shown below:














Maximum aperture at ISO equivalent of:							
100	200	400	800	1600	3200	6400	12800
4	4.8	5.6	6.7	8	9.5	11	13

If the maximum aperture of the lens is smaller than given above, the maximum value for aperture will be the maximum aperture of the lens.



Flash Control Mode

The information display shows the flash control mode for optional flash units attached to the camera accessory shoe as follows:

	Flash sync	Auto FP (📖 257)
i-TTL		
Auto aperture (AA)		
Non-TTL auto flash (A)		
Distance-priority manual (GN)		
Manual		
Repeating flash		—
Advanced wireless lighting		



i-TTL Flash Control

When a CLS-compatible flash unit (☐ 118) is set to TTL, the camera automatically selects one of the following types of flash control:







i-TTL balanced fill-flash for digital SLR: Flash unit emits series of nearly invisible preflashes (monitor preflashes) immediately before main flash. Preflashes reflected from objects in all areas of frame are picked up by a 2016-segment RGB sensor and are analyzed in combination with range information from matrix metering system to adjust flash output for natural balance between main subject and ambient background lighting. If type G, E, or D lens is used, distance information is included when calculating flash output. Precision of calculation can be increased for non-CPU lenses by providing lens data (focal length and maximum aperture; see ☐ 163). Not available when spot metering is used.

Standard i-TTL flash for digital SLR: Flash output adjusted to bring lighting in frame to standard level; brightness of background is not taken into account. Recommended for shots in which main subject is emphasized at expense of background details, or when exposure compensation is used. Standard i-TTL flash for digital SLR is activated automatically when spot metering is selected.




Flash Modes

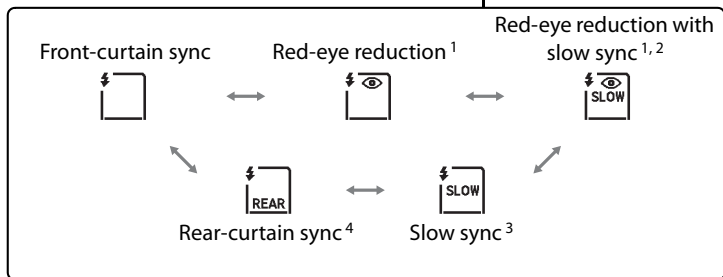
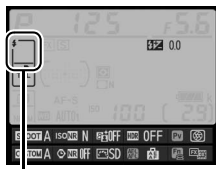
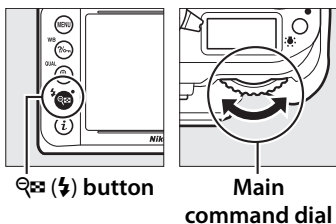
The camera supports the following flash modes:



Flash mode	Description
 Front-curtain sync	This mode is recommended for most situations. In programmed auto and aperture-priority auto exposure modes, shutter speed will automatically be set to values between $1/200$ and $1/60$ s ($1/4000$ to $1/60$ s with Auto FP High-Speed Sync;  257).
 Red-eye reduction	Choose this mode (available with SB-910, SB-900, SB-800, SB-700, SB-600, and SB-400 only) to reduce “red-eye” effect sometimes caused by flash. Not recommended with moving subjects or in other situations in which quick shutter response is required. Do not move camera during shooting.
 Red-eye reduction with slow sync	Combines red-eye reduction with slow sync. Use for portraits taken against a backdrop of night scenery. Available only with SB-910, SB-900, SB-800, SB-700, SB-600, and SB-400 in programmed auto and aperture-priority auto exposure modes. Use of a tripod is recommended to prevent blurring caused by camera shake.
 Slow sync	Flash is combined with shutter speeds as slow as 30 s to capture both subject and background at night or under dim light. This mode is only available in programmed auto and aperture-priority auto exposure modes. Use of tripod is recommended to prevent blurring caused by camera shake.
 Rear-curtain sync	In shutter-priority auto or manual exposure mode, flash fires just before the shutter closes. Use to create effect of a stream of light behind moving objects. In programmed auto and aperture-priority auto, slow rear-curtain sync is used to capture both subject and background. Use of tripod is recommended to prevent blurring caused by camera shake.



■ ■ Choosing a Flash Mode

To choose the flash mode, press the  button and rotate the main command dial until the desired flash mode is selected in the information display:



- 1  icon flashes if flash unit does not support red-eye reduction.
- 2 Red-eye reduction with slow sync is available only in exposure modes **P** and **A**. In exposure modes **S** and **M**, red-eye reduction with slow sync becomes red-eye reduction.
- 3 Available only in exposure modes **P** and **A**. In exposure modes **S** and **M**, slow sync becomes front-curtain sync.
- 4 In exposure modes **P** and **A**, flash-sync mode will be set to slow rear-curtain sync when the  button is released.



Studio Flash Systems


Rear-curtain sync can not be used with studio flash systems, as the correct synchronization can not be obtained.

Shutter Speed and Aperture

Shutter speed and aperture can be set as follows when an optional flash unit is used:



Mode	Shutter speed	Aperture	See page
P	Set automatically by camera ($1/200$ s– $1/60$ s) ^{1,2}	Set automatically by camera	38
S	Value selected by user ($1/200$ s–30 s) ²		39
A	Set automatically by camera ($1/200$ s– $1/60$ s) ^{1,2}	Value selected by user ³	41
M	Value selected by user ($1/200$ s–30 s, Bulb, Time) ²		42

1 Shutter speed may be set as slow as 30 s in slow sync, slow rear-curtain sync, and slow sync with red-eye reduction flash modes.

2 When **1/250 s (Auto FP)** or **1/200 s (Auto FP)** is selected for Custom Setting e1 (**Flash sync speed**,  257), speeds as fast as $1/4000$ s are available with optional flash units that support auto FP high-speed sync.

3 Flash range varies with aperture and ISO sensitivity. When setting aperture in exposure modes **A** and **M**, consult the table of flash ranges provided with optional flash unit.


See Also

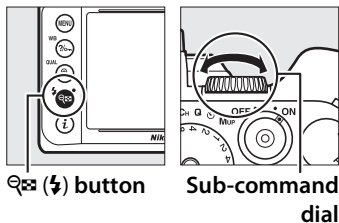
For information on choosing a flash sync speed, see Custom Setting e1 (**Flash sync speed**,  257). For information on choosing the slowest shutter speed available when using the flash, see Custom Setting e2 (**Flash shutter speed**,  258).






Flash Compensation

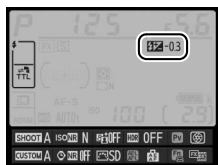
Flash compensation is used to alter flash output by from -3 EV to $+1\text{ EV}$ in increments of $\frac{1}{3}\text{ EV}$, changing the brightness of the main subject relative to the background. Flash output can be increased to make the main subject appear brighter, or reduced to prevent unwanted highlights or reflections.

Press the  button and rotate the sub-command dial until the desired value is displayed in the information display. In general, choose positive values to make the main subject brighter, negative values to make it darker.



At values other than ± 0.0 , a  icon will be displayed in the information display and viewfinder after you release the  button. The current value for flash compensation can be confirmed by pressing the  button.

Normal flash output can be restored by setting flash compensation to ± 0.0 . Flash compensation is not reset when the camera is turned off.



P 125 f5.6  0.0 

$\pm 0\text{ EV}$

( button pressed)

P 125 f5.6  0.3 

-0.3 EV


P 125 f5.6  1.0 

$+1.0\text{ EV}$

Optional Flash Units

The flash compensation selected with the optional flash unit is added to the flash compensation selected with the camera.

See Also

For information on choosing how flash and exposure compensation combine, see Custom Setting e4 (**Exposure comp. for flash**,  259).
For information on automatically varying flash level over a series of shots, see page 136.



FV Lock

This feature is used to lock flash output, allowing photographs to be recomposed without changing the flash level and ensuring that flash output is appropriate to the subject even when the subject is not positioned in the center of the frame. Flash output is adjusted automatically for any changes in ISO sensitivity and aperture. FV lock is available with CLS compatible flash units only (☞ 118).

To use FV lock:

- 1 Assign FV lock to a camera control.**
Select **FV lock** as the “press” option for Custom Setting f4 (**Assign Fn button**, ☞ 263), f5 (**Assign preview button**, ☞ 266), or f6 (**Assign AE-L/AF-L button**, ☞ 267).



- 2 Attach a CLS-compatible flash unit.**

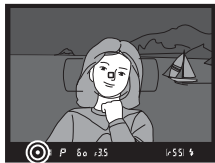
Mount a CLS-compatible flash unit (☞ 118) on the camera accessory shoe.

- 3 Set the flash unit to the appropriate mode.**

Turn the flash unit on and set the flash mode to TTL, monitor pre-flash AA, or monitor pre-flash A. See the Speedlight instruction manual for details.

4 Focus.

Position the subject in the center of the frame and press the shutter-release button halfway to focus.



5 Lock flash level.

After confirming that the flash ready indicator (⚡) is displayed in the viewfinder, press button selected in Step 1. The flash will emit a monitor preflash to determine the appropriate flash level. Flash output will be locked at this level and FV lock icon (⚡) will appear in the viewfinder.



6 Recompose the photograph.



7 Take the photograph.

Press the shutter-release button the rest of the way down to shoot. If desired, additional pictures can be taken without releasing FV lock.



8 Release FV lock.

Press the button selected in Step 1 to release FV lock. Confirm that the FV lock icon (⚡) is no longer displayed in the viewfinder.

 **Metering**



The metering areas for FV lock when using optional flash unit are as follows:

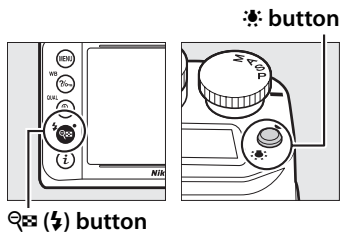
Flash unit	Flash mode	Metered area
Stand-alone flash unit	i-TTL	5-mm circle in center of frame
	AA	Area metered by flash exposure meter
Used with other flash units (Advanced Wireless Lighting)	i-TTL	Entire frame
	AA	Area metered by flash exposure meter
	A (master flash)	




Other Shooting Options


Two-Button Reset: Restoring Default Settings

The camera settings listed below can be restored to default values by holding the  and  buttons down together for more than two seconds (these buttons are marked by a green dot). The control panel turns off briefly while settings are reset.




■ Settings Accessible from the Shooting Menu ¹

Option	Default	
Image quality	JPEG normal	55
Image size	Large	58
White balance	Auto > Normal	81
Fine tuning	A-B: 0, G-M: 0	84
HDR (high dynamic range)	Off ²	112
Auto ISO sensitivity control	Off	72
Interval timer shooting	Off ³	156
Picture Control settings ⁴	Unmodified	100
Multiple exposure	Off ⁵	149


- 1 With the exception of multiple exposure and interval timer settings, only settings in the bank currently selected using the **Shooting menu bank** option will be reset ( 236). Settings in the remaining banks are unaffected.
- 2 Exposure differential and smoothing are not reset.
- 3 If interval timer shooting is currently in progress, shooting will end. Starting time, shooting interval, and number of intervals and shots are not reset.
- 4 Current Picture Control only.
- 5 If multiple exposure is currently in progress, shooting will end and multiple exposure will be created from exposures recorded to that point. Gain and number of shots are not reset.



■ ■ Other Settings

Option	Default	
Autofocus (viewfinder)		
Autofocus mode	AF-S	59
AF-area mode	Single-point AF	62
Autofocus (live view)		
Autofocus mode	AF-S	175
AF-area mode	Normal-area AF	177
Focus point ¹	Center	64
AE lock hold	Off	66, 77
Bracketing	Off	136
Flash compensation	Off	128
Flash mode	Front-curtain sync	125
Exposure delay mode ²	Off	256
FV lock	Off	130
Flexible program	Off	38
+ NEF (RAW)	Off	264

1 Focus point not displayed if auto-area AF is selected for AF-area mode.

2 Only settings in the bank currently selected using the **Custom settings bank** option will be reset ( 245). Settings in the remaining banks are unaffected.



Bracketing

Bracketing automatically varies exposure, flash level, **Active D-Lighting (ADL)**, or white balance slightly with each shot, “bracketing” the current value. Choose in situations in which it is difficult to set exposure, flash level (i-TTL and, where supported, auto aperture flash control modes only; see pages 119 and 124), **Active D-Lighting**, or white balance and there is not time to check results and adjust settings with each shot, or to experiment with different settings for the same subject.

■ ■ Exposure and Flash Bracketing

To vary exposure and/or flash level over a series of photographs:



Exposure modified by:
0 EV

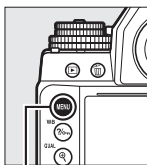


Exposure modified by:
-1 EV

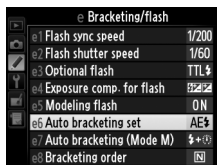


Exposure modified by:
+1 EV

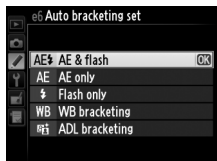
- 1 Select flash or exposure bracketing for Custom Setting e6 (**Auto bracketing set**) in the Custom Settings menu.



MENU button



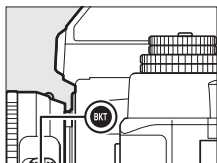
To display the menus, press the MENU button. Select Custom Setting e6 (**Auto bracketing set**) in the Custom Settings menu, highlight an option, and press OK. Choose **AE &**



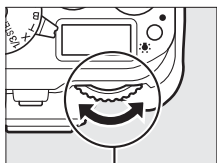
flash to vary both exposure and flash level, **AE only** to vary only exposure, or **Flash only** to vary only flash level.

2 Choose the number of shots.

Pressing the **BKT** button, rotate the main command dial to choose the number of shots in the bracketing sequence. The number of shots is shown in information display.



BKT button



Main command dial



Information display

Exposure and flash
bracketing indicator

At settings other than **AF**, a **BKT** icon is displayed in the control panel. **BKT** appears in the viewfinder, while the information display provides a bracketing indicator and an icon showing the type of bracketing: **AE-BKT** (exposure and flash bracketing), **AE-BKT** (exposure bracketing only), or **AF-BKT** (flash bracketing only).

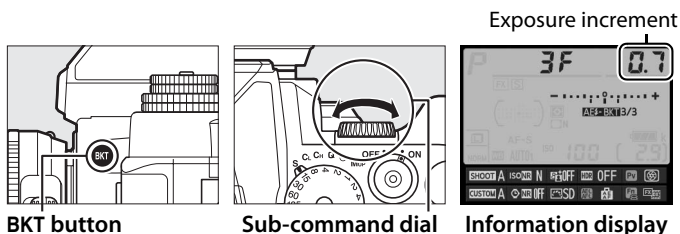


Viewfinder



3 Select an exposure increment.


Pressing the **BKT** button, rotate the sub-command dial to choose the exposure increment.



At default settings, the size of the increment can be chosen from 0.3 ($1/3$), 0.7 ($2/3$), 1, 2, and 3 EV. The bracketing programs with an increment of $1/3$ EV are listed below.

Information display	No. of shots	Bracketing order (EVs)
0F 0.3 -.....°.....+	0	0
+ 3F 0.3 -.....°;:.....+	3	0/+0.3/+0.7
-- 3F 0.3 -.....°;:.....+	3	0/-0.7/-0.3
+ 2F 0.3 -.....°;:.....+	2	0/+0.3
-- 2F 0.3 -.....°;:.....+	2	0/-0.3
3F 0.3 -.....°;:.....+	3	0/-0.3/+0.3
5F 0.3 -.....°;:.....+	5	0/-0.7/-0.3/+0.3/+0.7

See Also

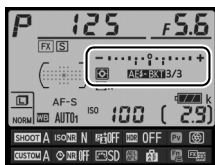
For information on choosing the order in which bracketing is performed, see Custom Setting e8 (**Bracketing order**,  260).

4 Frame a photograph, focus, and shoot.

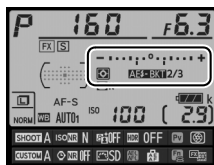


The camera will vary exposure and/or flash level shot-by-shot according to the bracketing program selected. Modifications to exposure are added to those made with exposure compensation (see page 79).

A bracketing progress indicator can be viewed by activating the information display. A segment will disappear from the indicator after each shot.



No. shots: 3; increment: 0.7



Display after first shot

■ ■ *Canceling Bracketing*

To cancel bracketing, press the **BKT** button and rotate the main command dial until the number of shots in the bracketing sequence is zero (**0F**) and the bracketing icon (**AE3-BKT**, **AE-BKT**, or **B-KT**) is no longer displayed. The program last in effect will be restored the next time bracketing is activated. Bracketing can also be cancelled by performing a two-button reset (□ 133), although in this case the bracketing program will not be restored the next time bracketing is activated.



Exposure and Flash Bracketing

In continuous low speed and continuous high speed modes, shooting will pause after the number of shots specified in the bracketing program have been taken. Shooting will resume the next time the shutter-release button is pressed. In self-timer mode, the camera will take the number of shots selected in Step 2 on page 137 each time the shutter-release button is pressed, regardless of the option selected for Custom Setting c3 (**Self-timer**) > **Number of shots** (☐ 252); the interval between shots is however controlled by Custom Setting c3 (**Self-timer**) > **Interval between shots**. In other modes, one shot will be taken each time the shutter-release button is pressed.

If the memory card fills before all shots in the sequence have been taken, shooting can be resumed from the next shot in the sequence after the memory card has been replaced or shots have been deleted to make room on the memory card. If the camera is turned off before all shots in the sequence have been taken, bracketing will resume from the next shot in the sequence when the camera is turned on.

Exposure Bracketing

The camera modifies exposure by varying shutter speed and aperture (programmed auto), aperture (shutter-priority auto), or shutter speed (aperture-priority auto, manual exposure mode). If **On** is selected for **Auto ISO sensitivity control** > **Auto ISO sensitivity control** (☐ 72) in exposure modes **P**, **S**, and **A** and no flash is attached, the camera will modify exposure by varying ISO sensitivity and only vary shutter speed and/or aperture if the limits of exposure system are exceeded. Custom Setting e7 (**Auto bracketing (mode M)**, ☐ 260) can be used to change how the camera performs exposure and flash bracketing in manual exposure mode. Bracketing can be performed by varying flash level together with shutter speed and/or aperture, or by varying flash level alone.

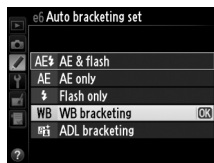


■ White Balance Bracketing

The camera creates multiple copies of each photograph, each with a different white balance. For more information on white balance, see page 81.

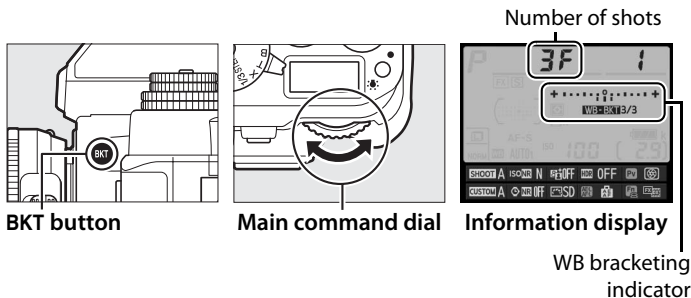
1 Select white balance bracketing.

Choose **WB bracketing** for Custom Setting e6 **Auto bracketing set**.



2 Choose the number of shots.

Pressing the **BKT** button, rotate the main command dial to choose the number of shots in the bracketing sequence. The number of shots is shown in the information display.

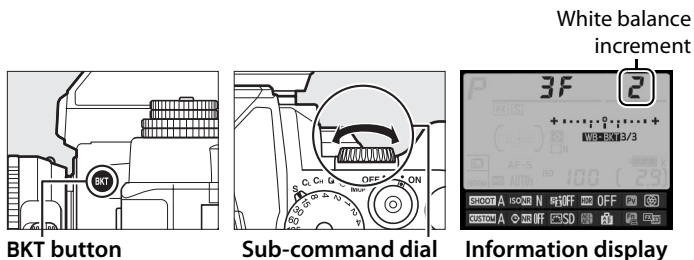


At settings other than **AF**, **BKT** and **BKT** are displayed respectively in the control panel and viewfinder; a **WB-BKT** icon and a bracketing indicator appear in the information display.



3 Select a white balance increment.

Pressing the **BKT** button, rotate the sub-command dial to choose the white balance adjustment. Each increment is roughly equivalent to 5 mired.



Choose from increments of 1 (5 mired), 2 (10 mired), or 3 (15 mired). Higher **B** values correspond to increased amounts of blue, higher **A** values to increased amounts of amber (☞ 87). The bracketing programs with an increment of 1 are listed below.

Information display	No. of shots	White balance increment	Bracketing order (EVs)
OF 1 +.....°.....+	0	1	0
b2F 1 +.....;i.....+	2	1 B	0 / 1 B
A2F 1 +.....;i.....+	2	1 A	0 / 1 A
3F 1 +.....;i.....+	3	1 A, 1 B	0 / 1 A / 1 B

See Also

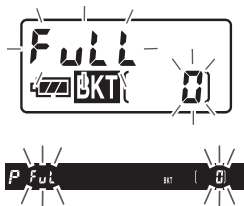
See page 87 for a definition of “mired.”

4 Frame a photograph, focus, and shoot.



Each shot will be processed to create the number of copies specified in the bracketing program, and each copy will have a different white balance. Modifications to white balance are added to the white balance adjustment made with white balance fine-tuning.

If the number of shots in the bracketing program is greater than the number of exposures remaining, **FULL** will flash in the control panel, a flashing **FuL** icon will appear in the viewfinder as shown at right, and the shutter release will be disabled. Shooting can begin when a new memory card is inserted.



■ ■ *Canceling Bracketing*

To cancel bracketing, press the **BKT** button and rotate the main command dial until the number of shots in the bracketing sequence is zero (0) and **WB-BKT** is no longer displayed. The program last in effect will be restored the next time bracketing is activated. Bracketing can also be cancelled by performing a two-button reset (☐ 133), although in this case the bracketing program will not be restored the next time bracketing is activated.

White Balance Bracketing

White balance bracketing is not available at an image quality of NEF (RAW). Selecting **NEF (RAW)**, **NEF (RAW)+JPEG fine**, **NEF (RAW)+JPEG normal**, or **NEF (RAW)+JPEG basic** cancels white balance bracketing.

White balance bracketing affects only color temperature (the amber-blue axis in the white balance fine-tuning display, ☐ 84). No adjustments are made on the green-magenta axis.

In self-timer mode (☐ 48), the number of copies specified in the white-balance program will be created each time the shutter is released, regardless of the option selected for Custom Setting c3 (**Self-timer**) > **Number of shots** (☐ 252).

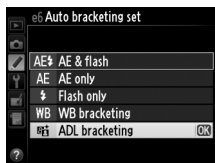
If the camera is turned off while the memory card access lamp is lit, the camera will power off only after all photographs in the sequence have been recorded.

■ ■ ADL Bracketing

The camera varies Active D-Lighting over a series of exposures. For more information on Active D-Lighting, see page 110.

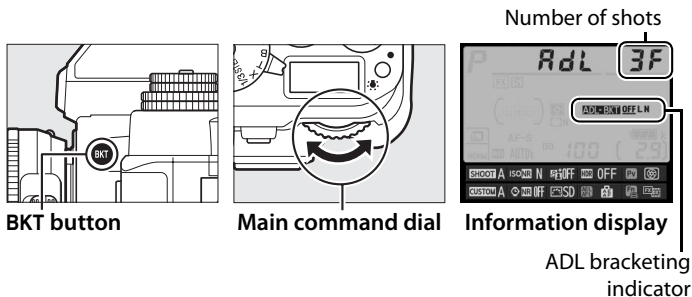
1 Select ADL bracketing.

Choose **ADL bracketing** for Custom Setting e6 **Auto bracketing set**.



2 Choose the number of shots.

Pressing the **BKT** button, rotate the main command dial to choose the number of shots in the bracketing sequence. The number of shots is shown in the information display.

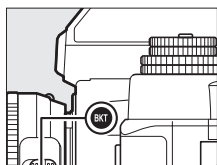


At settings other than **AF**, **BKT** and **BKT** are displayed respectively in the control panel and viewfinder; a **ADL-BKT** icon and a bracketing indicator appear in the information display. Choose two shots to take one photograph with Active D-Lighting off and another at a selected value. Choose three to five shots to take a series of photographs with Active D-Lighting set successively to values between **Off** and **Normal** (three shots), between **Off** and **High** (four shots), or between **Off** and **Extra high 1** or **Low** and **Extra high 2** (five shots). If you choose more than two shots, proceed to Step 4.

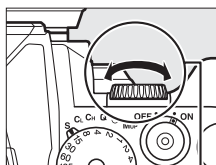


3 Select Active D-Lighting.

Pressing the **BKT** button, rotate the sub-command dial to choose Active D-Lighting.



BKT button



Sub-command dial

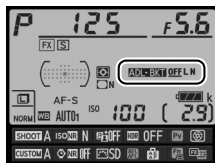
Active D-Lighting is shown in the information display.

Information display	ADL	Information display	ADL
	暗 A Auto		暗 H High
	暗 L Low		暗 H1 Extra high 1
	暗 N Normal		暗 H2 Extra high 2

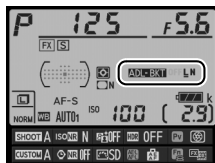
4 Frame a photograph, focus, and shoot.



The camera will vary Active D-Lighting shot-by-shot according to the bracketing program selected. A bracketing progress indicator can be viewed by activating the information display. A segment will disappear from the indicator after each shot.



No. shots: 3



Display after first
shot



■ ■ *Canceling Bracketing*

To cancel bracketing, press the **BKT** button and rotate the main command dial until the number of shots in the bracketing sequence is zero (0) and **ADL-BKT** is no longer displayed. The program last in effect will be restored the next time bracketing is activated. Bracketing can also be cancelled by performing a two-button reset (☐ 133), although in this case the bracketing program will not be restored the next time bracketing is activated.

ADL Bracketing

In continuous low speed and continuous high speed modes, shooting will pause after the number of shots specified in the bracketing program have been taken. Shooting will resume the next time the shutter-release button is pressed. In self-timer mode, the camera will take the number of shots selected in Step 2 on page 145 each time the shutter-release button is pressed, regardless of the option selected for Custom Setting c3 (**Self-timer**) > **Number of shots** (☐ 252); the interval between shots is however controlled by Custom Setting c3 (**Self-timer**) > **Interval between shots**. In other modes, one shot will be taken each time the shutter-release button is pressed.

If the memory card fills before all shots in the sequence have been taken, shooting can be resumed from the next shot in the sequence after the memory card has been replaced or shots have been deleted to make room on the memory card. If the camera is turned off before all shots in the sequence have been taken, bracketing will resume from the next shot in the sequence when the camera is turned on.


Multiple Exposure

Follow the steps below to record a series of two to ten exposures in a single photograph. Multiple exposures can make use of RAW data from the camera image sensor to produce colors noticeably superior to those in software-generated photographic overlays.

■ Creating a Multiple Exposure

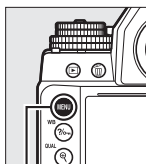
Multiple exposures can not be recorded in live view. Exit live view before proceeding. Note that at default settings, shooting will end and a multiple exposure will be recorded automatically if no operations are performed for 30 s.

Extended Recording Times

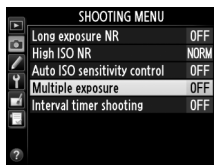
For an interval between exposures of more than 30 s, extend the meter-off delay using Custom Setting c2 (**Standby timer**,  251). The maximum interval between exposures is 30 s longer than the option selected for Custom Setting c2. If the monitor has turned off during playback or menu operations, shooting will end 30 s after the exposure meters turn off and a multiple exposure will be created from the exposures that have been recorded to that point.

1 Select Multiple exposure in the shooting menu.

Press the **MENU** button to display the menus. Highlight **Multiple exposure** in the shooting menu and press **▶**.

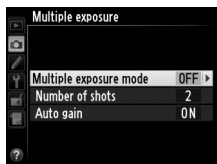


MENU button




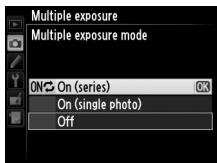
2 Select a mode.

Highlight **Multiple exposure mode** and press **▶**.



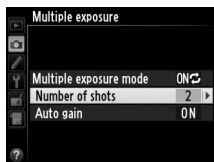
Highlight one of the following and press **⊙**.

- **To take a series of multiple exposures**, select **ON↻ On (series)**. Multiple exposure shooting will continue until you select **Off** for **Multiple exposure mode**.
 - **To take one multiple exposure**, select **On (single photo)**. Normal shooting will resume automatically after you have created a single multiple exposure.
 - **To exit without creating additional multiple exposures**, select **Off**.
- If **On (series)** or **On (single photo)** is selected, a  icon will be displayed in the control panel.

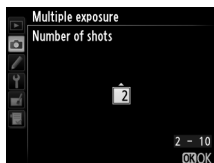


3 Choose the number of shots.





Highlight **Number of shots** and press **▶**.

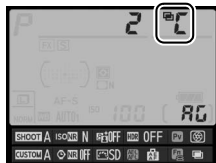


Press **▲** or **▼** to choose the number of exposures that will be combined to form a single photograph and press **OK**.



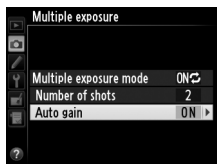
The Command Dial

If **Multiple exposure** is selected as the “+ command dials” option for Custom Setting f4 (**Assign Fn button**,  263) or f5 (**Assign preview button**,  266), you can choose the multiple exposure mode by pressing the selected button and rotating the main command dial, and the number of shots by pressing the button and rotating the sub-command dial. Your selection is shown in the information display; when multiple exposure is enabled, multiple exposure mode is shown as follows:  (with a **!** to the right) for **On (single photo)** and  (with a **⌂** to the right) for **On (series)**.



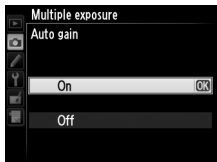
4 Choose the amount of gain.

Highlight **Auto gain** and press



The following options will be displayed. Highlight an option and press **OK**.


- **On**: Gain is adjusted according to number of exposures actually recorded (gain for each exposure is set to $1/2$ for 2 exposures, $1/3$ for 3 exposures, etc.).
- **Off**: Gain is not adjusted when recording multiple exposure. Recommended if background is dark, but note that photographs may be affected by noise (randomly-spaced bright pixels, fog, or lines).




5 Frame a photograph, focus, and shoot.

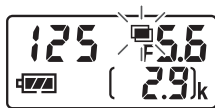


In continuous release modes (☞ 46), the camera records all exposures in a single burst. If **On (series)** is selected, the camera will continue to record multiple exposures while the shutter-release button is pressed; if **On (single photo)** is selected, multiple exposure shooting will end after the first photograph. In self-timer mode, the camera will automatically record the number of exposures selected in Step 3, regardless of the option selected for Custom Setting c3 (**Self-timer**) > **Number of shots** (☞ 252); the interval between shots is however controlled by Custom Setting c3 (**Self-timer**) > **Interval between shots**. In other release modes, one photograph will be taken each time the shutter-release button is pressed; continue shooting until all exposures have been recorded (for information on interrupting a multiple exposure before all photographs are recorded, see page 154).

The  icon will flash until shooting ends.

If **On (series)** is selected, multiple exposure shooting will only end when **Off** is selected for multiple exposure

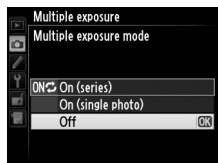
mode; if **On (single photo)** is selected, multiple exposure shooting ends automatically when the multiple exposure is complete. The  icon clears from the display when multiple exposure shooting ends.



■ Interrupting Multiple Exposures

To interrupt a multiple exposure before the specified number of exposures have been taken, select **Off** for multiple exposure mode. If shooting ends before the specified number of exposures have been taken, a multiple exposure will be created from the exposures that have been recorded to that point. If **Auto gain** is on, gain will be adjusted to reflect the number of exposures actually recorded. Note that shooting will end automatically if:

- A two-button reset is performed (📖 133)
- The camera is turned off
- The battery is exhausted
- Pictures are deleted



Multiple Exposures

Do not remove or replace the memory card while recording a multiple exposure.

The shooting information listed in the playback photo information display (including date of recording and camera orientation) is for the first shot in the multiple exposure.

ISO sensitivity is fixed at the value for the first shot in each series; rotating the ISO sensitivity dial while shooting is in progress has no effect.

Interval Timer Photography

If interval timer photography is activated before the first exposure is taken, the camera will record exposures at the selected interval until the number of exposures specified in the multiple exposure menu have been taken (the number of shots listed in the interval timer shooting menu is ignored). These exposures will then be recorded as a single photograph and interval timer shooting will end (if **On (single photo)** is selected for multiple exposure mode, multiple exposure shooting will also end automatically).

Other Settings

While a multiple exposure is being shot, memory cards can not be formatted and some menu items are grayed out and can not be changed.



Interval Timer Photography

The camera is equipped to take photographs automatically at preset intervals.

✔ Before Shooting

Do not select self-timer (☺) or **MUP** release mode when using the interval timer. Before beginning interval timer photography, take a test shot at current settings and view the results in the monitor.

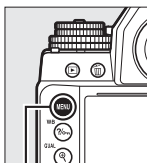
Before choosing a starting time, select **Time zone and date** in the setup menu and make sure that the camera clock is set to the correct time and date (☐ 276).

Use of a tripod is recommended. Mount the camera on a tripod before shooting begins. To ensure that shooting is not interrupted, be sure the camera battery is fully charged. If in doubt, charge the battery before use or use an AC adapter and power connector (available separately).

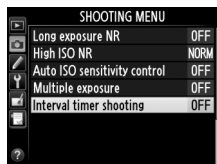
1 Select Interval timer shooting in the shooting menu.

Press the **MENU** button to display the menus.

Highlight **Interval timer shooting** in the shooting menu and press ►.



MENU button

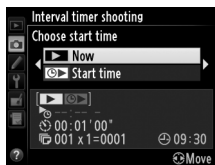


2 Choose a starting time.

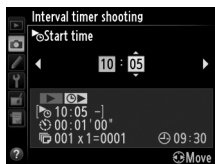
Choose from the following starting triggers.

- **To start shooting immediately**, highlight **Now** and press ►.

Shooting begins about 3 s after settings are completed; proceed to Step 3.

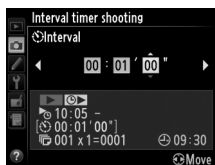


- **To choose a starting time**, highlight **Start time** and press ► to display the start time options shown at right. Press ◀ or ▶ to highlight hours or minutes and press ▲ or ▼ to change. Press ► to continue.



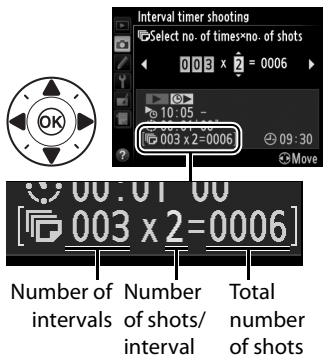
3 Choose the interval.

Press ◀ or ▶ to highlight hours, minutes, or seconds; press ▲ or ▼ to change. Choose an interval longer than the time needed to take the number of shots selected in Step 4. If the interval is too short, the number of photos taken may be less than the total listed in Step 4 (the number of intervals multiplied by the number of shots per interval). Press ► to continue.



4 Choose the number of intervals and number of shots per interval.

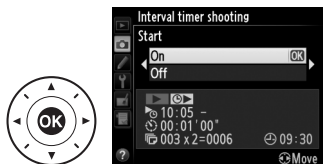
Press ◀ or ▶ to highlight number of intervals or number of shots; press ▲ or ▼ to change. Press ▶ to continue.



5 Start shooting.

Highlight **On** and press **OK** (to return to the shooting menu without starting the interval timer, highlight **Off** and press **OK**). The first series of shots will

be taken at the specified starting time, or after about 3 s if **Now** was selected for **Choose start time** in Step 2. Shooting will continue at the selected interval until all shots have been taken. Note that because the shutter speed, frame rate, and time needed to record images may vary from one interval to the next, the time between the end of one interval and the beginning of the next may vary. If shooting can not proceed at current settings (for example, if a shutter speed of **B** (bulb) or **T** (time) is currently selected in manual exposure mode or the start time is in less than a minute), a warning will be displayed in the monitor.



Out of Memory

If the memory card is full, the interval timer will remain active but no pictures will be taken. Resume shooting (📖 161) after deleting some pictures or turning the camera off and inserting another memory card.

Cover the Viewfinder

To prevent light entering via the viewfinder interfering with photographs and exposure, cover the viewfinder with the supplied DK-26 eyepiece cap (📖 23).

Interval Timer Photography

Interval timer photography can not be combined with long time-exposures (📖 44) or live view (📖 172).

Release Mode

Regardless of the release mode selected, the camera will take the specified number of shots at each interval.

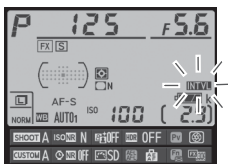
Bracketing

Adjust bracketing settings before starting interval timer photography. If exposure, flash, or ADL bracketing is active while interval timer photography is in effect, the camera will take the number of shots in the bracketing program at each interval, regardless of the number of shots specified in the interval timer menu. If white balance bracketing is active while interval timer photography is in effect, the camera will take one shot at each interval and process it to create the number of copies specified in the bracketing program.

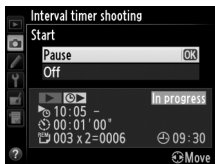


During Shooting

During interval timer photography, the **INTVL** icon in the information display will flash. Immediately before the next shooting interval begins, the shutter speed display in the control panel will show the number of intervals remaining, and the aperture display will show the number of shots remaining in the current interval. At other times, the number of intervals remaining and the number of shots in each interval can be viewed by pressing the shutter-release button halfway (once the button is released, the shutter speed and aperture will be displayed until the standby timer expires).



To view current interval timer settings, select **Interval timer shooting** between shots. While interval timer photography is in progress, the interval timer menu will show the starting time, the shooting interval, and the number of intervals and shots remaining. None of these items can be changed while interval timer photography is in progress.



Pictures can be played back and shooting and menu settings can be adjusted freely while interval timer photography is in progress. The monitor will turn off automatically about four seconds before each interval.



■ Pausing Interval Timer Photography

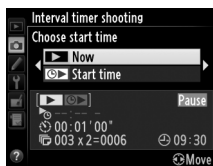
Interval timer photography can be paused by:

- Pressing the **OK** button between intervals
- Highlighting **Start > Pause** in the interval timer menu and pressing **OK**
- Turning the camera off and then on again (if desired, the memory card can be replaced while the camera is off)
- Selecting self-timer (☺) or **MUP** release mode

To resume shooting:

1 Choose a new starting time.

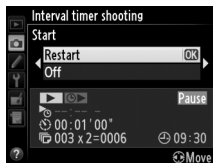
Choose a new starting time as described on page 157.



2 Resume shooting.

Highlight **Restart** and press **OK**.

Note that if interval timer photography was paused during shooting, any shots remaining in the current interval will be canceled.



■ ■ *Interrupting Interval Timer Photography*

Interval timer shooting will end automatically if the battery is exhausted. Interval timer photography can also be ended by:

- Selecting **Start > Off** in the interval timer menu
- Performing a two button reset (☞ 133)
- Resetting settings for the current shooting menu bank using the **Shooting menu bank** item in the shooting menu (☞ 236)
- Changing bracketing settings (☞ 136)

Normal shooting will resume when interval timer photography ends.

■ ■ *No Photograph*

The camera will skip the current interval if any of the following situations persist for eight seconds or more after the interval was due to start: the photograph or photographs for the previous interval have yet to be taken, the memory buffer is full, or the camera is unable to focus in **AF-S** (note that the camera focuses again before each shot). Shooting will resume with the next interval.



Non-CPU Lenses

Non-CPU lenses can be used in exposure modes **A** and **M**, with aperture set using the lens aperture ring. By specifying lens data (lens focal length and maximum aperture), the user can gain access to the following CPU lens functions.

If the focal length of the lens is known:

- Power zoom can be used with optional flash units (☞ 119)
- Lens focal length is listed (with an asterisk) in the playback photo info display

If the maximum aperture of the lens is known:

- The aperture value is displayed in the control panel and viewfinder
- Flash level is adjusted for changes in aperture if the flash unit supports AA (auto aperture) mode
- Aperture is listed (with an asterisk) in the playback photo info display

Specifying both the focal length and maximum aperture of the lens:

- Enables color matrix metering (note that it may be necessary to use center-weighted or spot metering to achieve accurate results with some lenses, including Reflex-NIKKOR lenses)
- Improves the precision of center-weighted and spot metering and i-TTL balanced fill-flash for digital SLR

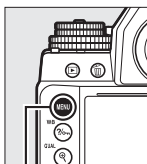


■■ Storing Non-CPU Lens Data

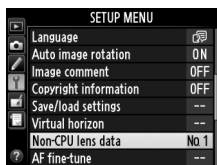
The camera can store data for up to nine non-CPU lenses. To enter or edit data for a non-CPU lens:

1 Select Non-CPU lens data.

Press the **MENU** button to display the menus. Highlight **Non-CPU lens data** in the setup menu and press ►.

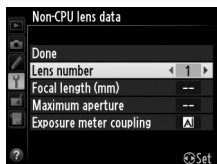


MENU button



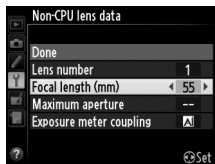
2 Choose a lens number.

Highlight **Lens number** and press ◀ or ▶ to choose a lens number between 1 and 9.



3 Enter the focal length and aperture.

Highlight **Focal length (mm)** or **Maximum aperture** and press ◀ or ▶ to edit the highlighted item. Focal length can be selected from values between 6 and 4000 mm, maximum aperture from values between f/1.2 and f/22.





Focal Length Not Listed

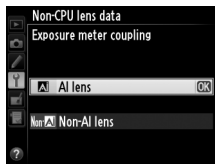
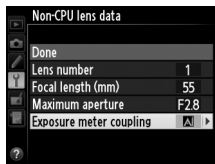
If the correct focal length is not listed, choose the closest value greater than the actual focal length of the lens.

Teleconverters and Zoom Lenses

The maximum aperture for teleconverters is the combined maximum aperture of the teleconverter and the lens. Note that lens data are not adjusted when non-CPU lenses are zoomed in or out. The data for different focal lengths can be entered as separate lens numbers, or the data for the lens can be edited to reflect the new values for lens focal length and maximum aperture each time zoom is adjusted.

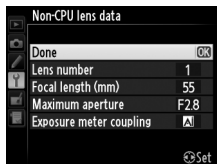
4 Choose a meter coupling method.

Highlight **Exposure meter coupling** and press ▶, then press ▲ or ▼ to highlight **AI lens** and press  to select (choose **Non-AI lens** only if the lens is not equipped with an AI mechanism;  167).



5 Select Done.

Highlight **Done** and press **OK**.
The specified focal length and aperture will be stored under the chosen lens number.



Recalling Non-CPU Lens Data

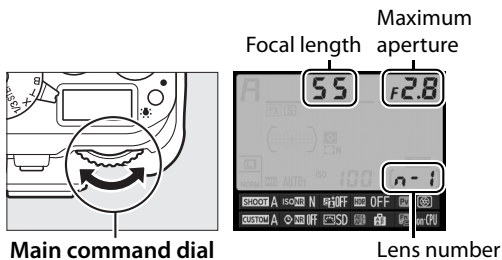
Lens data for selected non-CPU lenses can be recalled by lens number as described below.

1 Assign non-CPU lens number selection to a camera control.

Select **Choose non-CPU lens number** as the “+ command dials” option for Custom Setting f4 (**Assign Fn button**, [□ 263](#)), Custom Setting f5 (**Assign preview button**, [□ 266](#)), or f6 (**Assign AE-L/AF-L button**, [□ 267](#)).

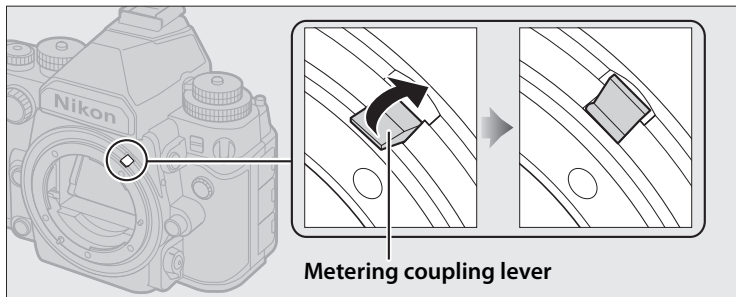
2 Use the selected control to choose the lens number.

Press the selected button and rotate the main command dial until the desired lens number appears in the information display.



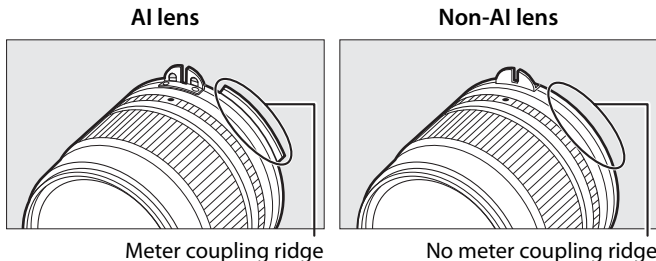
Non-AI Lenses

The camera can be used with non-AI lenses (i.e., lenses not equipped with AI mechanisms). Before attaching the lens, be sure to raise the metering coupling lever; failure to observe this precaution could result in damage to the camera or lens.



■ AI Versus Non-AI Lenses

"Non-CPU" lenses are divided into lenses with AI mechanisms ("AI lenses") and those without ("non-AI lenses").



Incompatible Lenses

Some non-AI lenses can not be attached even when the meter coupling lever is raised. See page 320 for more information.

AI Lenses

Lower the metering coupling lever before attaching AI lenses.

■ Taking Pictures with Non-AI Lenses


The lack of an AI mechanism means that camera controls can not be used to set aperture when a non-AI lens is attached. For optimal exposure, you must manually match the camera aperture setting to the lens.

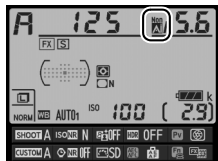
1 Attach the lens.

Attach a non-AI lens for which you have previously provided lens data (☞ 164).

2 Select the lens number (☞ 166).

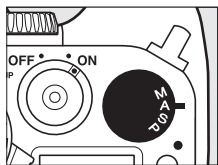
Confirm that **Non-AI lens** is selected for **Non-CPU lens data > Exposure meter coupling**.

"F" will flash in the control panel and  will appear in the information display.



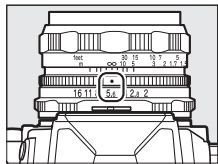
3 Select exposure mode A or M.

Rotate the exposure mode dial to **A** or **M**.



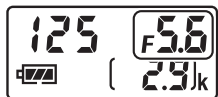
4 Adjust aperture.

Choose an aperture using the lens aperture ring.



5 Match the camera aperture setting to the lens.

While the exposure meters are on, rotate the sub-command dial to set the camera to the aperture selected in Step 4.



6 Take pictures.

Repeat Steps 4 and 5 as necessary to change the aperture during shooting.



Location Data

Optional GP-1 and GP-1A GPS units (📖 325) embed the following information in photographs taken while the unit is attached: longitude, latitude, altitude, and Coordinated Universal Time (UTC). These data are displayed in the photo information location data page (📖 188).

■ ■ *Attaching a GPS Unit*

Turn the camera off and connect the GPS unit to the accessory terminal (📖 325) using the cable supplied with the unit. See the GPS unit manual for more information.

■ ■ *Setup Menu Options*

The **Location data** item in the setup menu contains the options listed below.

- **Standby timer:** Choose whether the exposure meters turn off automatically when a GPS unit is attached.


Option	Description
Enable	Exposure meters turn off automatically if no operations are performed for the time selected for Custom Setting c2 (Standby timer , 📖 251; to allow the camera time to acquire location data, the delay is extended by up to one minute after the exposure meters are activated or the camera is turned on). This reduces the drain on the battery.
Disable	Exposure meters do not turn off while a GPS unit is connected.




- **Position:** This item is only available if a GPS unit is connected, when it displays the current latitude, longitude, altitude, and Coordinated Universal Time (UTC) as reported by the GPS unit.
- **Set clock from satellite:** Select **Yes** to synchronize the camera clock with the time reported by the GPS unit.

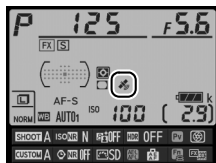
Coordinated Universal Time (UTC)

UTC data is provided by the GPS unit and is independent of the camera clock.

The Icon

Connection status is shown by the  icon:

-  (**static**): The camera has established communication with the GPS unit. Photo information for pictures taken while this icon is displayed include an additional page of location data (📖 194).
-  (**flashing**): The GPS unit is searching for a signal. Pictures taken while the icon is flashing do not include location data.
- **No icon**: No new location data have been received from the GPS unit for at least two seconds. Pictures taken when the  icon is not displayed do not include location data.



Live View Photography

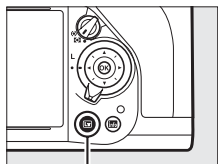
Follow the steps below to take photographs in live view.

Cover the Viewfinder

To prevent light entering via the viewfinder interfering with photographs or exposure, cover the viewfinder with the supplied DK-26 eyepiece cap before shooting (☞ 23).

1 Press the **[Lv]** button.

The mirror will be raised and the view through the lens will be displayed in the camera monitor. The subject will no longer be visible in the viewfinder.



[Lv] button

2 Position the focus point.

Position the focus point over your subject as described on page 175.

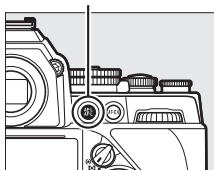
3 Focus.

Press the shutter-release button halfway to focus.



The focus point will flash green while the camera focuses. If the camera is able to focus, the focus point will be displayed in green; if the camera is unable to focus, the focus point will flash red (note that pictures can be taken even when the focus point flashes red; check focus in the monitor before shooting). Exposure can be locked by pressing the ^{AE-L}/_{AF-L} **AE-L/AF-L** button (☐ 77); focus locks while the shutter-release button is pressed halfway. In exposure mode **M**, exposure can be adjusted with the assistance of an exposure indicator (☐ 43).

^{AE-L}/_{AF-L} **AE-L/AF-L** button



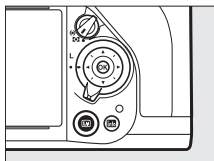
4 Take the picture.

Press the shutter-release button the rest of the way down to shoot. The monitor will turn off.



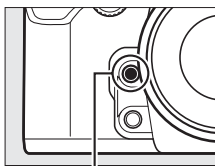
5 Exit live view mode.

Press the **Lv** button to exit live view mode.



Exposure Preview (Exposure Mode M Only)

In exposure mode **M**, pressing the **Pv** button lets you preview how the current shutter speed, aperture, and ISO sensitivity settings affect exposure.




Pv button

Ending Live View

Live view ends automatically if the lens is removed. Live view may also end automatically to prevent damage to the camera's internal circuits; exit live view when the camera is not in use. Note that the temperature of the camera's internal circuits may rise and noise (bright spots, randomly-spaced bright pixels, or fog) may be displayed in the following instances (the camera may also become noticeably warm, but this does not indicate a malfunction):

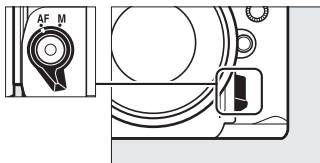
- The ambient temperature is high
- Live view has been used for extended periods
- The camera has been used in continuous release mode for extended periods

If live view does not start when you press the  button, wait for the internal circuits to cool and then try again.

Focusing in Live View

To focus using autofocus, rotate the focus-mode selector to **AF** and follow the steps below to choose autofocus and AF-area modes. For information on focusing manually, see page 183.

Focus-mode selector

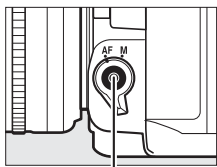


■ ■ Choosing a Focus Mode

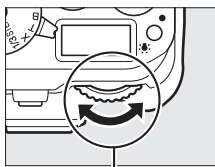
The following autofocus modes are available in live view:

Mode	Description
AF-S	Single-servo AF: For stationary subjects. Focus locks when shutter-release button is pressed halfway.
AF-F	Full-time servo AF: For moving subjects. Camera focuses continuously until shutter-release button is pressed. Focus locks when shutter-release button is pressed halfway.

To choose an autofocus mode, press the AF-mode button and rotate the main command dial until the desired mode is displayed in the monitor.



AF-mode button



Main command dial



Monitor











Using Autofocus in Live View

Use an AF-S lens. The desired results may not be achieved with other lenses or teleconverters. Note that in live view, autofocus is slower and the monitor may brighten or darken while the camera focuses. The focus point may sometimes be displayed in green when the camera is unable to focus. The camera may be unable to focus in the following situations:

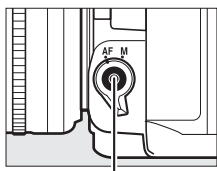
- The subject contains lines parallel to the long edge of the frame
- The subject lacks contrast
- The subject in the focus point contains areas of sharply contrasting brightness, or includes spot lighting or a neon sign or other light source that changes in brightness
- Flicker or banding appears under fluorescent, mercury-vapor, sodium-vapor, or similar lighting
- A cross (star) filter or other special filter is used
- The subject appears smaller than the focus point
- The subject is dominated by regular geometric patterns (e.g., blinds or a row of windows in a skyscraper)
- The subject is moving

■ ■ Choosing an AF-Area Mode

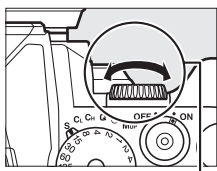
The following AF-area modes can be selected in live view:

Mode	Description
	Face-priority AF: Use for portraits. The camera automatically detects and focuses on portrait subjects; the selected subject is indicated by a double yellow border (if multiple faces, up to a maximum of 35, are detected, the camera will focus on the closest subject; to choose a different subject, use the multi selector). If the camera can no longer detect the subject (because, for example, the subject has turned to face away from the camera), the border will no longer be displayed.
	Wide-area AF: Use for hand-held shots of landscapes and other non-portrait subjects. Use the multi selector to move the focus point anywhere in the frame, or press  to position the focus point in the center of the frame.
	Normal-area AF: Use for pin-point focus on a selected spot in the frame. Use the multi selector to move the focus point anywhere in the frame, or press  to position the focus point in the center of the frame. A tripod is recommended.
	Subject-tracking AF: Position the focus point over your subject and press  . The focus point will track the selected subject as it moves through the frame. To end tracking, press  again. Note that the camera may be unable to track subjects if they move quickly, leave the frame or are obscured by other objects, change visibly in size, color, or brightness, or are too small, too large, too bright, too dark, or similar in color or brightness to the background.

To choose an AF-area mode, press the AF-mode button and rotate the sub-command dial until the desired mode is displayed in the monitor.



AF-mode button



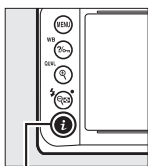
Sub-command dial



Monitor

Using the **i** Button

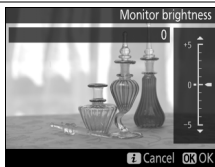
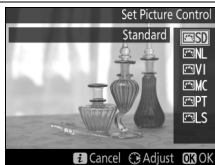
The options listed below can be accessed by pressing the **i** button during live view photography. Highlight items using the multi selector and press **▶** to view options for the highlighted item. After choosing the desired setting, press **OK** to exit.



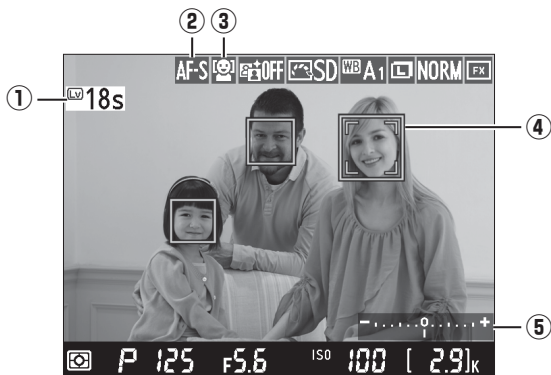
i button



Option	Description
Image quality	Choose image quality (☞ 55).
Image size	Choose image size (☞ 58).
Set Picture Control	Choose a Picture Control (☞ 100).
Active D-Lighting	Adjust Active D-Lighting to preserve details in highlights and shadows (☞ 110).
Monitor brightness	Press ▲ or ▼ to adjust monitor brightness for live view. Changes to monitor brightness have no effect on photographs recorded with the camera.



The Live View Display: Live View Photography



Item	Description	
① Time remaining	The amount of time remaining before live view ends automatically. Displayed if shooting will end in 30 s or less.	184
② Autofocus mode	The current autofocus mode.	175
③ AF-area mode	The current AF-area mode.	177
④ Focus point	The current focus point. The display varies with the option selected for AF-area mode (177).	172
⑤ Exposure indicator	Indicates whether the photograph would be under- or overexposed at current settings (exposure mode M only).	43

✓ **The Live View Display**

Although they will not appear in the final picture, jagged edges, color fringing, moire, and bright spots may appear in the monitor, while bright bands may appear in some areas with flashing signs and other intermittent light sources or if the subject is briefly illuminated by a strobe or other bright, momentary light source. In addition, distortion may occur if the camera is panned horizontally or an object moves at high speed through the frame. Flicker and banding visible in the monitor under fluorescent, mercury vapor, or sodium lamps can be reduced using **Flicker reduction** (📖 276), although they may still be visible in the final photograph at some shutter speeds. When shooting in live view mode, avoid pointing the camera at the sun or other strong light sources. Failure to observe this precaution could result in damage to the camera's internal circuitry.

✍ **Exposure**

Depending on the scene, exposure may differ from that which would be obtained when live view is not used. Metering in live view is adjusted to suit the live view display, producing photographs with exposure close to what is seen in the monitor.

The Information Display: Live View Photography

To hide or display indicators in the monitor during live view photography, press the **info** button.



Information on



Information off



16-cell framing grid



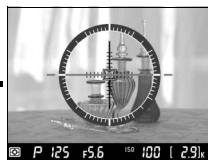
9-cell framing grid



1 : 1 aspect ratio



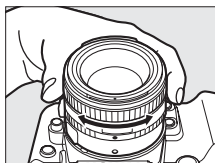
16 : 9 aspect ratio



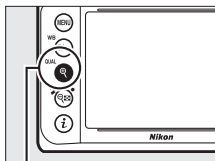
Virtual horizon
(282)

Manual Focus

To focus in manual focus mode (📖 68), rotate the lens focus ring until the subject is in focus.



To magnify the view in the monitor up to about 15 × for precise focus, press the **QUAL** button. While the view through the lens is zoomed in, a navigation window will appear in a gray frame at the bottom right corner of the display. Use the multi-selector to scroll to areas of the frame not visible in the monitor (available only if wide- or normal-area AF is selected for AF-area mode), or press **QUAL** (🔍) to zoom out.



QUAL button



Navigation window



✔ The Count Down Display

A count down will be displayed 30 s before live view ends automatically (☞ 180; the timer turns red if live view is about to end to protect the internal circuits or, if an option other than **No limit** is selected for Custom Setting c4—**Monitor off delay** > **Live view**; ☞ 253—5 s before the monitor is due to turn off automatically). Depending on shooting conditions, the timer may appear immediately when live view is selected. Note that although the count down does not appear during playback, live view will still end automatically when the timer expires.

✍ HDMI

If the camera is attached to an HDMI video device during live view photography, the camera monitor will remain on and the video device will display the view through the lens as shown at right. If the device supports HDMI-CEC, select **Off** for the **HDMI** >




Device control option in the setup menu (☞ 223) before shooting in live view.

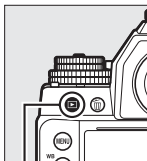
✍ See Also

For information on using the **OK** button to select the center focus point or toggle focus zoom, see Custom Setting f2 (**OK button**; ☞ 261). For information on reducing flicker or measuring a value for spot white balance during live view, see pages 276 and 93.

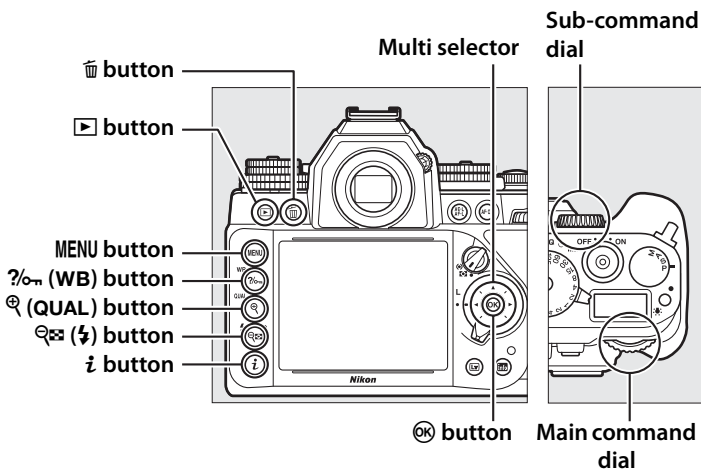
More on Playback











Full-Frame Playback

To play photographs back, press the  button. The most recent photograph will be displayed in the monitor.



 button



To	Use	Description
View additional photographs		Press ▶ to view photographs in order recorded, ◀ to view photographs in reverse order.
View photo information		Press ▲ or ▼ to view information about current photograph (📖 188).
View thumbnails		See page 196 for more information.
Zoom in on photograph		See page 199 for more information.
Delete images		Confirmation dialog will be displayed. Press  again to delete photo (📖 203).
Change protect status		To protect image, or to remove protection from protected image, press  (📖 201).
Return to shooting mode		Monitor will turn off. Photographs can be taken immediately.
Retouch photo		Create retouched copy of current photograph (📖 287).



Rotate Tall

To display “tall” (portrait-orientation) photographs in tall orientation, select **On** for the **Rotate tall** option in the playback menu (☐ 233).



Image Review

When **On** is selected for **Image review** in the playback menu (☐ 232), photographs are automatically displayed in the monitor for about 4 s after shooting (because the camera is already in the correct orientation, images are not rotated automatically during image review). In continuous release mode, display begins when shooting ends, with the first photograph in the current series displayed.

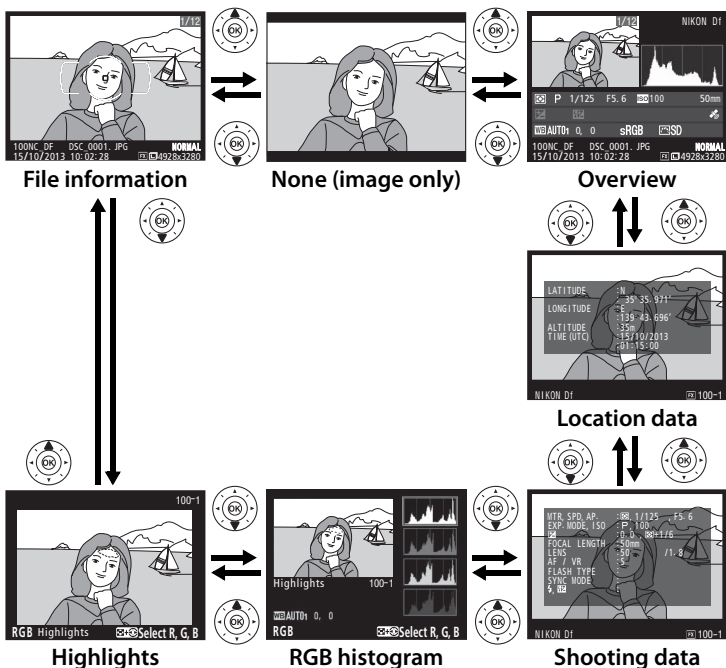
See Also

For information on choosing how long the monitor will remain on when no operations are performed, see Custom Setting c4 (**Monitor off delay**, ☐ 253).

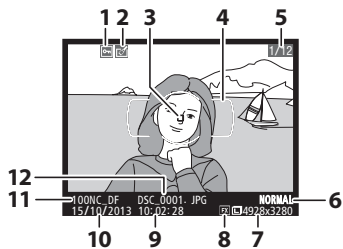


Photo Information

Photo information is superimposed on images displayed in full-frame playback. Press ▲ or ▼ to cycle through photo information as shown below. Note that “image only”, shooting data, RGB histograms, highlights, and overview data are only displayed if corresponding option is selected for **Playback display options** (p. 232). Location data are only displayed if an optional GP-1 or GP-1A GPS unit was used when the photo was taken.



■ ■ File Information

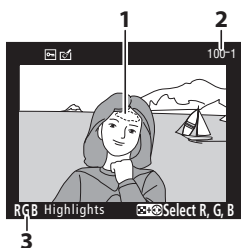


1	Protect status.....	201
2	Retouch indicator	287
3	Focus point ^{1,2}	64
4	AF area brackets ¹	28
5	Frame number/total number of frames	
6	Image quality.....	55
7	Image size.....	58
8	Image area ³	51
9	Time of recording	27, 276
10	Date of recording.....	27, 276
11	Folder name	237
12	File name	239

- 1 Displayed only if **Focus point** is selected for **Playback display options** (☐ 232).
- 2 If photograph was taken using **AF-S**, display shows point where focus first locked. If photograph was taken using **AF-C**, focus point is only displayed if option other than auto-area AF was selected for AF-area mode and camera was able to focus.
- 3 Displayed in yellow if picture is in DX format (☐ 51).

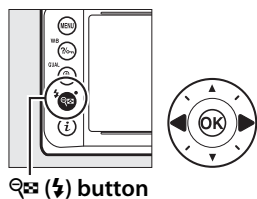


■ Highlights



- 1 Image highlights¹
- 2 Folder number—frame number².....237
- 3 Current channel¹

1 Flashing areas indicate highlights (areas that may be overexposed) for the current channel. Hold and press ◀ or ▶ to cycle through channels as follows:



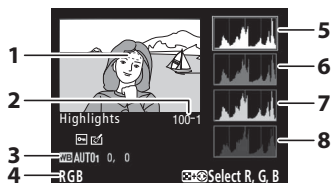
button



2 Displayed in yellow if picture is in DX format (📖 51).

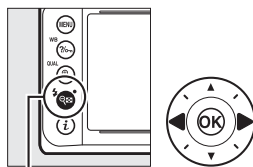


■ ■ RGB Histogram

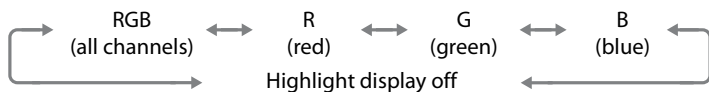


- | | |
|---|--|
| 1 | Image highlights ¹ |
| 2 | Folder number—frame number ² 237 |
| 3 | White balance 81
Color temperature 88
White balance fine-tuning 84
Preset manual 90 |
| 4 | Current channel ¹ |
| 5 | Histogram (RGB channel). In all histograms, horizontal axis gives pixel brightness, vertical axis number of pixels. |
| 6 | Histogram (red channel) |
| 7 | Histogram (green channel) |
| 8 | Histogram (blue channel) |

- 1 Flashing areas indicate highlights (areas that may be overexposed) for the current channel. Hold () button and press ◀ or ▶ to cycle through channels as follows:



() button



- 2 Displayed in yellow if picture is in DX format (51).



Playback Zoom

To zoom in on the photograph when the histogram is displayed, press **Q** (QUAL). Use the **Q** (QUAL) and **Q** (QUAL) and **Q** (QUAL) buttons to zoom in and out and scroll the image with the multi selector. The histogram will be updated to show only the data for the portion of the image visible in the monitor.



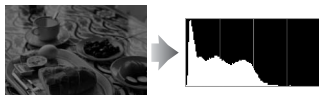
Histograms

Camera histograms are intended as a guide only and may differ from those displayed in imaging applications. Some sample histograms are shown below:

If the image contains objects with a wide range of brightnesses, the distribution of tones will be relatively even.



If the image is dark, tone distribution will be shifted to the left.



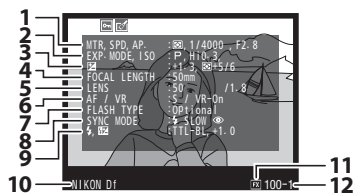
If the image is bright, tone distribution will be shifted to the right.



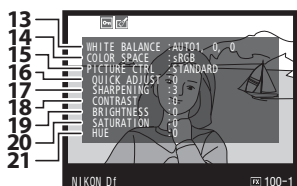
Increasing exposure compensation shifts the distribution of tones to the right, while decreasing exposure compensation shifts the distribution to the left. Histograms can provide a rough idea of overall exposure when bright ambient lighting makes it difficult to see photographs in the monitor.



Shooting Data

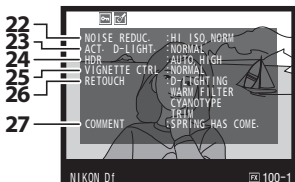


1	Metering	75
	Shutter speed	39, 42
	Aperture.....	41, 42
2	Exposure mode	36
	ISO sensitivity ¹	70
3	Exposure compensation	79
	Optimal exposure tuning ²	250
4	Focal length	163, 322
5	Lens data.....	163
6	Focus mode.....	59, 68
	Lens VR (vibration reduction) ³	
7	Flash type ⁴	116
	Commander mode ⁴	
8	Flash mode ⁴	125
9	Flash control ⁴	118, 121, 258
	Flash compensation ⁴	128
10	Camera name	
11	Image area ⁵	51
12	Folder number—frame number ⁵	237

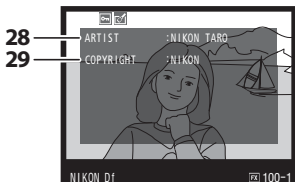


13	White balance	81
	Color temperature	88
	White balance fine-tuning	84
	Preset manual.....	90
14	Color space	240
15	Picture Control.....	100
16	Quick adjust ⁶	103
	Original Picture Control ⁷	108
17	Sharpening.....	103
18	Contrast.....	103
19	Brightness.....	103
20	Saturation ⁸	103
	Filter effects ⁹	103
21	Hue ⁸	103
	Toning ⁹	103, 105





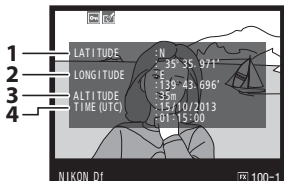
22	High ISO noise reduction	242
	Long exposure noise reduction ...	242
23	Active D-Lighting	110
24	HDR exposure differential	112
	HDR smoothing	112
25	Vignette control	241
26	Retouch history	287
27	Image comment	278



28	Name of photographer ¹⁰	279
29	Copyright holder ¹⁰	279

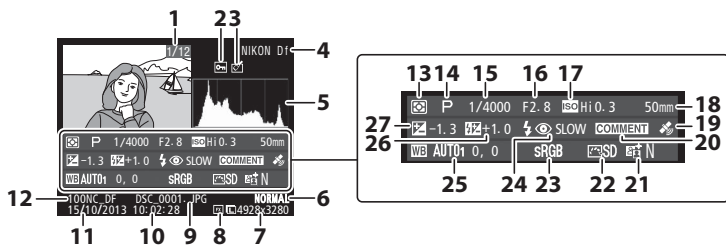
- 1 Displayed in red if photo was taken with auto ISO sensitivity control on.
- 2 Displayed if Custom Setting b2 (**Fine-tune optimal exposure**, 250) has been set to a value other than zero for any metering method.
- 3 Displayed only if VR lens is attached.
- 4 Displayed only if optional flash unit (116) is used.
- 5 Displayed in yellow if picture is in DX format (51).
- 6 **Standard, Vivid, Portrait**, and **Landscape** Picture Controls only.
- 7 **Neutral, Monochrome**, and custom Picture Controls.
- 8 Not displayed with monochrome Picture Controls.
- 9 Monochrome Picture Controls only.
- 10 The fourth page of the shooting data is only displayed if copyright information was recorded with the photograph as described on page 279.

Location Data



1	Latitude
2	Longitude
3	Altitude
4	Coordinated Universal Time (UTC)

Overview Data



1	Frame number/total number of images	15	Shutter speed	39, 42	
2	Protect status.....	201	16	Aperture.....	41, 42
3	Retouch indicator	287	17	ISO sensitivity ²	70
4	Camera name		18	Focal length	163, 322
5	Histogram showing the distribution of tones in the image (☐ 192).		19	Location data indicator	170
6	Image quality.....	55	20	Image comment indicator.....	278
7	Image size.....	58	21	Active D-Lighting.....	110
8	Image area ¹	51	22	Picture Control.....	100
9	File name	239	23	Color space	240
10	Time of recording	27, 276	24	Flash mode ³	125
11	Date of recording.....	27, 276	25	White balance.....	81
12	Folder name.....	237		Color temperature	88
13	Metering	75		White balance fine-tuning	84
14	Exposure mode	36		Preset manual.....	90
			26	Flash compensation ³	128
				Commander mode ³	
			27	Exposure compensation	79


1 DX format displayed in yellow (☐ 51).

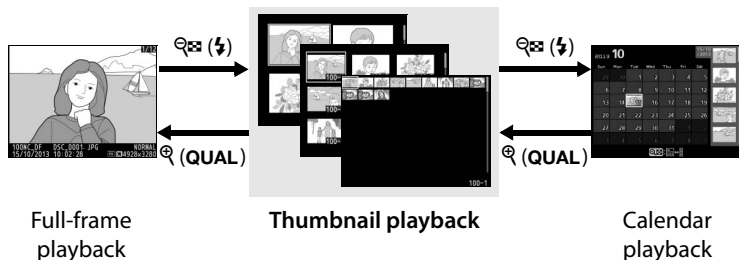
2 Displayed in red if photo was taken with auto ISO sensitivity control on.
















3 Displayed only if photo was taken with optional flash unit (☐ 116).




Thumbnail Playback

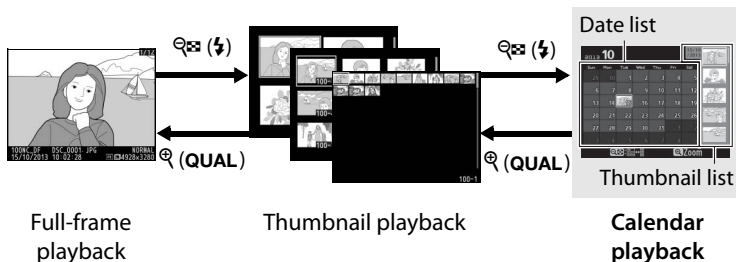
To display images in “contact sheets” of four, nine, or 72 images, press the  button.











To	Use	Description
Display more images		Press  to increase the number of images displayed.
Display fewer images		Press  to reduce the number of images displayed. When four images are displayed, press to view highlighted image full frame.
Highlight images		Use multi selector to highlight images for full-frame playback, playback zoom ( 199), deletion ( 203), or protection ( 201).
View highlighted image		Press  to display the highlighted image full frame.
Delete highlighted image		See page 203 for more information.
Change protect status of highlighted image	 (WB)	See page 201 for more information.
Return to shooting mode		Monitor will turn off. Photographs can be taken immediately.
Retouch photo		Create retouched copy of current photograph ( 287).



Calendar Playback

To view images taken on a selected date, press the  button when 72 images are displayed.



The operations can be performed depend on whether the cursor is in the date list or the thumbnail list:





To	Use	Description
Toggle between date list and thumbnail list	 /OK	Press  or OK button in date list to place cursor in thumbnail list. Press  again to return to date list.
Exit to thumbnail playback/Zoom in on highlighted photo	 (QUAL)	<ul style="list-style-type: none"> Date list: Exit to 72-frame playback. Thumbnail list: Press and hold  (QUAL) button to zoom in on highlighted picture.
Highlight dates/ Highlight images		<ul style="list-style-type: none"> Date list: Highlight date. Thumbnail list: Highlight picture.
Toggle full frame playback	OK	Thumbnail list: View highlighted picture.
Delete highlighted photo(s)		<ul style="list-style-type: none"> Date list: Delete all pictures taken on selected date. Thumbnail list: Delete highlighted picture (203).
Change protect status of highlighted photo	 (WB)	See page 201 for more information.

To	Use	Description
Return to shooting mode		Monitor will turn off. Photographs can be taken immediately.
Retouch photo		Thumbnail list: Create retouched copy of photo highlighted in thumbnail list (📖 287).







Taking a Closer Look: Playback Zoom

Press the **Q (QUAL)** button to zoom in on the image displayed in full-frame playback or on the image currently highlighted in thumbnail playback. The following operations can be performed while zoom is in effect:

To	Use	Description
Zoom in or out	Q (QUAL) / Q (Z)	Press Q (QUAL) to zoom in to maximum of approximately 30 × (large images in 36 × 24/3 : 2 format), 23 × (medium images) or 15 × (small images). Press Q (Z) to zoom out. While photo is zoomed in, use multi selector to view areas of image not visible in monitor. Keep multi selector pressed to scroll rapidly to other areas of frame. Navigation window is displayed when zoom ratio is altered; area currently visible in monitor is indicated by yellow border. 
View other areas of image		While photo is zoomed in, use multi selector to view areas of image not visible in monitor. Keep multi selector pressed to scroll rapidly to other areas of frame. Navigation window is displayed when zoom ratio is altered; area currently visible in monitor is indicated by yellow border.
Select faces		Faces (up to 35) detected during zoom are indicated by white borders in navigation window. Rotate sub-command dial to view other faces. 



To	Use	Description
View other images		Rotate main command dial to view same location in other photos at current zoom ratio.
Change protect status		See page 201 for more information.
Return to shooting mode		Monitor will turn off. Photographs can be taken immediately.
Retouch photo		Create retouched copy of current photograph (p. 287).



Protecting Photographs from Deletion

In full-frame, zoom, thumbnail, and calendar playback, the **WB** button can be used to protect photographs from accidental deletion. Protected files can not be deleted using the **W** button or the **Delete** option in the playback menu. Note that protected images *will* be deleted when the memory card is formatted (□ 22, 272).

To protect a photograph:

1 Select an image.

Display the image in full-frame playback or playback zoom or highlight it in the thumbnail list in thumbnail or calendar playback.



Full-frame playback




Thumbnail playback

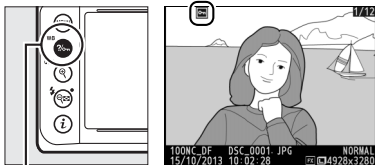


Calendar playback



2 Press the ?/WB button.


The photograph will be marked with a  icon. To remove protection from the photograph so that it can be deleted, display the photograph or highlight it in the thumbnail list and then press the ?/WB button.




?/WB button



Removing Protection from All Images

To remove protection from all images in the folder or folders currently selected in the **Playback folder** menu, press the ?/WB and  buttons together for about two seconds during playback.

Deleting Photographs

To delete the photograph displayed in full-frame playback or highlighted in the thumbnail list, press the  button. To delete multiple selected photographs, all photographs taken on a selected date, or all photographs in the current playback folder, use the **Delete** option in the playback menu. Once deleted, photographs can not be recovered. Note that pictures that are protected or hidden can not be deleted.

Full-Frame, Thumbnail, and Calendar Playback

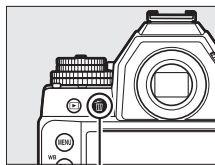
Press the  button to delete the current photograph.


1 Select an image.

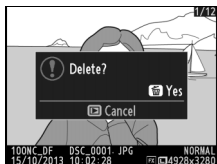
Display the image or highlight it in the thumbnail list in thumbnail or calendar playback.

2 Press the button.

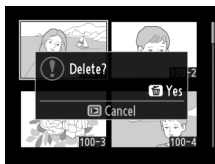
A confirmation dialog will be displayed.



 button



Full-frame playback





Thumbnail playback

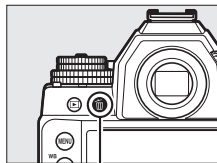


Calendar playback
(thumbnail list)




3 Press the button again.

To delete the photograph, press the  button. To exit without deleting the photograph, press the  button.



 button

Calendar Playback



During calendar playback, you can delete all photographs taken on a selected date by highlighting the date in the date list and pressing the  button (📖 197).

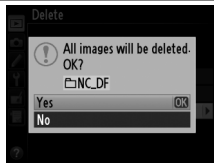
See Also

The **After delete** option in the playback menu determines whether the next image or the previous image is displayed after an image is deleted (📖 233).

The Playback Menu

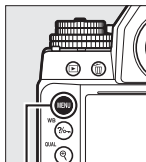
The **Delete** option in the playback menu contains the following options. Note that depending on the number of images, some time may be required for deletion.

Option	Description
 Selected	Delete selected pictures.
 Select date	Delete all pictures taken on a selected date (📅 206).
ALL All	Delete all pictures in the folder currently selected for playback (📅 230).

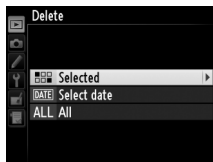


■ Selected: Deleting Selected Photographs

- 1 Choose Selected for the Delete option in the playback menu.**
Press the **MENU** button and select **Delete** in the playback menu. Highlight **Selected** and press **▶**.






MENU button

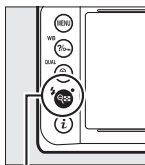



- 2 Highlight a picture.**
Use the multi selector to highlight a picture. To view the highlighted picture full screen, press and hold the **QUAL** button.



3 Select the highlighted picture.


Press the  button to select the highlighted picture. Selected pictures are marked by a  icon. Repeat steps 2 and 3 to select additional pictures; to deselect a picture, highlight it and press .



 button




4 Press to complete the operation.

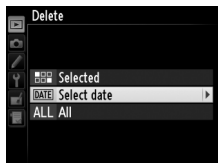
A confirmation dialog will be displayed; highlight **Yes** and press .



■ Select Date: Deleting Photographs Taken on a Selected Date

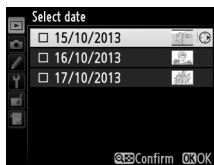
1 Choose **Select date**.



In the delete menu, highlight **Select date** and press .

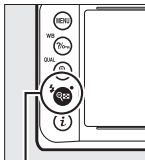



2 Highlight a date.

Press ▲ or ▼ to highlight a date.



To view the pictures taken on the highlighted date, press  (QUAL). Use the multi-selector to scroll through the pictures, or press and hold  (QUAL) to view the current picture full screen.




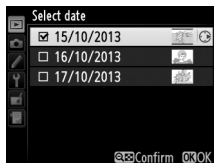
 (QUAL) button




Press  (QUAL) to return to the date list.

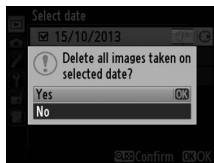
3 Select the highlighted date.

Press ► to select all pictures taken on the highlighted date. Selected dates are marked with a  icon. Repeat steps 2 and 3 to select additional dates; to deselect a date, highlight it and press ►.



4 Press to complete the operation.

A confirmation dialog will be displayed; highlight **Yes** and press .



Connections

Installing ViewNX 2

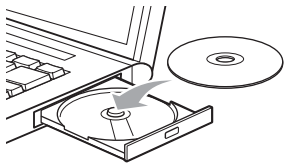
Install the supplied software to display and edit photographs and movies that have been copied to your computer. Before installing ViewNX 2, confirm that your computer meets the



system requirements on page 210. Be sure to use the latest version of ViewNX 2, which is available for download from the websites listed on page xvii, as earlier versions that do not support the Df may fail to transfer NEF (RAW) images correctly.

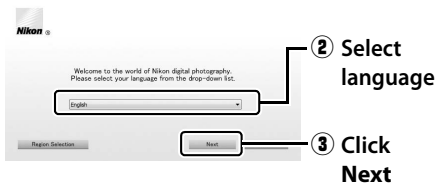
1 Launch the installer.

Start the computer, insert the ViewNX 2 installer CD, and launch the installer.



2 Select a language. ① Select region (if required)

If the desired language is not available, click **Region Selection** to choose a different region and then choose the desired language (region selection is not available in the European release).



3 Start the installer.

Click **Install** and follow the on-screen instructions.

Installation Guide
For help installing ViewNX 2, click **Installation Guide** in Step 3.



4 Exit the installer.

Windows



Click Yes

Mac OS



Click OK

5 Remove the installer CD from the CD-ROM drive.

Windows

To visit the Nikon website after installing ViewNX 2, select **All Programs > Link to Nikon** from the Windows start menu (Internet connection required).

System Requirements

	Windows	Mac OS
CPU	<ul style="list-style-type: none">• Photos: Intel Celeron, Pentium 4, or Core series, 1.6 GHz or better• Movies (playback): 3.0 GHz or better Pentium D; Intel Core i5 or better recommended when viewing movies with a frame size of 1280 × 720 or more at a frame rate of 30 fps or above or movies with a frame size of 1920 × 1080 or more• Movies (editing): Intel Core i5 or better	<ul style="list-style-type: none">• Photos: Intel Core or Xeon series• Movies (playback): Core Duo 2 GHz or better; Intel Core i5 or better recommended when viewing movies with a frame size of 1280 × 720 or more at a frame rate of 30 fps or above or movies with a frame size of 1920 × 1080 or more• Movies (editing): Intel Core i5 or better
OS	Pre-installed versions of Windows 8, Windows 7, Windows Vista, and Windows XP; note that 64-bit versions of Windows XP are not supported	OS X 10.8 or 10.7, Mac OS X 10.6
Memory (RAM)	<ul style="list-style-type: none">• 32-bit Windows 8, Windows 7, or Windows Vista: 1 GB or more (2 GB or more recommended)• 64-bit Windows 8, Windows 7, or Windows Vista: 2 GB or more (4 GB or more recommended)• Windows XP: 512 MB or more (2 GB or more recommended)	<ul style="list-style-type: none">• OS X 10.8, 10.7: 2 GB or more (4 GB or more recommended)• Mac OS X 10.6: 1 GB or more (4 GB or more recommended)
Hard disk space	A minimum of 1 GB available on the startup disk (3 GB or more recommended)	
Graphics	Resolution: 1024 × 768 pixels (XGA) or more (1280 × 1024 pixels or more recommended) Color: 24-bit color (True Color) or more	Resolution: 1024 × 768 pixels (XGA) or more (1280 × 1024 pixels or more recommended) Color: 24-bit color (millions of colors) or more

See the websites listed on page xvii for the latest information on supported operating systems.

Using ViewNX 2

Copy Pictures to the Computer

Before proceeding, be sure you have installed the software on the supplied ViewNX 2 CD (☞ 208).

1 Choose how pictures will be copied to the computer.

Choose one of the following methods:

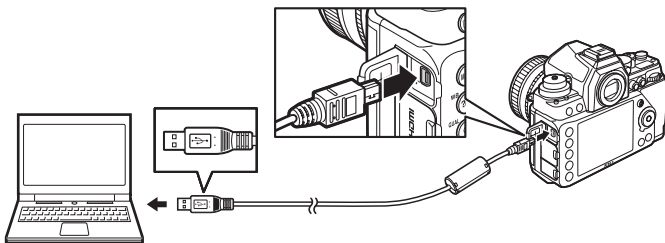
- **Direct USB connection:** Turn the camera off and ensure that the memory card is inserted in the camera. Connect the camera to the computer using the supplied USB cable and then turn the camera on.

Use a Reliable Power Source

To ensure that data transfer is not interrupted, be sure the camera battery is fully charged. If in doubt, charge the battery before use or use an AC adapter and power connector (available separately).

USB Hubs

Connect the camera directly to the computer; do not connect the cable via a USB hub or keyboard.



- **SD card slot:** If your computer is equipped with an SD card slot, the card can be inserted directly in the slot.
- **SD card reader:** Connect a card reader (available separately from third-party suppliers) to the computer and insert the memory card.



2 Start Nikon Transfer 2 component of ViewNX 2.

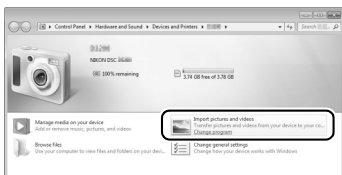
If a message is displayed prompting you to choose a program, select Nikon Transfer 2.

Windows 7

If the following dialog is displayed, select Nikon Transfer 2 as described below.

1 Under **Import pictures and videos**, click **Change program**. A program selection dialog will be displayed; select **Import file using Nikon Transfer 2** and click **OK**.

2 Double-click **Import file**.



3 Click Start Transfer.

At default settings, all the pictures on the memory card will be copied to the computer.



Start Transfer

4 Terminate the connection.

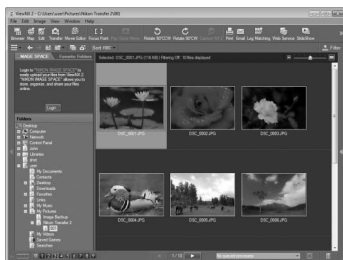
If the camera is connected to the computer, turn the camera off and disconnect the USB cable. If you are using a card reader or card slot, choose the appropriate option in the computer operating system to eject the removable disk corresponding to the memory card and then remove the card from the card reader or card slot.

View Pictures

Pictures are displayed in ViewNX 2 when transfer is complete.

Starting ViewNX 2 Manually

- Windows: Double-click the ViewNX 2 shortcut on the desktop.
- Mac OS: Click the ViewNX 2 icon in the Dock.



Retouching Photographs

To crop pictures and perform such tasks as adjusting sharpness and tone levels, click the **Edit** button in the ViewNX 2 toolbar.



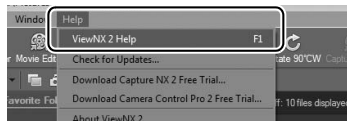
Printing Pictures

Click the **Print** button in the ViewNX 2 toolbar. A dialog will be displayed, allowing you to print pictures on a printer connected to the computer.



For More Information

Consult online help for more information on using ViewNX 2.



Connecting Cables

Be sure the camera is off when connecting or disconnecting interface cables. Do not use force or attempt to insert the connectors at an angle. Close the connector cover when the connector is not in use.

During Transfer

Do not turn the camera off or disconnect the USB cable while transfer is in progress.



Printing Photographs

Selected JPEG images can be printed on a PictBridge printer (□ 362) connected directly to the camera.

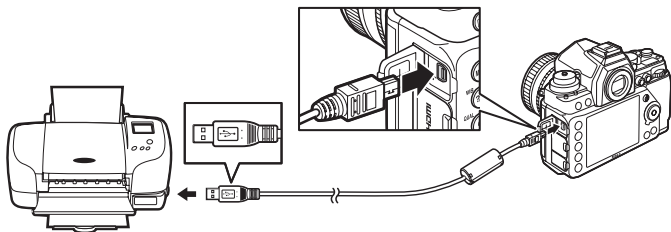
Connecting the Printer

Connect the camera using the supplied USB cable.

1 Turn the camera off.

2 Connect the USB cable.

Turn the printer on and connect the USB cable as shown. Do not use force or attempt to insert the connectors at an angle.



USB Hubs

Connect the camera directly to the printer; do not connect the cable via a USB hub.

3 Turn the camera on.

A welcome screen will be displayed in the monitor, followed by a PictBridge playback display.



Printing Via Direct USB Connection

Be sure the battery is fully charged or use an optional AC adapter and power connector. When taking photographs to be printed via direct USB connection, set **Color space** to **sRGB** (□ 240).

Selecting Photographs for Printing

Images created at image quality settings of NEF (RAW) or TIFF (RGB) (□ 55) can not be selected for printing. JPEG copies of NEF (RAW) images can be created using the **NEF (RAW) processing** option in the retouch menu (□ 300).



See Also



See page 351 for information on what to do if an error occurs during printing.

Printing Pictures One at a Time

1 Select a picture.

Press ◀ or ▶ to view additional pictures.


Press the  (**QUAL**) button to zoom in on the current frame (□ 199; press  to exit zoom).

To view six pictures at a time, press the  () button.

Use the multi selector to highlight pictures, or press  (**QUAL**) to display the highlighted picture full frame.



2 Display printing options.

Press  to display PictBridge printing options.



3 Adjust printing options.

Press ▲ or ▼ to highlight an option and press ► to select.

Option	Description
Page size	Highlight a page size (only sizes supported by the current printer are listed) and press OK to select and exit to the previous menu (to print at the default page size for the current printer, select Printer default).
No. of copies	Press ▲ or ▼ to choose number of copies (maximum 99), then press OK to select and return to the previous menu.
Border	This option is available only if supported by the printer. Highlight Printer default (use current printer settings), Print with border (print photo with white border), or No border and press OK to select and exit to the previous menu.
Time stamp	Highlight Printer default (use current printer settings), Print time stamp (print times and dates of recording on photos), or No time stamp and press OK to select and exit to the previous menu.
Cropping	This option is available only if supported by the printer. To exit without cropping, highlight No cropping and press OK . To crop the current picture, highlight Crop and press ►. A crop selection dialog will be displayed; press QUAL to increase the size of the crop, QUAL (↓) to decrease. Position the crop using the multi selector and press OK . Note that print quality may drop if small crops are printed at large sizes.

4 Start printing.

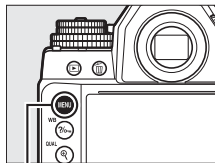
Select **Start printing** and press **OK** to start printing. To cancel before all copies have been printed, press **OK**.



Printing Multiple Pictures

1 Display the PictBridge menu.

Press the **MENU** button in the PictBridge playback display (see Step 3 on page 214).



MENU button

2 Choose an option.

Highlight one of the following options and press ►.



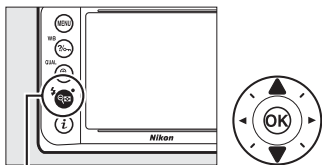
- **Print select:** Select pictures for printing.
- **Select date:** Print one copy of all the pictures taken on a selected date.
- **Print (DPOF):** Print an existing print order created with the **DPOF print order** option in the playback menu (📖 219). The current print order will be displayed in Step 3.
- **Index print:** To create an index print of all JPEG pictures (📖 55) on the memory card, proceed to Step 4. Note that if the memory card contains more than 256 pictures, only the first 256 images will be printed.



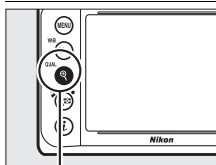
3 Select pictures or choose a date.

If you chose **Print select** or **Print (DPOF)** in Step 2, use the multi selector to scroll through the pictures on the memory card. To display the current picture full screen, press and hold the **QUAL** button. To select the current picture for printing, hold the **QUAL** (⚡) button and press **▲**. The picture will be marked with a **🖨** icon and the number of prints will be set to 1. Keeping the **QUAL** (⚡) button pressed, press **▲** or **▼** to specify the number of prints (up to 99; to deselect the picture, press **▼** when the number of prints is 1). Continue until all the desired pictures have been selected.

If you chose **Select date** in Step 2, press **▲** or **▼** to highlight a date and press **▶** to toggle the highlighted date on or off. To view the pictures taken on the selected date, press **QUAL** (⚡). Use the multi selector to scroll through the pictures, or press and hold **QUAL** to view the current picture full screen. Press **QUAL** (⚡) again to return to the date selection dialog.



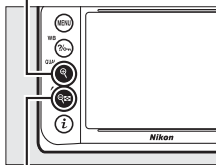
QUAL (⚡) + **▲** **▼**: Choose number of copies



QUAL (QUAL) button: View photo full screen



QUAL (QUAL) button: View highlighted photo full screen



QUAL (⚡) button: View photos for selected date



4 Display printing options.

Press **OK** to display PictBridge printing options.



5 Adjust printing options.

Choose page size, border, and time stamp options as described on page 216 (a warning will be displayed if the selected page size is too small for an index print).

6 Start printing.

Select **Start printing** and press **OK** to start printing. To cancel before all copies have been printed, press **OK**.

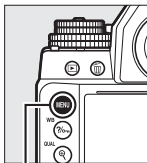


Creating a DPOF Print Order: Print Set

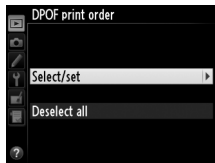
The **DPOF print order** option in the playback menu is used to create digital “print orders” for PictBridge-compatible printers and devices that support DPOF.

1 Choose **Select/set** for the DPOF print order item in the playback menu.

Press the **MENU** button and select **DPOF print order** in the playback menu.



MENU button

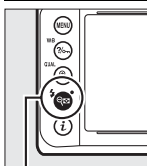
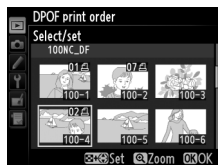


Highlight **Select/set** and press **▶** (to remove all photographs from the print order, select **Deselect all**).

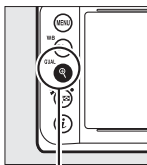


2 Select pictures.

Use the multi selector to scroll through the pictures on the memory card. To display the current picture in full screen, press and hold the **Q** (**QUAL**) button. To select the current picture for printing, hold the **Q** (**QUAL**) button and press **▲**. The picture will be marked with a **1** icon and the number of prints will be set to 1. Keeping the **Q** (**QUAL**) button pressed, press **▲** or **▼** to specify the number of prints (up to 99); to deselect the picture, press **▼** when the number of prints is 1). Continue until all the desired pictures have been selected.



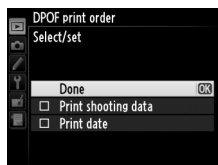
Q (**QUAL**) + **▲** **▼**: Choose number of copies



Q (**QUAL**) button: View photo full screen

3 Display imprint options.

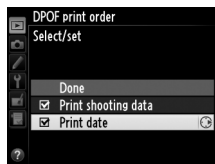
Press **OK** to display data imprint options.



4 Select imprint options.

Highlight the following options and press **▶** to toggle the highlighted option on or off (to complete the print order without including this information, proceed to Step 5).

- **Print shooting data:** Print shutter speed and aperture on all pictures in print order.
- **Print date:** Print date of recording on all pictures in print order.



5 Complete the print order.

Highlight **Done** and press **OK** to complete the print order.



✔ DPOF Print Order

To print the current print order when the camera is connected to a PictBridge printer, select **Print (DPOF)** in the PictBridge menu and follow the steps in "Printing Multiple Pictures" to modify and print the current order (☞ 217). DPOF print date and shooting data options are not supported when printing via direct USB connection; to print the date of recording on photographs in the current print order, use the PictBridge **Time stamp** option.

The **DPOF print order** option can not be used if there is not enough space on the memory card to store the print order.

NEF (RAW) photographs (☞ 55) can not be selected using this option. JPEG copies of NEF (RAW) images can be created using the **NEF (RAW) processing** option in the retouch menu (☞ 300).

Print orders may not print correctly if images are deleted using a computer or other device after the print order is created.



Viewing Photographs on TV

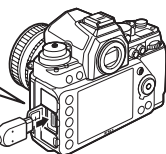
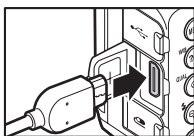
A type C mini-pin High-Definition Multimedia Interface (HDMI) cable (available separately from commercial sources) can be used to connect the camera to high-definition video devices.

1 Turn the camera off.

Always turn the camera off before connecting or disconnecting an HDMI cable.

2 Connect the HDMI cable as shown.

Connect to high-definition device (choose cable with connector for HDMI device)

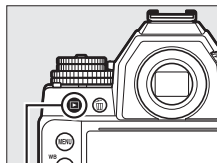


Connect to camera

3 Tune the device to the HDMI channel.


4 Turn the camera on and press the button.

During playback, images will be displayed on the television screen.



 button

HDMI and Live View

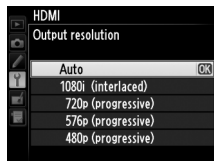
HDMI displays connected via an HDMI cable can be used for live view ( 172).

■ HDMI Options

The **HDMI** option in the setup menu (📖 271) controls output resolution and can be used to enable the camera for remote control from devices that support HDMI-CEC (**H**igh-**D**efinition **M**ultimedia Interface–**C**onsumer **E**lectronics **C**ontrol, a standard that allows HDMI devices to be used to control peripherals to which they are connected).

Output Resolution

Choose the format for images output to the HDMI device. If **Auto** is selected, the camera will automatically select the appropriate format.



Device Control

If **On** is selected for **HDMI > Device control** in the setup menu when the camera is connected to a television that supports HDMI-CEC and both the camera and television are on, the television remote can be used in place of the camera multi selector and **OK** button during full-frame playback and slide shows. If **Off** is selected, the television remote can not be used to control the camera.

HDMI-CEC Devices

When the camera is connected to an HDMI-CEC device, **ⓧ** will appear in the control panel in place of the number of exposures remaining.

Device Control

See the television manual for details.

Television Playback

Use of an AC adapter and power connector (available separately) is recommended for extended playback. The TV will display images full screen if photo information is hidden during full-frame playback (📖 188). Note that the edges may not be visible when photographs are viewed on a television screen.



Menu Guide

Defaults

The default settings for the options in the camera menus are listed below. For information on two-button resets, see page 133.

■ Playback Menu Defaults

Option	Default
Playback folder (☞ 230)	NC_DF
Image review (☞ 232)	Off
After delete (☞ 233)	Show next
Rotate tall (☞ 233)	On
Slide show (☞ 234)	
Frame interval	2 s

■ Shooting Menu Defaults ¹

Option	Default
File naming (☞ 239)	DSC
Image quality (☞ 55)	JPEG normal
Image size (☞ 58)	Large
Image area	
Choose image area (☞ 52)	FX (36×24) 1.0×
Auto DX crop (☞ 52)	On
JPEG compression (☞ 57)	Size priority
NEF (RAW) recording (☞ 57)	
Type	Lossless compressed
NEF (RAW) bit depth	14-bit

Option	Default
White balance (☞ 81)	Auto > Normal
Fine-tuning (☞ 84)	A-B: 0, G-M: 0
Choose color temp. (☞ 88)	5000 K
Preset manual (☞ 90)	d-1
Set Picture Control (☞ 100)	Standard
Color space (☞ 240)	sRGB
Active D-Lighting (☞ 110)	Off
HDR (high dynamic range)	
HDR mode (☞ 113)	Off
Exposure differential (☞ 114)	Auto
Smoothing (☞ 114)	Normal
Vignette control (☞ 241)	Normal
Auto distortion control (☞ 241)	Off
Long exposure NR (☞ 242)	Off
High ISO NR (☞ 242)	Normal
Auto ISO sensitivity control (☞ 72)	Off
Multiple exposure ²	
Multiple exposure mode (☞ 149)	Off
Number of shots (☞ 151)	2
Auto gain (☞ 152)	On
Interval timer shooting (☞ 156)	Reset ³

- 1 Default settings can be restored using **Shooting menu bank** (☞ 236). With the exceptions of **Multiple exposure** and **Interval timer shooting**, only settings in the current shooting menu bank will be reset.
- 2 Applies to all banks. Shooting menu reset is not available while shooting is in progress.
- 3 Applies to all banks. Start time reset to **Now**, interval reset to 1 minute, number of intervals and number of shots reset to 1, and **Start** set to **Off**. Shooting ends when reset is performed.




■ Custom Settings Menu Defaults*

	Option	Default
a1	AF-C priority selection (☞ 246)	Release
a2	AF-S priority selection (☞ 246)	Focus
a3	Focus tracking with lock-on (☞ 247)	3 (Normal)
a4	AF activation (☞ 247)	Shutter/AF-ON
a5	Focus point illumination (☞ 248)	
	AF point illumination	Auto
	Manual focus mode	On
a6	Focus point wrap-around (☞ 249)	No wrap
a7	Number of focus points (☞ 249)	39 points
b1	Center-weighted area (☞ 250)	ø 12 mm
b2	Fine-tune optimal exposure (☞ 250)	
	Matrix metering	0
	Center-weighted metering	0
	Spot metering	0
c1	Shutter-release button AE-L (☞ 251)	Off
c2	Standby timer (☞ 251)	6 s
c3	Self-timer (☞ 252)	
	Self-timer delay	10 s
	Number of shots	1
	Interval between shots	0.5 s
c4	Monitor off delay (☞ 253)	
	Playback	10 s
	Menus	1 min
	Information display	10 s
	Image review	4 s
	Live view	10 min
d1	Beep (☞ 253)	Off
d2	Viewfinder grid display (☞ 253)	Off
d3	ISO display (☞ 254)	Off



Option		Default
d4	Screen tips (☞ 254)	On
d5	CL mode shooting speed (☞ 254)	3 fps
d6	Max. continuous release (☞ 254)	100
d7	File number sequence (☞ 255)	On
d8	Information display (☞ 256)	Auto
d9	LCD illumination (☞ 256)	Off
d10	Exposure delay mode (☞ 256)	Off
e1	Flash sync speed (☞ 257)	1/200 s
e2	Flash shutter speed (☞ 258)	1/60 s
e3	Optional flash (☞ 258)	TTL
e4	Exposure comp. for flash (☞ 259)	Entire frame
e5	Modeling flash (☞ 259)	On
e6	Auto bracketing set (☞ 259)	AE & flash
e7	Auto bracketing (Mode M) (☞ 260)	Flash/speed
e8	Bracketing order (☞ 260)	MTR > under > over
f1	☼ button (☞ 261)	LCD backlight (☼)
f2	OK button (☞ 261)	
	Shooting mode	Select center focus point
	Playback mode	Thumbnail on/off
	Live view	Select center focus point
f3	Multi selector (☞ 262)	Do nothing
f4	Assign Fn button (☞ 263)	
	Press	None
	Press + command dials	Choose image area
f5	Assign preview button (☞ 266)	
	Press	Preview
	Press + command dials	None
f6	Assign AE-L/AF-L button (☞ 267)	
	Press	AE/AF lock
	Press + command dials	None



	Option	Default
f7	Customize command dials (☞ 267)	
	Reverse rotation	No
	Change main/sub	Off
	Aperture setting	Sub-command dial
	Menus and playback	Off
f8	Release button to use dial (☞ 269)	No
f9	Slot empty release lock (☞ 269)	Enable release
f10	Reverse indicators (☞ 269)	
f11	Easy shutter-speed shift (☞ 270)	Off

* Defaults for the current Custom Settings bank can be restored using **Custom settings bank** (☞ 245).

■ Setup Menu Defaults

	Option	Default
	Monitor brightness (☞ 273)	0
	Auto info display (☞ 273)	Off
	Clean image sensor (☞ 329)	
	Clean at startup/shutdown	Clean at startup & shutdown
	Flicker reduction (☞ 276)	Auto
	Time zone and date	
	Daylight saving time (☞ 276)	Off
	Auto image rotation (☞ 277)	On
	HDMI (☞ 223)	
	Output resolution	Auto
	Device control	On
	Location data (☞ 170)	
	Standby timer	Enable
	Set clock from satellite	Yes
	Assign remote Fn button (☞ 284)	Same as camera Fn button
	Wireless mobile adapter (☞ 284)	Enable
	Eye-Fi upload (☞ 285)	Enable



▶ The Playback Menu: *Managing Images*

To display the playback menu, press **MENU** and select the ▶ (playback menu) tab.



MENU button

The playback menu contains the following options:

Option	📖	Option	📖
Delete	205	After delete	233
Playback folder	230	Rotate tall	233
Hide image	230	Slide show	234
Playback display options	232	DPOF print order	219
Image review	232		


See Also

Menu defaults are listed on page 224.



Playback Folder

MENU button →  playback menu





Choose a folder for playback ( 185):

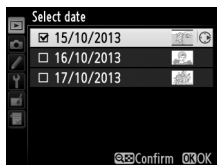
Option	Description
NC_DF	Pictures in all folders created with the Df will be visible during playback.
All	Pictures in all folders will be visible during playback.
Current	Only pictures in the current folder will be visible during playback.

Hide Image

MENU button →  playback menu

Hide or reveal pictures. Hidden pictures are visible only in the **Hide image** menu and can only be deleted by formatting the memory card.

Option	Description
Select/set	Hide or reveal selected pictures.
Select date	Selecting this option displays a list of dates. To hide all pictures taken on a date, highlight the date and press  . Selected dates are marked by a  ; to reveal all pictures taken on a selected date, highlight it and press  . Press  to complete the operation.
Deselect all	Reveal all pictures.



Protected and Hidden Images

Revealing a protected image will also remove protection from the image.



Follow the steps below to hide or reveal selected pictures.

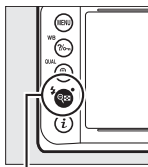
1 Choose **Select/set**.

Highlight **Select/set** and press




2 Select pictures.

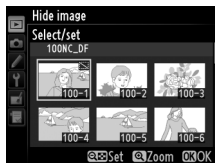
Use the multi selector to scroll through the pictures on the memory card (to view the highlighted picture full screen, press



and hold the **QUAL**

button) and press **QUAL** (⚡) to select the current picture.

Selected pictures are marked by a  icon; to deselect a picture, highlight it and press **QUAL** (⚡) again. Continue until all the desired pictures have been selected.




3 Press **OK**.

Press **OK** to complete the operation.



Playback Display Options

MENU button →  playback menu

Choose the information available in the playback photo information display (📖 188). Press ▲ or ▼ to highlight an option, then press ► to select the option for the photo information display. A ✓ appears next to selected items; to deselect, highlight and press ►. To return to the playback menu, highlight **Done** and press .

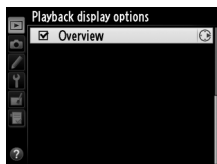
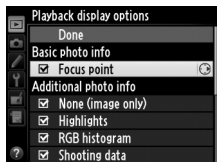



Image Review

MENU button →  playback menu




Choose whether pictures are automatically displayed in the monitor immediately after shooting. If **Off** is selected, pictures can only be displayed by pressing the  button.



After Delete

MENU button →  playback menu


Choose the picture displayed after an image is deleted.

Option	Description
 Show next	Display following picture. If deleted picture was last frame, previous picture will be displayed.
 Show previous	Display previous picture. If deleted picture was first frame, following picture will be displayed.
 Continue as before	If user was scrolling through pictures in order recorded, following picture will be displayed as described for Show next . If user was scrolling through pictures in reverse order, previous picture will be displayed as described for Show previous .

Rotate Tall

MENU button →  playback menu

Choose whether to rotate “tall” (portrait-orientation) pictures for display during playback. Note that because the camera itself is already in the appropriate orientation during shooting, images are not rotated automatically during image review.





Option	Description
On	“Tall” (portrait-orientation) pictures are automatically rotated for display in the camera monitor. Pictures taken with Off selected for Auto image rotation ( 277) will be displayed in “wide” (landscape) orientation.
Off	“Tall” (portrait-orientation) pictures are displayed in “wide” (landscape) orientation.



Create a slide show of the pictures in the current playback folder (📁 230). Hidden images (📁 230) are not displayed.

Option	Description
Start	Start slide show.
Frame interval	Choose how long each picture will be displayed.


To start the slide show, highlight **Start** and press **OK**. The following operations can be performed while the slide show is in progress:

To	Press	Description
Skip back/skip ahead		Press ◀ to return to previous frame, ▶ to skip to next frame.
View additional photo info		Change or hide photo info displayed (📖 188).
Pause/resume	OK	Pause or resume slide show.
Exit to playback menu	MENU	End slide show and return to playback menu.
Exit to playback mode		End show and return to playback mode.
Exit to shooting mode		Press shutter-release button halfway to return to shooting mode.

The dialog shown at right is displayed when the show ends. Select **Restart** to restart or **Exit** to return to the playback menu.





The Shooting Menu: *Shooting Options*

To display the shooting menu, press **MENU** and select the  (shooting menu) tab.



MENU button

The shooting menu contains the following options:


Option		Option	
Shooting menu bank	236	Color space	240
Storage folder	237	Active D-Lighting	110
File naming	239	HDR (high dynamic range)	112
Image quality	55	Vignette control	241
Image size	58	Auto distortion control	241
Image area	51	Long exposure NR	242
JPEG compression	57	High ISO NR	242
NEF (RAW) recording	57	Auto ISO sensitivity control	70
White balance	81	Multiple exposure	149
Set Picture Control	100	Interval timer shooting	156
Manage Picture Control	106		

See Also

Menu defaults are listed on page 224.

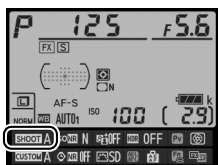


Shooting menu options are stored in one of four banks. With the exceptions of **Multiple exposure**, **Interval timer shooting**, and modifications to Picture Controls (quick adjust and other manual adjustments), changes to settings in one bank have no effect on the others. To store a particular combination of frequently-used settings, select one of the four banks and set the camera to these settings. The new settings will be stored in the bank even when the camera is turned off, and will be restored the next time the bank is selected. Different combinations of settings can be stored in the other banks, allowing the user to switch instantly from one combination to another by selecting the appropriate bank from the bank menu.



The default names for the four shooting menu banks are A, B, C, and D. A descriptive caption up to 20 characters long can be added as described on page 107 by highlighting the menu bank and pressing .

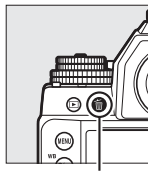
Shooting Menu Bank

The information display shows the current shooting menu bank.

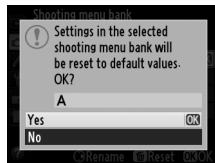


Restoring Default Settings

To restore default settings, highlight a bank in the **Shooting menu bank** menu and press . A confirmation dialog will be displayed; highlight **Yes** and press  to restore default settings for the selected bank. See page 224 for a list of default settings.



 button



Select the folder in which subsequent images will be stored.




■ Selecting Folders by Folder Number




1 Choose Select folder by number.

Highlight **Select folder by number** and press ►. The dialog shown at right will be displayed.



2 Choose a folder number.

Press ◀ or ▶ to highlight a digit, press ▲ or ▼ to change. If a folder with the selected number already exists, a , , or  icon will be displayed to the left of the folder number:

-  : Folder is empty.
-  : Folder is partially full.
-  : Folder contains 999 pictures or a picture numbered 9999. No further pictures can be stored in this folder.

3 Save changes and exit.

Press **OK** to complete the operation and return to the shooting menu (to exit without choosing the storage folder, press the **MENU** button). If a folder with the specified number does not already exist, a new folder will be created. Subsequent photographs will be stored in the selected folder unless it is already full.



✓ Folder and File Numbers

If the current folder is numbered 999 and contains 999 pictures or a picture numbered 9999, the shutter-release will be disabled and no further photographs can be taken. To continue shooting, create a folder with a number less than 999, or select an existing folder with a number less than 999 and less than 999 images.

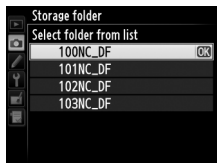
✓ Startup Time

Additional time may be required for camera startup if the memory card contains a very large number of files or folders.

■ Selecting Folders from a List

1 Choose **Select folder from list**.

Highlight **Select folder from list** and press ►.



2 Highlight a folder.

Press ▲ or ▼ to highlight a folder.

3 Select the highlighted folder.

Press **OK** to select the highlighted folder and return to the shooting menu. Subsequent photographs will be stored in the selected folder.



Photographs are saved using file names consisting of “DSC_” or, in the case of images that use the Adobe RGB color space, “_DSC”, followed by a four-digit number and a three-letter extension (e.g., “DSC_0001.JPG”). The **File naming** option is used to select three letters to replace the “DSC” portion of the file name. For information on editing file names, see page 107.

Extensions

The following extensions are used: “.NEF” for NEF (RAW) images, “.TIF” for TIFF (RGB) images, “.JPG” for JPEG images, and “.NDF” for dust off reference data. In each pair of photographs recorded at image-quality settings of NEF (RAW)+JPEG, the NEF and JPEG images have the same file names but different extensions.



The color space determines the gamut of colors available for color reproduction. Choose **sRGB** for photographs that will be printed or used “as is,” with no further modification. **Adobe RGB** has a wider color gamut and is recommended for images that will be extensively processed or retouched after leaving the camera.

Color Space

Color spaces define the correspondence between colors and the numeric values that represent them in a digital image file. The sRGB color space is widely used, while the Adobe RGB color space is typically used in publishing and commercial printing. sRGB is recommended when taking photographs that will be printed without modification or viewed in applications that do not support color management, or when taking photographs that will be printed with ExifPrint, the direct printing option on some household printers, or kiosk printing or other commercial print services. Adobe RGB photographs can also be printed using these options, but colors will not be as vivid.

JPEG photographs taken in the Adobe RGB color space are DCF compliant; applications and printers that support DCF will select the correct color space automatically. If the application or device does not support DCF, select the appropriate color space manually. An ICC color profile is embedded in TIFF photographs taken in the Adobe RGB color space, allowing applications that support color management to automatically select the correct color space. For more information, see the documentation provided with the application or device.



Nikon Software

ViewNX 2 (supplied) and Capture NX 2 (available separately) automatically select the correct color space when opening photographs created with this camera.




“Vignetting” is a drop in brightness at the edges of a photograph. **Vignette control** reduces vignetting for type G, E, and D lenses (DX and PC lenses excluded). Its effects vary from lens to lens and are most noticeable at maximum aperture. Choose from **High**, **Normal**, **Low**, and **Off**.

Vignette Control

Depending on the scene, shooting conditions, and type of lens, TIFF and JPEG images may exhibit noise (fog) or variations in peripheral brightness, while custom Picture Controls and preset Picture Controls that have been modified from default settings may not produce the desired effect. Take test shots and view the results in the monitor. Vignette control does not apply to multiple exposures ( 149) or DX-format images ( 52).

Auto Distortion Control

Select **On** to reduce barrel distortion when shooting with wide-angle lenses and to reduce pin-cushion distortion when shooting with long lenses (note that the edges of the area visible in the viewfinder may be cropped out of the final photograph, and that the time needed to process photographs before recording begins may increase). This option is available only with type G, E, and D lenses (PC, fisheye, and certain other lenses excluded); results are not guaranteed with other lenses. Before using auto distortion control with DX lenses, select **On** for **Auto DX crop** or choose an image area of **DX (24×16) 1.5×** ( 52); selecting other options may result in heavily cropped photographs or in photographs with severe peripheral distortion.

Retouch: Distortion Control

For information on creating copies of existing photographs with reduced barrel and pin-cushion distortion, see page 305.



Long Exposure NR (Long Exposure Noise Reduction)

MENU button →  shooting menu

If **On** is selected, photographs taken at shutter speeds slower than 1 s will be processed to reduce noise (bright spots, randomly-spaced bright pixels, or fog). The time required for processing roughly doubles; during processing, “Job NR” will flash in the shutter speed/aperture



displays and pictures can not be taken (if the camera is turned off before processing is complete, the picture will be saved but noise reduction will not be performed). In continuous release mode, frame rates will slow and while photographs are being processed, the capacity of the memory buffer will drop.

High ISO NR


MENU button →  shooting menu

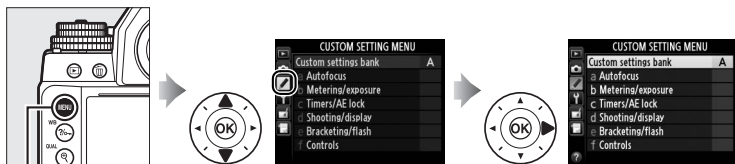
Photographs taken at high ISO sensitivities can be processed to reduce “noise.”

Option	Description
High	Reduce noise (randomly-spaced bright pixels, lines, or fog), particularly in photographs taken at high ISO sensitivities.
Normal	
Low	Choose the amount of noise reduction performed from High , Normal , and Low .
Off	Noise reduction is only performed at ISO sensitivities of ISO 3200 and higher. The amount of noise reduction is less than the amount performed when Low is selected for High ISO NR .



Custom Settings: *Fine-Tuning Camera Settings*

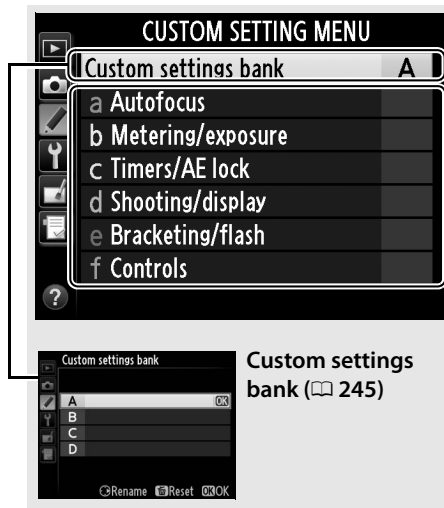
To display the Custom Settings menu, press **MENU** and select the  (Custom Settings menu) tab.



MENU button

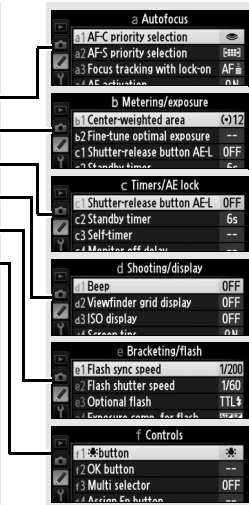
Custom Settings are used to customize camera settings to suit individual preferences.

Main menu






Custom settings bank (📖 245)


Custom Setting groups



The following Custom Settings are available:

Custom Setting		
Custom settings bank		245
a Autofocus		
a1	AF-C priority selection	246
a2	AF-S priority selection	246
a3	Focus tracking with lock-on	247
a4	AF activation	247
a5	Focus point illumination	248
a6	Focus point wrap-around	249
a7	Number of focus points	249
b Metering/exposure		
b1	Center-weighted area	250
b2	Fine-tune optimal exposure	250
c Timers/AE lock		
c1	Shutter-release button AE-L	251
c2	Standby timer	251
c3	Self-timer	252
c4	Monitor off delay	253
d Shooting/display		
d1	Beep	253
d2	Viewfinder grid display	253
d3	ISO display	254
d4	Screen tips	254
d5	CL mode shooting speed	254
d6	Max. continuous release	254
d7	File number sequence	255
d8	Information display	256
d9	LCD illumination	256
d10	Exposure delay mode	256

Custom Setting		
e Bracketing/flash		
e1	Flash sync speed	257
e2	Flash shutter speed	258
e3	Optional flash	258
e4	Exposure comp. for flash	259
e5	Modeling flash	259
e6	Auto bracketing set	259
e7	Auto bracketing (Mode M)	260
e8	Bracketing order	260
f Controls		
f1	 button	261
f2	OK button	261
f3	Multi selector	262
f4	Assign Fn button	263
f5	Assign preview button	266
f6	Assign AE-L/AF-L button	267
f7	Customize command dials	267
f8	Release button to use dial	269
f9	Slot empty release lock	269
f10	Reverse indicators	269
f11	Easy shutter-speed shift	270

Note: If settings in the current bank have been modified from default values ( 226), an asterisk will be displayed adjacent to the altered settings in the second level of the Custom Settings menu.

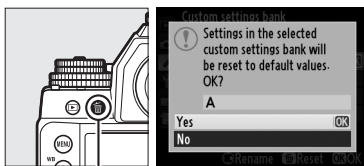


Custom Settings are stored in one of four banks. Changes to settings in one bank have no effect on the others. To store a particular combination of frequently-used settings, select one of the four banks and set the camera to these settings. The new settings will be stored in the bank even when the camera is turned off, and will be restored the next time the bank is selected. Different combinations of settings can be stored in the other banks, allowing the user to switch instantly from one combination to another by selecting the appropriate bank from the bank menu.

The default names for the four Custom Settings banks are A, B, C, and D. A descriptive caption up to 20 characters long can be added as described on page 107 by highlighting the menu bank and pressing ►.

■ Restoring Default Settings

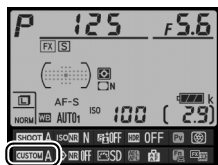
To restore default settings, highlight a bank in the **Custom settings bank** menu and press . A confirmation dialog will be displayed; highlight **Yes** and press to restore default settings for the selected bank (226).



button

Custom Settings Bank

The information display shows the current Custom Settings bank.





a: Autofocus

a1: AF-C Priority Selection

MENU button →  Custom Settings menu

When **AF-C** is selected for viewfinder photography (📖 59), this option controls whether photographs can be taken whenever the shutter-release button is pressed (*release priority*) or only when the camera is in focus (*focus priority*).



Option	Description
 Release	Photos can be taken whenever the shutter-release button is pressed.
 Focus	Photos can only be taken when the in-focus indicator (●) is displayed.

Regardless of the option selected, focus will not lock when **AF-C** is selected for autofocus mode. The camera will continue to adjust focus until the shutter is released.

a2: AF-S Priority Selection

MENU button →  Custom Settings menu

When **AF-S** is selected for viewfinder photography (📖 59), this option controls whether photographs can be taken only when the camera is in focus (*focus priority*) or whenever the shutter-release button is pressed (*release priority*).

Option	Description
 Release	Photos can be taken whenever the shutter-release button is pressed.
 Focus	Photos can only be taken when the in-focus indicator (●) is displayed.






Regardless of the option selected, if the in-focus indicator (●) is displayed when **AF-S** is selected for autofocus mode, focus will lock while the shutter-release button is pressed halfway. Focus lock continues until the shutter is released.



a3: Focus Tracking with Lock-On

MENU button →  Custom Settings menu

This option controls how autofocus adjusts to sudden large changes in the distance to the subject when **AF-C** is selected during viewfinder photography (📖 59).

Option	Description
AF  5 (Long)	When the distance to the subject changes abruptly, the camera waits for the specified period before adjusting the distance to the subject. This prevents the camera from refocusing when the subject is briefly obscured by objects passing through the frame.
AF  4	
AF  3 (Normal)	
AF  2	
AF  1 (Short)	
Off	The camera immediately adjusts focus when the distance to the subject changes. Use when photographing a series of subjects at varying distances in quick succession.

a4: AF Activation

MENU button →  Custom Settings menu

If **Shutter/AF-ON** is selected, both the shutter-release button and the **AF-ON** button can be used to initiate autofocus. Select **AF-ON only** to prevent the camera focusing when the shutter-release button is pressed halfway.



The options in this menu control whether or not the focus points are illuminated.

■ ■ *AF point illumination*

Choose whether the active focus point is highlighted in red in the viewfinder.


Option	Description
Auto	The selected focus point is automatically highlighted as needed to establish contrast with the background.
On	The selected focus point is always highlighted, regardless of the brightness of the background. Depending on the brightness of the background, the selected focus point may be difficult to see.
Off	The selected focus point is not highlighted. The area outside the current crop is shown in grey (📖 52).

■ ■ *Manual focus mode*




Choose **On** to display the active focus point in manual focus mode.




a6: Focus Point Wrap-Around

MENU button →  Custom Settings menu



Choose whether focus-point selection “wraps around” from one edge of the viewfinder to another.

Option	Description
Wrap	Focus-point selection “wraps around” from top to bottom, bottom to top, right to left, and left to right, so that, for example, pressing  when a focus point at the right edge of the display is highlighted (①) selects the corresponding focus point at the left edge of the display (②). 
No wrap	The focus-point display is bounded by the outermost focus points so that, for example, pressing  when a focus point at the right edge of the display is selected has no effect.

a7: Number of Focus Points

MENU button →  Custom Settings menu


Choose the number of focus points available for manual focus-point selection.

Option	Description
AF39 39 points	Choose from the 39 focus points shown at right. 
AF11 11 points	Choose from the 11 focus points shown at right. Use for quick focus-point selection. 

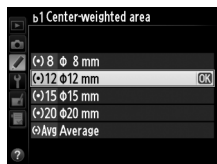


b: Metering/Exposure

b1: Center-Weighted Area


MENU button →  Custom Settings menu

When calculating exposure, center-weighted metering assigns the greatest weight to a circle in the center of the frame. The diameter (ϕ) of this circle can be set to 8, 12, 15, or 20 mm or to the average of the entire frame.

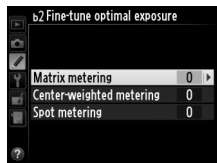


Note that the diameter is fixed at 12 mm when a non-CPU lens is used, regardless of the setting selected for **Non-CPU lens data** in the setup menu (□ 163).


b2: Fine-tune Optimal Exposure

MENU button →  Custom Settings menu

Use this option to fine-tune the exposure value selected by the camera. Exposure can be fine-tuned separately for each metering method by from +1 to -1 EV in steps of $\frac{1}{6}$ EV.



Fine-Tuning Exposure

Exposure can be fine-tuned separately for each Custom Settings bank and is not affected by two-button resets. Note that as the exposure compensation () icon is not displayed, the only way to determine how much exposure has been altered is to view the amount in the fine-tuning menu. Exposure compensation (□ 79) is preferred in most situations.



c: Timers/AE Lock

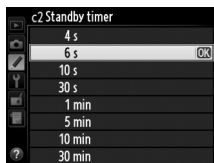
c1: Shutter-Release Button AE-L MENU button → Custom Settings menu

If **On** is selected, exposure will lock when the shutter-release button is pressed halfway.

c2: Standby timer

MENU button →  Custom Settings menu


Choose how long the camera continues to meter exposure when no operations are performed. The shutter-speed and aperture displays in the control panel and viewfinder turn off automatically when the timer expires.

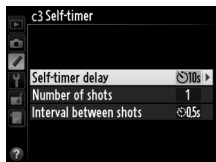


Choose a shorter standby timer delay for longer battery life.



Choose the length of the shutter release delay, the number of shots taken, and the interval between shots in self-timer mode.

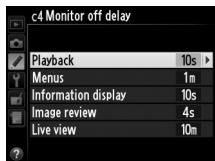
- **Self-timer delay:** Choose the length of the shutter-release delay ( 48).
- **Number of shots:** Press ▲ and ▼ to choose the number of shots taken each time the shutter-release button is pressed.
- **Interval between shots:** Choose the interval between shots when the **Number of shots** is more than 1.



c4: Monitor off Delay

MENU button → Custom Settings menu

Choose how long the monitor remains on when no operations are performed during playback (**Playback**; defaults to 10 s) and image review (**Image review**; defaults to 4 s), when menus (**Menus**; defaults to 1 minute) or information (**Information display**; defaults to 10 s) are displayed, or during live view (**Live view**; defaults to 10 minutes). Choose a shorter monitor-off delay for longer battery life.

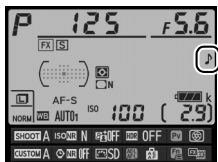


d: Shooting/Display

d1: Beep

MENU button → Custom Settings menu

Choose the pitch of the beep that sounds when the camera focuses using single-servo AF (**AF-S**; 59), when focus locks, while the release timer is counting down in self-timer mode (48), or if you attempt to take a photograph when the memory card is locked (22).



To disable the beep, choose **Off**. appears in the information display when an option other than **Off** is selected. Note that a beep will not sound in quiet-shutter release mode (mode **Q**; 46), regardless of the option selected.


d2: Viewfinder Grid Display

MENU button → Custom Settings menu

Choose **On** to display on-demand grid lines in the viewfinder for reference when composing photographs (9).




d3: ISO Display

MENU button →  Custom Settings menu

If **On** is selected, the viewfinder will show ISO sensitivity in place of the number of exposures remaining.


d4: Screen Tips

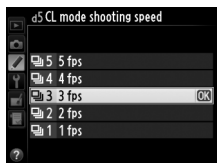
MENU button →  Custom Settings menu

Choose **On** to display tool tips for items selected in the information display ( 14).

d5: CL Mode Shooting Speed

MENU button →  Custom Settings menu

Choose the maximum frame advance rate in **CL** (continuous low speed) mode ( 46; during interval timer photography, this setting also determines the frame advance rate for single-frame).




d6: Max. Continuous Release

MENU button →  Custom Settings menu

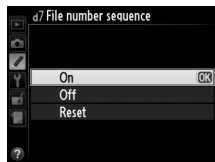
The maximum number of shots that can be taken in a single burst in continuous mode can be set to any value between 1 and 100.

The Memory Buffer

Regardless of the option selected for Custom Setting d6, shooting will slow when the memory buffer fills (). See page 364 for more information on the capacity of the memory buffer.



When a photograph is taken, the camera names the file by adding one to the last file number used. This option controls whether file numbering continues from the last number used when a new folder is created, the memory card is formatted, or a new memory card is inserted in the camera.



Option	Description
On	When a new folder is created, the memory card formatted, or a new memory card inserted in the camera, file numbering continues from the last number used or from the largest file number in the current folder, whichever is higher. If a photograph is taken when the current folder contains a photograph numbered 9999, a new folder will be created automatically and file numbering will begin again from 0001.
Off	File numbering is reset to 0001 when a new folder is created, the memory card is formatted, or a new memory card is inserted in the camera. Note that a new folder is created automatically if a photograph is taken when the current folder contains 999 photographs.
Reset	As for On , except that the next photograph taken is assigned a file number by adding one to the largest file number in the current folder. If the folder is empty, file numbering is reset to 0001.

File Number Sequence

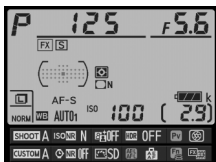
If the current folder is numbered 999 and contains either 999 photographs or a photograph numbered 9999, the shutter-release button will be disabled and no further photographs can be taken. Choose **Reset** for Custom Setting d7 (**File number sequence**) and then either format the current memory card or insert a new memory card.



d8: Information Display

MENU button → Custom Settings menu

If **Auto** (AUTO) is selected, the color of the lettering in the information display (☐ 11) will automatically change from black to white or white to black to maintain contrast with the background. To always use the same color lettering, select **Manual** and choose **Dark on light** (B; black lettering) or **Light on dark** (W; white lettering). Monitor brightness will automatically be adjusted for maximum contrast with the selected text color.



Dark on light



Light on dark

d9: LCD Illumination

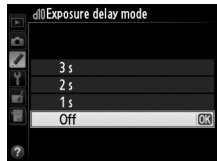
MENU button → Custom Settings menu

If **Off** is selected, the control panel backlight (LCD illuminator) will light only when the button is pressed. If **On** is selected, the control panel will be illuminated whenever the standby timer is active (☐ 5; note that regardless of the option selected, the backlight turns off while the shutter-release button is pressed). Select **Off** for increased battery life.

d10: Exposure Delay Mode

MENU button → Custom Settings menu

In situations where the slightest camera movement can blur pictures, select **1 s**, **2 s**, or **3 s** to delay shutter release until one, two, or three seconds after the mirror is raised.



e: Bracketing/Flash

e1: Flash Sync Speed

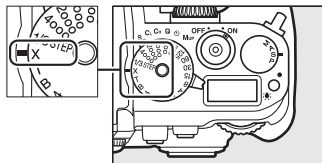
MENU button →  Custom Settings menu

This option controls flash sync speed.

Option	Description
1/250 s (Auto FP)	Auto FP high-speed sync is used when a compatible flash unit is attached (📖 119). If other flash units are used, shutter speed is set to $1/250$ s. When the camera shows a shutter speed of $1/250$ s in exposure mode P or A , auto FP high-speed sync will be activated if the actual shutter speed is faster than $1/250$ s.
1/200 s (Auto FP)	Auto FP high-speed sync is used when a compatible flash unit is attached (📖 119). If other flash units are used, shutter speed is set to $1/200$ s. When the camera shows a shutter speed of $1/200$ s in exposure mode P or A , auto FP high-speed sync will be activated if the actual shutter speed is faster than $1/200$ s.
1/200 s–1/60 s	Flash sync speed set to selected value.

Fixing Shutter Speed at the Flash Sync Speed Limit

To fix shutter speed at the sync speed limit in exposure mode **S** or **M**, rotate the shutter-speed dial to **X**. An X (flash sync indicator) will be displayed in the viewfinder and control panel.



Auto FP High-Speed Sync

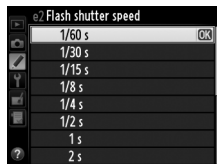
Allows the flash to be used at the highest shutter speed supported by the camera, making it possible to choose the maximum aperture for reduced depth of field even when the subject is backlit in bright sunlight. The information display flash mode indicator shows “FP” when auto FP high-speed sync is active (📖 123).




e2: Flash Shutter Speed

MENU button →  Custom Settings menu



This option determines the slowest shutter speed available when using front- or rear-curtain sync or red-eye reduction in exposure mode **P** or **A** (regardless of the setting chosen, shutter speeds can be as slow as 30 s in **S** and **M** modes or at flash settings of slow sync, slow rear-curtain sync, or red-eye reduction with slow sync). Options range from $1/60$ s (**1/60 s**) to 30 s (**30 s**).



e3: Optional Flash

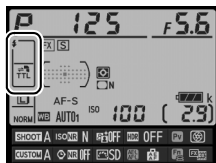
MENU button →  Custom Settings menu

Choose a flash control mode for optional SB-400 or SB-300 flash units.

Option	Description
TTL  TTL	Flash output is adjusted automatically in response to shooting conditions (📖 124).
 Manual	Choose a flash level. Monitor pre-flashes are not emitted.

Flash Control Mode



The flash control mode is shown in the information display (📖 11, 123).



e4: Exposure Comp. for Flash

MENU button →  Custom Settings menu

Choose how the camera adjusts flash level when exposure compensation is used.

Option	Description
 Entire frame	Both flash level and exposure compensation are adjusted to modify exposure over the entire frame.
 Background only	Exposure compensation applies to background only.

e5: Modeling Flash

MENU button →  Custom Settings menu

If **On** is selected when the camera is being used with an optional flash unit that supports the Nikon Creative Lighting system (□ 118), a modeling flash will be emitted when the camera **Pv** button is pressed (□ 41). No modeling flash is emitted if **Off** is selected.

e6: Auto Bracketing Set

MENU button →  Custom Settings menu





Choose the setting or settings bracketed when auto bracketing (□ 136) is in effect. Choose **AE & flash** (AE $\frac{1}{2}$) to perform both exposure and flash-level bracketing, **AE only** (AE) to bracket only exposure, **Flash only** ($\frac{1}{2}$) to perform only flash-level bracketing, **WB bracketing** (WB) to perform white-balance bracketing (□ 141), or **ADL bracketing** (ADL) to perform bracketing using Active D-Lighting (□ 145). Note that white balance bracketing is not available at image quality settings of NEF (RAW) or NEF (RAW) + JPEG.



e7: Auto Bracketing (Mode M)

MENU button →  Custom Settings menu

This option determines which settings are affected when **AE & flash** or **AE only** is selected for Custom Setting e6 in manual exposure mode.

Option	Description
 Flash/speed	Camera varies shutter speed (Custom Setting e6 set to AE only) or shutter speed and flash level (Custom Setting e6 set to AE & flash).
 Flash/speed/aperture	Camera varies shutter speed and aperture (Custom Setting e6 set to AE only) or shutter speed, aperture, and flash level (Custom Setting e6 set to AE & flash).
 Flash/aperture	Camera varies aperture (Custom Setting e6 set to AE only) or aperture and flash level (Custom Setting e6 set to AE & flash).
 Flash only	Camera varies flash level only (Custom Setting e6 set to AE & flash).

Flash bracketing is performed only with i-TTL or AA flash control. If a setting other than **Flash only** is selected and the flash is not used, ISO sensitivity will be fixed at the value for the first shot, regardless of the setting selected for auto ISO sensitivity control (📖 72).

e8: Bracketing Order

MENU button →  Custom Settings menu






At the default setting of **MTR > under > over** (📷), exposure, flash, and white balance bracketing are performed in the order described on pages 137 and 141. If **Under > MTR > over** (→+) is selected, shooting will proceed in order from the lowest to the highest value. This setting has no effect on ADL bracketing.



f: Controls


f1: Button

MENU button →  Custom Settings menu




Choose the role played by the  button: turning the control panel backlight on or off ( **LCD backlight** () on/off) or turning the control panel and information display on or off ( **Info**  **and information display** on/off).

f2: OK Button








MENU button →  Custom Settings menu

This option determines the role assigned to the  button during viewfinder photography, playback, and live view.






■ Shooting Mode

Option	Role assigned to  button
 Select center focus point	Select the center focus point.
 Highlight active focus point	Highlight the active focus point.
Not used	None.


■ Playback Mode


Option	Role assigned to  button
 Thumbnail on/off	Toggle between full-frame and thumbnail playback.
 View histograms	In both full-frame and thumbnail playback, a histogram is displayed ( 192) while the  button is pressed.
 Zoom on/off	Toggle between full-frame or thumbnail playback and playback zoom. Choose the initial zoom setting from Low magnification , Medium magnification , and High magnification . The zoom display will center on the active focus point (if the picture was taken in viewfinder photography) or on the center of the image (if the picture was taken during live view).
 Choose folder	Display a folder selection dialog.

■ Live View

Option	Role assigned to  button
RESET Select center focus point	Pressing the  button in live view selects the center focus point.
 Zoom on/off	Press the  button to toggle zoom on and off. Choose the initial zoom setting from Low magnification , Medium magnification , and High magnification . The zoom display will center on the active focus point.
Not used	Pressing the  button has no effect in live view.

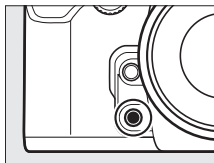
f3: Multi Selector

MENU button →  Custom Settings menu

If **Restart standby timer** is selected, operating the multi selector when the standby timer expires ( 33) will activate the meters and start the standby timer. If **Do nothing** is selected, the timer will not start when the multi selector is pressed.












Choose the role played by the **Fn** button, either by itself (**Press**) or when used in combination with the command dials (**Press + command dials**).















■ Press

Selecting **Press** displays the following options:

Option	Description
 Preview	Press the Fn button to preview depth of field (☞ 41).
 FV lock	Press the Fn button to lock flash value (supported flash units only, ☞ 118). Press again to cancel FV lock (☞ 130).
 AE/AF lock	Focus and exposure lock while the Fn button is pressed.
 AE lock only	Exposure locks while the Fn button is pressed.
 AE lock (Reset on release)	Exposure locks when the Fn button is pressed, and remains locked until the button is pressed a second time, the shutter is released, or the standby timer expires.
 AE lock (Hold)	Exposure locks when the Fn button is pressed, and remains locked until the button is pressed a second time or the standby timer expires.
 AF lock only	Focus locks while the Fn button is pressed.
 AF-ON	Pressing the Fn button initiates autofocus.
 Flash off	The flash will not fire in photos taken while the Fn button is pressed.



Option	Description
 Bracketing burst	If the Fn button is pressed while exposure, flash, or ADL bracketing is active in single frame or quiet shutter-release mode, all shots in the current bracketing program will be taken each time the shutter-release button is pressed. If white balance bracketing is active or continuous release mode (mode Ch or Cl) is selected, the camera will repeat the bracketing burst while the shutter-release button is held down.
 +NEF (RAW)	If image quality is set to JPEG fine , JPEG normal , or JPEG basic , “RAW” will be displayed in the control panel and an NEF (RAW) copy will be recorded with the next picture taken after the Fn button is pressed (to record NEF/RAW copies with a series of photographs, keep the shutter-release button pressed halfway between shots). To exit without recording an NEF (RAW) copy, press the Fn button again.
 Matrix metering	Matrix metering is activated while the Fn button is pressed.
 Center-weighted metering	Center-weighted metering is activated while the Fn button is pressed.
 Spot metering	Spot metering is activated while the Fn button is pressed.
 Viewfinder grid display	Press the Fn button to turn the framing grid display in the viewfinder on or off (□ 9).
 Viewfinder virtual horizon	Press the Fn button to view a virtual horizon display in the viewfinder (□ 265).
 MY MENU	Pressing the Fn button displays “MY MENU” (□ 313).
 Access top item in MY MENU	Press the Fn button to jump to the top item in “MY MENU.” Select this option for quick access to a frequently-used menu item.

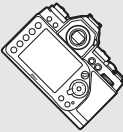

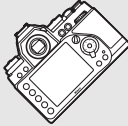



Option	Description
 Playback	Fn button performs same function as  button. Select when using a telephoto lens or in other circumstances in which it is difficult to operate the  button with your left hand.
None	Pressing the button has no effect.

Incompatible Options

If the option selected for **Press** can not be used in combination with the option selected for **Press + command dials**, a message will be displayed and whichever of **Press** or **Press + command dials** was selected first will be set to **None**.

Viewfinder Virtual Horizon

When **Viewfinder virtual horizon** is selected for Custom Setting f4 (**Assign Fn button**) > **Press**, pressing the **Fn** button converts the exposure indicator in the viewfinder to a roll display. Press the button again to restore the indicator to its normal function.




	Camera tilted right	Camera level	Camera tilted left
			
Viewfinder			

Note that the display may not be accurate when the camera is tilted at a sharp angle forward or back. For a display that shows both pitch and roll, use the **Virtual horizon** option in the setup menu (📖 282).



■ ■ Press + command dials

Selecting **Press + command dials** displays the following options:

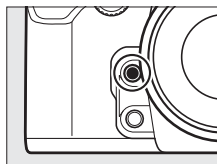
Option	Description
 Choose image area	Keeping the Fn button pressed, rotate a command dial to choose an image area (☞ 51).
Non-CPU Choose non-CPU lens number	Keeping the Fn button pressed, rotate a command dial to choose a lens number specified using the Non-CPU lens data option (☞ 163).
 Active D-Lighting	Keeping the Fn button pressed, rotate a command dial to adjust Active D-Lighting (☞ 110).
HDR HDR (high dynamic range)	Keeping the Fn button pressed, rotate the main command dial to choose an HDR mode , the sub-command dial to choose Exposure differential (☞ 112).
ISO-A Auto ISO sensitivity control	Keeping the Fn button pressed, rotate a command dial to turn auto ISO sensitivity control on or off (☞ 72).
 Multiple exposure	Keeping the Fn button pressed, rotate the main command dial to choose the multiple exposure mode; press the Fn button and rotate the sub-command dial to choose the number of exposures (☞ 149).
None	No operation is performed when the command dials are rotated while the Fn button is pressed.

f5: Assign Preview Button


MENU button →  Custom Settings menu

Choose the role played by the **Pv** button, either by itself (**Press**) or when used in combination with the command dials (**Press + command dials**). The options available are the same as for **Assign Fn button** (☞ 263). The default options for

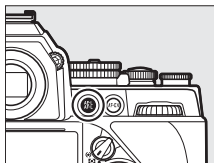
Press and **Press + command dials** are **Preview** (☞ 41) and **None**, respectively.



f6: Assign AE-L/AF-L Button

MENU button →  Custom Settings menu

Choose the role played by the ^{AE-L}/_{AF-L} **AE-L/AF-L** button, either alone (**Press**) or in combination with the command dials (**Press + command dials**). The options available are the same as for **Assign Fn button** (📖 263), except that **HDR (high dynamic range)** and **Multiple exposure** are not available for **Press + command dials**. The default options for **Press** and **Press + command dials** are **AE/AF lock** and **None**, respectively.

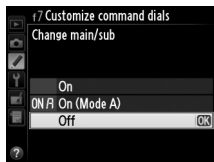


f7: Customize Command Dials

MENU button →  Custom Settings menu

This option controls the operation of the main and sub-command dials.

- **Reverse rotation:** Reverse the direction of rotation of the command dials.
- **Change main/sub:** If **Off** is selected, the main command dial controls shutter speed and the sub-command dial controls aperture. If **On** is selected, the main command dial will control aperture and the sub-command dial shutter speed. If **On (Mode A)** is selected, the main command dial will be used to set aperture in exposure mode **A** only.






- **Aperture setting:** If **Sub-command dial** is selected, aperture can only be adjusted with the sub-command dial (or with the main command dial if **On** is selected for **Change main/sub**). If **Aperture ring** is selected, aperture can only be adjusted with the lens aperture ring and the camera aperture display will show aperture in increments of 1 EV (aperture for type G and E lenses is still set using the sub-command dial). Note that regardless of the setting chosen, the aperture ring must be used to adjust aperture when a non-CPU lens is attached.
- **Menus and playback:** If **Off** is selected, the multi selector is used to choose the picture displayed during full-frame playback, highlight thumbnails, and navigate menus. If **On** or **On (image review excluded)** is selected, the main command dial can be used to choose the picture displayed during full-frame playback, move the cursor left or right during thumbnail playback, and move the menu highlight bar up or down. The sub-command dial is used to display additional photo information in full-frame playback and to move the cursor up or down during thumbnail playback. Select **On (image review excluded)** to prevent the command dials from being used for playback during image review. While menus are displayed, rotating the sub-command dial right displays the sub-menu for the selected option, while rotating it left displays the previous menu. To make a selection, press ► or Ⓞ.



f8: Release Button to Use Dial

MENU button →  Custom Settings menu


Selecting **Yes** allows adjustments that are normally made by holding the ,  (QUAL),  (WB), AF-mode, or BKT button and rotating a command dial to be made by rotating the command dial after the button is released (this also applies to the **Fn**, **Pv**, and ^{AE-L}_{AF-L} **AE-L/AF-L** buttons if they have been assigned a “+ command dials” function other than **Choose image area**, **Choose non-CPU lens number**, or **Auto ISO sensitivity control** using Custom Setting f4, **Assign Fn button**, f5, **Assign preview button**, or f6, **Assign AE-L/AF-L button**). Setting ends when any of the affected buttons is pressed again, the standby timer expires, or the shutter-release button is pressed halfway.



f9: Slot Empty Release Lock

MENU button →  Custom Settings menu

Selecting **Enable release** allows the shutter to be released when no memory card is inserted, although no pictures will be recorded (they will however be displayed in the monitor in demo mode). If **Release locked** is selected, the shutter-release button is only enabled when a memory card is inserted in the camera.


f10: Reverse Indicators

MENU button →  Custom Settings menu

If  (-0+) is selected, the exposure indicators in the viewfinder and information display are displayed with negative values on the left and positive values on the right. Select  (+0-) to display positive values on the left and negative values on the right.



f11: Easy Shutter-Speed Shift

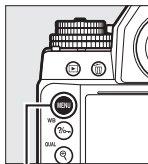
MENU button →  Custom Settings menu

If **On** is selected, the main command dial can be used to adjust the shutter speed selected with the shutter-speed dial by $\pm 2/3$ EV in increments of $1/3$ EV. If the shutter speed dial is set to **4** (4 s, labelled in red), the main command dial can be used to select shutter speeds as slow as 30 s.



Y The Setup Menu: *Camera Setup*



To display the setup menu, press **MENU** and select the **Y** (setup menu) tab.



MENU button



The setup menu contains the following options:

Option		Option	
Format memory card	272	Copyright information	279
Monitor brightness	273	Save/load settings	280
Auto info display	273	Virtual horizon	282
Clean image sensor	329	Non-CPU lens data	163
Lock mirror up for cleaning ¹	331	AF fine-tune	283
Image Dust Off ref photo	274	HDMI	223
Flicker reduction	276	Location data	170
Time zone and date	276	Assign remote Fn button	284
Language	277	Wireless mobile adapter	284
Auto image rotation	277	Eye-Fi upload ²	285
Image comment	278	Firmware version	286

1 Not available when battery is low.

2 Only displayed when compatible Eye-Fi memory card is inserted ( 285).

See Also

Menu defaults are listed on page 228.



Memory cards must be formatted before first use or after being formatted in other devices. Format the card as described below.

✔ Formatting Memory Cards

Formatting memory cards permanently deletes any data they may contain. Be sure to copy any photographs and other data you wish to keep to a computer before proceeding (☰ 211).

1 Highlight Yes.

To exit without formatting the memory card, highlight **No** and press **OK**.




2 Press **OK**.

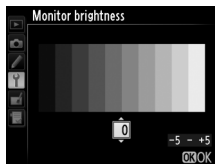
Press **OK** to begin formatting. *Do not remove the memory card or remove or disconnect the power source until formatting is complete.*



Monitor Brightness

MENU button →  setup menu


Press ▲ or ▼ to choose monitor brightness for playback, menus, and the information display. Choose higher values for increased brightness, lower values for reduced brightness.



See Also

For information on adjusting monitor brightness in live view, see page 179.

Auto Info Display

MENU button →  setup menu

If **Auto info display** is selected, shooting information will automatically be displayed in the monitor when the shutter-release button returns to its starting position after being pressed halfway.



Acquire reference data for the Image Dust Off option in Capture NX 2 (available separately; for more information, see the Capture NX 2 manual).

Image Dust Off ref photo is available only when a CPU lens is mounted on the camera. A non-DX lens with a focal length of at least 50 mm is recommended. When using a zoom lens, zoom all the way in.

1 Choose a start option.

Highlight one of the following options and press **OK**. To exit without acquiring image dust off data, press **MENU**.



- **Start:** The message shown at right will be displayed and “rEF” will appear in the viewfinder and control panel displays.
- **Clean sensor and then start:** Select this option to clean the image sensor before starting. The message shown at right will be displayed and “rEF” will appear in the viewfinder and control panel displays when cleaning is complete.



2 Frame a featureless white object in the viewfinder.

With the lens about ten centimeters (four inches) from a well-lit, featureless white object, frame the object so that it fills the viewfinder and then press the shutter-release button halfway.

In autofocus mode, focus will automatically be set to infinity; in manual focus mode, set focus to infinity manually.

3 Acquire dust off reference data.

Press the shutter-release button the rest of the way down to acquire Image Dust Off reference data. The monitor turns off when the shutter-release button is pressed. Note that noise reduction will be performed if the subject is poorly lit, increasing recording times.

If the reference object is too bright or too dark, the camera may be unable to acquire Image Dust Off reference data and the message shown at right will be displayed. Choose another reference object and repeat the process from step 1.

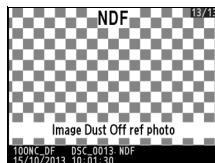


Image Sensor Cleaning

Dust off reference data recorded before image sensor cleaning is performed can not be used with photographs taken after image sensor cleaning is performed. Select **Clean sensor and then start** only if the dust off reference data will not be used with existing photographs.

Image Dust Off Reference Data

The same reference data can be used for photographs taken with different lenses or at different apertures. Reference images can not be viewed using computer imaging software. A grid pattern is displayed when reference images are viewed on the camera.





Reduce flicker and banding when shooting under fluorescent or mercury-vapor lighting during live view. Choose **Auto** to allow the camera to automatically choose the correct frequency, or manually match the frequency to that of the local AC power supply.

Flicker Reduction

If **Auto** fails to produce the desired results and you are unsure as to the frequency of the local power supply, test both the 50 and 60 Hz options and choose the one that produces the best results. Flicker reduction may not produce the desired results if the subject is very bright, in which case you should try choosing a smaller aperture (higher f-number).

Time Zone and Date



Change time zones, set the camera clock, choose the date display order, and turn daylight saving time on or off ( 27).

Option	Description
Time zone	Choose a time zone. The camera clock is automatically set to the time in the new time zone.
Date and time	Set the camera clock. If the clock is not set, a flashing  icon will appear in the information display.
Date format	Choose the order in which the day, month, and year are displayed.
Daylight saving time	Turn daylight saving time on or off. The camera clock will automatically be advanced or set back one hour. The default setting is Off .



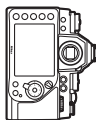
Choose a language for camera menus and messages.

Auto Image Rotation

Photographs taken while **On** is selected contain information on camera orientation, allowing them to be rotated automatically during playback ( 187) or when viewed in ViewNX 2 (supplied) or in Capture NX 2 (available separately;  325). The following orientations are recorded:



Landscape (wide)
orientation




Camera rotated 90°
clockwise



Camera rotated 90°
counter-clockwise

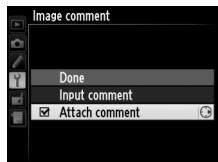
Camera orientation is not recorded when **Off** is selected. Choose this option when panning or taking photographs with the lens pointing up or down.

Rotate Tall

To automatically rotate “tall” (portrait-orientation) photographs for display during playback, select **On** for the **Rotate tall** option in the playback menu ( 233).

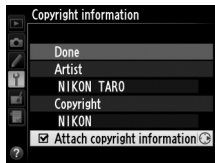
Add a comment to new photographs as they are taken. Comments can be viewed as metadata in ViewNX 2 (supplied) or Capture NX 2 (available separately; □ 325). The comment is also visible on the shooting data page in the photo information display (□ 193).

- **Done:** Save changes and return to the setup menu.
- **Input comment:** Input a comment as described on page 107. Comments can be up to 36 characters long.
- **Attach comment:** Select this option to attach the comment to all subsequent photographs. **Attach comment** can be turned on and off by highlighting it and pressing ►.



Add copyright information to new photographs as they are taken. Copyright information is included in the shooting data shown in the photo information display (□ 193) and can be viewed as metadata in ViewNX 2 (supplied) or in Capture NX 2 (available separately; □ 325).

- **Done:** Save changes and return to the setup menu.
- **Artist:** Enter a photographer name as described on page 107. Photographer names can be up to 36 characters long.
- **Copyright:** Enter the name of the copyright holder as described on page 107. Copyright holder names can be up to 54 characters long.
- **Attach copyright information:** Select this option to attach copyright information to all subsequent photographs. **Attach copyright information** can be turned on and off by highlighting it and pressing ►.



✔ Copyright Information

To prevent unauthorized use of the artist or copyright holder names, make sure that **Attach copyright information** is not selected and that the **Artist** and **Copyright** fields are blank before lending or transferring the camera to another person. Nikon does not accept liability for any damages or disputes arising from the use of the **Copyright information** option.



Select **Save settings** to save the following settings to the memory card (if the card is full, an error will be displayed). Use this option to share settings among Df cameras.

Menu	Option
Playback	Playback display options
	Image review
	After delete
	Rotate tall
Shooting (all banks)	Shooting menu bank
	File naming
	Image quality
	Image size
	Image area
	JPEG compression
	NEF (RAW) recording
	White balance (with fine-tuning and presets d-1–d-4)
	Set Picture Control
	Color space
	Active D-Lighting
	Vignette control
	Auto distortion control
	Long exposure NR
High ISO NR	
Auto ISO sensitivity control	



Menu	Option
Custom settings (all banks)	All Custom Settings
Setup	Auto info display
	Clean image sensor
	Flicker reduction
	Time zone and date (excepting date and time)
	Language
	Auto image rotation
	Image comment
	Copyright information
	Non-CPU lens data
	HDMI
	Location data
	Assign remote Fn button
	Wireless mobile adapter
Eye-Fi upload	
My Menu/ Recent Settings	All My Menu items
	All recent settings
	Choose tab

Settings saved using this model of camera can be restored by selecting **Load settings**. Note that **Save/load settings** is only available when a memory card is inserted in the camera, and that the **Load settings** option is only available if the card contains saved settings.

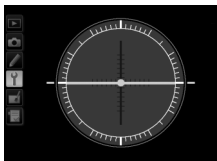


Saved Settings

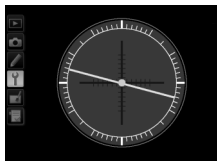
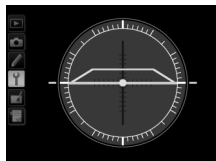
Settings are saved in a file named NCSETUPD. The camera will not be able to load settings if the file name is changed.



Display roll and pitch information based on information from the camera tilt sensor. If the camera is tilted neither left nor right, the roll reference line will turn green, while if the camera is tilted neither forward nor back, the dot in the center of the display will turn green. Each division is equivalent to 5°.



Camera level

Camera tilted left or
rightCamera tilted
forward or back

✓ Tilting the Camera

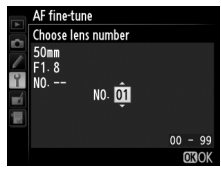
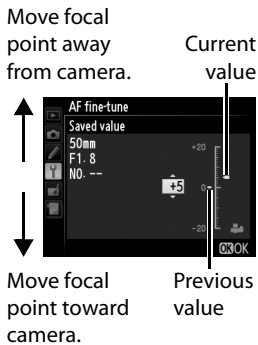
The virtual horizon display is not accurate when the camera is tilted at a sharp angle forward or back. If the camera is unable to measure tilt, the amount of tilt will not be displayed.

✎ See Also

For information on viewing a roll indicator in the viewfinder, see Custom Setting f4 (**Assign Fn button**; 📖 263, 265). For information on displaying a virtual horizon in live view, see page 182.

Fine-tune focus for up to 12 lens types. AF tuning is not recommended in most situations and may interfere with normal focus; use only when required.

Option	Description
AF fine-tune (On/Off)	<ul style="list-style-type: none"> • On: Turn AF tuning on. • Off: Turn AF tuning off.
Saved value	<p>Tune AF for the current lens (CPU lenses only). Press ▲ or ▼ to choose a value between +20 and -20. Values for up to 12 lens types can be stored. Only one value can be stored for each type of lens.</p>
Default	<p>Choose the AF tuning value used when no previously saved value exists for the current lens (CPU lenses only).</p>
List saved values	<p>List previously saved AF tuning values. To delete a lens from the list, highlight the desired lens and press . To change a lens identifier (for example, to choose an identifier that is the same as the last two digits of the lens serial number to distinguish it from other lenses of the same type in light of the fact that Saved value can be used with only one lens of each type), highlight the desired lens and press ►.</p> <p>The menu shown at right will be displayed; press ▲ or ▼ to choose an identifier and press to save changes and exit.</p>



✓ AF Tuning

The camera may be unable to focus at minimum range or at infinity when AF tuning is applied.


✓ Live View

Tuning is not applied to autofocus during live view.

✍ Saved Value

Only one value can be stored for each type of lens. If a teleconverter is used, separate values can be stored for each combination of lens and teleconverter.


Assign Remote Fn Button

MENU button →  setup menu

Choose the role played by the **Fn** buttons on optional WR-1 and WR-T10 (□ 325) wireless remote controllers.



Wireless Mobile Adapter

MENU button →  setup menu

Choose whether the camera will establish wireless connections with smart devices when an optional WU-1a wireless mobile adapter (□ 324) is attached to the camera USB connector.







Option	Description
Enable	Enable wireless connections to smart devices running the Wireless Mobile Utility.
Disable	Disable wireless connections to smart devices. Choose this option in locations where the use of wireless devices is prohibited. Selecting this option also reduces the drain on the camera battery.

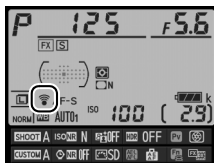


This option is displayed only when an Eye-Fi memory card (available separately from third-party suppliers) is inserted in the camera. Choose **Enable** to upload photographs to a preselected destination. Note that pictures will not be uploaded if signal strength is insufficient.

Observe all local laws concerning wireless devices and choose **Disable** where wireless devices are prohibited.

When an Eye-Fi card is inserted, its status is indicated by an icon in the information display:

- : Eye-Fi upload disabled.
- : Eye-Fi upload enabled but no pictures available for upload.
-  (static): Eye-Fi upload enabled; waiting to begin upload.
-  (animated): Eye-Fi upload enabled; uploading data.
- : Error — camera can not control Eye-Fi card. If a flashing  appears in the control panel or viewfinder, refer to page 349; if this indicator is not flashing, pictures can be taken normally but you may be unable to change Eye-Fi settings.



Eye-Fi Cards

Eye-Fi cards may emit wireless signals when **Disable** is selected. If a warning is displayed in the monitor (☐ 349), turn the camera off and remove the card.


See the manual provided with the Eye-Fi card, and direct any inquiries to the manufacturer. The camera can be used to turn Eye-Fi cards on and off, but may not support other Eye-Fi functions.

Some cards may not be available in some countries or regions; consult the manufacturer for more information. Eye-Fi cards are for use only in the country of purchase. Be sure the Eye-Fi card firmware has been updated to the latest version.

Using Eye-Fi Cards in Ad Hoc Mode

Additional time may be required when connecting using Eye-Fi cards that support ad hoc mode. Set Custom Setting c2 (**Standby timer**, ☐ 251) to 30 s or longer.


Firmware Version

MENU button →  setup menu

View the current camera firmware version.
























The Retouch Menu: Creating Retouched Copies


To display the retouch menu, press **MENU** and select the  (retouch menu) tab.




MENU button

The options in the retouch menu are used to create trimmed or retouched copies of existing pictures. The retouch menu is only displayed when a memory card containing photographs is inserted in the camera.

Option		Option	
 D-Lighting	291	 Straighten	304
 Red-eye correction	292	 Distortion control	305
 Trim	293	 Fisheye	305
 Monochrome	294	 Color outline	306
 Filter effects	295	 Color sketch	306
 Color balance	296	 Perspective control	307
 Image overlay ¹	297	 Miniature effect	308
 NEF (RAW) processing	300	 Selective color	309
 Resize	302	 Side-by-side comparison ²	311
 Quick retouch	304		

1 Can only be selected by pressing **MENU** and selecting  tab.

2 Only available if  is pressed in full-frame playback when a retouched image or original is displayed.



Retouching Copies

Most options can be applied to copies created using other retouch options, although (with the exception of **Image overlay**) each option can be applied only once (note that multiple edits may result in loss of detail). Options that can not be applied to the current image are grayed out and unavailable.

Image Quality

Except in the case of copies created with **Trim**, **Image overlay**, **NEF (RAW) processing**, and **Resize**, copies created from JPEG images are the same size and quality as the original, while copies created from NEF (RAW) photos are saved as large fine-quality JPEG images, and copies created from TIFF (RGB) photos are saved as fine-quality JPEG images of the same size as the original. Size-priority compression is used when copies are saved in JPEG format.

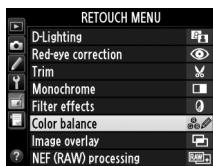


Creating Retouched Copies

To create a retouched copy:

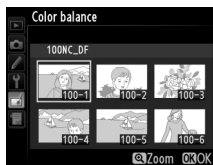
1 Select an item in the retouch menu.

Press ▲ or ▼ to highlight an item, ► to select.



2 Select a picture.

Highlight a picture and press **OK**. To view the highlighted picture full screen, press and hold the **QUAL** button.

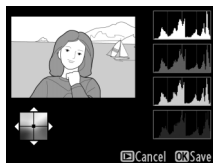


Retouch

In the case of images recorded at image quality settings of NEF + JPEG (□ 56), only the NEF (RAW) image will be retouched. The camera may not be able to display or retouch images created with other devices.

3 Select retouch options.

For more information, see the section for the selected item. To exit without creating a retouched copy, press **MENU**.




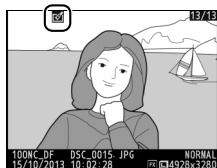
Monitor off Delay

The monitor will turn off and the operation will be cancelled if no actions are performed for a brief period. Any unsaved changes will be lost. To increase the time the monitor remains on, choose a longer menu display time for Custom Setting c4 (**Monitor off delay**; □ 253).



4 Create a retouched copy.

Press **OK** to create a retouched copy. Retouched copies are indicated by a  icon.



Creating Retouched Copies During Playback

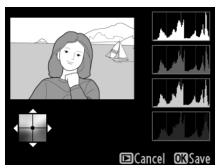
Retouched copies can also be created during playback.



Display picture full frame and press **Z**.



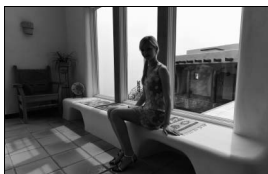
Highlight an option and press **OK**.



Create retouched copy.



D-lighting brightens shadows, making it ideal for dark or backlit photographs.

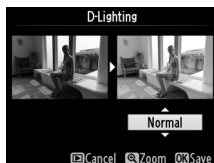


Before











After

Press ▲ or ▼ to choose the amount of correction performed. The effect can be previewed in the edit display. Press **OK** to copy the photograph.










This option is used to correct “red-eye” caused by the flash, and is available only with photographs taken using the flash. The photograph selected for red-eye correction can be previewed in the edit display. Confirm the effects of red-eye correction and create a copy as described in the following table. Note that red-eye correction may not always produce the expected results and may in very rare circumstances be applied to portions of the image that are not affected by red-eye; check the preview thoroughly before proceeding.


To	Use	Description
Zoom in	 (QUAL)	Press  (QUAL) to zoom in,  (⚡) to zoom out. While photo is zoomed in, use multi selector to view areas of image not visible in monitor. Keep multi selector pressed to scroll rapidly to other areas of frame. Navigation window is displayed when zoom buttons or multi selector is pressed; area currently visible in monitor is indicated by yellow border. Press  to cancel zoom.
Zoom out	 (⚡)	
View other areas of image		
Cancel zoom	 (OK)	
Create copy	 (OK)	If the camera detects red-eye in the selected photograph, a copy will be created that has been processed to reduce its effects. No copy will be created if the camera is unable to detect red-eye.

Create a cropped copy of the selected photograph. The selected photograph is displayed with the selected crop shown in yellow; create a cropped copy as described in the following table.



To	Use	Description
Reduce size of crop		Press  to reduce the size of the crop.
Increase size of crop	 (QUAL)	Press  (QUAL) to increase the size of the crop.
Change crop aspect ratio		Rotate the main command dial to switch between aspect ratios of 3 : 2, 4 : 3, 5 : 4, 1 : 1, and 16 : 9.
Position crop		Use multi selector to position the crop. Press and hold to move the crop rapidly to the desired position.
Create copy		Save the current crop as a separate file.

Trim: Image Quality and Size

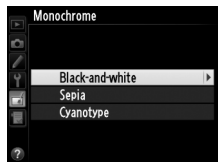
Copies created from NEF (RAW), NEF (RAW) + JPEG, or TIFF (RGB) photos have an image quality ( 55) of JPEG fine; cropped copies created from JPEG photos have the same image quality as the original. The size of the copy varies with crop size and aspect ratio and appears at upper left in the crop display.



Viewing Cropped Copies

Playback zoom may not be available when cropped copies are displayed.

Copy photographs in **Black-and-white**, **Sepia**, or **Cyanotype** (blue and white monochrome).

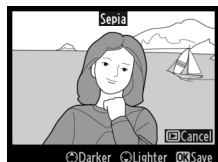


Selecting **Sepia** or **Cyanotype** displays a preview of the selected image; press ▲ to increase color saturation, ▼ to decrease. Press **OK** to create a monochrome copy.



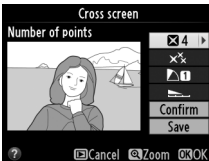
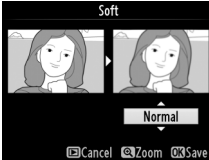

Increase saturation




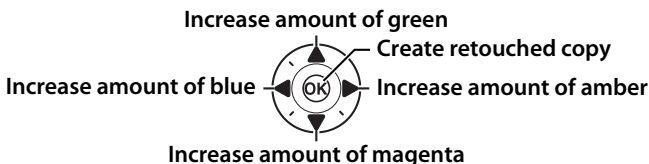
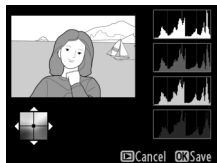
Decrease saturation



Choose from the following filter effects. After adjusting filter effects as described below, press **OK** to copy the photograph.

Option	Description
Skylight	Creates the effect of a skylight filter, making the picture less blue. The effect can be previewed in the monitor as shown at right. 
Warm filter	Creates a copy with warm tone filter effects, giving the copy a “warm” red cast. The effect can be previewed in the monitor. 
Red intensifier Green intensifier Blue intensifier	Intensify reds (Red intensifier), greens (Green intensifier), or blues (Blue intensifier). Press ▲ to increase the effect, ▼ to decrease. 
Cross screen	Add starburst effects to light sources. <ul style="list-style-type: none"> • Number of points: Choose from four, six, or eight. • Filter amount: Choose the brightness of the light sources affected. • Filter angle: Choose the angle of the points. • Length of points: Choose the length of points. • Confirm: Preview the effects of the filter. Press QUAL to preview the copy full frame. • Save: Create a retouched copy. 
Soft	Add a soft filter effect. Press ▲ or ▼ to choose the filter strength. 

Use the multi selector to create a copy with modified color balance as shown below. The effect is displayed in the monitor together with red, green, and blue histograms ( 192) giving the distribution of tones in the copy.



Zoom






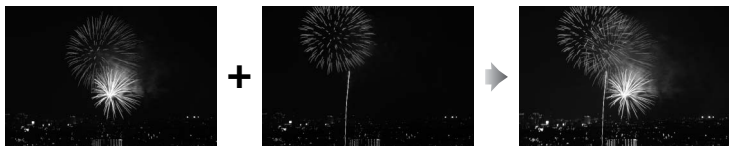

To zoom in on the image displayed in the monitor, press  (**QUAL**). The histogram will be updated to show data only for the portion of the image displayed in the monitor. While the image is zoomed in, press  (**WB**) to toggle back and forth between color balance and zoom. When zoom is selected, you can zoom in and out with the  (**QUAL**) and  (**WB**) and scroll the image with the multi selector.

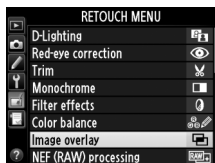



Image overlay combines two existing NEF (RAW) photographs to create a single picture that is saved separately from the originals; the results, which make use of RAW data from the camera image sensor, are noticeably better than overlays created in an imaging application. The new picture is saved at current image quality and size settings; before creating an overlay, set image quality and size ( 55, 58; all options are available). To create a NEF (RAW) copy, choose an image quality of **NEF (RAW)**.

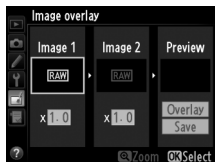


1 Select Image overlay.

Highlight **Image overlay** in the retouch menu and press .

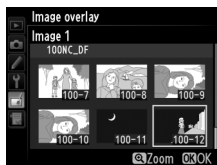


The dialog shown at right will be displayed, with **Image 1** highlighted; press  to display a list of the NEF pictures created with this camera.



2 Select the first image.

Use the multi selector to highlight the first photograph in the overlay. To view the highlighted photograph full frame, press and hold the **QUAL** button. Press **OK** to select the highlighted photograph and return to the preview display.



3 Select the second image.

The selected image will appear as **Image 1**. Highlight **Image 2** and press **OK**, then select the second photo as described in Step 2.

4 Adjust gain.

Highlight **Image 1** or **Image 2** and optimize exposure for the overlay by pressing **▲** or **▼** to select gain from values between 0.1 and 2.0. Repeat for the second image. The default value is 1.0; select 0.5 to halve gain or 2.0 to double it. The effects are visible in the **Preview** column.



5 Preview the overlay.

Press **◀** or **▶** to place the cursor in the **Preview** column and press **▲** or **▼** to highlight **Overlay**. Press **OK** to preview the overlay as shown at right (to save the overlay without displaying a preview, select **Save**). To return to Step 4 and select new photos or adjust gain, press **Q** (**⚡**).



6 Save the overlay.

Press **OK** while the preview is displayed to save the overlay. After an overlay is created, the resulting image will be displayed full-frame in the monitor.



Image Overlay

Only NEF (RAW) photographs with the same image area and bit depth can be combined.


The overlay has the same photo info (including date of recording, metering, shutter speed, aperture, exposure mode, exposure compensation, focal length, and image orientation), and values for white balance and Picture Control as the photograph selected for **Image 1**. The current image comment is appended to the overlay when it is saved; copyright information, however, is not copied. Overlays saved in NEF (RAW) format use the compression selected for **Type** in the **NEF (RAW) recording** menu and have the same bit depth as the original images; JPEG overlays are saved using size-priority compression.

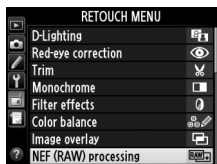


Create JPEG copies of NEF (RAW) photographs.



1 Select NEF (RAW) processing.

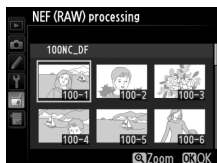
Highlight **NEF (RAW)**

processing in the retouch menu and press  to display a picture selection dialog listing only NEF (RAW) images created with this camera.



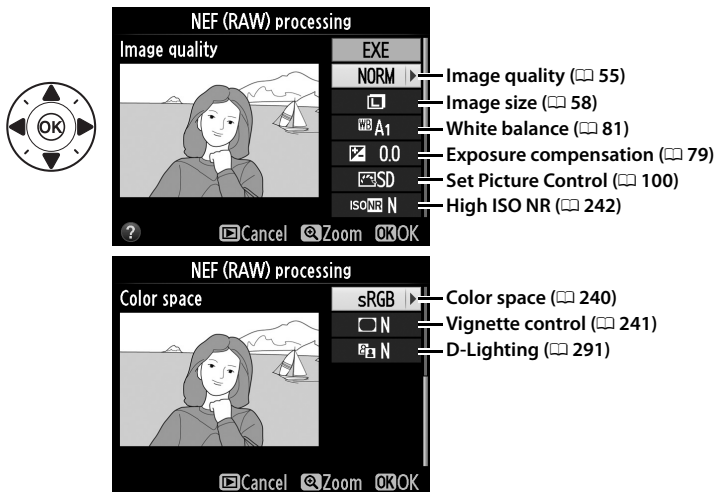
2 Select a photograph.

Highlight a photograph (to view the highlighted photograph full frame, press and hold the  (**QUAL**) button). Press  to select the highlighted photograph and proceed to the next step.



3 Choose settings for the JPEG copy.

Adjust the settings listed below. Note that white balance and vignette control are not available with multiple exposures or pictures created with image overlay and that exposure compensation can only be set to values between -2 and $+2$ EV. The Picture Control grid is not displayed when Picture Controls are adjusted.



4 Copy the photograph.

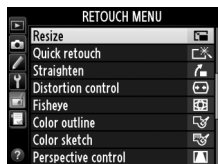
Highlight **EXE** and press **OK** to create a JPEG copy of the selected photograph (to exit without copying the photograph, press the **MENU** button).



Create small copies of selected photographs.

1 Select Resize.

To resize selected images, press **MENU** to display the menus and select **Resize** in the retouch menu.

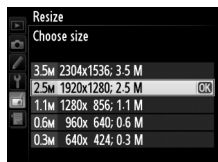


2 Choose a size.

Highlight **Choose size** and press **▶**.

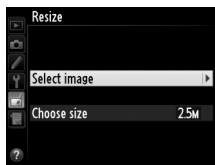


The options shown at right will be displayed; highlight an option and press **OK**.

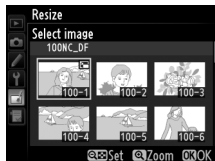


3 Choose pictures.

Highlight **Select image** and press **▶**.



The dialog shown at right will be displayed; highlight pictures using the multi selector and press the **Ⓜ** (**⚡**) button to select or deselect (to view the highlighted picture full screen,



press and hold the **Ⓜ** (**QUAL**) button). Selected pictures are marked by a **☑** icon. Press **OK** when the selection is complete.

4 Save the resized copies.

A confirmation dialog will be displayed. Highlight **Yes** and press **OK** to save the resized copies.



Viewing Resized Copies

Playback zoom may not be available when resized copies are displayed.

Image Quality

Copies created from NEF (RAW), NEF (RAW) + JPEG, or TIFF (RGB) photos have an image quality (☐ 55) of JPEG fine; copies created from JPEG photos have the same image quality as the original.

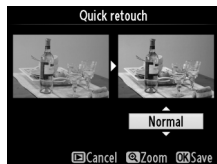


Quick Retouch

MENU button →  retouch menu


Create copies with enhanced saturation and contrast. D-Lighting is applied as required to brighten dark or backlit subjects.

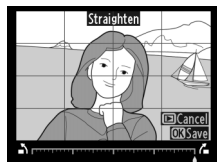
Press ▲ or ▼ to choose the amount of enhancement. The effect can be previewed in the edit display. Press **OK** to copy the photograph.



Straighten

MENU button →  retouch menu

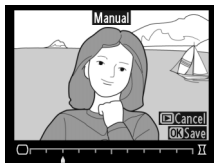
Create a straightened copy of the selected image. Press ► to rotate the image clockwise by up to five degrees in increments of approximately 0.25 degrees, ◀ to rotate it counterclockwise (the effect can be previewed in the edit display; note that edges of the image will be trimmed to create a square copy). Press **OK** to copy the photograph, or press  to exit to playback without creating a copy.



Distortion Control

MENU button →  retouch menu

Create copies with reduced peripheral distortion. Select **Auto** to let the camera correct distortion automatically and then make fine adjustments using the multi-selector, or select **Manual** to reduce distortion manually (note that **Auto** is not available with photos taken using auto distortion control; see page 241). Press **▶** to reduce barrel distortion, **◀** to reduce pin-cushion distortion (the effect can be previewed in the edit display; note that greater amounts of distortion control result in more of the edges being cropped out). Press **⊗** to copy the photograph, or press **▶** to exit to playback without creating a copy. Note that distortion control may heavily crop or distort the edges of copies created from photographs taken with DX lenses at an image area setting of **FX (36x24) 1.0x**.



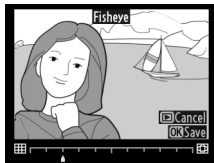
Auto

Auto is for use only with pictures taken with type G, E, and D lenses (PC, fisheye, and certain other lenses excluded). Results are not guaranteed with other lenses.

Fisheye

MENU button →  retouch menu

Create copies that appear to have been taken with a fisheye lens. Press **▶** to increase the effect (this also increases the amount of that will be cropped out at the edges of the image), **◀** to reduce it. The effect can be previewed in the edit display. Press **⊗** to copy the photograph, or press **▶** to exit to playback without creating a copy.



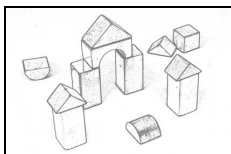
Color Outline

MENU button →  retouch menu

Create an outline copy of a photograph to use as a base for painting. The effect can be previewed in the edit display. Press **OK** to copy the photograph.



Before



After



Color Sketch

MENU button →  retouch menu

Create a copy of a photograph that resembles a sketch made with colored pencils. Press **▲** or **▼** to highlight **Vividness** or **Outlines** and press **◀** or **▶** to change. Vividness can be increased to make colors more saturated, or decreased for a washed-out, monochromatic effect, while outlines can be made thicker or thinner. Thicker outlines makes colors more saturated. The results can be previewed in the edit display. Press **OK** to copy the photograph, or press **▶** to exit to playback without creating a copy.



Create copies that reduce the effects of perspective taken from the base of a tall object. Use the multi selector to adjust perspective (note that greater amounts of perspective control result in more of the edges being cropped out). The results can be previewed in the edit display. Press **OK** to copy the photograph, or press **▶** to exit to playback without creating a copy.












Before

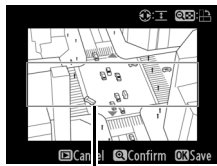


After

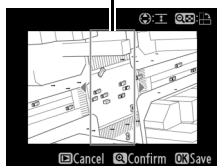


Create a copy that appears to be a photo of a diorama. Works best with photos taken from a high vantage point. The area that will be in focus in the copy is indicated by a yellow frame.

To	Press	Description
Choose orientation		Press  to choose orientation of area that is in focus.
Choose position		If area of effect is in wide orientation, press ▲ or ▼ to position frame showing area of copy that will be in focus.
		If area of effect is in tall orientation, press ◀ or ▶ to position frame showing area of copy that will be in focus.
Choose size		If area of effect is in wide orientation, press ◀ or ▶ to choose height.
		If area of effect is in tall orientation, press ▲ or ▼ to choose width.
Preview copy	 (QUAL)	Preview copy.
Cancel		Exit to playback without creating copy.
Create copy		Create copy.



Area in focus



Create a copy in which only selected hues appear in color.

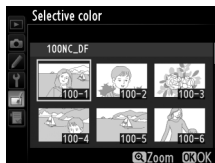
1 Select Selective color.

Highlight **Selective color** in the retouch menu and press to display a picture selection dialog.



2 Select a photograph.

Highlight a photograph (to view the highlighted photograph full frame, press and hold the (QUAL) button). Press to select the highlighted photograph and proceed to the next step.



3 Select a color.

Use the multi selector to position the cursor over an object and press the **AE-L/AF-L** button to select the color of the object as one that will remain in the final copy (the camera may have



AE-L/AF-L button

difficulty detecting unsaturated colors; choose a saturated color). To zoom in on the picture for precise color selection, press (QUAL). Press () to zoom out.

Selected color



4 Highlight the color range.

Rotate the main command dial to highlight the color range for the selected color.



Color range





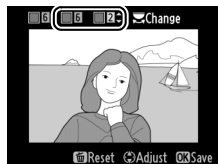
5 Choose the color range.

Press ▲ or ▼ to increase or decrease the range of similar hues that will be included in the final photograph. Choose from values between 1 and 7; note that higher values may include hues from other colors. The effect can be previewed in the edit display.




6 Select additional colors.

To select additional colors, rotate the main command dial to highlight another of the three color boxes at the top of the display and repeat Steps 3–5 to select another color. Repeat for a third color if desired. To deselect the highlighted color, press , or press and hold  to remove all colors. A confirmation dialog will be displayed; select **Yes**.



7 Save the edited copy.


Press  to copy the photograph.

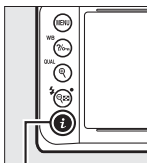


Side-by-side Comparison

Compare retouched copies to the original photographs. This option is only available if **i** button is pressed to display the retouch menu when a copy or original is played back full frame.

1 Select a picture.

In full-frame playback, select a retouched copy (shown by a ) or a photograph that has been retouched and press **i**.



i button



2 Select Side-by-side comparison.

Highlight **Side-by-side comparison** and press **OK**.

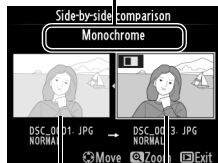


3 Compare the copy with the original.

The source image is displayed on the left, the retouched copy on the right, with the options used to create the copy listed at the top of the display. Press ◀ or ▶ to switch between the source image and the retouched copy. To view the highlighted picture full frame, press and hold the **QUAL** button. If the copy was created from two source images using **Image overlay**, or if the source has been copied multiple times, press ▲ or ▼ to view the other source images or copies. To exit to playback mode, press the ▶ button, or press **OK** to exit to playback with the highlighted image selected.



Options used to create copy



Source image


Retouched copy

✔ Side-by-side Comparisons

The source image will not be displayed if the copy was created from a photograph that was protected (🔒 201), has since been deleted or hidden (🔒 230).




My Menu / Recent Settings

To display My Menu, press **MENU** and select the  (My Menu) tab.



MENU button

The **MY MENU** option can be used to create and edit a customized list of options from the playback, shooting, Custom Settings, setup, and retouch menus for quick access (up to 20 items). If desired, recent settings can be displayed in place of My Menu ( 317).

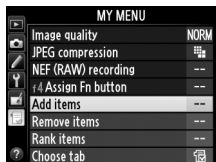
Options can be added, deleted, and reordered as described on the following pages.



■ Adding Options to My Menu

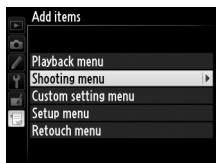
1 Select Add items.

In My Menu (☰), highlight **Add items** and press **▶**.



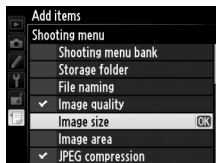
2 Select a menu.

Highlight the name of the menu containing the option you wish to add and press **▶**.



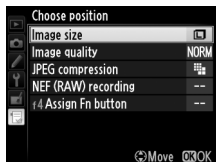
3 Select an item.

Highlight the desired menu item and press **OK**.




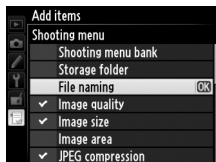
4 Position the new item.

Press **▲** or **▼** to move the new item up or down in My Menu. Press **OK** to add the new item.



5 Add more items.

The items currently displayed in My Menu are indicated by a check mark. Items indicated by a  icon can not be selected. Repeat steps 1–4 to select additional items.



■ Deleting Options from My Menu

1 Select Remove items.

In My Menu (☰), highlight **Remove items** and press ►.

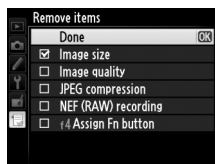
2 Select items.

Highlight items and press ► to select or deselect. Selected items are indicated by a check mark.



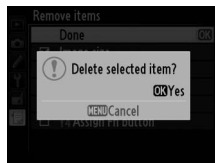
3 Select Done.

Highlight **Done** and press OK. A confirmation dialog will be displayed.



4 Delete the selected items.

Press OK to delete the selected items.



Deleting Items in My Menu

To delete the item currently highlighted in My Menu, press the ☰ button. A confirmation dialog will be displayed; press ☰ again to remove the selected item from My Menu.



■ Reordering Options in My Menu

1 Select Rank items.

In My Menu (☰), highlight **Rank items** and press ►.

2 Select an item.

Highlight the item you wish to move and press OK.



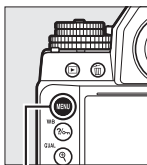
3 Position the item.

Press ▲ or ▼ to move the item up or down in My Menu and press OK. Repeat Steps 2–3 to reposition additional items.

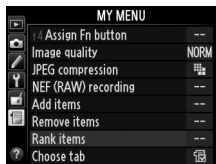


4 Exit to My Menu.



Press the MENU button to return to My Menu.





MENU button

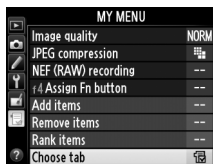


Recent Settings



To display the twenty most recently used settings, select  **RECENT SETTINGS** for  **MY MENU** > **Choose tab**.

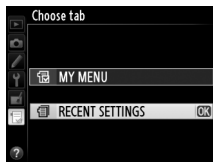
1 Select **Choose tab**.



In My Menu () , highlight **Choose tab** and press .





2 Select **RECENT SETTINGS**.

Highlight  **RECENT SETTINGS** and press . The name of the menu will change from "MY MENU" to "RECENT SETTINGS."



Menu items will be added to the top of the recent settings menu as they are used. To view My Menu again, select  **MY MENU** for  **RECENT SETTINGS** > **Choose tab**.

Removing Items from the Recent Settings Menu

To remove an item from the recent settings menu, highlight it and press the  button. A confirmation dialog will be displayed; press  again to delete the selected item.



Technical Notes

Read this chapter for information on compatible accessories, cleaning and storing the camera, and what to do if an error message is displayed or you encounter problems using the camera.

Compatible Lenses

Camera setting Lens/accessory		Focus mode			Exposure mode		Metering system		
		AF	M (with electronic rangefinder)	M	P S	A M	☒		☒
							3D	Color	☐
CPU lenses ¹	Type G, E, or D AF NIKKOR ² AF-S, AF-I NIKKOR	✓	✓	✓	✓	✓	✓	—	✓ ³
	PC-E NIKKOR series ⁴	—	✓ ⁵	✓	✓ ⁵	✓ ⁵	✓ ⁵	—	✓ ^{3,5}
	PC Micro 85mm f/2.8D ⁶	—	✓ ⁵	✓	—	✓ ⁷	✓	—	✓ ^{3,5}
	AF-S / AF-I Teleconverter ⁸	✓	✓	✓	✓	✓	✓	—	✓ ³
	Other AF NIKKOR (except lenses for F3AF)	✓ ⁹	✓ ⁹	✓	✓	✓	—	✓	✓ ³
	AI-P NIKKOR	—	✓ ¹⁰	✓	✓	✓	—	✓	✓ ³
Non-CPU lenses ¹¹	AI-, AI-modified, NIKKOR or Nikon Series E lenses ¹²	—	✓ ¹⁰	✓	—	✓ ¹³	—	✓ ¹⁴	✓ ¹⁵
	Non-AI lenses	—	✓ ¹⁰	✓	—	✓ ¹⁶	—	✓ ¹⁶	✓ ¹⁵
	Medical-NIKKOR 120mm f/4	—	✓	✓	—	✓ ¹⁷	—	—	—
	Reflex-NIKKOR	—	—	✓	—	✓ ¹³	—	—	✓ ¹⁵
	PC-NIKKOR	—	✓ ⁵	✓	—	✓ ¹⁸	—	—	✓
	AI-type Teleconverter ¹⁹	—	✓ ²⁰	✓	—	✓ ¹³	—	✓ ¹⁴	✓ ¹⁵
	PB-6 Bellows Focusing Attachment ²¹	—	✓ ²⁰	✓	—	✓ ²²	—	—	✓
Auto extension rings (PK-series 11A, 12, or 13; PN-11)	—	✓ ²⁰	✓	—	✓ ¹³	—	—	✓	

- 1 IX-NIKKOR lenses can not be used.
- 2 Vibration Reduction (VR) supported with VR lenses.
- 3 Spot metering meters selected focus point (☐ 75).
- 4 Observe due caution when tilting or shifting PC-E NIKKOR 24mm f/3.5D ED lenses, as they may contact the camera body and cause damage or injury.
- 5 Can not be used with shifting or tilting.

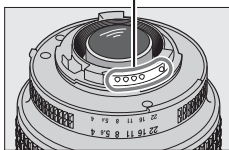
- 6 The camera's exposure metering and flash control systems do not work properly when shifting and/or tilting the lens, or when an aperture other than the maximum aperture is used.
 - 7 Manual exposure mode only.
 - 8 Can be used with AF-S and AF-I lenses only (□ 321). For information on the focus points available for autofocus and electronic rangefinding, see page 321.
 - 9 When focusing at minimum focus distance with AF 80–200mm f/2.8, AF 35–70mm f/2.8, AF 28–85mm f/3.5–4.5 <New>, or AF 28–85mm f/3.5–4.5 lens at maximum zoom, in-focus indicator may be displayed when image on matte screen in viewfinder is not in focus. Adjust focus manually until image in viewfinder is in focus.
 - 10 With maximum aperture of f/5.6 or faster.
 - 11 Some lenses can not be used (see page 320).
 - 12 Range of rotation for AI 80–200mm f/2.8 ED tripod mount is limited by camera body. Filters can not be exchanged while AI 200–400mm f/4 ED is mounted on camera.
 - 13 If maximum aperture is specified using **Non-CPU lens data** (□ 163), aperture value will be displayed in viewfinder and control panel.
 - 14 Can be used only if lens focal length and maximum aperture are specified using **Non-CPU lens data** (□ 163). Use spot or center-weighted metering if desired results are not achieved.
 - 15 For improved precision, specify lens focal length and maximum aperture using **Non-CPU lens data** (□ 163).
 - 16 Can be used only if **Non-CPU lens data** (□ 163) has been used to specify lens focal length and maximum aperture and to set exposure meter coupling to **Non-AI lens** (□ 167). Match camera aperture setting to value selected with lens aperture ring.
 - 17 Can be used in manual exposure mode at shutter speeds slower than flash sync speed by one step or more.
 - 18 Exposure determined by presetting lens aperture. In aperture-priority auto exposure mode, preset aperture using lens aperture ring before performing AE lock and shifting lens. In manual exposure mode, preset aperture using lens aperture ring and determine exposure before shifting lens.
 - 19 Exposure compensation required when used with AI 28–85mm f/3.5–4.5, AI 35–105mm f/3.5–4.5, AI 35–135mm f/3.5–4.5, or AF-S 80–200mm f/2.8D. See teleconverter manual for details.
 - 20 With maximum effective aperture of f/5.6 or faster.
 - 21 Requires PK-12 or PK-13 auto extension ring. PB-6D may be required depending on camera orientation.
 - 22 Use preset aperture. In aperture-priority auto exposure mode, set aperture using focusing attachment before determining exposure and taking photograph.
- PF-4 Reprocopy Outfit requires PA-4 Camera Holder.
 - Noise in the form of lines may appear during autofocus at high ISO sensitivities. Use manual focus or focus lock.



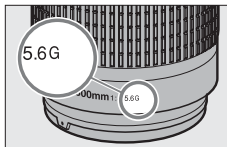
✎ Recognizing CPU and Type G, E, and D Lenses

CPU lenses (particularly types G, E, and D) are recommended, but note that IX-NIKKOR lenses can not be used. CPU lenses can be identified by the presence of CPU contacts, type G, E, and D lenses by a letter on the lens barrel. Type G and E lenses are not equipped with a lens aperture ring.

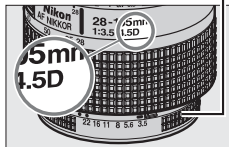
CPU contacts



CPU lens



Type G/E lens



Type D lens

Aperture ring

✎ Lens f-number

The f-number given in lens names is the maximum aperture of the lens.

✎ Incompatible Accessories and Non-CPU Lenses








The following can NOT be used with the Df:

- TC-16AS AF teleconverter
- Lenses that require the AU-1 focusing unit (400mm f/4.5, 600mm f/5.6, 800mm f/8, 1200mm f/11)
- Fisheye (6mm f/5.6, 7.5mm f/5.6, 8mm f/8, OP 10mm f/5.6)
- 2.1cm f/4
- Extension Ring K2
- AF lenses for the F3AF (AF 80mm f/2.8, AF 200mm f/3.5 ED, AF Teleconverter TC-16)
- PC 35mm f/3.5 (old type)
- Reflex 1000mm f/6.3 (old type)
- NIKKOR-H Auto 2.8cm/3.5 (28mm/3.5) lenses with serial numbers below 362000
- NIKKOR-S Auto 3.5cm/2.8 (35mm/2.8) lenses with serial numbers below 928000
- NIKKOR-S Auto 5cm/2 (50mm/2)
- NIKKOR-Q Auto 13.5cm/3.5 (135mm/3.5) lenses with serial numbers below 753000
- Micro-NIKKOR 5.5cm/3.5
- Medical-NIKKOR Auto 200mm/f5.6
- Auto NIKKOR Telephoto-Zoom 85–250mm/f4–4.5
- Auto NIKKOR Telephoto-Zoom 200–600mm/f9.5–10.5

Depending on their condition, individual lenses of other types may not be suitable for use. Do not attempt to forcibly attach a lens that does not mate smoothly with the camera mount.

AF-S/AF-I Teleconverters

The table below shows the focus points available for autofocus and electronic rangefinding when an AF-S/AF-I teleconverter is attached. Note that the camera may be unable to focus on dark or low-contrast subjects if the combined aperture is slower than f/5.6. Autofocus is not available when teleconverters are used with the AF-S VR Micro-Nikkor 105mm f/2.8G IF-ED.

Accessory	Maximum aperture of lens	Focus points	Accessory	Maximum aperture of lens	Focus points
TC-14E, TC-14E II	f/4 or faster		TC-20E, TC-20E II, TC-20E III	f/2.8 or faster	
	f/5.6			f/4	
				f/5.6	— ³
TC-17E II	f/2.8 or faster		TC-800- 1.25E ED	f/5.6	
	f/4				
	f/5.6	— ³			


1 Focus data for focus points other than the center focus point are obtained from line sensors.

2 Single point AF is used when 3D-tracking or auto-area AF is selected for AF-area mode (□ 62).

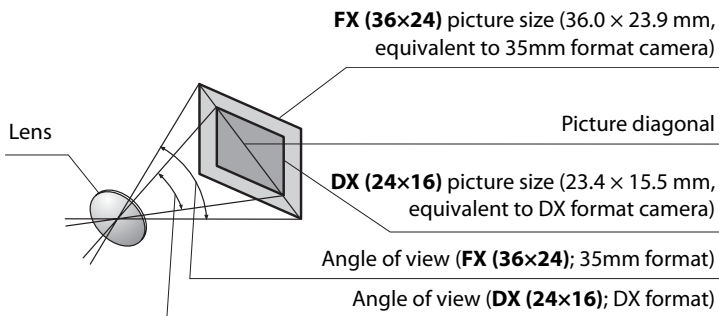
3 Autofocus not available.



Calculating Angle of View

The Df can be used with Nikon lenses for 35mm (135) format cameras. If **Auto DX crop** is on ( 52) and a 35mm format lens is attached, the angle of view will be the same as a frame of 35mm film (36.0×23.9 mm); if a DX lens is attached, the angle of view will automatically be adjusted to 23.4×15.5 mm (DX format).

If a 35 mm format lens is attached, the angle of view can be reduced by 1.5 \times by turning **Auto DX crop** off and selecting **DX (24 \times 16)**.



The **DX (24 \times 16)** angle of view is about 1.5 times smaller than the 35mm format angle of view. To calculate the focal length of lenses in 35mm format when **DX (24 \times 16)** is selected, multiply the focal length of the lens by about 1.5 (for example, the effective focal length of a 50mm lens in 35mm format would be 75 mm when **DX (24 \times 16)** is selected).



Other Accessories

At the time of writing, the following accessories were available for the Df.

Power sources	<ul style="list-style-type: none">• Rechargeable Li-ion Battery EN-EL14a (☞ 18, 19): EN-EL14 batteries can also be used. Additional EN-EL14a batteries are available from local retailers and Nikon-authorized service representatives.• Battery Charger MH-24 (☞ 18): Recharge EN-EL14a and EN-EL14 batteries.• Power Connector EP-5A, AC Adapter EH-5b: These accessories can be used to power the camera for extended periods (EH-5a and EH-5 AC adapters can also be used). The EP-5A is required to connect the camera to the EH-5b; see page 326 for details.
Cable releases	<p>Cable Release AR-3: Attaches to the release socket to help prevent camera shake in close ups or under low light.</p>
Filters	<ul style="list-style-type: none">• Filters intended for special-effects photography may interfere with autofocus or the electronic rangefinder.• The Df can not be used with linear polarizing filters. Use C-PL or C-PL II circular polarizing filters instead.• Use NC filters to protect the lens.• To prevent ghosting, use of a filter is not recommended when the subject is framed against a bright light, or when a bright light source is in the frame.• Center-weighted metering is recommended with filters with exposure factors (filter factors) over 1 × (Y44, Y48, Y52, O56, R60, X0, X1, C-PL, ND2S, ND4, ND4S, ND8, ND8S, ND400, A2, A12, B2, B8, B12). See the filter manual for details.

Availability may vary with country or region. See our website or brochures for the latest information.



Viewfinder eyepiece accessories

- **Rubber Eyecup DK-19:** The DK-19 makes the image in the viewfinder easier to see, preventing eye fatigue.
- **Dioptr-Adjustment Viewfinder Lens DK-17C:** To accommodate individual differences in vision, viewfinder lenses are available with diopters of -3 , -2 , 0 , $+1$, and $+2\text{ m}^{-1}$. Use diopter adjustment lenses only if the desired focus can not be achieved with the built-in diopter adjustment control (-3 to $+1\text{ m}^{-1}$). Test diopter adjustment lenses before purchase to ensure that the desired focus can be achieved.
- **Magnifying Eyepiece DK-17M:** The DK-17M magnifies the view through the viewfinder by approximately $1.2\times$ for greater precision when framing.
- **Eyepiece Magnifier DG-2:** The DG-2 magnifies the scene at the center of the viewfinder for more accurate focus. DK-18 eyepiece adapter (available separately) required.
- **Eyepiece Adapter DK-18:** The DK-18 is used when attaching the DG-2 magnifier or DR-3 right-angle viewing attachment to the Df.
- **Antifog Finder Eyepiece DK-14/Antifog Finder Eyepiece DK-17A:** These viewfinder eyepieces prevent fogging in humid or cold conditions.
- **Right-Angle Viewing Attachment DR-5/Right-Angle Viewing Attachment DR-4:** The DR-5 and DR-4 attach to the viewfinder eyepiece at a right angle, allowing the image in the viewfinder to be viewed from above when the camera is in the horizontal shooting position. The DR-5 supports diopter adjustment and can also magnify the view through the viewfinder by $2\times$ for greater precision when framing (note that the edges of the frame will not be visible when the view is magnified).

Body cap

Body Cap BF-1B/Body Cap BF-1A: The body cap keeps the mirror, viewfinder screen, and low-pass filter free of dust when a lens is not in place.

Wireless mobile adapters

Wireless Mobile Adapter WU-1a: Supports two-way communication between the camera and smart devices running the Wireless Mobile Utility app. Use the Wireless Mobile Utility to take pictures remotely or download existing pictures to the smart device.



Software

- **Capture NX 2:** A complete photo editing package with such advanced editing features as selection control points and an auto retouch brush.
- **Camera Control Pro 2:** Control the camera remotely from a computer to take photos and save them directly to the computer hard disk. When Camera Control Pro 2 is used to capture photographs directly to the computer, a PC connection indicator **P** will appear in the control panel.

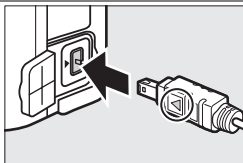
Note: Use the latest versions of Nikon software; see the websites listed on page xvii for the latest information on supported operating systems. At default settings, Nikon Message Center 2 will periodically check for updates to Nikon software and firmware while you are logged in to an account on the computer and the computer is connected to the Internet. A message is automatically displayed when an update is found.

Wireless remote controllers

- **Wireless Remote Controller WR-R10/WR-T10:** When a WR-R10 wireless remote controller is attached to the camera accessory terminal, the camera can be controlled wirelessly using a WR-T10 wireless remote controller.
- **Wireless Remote Controller WR-1:** WR-1 units are used in groups of two or more, with one functioning as a transmitter and the remaining units acting receivers. The receivers are attached to the accessory terminals of one or more cameras, allowing the transmitter to be used to release the camera shutters or adjust settings remotely.

Accessory terminal accessories

The Df is equipped with an accessory terminal for **MC-DC2 remote cords** (☞ 44) and **GP-1 and GP-1A GPS units** (☞ 170), which connect with the ◀ mark on the connector aligned with the ▶ next to the accessory terminal (close the camera connector cover when the terminal is not in use).



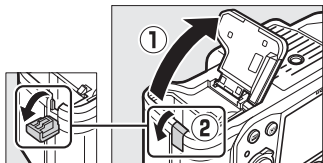
Attaching a Power Connector and AC Adapter

Adapter

Turn the camera off before attaching an optional power connector and AC adapter.

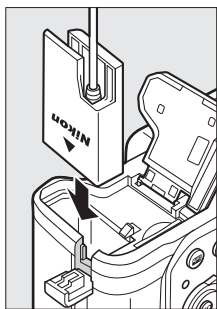
1 Ready the camera.

Open the battery-chamber/ memory card slot (①) and power connector (②) covers.



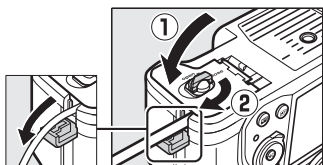
2 Insert the EP-5A power connector.

Be sure to insert the connector in the orientation shown, using the connector to keep the battery latch pressed to one side. The latch locks the connector in place when the connector is fully inserted.




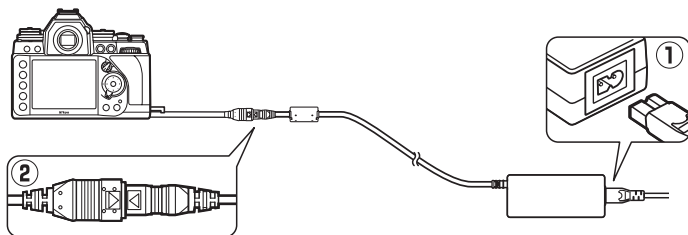
3 Close the battery-chamber/ memory card slot cover.

Position the power connector cable so that it passes through the power connector slot and close the battery-chamber/ memory card slot cover.



4 Connect the EH-5b AC adapter.

Connect the AC adapter power cable to the AC socket on AC adapter (①) and the EP-5A power cable to the DC socket (②). A  icon is displayed in the monitor when the camera is powered by the AC adapter and power connector.



Caring for the Camera

Storage

When the camera will not be used for an extended period, remove the battery and store the battery in a cool, dry area with the terminal cover in place. To prevent mold or mildew, store the camera in a dry, well-ventilated area. Do not store your camera with naphtha or camphor moth balls or in locations that:

- are poorly ventilated or subject to humidities of over 60%
- are next to equipment that produces strong electromagnetic fields, such as televisions or radios
- are exposed to temperatures above 50 °C (122 °F) or below -10 °C (14 °F)

Cleaning

Camera body	Use a blower to remove dust and lint, then wipe gently with a soft, dry cloth. After using the camera at the beach or seaside, wipe off sand or salt with a cloth lightly dampened in distilled water and dry thoroughly. Important: <i>Dust or other foreign matter inside the camera may cause damage not covered under warranty.</i>
Lens, mirror, and viewfinder	These glass elements are easily damaged. Remove dust and lint with a blower. If using an aerosol blower, keep the can vertical to prevent the discharge of liquid. To remove fingerprints and other stains, apply a small amount of lens cleaner to a soft cloth and clean with care.
Monitor	Remove dust and lint with a blower. When removing fingerprints and other stains, wipe the surface lightly with a soft cloth or chamois leather. Do not apply pressure, as this could result in damage or malfunction.

Do not use alcohol, thinner, or other volatile chemicals.



The Low-Pass Filter

The image sensor that acts as the camera's picture element is fitted with a low-pass filter to prevent moiré. If you suspect that dirt or dust on the filter is appearing in photographs, you can clean the filter using the **Clean image sensor** option in the setup menu.

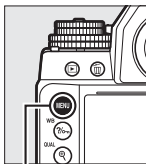
The filter can be cleaned at any time using the **Clean now** option, or cleaning can be performed automatically when the camera is turned on or off.

■ "Clean Now"

1 Select Clean image sensor in the setup menu.

Press the **MENU** button to display the menus.

Highlight **Clean image sensor** in the setup menu and press ►.

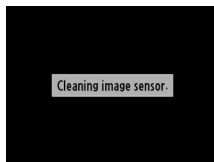


MENU button






2 Select Clean now.

The camera will check the image sensor and then begin cleaning. During cleaning, **buSy** flashes in the control panel and other operations can not be performed. Do not remove or disconnect the power source until cleaning is complete and **buSy** is no longer displayed.



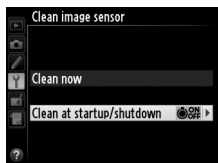
■ “Clean at Startup/Shutdown”

Choose from the following options:


Option	Description
 Clean at startup	The image sensor is automatically cleaned each time the camera is turned on.
 Clean at shutdown	The image sensor is automatically cleaned during shutdown each time the camera is turned off.
 Clean at startup & shutdown	The image sensor is cleaned automatically at startup and at shutdown.
Cleaning off	Automatic image sensor cleaning off.

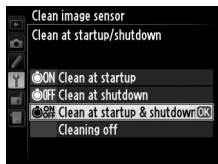
1 Select Clean at startup/ shutdown.

Display the **Clean image sensor** menu as described in Step 2 on the previous page. Highlight **Clean at startup/shutdown** and press ►.



2 Select an option.

Highlight an option and press .



Place the Camera Base Down

Image sensor cleaning is most effective when the camera is placed base down as shown at right.

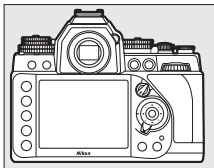


Image Sensor Cleaning

Using camera controls during startup interrupts image sensor cleaning.


Cleaning is performed by vibrating the low-pass filter. If dust can not be fully removed using the options in the **Clean image sensor** menu, clean the image sensor manually or consult a Nikon-authorized service representative.

If image sensor cleaning is performed several times in succession, image sensor cleaning may be temporarily disabled to protect the camera's internal circuitry. Cleaning can be performed again after a short wait.

Manual Cleaning

If foreign matter can not be removed from the low-pass filter using the **Clean image sensor** option in the setup menu (☐ 329), the filter can be cleaned manually as described below. Note, however, that the filter is extremely delicate and easily damaged. Nikon recommends that the filter be cleaned only by Nikon-authorized service personnel.

1 Charge the battery or connect an AC adapter.

A reliable power source is required when inspecting or cleaning the low-pass filter. Turn the camera off and insert a fully-charged battery or connect an optional AC adapter and power connector. The **Lock mirror up for cleaning** option is only available in the setup menu at battery levels over .

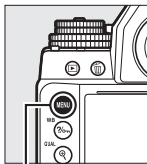
2 Remove the lens.

Turn the camera off and remove the lens.

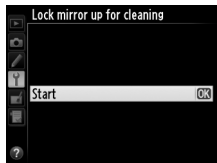


3 Select **Lock mirror up for cleaning.**

Turn the camera on and press the **MENU** button to display the menus. Highlight **Lock mirror up for cleaning** in the setup menu and press ►.

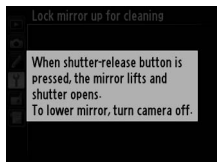


MENU button



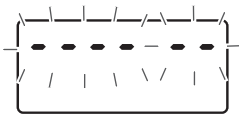
4 Press **OK**.

The message shown at right will be displayed in the monitor and a row of dashes will appear in the control panel and viewfinder. To restore normal operation without inspecting the low-pass filter, turn the camera off.



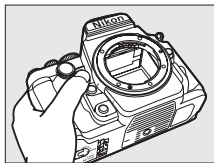
5 Raise the mirror.

Press the shutter-release button all the way down. The mirror will be raised and the shutter curtain will open, revealing the low-pass filter. The display in the viewfinder will turn off and the row of dashes in the control panel will flash.



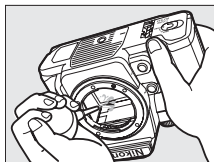
6 Examine the low-pass filter.

Holding the camera so that light falls on the low-pass filter, examine the filter for dust or lint. If no foreign objects are present, proceed to Step 8.



7 Clean the filter.

Remove any dust and lint from the filter with a blower. Do not use a blower-brush, as the bristles could damage the filter. Dirt that can not be removed with a blower can only be removed by Nikon-authorized service personnel. Under no circumstances should you touch or wipe the filter.



8 Turn the camera off.

The mirror will return to the down position and the shutter curtain will close. Replace the lens or body cap.

Use a Reliable Power Source

The shutter curtain is delicate and easily damaged. If the camera powers off while the mirror is raised, the curtain will close automatically. To prevent damage to the curtain, observe the following precautions:

- Do not turn the camera off or remove or disconnect the power source while the mirror is raised.
- If the battery runs low while the mirror is raised, a beep will sound and the self-timer lamp will flash to warn that the shutter curtain will close and the mirror will be lowered after about two minutes. End cleaning or inspection immediately.



Foreign Matter on the Low-Pass Filter

Nikon takes every possible precaution to prevent foreign matter from coming into contact with the low-pass filter during production and shipping. The Df, however, is designed to be used with interchangeable lenses, and foreign matter may enter the camera when lenses are removed or exchanged. Once inside the camera, this foreign matter may adhere to the low-pass filter, where it may appear in photographs taken under certain conditions. To protect the camera when no lens is in place, be sure to replace the body cap provided with the camera, being careful to first remove all dust and other foreign matter that may be adhering to the body cap. Avoid exchanging lenses in dusty environments.

Should foreign matter find its way onto the low-pass filter, clean the filter as described above, or have the filter cleaned by authorized Nikon service personnel. Photographs affected by the presence of foreign matter on the filter can be retouched using Capture NX 2 (available separately; □ 325) or the clean image options available in some third-party imaging applications.

Servicing the Camera and Accessories

The camera is a precision device and requires regular servicing. Nikon recommends that the camera be inspected by the original retailer or Nikon-authorized service representative once every one to two years, and that it be serviced once every three to five years (note that fees apply to these services). Frequent inspection and servicing are particularly recommended if the camera is used professionally. Any accessories regularly used with the camera, such as lenses or optional Speedlights, should be included when the camera is inspected or serviced.



Caring for the Camera and Battery: Cautions

Do not drop: The product may malfunction if subjected to strong shocks or vibration.

Keep dry: This product is not waterproof, and may malfunction if immersed in water or exposed to high levels of humidity. Rusting of the internal mechanism can cause irreparable damage.

Avoid sudden changes in temperature: Sudden changes in temperature, such as those that occur when entering or leaving a heated building on a cold day, can cause condensation inside the device. To prevent condensation, place the device in a carrying case or plastic bag before exposing it to sudden changes in temperature.

Keep away from strong magnetic fields: Do not use or store this device in the vicinity of equipment that generates strong electromagnetic radiation or magnetic fields. Strong static charges or the magnetic fields produced by equipment such as radio transmitters could interfere with the monitor, damage data stored on the memory card, or affect the product's internal circuitry.

Do not leave the lens pointed at the sun: Do not leave the lens pointed at the sun or other strong light source for an extended period. Intense light may cause the image sensor to deteriorate or produce a white blur effect in photographs.

Turn the product off before removing or disconnecting the power source: Do not unplug the product or remove the battery while the product is on or while images are being recorded or deleted. Forcibly cutting power in these circumstances could result in loss of data or in damage to product memory or internal circuitry. To prevent an accidental interruption of power, avoid carrying the product from one location to another while the AC adapter is connected.



Cleaning: When cleaning the camera body, use a blower to gently remove dust and lint, then wipe gently with a soft, dry cloth. After using the camera at the beach or seaside, wipe off any sand or salt using a cloth lightly dampened in pure water and then dry the camera thoroughly. In rare instances, static electricity may cause LCDs to light up or go dark. This does not indicate a malfunction, and the display will soon return to normal.

The lens and mirror are easily damaged. Dust and lint should be gently removed with a blower. When using an aerosol blower, keep the can vertical to prevent discharge of liquid. To remove fingerprints and other stains from the lens, apply a small amount of lens cleaner to a soft cloth and wipe the lens carefully.

See “The Low-Pass Filter” (☞ 329, 331) for information on cleaning the low-pass filter.

Lens contacts: Keep the lens contacts clean.

Do not touch the shutter curtain: The shutter curtain is extremely thin and easily damaged. Under no circumstances should you exert pressure on the curtain, poke it with cleaning tools, or subject it to powerful air currents from a blower. These actions could scratch, deform, or tear the curtain.

Storage: To prevent mold or mildew, store the camera in a dry, well-ventilated area. If you are using an AC adapter, unplug the adapter to prevent fire. If the product will not be used for an extended period, remove the battery to prevent leakage and store the camera in a plastic bag containing a desiccant. Do not, however, store the camera case in a plastic bag, as this may cause the material to deteriorate. Note that desiccant gradually loses its capacity to absorb moisture and should be replaced at regular intervals.

To prevent mold or mildew, take the camera out of storage at least once a month. Turn the camera on and release the shutter a few times before putting it away.

Store the battery in a cool, dry place. Replace the terminal cover before putting the battery away.



Notes on the monitor: The monitor is constructed with extremely high precision; at least 99.99% of pixels are effective, with no more than 0.01% being missing or defective. Hence while these displays may contain pixels that are always lit (white, red, blue, or green) or always off (black), this is not a malfunction and has no effect on images recorded with the device.

Images in the monitor may be difficult to see in a bright light.

Do not apply pressure to the monitor, as this could cause damage or malfunction. Dust or lint on the monitor can be removed with a blower. Stains can be removed by wiping lightly with a soft cloth or chamois leather. Should the monitor break, care should be taken to avoid injury from broken glass and to prevent liquid crystal from the monitor touching the skin or entering the eyes and mouth.

Batteries: Batteries may leak or explode if improperly handled. Observe the following precautions when handling batteries:

- Use only batteries approved for use in this equipment.
- Do not expose the battery to flame or excessive heat.
- Keep the battery terminals clean.
- Turn the product off before replacing the battery.
- Remove the battery from the camera or charger when not in use and replace the terminal cover. These devices draw minute amounts of charge even when off and could draw the battery down to the point that it will no longer function. If the battery will not be used for some time, insert it in the camera and run it flat before removing it and storing it in a location with an ambient temperature of 15 °C to 25 °C (59 °F to 77 °F; avoid hot or extremely cold locations). Repeat this process at least once every six months.
- Turning the camera on or off repeatedly when the battery is fully discharged will shorten battery life. Batteries that have been fully discharged must be charged before use.
- The internal temperature of the battery may rise while the battery is in use. Attempting to charge the battery while the internal temperature is elevated will impair battery performance, and the battery may not charge or charge only partially. Wait for the battery to cool before charging.



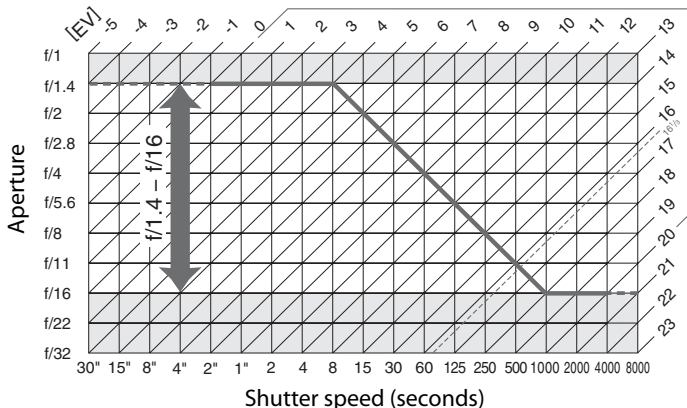
- Continuing to charge the battery after it is fully charged can impair battery performance.
- A marked drop in the time a fully charged battery retains its charge when used at room temperature indicates that it requires replacement. Purchase a new battery.
- Charge the battery before use. When taking photographs on important occasions, ready a spare battery and keep it fully charged. Depending on your location, it may be difficult to purchase replacement batteries on short notice. Note that on cold days, the capacity of batteries tends to decrease. Be sure the battery is fully charged before taking photographs outside in cold weather. Keep a spare battery in a warm place and exchange the two as necessary. Once warmed, a cold battery may recover some of its charge.
- Used batteries are a valuable resource; recycle in accord with local regulations.



Exposure Program (Mode P)

The exposure program for mode **P** is shown in the following graph:

— ISO 100; lens with maximum aperture of f/1.4 and minimum aperture of f/16 (e.g., AF-S NIKKOR 50mm f/1.4G)



The maximum and minimum values for EV vary with ISO sensitivity; the above graph assumes an ISO sensitivity of ISO 100 equivalent. When matrix metering is used, values over $16^{1/3}$ EV are reduced to $16^{1/3}$ EV.



Troubleshooting

If the camera fails to function as expected, check the list of common problems below before consulting your retailer or Nikon-authorized service representative.

Battery/Display

The camera is on but does not respond: Wait for recording to end. If the problem persists, turn the camera off. If the camera does not turn off, remove and reinsert the battery or, if you are using an AC adapter, disconnect and reconnect the AC adapter. Note that although any data currently being recorded will be lost, data that have already been recorded will not be affected by removing or disconnecting the power source.

Viewfinder is out of focus: Adjust viewfinder focus or use optional eyepiece correction lenses (☐ 28, 324).

Viewfinder is dark: Insert a fully-charged battery (☐ 18, 29).

Displays turn off without warning: Choose longer delays for Custom Setting c2 (**Standby timer**) or c4 (**Monitor off delay**) (☐ 251, 253).

Control panel and viewfinder displays are unresponsive and dim: The response times and brightness of these displays vary with temperature.

Fine lines are visible around active focus point or display turns red when focus point is highlighted: These phenomena are normal for this type of viewfinder and do not indicate a malfunction.



Shooting

Camera takes time to turn on: Delete files or folders.

Shutter-release disabled:

- Memory card is locked, full, or not inserted (☞ 19, 29).
 - **Release locked** is selected for Custom Setting f9 (**Slot empty release lock**; ☞ 269).
 - Camera is not in focus (☞ 32).
 - Aperture ring for CPU lens not locked at highest f-number (does not apply to type G and E lenses). If **fE E** is displayed in control panel, select **Aperture ring** for Custom Setting f7 (**Customize command dials**) > **Aperture setting** to use lens aperture ring to adjust aperture (☞ 267).
 - CPU lens attached with metering coupling lever raised (does not apply to type G and E lenses; ☞ 167).
-

Camera is slow to respond to shutter-release button: Select **Off** for Custom Setting d10 (**Exposure delay mode**; ☞ 256).

Only one shot taken each time shutter-release button is pressed in continuous release mode: Turn HDR off (☞ 112).

Photos are out of focus:

- Rotate focus-mode selector to **AF** (☞ 59).
 - Camera unable to focus using autofocus: use manual focus or focus lock (☞ 66, 68).
 - The shutter-release button can not be used to focus when **AF-ON** is assigned as the **Press** option for Custom Setting f4 (**Assign Fn button**, ☞ 263), f5 (**Assign preview button**, ☞ 266), or f6 (**Assign AE-L/AF-L button**, ☞ 267). Use the button to which **AF-ON** is assigned.
-

Shutter speed can not be adjusted using the command dials: Flash in use. Flash sync speed can be selected using Custom Setting e1 (**Flash sync speed**); when using compatible flash units, choose **1/250 s (Auto FP)** or **1/200 s (Auto FP)** for full range of shutter speeds (☞ 257).

Focus does not lock when shutter-release button is pressed halfway: Use ^{AE-L}_{AF-L} **AE-L/AF-L** button to lock focus when **AF-C** is selected for focus mode.



Can not select focus point:

- Unlock focus selector lock (☐ 64).
- Auto-area AF (☐ 62) or face-priority AF (☐ 177) selected for AF-area mode: choose another mode.
- Camera is in playback mode (☐ 185) or menus are in use (☐ 224).
- Press shutter-release button halfway to start standby timer (☐ 33).

Can not select AF-area mode: Manual focus selected (☐ 68, 183).

Image size can not be changed: **Image quality** set to **NEF (RAW)** (☐ 55).

Camera is slow to record photos: Turn long exposure noise reduction off (☐ 242).

Noise (bright spots, randomly-spaced bright pixels, fog, or lines) appear in photos:

- Choose lower ISO sensitivity or use high ISO noise reduction (☐ 70, 242).
- Shutter speed is slower than 1 s: use long exposure noise reduction (☐ 242).
- Turn Active D-Lighting off to avoid heightening the effects of noise (☐ 110).

Smudges appear in photographs: Clean front and rear lens elements. If problem persists, perform image sensor cleaning (☐ 329).

Colors are unnatural:

- Adjust white balance to match light source (☐ 81).
- Adjust **Set Picture Control** settings (☐ 100).

Can not measure white balance: Subject is too dark or too bright (☐ 92).

Image can not be selected as source for preset white balance: Image was not created with Df (☐ 96).

White balance bracketing unavailable:

- NEF (RAW) or NEF+JPEG image quality option selected for image quality (☐ 55, 141).
- Multiple exposure mode is in effect (☐ 155).

Effects of Picture Control differ from image to image: **A** (auto) is selected for sharpening, contrast, or saturation. For consistent results over a series of photos, choose another setting (☐ 103).

Metering can not be changed: Autoexposure lock is in effect (☐ 77).

Exposure compensation can not be used: Choose exposure mode **P**, **S**, or **A** (☐ 38, 39, 41).

Noise (reddish areas or other artifacts) appears in long time-exposures: Enable long exposure noise reduction (☐ 242).

The brightness of the image in the monitor differs from the exposure of photographs taken in live view:

- Center-weighted or spot metering is selected (☐ 75).
 - The camera is in exposure mode **M** (☐ 174).
 - The subject is too bright or too dark.
 - Active D-Lighting is in effect (☐ 110).
 - The photograph is a long time-exposure (☐ 44).
 - The flash is used (☐ 116).
-

Flicker or banding appears during live view: Choose an option for **Flicker reduction** that matches the frequency of the local AC power supply (☐ 276).

Bright bands appear during live view: A flashing sign, flash, or other light source with brief duration was used during live view.

Playback

NEF (RAW) image is not played back: Photo was taken at image quality of NEF + JPEG (☐ 55).

Can not view pictures recorded with other cameras: Pictures recorded with other makes of camera may not be displayed correctly.

Some photos are not displayed during playback: Select **All** for **Playback folder** (☐ 230).

“Tall” (portrait) orientation photos are displayed in “wide” (landscape) orientation:

- Select **On** for **Rotate tall** (☐ 233).
 - Photo was taken with **Off** selected for **Auto image rotation** (☐ 277).
 - Camera was pointed up or down when photo was taken (☐ 277).
 - Photo is displayed in image review (☐ 232).
-

Can not delete picture:

- Picture is protected: remove protection (☐ 201).
 - Memory card is locked (☐ 22).
-



Can not retouch picture: Photo can not be further edited with this camera (☐ 289).

Message is displayed stating that no images are available for playback: Select **All** for **Playback folder** (☐ 230).

Can not change print order:

- Memory card is full: delete pictures (☐ 35, 203).
- Memory card is locked (☐ 22).

Can not print photos: NEF (RAW) or TIFF photos can not be printed by direct USB connection. Transfer photos to computer and print using ViewNX 2 (supplied) or Capture NX 2 (available separately; ☐ 325). NEF (RAW) photos can be saved in JPEG format using **NEF (RAW) processing** (☐ 300).

Photo is not displayed on high-definition video device: Confirm that HDMI cable (available separately) is connected (☐ 222).

Camera does not respond to remote control for HDMI-CEC television:

- Select **On** for **HDMI > Device control** in the setup menu (☐ 223).
- Adjust HDMI-CEC settings for the television as described in documentation provided with the device.

Can not transfer photos to computer: OS not compatible with camera or transfer software. Use card reader to copy photos to computer (☐ 325).

Photos are not displayed in Capture NX 2: Update to latest version (☐ 325).

Image Dust Off option in Capture NX 2 does not have desired effect: Image sensor cleaning changes the position of dust on the low-pass filter. Dust off reference data recorded before image sensor cleaning is performed can not be used with photographs taken after image sensor cleaning is performed. Dust off reference data recorded after image sensor cleaning is performed can not be used with photographs taken before image sensor cleaning is performed (☐ 275).

Computer displays NEF (RAW) images differently from camera: Third-party software does not display effects of Picture Controls or Active D-Lighting. Use ViewNX 2 (supplied) or optional Nikon software such as Capture NX 2 (available separately).



Miscellaneous






Date of recording is not correct: Set camera clock (📖 27, 276).

Menu item can not be selected: Some options are not available at certain combinations of settings or when no memory card is inserted.



Error Messages



This section lists the indicators and error messages that appear in the viewfinder, control panel, and monitor.

Indicator		Problem	Solution	
Control panel	Viewfinder			
FE E (flashes)		<ul style="list-style-type: none"> • Lens aperture ring is not set to minimum aperture. • CPU AI lens attached with camera metering coupling lever raised (does not apply to type G or E lenses). 	<ul style="list-style-type: none"> • Set ring to minimum aperture (highest f-number). • Remove lens, lower metering coupling lever, and re-attach lens. 	25 167
		Low battery.	Ready a fully-charged spare battery.	29
 (flashes)	 (flashes)	<ul style="list-style-type: none"> • Battery exhausted. • Battery can not be used. 	<ul style="list-style-type: none"> • Recharge or replace battery. • Contact Nikon-authorized service representative. • Replace the battery, or recharge the battery if the rechargeable Li-ion battery is exhausted. 	xvi, 18, 19
ΔF		No lens attached, or non-CPU lens attached without specifying maximum aperture. Aperture shown in stops from maximum aperture.	Aperture value will be displayed if maximum aperture is specified.	163










Indicator		Problem	Solution	📖
Control panel	Viewfinder			
—	▶ ◀ (flashes)	Camera unable to focus using autofocus.	Change composition or focus manually.	61, 68
(Exposure indicators and shutter speed or aperture display flash)		Subject too bright; photo will be overexposed.	<ul style="list-style-type: none"> Use a lower ISO sensitivity In exposure mode: <ul style="list-style-type: none"> P Use optional ND filter S Increase shutter speed A Choose a smaller aperture (higher f-number) 	70 38, 323 39 41
		Subject too dark; photo will be underexposed.	<ul style="list-style-type: none"> Use a higher ISO sensitivity In exposure mode: <ul style="list-style-type: none"> P Use flash S Lower shutter speed A Choose a larger aperture (lower f-number) 	70 38, 116 39 41
b u l b (flashes)		B (Bulb) selected in exposure mode S .	Change shutter speed or select exposure mode M .	39, 42
- - (flashes)		T (Time) selected in exposure mode S .	Change shutter speed or select exposure mode M .	39, 42
b u s y (flashes)	b s y (flashes)	Images are being processed.	Wait until processing is complete.	—



Indicator		Problem	Solution	
Control panel	View-finder			
—	 (flashes)	If indicator flashes for 3s after flash fires, photo may be underexposed.	Check photo in monitor; if underexposed, adjust settings and try again.	121
F u l l (flashes)	F u l (flashes)	Memory insufficient to record further photos at current settings, or camera has run out of file or folder numbers.	<ul style="list-style-type: none"> • Reduce quality or size. • Delete photographs. • Insert new memory card. 	55, 58 203 19
E r r (flashes)		Camera malfunction.	Release shutter. If error persists or appears frequently, consult Nikon-authorized service representative.	—




Indicator		Problem	Solution	
Monitor	Control panel			
No memory card.	 (- E -)	Camera cannot detect memory card.	Turn camera off and confirm that card is correctly inserted.	19
This memory card cannot be used. Card may be damaged. Insert another card.	 (flashes)	<ul style="list-style-type: none"> • Error accessing memory card. • Unable to create new folder. 	<ul style="list-style-type: none"> • Use Nikon-approved card. • Check that contacts are clean. If card is damaged, contact retailer or Nikon-authorized service representative. • Delete files or insert new memory card after copying important images to computer or other device. 	363 — 19, 203
	 (flashes)	Camera can not control Eye-Fi card.	<ul style="list-style-type: none"> • Check that Eye-Fi card firmware is up to date. • Copy files on Eye-Fi card to a computer or other device and format card, or insert new card. 	285 19
Memory card is locked. Slide lock to “write” position.	 (flashes)	Memory card is locked (write protected).	Slide card write-protect switch to “write” position.	22
Not available if Eye-Fi card is locked.	 (flashes)	Eye-Fi card is locked (write protected).		



Indicator		Problem	Solution	📖
Monitor	Control panel			
This card is not formatted. Format the card.	[F a r] (flashes)	Memory card has not been formatted for use in camera.	Format memory card or insert new memory card.	19
Clock has been reset	—	Camera clock is not set.	Set camera clock.	27, 276
Failed to update flash unit firmware. Flash cannot be used. Contact a Nikon-authorized service representative.	—	Firmware for flash unit mounted on camera was not updated correctly.	Contact a Nikon-authorized service representative.	—
Unable to start live view. Please wait.	—	The internal temperature of the camera is high.	Wait for the internal circuits to cool before resuming live view.	174
Folder contains no images.	—	No images on memory card or in folder(s) selected for playback.	Select folder containing images from Playback folder menu or insert memory card containing images.	19, 230
All images are hidden.	—	All photos in current folder are hidden.	No images can be played back until another folder has been selected or Hide image used to allow at least one image to be displayed.	230



Indicator		Problem	Solution	
Monitor	Control panel			
Cannot display this file.	—	File has been created or modified using a computer or different make of camera, or file is corrupt.	File can not be played back on camera.	—
Cannot select this file.	—	Selected image can not be retouched.	Images created with other devices can not be retouched.	289
Check printer.	—	Printer error.	Check printer. To resume, select Continue (if available).	214 *
Check paper.	—	Paper in printer is not of selected size.	Insert paper of correct size and select Continue .	214 *
Paper jam.	—	Paper is jammed in printer.	Clear jam and select Continue .	214 *
Out of paper.	—	Printer is out of paper.	Insert paper of selected size and select Continue .	214 *
Check ink supply.	—	Ink error.	Check ink. To resume, select Continue .	214 *
Out of ink.	—	Printer is out of ink.	Replace ink and select Continue .	214 *

* See printer manual for more information.



Specifications

■ Nikon Df Digital Camera

Type	
Type	Single-lens reflex digital camera
Lens mount	Nikon F mount (with AF coupling and AF contacts)
Effective angle of view	Nikon FX format
Effective pixels	
Effective pixels	16.2 million
Image sensor	
Image sensor	36.0 × 23.9 mm CMOS sensor
Total pixels	16.6 million
Dust-reduction System	Image sensor cleaning, Image Dust Off reference data (optional Capture NX 2 software required)
Storage	
Image size (pixels)	<ul style="list-style-type: none">• FX (36×24) image area 4928 × 3280 (📷) 3696 × 2456 (📷) 2464 × 1640 (📷)• DX (24×16) image area 3200 × 2128 (📷) 2400 × 1592 (📷) 1600 × 1064 (📷)
File format	<ul style="list-style-type: none">• NEF (RAW): 12 or 14 bit, lossless compressed, compressed, or uncompressed• TIFF (RGB)• JPEG: JPEG-Baseline compliant with fine (approx. 1 : 4), normal (approx. 1 : 8), or basic (approx. 1 : 16) compression (Size priority); Optimal quality compression available• NEF (RAW)+JPEG: Single photograph recorded in both NEF (RAW) and JPEG formats
Picture Control System	Standard, Neutral, Vivid, Monochrome, Portrait, Landscape; selected Picture Control can be modified; storage for custom Picture Controls
Media	SD (Secure Digital) and UHS-I compliant SDHC and SDXC memory cards
File system	DCF (Design Rule for Camera File System) 2.0, DPOF (Digital Print Order Format), Exif (Exchangeable Image File Format for Digital Still Cameras) 2.3, PictBridge



Viewfinder	
Viewfinder	Eye-level pentaprism single-lens reflex viewfinder
Frame coverage	<ul style="list-style-type: none"> • FX (36×24): Approx. 100% horizontal and 100% vertical • DX (24×16): Approx. 97% horizontal and 97% vertical
Magnification	Approx. $0.7 \times$ (50 mm f/1.4 lens at infinity, -1.0 m^{-1})
Eyepoint	15 mm (-1.0 m^{-1} ; from center surface of viewfinder eyepiece lens)
Diopter adjustment	-3 – $+1 \text{ m}^{-1}$
Focusing screen	Type B BriteView Clear Matte Mark VIII screen with AF area brackets (framing grid can be displayed)
Reflex mirror	Quick return
Depth-of-field preview	Pressing Pv button stops lens aperture down to value selected by user (exposure modes A and M) or by camera (exposure modes P and S)
Lens aperture	Instant return, electronically controlled

Lens

Compatible lenses	Compatible with AF NIKKOR lenses, including type G, E, and D lenses (some restrictions apply to PC lenses) and DX lenses (using DX 24 × 16 1.5× image area), AI-P NIKKOR lenses, and non-CPU lenses. IX NIKKOR lenses and lenses for the F3AF can not be used. The electronic rangefinder can be used with lenses that have a maximum aperture of f/5.6 or faster (the electronic rangefinder supports the center 7 focus points with lenses that have a maximum aperture of f/8 or faster and the center 33 focus points with lenses that have a maximum aperture of f/7.1 or faster).
--------------------------	---


Shutter

Type	Electronically-controlled vertical-travel focal-plane shutter
Speed	$\frac{1}{4000}$ –4 s in steps of 1 EV ($\frac{1}{4000}$ –30 s in steps of $\frac{1}{3}$ EV with main command dial), X200 (with shutter-speed dial only), bulb, time
Flash sync speed	X = $\frac{1}{200}$ s; synchronizes with shutter at $\frac{1}{250}$ s or slower (flash range drops at speeds between $\frac{1}{200}$ and $\frac{1}{250}$ s)



Release	
Release mode	S (single frame), CL (continuous low speed), CH (continuous high speed), Q (quiet shutter-release), ⌚ (self-timer), MUP (mirror up)
Frame advance rate	1–5 fps (CL) or 5.5 fps (CH)
Self-timer	2 s, 5 s, 10 s, 20 s; 1–9 exposures at intervals of 0.5, 1, 2, or 3 s
Exposure	
Metering	TTL exposure metering using 2016-pixel RGB sensor
Metering method	<ul style="list-style-type: none"> • Matrix: 3D color matrix metering II (type G, E, and D lenses); color matrix metering II (other CPU lenses); color matrix metering available with non-CPU lenses if user provides lens data • Center-weighted: Weight of 75% given to 12 mm circle in center of frame. Diameter of circle can be changed to 8, 15, or 20 mm, or weighting can be based on average of entire frame (non-CPU lenses use 12-mm circle) • Spot: Meters 4 mm circle (about 1.5% of frame) centered on selected focus point (on center focus point when non-CPU lens is used)
Range (ISO 100, f/1.4 lens, 20 °C/68 °F)	<ul style="list-style-type: none"> • Matrix or center-weighted metering: 0–20 EV • Spot metering: 2–20 EV
Exposure meter coupling	Combined CPU and AI (collapsible metering coupling lever)
Exposure mode	Programmed auto with flexible program (P); shutter-priority auto (S); aperture-priority auto (A); manual (M)
Exposure compensation	–3 – +3EV in increments of $\frac{1}{3}$ EV
Exposure bracketing	2–5 frames in steps of $\frac{1}{3}$, $\frac{2}{3}$, 1, 2, or 3 EV
Flash bracketing	2–5 frames in steps of $\frac{1}{3}$, $\frac{2}{3}$, 1, 2, or 3 EV
White balance bracketing	2–3 frames in steps of 1, 2, or 3
ADL bracketing	2 frames using selected value for one frame or 3-5 frames using preset values for all frames
Exposure lock	Luminosity locked at detected value with AE-L/AF-L button



Exposure	
ISO sensitivity (Recommended Exposure Index)	ISO 100 – 12800 in steps of $1/3$ EV. Can also be set to approx. 0.3, 0.7, or 1 EV (ISO 50 equivalent) below ISO 100 or to approx. 0.3, 0.7, 1, 2, 3, or 4 EV (ISO 204800 equivalent) above ISO 12800; auto ISO sensitivity control available
Active D-Lighting	Can be selected from Auto , Extra high +2/+1, High , Normal , Low , or Off
Focus	
Autofocus	Nikon Multi-CAM 4800 autofocus sensor module with TTL phase detection, fine-tuning, and 39 focus points (including 9 cross-type sensors; the center 33 points are available at apertures slower than f/5.6 and faster than f/8, while the center 7 focus points are available at f/8)
Detection range	-1 – +19 EV (ISO 100, 20 °C/68 °F)
Lens servo	<ul style="list-style-type: none"> • Autofocus (AF): Single-servo AF (AF-S); continuous-servo AF (AF-C); predictive focus tracking activated automatically according to subject status • Manual focus (M): Electronic rangefinder can be used
Focus point	Can be selected from 39 or 11 focus points
AF-area mode	Single-point AF; 9-, 21-, or 39-point dynamic-area AF, 3D-tracking, auto-area AF
Focus lock	Focus can be locked by pressing shutter-release button halfway (single-servo AF) or by pressing  AE-L/AF-L button
Flash	
Flash control	TTL: i-TTL flash control using 2016-pixel RGB sensor is available with SB-910, SB-900, SB-800, SB-700, SB-600, SB-400, or SB-300; i-TTL balanced fill-flash for digital SLR is used with matrix and center-weighted metering, standard i-TTL flash for digital SLR with spot metering
Flash mode	Front-curtain sync, slow sync, rear-curtain sync, red-eye reduction, red-eye reduction with slow sync, slow rear-curtain sync, Auto FP High-Speed Sync supported



Flash	
Flash compensation	-3 – +1 EV in increments of 1/3 EV
Flash-ready indicator	Lights when optional flash unit is fully charged; flashes after flash is fired at full output
Accessory shoe	ISO 518 hot-shoe with sync and data contacts and safety lock
Nikon Creative Lighting System (CLS)	Advanced Wireless Lighting supported with SB-910, SB-900, SB-800, or SB-700 as a master flash and SB-600 or SB-R200 as remotes, or SU-800 as commander; Auto FP High-Speed Sync and modeling illumination supported with all CLS-compatible flash units except SB-400 and SB-300; Flash Color Information Communication and FV lock supported with all CLS-compatible flash units
Sync terminal	ISO 519 sync terminal with locking thread
White balance	
White balance	Auto (2 types), incandescent, fluorescent (7 types), direct sunlight, flash, cloudy, shade, preset manual (up to 4 values can be stored, spot white balance measurement available during live view), choose color temperature (2500 K–10000 K), all with fine-tuning
Live view	
Lens servo	<ul style="list-style-type: none"> • Autofocus (AF): Single-servo AF (AF-S); full-time servo AF (AF-F) • Manual focus (M)
AF-area mode	Face-priority AF, wide-area AF, normal-area AF, subject-tracking AF
Autofocus	Contrast-detect AF anywhere in frame (camera selects focus point automatically when face-priority AF or subject-tracking AF is selected)
Monitor	
Monitor	8-cm/3.2-in., approx. 921k-dot (VGA), low-temperature polysilicon TFT LCD with approx. 170 ° viewing angle, approx. 100% frame coverage, and brightness control



Playback	
Playback	Full-frame and thumbnail (4, 9, or 72 images or calendar) playback with playback zoom, photo slide shows, histogram display, highlights, photo information, location data display, and auto image rotation
Interface	
USB	Hi-Speed USB
HDMI output	Type C mini-pin HDMI connector
Accessory terminal	Wireless remote controllers: WR-R10 and WR-1 (available separately) Remote cord: MC-DC2 (available separately) GPS unit: GP-1/GP-1A (available separately)
Supported languages	
Supported languages	Arabic, Chinese (Simplified and Traditional), Czech, Danish, Dutch, English, Finnish, French, German, Greek, Hindi, Hungarian, Indonesian, Italian, Japanese, Korean, Norwegian, Polish, Portuguese (Portugal and Brazil), Romanian, Russian, Spanish, Swedish, Thai, Turkish, Ukrainian
Power source	
Battery	One rechargeable Li-ion EN-EL14a battery
AC adapter	EH-5b AC adapter; requires EP-5A power connector (available separately)
Tripod socket	
Tripod socket	1/4 in. (ISO 1222)
Dimensions/weight	
Dimensions (W × H × D)	Approx. 143.5 × 110 × 66.5 mm (5.6 × 4.3 × 2.6 in.)
Weight	Approx. 765 g (1 lb 11 oz) with battery and memory card but without body cap; approx. 710 g (1 lb 9 oz; camera body only)



Operating environment

Temperature	0 °C–40 °C (+32 °F–104 °F)
Humidity	85% or less (no condensation)

- Unless otherwise stated, all figures are for a camera with a fully-charged battery operating at the temperature specified by the Camera and Imaging Products Association (CIPA): 23 ±3 °C (73.4 ±5.4 °F).
- Nikon reserves the right to change the specifications of the hardware and software described in this manual at any time and without prior notice. Nikon will not be held liable for damages that may result from any mistakes that this manual may contain.

MH-24 battery charger

Rated input	AC 100–240 V, 50/60 Hz, 0.2 A maximum
Rated output	DC 8.4 V/0.9 A
Supported batteries	Nikon Rechargeable Li-ion Battery EN-EL14a
Charging time	Approx. 1 hour and 50 minutes at an ambient temperature of 25 °C (77 °F) when no charge remains
Operating temperature	0 °C–40 °C (+32 °F–104 °F)
Dimensions (W × H × D)	Approx. 70 × 26 × 97 mm (2.8 × 1.0 × 3.8 in.), excluding plug adapter
Weight	Approx. 96 g (3.4 oz), excluding plug adapter

EN-EL14a rechargeable Li-ion battery

Type	Rechargeable lithium-ion battery
Rated capacity	7.2 V/1230 mAh
Operating temperature	0 °C–40 °C (+32 °F–104 °F)
Dimensions (W × H × D)	Approx. 38 × 53 × 14 mm (1.5 × 2.1 × 0.6 in.)
Weight	Approx. 49 g (1.7 oz), excluding terminal cover

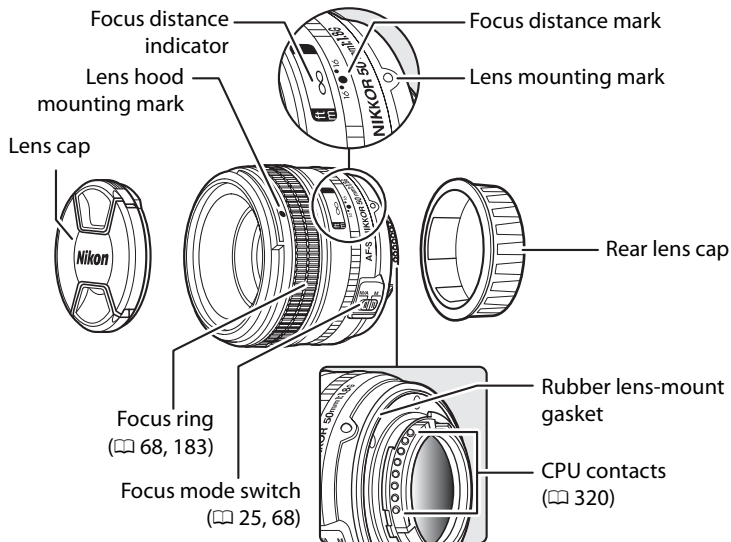


AF-S NIKKOR 50mm f/1.8G (Special Edition)	
Type	Type G AF-S lens with built-in CPU and F mount
Focal length	50 mm
Maximum aperture	f/1.8
Lens construction	7 elements in 6 groups (including 1 aspherical lens element)
Angle of view	<ul style="list-style-type: none"> • Nikon film SLR and FX-format D-SLR cameras: 47° • Nikon DX-format D-SLR cameras: 31° 30'
Distance information	Output to camera
Focusing	Autofocus controlled by Silent Wave Motor and separate focus ring for manual focus
Focus distance indicator	0.45 m to infinity (∞)
Minimum focus distance	0.45 m (1.5 ft) from focal plane
Diaphragm blades	7 (rounded diaphragm opening)
Diaphragm	Fully automatic
Aperture range	f/1.8 – 16
Metering	Full aperture
Filter-attachment size	58 mm (P = 0.75 mm)
Dimensions	Approx. 73 mm maximum diameter × 52.5 mm (distance from camera lens mount flange)
Weight	Approx. 190 g (6.7 oz)



AF-S NIKKOR 50mm f/1.8G **(Special Edition)**

The parts of the AF-S NIKKOR 50mm f/1.8G (Special Edition) are shown below.

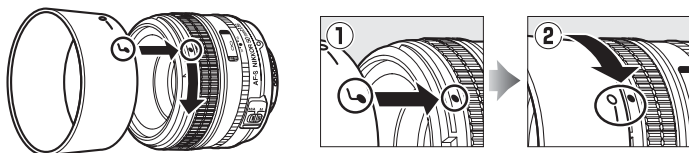


✔ Lens Care

- When a lens hood is attached, do not pick up or hold the lens or camera using only the hood.
- Keep the CPU contacts clean.
- Should the rubber lens-mount gasket be damaged, cease use immediately and take the lens to a Nikon-authorized service center for repair.
- Use a blower to remove dust and lint from the lens surfaces. To remove smudges and fingerprints, apply a small amount of ethanol or lens cleaner to a soft, clean cotton cloth or lens-cleaning tissue and clean from the center outwards using a circular motion, taking care not to leave smears or touch the glass with your fingers.
- Never use organic solvents such as paint thinner or benzene to clean the lens.
- The lens hood or NC filters can be used to protect the front lens element.
- Attach the front and rear caps before placing the lens in its flexible pouch.
- If the lens will not be used for an extended period, store it in a cool, dry location to prevent mold and rust. Do not store in direct sunlight or with naphtha or camphor moth balls.
- Keep the lens dry. Rusting of the internal mechanism can cause irreparable damage.
- Leaving the lens in extremely hot locations could damage or warp parts made from reinforced plastic.

✔ Supplied Accessories

- 58 mm Snap-on Front Lens Cap LC-58
- Rear Lens Cap LF-4
- Flexible Lens Pouch CL-1013
- Bayonet Hood HB-47 (attaches as shown)



✔ Optional Accessories

- 58 mm screw-on filters



Supported Standards

- **DCF Version 2.0:** The Design Rule for Camera File Systems (DCF) is a standard widely used in the digital camera industry to ensure compatibility among different makes of camera.
- **DPOF:** Digital Print Order Format (DPOF) is an industry-wide standard that allows pictures to be printed from print orders stored on the memory card.
- **Exif version 2.3:** The camera supports Exif (Exchangeable Image File Format for Digital Still Cameras) version 2.3, a standard in which information stored with photographs is used for optimal color reproduction when the images are output on Exif-compliant printers.
- **PictBridge:** A standard developed through cooperation with the digital camera and printer industries, allowing photographs to be output directly to a printer without first transferring them to a computer.
- **HDMI:** High-Definition Multimedia Interface is a standard for multimedia interfaces used in consumer electronics and AV devices capable of transmitting audiovisual data and control signals to HDMI-compliant devices via a single cable connection.

Trademark Information

Mac OS and OS X are registered trademarks of Apple Inc. in the United States and/or other countries. Microsoft, Windows, and Windows Vista are either registered trademarks, or trademarks of Microsoft Corporation in the United States and/or other countries. PictBridge is a trademark. The SD, SDHC, and SDXC logos are trademarks of the SD-3C, LLC. HDMI, the HDMI logo and High-Definition Multimedia Interface are trademarks or registered trademarks of HDMI Licensing LLC.

HDMI

All other trade names mentioned in this manual or the other documentation provided with your Nikon product are trademarks or registered trademarks of their respective holders.



Approved Memory Cards

The camera supports SD, SDHC, and SDXC memory cards, including SDHC and SDXC cards compliant with UHS-I. When choosing cards for use in card readers, be sure they are compatible with the device. Contact the manufacturer for information on features, operation, and limitations on use.



Memory Card Capacity

The following table shows the approximate number of pictures that can be stored on an 8 GB SanDisk Extreme Pro SDHC UHS-I card at different image quality (□ 55), image size (□ 58), and image area settings (□ 51).

■ FX (36×24) Image Area *

Image quality	Image size	File size ¹	No. of images ¹	Buffer capacity ²
NEF (RAW), Lossless compressed, 12-bit	—	15.4 MB	279	37
NEF (RAW), Lossless compressed, 14-bit	—	19.4 MB	216	29
NEF (RAW), Compressed, 12-bit	—	13.9 MB	377	47
NEF (RAW), Compressed, 14-bit	—	17.0 MB	315	38
NEF (RAW), Uncompressed, 12-bit	—	26.5 MB	279	30
NEF (RAW), Uncompressed, 14-bit	—	34.3 MB	216	25
TIFF (RGB)	Large	49.1 MB	151	21
	Medium	28.3 MB	265	25
	Small	13.2 MB	566	36
JPEG fine ³	Large	7.9 MB	729	100
	Medium	5.4 MB	1100	100
	Small	3.0 MB	2200	100
JPEG normal ³	Large	4.5 MB	1400	100
	Medium	2.8 MB	2300	100
	Small	1.6 MB	4300	100
JPEG basic ³	Large	2.2 MB	2800	100
	Medium	1.5 MB	4600	100
	Small	0.9 MB	8000	100

* Includes images taken with non-DX lenses when **On** is selected for **Auto DX crop**.


■ ■ DX (24×16) Image Area *

Image quality	Image size	File size ¹	No. of images ¹	Buffer capacity ²
NEF (RAW), Lossless compressed, 12-bit	—	7.2 MB	618	100
NEF (RAW), Lossless compressed, 14-bit	—	8.9 MB	484	96
NEF (RAW), Compressed, 12-bit	—	6.6 MB	818	100
NEF (RAW), Compressed, 14-bit	—	7.9 MB	692	100
NEF (RAW), Uncompressed, 12-bit	—	12.0 MB	618	72
NEF (RAW), Uncompressed, 14-bit	—	15.3 MB	484	53
TIFF (RGB)	Large	21.5 MB	349	29
	Medium	12.6 MB	593	39
	Small	6.2 MB	1100	69
JPEG fine ³	Large	3.7 MB	1500	100
	Medium	2.8 MB	2200	100
	Small	1.9 MB	3600	100
JPEG normal ³	Large	2.3 MB	2900	100
	Medium	1.6 MB	4400	100
	Small	1.1 MB	7100	100
JPEG basic ³	Large	1.2 MB	5700	100
	Medium	0.9 MB	8600	100
	Small	0.7 MB	12100	100

* Includes images taken with DX lenses when **On** is selected for **Auto DX crop**.

- 1 All figures are approximate. File size varies with scene recorded.
- 2 Maximum number of exposures that can be stored in memory buffer at ISO 100. Drops if **Optimal quality** is selected for **JPEG compression** (□ 57), NEF (RAW) photos are taken with ISO sensitivity set to Hi 0.3 or higher, or long exposure noise reduction or auto distortion control is on.
- 3 Figures assume **JPEG compression** is set to **Size priority**. Selecting **Optimal quality** increases the file size of JPEG images; number of images and buffer capacity drop accordingly.



 **d6—Max. Continuous Release** (📖 254)

The maximum number of photographs that can be taken in a single burst can be set to any amount between 1 and 100.



Battery Life

The number of shots that can be taken with a fully-charged EN-EL14a battery varies with the condition of the battery, temperature, and how the camera is used. Sample figures are given below.

- **CIPA standard**¹: Approximately 1400 shots
- **Nikon standard**²: Approximately 2900 shots
 - 1 Measured at 23 °C/73.4 °F (±2 °C/3.6 °F) with an AF-S NIKKOR 50mm f/1.8G (Special Edition) lens under the following test conditions: lens cycled from infinity to minimum range and one photograph taken at default settings once every 30 s. Live view not used.
 - 2 Measured at 20 °C/68 °F with an AF-S NIKKOR 50mm f/1.8G (Special Edition) lens under the following test conditions: image quality set to JPEG basic, image size set to **M** (medium), shutter speed $1/250$ s, shutter-release button pressed halfway for three seconds and focus cycled from infinity to minimum range three times; six shots are then taken in succession and monitor turned on for five seconds and then turned off; cycle repeated once standby timer expires.

The following can reduce battery life:

- Using the monitor
- Keeping the shutter-release button pressed halfway
- Repeated autofocus operations
- Taking NEF (RAW) or TIFF (RGB) photographs
- Slow shutter speeds
- Using a GP-1 or GP-1A GPS unit
- Using an Eye-Fi card
- Using a WU-1a wireless mobile adapter or WR-R10/WR-1 wireless remote controllers
- Using VR (vibration reduction) mode with VR lenses













To ensure that you get the most from rechargeable Nikon EN-EL14a batteries:

- Keep the battery contacts clean. Soiled contacts can reduce battery performance.
- Use batteries immediately after charging. Batteries will lose their charge if left unused.



Index

Symbols

P (Programmed auto).....	38
S (Shutter-priority auto)	39
A (Aperture-priority auto).....	41
M (Manual)	42
B (Bulb).....	44
T (Time).....	44
1/3STEP	40
S (Single frame)	7, 46
Cl (Continuous low speed)	7, 46, 254
Ch (Continuous high speed).....	7, 46
Q (Quiet shutter-release).....	7, 46
⌚ (Self-timer).....	7, 46, 48
MUP (Mirror up).....	7, 46, 50
 (Face-priority AF).....	177
 (Wide-area AF)	177
 (Normal-area AF)	177
 (Subject-tracking AF).....	177
 (Matrix).....	75
 (Center-weighted).....	75
 (Spot)	75
Fn button	263
Pv button	41, 174, 259, 266
BKT button.....	137, 138, 141, 142, 145
 (Info) button	11, 182
i button.....	14, 179, 290
 (Live view) button	93, 172
 (Help)	15
 button	5, 133, 256, 261
 (Memory buffer)	32, 47

Numerics

12-bit	57
14-bit	57
2016-pixel RGB sensor	354, 355
3D-tracking.....	62, 63, 64

A

AC adapter.....	323, 326
Accessories	323
Accessory shoe.....	116

Accessory terminal.....	170, 325
Active D-Lighting.....	110, 145
Add items (My Menu).....	314
Adjust viewfinder focus.....	28
ADL bracketing (Auto bracketing set)....	145, 259
Adobe RGB	240
AE & flash (Auto bracketing set)	136, 259
AE lock	77
AE only (Auto bracketing set)..	136, 259
AE-L/AF-L button	66, 77, 267
AF	59–67, 175–178
AF activation.....	247
AF area brackets	28
AF fine-tune	283
AF point illumination.....	248
AF-area mode.....	62, 177
AF-assist	122
AF-C	59, 246
AF-C priority selection	246
AF-F	175
AF-mode button	60, 63, 175, 178
AF-ON button	60, 67, 247
AF-S.....	59, 175, 246
AF-S priority selection	246
After delete	233
Angle of view.....	322
Aperture	41–43, 268
Aperture-priority auto	41
Aspect ratio	293
Assign AE-L/AF-L button	267
Assign Fn button	263
Assign preview button.....	266
Assign remote Fn button	284
Attaching the lens	24
Auto (White balance).....	81
Auto bracketing.....	136, 259, 260
Auto bracketing (Mode M)	260
Auto bracketing set.....	259
Auto distortion control	241

Auto DX crop	52, 53
Auto FP high-speed sync.....	119, 257
Auto image rotation.....	277
Auto info display	273
Auto ISO sensitivity control	72
Auto-area AF	63, 64
Autoexposure lock.....	77
Autofocus.....	59–67, 175–178
Autofocus mode	59, 175

B

Backlight.....	256
Battery.....	18, 19, 29, 358
Battery charger	18, 358
Beep	253
Black-and-white (Monochrome).....	294
Blue intensifier (Filter effects)	295
Body cap.....	324
Border (PictBridge)	216
Bracketing.....	136, 141, 145, 259, 260
Bracketing order	260
Bulb	44
Burst.....	153, 254

C

Cable release.....	323
Calendar playback	197
Camera Control Pro 2.....	325
Capture NX 2.....	56, 109, 240, 274, 277–279, 325
CEC	223
Center-weighted	75, 250
Center-weighted area.....	250
Charging the battery	18
Choose color temp. (White balance) 82, 88	
Choose image area.....	52, 53
CL mode shooting speed	254
Clean image sensor	329
Clock	26, 276
Clock battery.....	27
Cloudy (White balance)	82
CLS.....	118
Color balance.....	296

Color outline.....	306
Color sketch	306
Color space.....	240
Color temperature	82, 83, 88
Compatible lenses.....	318
Compressed (Type)	57
Continuous high speed	7, 46
Continuous low speed	7, 46, 254
Continuous release mode	7, 46
Continuous-servo AF	59, 246

Control panel.....	8
Copyright.....	279
Copyright information	279
CPU contacts	320, 360
CPU lens	25, 318, 320
Creative Lighting System	118
Cropping (PictBridge)	216
Cross screen (Filter effects).....	295
Custom Settings.....	243
Custom settings bank	245
Customize command dials.....	267
Cyanotype (Monochrome).....	294

D

Date and time	26, 276
Date format.....	26, 276
Daylight saving time.....	27, 276
DCF.....	240, 362
Default settings	133, 224
Delete.....	35, 203
Delete all images.....	205
Delete current image	35, 203
Delete selected images	205
Depth-of-field	41
Detaching the lens	25
Device control (HDMI).....	223
Digital Print Order Format	217, 219, 362
Diopter.....	324
Diopter adjustment control	28
Direct sunlight (White balance).....	81
Distortion control	305
D-Lighting	291
DPOF	217, 219, 362



DPOF print order	219
DX (24 × 16) 1.5 ×	52
DX format	52
Dynamic-area AF	62, 64

E

Easy shutter-speed shift	270
Electronic rangefinder	69
Exif	362
Exposure	75–80, 136
Exposure bracketing	136, 259, 260
Exposure comp. for flash	259
Exposure compensation	79
Exposure compensation dial	79
Exposure compensation dial lock release	79
Exposure delay mode	256
Exposure indicator	43
Exposure lock	77
Exposure meters	33, 251
Exposure mode	6, 30, 36
Exposure mode dial	6, 30, 36
Exposure program	339
Eye-Fi upload	285
Eyepiece cap	159

F

Face-priority AF	177
File information	189
File naming	239
File number sequence	255
Filter effects	295
Fine-tune optimal exposure	250
Fine-tuning white balance	84
Firmware version	286
Fisheye	305
Flash	116, 125, 128, 130
Flash (White balance)	82
Flash bracketing	136, 259, 260
Flash compensation	128
Flash control	124
Flash mode	125, 126
Flash only (Auto bracketing set)	136, 259

Flash ready indicator	121, 131
Flash shutter speed	258
Flash sync speed	127, 257
Flash sync terminal	117
Flexible program	38
Flicker reduction	276
Fluorescent (White balance)	81
f-number	37, 320
Focal length	165, 322
Focal plane mark	69
Focus distance indicator	360
Focus distance mark	360
Focus indicator	31, 66, 69
Focus lock	66
Focus mode	59, 175
Focus mode switch	25, 68, 360
Focus point 31, 62, 64, 69, 177, 248, 249	
Focus point illumination	248
Focus point wrap-around	249
Focus ring	360
Focus tracking	60, 247
Focus tracking with lock-on	247
Focus-mode selector	59, 68, 175, 183
Format memory card	22, 272
Frame interval (Slide show)	234
Front-curtain sync	125
Full-frame playback	185
Full-time servo AF	175
FV lock	130
FX (36 × 24) 1.0 ×	52
FX format	52

G

GPS unit	170, 325
Green intensifier (Filter effects)	295

H

HDMI	184, 222, 362
HDMI mini-pin connector	222
HDMI-CEC	223
Help	15
Hi (Sensitivity)	71
Hide image	230
High definition	222, 362



High Dynamic Range (HDR)	112	Lo (Sensitivity).....	71
High ISO NR.....	242	Location data.....	170, 194
Highlights	190	Lock mirror up for cleaning.....	332
Histogram	191, 192, 261	Long exposure NR.....	242
I		Long time-exposures	44
Image area	25, 51, 53, 58	Lossless compressed (Type).....	57
Image comment	278	Low-pass filter	329
Image Dust Off ref photo	274	M	
Image overlay	297	M (medium)	58
Image quality.....	55	Manage Picture Control	106
Image review	187, 232	Manual.....	42
Image size	58	Manual focus	68, 183
Incandescent (White balance).....	81	Matrix	75
Index print	217	Max. continuous release	254
In-focus indicator	32, 66, 69	Maximum aperture	69, 122, 320
Information	11, 188	Maximum sensitivity	73
Information display	11, 256	Memory buffer.....	32, 47
Interval timer shooting	156	Memory card	19, 22, 272, 363, 364
ISO display	254	Memory card capacity	364
ISO sensitivity	70, 72	Metering	75
ISO sensitivity dial.....	70	Metering selector.....	76
ISO sensitivity dial lock release	70	Miniature effect	308
i-TTL.....	119, 124	Minimum aperture	25, 37
J		Minimum shutter speed.....	73
JPEG	55, 57	Mired	87
JPEG basic	55	Mirror	50, 332
JPEG compression.....	57	Mirror up	7, 46, 50
JPEG fine.....	55	Modeling flash	259
JPEG normal	55	Monitor.....	11, 34, 172, 185, 273
L		Monitor brightness	273
L (large).....	58	Monitor off delay	253
Landscape (Set Picture Control)	100	Monitor pre-flash	130, 131
Language	26, 277	Monochrome.....	294
LCD illumination	256	Monochrome (Set Picture Control)	100
LCD illuminator.....	5, 256	Multi selector.....	262
Lens	24–25, 163, 283, 318	Multiple exposure.....	149
Lens cap.....	360	My Menu	313
Lens focus ring	68, 183, 360	N	
Lens mount	69	NEF (RAW).....	55, 57, 300
Lens mounting mark.....	360	NEF (RAW) bit depth (NEF (RAW)	
Live view.....	172–184	recording)	57
Live view photography	172	NEF (RAW) processing.....	300



NEF (RAW) recording	57
Neutral (Set Picture Control)	100
No. of copies (PictBridge)	216
Noise reduction	242
Non-AI lens	25, 167
Non-CPU lens	25, 163, 318
Non-CPU lens data	163
Normal-area AF	177
Number of focus points	249
Number of photographs	30, 364

O

OK button	261
Optimal quality (JPEG compression)	57
Optional flash	258
Output resolution (HDMI)	223
Overview data	195

P

Page size (PictBridge).....	216
Perspective control	307
Photo information	188, 232
PictBridge.....	214, 362
Picture Control Utility	109
Picture Controls	100, 102
Picture size	322
Pitching.....	282
Playback.....	34, 185
Playback display options	232
Playback folder.....	230
Playback information.....	188, 232
Playback menu	229
Playback zoom	199
Portrait (Set Picture Control)	100
Power connector	323, 326
Power switch.....	5
PRE (Preset manual).....	82, 90
Predictive focus tracking	60
Preset manual (White balance) ...	82, 90
Press the shutter-release button all the way down	33
Press the shutter-release button halfway	33
Print (DPOF).....	217

Print select.....	217
Printing.....	214
Programmed auto	38
Protecting photographs.....	201

Q

Quick retouch.....	304
Quiet shutter-release.....	7, 46

R

Rank items (My Menu)	316
Rear-curtain sync	125
Recent settings	317
Red intensifier (Filter effects)	295
Red-eye correction	292
Red-eye reduction	125
Red-eye reduction with slow sync..	125
Release button to use dial	269
Release mode	7, 46
Release mode dial.....	7, 46
Remote cord	44, 50, 325
Remove items (My Menu).....	315
Reset	133, 236, 245
Resize	302
Restoring default settings	133, 224, 236, 245
Retouch menu	287
Reverse indicators	269
RGB.....	191, 240
Rolling.....	265, 282
Rotate tall.....	233

S

S (small).....	58
Save settings.....	280
Save/load settings	280
Screen tips.....	254
SD memory card... 19, 22, 272, 363, 364	
Select date	206, 217, 230
Selective color.....	309
Self-timer	7, 46, 48, 252
Sensitivity	70, 72
Sepia (Monochrome).....	294
Set Picture Control	100
Setup menu	271

Shade (White balance) 82
 Shooting data 193
 Shooting menu 235
 Shooting menu bank 236
 Shutter speed 39, 40, 42
 Shutter-priority auto 39
 Shutter-release button 31, 33, 66, 77,
 131
 Shutter-release button AE-L 251
 Shutter-speed dial 39, 40, 42
 Shutter-speed dial lock release 39, 42
 Side-by-side comparison 311
 Single frame 7, 46
 Single-point AF 62, 64
 Single-servo AF 59, 175, 246
 Size 58
 Size priority (JPEG compression) 57
 Skylight (Filter effects) 295
 Slide show 234
 Slot empty release lock 269
 Slow sync 125
 Soft (Filter effects) 295
 Spot 75
 Spot white balance 93
 sRGB 240
 Standard (Set Picture Control) 100
 Standard i-TTL flash for digital SLR 119,
 124
 Standby timer 33, 170, 251
 Start printing (PictBridge) 216, 219
 Storage folder 237
 Straighten 304
 Subject-tracking AF 177
 Sync terminal 117

T

Television 222
 Thumbnail 261
 Thumbnail playback 196
 TIFF 55
 Time 44
 Time stamp (PictBridge) 216
 Time zone 26, 276
 Time zone and date 26, 276

Timer 48, 156
 Trim 293
 Tripod 3
 Two-button reset 133
 Type (NEF (RAW) recording) 57
 Type D lens 318, 320
 Type E lens 318, 320
 Type G lens 318, 320

U

Uncompressed (Type) 57
 USB cable 211, 214
 UTC 26, 171, 194

V

Viewfinder 9, 28, 324, 353
 Viewfinder focus 28, 324
 Viewfinder grid display 253
 ViewNX 2... 56, 109, 208, 211, 240, 277–
 279
 Vignette control 241
 Virtual horizon 182, 265, 282
 Vivid (Set Picture Control) 100

W

Warm filter (Filter effects) 295
 WB 81, 141
 WB bracketing (Auto bracketing set)
 141, 259
 White balance 81, 141
 White balance bracketing 141
 Wide-area AF 177
 Wireless mobile adapter 284, 324
 Wireless remote controller 44, 325



No reproduction in any form of this manual, in whole or in part (except for brief quotation in critical articles or reviews), may be made without written authorization from NIKON CORPORATION.

Nikon User Support for India and Australia

Contact a Nikon representative for technical assistance with the operation of your Nikon product or products. For information on the Nikon representatives in your area, visit

<http://www.nikon-asia.com/support>.