

Nikon

DIGITAL CAMERA

D780

Reference Manual

- Read this manual thoroughly before using the camera.
- To ensure proper use of the camera, be sure to read "For Your Safety" (page xxxviii).
- After reading this manual, keep it in a readily accessible place for future reference.

En

Package Contents

Be sure all items listed here were included with your camera.

- Camera



- BF-1B body cap



- DK-31 rubber eyecup
(comes attached to camera)



- EN-EL15b rechargeable Li-ion battery with terminal cover

- MH-25a battery charger
(comes with either an AC wall adapter or power cable of a type and shape that varies with the country or region of sale)

- DK-5 eyepiece cap

- UC-E24 USB cable

- AN-DC21 strap

- Warranty*

- User's Manual*

- Memory cards are sold separately.
- Purchasers of the lens kit option should confirm that the package also includes a lens (manuals for the lens may also be provided).

D780 Model Name: N1722

✓ **The Nikon Download Center**

Visit the Nikon download center to download firmware updates, NX Studio and other Nikon software, and manuals for Nikon products including cameras, NIKKOR lenses, and flash units.



<https://downloadcenter.nikonimglib.com/>



About This Manual

■ Symbols

The following symbols and conventions are employed in this manual. Use them to help locate the information you need.

	This icon marks notes, information that should be read before using this product.
	This icon marks tips, additional information you may find helpful when using this product.
	This icon marks references to other sections in this manual.

■ Conventions

- This camera uses SD, SDHC, and SDXC memory cards, referred to throughout this manual as “memory cards”.
- Throughout this manual, battery chargers are referred to as “battery chargers” or “chargers”.
- Throughout this manual, smartphones and tablets are referred to as “smart devices”.
- Throughout this manual, the term “default settings” is used to refer to the settings in effect at shipment. The explanations in this manual assume that default settings are used.

For Your Safety









“For Your Safety” contains important safety instructions. Be sure to read them before using the camera. For more information, see “For Your Safety” ( xxxviii).

Table of Contents

Package Contents	ii
About This Manual.....	iv
Menu List.....	xxxii
For Your Safety	xxxviii
Notices	xliv
Getting to Know the Camera	1
<hr/>	
Parts of the Camera	1
Camera Body.....	1
The Power Switch.....	7
The Control Panel.....	8
The Viewfinder	9
The Live View Displays (Photos/Movies).....	12
Touch Controls	14
First Steps	21
<hr/>	
Readying the Camera	21
Attaching the Strap	21
Charging the Battery	22
Inserting the Battery.....	24
Attaching a Lens	25
Inserting Memory Cards.....	27
Camera Setup	30

The Battery Level and Number of Exposures Remaining	33
Battery Level.....	33
Memory Card Indicators and Number of Exposures Remaining	34
Basic Photography and Playback	36
<hr/>	
Taking Photographs (📷 Mode)	36
Framing Photographs in the Viewfinder (Viewfinder Photography)	36
Framing Photographs in the Monitor (Live View)	40
Recording Movies (📹 Mode).....	45
Taking Photos During Filming.....	50
Playback.....	51
Viewing Movies.....	53
Deleting Unwanted Pictures	56
Camera Controls	57
<hr/>	
The MENU Button	57
Using the Menus.....	58
The i Button (the i Menu)	63
The Still Photography i Menu.....	65
The Movie i Menu	66
The Playback i Menu.....	67

The  Button.....	68
Viewfinder Photography.....	68
Live View Photography.....	69
The Mode Dial.....	71
Using the Mode Dial	72
The Release Mode Dial.....	73
Choosing a Release Mode.....	73
The Focus-Mode Selector	75
The AF-Mode Button	76
Choosing an AF Mode.....	77
Choosing an AF-Area Mode	78
The AF-ON Button	82
The  Button	82
Exposure (AE) Lock.....	83
Focus Lock.....	83
Locking Focus and Exposure	83
The  (WB) Button	86
Adjusting White Balance.....	86
The ISO () Button.....	91
Adjusting ISO Sensitivity	91
Enabling Auto ISO Sensitivity Control.....	93

The  Button	94
Adjusting Exposure Compensation.....	94
The  (QUAL) Button	95
Adjusting Image Quality	95
Choosing an Image Size.....	97
The  (METERING) Button	99
Choosing a Metering Option	99
The  (FLASH) Button	101
Choosing a Flash Mode.....	101
Adjusting Flash Compensation	103
The BKT Button	104
The Pv Button	105
The Fn Button	106
Shooting Settings	107
<hr/>	
Choosing a Shooting Mode.....	107
Shooting in Modes P, S, A, and M.....	109
User Settings: U1 and U2 Modes	115
Using Special Effects Modes.....	119
Image Recording Options (Image Area, Quality, and Size).....	129
Adjusting Image Area Settings.....	129
Adjusting Image Quality	134
Choosing an Image Size.....	137

Choosing How the Camera Focuses (Focus)	139
Choosing a Focus Mode	139
Autofocus Mode.....	140
AF-Area Mode	145
Focus Point Selection	159
Manual Focus	162
Exposure-Related Settings (Metering and Exposure Compensation).....	166
Choosing How the Camera Sets Exposure	166
Long Time-Exposures (M Mode Only)	170
Autoexposure Lock	173
Exposure Compensation.....	175
Choosing the Operation Performed When the Shutter Is Released (Release Mode).....	178
Choosing a Release Mode Such as Single-Frame, Continuous, or Quiet Shutter-Release	178
Self-Timer Mode (⌚)	183
Mirror up Mode (Mup)	185
Adjusting the Camera's Sensitivity to Light (ISO Sensitivity)	187
ISO Sensitivity.....	187
Auto ISO Sensitivity Control.....	190

Achieving Natural Colors with Different Light Sources	
(White Balance).....	195
White Balance	195
Fine-Tuning White Balance.....	200
Choosing a Color Temperature	204
Preset Manual	209
Varying Exposure or White Balance over a Series of	
Photographs (Bracketing).....	224
Bracketing	225
Exposure and Flash Bracketing	226
White Balance Bracketing	232
ADL Bracketing.....	238
Image Processing (Picture Controls)	243
Selecting a Picture Control	243
Modifying Picture Controls.....	245
Creating Custom Picture Controls	250
Preserving Detail in Highlights and Shadows	
(Active D-Lighting and HDR)	254
Active D-Lighting	254
High Dynamic Range (HDR).....	256

Options for Movie Recording and Editing	262
<hr/>	
Image Area: Choosing a Movie Crop	262
Frame Size/Frame Rate and Movie Quality	264
Slow-Motion Movies.....	266
Points to Note When Recording Movies	268
Editing Movies	271
Trimming Movies	272
Saving Selected Frames.....	277
Adding Indices to Movies	278
Other Shooting Options	279
<hr/>	
Using Two Memory Cards.....	279
Deleting Copies	281
Two-Button Reset: Restoring Default Settings.....	282
Settings Accessible from the Photo Shooting Menu.....	282
Settings Accessible from the Movie Shooting Menu.....	284
Other Settings	285

Combining Multiple Exposures in a Single Photo	
(Multiple Exposure).....	287
Multiple Exposure Options	287
Creating a Multiple Exposure.....	290
Using the i Button.....	296
Ending Multiple Exposures	297
Taking Photos at a Set Interval (Interval Timer Shooting)...	298
Interval Timer Shooting Options	298
Interval-Timer Photography	303
Pausing Interval-Timer Photography.....	312
Resuming Interval-Timer Photography.....	313
Ending Interval-Timer Photography.....	314
Creating a Movie from Photos (Time-Lapse Movie)	315
Time-Lapse Movie Options	315
Recording Time-Lapse Movies	318
Varying Focus over a Series of Photos (Focus Shift	
Shooting)	328
Focus Shift Shooting Options	329
Focus-Shift Photography.....	331
The Electronic Shutter (Silent Live View Photography)	340
Photographing Film Negatives (Negative Digitizer)	343
Customizing the i Menu: Customize i Menu	347

Using Non-CPU Lenses (Non-CPU Lens Data)	349
Entering Lens Data	351
Recalling Non-CPU Lens Data	352
Playback	353
<hr/>	
Viewing Pictures.....	353
Full-Frame Playback.....	353
Thumbnail Playback	354
Calendar Playback	355
Playback Controls	356
Using the Touch Screen.....	358
The i Button.....	361
Photo Information	366
File Information	367
Exposure Data	368
Highlights	368
RGB Histogram.....	369
Shooting Data	371
Location Data	373
Overview Data	374
Taking a Closer Look: Playback Zoom.....	376
Playback Zoom	376
Protecting Photographs from Deletion.....	378
Rating Pictures.....	380

Selecting Pictures for Upload	381
Deleting Pictures	383
During Playback.....	383
The Playback Menu.....	385
Connecting to Computers and TVs	389
<hr/>	
Connecting to Computers	389
Connecting via USB	389
Wireless Networks (Wi-Fi)	394
Connecting to HDMI Devices.....	396
Connecting to HDMI TVs	397
Connecting to HDMI Recorders	397
Network Connections	402
<hr/>	
Camera and Network System Chart	402
Connecting to Smart Devices	403
The SnapBridge App	403
What SnapBridge Can Do for You	404
Wireless Connections.....	405
Connecting via Wi-Fi (Wi-Fi Mode)	406
Connecting via Bluetooth	415

Connecting to Computers via Wi-Fi.....	430
What Wi-Fi Can Do for You.....	430
The Wireless Transmitter Utility.....	430
Infrastructure and Access-Point Modes.....	431
Connecting in Access-Point Mode	433
Connecting in Infrastructure Mode.....	439
Uploading Pictures.....	447
Disconnecting and Reconnecting	451
Connecting to Networks Using the WT-7	453
The WT-7	453
What the WT-7 Can Do for You.....	454
Connecting Using the WT-7	456
Troubleshooting Wireless Issues.....	457
On-Camera Flash Photography	459
<hr/>	
“On-Camera” Versus “Remote”	459
Camera-Mounted Flash Units.....	459
Remote Flash Photography	459
Using an On-Camera Flash	460
Flash Control Mode.....	463
Flash Modes	465
Choosing a Flash Mode	468

Flash Compensation	469
Adjusting Flash Compensation	470
FV Lock.....	471
Flash Info for On-Camera Units	474
Flash Control Mode Displays.....	474
Remote Flash Photography	477
<hr/>	
What Is Remote Flash Photography?	477
Using Remote Flash Units	478
Radio AWL.....	479
Establishing a Wireless Connection.....	479
Adjusting Flash Settings	484
Adding a Shoe-Mounted Flash Unit.....	493
Optical AWL.....	494
Using Optical AWL with the SB-5000 or SB-500	495
Optical/Radio AWL.....	506
Flash Info for Remote Units	507
Flash Control Mode Displays.....	507

Defaults	511
Playback Menu Defaults.....	511
Photo Shooting Menu Defaults	512
Movie Shooting Menu Defaults.....	516
Custom Settings Menu Defaults.....	518
Setup Menu Defaults	524
▶ The Playback Menu: Managing Images.....	529
Delete	530
Playback Folder.....	530
Playback Display Options.....	531
Copy Image(s).....	532
Copying Pictures	533
Image Review	538
After Delete	539
Rotate Tall	540
Slide Show	540
Viewing Slide Shows.....	541
Rating	543

 The Photo Shooting Menu: Shooting Options.....	544
Reset Photo Shooting Menu.....	545
Storage Folder	545
Renaming Folders	545
Select Folder by Number.....	546
Select Folder from List.....	548
File Naming.....	550
Role Played by Card in Slot 2.....	551
Image Area.....	551
Image Quality.....	551
Image Size	551
NEF (RAW) Recording.....	552
NEF (RAW) Compression.....	552
NEF (RAW) Bit Depth	552
ISO Sensitivity Settings.....	553
White Balance	553
Set Picture Control	553
Manage Picture Control	554
Color Space.....	554
Active D-Lighting.....	555



Long Exposure NR.....	556
High ISO NR.....	557
Vignette Control.....	558
Diffraction Compensation	559
Auto Distortion Control	560
Flicker Reduction.....	561
Flash Control.....	563
Flash Control Mode.....	564
Wireless Flash Options.....	565
Remote Flash Control.....	566
Radio Remote Flash Info.....	566
Auto Bracketing	567
Multiple Exposure	569
HDR (High Dynamic Range)	569
Interval Timer Shooting	569
Time-Lapse Movie.....	570
Focus Shift Shooting.....	570
Silent Live View Photography	570

▶ The Movie Shooting Menu: Movie Shooting Options.....	571
Reset Movie Shooting Menu	572
File Naming.....	572
Destination	572
Image Area.....	573
Auto DX Crop.....	573
Frame Size/Frame Rate.....	573
Movie Quality.....	574
Movie File Type	574
ISO Sensitivity Settings.....	575
White Balance	576
Set Picture Control	577
Manage Picture Control	577
Active D-Lighting.....	577
High ISO NR	578
Diffraction Compensation.....	578
Flicker Reduction	579
Electronic VR.....	580
Microphone Sensitivity.....	581
Attenuator.....	582

Frequency Response.....	582
Wind Noise Reduction.....	583
Headphone Volume.....	583
Timecode	584
 Custom Settings: Fine-Tuning Camera Settings.....	586
Reset Custom Settings	590
a: Autofocus	590
a1: AF-C Priority Selection	590
a2: AF-S Priority Selection.....	591
a3: Focus Tracking with Lock-On	592
a4: 3D-Tracking Face-Detection.....	592
a5: Auto-Area AF Face/Eye Detection	593
a6: Focus Points Used	594
a7: Store Points by Orientation	595
a8: AF Activation.....	597
a9: Focus Point Wrap-Around.....	597
a10: Focus Point Options	598
Focus Point Illumination	598
Manual Focus Mode.....	598
Dynamic-Area AF Assist.....	599
a11: Low-Light AF.....	599
a12: Manual Focus Ring in AF Mode.....	600

b: Metering/Exposure	601
b1: EV Steps for Exposure Cntrl.....	601
b2: Easy Exposure Compensation	602
b3: Matrix Metering.....	603
b4: Center-Weighted Area.....	603
b5: Fine-Tune Optimal Exposure.....	604
c: Timers/AE Lock.....	605
c1: Shutter-Release Button AE-L.....	605
c2: Standby Timer	605
c3: Self-Timer	606
c4: Monitor Off Delay.....	606
d: Shooting/Display	607
d1: CL Mode Shooting Speed	607
d2: Max. Continuous Release.....	607
d3: Sync. Release Mode Options	608
d4: Exposure Delay Mode	608
d5: Electronic Front-Curtain Shutter	609
d6: Extended Shutter Speeds (M).....	610
d7: File Number Sequence	611
d8: Save Original (EFFECTS).....	613
d9: Exposure Preview (Lv)	614

d10: Framing Grid Display	615
d11: Peaking Highlights	615
d12: LCD Illumination	616
d13: Live View in Continuous Mode	616
d14: Optical VR	617
e: Bracketing/Flash	618
e1: Flash Sync Speed	618
e2: Flash Shutter Speed	620
e3: Exposure Comp. for Flash	620
e4: Auto ⚡ ISO Sensitivity Control	621
e5: Modeling Flash	621
e6: Bracketing Order	622
f: Controls	623
f1: Customize i Menu	623
View Memory Card Info	624
View Release Mode	624
Bluetooth Connection	625
Wi-Fi Connection	625
f2: Customize i Menu (Lv)	626
f3: Custom Controls	628

f4: OK Button.....	635
Viewfinder Photography	635
Live View.....	635
Playback Mode	636
f5: Customize Command Dials	637
Reverse Rotation.....	637
Change Main/Sub	637
Aperture Setting	638
Menus and Playback	639
Sub-Dial Frame Advance	640
f6: Release Button to Use Dial.....	641
f7: Reverse Indicators.....	642
f8:  Switch	642
g: Movie.....	643
g1: Customize  Menu	643
Multi-Selector Power Aperture.....	644
Multi Selector Exposure Comp.....	644
g2: Custom Controls	645
g3: AF Speed	650
g4: AF Tracking Sensitivity.....	652
g5: Highlight Display	653
Display Pattern	653
Highlight Display Threshold.....	653

Y The Setup Menu: Camera Setup.....	654
Format Memory Card	656
Save User Settings	657
Reset User Settings.....	657
Language	657
Time Zone and Date.....	658
Monitor Brightness.....	658
Monitor Color Balance.....	659
Virtual Horizon	661
Information Display.....	662
AF Fine-Tuning Options.....	663
Creating and Saving Fine-Tuning Values	665
Choosing a Default Fine-Tuning Value	667
Auto AF Fine-Tuning.....	668
Non-CPU Lens Data	672
Clean Image Sensor.....	673
Lock Mirror Up for Cleaning	674
Image Dust Off Ref Photo	675
Acquiring Image Dust Off Reference Data	675
Pixel Mapping.....	679

Image Comment	681
Input Comment.....	681
Attach Comment	681
Copyright Information.....	682
Entering the Names of the Photographer and Copyright Holder	682
Attach Copyright Information	683
Beep Options.....	684
Beep On/Off.....	684
Volume	685
Pitch	685
Touch Controls	686
Enable/Disable Touch Controls.....	686
Full-Frame Playback Flicks	686
HDMI	686
Location Data.....	687
Wireless Remote (WR) Options	688
LED Lamp	688
Link Mode.....	689
Assign Remote (WR) Fn Button	691
Airplane Mode	691

Connect to Smart Device	692
Pairing (Bluetooth)	692
Select to Send (Bluetooth).....	693
Wi-Fi Connection	694
Connect to PC.....	696
Wi-Fi Connection	696
Network Settings	696
Options	698
MAC Address	699
Wireless Transmitter (WT-7)	700
Wireless Transmitter	700
Conformity Marking	700
Battery Info	701
Slot Empty Release Lock.....	702
Save/Load Menu Settings	703
Save Menu Settings.....	707
Load Menu Settings	707
Reset All Settings.....	708
Firmware Version	708

✎ The Retouch Menu: Creating Retouched Copies.....	709
Creating Retouched Copies.....	710
NEF (RAW) Processing: Creating JPEG Copies of NEF (RAW) Images Without a Computer	713
Trim.....	719
Resize	720
Resizing Multiple Images.....	720
D-Lighting	726
Quick Retouch	727
Red-Eye Correction	728
Straighten.....	729
Distortion Control.....	730
Perspective Control	732
Monochrome	733
Image Overlay.....	734
Add	734
Lighten and Darken.....	738
Trim Movie	743
☰MY MENU/☰RECENT SETTINGS	744
☰ My Menu: Creating a Custom Menu.....	745
☰ Recent Settings: Accessing Recently-Used Settings.....	750

Troubleshooting	751
<hr/>	
Before Contacting Customer Support	751
Problems and Solutions	753
Battery/Display	753
Shooting.....	754
Playback	762
Bluetooth and Wi-Fi (Wireless Networks).....	764
Miscellaneous.....	764
Alerts and Error Messages	765
Alerts	765
Error Messages.....	769
Technical Notes	773
<hr/>	
Camera Displays.....	773
The Viewfinder.....	773
The Information Display.....	776
Live View (Still Photography/Movies)	780
The Control Panel	784
Compatible F Mount Lenses.....	786
CPU Lenses.....	786
Non-CPU Lenses and Other Accessories	792
The Electronic Rangefinder	796

Compatible Flash Units	798
The Nikon Creative Lighting System (CLS)	798
Other Compatible Accessories	808
Attaching a Power Connector and AC Adapter	814
Charging AC Adapters	816
Software	819
Caring for the Camera	821
Storage	821
Cleaning	822
The Low-Pass Filter	823
Caring for the Camera and Battery: Cautions	832
Camera Care	832
Battery Care	836
Using the Charger	839
Using the Charging AC Adapter	839
Specifications	840
Nikon D780 Digital Camera	840
Approved Memory Cards	860
Memory Card Capacity	861
[FX (36 × 24)] Selected for Image Area	862
[DX (24 × 16)] Selected for Image Area	864

Battery Endurance.....	867
Trademarks and Licenses.....	870
Kit Lens Manual	874
<hr/>	
Kit Lenses.....	874
AF-S NIKKOR 24–120mm f/4G ED VR Lens Manual	874
Index	887
<hr/>	

Menu List

The camera offers the following menus. For a more complete description of individual menu items, refer to the “Menu Guide” chapter in the *Reference Manual*. Some items may not be displayed depending on camera settings or on the type of lens, flash unit, or other accessory attached.

PLAYBACK MENU	PHOTO SHOOTING MENU
Delete	White balance
Playback folder	Set Picture Control
Playback display options	Manage Picture Control
Copy image(s)	Color space
Image review	Active D-Lighting
After delete	Long exposure NR
Rotate tall	High ISO NR
Slide show	Vignette control
Rating	Diffraction compensation
PHOTO SHOOTING MENU	Auto distortion control
Reset photo shooting menu	Flicker reduction
Storage folder	Flash control
File naming	Auto bracketing
Role played by card in Slot 2	Multiple exposure
Image area	HDR (high dynamic range)
Image quality	Interval timer shooting
Image size	Time-lapse movie
NEF (RAW) recording	Focus shift shooting
ISO sensitivity settings	Silent live view photography

MOVIE SHOOTING MENU

Reset movie shooting menu

File naming

Destination

Image area

Frame size/frame rate

Movie quality

Movie file type

ISO sensitivity settings

White balance

Set Picture Control

Manage Picture Control

Active D-Lighting

High ISO NR

Diffraction compensation

Flicker reduction

Electronic VR

Microphone sensitivity

Attenuator

Frequency response

Wind noise reduction

Headphone volume

Timecode

CUSTOM SETTING MENU

Reset custom settings

a Autofocus

a1 AF-C priority selection

a2 AF-S priority selection

a3 Focus tracking with lock-on

a4 3D-tracking face-detection

a5 Auto-area AF face/eye
detection

a6 Focus points used

a7 Store points by orientation

a8 AF activation

a9 Focus point wrap-around

a10 Focus point options

a11 Low-light AF

a12 Manual focus ring in AF
mode

CUSTOM SETTING MENU**b Metering/exposure**

b1	EV steps for exposure cntrl
b2	Easy exposure compensation
b3	Matrix metering
b4	Center-weighted area
b5	Fine-tune optimal exposure

c Timers/AE lock

c1	Shutter-release button AE-L
c2	Standby timer
c3	Self-timer
c4	Monitor off delay

CUSTOM SETTING MENU**d Shooting/display**



d1	CL mode shooting speed
d2	Max. continuous release
d3	Sync. release mode options
d4	Exposure delay mode
d5	Electronic front-curtain shutter
d6	Extended shutter speeds (M)
d7	File number sequence
d8	Save original (EFFECTS)
d9	Exposure preview (Lv)
d10	Framing grid display
d11	Peaking highlights
d12	LCD illumination
d13	Live view in continuous mode
d14	Optical VR

CUSTOM SETTING MENU

e Bracketing/flash

e1	Flash sync speed
e2	Flash shutter speed
e3	Exposure comp. for flash
e4	Auto  ISO sensitivity control
e5	Modeling flash
e6	Bracketing order

f Controls

f1	Customize  menu
f2	Customize  menu (Lv)
f3	Custom controls
f4	OK button
f5	Customize command dials
f6	Release button to use dial
f7	Reverse indicators
f8	 switch

CUSTOM SETTING MENU

g Movie

g1	Customize  menu
g2	Custom controls
g3	AF speed
g4	AF tracking sensitivity
g5	Highlight display

SETUP MENU

Format memory card

Save user settings

Reset user settings

Language

Time zone and date

Monitor brightness

Monitor color balance

Virtual horizon

Information display

SETUP MENU

AF fine-tuning options

Non-CPU lens data

Clean image sensor

Lock mirror up for cleaning

Image Dust Off ref photo

Pixel mapping

Image comment

Copyright information

Beep options

Touch controls

HDMI

Location data

Wireless remote (WR) options

Assign remote (WR) Fn button

SETUP MENU

Airplane mode

Connect to smart device

Connect to PC

Wireless transmitter (WT-7)

Conformity marking

Battery info

Slot empty release lock

Save/load menu settings

Reset all settings

Firmware version

RETOUCH MENU

NEF (RAW) processing

Trim

Resize

D-Lighting

Quick retouch

Red-eye correction

Straighten

Distortion control

Perspective control

Monochrome

Image overlay

Trim movie

MY MENU

Add items

Remove items

Rank items

Choose tab

For Your Safety

To prevent damage to property or injury to yourself or to others, read "For Your Safety" in its entirety before using this product.

Keep these safety instructions where all those who use this product will read them.

 **DANGER:** Failure to observe the precautions marked with this icon carries a high risk of death or severe injury.

 **WARNING:** Failure to observe the precautions marked with this icon could result in death or severe injury.

 **CAUTION:** Failure to observe the precautions marked with this icon could result in injury or property damage.

WARNING

Do not use while walking or operating a vehicle.

Failure to observe this precaution could result in accidents or other injury.

Do not disassemble or modify this product. Do not touch internal parts that become exposed as the result of a fall or other accident.

Failure to observe these precautions could result in electric shock or other injury.

Should you notice any abnormalities such as the product producing smoke, heat, or unusual odors, immediately disconnect the battery or power source.

Continued operation could result in fire, burns or other injury.

Keep dry. Do not handle with wet hands. Do not handle the plug with wet hands.

Failure to observe these precautions could result in fire or electric shock.

Do not let your skin remain in prolonged contact with this product while it is on or plugged in.

Failure to observe this precaution could result in low-temperature burns.

Do not use this product in the presence of flammable dust or gas such as propane, gasoline or aerosols.

Failure to observe this precaution could result in explosion or fire.

Do not directly view the sun or other bright light source through the lens or camera.

Failure to observe this precaution could result in visual impairment.

Do not aim the flash or AF-assist illuminator at the operator of a motor vehicle

Failure to observe this precaution could result in accidents.

Keep this product out of reach of children.

Failure to observe this precaution could result in injury or product malfunction. In addition, note that small parts constitute a choking hazard. Should a child swallow any part of this product, seek immediate medical attention.

Do not entangle, wrap or twist the straps around your neck.

Failure to observe this precaution could result in accidents.

Do not use batteries, chargers, or AC adapters not specifically designated for use with this product. When using batteries, chargers, and AC adapters designated for use with this product, do not:

- **Damage, modify, forcibly tug or bend the cords or cables, place them under heavy objects, or expose them to heat or flame.**
- **Use travel converters or adapters designed to convert from one voltage to another or with DC-to-AC inverters.**

Failure to observe these precautions could result in fire or electric shock.

Do not handle the plug when charging the product or using the AC adapter during thunderstorms.

Failure to observe this precaution could result in electric shock.

Do not handle with bare hands in locations exposed to extremely high or low temperatures.

Failure to observe this precaution could result in burns, or frostbite.

 **CAUTION**

Do not leave the lens pointed at the sun or other strong light sources.

Light focused by the lens could cause fire or damage to product's internal parts. When shooting backlit subjects, keep the sun well out of the frame. Sunlight focused into the camera when the sun is close to the frame could cause fire.

Turn this product off when its use is prohibited. Disable wireless features when the use of wireless equipment is prohibited.

The radio-frequency emissions produced by this product could interfere with equipment onboard aircraft or in hospitals or other medical facilities.

Remove the battery and disconnect the AC adapter if this product will not be used for an extended period.

Failure to observe this precaution could result in fire or product malfunction.

Do not fire the flash in contact with or in close proximity to the skin or objects.

Failure to observe this precaution could result in burns or fire.

Do not leave the product where it will be exposed to extremely high temperatures, for an extended period such as in an enclosed automobile or in direct sunlight.

Failure to observe this precaution could result in fire or product malfunction.

Do not look directly at the AF-assist illuminator.

Failure to observe this precaution could have adverse effects on vision.

Do not transport cameras or lenses with tripods or similar accessories attached.

Failure to observe this precaution could result in injury or product malfunction.

DANGER (Batteries)

Do not mishandle batteries.

Failure to observe the following precautions could result in the batteries leaking, overheating, rupturing, or catching fire:

- Use only rechargeable batteries approved for use in this product.
- Do not expose batteries to flame or excessive heat.
- Do not disassemble.
- Do not short-circuit the terminals by touching them to necklaces, hairpins, or other metal objects.
- Do not expose batteries or the products in which they are inserted to powerful physical shocks.
- Do not step on batteries, pierce them with nails, or strike them with hammers.

Charge only as indicated.

Failure to observe this precaution could result in the batteries leaking, overheating, rupturing, or catching fire.

If battery liquid comes into contact with the eyes, rinse with plenty of clean water and seek immediate medical attention.

Delaying action could result in eye injuries.

Follow the instructions of airline personnel.

Batteries left unattended at high altitudes in an unpressurized environment may leak, overheat, rupture, or catch fire.

WARNING (Batteries)

Keep batteries out of reach of children.

Should a child swallow a battery, seek immediate medical attention.

Keep batteries out of reach of household pets and other animals.

The batteries could leak, overheat, rupture, or catch fire if bitten, chewed, or otherwise damaged by animals.

Do not immerse batteries in water or expose to rain.

Failure to observe this precaution could result in fire or product malfunction. Immediately dry the product with a towel or similar object should it become wet.

Discontinue use immediately should you notice any changes in the batteries, such as discoloration or deformation. Cease charging EN-EL15b rechargeable batteries if they do not charge in the specified period of time.

Failure to observe these precautions could result in the batteries leaking, overheating, rupturing, or catching fire.

When batteries are no longer needed, insulate the terminals with tape.

Overheating, rupture, or fire may result should metal objects come into contact with the terminals.

If battery liquid comes into contact with a person's skin or clothing, immediately rinse the affected area with plenty of clean water.

Failure to observe this precaution could result in skin irritation.

Notices

- No part of the manuals included with this product may be reproduced, transmitted, transcribed, stored in a retrieval system, or translated into any language in any form, by any means, without Nikon's prior written permission.
- Nikon reserves the right to change the appearance and specifications of the hardware and software described in these manuals at any time and without prior notice.
- Nikon will not be held liable for any damages resulting from the use of this product.
- While every effort has been made to ensure that the information in these manuals is accurate and complete, we would appreciate it were you to bring any errors or omissions to the attention of the Nikon representative in your area (address provided separately).

● **Notice Concerning Prohibition of Copying or Reproduction**

Note that simply being in possession of material that has been digitally copied or reproduced by means of a scanner, digital camera, or other device may be punishable by law.

• **Items prohibited by law from being copied or reproduced**

Do not copy or reproduce paper money, coins, securities, government bonds, or local government bonds, even if such copies or reproductions are stamped "Sample."

The copying or reproduction of paper money, coins, or securities which are circulated in a foreign country is prohibited.

Unless the prior permission of the government has been obtained, the copying or reproduction of unused postage stamps or post cards issued by the government is prohibited.

The copying or reproduction of stamps issued by the government and of certified documents stipulated by law is prohibited.

• **Cautions on certain copies and reproductions**

The government has issued cautions on copies or reproductions of securities issued by private companies (shares, bills, checks, gift certificates, etc.), commuter passes, or coupon tickets, except when a minimum of necessary copies are to be provided for business use by a company. Also, do not copy or reproduce passports issued by the government, licenses issued by public agencies and private groups, ID cards, and tickets, such as passes and meal coupons.

• **Comply with copyright notices**

Under copyright law, photographs or recordings of copyrighted works made with the camera cannot be used without the permission of the copyright holder. Exceptions apply to personal use, but note that even personal use may be restricted in the case of photographs or recordings of exhibits or live performances.

● Use Only Nikon Brand Electronic Accessories

Nikon cameras are designed to the highest standards and include complex electronic circuitry. Only Nikon brand electronic accessories (including lenses, chargers, batteries, AC adapters, and flash accessories) certified by Nikon specifically for use with this Nikon digital camera are engineered and proven to operate within the operational and safety requirements of this electronic circuitry.

The use of non-Nikon electronic accessories could damage the camera and may void your Nikon warranty. The use of third-party rechargeable Li-ion batteries not bearing the Nikon holographic seal shown at right could interfere with normal operation of the camera or result in the batteries overheating, igniting, rupturing, or leaking.



For more information about Nikon brand accessories, contact a local authorized Nikon dealer.

✔ Before Taking Important Pictures

Before taking pictures on important occasions (such as at weddings or before taking the camera on a trip), take a test shot to ensure that the camera is functioning normally. Nikon will not be held liable for damages or lost profits that may result from product malfunction.

✔ Life-Long Learning

As part of Nikon's "Life-Long Learning" commitment to ongoing product support and education, continually-updated information is available online at the following sites:

- **For users in the U.S.A.:** <https://www.nikonusa.com/>
- **For users in Europe:** <https://www.europe-nikon.com/support/>
- **For users in Asia, Oceania, the Middle East, and Africa:** <https://www.nikon-asia.com/>

Visit these sites to keep up-to-date with the latest product information, tips, answers to frequently-asked questions (FAQs), and general advice on digital imaging and photography. Additional information may be available from the Nikon representative in your area. See the following URL for contact information: <https://imaging.nikon.com/>

Getting to Know the Camera

Parts of the Camera

Camera Body

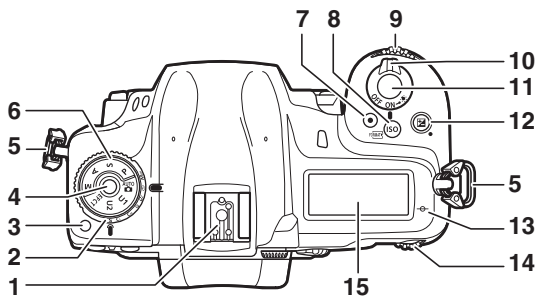

- 1 Accessory shoe (for optional flash unit)
- 2 Release mode dial (73)
- 3 Release mode dial lock release (73)
- 4 Mode dial lock release (72)
- 5 Eyelet for camera strap (21)
- 6 Mode dial (71)
- 7 Movie-record button (45)

- 8 ISO (FORMAT) button (91)
- 9 Sub-command dial
- 10 Power switch (7)
- 11 Shutter-release button (36)
- 12 AF-ON button (94)
- 13 \ominus (focal plane mark)
- 14 Main command dial
- 15 Control panel (8, 784)

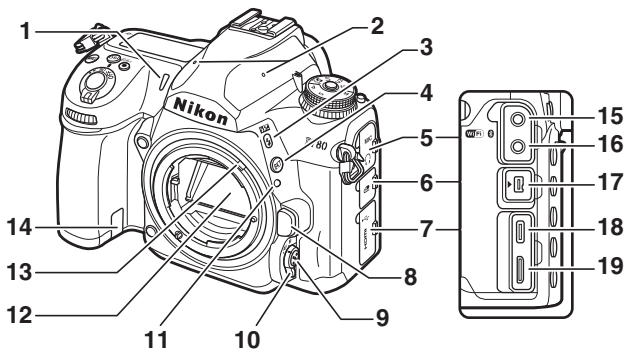

- | | | | |
|----|------------------------------------|----|--|
| 1 | Self-timer lamp | 11 | Lens mounting mark (☐ 25) |
| 2 | Stereo microphone (☐ 45) | 12 | Mirror (☐ 822) |
| 3 | ⚡ (M) button (☐ 101) | 13 | Meter coupling lever |
| 4 | BKT button (☐ 104) | 14 | Power connector cover (☐ 814) |
| 5 | Audio connector cover | 15 | Connector for external microphones (☐ 808) |
| 6 | Accessory terminal connector cover | 16 | Headphone connector |
| 7 | Cover for USB and HDMI connectors | 17 | Accessory terminal (☐ 808) |
| 8 | Lens release button (☐ 26) | 18 | USB connector |
| 9 | AF-mode button (☐ 76) | 19 | HDMI connector |
| 10 | Focus-mode selector (☐ 75) | | |

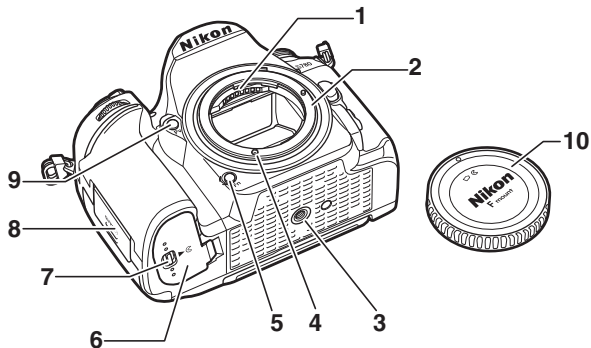

1 CPU contacts

2 Lens mount (☞ 25)

3 Tripod socket

4 AF coupling

5 **Fn** button (☞ 106)

6 Battery-chamber cover

7 Battery-chamber cover latch

8 Memory card slot cover (☞ 27)

9 **P/v** button (☞ 105)

10 Body cap (☞ 25)

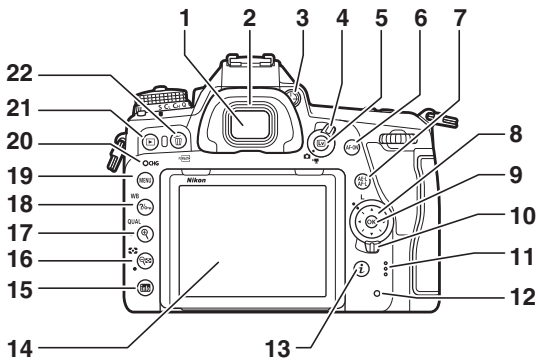

- | | | | |
|----|----------------------------------|----|-----------------------------------|
| 1 | Viewfinder eyepiece (11) | 12 | Memory card access lamp (27, 36) |
| 2 | Rubber eyecup | 13 | i button (63) |
| 3 | Diopter adjustment control (11) | 14 | Tilting monitor (5, 14) |
| 4 | Live view selector (40, 45) | 15 | info button (68) |
| 5 | L button (40, 45) | 16 | Q () button (99) |
| 6 | AF-ON button (82) | 17 | QUAL button (95) |
| 7 | AE-L/AF-ON button (82) | 18 | ?/WB (WB) button (86) |
| 8 | Multi selector (58) | 19 | MENU button (57) |
| 9 | OK button (58) | 20 | Charge lamp (816) |
| 10 | Focus selector lock | 21 | Play button (51) |
| 11 | Speaker | 22 | Trash (FORMAT) button (56) |

✓ **The Connector Covers**

Be sure to close the covers when the connectors are not in use. Foreign matter in the connectors could cause malfunction.

✓ **The Speaker**

Close proximity to the speaker could corrupt data stored on magnetic stripe cards or other such magnetic storage devices. Keep magnetic storage devices away from the speaker.

✓ **The Monitor**

The angle of the monitor can be adjusted as shown.

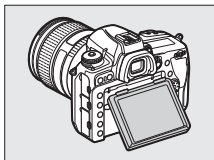
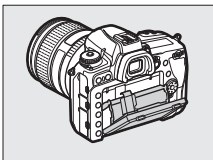

✔ The Serial Number

The product serial number is located behind the monitor.

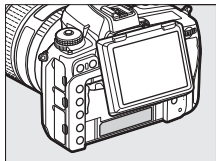

✔ Tilting the Monitor

- Rotate the monitor gently within the limits of the hinges. Do not use force; failure to observe this precaution could damage the camera or monitor.
- Do not touch the area to the rear of the monitor. Be particularly careful not to touch the area shown. Failure to observe this precaution could cause product malfunction.
- Do not allow liquid to contact the monitor's inner surface. Failure to observe this precaution could cause product malfunction.
- We recommend that you keep the monitor in the storage position when not using it to frame photographs.
- Do not lift or carry the camera by the monitor. Failure to observe this precaution could damage the camera.
- When the camera is mounted on a tripod, care should be taken to ensure that the monitor does not contact the tripod.

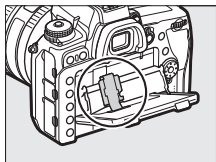

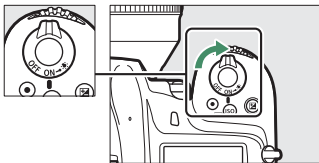

The Power Switch

Rotate the power switch to the “ON” position as shown to turn the camera on. Returning the switch to the “OFF” position turns the camera off.



✓ The LCD Illuminator

Rotating the power switch to  activates the control panel backlight (LCD illuminator). The backlight will remain lit for a few seconds after the power switch is released. The backlight turns off when the switch is rotated to  a second time or the shutter is released.

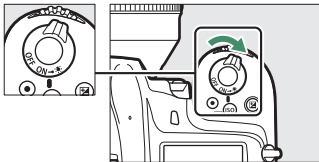

The Control Panel

The following indicators appear in the control panel at default settings. For a full list of the indicators that may be displayed, see “Camera Displays” (📖 773) in “Technical Notes”.

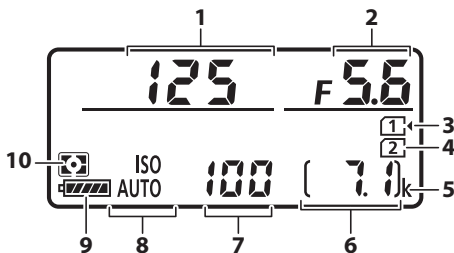

1	Shutter speed	6	Number of exposures remaining (📖 34, 861)
2	Aperture	7	ISO sensitivity (📖 91)
3	Memory card icon (Slot 1; 📖 34)	8	ISO sensitivity indicator (📖 91) Auto ISO sensitivity indicator (📖 93)
4	Memory card icon (Slot 2; 📖 34)	9	Battery indicator (📖 33)
5	"k" (appears when memory remains for over 1000 exposures; 📖 34)	10	Metering (📖 99)

✔ Camera Off Display

If the camera is turned off with a battery inserted, the control panel will display a memory card icon and the number of exposures remaining. In rare instances, some memory cards may not display the memory card icon and number of exposures remaining when the camera is off, even if a battery is inserted. This information will be displayed when the camera is turned on.

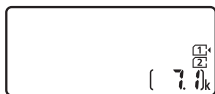

The Viewfinder

The following indicators appear in the viewfinder at default settings. For a full list of the indicators that may be displayed, see “Camera Displays” (📖 773) in “Technical Notes”.

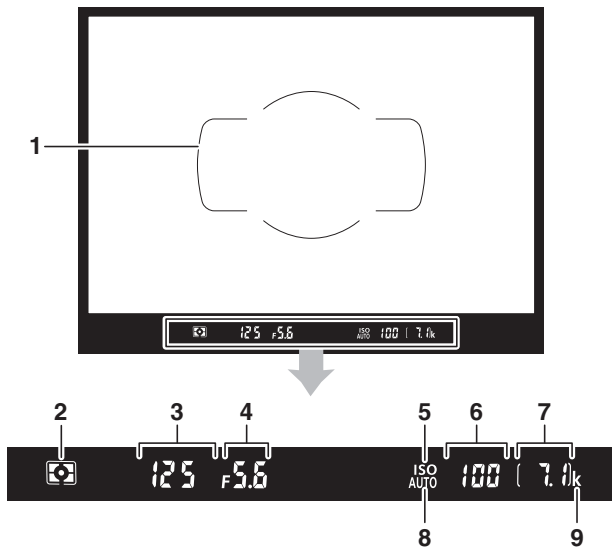

1 AF area brackets (📖 36)

2 Metering (📖 99)

3 Shutter speed

4 Aperture

5 ISO sensitivity indicator (📖 91)

6 ISO sensitivity (📖 91)

7 Number of exposures remaining (📖 34, 861)

8 Auto ISO sensitivity indicator (📖 93)

9 “k” (appears when memory remains for over 1000 exposures; 📖 34)

✓ The Viewfinder

When the battery is exhausted or no battery is inserted, the display in the viewfinder will dim. The display will return to normal when a charged battery is inserted.

✓ Temperature Extremes

The brightness of the control panel and viewfinder displays varies with temperature, and response times may drop when the temperature is low; the displays will return to normal at room temperature.

✓ Cover the Viewfinder

- When taking photos without your eye to the viewfinder, attach the supplied eyepiece cap to prevent light entering via the viewfinder appearing in photographs or interfering with exposure.
- Remove the rubber eyecup (①) and insert the supplied eyepiece cap as shown (②). Hold the camera firmly when removing the rubber eyepiece cup.

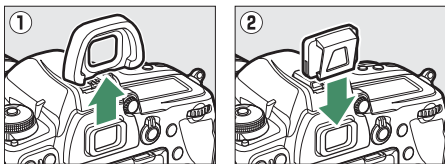

The Diopter Adjustment Control

With your eye to the viewfinder, rotate the diopter control until display in the viewfinder is in sharp focus.

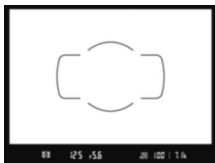
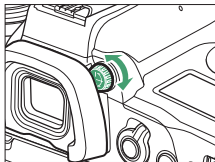

Viewfinder not in focus

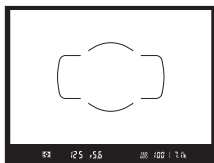

Viewfinder in focus

The Live View Displays (Photos/Movies)

Press the **[Lv]** button to display the view through the lens in the monitor. Rotate the live view selector to **[📷]** to take photographs or to **[🎥]** to record movies.

■ Live View Photography

The following indicators appear in the monitor at default settings. For a full list of the indicators that may be displayed, see “Camera Displays” in “Technical Notes” (📖 773).

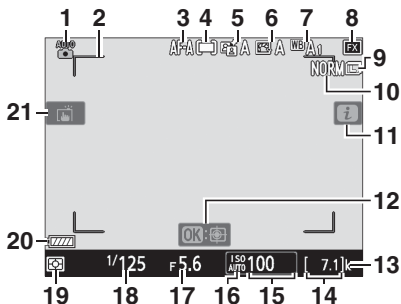

1 Shooting mode (📖 71)

2 AF-area brackets (📖 40)

3 Autofocus mode (📖 76)

4 AF-area mode (📖 78)

5 Active D-Lighting

6 Set Picture Control

7 White balance (📖 86)

8 Image area

9 Image size (📖 97)

10 Image quality (📖 95)

11 *i* icon (📖 63)

12 Subject tracking AF

- | | |
|---|--|
| <p>13 “k” (appears when memory remains for over 1000 exposures; ☞ 34)</p> <p>14 Number of exposures remaining (☞ 34, 861)</p> <p>15 ISO sensitivity (☞ 91)</p> <p>16 ISO sensitivity indicator (☞ 91)
Auto ISO sensitivity indicator (☞ 93)</p> | <p>17 Aperture</p> <p>18 Shutter speed</p> <p>19 Metering (☞ 99)</p> <p>20 Battery indicator (☞ 33)</p> <p>21 Touch shooting (☞ 14, 65)</p> |
|---|--|

■ Movies

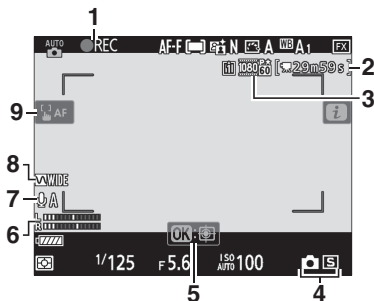

- | | |
|--|--|
| <p>1 Recording indicator (☞ 45)
“No movie” indicator</p> <p>2 Time remaining (☞ 45)</p> <p>3 Frame size and rate/image quality</p> <p>4 Release mode (still photography; ☞ 73)</p> | <p>5 Subject tracking AF</p> <p>6 Sound level (☞ 45)</p> <p>7 Microphone sensitivity</p> <p>8 Frequency response</p> <p>9 AF-area brackets (☞ 45)</p> |
|--|--|

Touch Controls

- The touch-sensitive monitor offers a variety of controls that can be operated by touching the display with your fingers.

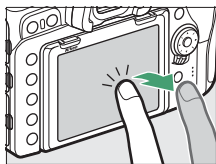

- Touch controls can be used to:
 - Focus and release the shutter (📖 14)
 - Adjust settings (📖 15)
 - View pictures (📖 16)
 - View movies (📖 17)
 - Access the **i** menu (📖 18)
 - Enter text (📖 18)
 - Navigate the menus (📖 19)

■ Focusing and Releasing the Shutter

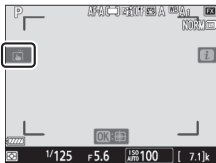
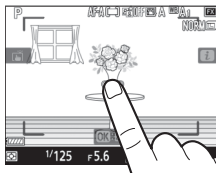

- Touch the monitor during live view to focus on the selected point (touch AF).
- During still photography, the shutter will be released when you lift your finger from the display (touch shutter).
- Touch AF settings can be adjusted by tapping the  icon.

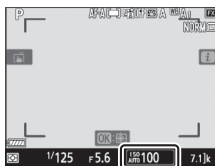

■ Adjusting Settings

- Tap highlighted settings in the display.
- You can then choose the desired option by tapping icons or sliders.



- Tap  or press  to select the chosen option and return to the previous display.



■ Playback

- Flick left or right to view other pictures during full-frame playback.

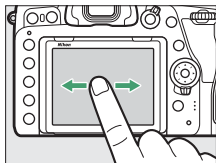

- In full-frame playback, touching the bottom of the display brings up a frame-advance bar. Slide your finger left or right over the bar to scroll rapidly to other pictures.

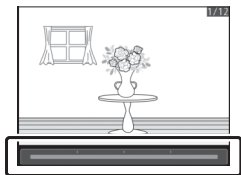
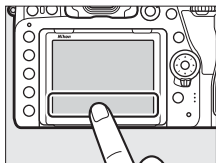

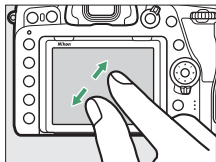

- To zoom in on a picture displayed in full-frame playback, use a stretch gesture or give the display two quick taps. After zooming in, you can adjust the zoom ratio using stretch gestures to zoom in and pinch gestures to zoom out.

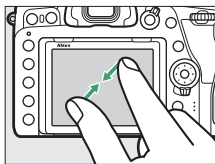

- Use slide gestures to view other parts of the image during zoom.
- Giving the display two quick taps while zoom is in effect cancels zoom.
- To “zoom out” to a thumbnail view, use a pinch gesture in full-frame playback. Use pinch and stretch to choose the number of images displayed from 4, 9, and 72 frames.
- Using a pinch gesture when 72 frames are displayed selects calendar playback. Use a stretch gesture to return to the 72-frame display.



■ Viewing Movies

- Movies are indicated by a  icon; to start playback, tap the on-screen guide.
- Tap the display to pause. Tap again to resume.
- Tap  to exit to full-frame playback.

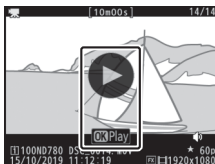

■ The *i* Menu

- Tapping the **i** icon during live view displays the *i* menu (📖 63).

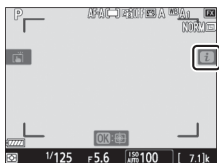

- Tap items to view options.

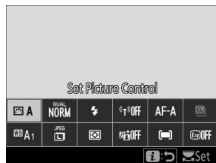

■ Text Entry

- When a keyboard is displayed, you can enter text by tapping the keys.



- 1 Text display area
- 2 Keyboard area
- 3 Keyboard selection

- To position the cursor, tap ◀ or ▶ or tap directly in the text display area.
- To cycle through the upper- and lower-case and symbol keyboards, tap the keyboard selection button.

■ Navigating the Menus

- After pressing the **MENU** button to display the menus, you can slide up or down to scroll.

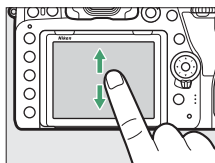

- Tap a menu icon to choose a menu.

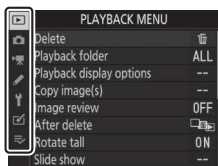

- Tap menu items to display options. You can then choose the desired option by tapping icons or sliders.

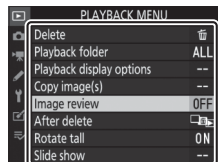

- To exit without changing settings, tap .

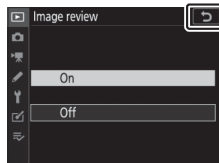

✔ **The Touch Screen**

- The touch screen responds to static electricity. It may not respond when touched with fingernails or gloved hands.
- Do not touch the screen with sharp objects.
- Do not use excessive force.
- The screen may not respond when covered with third-party protective films.
- The screen may not respond when touched simultaneously in multiple locations.

✔ **Enabling or Disabling Touch Controls**

Touch controls can be enabled or disabled using the **[Touch controls]** item in the setup menu.

First Steps

Readying the Camera

Attaching the Strap

To attach a strap (whether the supplied strap or one that has been purchased separately):

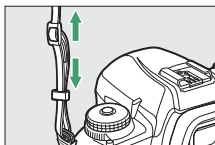
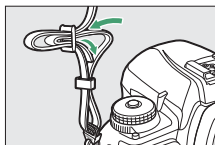
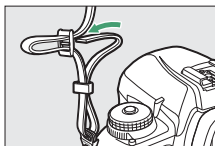
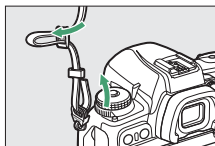

Charging the Battery

Charge the supplied EN-EL15b battery in the supplied MH-25a battery charger before use. Insert the battery and plug the charger in (depending on the country or region, the charger comes with either an AC wall adapter or a power cable).

- **AC wall adapter:** After inserting the AC wall adapter into the charger AC inlet (①), slide the AC wall adapter latch as shown (②) and rotate the adapter 90° to fix it in place (③).

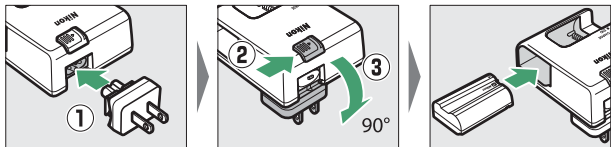

- **Power cable:** After connecting the power cable with the plug in the orientation shown, insert the battery and plug the cable in.

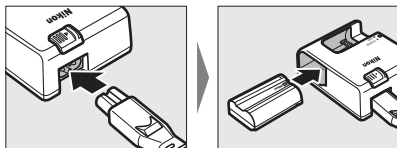

- An exhausted battery will fully charge in about two hours and 35 minutes.

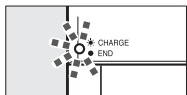

Battery charging (flashes)

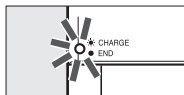

Charging complete (steady)

✓ The Battery and Charger

Read and follow the warnings and cautions in “For Your Safety” (☞ xxxviii) and “Caring for the Camera and Battery: Cautions” (☞ 832).

✓ If the CHARGE Lamp Flashes Rapidly

If the **CHARGE** lamp flashes rapidly (8 times a second):

- **A battery charging error has occurred:** Unplug the charger and remove and reinsert the battery.
- **The ambient temperature is too hot or too cold:** Use the battery charger at temperatures within the designated temperature range (0 – 40 °C).

If the problem persists, unplug the charger and end charging. Bring the battery and charger to a Nikon-authorized service representative.

Inserting the Battery

- Turn the camera off before inserting or removing the battery.
- Using the battery to keep the orange battery latch pressed to one side, slide the battery into the battery chamber until the latch locks it in place.

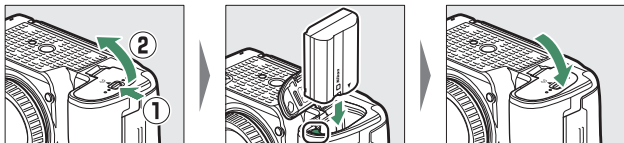

■ Removing the Battery

Turn the camera off and open the battery-chamber cover. Press the battery latch in the direction shown to release the battery and then remove the battery by hand.

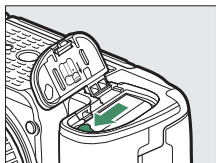

Attaching a Lens

- The lens generally used in this manual for illustrative purposes is an AF-S NIKKOR 24–120mm f/4G ED VR.
- Be careful to prevent dust entering the camera.
- Confirm that the camera is off before attaching the lens.
 - Remove the camera body cap (①, ②) and rear lens cap (③, ④).

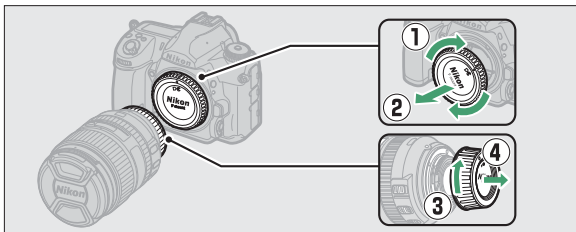

- Align the mounting marks on the camera (⑤) and lens (⑥).

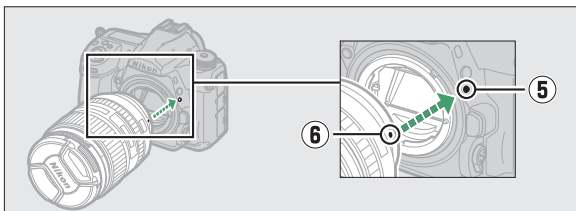

- Rotate the lens as shown until it clicks into place (7, 8).



- Remove the lens cap before taking pictures.

✓ CPU Lenses with Aperture Rings

When using a CPU lens equipped with an aperture ring (☐ 791), lock aperture at the minimum setting (highest f-number).

■ Detaching Lenses

- After turning the camera off, press and hold the lens release button (1) while turning the lens in the direction shown (2).
- After removing the lens, replace the lens caps and camera body cap.

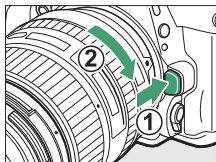

Inserting Memory Cards

- Turn the camera off before inserting or removing memory cards.
- The camera has two memory card slots: Slot 1 (①) and Slot 2 (②). If you are using only one memory card, insert it into Slot 1.

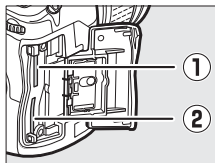

- Holding the memory card in the orientation shown, slide it straight into the slot until it clicks into place.

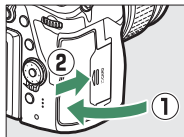
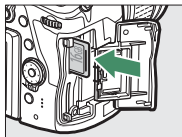
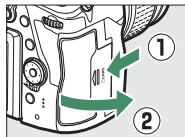

■ ■ Removing Memory Cards

After confirming that the memory card access lamp is off, turn the camera off and open the memory card slot cover. Press the card in to eject it (①); the card can then be removed by hand (②).

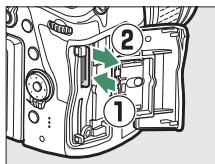

✔ Memory Cards

- Memory cards may be hot after use. Observe due caution when removing memory cards from the camera.
- Do not perform the following operations during formatting or while data are being recorded, deleted, or copied to a computer or other device. Failure to observe these precautions could result in loss of data or in damage to the camera or card.
 - Do not remove or insert memory cards
 - Do not turn the camera off
 - Do not remove the battery
 - Do not disconnect AC adapters
- Do not touch the card terminals with your fingers or metal objects.
- Do not use excessive force when handling memory cards. Failure to observe this precaution could damage the card.
- Do not bend or drop memory cards or subject them to strong physical shocks.
- Do not expose memory cards to water, heat, or direct sunlight.
- Do not format memory cards in a computer.

✔ No Memory Card Inserted

If no memory card is inserted, the exposure count displays in the control panel and viewfinder will show (- E -). If the camera is turned off with a battery and no memory card inserted, (- E -) will be displayed in the control panel.



✓ The Write Protect Switch

- SD memory cards are equipped with a write-protect switch. Sliding the switch to the “lock” position write-protects the card, protecting the data it contains.
 - If you attempt to release the shutter while a write-protected card is inserted, a warning will be displayed and no picture will be recorded. Unlock the memory card before attempting to take or delete pictures.
-

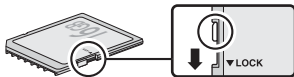

Camera Setup

Choose a language and set the camera clock. Pictures cannot be taken nor settings adjusted until the clock is set.

1 Turn the camera on.

When the camera is turned on for the first time after purchase, a language-selection dialog will be displayed. The languages available vary with the country or region in which the camera was originally purchased.

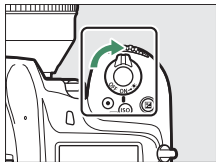

Use the multi selector and **OK** button to navigate the menus.

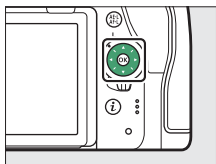

Press **▲** and **▼** to highlight a language and press **OK** to select. The language can be changed at any time using the [**Language**] item in the setup menu.

2 Set the camera clock.

Use the multi selector and  button to set the camera clock.

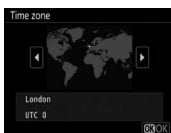

Select time zone

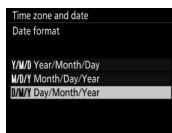

Select date format

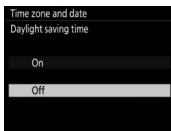

Select daylight saving time option

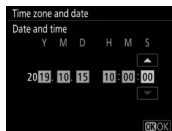

Set time and date (note that the camera uses a 24-hour clock)

The clock can be adjusted at any time using the **[Time zone and date] > [Date and time]** item in the setup menu.

✓ The **CLOCK** (“Clock Not Set”) Icon

Flashing **CLOCK** icon in the control panel indicates that the camera clock has been reset. The date and time recorded with new photographs will not be correct; use the **[Time zone and date] > [Date and time]** item in the setup menu to set the clock to the correct time and date. The camera clock is powered by an independent clock battery. The clock battery charges when the main battery is inserted or the camera is powered by an optional power connector and AC adapter. It takes about 2 days to charge. Once charged, it will power the clock for about a month.

✓ **SnapBridge**

Use the SnapBridge app to synchronize the camera clock with the clock on a smartphone or tablet (smart device). See SnapBridge online help for details.



The Battery Level and Number of Exposures Remaining

Before taking photographs, check the battery level and number of exposures remaining.

Battery Level

Check the battery level before taking photographs. The battery level is shown in the control panel and viewfinder.

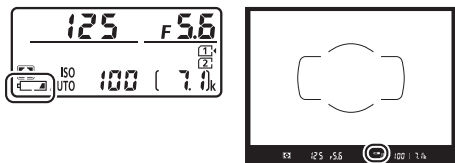

Control panel	Viewfinder	Description
	—	Battery fully charged.
	—	
	—	
	—	
		Low battery. Charge battery or ready spare battery.
(flashes)	(flashes)	Shutter release disabled. Charge or exchange battery.

Memory Card Indicators and Number of Exposures Remaining

The control panel and viewfinder show the number of additional photographs that can be taken at current settings (i.e, the number of exposures remaining).



- The control panel shows the slot or slots that currently hold a memory card (the example shows the icons displayed when cards are inserted in both slots).
- At default settings, **[Overflow]** is selected for **[Role played by card in Slot 2]** in the photo shooting menu. When two memory cards are inserted, pictures will first be recorded to the card in Slot 1, switching to Slot 2 when the card in Slot 1 is full.

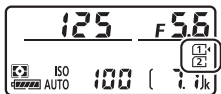

- If two memory cards are inserted, the camera will show the number of additional photographs that can be recorded to the card in Slot 1. When the card in Slot 1 is full, the display will show the number of exposures remaining on the card in Slot 2.
- Values over 1000 are rounded down to the nearest hundred. For example, values between 1400 and 1499 are shown as 1.4 k.
- If the memory card is full or locked or a card error has occurred, the icon for the affected slot will flash.

Basic Photography and Playback

Taking Photographs (AUTO Mode)

Select ^{AUTO} (auto) mode for simple “point-and-shoot” photography. Photographs can be framed in the viewfinder (viewfinder photography) or in the monitor (live view photography).

Framing Photographs in the Viewfinder (Viewfinder Photography)

- 1 Pressing the mode dial lock release on top of the camera, rotate the mode dial to ^{AUTO}.**

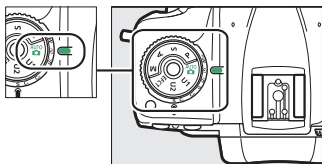

2 Ready the camera.

Holding the handgrip in your right hand and cradling the camera body or lens with your left, bring your elbows in against the sides of your chest.



3 Frame the photograph.

- *Frame a photograph in the viewfinder.*
- Position the main subject in the AF-area brackets.

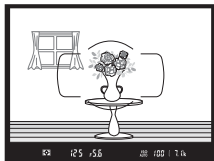

4 Press the shutter-release button halfway to focus.



- The in-focus indicator (●) will appear in the viewfinder when the focus operation is complete.

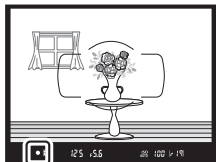

Viewfinder display	Description
● (steady)	The subject is in focus.
▶ (steady)	The focus point is in front of the subject.
◀ (steady)	The focus point is behind the subject.
▶ ◀ (flashes)	The camera is unable to focus using autofocus.

- The active focus point is displayed in the viewfinder.

5 Smoothly press the shutter-release button the rest of the way down to take the photograph.



The memory card access lamp will light while the photograph is being recorded. *Do not eject the memory card or remove or disconnect the power source until the lamp has gone out and recording is complete.*

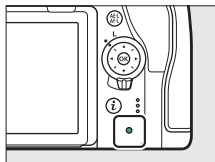

The Standby Timer (Viewfinder Photography)

The camera uses a standby timer to help reduce the drain on the battery. The timer starts when the shutter-release button is pressed halfway and expires if no operations are performed for about 6 seconds. The viewfinder display and some indicators in the control panel turn off when the timer expires. To restart the timer and restore the displays, press the shutter-release button halfway a second time. The length of time before the standby timer expires can be adjusted using Custom Setting c2 [Standby timer].

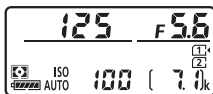

Standby timer on

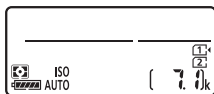

Standby timer off

Framing Photographs in the Monitor (Live View)

- 1 Pressing the mode dial lock release on top of the camera, rotate the mode dial to .**

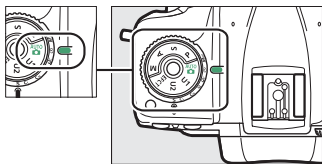

- 2 Rotate the live view selector to  (live view photography).**

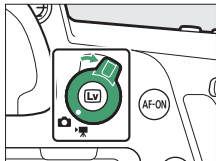

- 3 Press the  button.**

The mirror will be raised and live view will start. The viewfinder will go dark and the view through the lens will be displayed in the monitor.

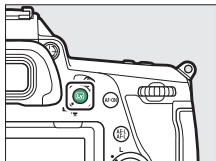

4 Ready the camera.

Hold the handgrip securely in your right hand and cradle the camera body or lens with your left.



5 Frame the photograph.

- Position the subject near the center of the frame.
- At default settings, the camera automatically detects portrait subjects and positions the focus point over their faces or eyes.

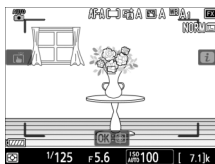

6 Press the shutter-release button halfway to focus.

If the camera is able to focus, the focus point will be displayed in green. If the camera is unable to focus, for example because the subject is too close to the camera, the focus area will flash red.



7 Press the shutter-release button the rest of the way down to take the photograph.

The monitor turns off during shooting.



8 Press the  button to exit live view.

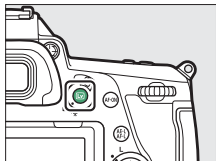

✓ Shooting in Live View

- Although these effects are not visible in the final pictures, during live view you may notice that:
 - Moving objects in the display appear distorted (individual subjects such as trains or cars moving at high speed through the frame may be distorted, or the entire frame may appear distorted when the camera is panned horizontally)
 - Jagged edges, color fringing, *moiré*, and bright spots are present in the display
 - Bright regions or bands may appear in scenes lit by flashing signs and other intermittent light sources or when the subject is briefly illuminated by a strobe or other bright, momentary light source
- Flicker and banding visible in the monitor under fluorescent, mercury vapor, or sodium lamps can be reduced using the **[Flicker reduction]** item in the movie shooting menu, although they may still be visible in photographs taken at some shutter speeds.
- To prevent light entering via the viewfinder from interfering with photographs or exposure, we recommend that you cover the viewfinder with the supplied eyepiece cap (☐ 10).
- When shooting in live view, avoid pointing the camera at the sun or other bright light sources. Failure to observe this precaution could result in damage to the camera's internal circuitry.
- Regardless of the option selected for Custom Setting c2 [**Standby timer**], the standby timer will not expire during live view.

✔ The Count Down Display

A count down will appear in the top left corner of the display approximately 30 s before live view ends automatically.

- If the timer has been triggered by Custom Setting c4 [**Monitor off delay**], the count down will be displayed in black starting 30 s before the timer expires, switching to red when there are only 5 s to go. If [**No limit**] is selected for [**Monitor off delay**] > [**Live view**], the camera may nevertheless terminate live view as necessary to protect its internal circuits from high temperatures and the like.
 - A count down will be displayed in red starting 30 s before the camera shuts down to protect its internal circuits. Depending on shooting conditions, the timer may appear immediately when live view is selected.
-

✔ Exposure Preview (Lv)

When [**On**] is selected for Custom Setting d9 [**Exposure preview (Lv)**], exposure can be previewed in the monitor during live view photography. You may find this useful when using exposure compensation or shooting in mode **M**.

✔ Touch Controls

Touch controls can be used in place of the shutter-release button to focus and take pictures during live view photography (📖 14).

Recording Movies (AUTO Mode)

 (auto) mode can also be used for simple “point-and-shoot” movie recording.

“Filming” Versus “Recording”

Throughout this manual, the terms “filming” and “recording” are used as follows: “filming” is used if the live view selector is rotated to , while “recording” refers to the act of shooting footage using the movie-record button.

- 1 Pressing the mode dial lock release on top of the camera, rotate the mode dial to .**

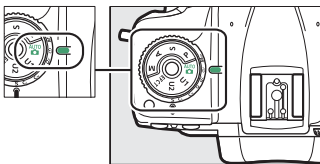

- 2 Rotate the live view selector to  (movie live view).**

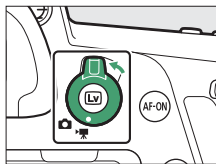

3 Press the **[Lv]** button.

- The mirror will be raised and live view will start. The viewfinder will go dark and the view through the lens will be displayed in the monitor.
- During live view, exposure for movies and photographs can be previewed in the monitor.

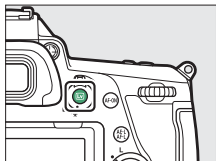

4 Press the **movie-record button** to start recording.

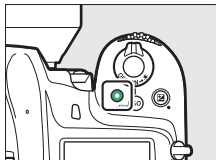

- A recording indicator will be displayed in the monitor. The monitor also shows the time remaining, or in other words the approximate amount of new footage that can be recorded to the memory card.

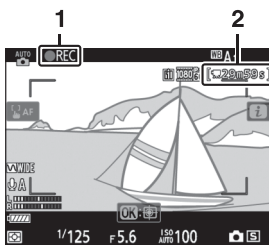

- | | |
|---|---------------------|
| 1 | Recording indicator |
| 2 | Time remaining |

- Sound is recorded via the built-in microphone. Do not cover the microphone during recording.
- Focus can be adjusted by tapping your subject in the monitor.

5 Press the movie-record button again to end recording.

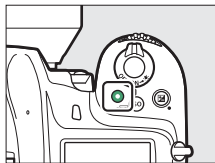

6 Press the **[Lv]** button to exit live view.

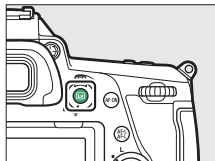

✓ Recording Movies



- When filming movies, you may notice the following in the display. These phenomena will also be visible in any footage recorded with the camera.
 - Flicker or banding in scenes lit by such sources as fluorescent, mercury vapor, or sodium lamps
 - Distortion associated with motion (individual subjects such as trains or cars moving at high speed through the frame may be distorted, or the entire frame may appear distorted when the camera is panned horizontally)
 - Jagged edges, color fringing, *moiré*, and bright spots in the display
 - Bright regions or bands in scenes lit by flashing signs and other intermittent light sources or when the subject is briefly illuminated by a strobe or other bright, momentary light source
 - Flicker occurring while power aperture is in use
- Note that noise (randomly-spaced bright pixels, fog, or lines) and unexpected colors may appear if you use the  (**QUAL**) button to zoom in on the view through the lens during filming.
- Movie recording will end automatically if:
 - The maximum length is reached
 - The live view selector is rotated to another setting
 - The lens is removed
- When recording movies, avoid pointing the camera at the sun or other strong light sources. Failure to observe this precaution could result in damage to the camera's internal circuitry.

- Sounds made by the camera may be audible in footage recorded:
 - During autofocus
 - When power aperture is used
 - During aperture adjustment
 - With vibration reduction enabled on vibration reduction (VR) lenses
- If the sound level is displayed in red, the volume is too high. Adjust microphone sensitivity.

✔ **The Count-Down Display**

- A count-down timer will be displayed in the top left corner of the monitor 30 s before movie recording ends automatically.
- Depending on shooting conditions, the timer may appear immediately when movie recording begins.
- Note that regardless of the time available (displayed in the top right corner of the monitor), filming will end automatically when the count-down timer expires.

✔ **Adjusting Settings During Movie Recording**

- Headphone volume cannot be adjusted during recording.
- If an option other than  (microphone off) is currently selected, microphone sensitivity can be changed while recording is in progress.  cannot be selected.

Focusing During Movie Recording

Focus can also be adjusted by pressing the shutter-release button halfway.

Taking Photos During Filming

Photos can be taken during filming by pressing the shutter-release button all the way down. The resulting photo will have an aspect ratio of 16:9.



- A camera icon will flash in the display when a photo is taken.
- Photos can be taken while recording is in progress. Taking photos does not interrupt movie recording.

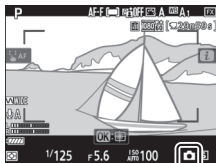

✓ Taking Photos During Filming

- Up to 40 photographs can be taken with each movie.
 - Note that photos can be taken even when the subject is not in focus.
 - Photos are recorded at the dimensions currently selected for movie frame size.
 - Photos are recorded in [JPEG fine★] format, regardless of the option selected for image quality.
 - The frame advance rate for continuous release modes varies with the option selected for [Frame size/frame rate]. While recording is in progress, only one photo will be taken each time the shutter-release button is pressed.
 - Photographs taken during filming will not be displayed automatically after shooting even if [On] is selected for [Image review] in the playback menu.
-

Playback

Press the  button to view photos and movies recorded with the camera.

1 Press the button.

- A picture will be displayed in the monitor.
- The memory card containing the picture currently displayed is shown by an icon.

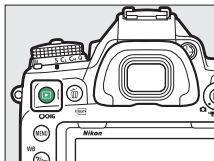

2 Press or to view additional pictures.

- Additional pictures can also be viewed by flicking a finger left or right over the display ( 14).
- To end playback and return to shooting mode, press the shutter-release button halfway.

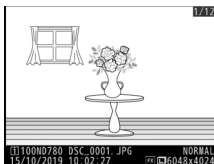



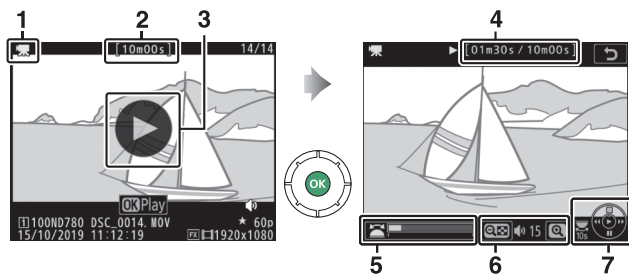

Image Review

When **[On]** is selected for **[Image review]** in the playback menu, pictures are automatically displayed in the monitor after shooting without the user pressing the  button.















Viewing Movies

Movies are indicated by a  icon. Tap the  icon in the display or press  to start playback (a progress bar shows your approximate position in the movie).

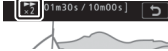
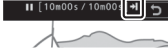

- 1  icon
- 2 Length
- 3  icon
- 4 Current position/total length
- 5 Progress bar
- 6 Volume
- 7 Guide

Movie Playback Operations

To	Description
Pause	Press  to pause playback.
Resume	Press  to resume playback when playback is paused or during rewind/advance.
Rewind/advance	<ul style="list-style-type: none"> Press  to rewind,  to advance. Speed increases with each press, from 2x to 4x to 8x to 16x. Keep  or  pressed to skip respectively to the first frame or last frame. The first frame is indicated by a  in the top right corner of the display, the last frame by a .  
Start slow-motion playback	Press  while the movie is paused to start slow-motion playback.
Jog rewind/advance	<ul style="list-style-type: none"> Press  or  while the movie is paused to rewind or advance one frame at a time. Keep  or  pressed for continuous rewind or advance.
Skip 10 s	Rotate the main command dial one stop to skip ahead or back 10 s.
Skip to last or first frame	If the movie contains no indices, you can skip to the first or last frame by rotating the sub-command dial.

To	Description
Skip to index	If the movie contains indices, rotating the sub-command dial takes you to the next or previous index. <ul style="list-style-type: none"> Indices can be added or removed from the [EDIT MOVIE] menu, which can be displayed by pausing playback and pressing the i button.
Adjust volume	Press QUAL to increase volume, QUAL (Q) to decrease.
Trim movie	To display the [EDIT MOVIE] menu, pause playback and press the i button.
Exit	Press Q or Q to exit to full-frame playback.
Exit to shooting mode	Press the shutter-release button halfway to exit playback and return to shooting mode.

Indices



Indices can be added when playback is paused by pressing the **i** button and selecting **[Add index]**. You can quickly jump to indexed locations during playback and editing. The presence of indices is indicated by a **i** icon in the full-frame playback display.



Deleting Unwanted Pictures



Pictures can be deleted as described below. *Note that once deleted, pictures cannot be recovered.*

1 Display the picture.

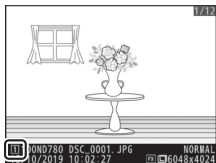
- Press the  button to start playback and press  or  until the desired picture is displayed.
- The location of the current image is shown by an icon at the bottom left corner of the display.



2 Delete the picture

- Press the  (FORMAT) button; a confirmation dialog will be displayed. Press the  (FORMAT) button again to delete the image and return to playback.
- To exit without deleting the picture, press .

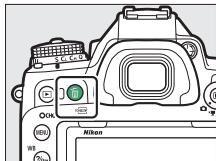

Camera Controls

The MENU Button

Press the **MENU** button to view the menus.

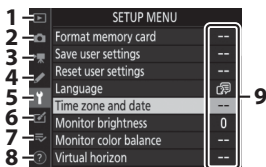
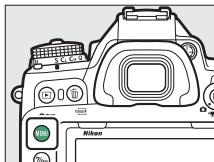

- 1 PLAYBACK MENU
- 2 PHOTO SHOOTING MENU
- 3 MOVIE SHOOTING MENU
- 4 CUSTOM SETTING MENU
- 5 SETUP MENU
- 6 RETOUCH MENU
- 7 MY MENU/
 RECENT SETTINGS *
- 8 Help icon
- 9 Current settings

* You can choose the menu displayed. The default is [**MY MENU**].

Using the Menus

You can navigate the menus using the multi selector and **OK** button.

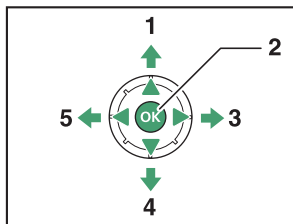

- 1 Move cursor up
- 2 Select highlighted item
- 3 Display sub-menu, select highlighted item, or move cursor right
- 4 Move cursor down
- 5 Cancel and return to previous menu, or move cursor left

1 Highlight the icon for the current menu.

Press to highlight the icon for the current menu.

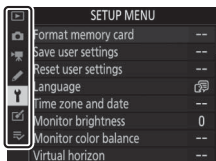

2 Select a menu.

Press or to select the desired menu.

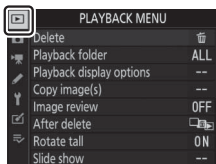

3 Position the cursor in the selected menu.

Press  to position the cursor in the selected menu.

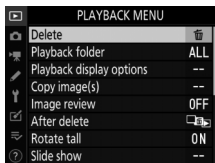

4 Highlight a menu item.

Press  or  to highlight a menu item.

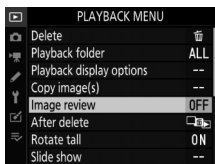

5 Display options.

Press  to display options for the selected menu item.

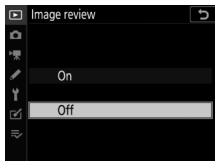

6 Highlight an option.

Press  or  to highlight an option.



7 Select the highlighted option.

- Press .
- To exit without making a selection, press the MENU button.
- To exit the menus and return to shooting mode, press the shutter-release button halfway.



✔ Grayed-Out Items

Some items and menu options may be unavailable depending on the mode and camera state. Unavailable items are displayed in gray and cannot be selected.

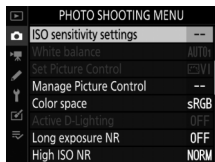

✔ Text Entry

A keyboard is displayed when text entry is required.



- 1 Text display area
- 2 Keyboard area
- 3 Keyboard selection

- Enter characters at the current cursor position by highlighting them with the multi selector and pressing **OK**.
- To move the cursor left or right in the text display area, rotate the main command dial.
- To cycle through the upper- and lower-case and symbol keyboards, highlight the keyboard selection icon and press **OK**. The keyboard selection icon may not be available in some cases.
- If a character is entered when the text display area is full, the rightmost character will be deleted.
- To delete the character under the cursor, press the **DELETE** (**FORMAT**) button.
- To complete entry, press **QUAL**.
- To exit without completing text entry, press **MENU**.

✔ The ? (Help) Icon

- Where available, a description of the currently-selected item can be viewed by pressing the ?/WB (WB) button.

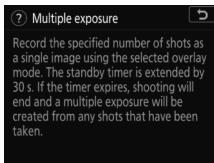
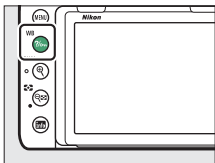

- Press or to scroll.
- Press ?/WB (WB) again to return to the menus.

✔ Touch Controls

You can also navigate the menus using touch controls (14).

The *i* Button (the *i* Menu)

For quick access to frequently-used settings, press the *i* button or tap the *i* icon in the live-view display to view the *i* menu.

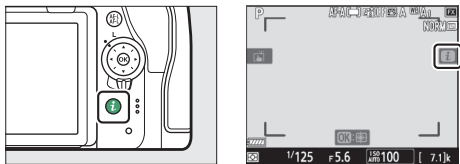

- Highlight items using the multi selector and press \odot to view options. Highlight the desired option and press \odot to select and return to the *i* menu.

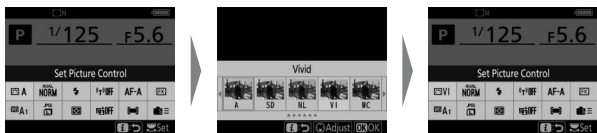

- To cancel and return to the previous display, press the *i* button.
- Different menus are displayed during viewfinder photography, live view, and movie recording.

✔ Grayed-Out Items

Some items and menu options may be unavailable depending on the mode and camera status. Unavailable items are displayed in gray and cannot be selected.

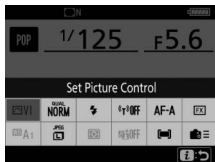

✔ The Command Dials

- The main command dial can be used to choose the setting for the item currently highlighted in the **i** menu. Options for the selected setting, if any, can be selected by rotating the sub-command dial.
- Some items can be adjusted by rotating either dial.
- Press **OK** to save changes. You can also save changes by pressing the shutter-release button halfway or highlighting another item.

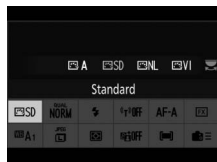

The Still Photography *i* Menu

Pressing the *i* button during still photography displays the items listed below. Highlight the desired item using the multi-selector and press \odot to view options.

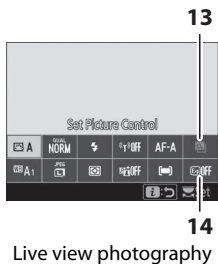
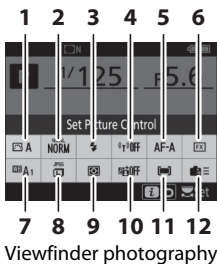

- 1 Set Picture Control
- 2 Image quality
- 3 Flash mode
- 4 Wi-Fi connection
- 5 Autofocus mode
- 6 Choose image area ¹
- 7 White balance

- 8 Image size
- 9 Metering
- 10 Active D-Lighting
- 11 AF-area mode
- 12 Custom controls ¹
- 13 Negative digitizer ²
- 14 Exposure preview ²

- 1 Displayed during viewfinder photography only.
- 2 Displayed during live view photography only.

Customize *i* Menu

Choose the items displayed in the *i* menus. Use Custom Settings f1 [**Customize *i* menu**] and f2 [**Customize *i* menu (Lv)**] to choose the items displayed in viewfinder and live photography, respectively.

The Movie **i** Menu

Pressing the **i** button during movie recording displays the items listed below. Highlight the desired item using the multi-selector and press **OK** to view options.

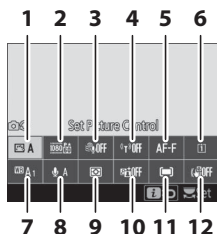

- | | | | |
|---|-----------------------------------|----|------------------------|
| 1 | Set Picture Control | 7 | White balance |
| 2 | Frame size and rate/Image quality | 8 | Microphone sensitivity |
| 3 | Wind noise reduction | 9 | Metering |
| 4 | Wi-Fi connection | 10 | Active D-Lighting |
| 5 | Autofocus mode | 11 | AF-area mode |
| 6 | Destination | 12 | Electronic VR |

Customize **i** Menu

Use Custom Setting g1 [**Customize **i** menu**] to choose the items displayed in the movie **i** menu.

The Playback *i* Menu

Pressing the *i* button during playback displays a context-sensitive *i* menu of frequently-used playback options.

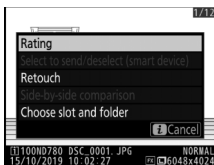
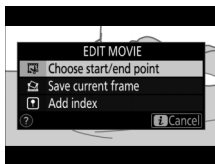

Photo playback



Movie playback



Movie playback paused

The **Info** Button

Use the **Info** button to view shooting information or choose the indicators displayed.

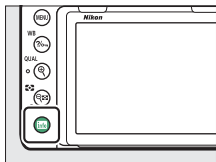

Viewfinder Photography

During viewfinder photography, you can press the **Info** button to view an information display in the monitor. The display lists such data as shutter speed, aperture, number of exposures remaining, and AF-area mode.



Live View Photography

Use the **info** button to cycle through the following displays:

Live View Selector Rotated to

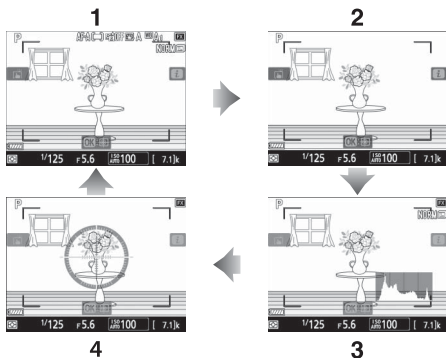

- 1 Indicators on
- 2 Simplified display
- 3 Histogram *
- 4 Virtual horizon

* Displayed when **[On]** is selected for Custom Setting d9 **[Exposure Preview (Lv)]** in mode **P**, **S**, **A**, or **M**. Not displayed if **[On]** is selected for **[Multiple exposure] > [Overlay shooting]** in the photo shooting menu.

Live View Selector Rotated to 90°

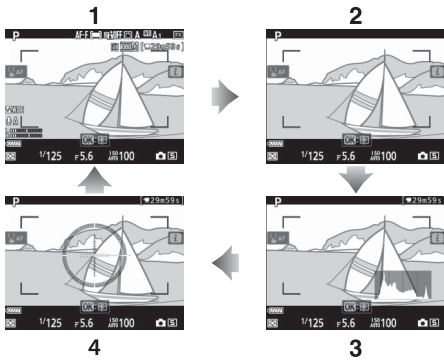

- 1 Indicators on
- 2 Simplified display
- 3 Histogram
- 4 Virtual horizon

The Mode Dial

Use the mode dial to choose a shooting mode. Choose whether to adjust shutter speed and/or aperture manually or leave the camera in charge.

Using the Mode Dial

Press the mode dial lock release and rotate the mode dial to choose from the following modes:

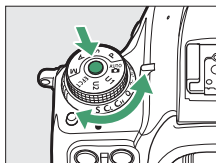

	Mode	Description
	Auto	A simple, “point-and-shoot” mode that leaves the camera in charge of settings (36, 45).
P	Programmed auto	The camera sets shutter speed and aperture for optimal exposure.
S	Shutter-priority auto	You choose the shutter speed; the camera selects the aperture for best results.
A	Aperture-priority auto	You choose the aperture; the camera selects the shutter speed for best results.
M	Manual	You control both shutter speed and aperture. Set shutter speed to “bulb” or “time” for long time-exposures.
U1/U2	User settings modes	Assign frequently-used settings to these positions. The settings can be recalled simply by rotating the mode dial.
EFCT	Special effects mode	Take pictures with added special effects.

The Release Mode Dial

Rotate the release mode dial to choose the operation performed when the shutter is released.

Choosing a Release Mode

Press the release mode dial lock release on top of the camera and rotate the release mode dial.

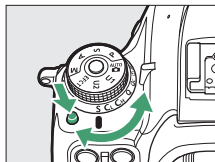

Mode		Description
S	Single frame	The camera takes one photograph each time the shutter-release button is pressed.
CL	Continuous low speed	At default settings, the camera takes photos at up to 3 fps while the shutter-release button is pressed. <ul style="list-style-type: none">The frame advance rate can be chosen using Custom Setting d1 [CL mode shooting speed]. Choose from values of from 1 to 6 fps. Note, however, that regardless of the option selected, the maximum frame advance rate during live view is 3 fps.

Mode		Description
CH	Continuous high speed	The camera takes photos at up to 7 fps while the shutter-release button is pressed. <ul style="list-style-type: none"> • When [On] is selected for [Silent live view photography] in the photo shooting menu during live view, the frame advance rate varies with the option selected for [NEF (RAW) recording] > [NEF (RAW) bit depth] in the photo shooting menu, increasing to a maximum of approximately 8 fps when [14-bit] is selected or approximately 12 fps when [12-bit] is selected.
Q	Quiet shutter-release	As for single frame except that camera noise is reduced.
QC	Quiet continuous shutter-release	The camera takes pictures at up to 3 fps while the shutter-release button is pressed; camera noise is reduced.
	Self-timer	Take pictures with the self-timer.
MUP	Mirror up	The mirror is raised before shooting to minimize blur caused by camera shake.

The Focus-Mode Selector

Choose **AF** for autofocus, **M** for manual focus.

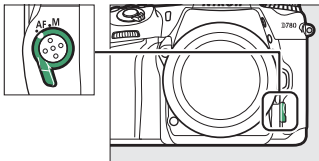

The AF-Mode Button

Choose the AF and AF-area modes. The AF mode determines how the camera focuses in autofocus mode, the AF-area mode how the camera selects the focus point for autofocus.

Choosing an AF Mode

Hold the AF-mode button and rotate the main command dial. The options available vary with camera settings.

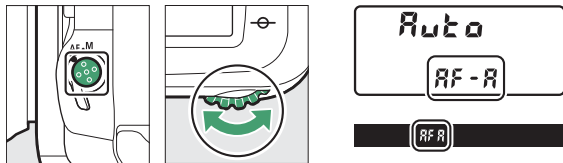

	Option	Description
AF-A	[AF mode auto-switch]	The camera uses AF-S when photographing stationary subjects and AF-C when photographing subjects that are in motion. <ul style="list-style-type: none">• This option is available only during still photography.
AF-S	[Single AF]	Use with stationary subjects. Focus locks while the shutter-release button is pressed halfway.
AF-C	[Continuous AF]	For moving subjects. The camera adjusts focus continuously in response to changes in the distance to the subject while the shutter-release button is pressed halfway.
AF-F	[Full-time AF]	The camera adjusts focus continuously in response to subject movement or changes in composition. When the shutter-release button is pressed halfway, the focus point will turn from red to green and focus will lock. <ul style="list-style-type: none">• This option is available only during movie recording.

Choosing an AF-Area Mode

Hold the AF-mode button and rotate the sub-command dial. The options available vary with the AF mode.







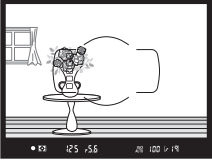

■ Viewfinder Photography

Option	Description
[Single-point AF]	The camera focuses on a point selected by the user. <ul style="list-style-type: none">• Use with stationary subjects.
[Dynamic-area AF (9 points)]/ [Dynamic-area AF (21 points)]/ [Dynamic-area AF (51 points)]	The camera focuses on a point selected by the user; if the subject briefly leaves the selected point, the camera will focus based on information from surrounding focus points. This option is available when AF-A or AF-C is selected for AF mode. <ul style="list-style-type: none">• Choose for subjects that move unpredictably. The greater the number of focus points, the wider the area used for focus.

Option	Description
[3D-tracking]	<p>The user selects the focus point; while the shutter-release button is pressed halfway, the camera will track subjects that leave the selected focus point and select new focus points as required. This option is available when AF-A or AF-C is selected for AF mode.</p> <ul style="list-style-type: none"> • Use for subjects that are moving erratically from side to side (e.g., tennis players).
[Group-area AF]	<p>The camera focuses using a group of focus points selected by the user. Priority is given to faces detected by the camera, if any.</p> <ul style="list-style-type: none"> • Choose for snapshots, subjects that are in motion, and other subjects that are difficult to photograph using [Single-point AF].
[Auto-area AF]	<p>The camera automatically detects the subject and selects the focus point. If a face is detected, the camera will give priority to the portrait subject.</p> 

Live View

Option	Description
 [PIN] [Pinpoint AF]	<p>With a focus area smaller than that employed for [Single-point AF], pinpoint AF is used for pinpoint focus on a selected spot in the frame.</p> <ul style="list-style-type: none"> • It is recommended for shots involving static subjects, such as buildings, in-studio product photography, and close-ups. • This option is available only when AF-S is selected as the AF mode for still photography.
 [Single-point AF]	<p>The camera focuses on a point selected by the user.</p> <ul style="list-style-type: none"> • Use with stationary subjects.
 [Wide-area AF (S)]	<p>As for [Single-point AF], except the camera focuses on a wider area.</p>
 [Wide-area AF (L)]	<ul style="list-style-type: none"> • Choose for snapshots, subjects that are in motion, and other subjects that are difficult to photograph using [Single-point AF].
 [Dynamic-area AF]	<p>The camera focuses on a point selected by the user. If the subject briefly leaves the selected point, the camera will focus based on information from surrounding focus points.</p> <ul style="list-style-type: none"> • Use for photographs of athletes and other active subjects that are hard to frame using [Single-point AF]. • This option is available only when AF-A or AF-C is selected as the AF mode for still photography.

Option	Description
 [Auto-area AF]	<p>The camera automatically detects the subject and selects the focus area.</p> <ul style="list-style-type: none"> • Use on occasions when you don't have time to select the focus point yourself, for portraits, or for snapshots and other spur-of-the-moment photos. • If a portrait subject is detected during live view photography, an amber border indicating the focus point will appear around the subject's face. If the camera detects the subject's eyes, the amber border will instead appear around an eye (face/eye-detection AF).

Manual Focus-Point Selection

When an option other than **[Auto-area AF]** is selected for AF-area mode, you can select the focus point manually. Press the multi selector up, down, left, or right (⬆️⬇️⬅️➡️) or diagonally to select the focus point.

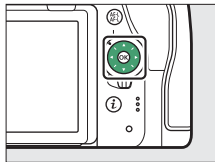

Locking Focus-Point Selection

Focus-point selection can be locked by rotating the focus selector lock to the "L" position. Focus-point selection can be re-enabled by rotating the lock to ●.

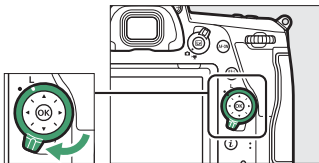

The AF-ON Button

The **AF-ON** button can be used for focus in autofocus mode.

- You can choose the role assigned to the **AF-ON** button. Use Custom Settings f3 [**Custom controls**] and g2 [**Custom controls**] in the Custom Settings menu to choose the roles played by the button during photography and movie recording, respectively.

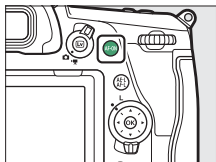

The AE-L/AF-L Button

Press the AE-L/AF-L (AE-L/AF-L) button to lock focus and exposure for photographs taken using autofocus.

- You can choose the role assigned to the AE-L/AF-L button. Use Custom Settings f3 [**Custom controls**] and g2 [**Custom controls**] in the Custom Settings menu to choose the roles played by the button during photography and movie recording, respectively.

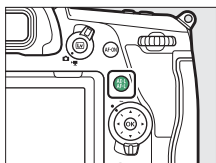

Exposure (AE) Lock

Exposure lock can be used to recompose shots after metering a subject that will not be in the selected focus area in the final composition. Exposure lock is particularly effective when [**Spot metering**] or [**Center-weighted metering**] is selected for metering.

Focus Lock

Use focus lock to lock focus on the current subject when **AF-A** or **AF-C** is selected for AF mode. When using focus lock, choose an AF-area mode other than [**Auto-area AF**].

Locking Focus and Exposure

- 1 Position the subject in the selected focus point and press the shutter-release button halfway to set focus and exposure.**

2 With the shutter-release button pressed halfway

(1), press the $\overset{\text{AE-L}}{\text{AF-L}}$ button (2).

- Focus and exposure will lock while the $\overset{\text{AE-L}}{\text{AF-L}}$ button is pressed. Exposure will not change even when the composition is altered.

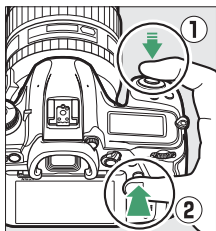

- An **AE-L** icon will be displayed in the viewfinder or monitor.

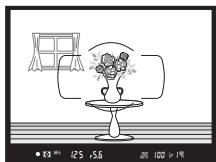

3 Keeping the $\overset{\text{AE-L}}{\text{AF-L}}$ button pressed, recompose the photograph.

Do not change the distance between the camera and the subject. If the distance to the subject changes, release the lock and focus again at the new distance.

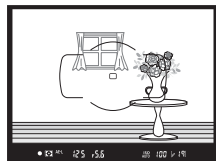

Locking Focus When AF-S Is Selected for AF Mode

Focus will lock while the shutter-release button is pressed halfway. Focus will also lock while the  button is pressed.

Using the Shutter-Release Button for Exposure Lock

If [On (half press)] is selected for Custom Setting c1 [Shutter-release button AE-L], exposure will lock while the shutter-release button is pressed halfway.

Taking Multiple Shots at the Same Focus Distance

- Focus will remain locked if you keep the  button pressed between shots, allowing several photographs in succession to be taken at the same focus setting.
 - Focus will also remain locked if you keep the shutter-release button pressed halfway between shots.
-

The ?/WB (WB) Button

The ?/WB (WB) button can be used during shooting to adjust white balance. White balance delivers natural colors with light sources of different hues.

✓ The ?/WB (WB) Button

The ?/WB (WB) button may be disabled in some shooting modes or when certain conditions apply.

Adjusting White Balance

Hold the ?/WB (WB) button and rotate the main command dial.

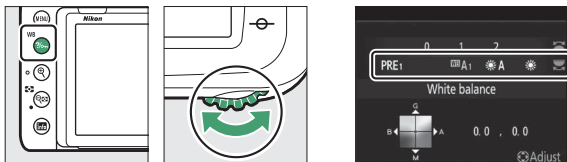

Options for the selected setting, if any, can be selected by holding the **WB** button and rotating the sub-command dial.

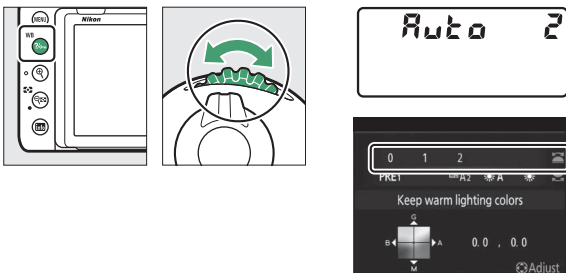

If coordinates are displayed as shown, you can hold the **WB** button and fine-tune white balance using the multi selector.

- Press or to fine-tune white balance on the amber-blue axis and or to fine-tune white balance on the green-magenta axis.

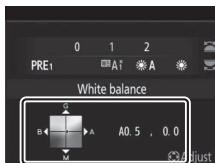

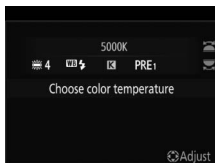

- When [**Choose color temperature**] is selected, you can press or to highlight a digit. Press or to change.



- Release the **WB** button to return to shooting mode.

Option	Description
WB A [Auto]	White balance is adjusted automatically for optimal results with most light sources.
WB A₀ [Keep white (reduce warm colors)]	Eliminate the warm color cast produced by incandescent lighting.
WB A₁ [Keep overall atmosphere]	Partially preserve the warm color cast produced by incandescent lighting.
WB A₂ [Keep warm lighting colors]	Preserve the warm color cast produced by incandescent lighting.
☀️ A [Natural light auto]	When used under natural light in place of WB A ([Auto]) , this option produces colors closer to those seen by the naked eye.
☀️ [Direct sunlight]	Use with subjects lit by direct sunlight.
☁️ [Cloudy]	Use in daylight under overcast skies.
🏠 [Shade]	Use in daylight with subjects in shade.
💡 [Incandescent]	Use under incandescent lighting.

Option	Description
 [Fluorescent] [Sodium-vapor lamps] [Warm-white fluorescent] [White fluorescent] [Cool-white fluorescent] [Day white fluorescent] [Daylight fluorescent] [High temp. mercury-vapor]	Use under fluorescent lighting; choose the bulb type according to the light source.
WB  [Flash]	Use with studio strobe lighting and other large flash units.
 [Choose color temperature]	Choose the color temperature directly.
PRE [Preset manual]	Measure white balance for the subject or light source or copy white balance from an existing photograph.

✔ Protecting Pictures from Deletion

During playback, the **?**/**WB** button can be used to protect pictures. Protecting pictures helps prevent accidental deletion.

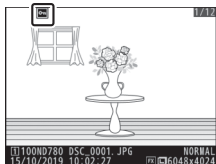

✔ Viewing Help

Where available, a description of the currently-selected item can be viewed by pressing the **?**/**WB** button (📖 62).

The ISO (FORMAT) Button

Use the **ISO** (FORMAT) button to adjust the camera's sensitivity to light (ISO sensitivity). The higher the ISO sensitivity, the less light needed to make an exposure, allowing faster shutter speeds or smaller apertures. You also have the option of enabling auto ISO sensitivity control, which automatically adjusts sensitivity if optimal exposure cannot be achieved at the setting selected by the user.

Adjusting ISO Sensitivity

Hold the **ISO** (FORMAT) button and rotate the main command dial.

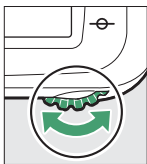
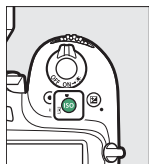

- Choose from values of from ISO 100 to 51200. Settings of from about 0.3 to 1 EV below ISO 100 and 0.3 to 2 EV above ISO 51200 are also available.
- In addition to settings of from ISO 100 to 51200, **AUTO** and all **EFCT** modes other than **[A]** also offer an **Auto** ([Auto]) option. When **Auto** is selected, the camera adjusts ISO sensitivity automatically.



✓ High ISO Sensitivities

The higher the ISO sensitivity, the less light needed to make an exposure, allowing pictures to be taken when lighting is poor and helping prevent blur when the subject is in motion. Note, however, that the higher the sensitivity, the more likely the image is to be affected by “noise” in the form of randomly-spaced bright pixels, fog, or lines.

Enabling Auto ISO Sensitivity Control

In **P**, **S**, **A**, and **M** modes, you can hold the **ISO** (FORMAT) button and rotate the sub-command dial to choose whether the camera will automatically adjust ISO sensitivity if the desired exposure cannot be achieved at the value selected by the user.

- When auto ISO sensitivity control is enabled, **ISO AUTO** indicators will appear in the control panel and viewfinder. When these indicators are lit (not flashing), pictures will be taken at the sensitivity selected for **[ISO sensitivity]**. When sensitivity is altered from the value selected by the user, the **ISO AUTO** indicators will flash and the altered value will be shown in the displays.

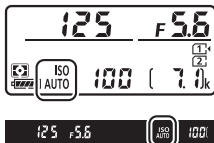
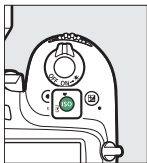

Maximum Sensitivity

In modes **P**, **S**, **A**, and **M**, you can select an upper limit for auto ISO sensitivity control to prevent ISO sensitivity being raised too high. The maximum ISO sensitivity can be selected using the **[ISO sensitivity settings] > [Auto ISO sensitivity control] > [Maximum sensitivity]** item in the photo shooting menu.

The Button

Use the  (exposure compensation) button to alter exposure from the value suggested by the camera. Exposure compensation can be used to make pictures brighter or darker.



-1 EV

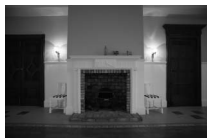

No exposure
compensation



+1 EV

The Button

The  button may be disabled in some shooting modes or when certain conditions apply.

Adjusting Exposure Compensation

Hold the  button and rotate the main command dial.

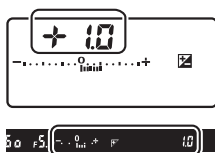
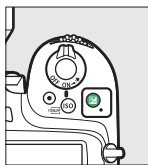

- Higher values make the subject brighter, lower values darker.
- Normal exposure can be restored by setting exposure compensation to ± 0.0 . Exposure compensation is not reset when the camera is turned off.

The (QUAL) Button

The  (QUAL) button is used to adjust image quality and choose the size of JPEG images.

Adjusting Image Quality

During viewfinder photography, image quality can be adjusted by holding the  (QUAL) button and rotating the main command dial.

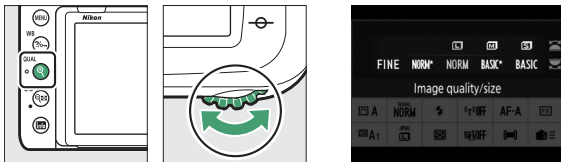

Option	Description
[NEF (RAW) + JPEG fine★]	Record two copies of each photo: an NEF (RAW) image and a JPEG copy. For the JPEG copy, you can choose from options prioritizing image quality or file size. Options with a star ("★") prioritize image quality, those without a star ("★") file size.
[NEF (RAW) + JPEG fine]	
[NEF (RAW) + JPEG normal★]	
[NEF (RAW) + JPEG normal]	
[NEF (RAW) + JPEG basic★]	
[NEF (RAW) + JPEG basic]	
[NEF (RAW)]	Record photos in NEF (RAW) format.
[JPEG fine★]	Record photos in JPEG format. Image quality increases as quality progress from basic through normal to fine. Options with a star ("★") prioritize image quality, those without a star ("★") file size.
[JPEG fine]	
[JPEG normal★]	
[JPEG normal]	
[JPEG basic★]	
[JPEG basic]	

Choosing an Image Size

During viewfinder photography, image size can be adjusted by holding the **Q** (QUAL) button and rotating the sub-command dial.

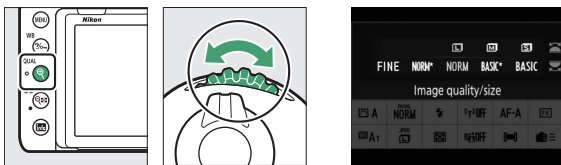



Choose from [**Large**], [**Medium**], and [**Small**]; the selected option applies to JPEG photos. The physical dimensions of the photos in pixels varies with image area.

Image area	Image size		
	[Large]	[Medium]	[Small]
[FX (36×24)]	6048×4024	4528×3016	3024×2016
[DX (24×16)]	3936×2624	2944×1968	1968×1312
[1:1 (24×24)]	4016×4016	3008×3008	2000×2000
[16:9 (36×20)]	6048×3400	4528×2544	3024×1696



Zoom Preview (Live View Photography)

Press the  (**QUAL**) button to zoom in on the view through the lens in the monitor.

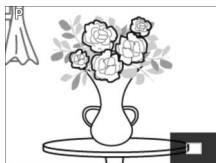

- The zoom ratio increases each time the  (**QUAL**) button is pressed; to zoom out, press .
- While the view through the lens is zoomed in, a navigation window will appear in a gray frame at the bottom right corner of the display.
- Use the multi selector to scroll to areas of the frame not visible in the monitor.
- During live view photography, image quality and size can be adjusted using the [**Image quality**] and [**Image size**] items in the photo shooting menu.



The () Button

Use the  () button to choose how the camera meters light when setting exposure.

✔ The () Button

The  () button may be disabled in some shooting modes or when certain conditions apply.

Choosing a Metering Option

Hold the  () button and rotate the main command dial.

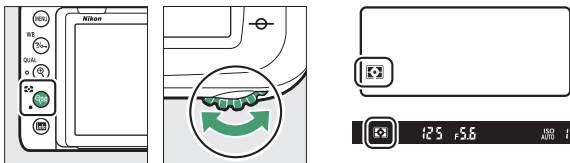

Option	Description
☒	[Matrix metering] Matrix metering is adapted to a wide range of subjects. It produces natural-looking results.
☒	[Center-weighted metering] The camera assigns the greatest weight to the center of the frame. It can be used with subjects that dominate the composition, for example.
☐	[Spot metering] The camera meters a circle 4 mm (0.16 in.) in diameter (approximately 1.5% of frame). Use for example to meter a specific area of the frame when your subject is backlit or features sharply contrasting areas.
☐*	[Highlight-weighted metering] The camera assigns the greatest weight to highlights. Use this option to reduce loss of detail in highlights, for example when photographing spotlight performers on stage.

The Button

Use the  button to adjust flash mode and compensation when using optional flash units. Flash mode determines the effect produced by the flash, flash compensation the flash level.







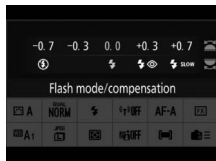
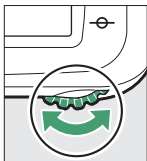
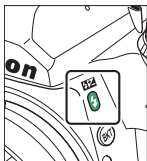

✔ The Button

The  button may be disabled in some shooting modes or when certain conditions apply.

Choosing a Flash Mode

Hold the  button and rotate the main command dial.



Option	Description	Shooting mode
 [Fill flash] (front-curtain sync)	This mode is recommended for most situations.	^{AUTO}  P, S, A, M, EFCT (ⓧ and ✎ excluded)
 [Red-eye reduction] (red-eye reduction)	The flash fires before the photograph is taken, reducing “red-eye”.	^{AUTO}  P, S, A, M, EFCT (ⓧ and ✎ excluded)
 [Slow sync] (slow sync)	As for “fill flash”, except that slow shutter speeds are used to capture background lighting at night or under low light.	P, A
 [Slow sync + red-eye] (red-eye reduction with slow sync)	As for “red-eye reduction”, except that slow shutter speeds are used to capture background lighting at night or under low light.	P, A
 [Rear-curtain sync] (rear-curtain sync)	The flash fires just before the shutter closes.	P, S, A, M
 [Flash off]	The flash does not fire.	^{AUTO}  P, S, A, M, EFCT

Adjusting Flash Compensation

Hold the  button and rotate the sub-command dial.

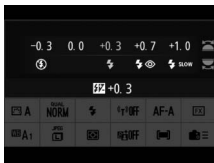
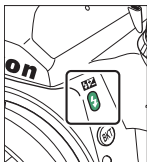

- Choose positive values for brighter lighting, negative values to ensure that the subject is not too brightly lit.
- Normal flash output can be restored by setting flash compensation to ± 0.0 . Flash compensation is not reset when the camera is turned off.

The BKT Button

Use the **BKT** button to choose the bracketing increment and number of shots in the bracketing program. Bracketing is used to vary exposure, flash level, white balance, or Active D-Lighting (ADL) over a series of shots.

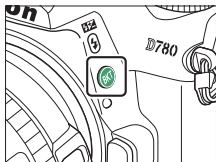

- The role performed by the **BKT** button can be chosen using Custom Setting f3 [**Custom controls**].

✓ The BKT Button

The **BKT** button may be disabled in some shooting modes or when certain conditions apply.

The Pv Button

To stop the lens down to the selected aperture and preview depth of field during shooting, press and hold the **Pv** button.

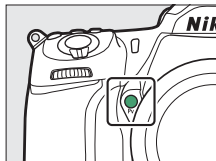

- Optional flash units compatible with the Nikon Creative Lighting System (CLS) will emit a modeling flash. The modeling flash can be disabled by selecting [**Off**] for Custom Setting e5 [**Modeling flash**].
- You can choose the role assigned to the **Pv** button. Use Custom Settings f3 [**Custom controls**] and g2 [**Custom controls**] in the Custom Settings menu to choose the roles played by the button during photography and movie recording, respectively.

✓ The Pv Button

The **Pv** button may be disabled in some shooting modes or when certain conditions apply.

The Fn Button

Use the **Fn** button for quick access to selected settings.

- The assigned setting can be adjusted by holding the **Fn** button and rotating the command dials. In some cases, adjustments can be made using both the main and sub-command dials.
- Use Custom Settings f3 [**Custom controls**] and g2 [**Custom controls**] in the Custom Settings menu to choose the roles played by the **Fn** button during photography and movie recording, respectively.
- The default assignment for the **Fn** button is [**Choose image area**].

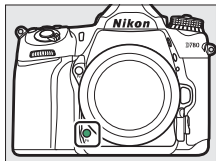

✓ The Fn Button

The **Fn** button may be disabled in some shooting modes or when certain conditions apply.

Shooting Settings

Choosing a Shooting Mode

Keeping the mode dial lock release pressed, rotate the mode dial to choose from the following modes:

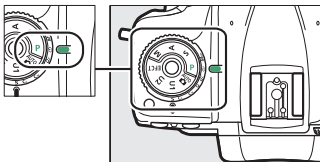

	Mode	Description
	Auto (☞ 36, 45)	A simple, “point-and-shoot” mode that leaves the camera in charge of settings.
P	Programmed auto (☞ 109)	Camera sets shutter speed and aperture for optimal exposure. Recommended for snapshots and in other situations in which there is little time to adjust camera settings.
S	Shutter-priority auto (☞ 110)	User chooses shutter speed; camera selects aperture for best results. Use to freeze or blur motion.

	Mode	Description
A	Aperture-priority auto (☞ 111)	User chooses aperture; camera selects shutter speed for best results. Use to blur background or bring both foreground and background into focus.
M	Manual (☞ 113)	User controls both shutter speed and aperture. Set shutter speed to Bulb or Time for long time-exposures.
U1/U2	User settings modes (☞ 115)	Assign frequently-used settings to these positions for quick recall.
EFCT	Special effects mode (☞ 119)	Take pictures with added special effects.

✓ Lens Types

- When using a CPU lens of a type other than G or E, lock the aperture ring at the minimum aperture (highest f-number).
- Mode **A** will be selected automatically if a non-CPU lens is attached in mode **P** or **S**. “**A**” will appear in the information display.

Shooting in Modes P, S, A, and M

■ ■ P (Programmed Auto)

In this mode, the camera automatically adjusts shutter speed and aperture according to a built-in program to ensure optimal exposure in most situations. You also have the option of choosing different combinations of shutter speed and aperture without altering exposure (“flexible program”).

📌 Flexible Program

Mode **P** offers “flexible program”, in which although the camera chooses the initial shutter speed and aperture, while the standby timer is on the main command dial can be rotated to select different combinations without altering exposure from the value chosen by the camera. While flexible program is in effect, a flexible program indicator (“”) appears in the viewfinder.

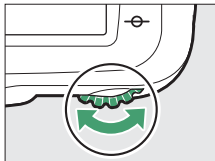

- To restore default shutter speed and aperture settings, rotate the dial until the flexible program indicator is no longer displayed, choose another mode, or turn the camera off.

■ S (Shutter-Priority Auto)

In shutter-priority auto, you choose the shutter speed while the camera automatically selects the aperture that will produce the optimal exposure. To choose a shutter speed, rotate the main command dial while the exposure meters are on.

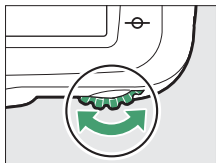

- Shutter speed can be set to "x 200" or to values between 30 s (30'') and $1/8000$ s (8000).

■ ■ A (Aperture-Priority Auto)

In aperture-priority auto, you choose the aperture while the camera automatically selects the shutter speed that will produce the optimal exposure. To adjust aperture, rotate the sub-command dial while the exposure meters are on.



- Aperture can be set to values between the minimum and maximum values for the lens.

✔ Non-CPU Lenses

Use the lens aperture ring to adjust aperture. If the maximum aperture of the lens has been specified using the **[Non-CPU lens data]** item in setup menu when a non-CPU lens is attached, the current f-number will be displayed in the viewfinder and control panel, rounded to the nearest full stop.

- Otherwise the aperture displays will show only the number of stops (ΔF , with maximum aperture displayed as $\Delta F0$) and the f-number must be read from the lens aperture ring.

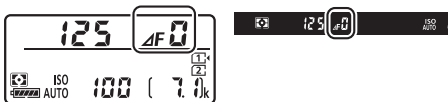

✔ Depth-of-Field Preview

Aperture can be stopped down by pressing and holding the **Pv** button. Depth of field (the range of distances that appears to be in focus) can then be previewed in the viewfinder.

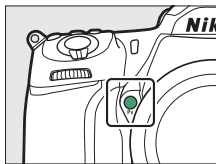

■ M (Manual)

You control both shutter speed and aperture. Choose this mode for long time-exposures of such subjects as fireworks or the night sky (Bulb or Time photography,  170). Shutter speed and aperture can be adjusted with reference to the exposure indicators by rotating the command dials as follows while the standby timer is on:

- Rotate the main command dial to choose the shutter speed. Shutter speed can be set to values between $\frac{1}{8000}$ s (**8000**) and 30 s (**30'**), to **b** (Bulb) or **-** (Time), or to **x** (200).
- Aperture can be adjusted by rotating the sub-command dial.
- The minimum and maximum values for aperture vary with the lens.

Shutter speed:

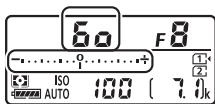

Aperture:



✔ AF Micro NIKKOR Lenses

Provided that an external exposure meter is used, the exposure ratio need only be taken into account when the lens aperture ring is used to set aperture.

✔ Extended Shutter Speeds

For shutter speeds as slow as 900 s (15 minutes), select [On] for Custom Setting d6 [Extended shutter speeds (M)].

✔ Exposure Indicators

The exposure indicators in the viewfinder and control panel show whether the photograph would be under- or over-exposed at current settings. Depending on the option chosen for Custom Setting b1 [EV steps for exposure cntrl], the amount of under- or overexposure is shown in increments of $\frac{1}{3}$ EV or $\frac{1}{2}$ EV.

	Custom Setting b1 set to $\frac{1}{3}$ step		
	Optimal exposure	Underexposed by $\frac{1}{3}$ EV	Overexposed by over 3 EV
Control panel			
Viewfinder			

- The orientation of the exposure indicators can be reversed using Custom Setting f7 [Reverse indicators].

✔ Exposure Warning

If the limits of the exposure metering system are exceeded, the displays will flash.

User Settings: U1 and U2 Modes

Assign frequently-used settings to the **U1** and **U2** positions on the mode dial.

■ Saving User Settings

Follow the steps below to save settings:

1 Adjust settings.

Make the desired adjustments to camera settings, including:

- photo shooting menu options (some settings excluded),
- movie shooting menu options (some settings excluded),
- Custom Settings, and
- shooting mode, shutter speed (modes **S** and **M**), aperture (modes **A** and **M**), flexible program (mode **P**), exposure and flash compensation.

2 Select [Save user settings].



Press the **MENU** button to display the menus. Highlight [**Save user settings**] in the setup menu and press .



3 Select a position.

Highlight [**Save to U1**] or [**Save to U2**] and press .

4 Save user settings.

Highlight [**Save settings**] using  and  and press  to assign current settings to the selected user settings mode.

5 Take pictures using saved settings.

Rotate the mode dial to **U1** or **U2** to recall the settings last saved to the selected position.

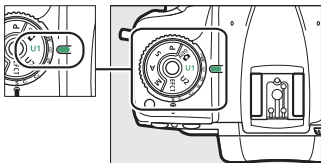

User Settings

The following cannot be saved to **U1** or **U2**.

- Photo shooting menu:
 - [**Storage folder**]
 - [**Image area**]
 - [**Manage Picture Control**]
 - [**Multiple exposure**]
 - [**Interval timer shooting**]
 - [**Time-lapse movie**]
 - [**Focus shift shooting**]
 - Movie shooting menu:
 - [**Image area**]
 - [**Manage Picture Control**]
-

Resetting User Settings

To reset settings for **U1** or **U2** to default values:

1 Select [Reset user settings].

Press the **MENU** button to display the menus. Highlight [**Reset user settings**] in the setup menu and press .

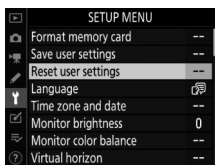

2 Select a position.

Highlight [**Reset U1**] or [**Reset U2**] and press .

3 Reset user settings.

Highlight [**Reset**] and press  to restore default settings for the selected position. The camera will function in mode **P**.



Using Special Effects Modes



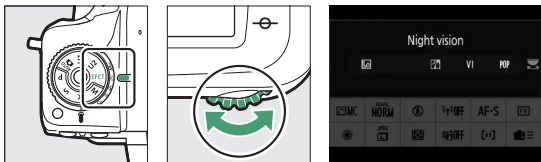





■ Choosing an Effect

To choose an effect, rotate the mode dial to **EFCT** and then rotate the main command dial to choose the desired option.



■ Special Effects













	Option	Description
	[Night vision]	Use under conditions of darkness to record monochrome images at high ISO sensitivities. <ul style="list-style-type: none">• Manual focus can be used if the camera is unable to focus.
VI	[Super vivid]	Overall saturation and contrast are increased for a more vibrant image.
POP	[Pop]	Overall saturation is increased for a more lively image.
	[Photo illustration]	Sharpen outlines and simplify coloring for a poster effect. <ul style="list-style-type: none">•  ([Photo illustration]) effects can be adjusted in live view (□ 122).• Movies shot in this mode play back like a slide show made up of a series of stills.

	Option	Description
	[Toy camera effect]	<p>Create photos and movies with saturation and peripheral illumination similar to pictures shot with a toy camera.</p> <ul style="list-style-type: none"> •  ([Toy camera effect]) effects can be adjusted in live view (📖 123).
	[Miniature effect]	<p>Create photos that appear to be pictures of dioramas. Works best when shooting from a high vantage point.</p> <ul style="list-style-type: none"> •  ([Miniature effect]) effects can be adjusted in live view (📖 124). • Miniature effect movies play back at high speed. • Sound is not recorded with movies.
	[Selective color]	<p>All colors other than the selected colors are recorded in black and white.</p> <ul style="list-style-type: none"> •  ([Selective color]) effects can be adjusted in live view (📖 126).
	[Silhouette]	Silhouette subjects against bright backgrounds.
	[High key]	Use with bright scenes to create bright images that seem filled with light.
	[Low key]	Use with dark scenes to create dark, low-key images with prominent highlights.

Preventing Blur

Use a tripod to prevent blur caused by camera shake at slow shutter speeds.

Special Effects Modes

- Pictures taken in , **VI**, **POP**, , , , or  mode with [**NEF (RAW)**] selected for image quality will be recorded at an image quality of [**JPEG fine ★**], while in the case of pictures taken at a setting of NEF (RAW) + JPEG, only the JPEG copy will be recorded.
 - If [**On**] is selected for Custom Setting d8 [**Save original (EFFECTS)**], the camera will save two copies of each picture shot in **VI**, **POP**, , , , and  modes: an unprocessed NEF(RAW) copy and a JPEG copy to which the effect has been applied. If [**Off**] is selected, only the JPEG copy will be saved.
 - Effects cannot be adjusted during movie recording.
 - The frame advance rates for **CL** (Continuous low speed) and **CH** (Continuous high speed) slow when  or  is selected.
 - In  and  modes, the live view display refresh rate will drop.
-

■ Adjusting (Photo Illustration) Settings

When  is selected, the effect can be adjusted in live view:

1 Press the button.

The view through the lens will be displayed in the monitor.

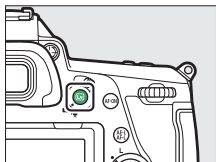



2 Press .

Photo illustration options will be displayed.



3 Adjust outline thickness.

Press  to thin outlines or  to make them thicker.



4 Press .

Press  to save changes; the selected effect will be applied during shooting.

■ Adjusting (Toy Camera Effect) Settings

When  is selected, the effect can be adjusted in live view:

1 Press the button.

The view through the lens will be displayed in the monitor.

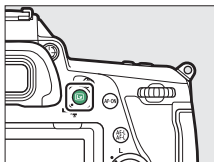







2 Press .

Toy camera effect options will be displayed.



3 Adjust options.

- Press  or  to highlight the desired setting.
- **[Vividness]**: Press  for more saturation,  for less.
- **[Vignetting]**: Press  for more vignetting,  for less.



4 Press .

Press  to save changes; the selected effect will be applied during shooting.

■ Adjusting (Miniature Effect) Settings



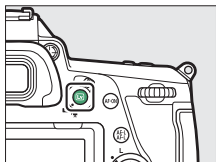

When  is selected, the effect can be adjusted in live view:

1 Press the button.

The view through the lens will be displayed in the monitor.



2 Position the focus point.

- Use the multi selector to position the focus point in the area that you want to be in focus.
- To check focus, press the shutter-release button halfway.
- To temporarily clear miniature effect options from the display and enlarge the view in the monitor for precise focus, press  (**QUAL**). Press   ( ) to restore the miniature effect display.







3 Display options.

Press **OK** to display miniature effect options.



4 Choose the orientation and size of the area that will be in focus.

- Press  or  to choose the orientation of the area that will be in focus.
- Press  or  to choose the width of the area that will be in focus.

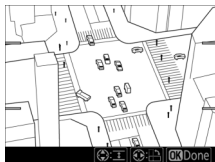

5 Press **OK**.

Press **OK** to save changes; the selected effect will be applied during shooting.

Movies

Miniature effect movies play back at high speed. For example, approximately 15 minutes of footage shot with 1920 x 1080/30p selected for **[Frame size/frame rate]** in the movie shooting menu will play back in about a minute.

■ Adjusting (Selective Color) Settings

When  is selected, the effect can be adjusted in live view:

1 Press the button.

The view through the lens will be displayed in the monitor.

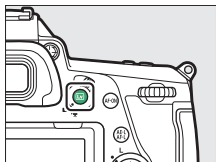



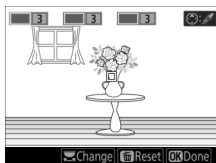

2 Press .

Selective color options will be displayed.



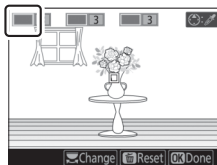

3 Select colors.

- Frame an object of the desired color in the white square at the center of the display.
- To zoom in for more precise color selection, press  (QUAL). Press  () to zoom out.
- Press  to choose the color of the object in the white square as one that will be recorded in color when photographs are taken; the selected color will appear in the first of the numbered color boxes.
- All colors other than those selected in the color boxes will appear in black and white.



4 Choose the color range.

Press  or  to increase or decrease the range of similar hues that will be included in photographs; choose from values between [1] and [7]. The higher the value, the wider the range of colors that will be included; the lower the value, the lower the range of colors that will be included.

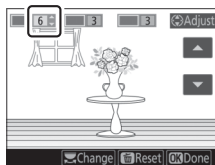

5 Select additional colors.

- To select additional colors, rotate the main command dial to highlight another of the numbered color boxes and repeat Steps 3 and 4.

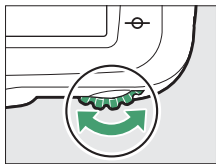

- Up to 3 colors can be selected.
- To deselect the highlighted color, press (FORMAT).
- To remove all colors, press and hold (FORMAT). A confirmation dialog will be displayed; select [Yes].

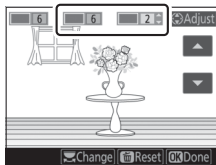

6 Press .

Press to save changes; the selected effect will be applied during shooting.

Note: Selective Color

- The camera may have difficulty detecting some colors. Saturated colors are recommended.
 - Higher values for color range may include hues from other colors.
-

Image Recording Options (Image Area, Quality, and Size)



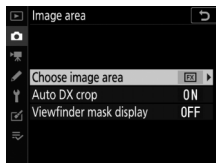

Adjusting Image Area Settings

Image area settings can be displayed by selecting [**Image area**] in the photo shooting menu.



■ Choose Image Area

Choose the image area. The following options are available:

Option	Description
 [FX (36×24)]	Images are recorded in FX format with an angle of view equivalent to a NIKKOR lens on a 35 mm format camera.
 [DX (24×16)]	Images are recorded in DX format. To calculate the approximate focal length of the lens in 35 mm format, multiply by 1.5.
 [1:1 (24×24)]	Pictures are recorded with an aspect ratio of 1 : 1.
 [16:9 (36×20)]	Pictures are recorded with an aspect ratio of 16 : 9.

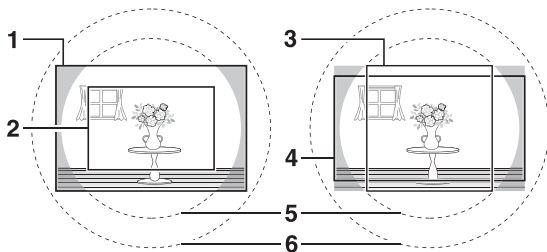

1 FX (36×24)

2 DX (24×16)

3 1 : 1 (24×24)

4 16 : 9 (36×20)

5 DX format (24×16) image circle

6 FX format (36×24) image circle

✓ DX Lenses

DX lenses are designed for use with DX format cameras and have a smaller angle of view than lenses for 35 mm format cameras. If [**Auto DX crop**] is off and an option other than [**DX (24 × 16)**] (DX format) is selected for [**Choose image area**] when a DX lens is attached, the edges of the image may be eclipsed. This may not be apparent in the viewfinder, but when the images are played back you may notice a drop in resolution or that the edges of the picture are blacked out.

✔ Choosing the Image Area via Buttons and Command Dials

If [**Choose image area**] has been assigned to a button using Custom Setting f3 [**Custom controls**], the image area can be selected by pressing the button and rotating a command dial.

- The selected crop is displayed in the viewfinder (☐ 130).
- The option currently selected for image area can be displayed in the control panel and viewfinder by pressing the button to which [**Choose image area**] is assigned.

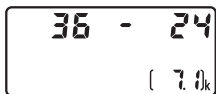

Image area	Display
[FX (36×24)]	36 - 24
[DX (24×16)]	24 - 16
[1 : 1 (24×24)]	24 - 24
[16 : 9 (36×20)]	36 - 20

- Camera controls cannot be used to select image area when a DX lens is attached and [**Auto DX crop**] is on.

✔ Image Size

Image size varies with the option selected for image area.

■ [Auto DX Crop]

Choose whether the camera automatically selects the [DX (24×16)] (DX format) image area when a DX lens is attached.

Option	Description
[On]	The camera automatically selects the [DX (24×16)] (DX format) image area when a DX lens is attached.
[Off]	Automatic image-area selection disabled.

■ The Viewfinder Mask Display

If [On] is selected, the area outside crop ([FX (36×24)] excepted) will be shown in gray in the viewfinder.

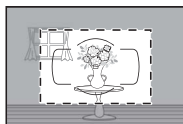

DX (24×16)

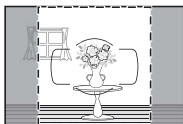

1 : 1 (24×24)

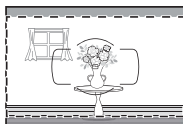

16 : 9 (36×20)

Adjusting Image Quality

Choose the image quality option used when photographs are recorded.

Option	Description
[NEF (RAW) + JPEG fine★]	<p>Record two copies of each photo: an NEF (RAW) image and a JPEG copy.</p> <ul style="list-style-type: none">• For the JPEG copy, you can choose from options prioritizing image quality or file size. Options with a star ("★") prioritize image quality, those without a star ("★") file size.• Only the JPEG copy is displayed during playback. The NEF (RAW) image can only be viewed using a computer.• Deleting the JPEG copy from the camera also deletes the NEF (RAW) image.
[NEF (RAW) + JPEG fine]	
[NEF (RAW) + JPEG normal★]	
[NEF (RAW) + JPEG normal]	
[NEF (RAW) + JPEG basic★]	
[NEF (RAW) + JPEG basic]	
[NEF (RAW)]	
[JPEG fine★]	<p>Record photos in JPEG format. "Fine" produces higher quality pictures than "normal" and "normal" higher quality pictures than "basic".</p> <ul style="list-style-type: none">• Choose options with ★ to maximize quality, options without ★ to ensure that all images have more or less the same file size.
[JPEG fine]	
[JPEG normal★]	
[JPEG normal]	
[JPEG basic★]	
[JPEG basic]	

NEF (RAW)

- NEF (RAW) files have the extension “*.nef”.
 - The process of converting NEF (RAW) pictures to other highly-portable formats such as JPEG is referred to as “NEF (RAW) processing”. During this process, Picture Controls and settings such as exposure compensation and white balance can be freely adjusted.
 - The RAW data themselves are unaffected by NEF (RAW) processing and their quality will remain intact even if the pictures are processed multiple times at different settings.
 - NEF (RAW) processing can be performed in-camera using the **[NEF (RAW) processing]** item in the retouch menu or on a computer using Nikon’s NX Studio software. NX Studio is available free-of-charge from the Nikon Download Center.
-

■ Choosing an Image Quality Option

During viewfinder photography, you can choose an image quality option by holding the **QUAL** button and rotating the main command dial.

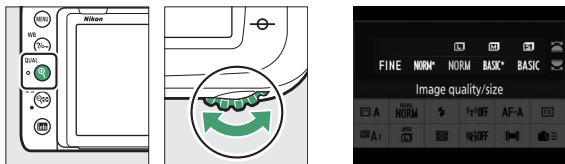

✔ The Photo Shooting Menu [Image Quality] Option

Image quality can also be adjusted using the **[Image quality]** item in the photo shooting menu. Use the **[Image quality]** item in the photo shooting menu to adjust image quality during live view.

✔ Recording Pictures to Two Memory Cards

If **[RAW Slot 1 - JPEG Slot 2]** is selected for **[Role played by card in Slot 2]** when photographs are taken at image quality settings of NEF (RAW) + JPEG, the NEF (RAW) copy will be saved to the card in Slot 1 and the JPEG copy to the card in Slot 2.

Choosing an Image Size

Choose a size for new JPEG pictures. The size for JPEG pictures can be selected from **[Large]**, **[Medium]**, and **[Small]**. The number of pixels in the image varies with the option selected for image area (☐ 129).

Image area	Option	Size (pixels)	Print size (cm/in.) *
[FX (36×24)] (FX format)	Large	6048 × 4024	51.2 × 34.1/20.2 × 13.4
	Medium	4528 × 3016	38.3 × 25.5/15.1 × 10.1
	Small	3024 × 2016	25.6 × 17.1/10.1 × 6.7
[DX (24×16)] (DX format)	Large	3936 × 2624	33.3 × 22.2/13.1 × 8.7
	Medium	2944 × 1968	24.9 × 16.7/9.8 × 6.6
	Small	1968 × 1312	16.7 × 11.1/6.6 × 4.4
[1 : 1 (24×24)]	Large	4016 × 4016	34.0 × 34.0/13.4 × 13.4
	Medium	3008 × 3008	25.5 × 25.5/10.0 × 10.0
	Small	2000 × 2000	16.9 × 16.9/6.7 × 6.7
[16 : 9 (36×20)]	Large	6048 × 3400	51.2 × 28.8/20.2 × 11.3
	Medium	4528 × 2544	38.3 × 21.5/15.1 × 8.5
	Small	3024 × 1696	25.6 × 14.4/10.1 × 5.7

* Approximate size when printed at 300 dpi. Print size in inches equals image size in pixels divided by printer resolution in dots per inch (dpi; 1 inch = approximately 2.54 cm).

■ Choosing an Image Size

During viewfinder photography, you can choose the image size by holding the **QUAL** button and rotating the sub-command dial.



✓ The Photo Shooting Menu [Image Size] Option

Image size for JPEG images can also be adjusted using the **[Image size]** item in the photo shooting menu. Use the **[Image size]** item in the photo shooting menu to adjust image size during live view.

Choosing How the Camera Focuses (Focus)

Choosing a Focus Mode

Rotate the focus-mode selector to **AF** to select autofocus or to **M** to select manual focus.

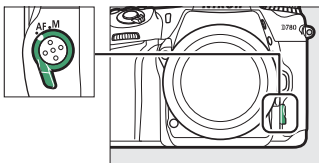

During viewfinder photography, the camera focuses using 51 focus points.

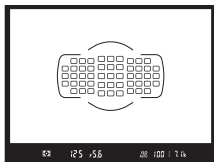

Autofocus Mode

Choose how the camera focuses in autofocus mode.

■ Viewfinder Photography

Option		Description
AF-A	[AF mode auto-switch]	The camera uses AF-S when photographing stationary subjects and AF-C when photographing subjects that are in motion.
AF-S	[Single AF]	For stationary subjects. Focus locks when shutter-release button is pressed halfway. At default settings, shutter can only be released when in-focus indicator (●) is displayed (<i>focus priority</i>).
AF-C	[Continuous AF]	For moving subjects. Camera focuses continuously while shutter-release button is pressed halfway; if subject moves, camera will engage <i>predictive focus tracking</i> to predict final distance to subject and adjust focus as necessary. At default settings, shutter can be released whether or not subject is in focus (<i>release priority</i>).

Predictive Focus Tracking

If **AF-C** is selected for AF mode, or if **AF-A** is selected and the camera is shooting using **AF-C**, the camera will initiate predictive focus tracking if the subject moves toward or away from the camera while the shutter-release button is pressed halfway or the **AF-ON** button is pressed. This allows the camera to track focus while attempting to predict where the subject will be when the shutter is released.

■ Live View Photography

Option		Description
AF-A	[AF mode auto-switch]	The camera automatically selects AF-S when the subject is stationary and AF-C when the subject is in motion. <ul style="list-style-type: none">• This option is available only during still photography.
AF-S	[Single AF]	For stationary subjects. Press the shutter-release button halfway to focus. If the camera is able to focus, the focus point will turn from red to green; focus will lock while the shutter-release button is pressed halfway. If the camera fails to focus, the focus point will flash red. <ul style="list-style-type: none">• At default settings, the shutter can only be released if the camera is able to focus (focus priority).
AF-C	[Continuous AF]	For moving subjects. The camera focuses continuously while the shutter-release button is pressed halfway; if the subject moves, the camera will predict the final distance to the subject and adjust focus as necessary. <ul style="list-style-type: none">• At default settings, the shutter can be released whether or not the subject is in focus (release priority).

Option		Description
AF-F	[Full-time AF]	<p>The camera adjusts focus continuously in response to subject movement or changes in composition. When the shutter-release button is pressed halfway, the focus point will turn from red to green and focus will lock.</p> <ul style="list-style-type: none">• This option is available only during filming.

■ Choosing an Autofocus Mode

To choose the autofocus mode, hold the AF-mode button and rotate the main command dial.

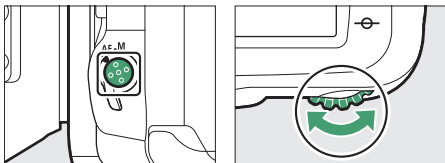

- During viewfinder photography, the selected AF mode is displayed in the control panel and viewfinder.



- During live view photography and filming, the selected AF mode is displayed in the monitor.

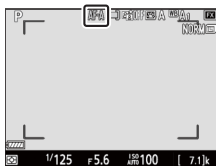

AF-Area Mode

Choose how the camera selects the focus point for autofocus.

■ Viewfinder Photography

Option	Description
[Single-point AF]	Select the focus point (☐ 159); the camera will focus on the subject in the selected focus point only. Use with stationary subjects.
[Dynamic-area AF (9 points)]/ [Dynamic-area AF (21 points)]/ [Dynamic-area AF (51 points)]	Select the focus point. In AF-A and AF-C focus modes, the camera will focus based on information from surrounding focus points if the subject briefly leaves the selected point. The number of focus points varies with the mode selected: <ul style="list-style-type: none">• [Dynamic-area AF (9 points)]: Choose when there is time to compose the photograph or when photographing subjects that are moving predictably (e.g., runners or race cars on a track).• [Dynamic-area AF (21 points)]: Choose when photographing subjects that are moving unpredictably (e.g., players at a football game).• [Dynamic-area AF (51 points)]: Choose when photographing subjects that are moving quickly and cannot be easily framed in the viewfinder (e.g., birds).

Option	Description
<p>[3D-tracking]</p>	<p>Select the focus point. While the shutter-release button is pressed halfway in AF-A and AF-C focus modes, the camera will use all 51 focus points to track subjects that leave the selected point and choose new points as required.</p> <ul style="list-style-type: none"> • Use to quickly compose pictures with subjects that are moving erratically from side to side (e.g., tennis players). • If the subject leaves viewfinder, remove your finger from the shutter-release button and recompose the photograph with the subject in the selected focus point.
<p>[Group-area AF]</p>	<p>The camera focuses using a group of focus points selected by the user, reducing the risk of the camera focusing on the background instead of on the main subject.</p> <ul style="list-style-type: none"> • Use for snapshots or photos of moving subjects that are hard to frame using the [Single-point AF] option. • Face detection is enabled. The camera gives priority to any faces detected.

Option	Description
<p>[Auto-area AF]</p>	<p>The camera automatically detects the subject and selects the focus point.</p> <ul style="list-style-type: none"> • If a face is detected, the camera will give priority to the portrait subject (face-detection AF). This lets you concentrate on composition and facial expressions even if your subject is in motion (📖 155). • Use on occasions when you don't have time to select the focus point yourself, for portraits, or snapshots and other spur-of-the-moment photos. • When AF-S is selected for autofocus mode, the active focus points are briefly highlighted after the camera focuses. When AF-C is selected, or when AF-A is selected and photographs are taken using AF-C, only the main focus point is displayed.

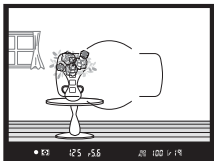

✓ AF-Area Mode

AF-area mode is shown in the control panel and viewfinder.

AF-area mode	Control panel	Viewfinder	Viewfinder focus-point display (during selection)
[Single-point AF]	S		
[Dynamic-area AF (9 points)]*	d 9		
[Dynamic-area AF (21 points)]*	d2 1		
[Dynamic-area AF (51 points)]*	d5 1		
[3D-tracking]	3d		
[Group-area AF]	Gr P		
[Auto-area AF]	Auto		

* Only active focus point is displayed in the viewfinder. Remaining focus points provide information to assist focus operation.

3D-Tracking

When [**3D-tracking**] is selected for AF-area mode, the camera stores the colors in the area surrounding the focus point at the moment the shutter-release button is pressed halfway. Consequently 3D-tracking may not produce the desired results with subjects that are similar in color to the background or that occupy a very small area of the frame.





Quick Focus-Point Selection



For quicker focus-point selection, choose [**Every other point**] for Custom Setting a6 [**Focus points used**] to use only a quarter of the available focus points.

AF-S/AF-I Teleconverters

If [**3D-tracking**] or [**Auto-area AF**] is selected for AF-area mode when an AF-S/AF-I teleconverter is used, [**Single-point AF**] will automatically be selected at combined apertures slower than f/5.6.

■ Live View Photography

Option	Description
 [PIN] [Pinpoint AF]	Recommended for shots involving static subjects, such as buildings, in-studio product photography, or close-ups. Use for pinpoint focus on a selected spot in the frame smaller than the focus point for [Single-point AF] . This option is available only when AF-S is chosen for AF mode during still photography. Focusing may be slower than with [Single-point AF] .
 [L1] [Single-point AF]	The camera focuses on a point selected by the user. Use with stationary subjects.
 [WIDE-S] [Wide-area AF (S)]	As for [Single-point AF] , except the camera focuses on a wider area, the focus areas for [Wide-area AF (L)] being larger than those for [Wide-area AF (S)] . Use for snapshots or photos of moving subjects that are hard to frame using [Single-point AF] , or during movie recording for smooth focus when making panning or tilting shots or filming moving subjects. If the selected focus area contains subjects at different distances from the camera, the camera will assign priority to the closest subject.
 [WIDE-L] [Wide-area AF (L)]	

Option	Description
 [Dynamic-area AF]	<p>The camera focuses on a point selected by the user. If the subject briefly leaves the selected point, the camera will focus based on information from surrounding focus points.</p> <ul style="list-style-type: none"> • Use for photographs of athletes and other active subjects that are hard to frame using [Single-point AF]. • This option is available only when AF-A or AF-C is selected for autofocus mode during still photography.
 [Auto-area AF]	<p>The camera automatically detects the subject and selects the focus area.</p> <ul style="list-style-type: none"> • Use on occasions when you don't have time to select the focus point yourself, for portraits, or for snapshots and other spur-of-the-moment photos. • If a portrait subject is detected during live view photography, an amber border indicating the focus point will appear around the subject's face. If the camera detects the subject's eyes, the amber border will instead appear around an eye (face/eye-detection AF). This frees you to concentrate on composition and your subject's expression when photographing active portrait subjects (□ 155). • Subject tracking (□ 158) can be activated by pressing the  button.

✔ Using Autofocus in Live View

- The camera may be unable to focus if:
 - The subject contains lines parallel to the long edge of the frame
 - The subject lacks contrast
 - The subject in the focus point contains areas of sharply contrasting brightness
 - The focus point includes night-time spot lighting or a neon sign or other light source that changes in brightness
 - Flicker or banding appears under fluorescent, mercury-vapor, sodium-vapor, or similar lighting
 - A cross (star) filter or other special filter is used
 - The subject appears smaller than the focus point
 - The subject is dominated by regular geometric patterns (e.g., blinds or a row of windows in a skyscraper)
 - The subject is moving
 - The monitor may brighten or darken while the camera focuses.
 - The focus point may sometimes be displayed in green when the camera is unable to focus.
 - Use an AF-S or AF-P lens. The desired results may not be achieved with other lenses or teleconverters.
-

 : **The Center Focus Point**

In all AF-area modes except [**Auto-area AF**], a dot appears in the focus point when it is in the center of the frame.

 **Quick Focus-Point Selection**

For quicker focus-point selection, choose [**Every other point**] for Custom Setting a6 [**Focus points used**] to use only a quarter of the available focus points (the number of points available for [**Pinpoint AF**] and [**Wide-area AF (L)**] does not change).

■ Choosing an AF-Area Mode

To choose the AF-area mode, hold the AF-mode button and rotate the sub-command dial.



- During viewfinder photography, the selected AF-area mode is displayed in the control panel and viewfinder.



- During live view photography and filming, the selected AF-area mode is displayed in the monitor.

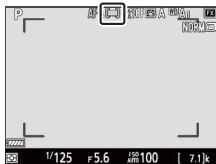

■ Face/Eye-Detection AF

When [**Auto-area AF**] is selected for AF-area mode, you have the option of enabling face-detection AF, allowing the camera to detect the faces of human portrait subjects. Face/eye detection AF, in which the camera detects both faces and eyes, is available during live view photography. Face- and eye-detection AF can be configured using Custom Setting a5 [**Auto-area AF face/eye detection**].

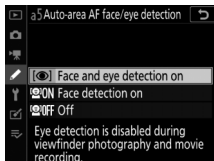

Viewfinder Photography

- If [**Face and eye detection on**] or [**Face detection on**] is selected, the camera will assign focus priority to the faces of any portrait subjects it detects.
- If the subject looks away after their face is detected, the focus point will move to track their motion.
- During playback, you can zoom in on the face used for focus by pressing the **OK** button.



Live View Photography

- If [**Face and eye detection on**] is selected and a portrait subject is detected, an amber border indicating the focus point will appear around the subject's face. If the camera detects the subject's eyes during live view photography, the border will instead be displayed around one or the other of their eyes.
- Faces detected when [**Face detection on**] is selected are similarly indicated by an amber border.
- If **AF-S** is selected for AF mode, or if **AF-A** is selected and the camera is shooting using **AF-S**, the focus point will turn green when the camera focuses.
- If more than one portrait subject or more than one eye is detected, ◀ and ▶ icons will appear on the focus point, and you will be able to position the focus point over a different face or eye by pressing ◀ or ▶.
- If the subject looks away after their face is detected, the focus point will move to track their motion.
- During playback, you can zoom in on the face or eye used for focus by pressing OK.



✔ **Face/Eye-Detection AF**

- Eye detection is not available during movie recording.
 - Eye and face detection may not perform as expected if:
 - the subject's face occupies a very large or very small proportion of the frame,
 - the subject's face is lit too brightly or too poorly,
 - the subject is wearing glasses or sunglasses,
 - the subject's face or eyes are obscured by hair or other objects, or
 - the subject moves excessively during shooting.
-

■ Subject Tracking AF

If [Auto-area AF] is selected for AF-area mode during live view, you can press **OK** to enable focus tracking. The focus point will change to a targeting reticle; position the reticle over the target and press the **AF-ON** button or press **OK** again to start tracking. The focus point will track the selected subject as it moves through the frame. To end tracking, press **OK** a third time. To exit subject-tracking mode, press the **Q/Exit** button.



✓ Subject Tracking

The camera may be unable to track subjects if they move quickly, leave the frame or are obscured by other objects, change visibly in size, color, or brightness, or are too small, too large, too bright, too dark, or similar in color or brightness to the background.

Focus Point Selection

Except when [**Auto-area AF**] is selected for AF-area mode, the focus point can be selected manually, allowing photographs to be composed with the subject positioned almost anywhere in the frame.

1 Undo the focus selector lock.

Rotate the focus selector lock to ●.

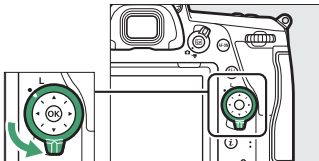

2 Use the multi selector to select the focus point while the standby timer is on.

- During viewfinder photography, you can choose from 51 focus points.
- During live view, the focus point can be positioned anywhere in the frame.

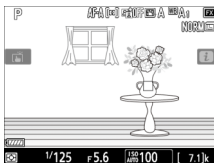
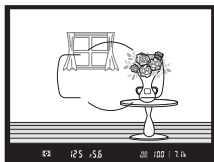

- The center focus point can be selected by pressing **OK**.
- The focus selector lock can be rotated to the locked (**L**) position following selection to prevent the selected focus point from changing when the multi selector is pressed.

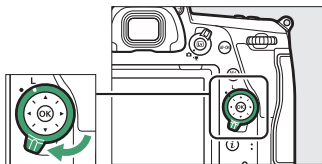

Focus Lock

If your subject will not be in the selected focus point in the final composition, or if the camera is unable to focus on the selected subject, press the **AE-L/AF-L** button to lock focus at the desired distance before recomposing the shot (☞ 83).

Getting Good Results with Autofocus

The camera may be unable to focus under the conditions listed below, in which case the shutter release may be disabled or pictures may be out of focus, the latter a result of the camera either displaying the in-focus indicator (●)—or, in live view, displaying the focus point in green—when the subject is not in focus. Focus manually or use focus lock to focus on another subject at the same distance.

- There is little contrast between the subject and the background, as may be the case if the subject is photographed against a featureless wall or the background is the same color as the subject.
 - The focus point contains objects at different distances from the camera, as may be the case if the subject is inside a cage.
 - The subject is dominated by regular geometric patterns such as the rows of windows in a skyscraper.
 - The focus point contains areas of sharply contrasting brightness, as may be the case if the subject is half in the shade.
 - Background objects appear larger than the main subject, as may be the case if a building is in the frame behind the subject.
 - The subject contains many fine details, as may be the case when the subject is a field of flowers.
-

Manual Focus

Manual focus is available for lenses that do not support autofocus (non-AF NIKKOR lenses) or when the autofocus does not produce the desired results.

- **AF lenses:** Set the lens focus mode switch (if present) and camera focus-mode selector to **M**.

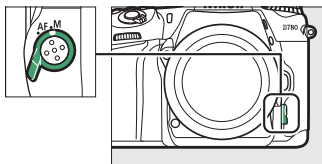

- **Manual focus lenses:** Focus manually.

To focus manually, adjust the lens focus ring until the image displayed on the clear matte field in the viewfinder is in focus.

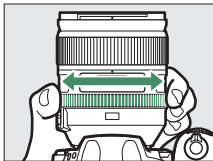

✓ AF Lenses

Do not use AF lenses with the lens focus-mode switch set to **M** and the camera focus-mode selector set to **AF**. Failure to observe this precaution could damage the camera or lens. This does not apply to AF-S and AF-P lenses, which can be used in **M** mode without setting the camera focus-mode selector to **M**.

■ The Electronic Rangefinder

The focus indicators (●) in the viewfinder and monitor can be used to confirm whether the subject in the selected focus point is in focus.

- In-focus indicators (●) are displayed when the subject is in focus.

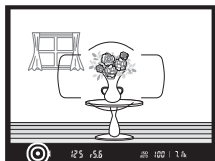

Focus indicator	Status
● (steady)	The subject is in focus.
▶ (steady)	The focus point is in front of the subject.
◀ (steady)	The focus point is behind the subject.
▶ ◀ (steady)	The camera is unable to focus.

- Note that with the subjects listed in “Getting Good Results with Autofocus” (☞ 161), the in-focus indicator (●) may sometimes be displayed when the subject is not in focus. Confirm focus in the viewfinder before shooting. During live view, you can check focus by zooming in on the view through the lens.
- A tripod is recommended if you experience trouble focusing.

AF-P Lenses

When an AF-P lens is used in manual focus mode, the in-focus indicator will flash in the viewfinder (or in live view, the focus point will flash in the monitor) to warn that continuing to rotate the focus ring in the current direction will not bring the subject into focus.

The Focal Plane Mark and Flange-Back Distance

Focus distance is measured from the focal plane mark (\ominus) on the camera body, which shows the position of the focal plane inside the camera (①). Use this mark when measuring the distance to your subject for manual focus or macro photography. The distance between the focal plane and the lens mounting flange is known as the “flange-back distance” (②). On this camera, the flange-back distance is 46.5 mm (1.83 in.).

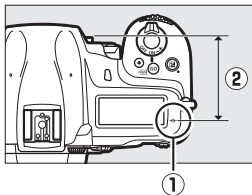

Focus Peaking

If focus peaking is enabled using Custom Setting d11 [**Peaking highlights**], objects that are in focus will be indicated by colored outlines that appear when focus is adjusted manually during live view. Note that peaking highlights may not be displayed if the camera is unable to detect outlines, in which case focus can be checked by zooming in on the view through the lens in the display.

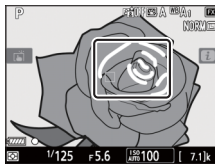

Exposure-Related Settings (Metering and Exposure Compensation)

Choosing How the Camera Sets Exposure

Metering determines how the camera sets exposure. Choose the method used and area metered when the camera sets exposure.

- In modes other than **P**, **S**, **A**, and **M**, the camera selects the metering method according to the scene.

	Option	Description
☑	[Matrix metering]	Produces natural results in most situations. The camera meters a wide area of the frame and sets exposure according to tone (brightness) distribution, color, distance, and composition for results close to those seen by the human eye.
☑	[Center-weighted metering]	The camera meters the entire frame but assigns the greatest weight to an area in the center (the size of the area can be selected using Custom Setting b4 [Center-weighted area] ; if a non-CPU lens or an AF-S Fisheye NIKKOR 8–15mm f/3.5–4.5E ED lens is attached, the area is equivalent to a circle 12 mm in diameter). This is the classic meter for portraits and is recommended when using filters with an exposure factor (filter factor) over 1×.

Option	Description
<input type="checkbox"/> [Spot metering]	<p>The camera meters a circle 4 mm (0.16 in.) in diameter (approximately 1.5% of the frame). The circle is centered on the current focus point, making it possible to meter off-center subjects (the camera will meter the center focus point if a non-CPU lens or an AF-S Fisheye NIKKOR 8–15mm f/3.5–4.5E ED lens is attached or if [Auto-area AF] is in effect; <input type="checkbox"/> 145). Spot metering ensures that the subject will be correctly exposed, even when the background is much brighter or darker.</p>
<input type="checkbox"/> * [Highlight-weighted metering]	<p>The camera assigns the greatest weight to highlights. Use to reduce loss of detail in highlights, for example when photographing spotlight performers on stage.</p>

■ Choosing a Metering Option

Hold the  () button and rotate the main command dial.

- The selected metering option is displayed in the control panel and viewfinder.

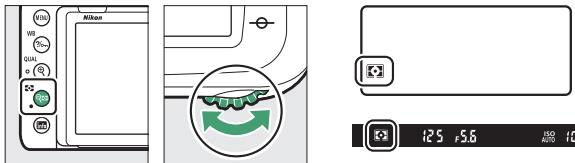

[Matrix Metering] and Lens Type

The metering method used when **[Matrix metering]** is selected varies with the lens.

- **CPU lenses:**

- **3D color matrix metering III:** Available with type D, E, and G CPU lenses. The camera includes distance information when calculating exposure.
- **Color matrix metering III:** Available with CPU lenses of types other than D, E, and G. Distance information is not included.

- **Non-CPU lenses:**

- Color matrix metering is available if lens data are provided using the **[Non-CPU lens data]** option in the setup menu. **[Center-weighted metering]** will be used if lens data are not provided.

[Highlight-Weighted Metering] and Lens Type

[Center-weighted metering] will be used if **[Highlight-weighted metering]** is selected when non-CPU lenses and certain CPU lenses (AI-P NIKKOR lenses and AF lenses of types other than D, E, or G) are attached.

Long Time-Exposures (M Mode Only)

The camera offers two options for long time-exposures: Bulb and Time. Long time-exposures can be used for pictures of fireworks, night scenery, the stars, or moving lights.



Shutter speed: Bulb (35-second exposure)
Aperture: f/25

Shutter speed	Description
Bulb	The shutter remains open while the shutter-release button is held down.
Time	The exposure starts when the shutter-release button is pressed and ends when the button is pressed a second time.

- To prevent blur, use a tripod or an optional wireless remote controller or remote cord.

1 Ready the camera.

Mount the camera on a tripod or place it on a stable, level surface.

2 Rotate the mode dial to M.

Keeping the mode dial lock release pressed, rotate the mode dial to **M**.

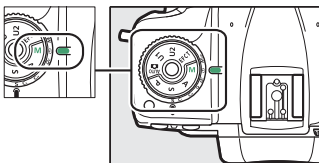

3 Choose a shutter speed.

- While the exposure meters are on, rotate the main command dial to choose a shutter speed of Bulb (**b u l b**) or Time (**- -**).

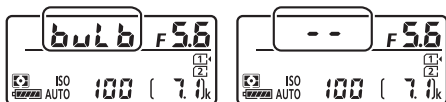

- The exposure indicators do not appear when Bulb (**b u l b**) or Time (**- -**) is selected.

4 Open the shutter.

- **Bulb:** After focusing, press the shutter-release button on the camera or optional remote cord or wireless remote controller all the way down. Keep the shutter-release button pressed until the exposure is complete.
- **Time:** After focusing, press the shutter-release button all the way down.

5 Close the shutter.

- **Bulb:** Take your finger off the shutter-release button.
- **Time:** Press the shutter-release button all the way down.

Long Time-Exposures

To prevent light entering via the viewfinder from appearing in the photograph or interfering with exposure, we recommend that you remove the rubber eyecup and cover the viewfinder with the supplied eyepiece cap (☐ 10). Nikon recommends using a fully charged battery or an optional AC adapter and power connector to prevent loss of power while the shutter is open. Note that noise (bright spots, randomly-spaced bright pixels or fog) may be present in long exposures. Bright spots and fog can be reduced by choosing **[On]** for **[Long exposure NR]** in the photo shooting menu.

Autoexposure Lock

Use autoexposure lock to recompose photographs after setting exposure for a specific area of the subject. Exposure lock comes in handy when the area used to set exposure is much brighter or darker than its surroundings.

1 Select [Center-weighted metering] or [Spot metering] (📖 166).

2 Lock exposure.

- Position the subject in the selected focus point and press the shutter-release button halfway. With the shutter-release button pressed halfway and the subject positioned in the focus point, press the $\overset{\text{AE-L}}{\text{AF-L}}$ button to lock exposure (if you are using autofocus, confirm that the ● in-focus indicator appears in the viewfinder).
- While exposure lock is in effect, an **AE-L** indicator will appear in the viewfinder.

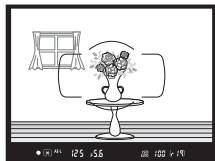
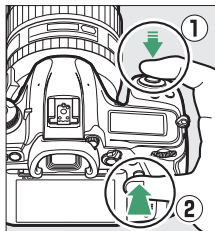

3 Recompose the photograph.

Keeping the **AE-L/AF-L** button pressed, recompose the photograph and shoot.

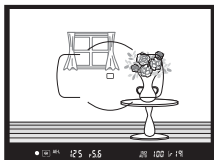

Metered Area

In [**Spot metering**] (☐ 166), exposure will be locked at the value metered in a circle centered on the selected focus point. In [**Center-weighted metering**], exposure will be locked at the value metered in a 12-mm circle in the center of the viewfinder.

Adjusting Shutter Speed and Aperture

While exposure lock is in effect, the following settings can be adjusted without altering the metered value for exposure:

Mode	Setting
P	Shutter speed and aperture (flexible program; ☐ 109)
S	Shutter speed
A	Aperture

- The new values can be confirmed in the viewfinder and control panel.
- Note that metering cannot be changed while exposure lock is in effect.

Exposure Compensation

Exposure compensation is used to alter exposure from the value suggested by the camera, making pictures brighter or darker. It is most effective when [**Spot metering**] or [**Center-weighted metering**] is selected for metering (📖 166).



-1 EV



No exposure
compensation



+1 EV

■ Adjusting Exposure Compensation





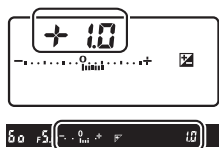
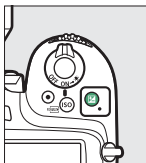

Hold the  button and rotate the main command dial.

- The selected value is displayed in the control panel and viewfinder.



- Choose from values between -5 EV (underexposure) and +5 EV (overexposure).
- By default, changes are made in increments of $\frac{1}{3}$ EV. The size of the increments can be changed using Custom Setting b1 [**EV steps for exposure cntrl**].

- In general, positive values make the subject brighter while negative values make it darker.
- The current value is displayed in the control panel and viewfinder when the  button is pressed.

Display	No exposure compensation ( button pressed)	-0.3 EV	+2.0 EV
Control panel			
Viewfinder			

-  icons and exposure indicators will appear in the control panel and viewfinder. In modes other than **M**, the zero ("0") at the center of the exposure indicator will flash in the control panel.

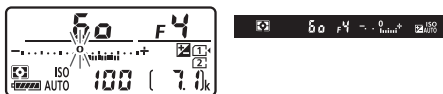

- Normal exposure can be restored by setting exposure compensation to ± 0.0 . Exposure compensation is not reset when the camera is turned off.

Mode M

In mode **M**, exposure compensation affects only the exposure indicator; shutter speed and aperture do not change.

Using a Flash

When a flash is used, exposure compensation affects both flash level and exposure, altering the brightness of both the main subject and the background. Custom Setting e3 [**Exposure comp. for flash**] can be used to restrict the effects of exposure compensation to the background only.

Choosing the Operation Performed When the Shutter Is Released (Release Mode)

Choosing a Release Mode Such as Single-Frame, Continuous, or Quiet Shutter-Release

To choose a release mode, press the release mode dial lock release and turn the release mode dial so that the pointer aligns with the desired setting.

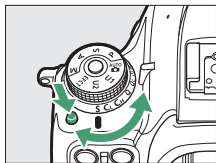

Mode		Description
S	Single frame	The camera takes one photograph each time the shutter-release button is pressed.
CL	Continuous low speed	<p>At default settings, the camera takes photos at up to 3 fps while the shutter-release button is pressed.</p> <ul style="list-style-type: none"> The frame advance rate can be selected using Custom Setting d1 [CL mode shooting speed]. Choose from values of from 1 to 6 fps. Note, however, that regardless of the option selected, the maximum frame advance rate during live view is 3 fps.
CH	Continuous high speed	<p>While shutter-release button is held down, camera records up to 7 frames per second. Use for active subjects.</p> <ul style="list-style-type: none"> When [On] is selected for [Silent live view photography] in the photo shooting menu during live view, the frame advance rate varies with the option selected for [NEF (RAW) recording] > [NEF (RAW) bit depth] in the photo shooting menu, increasing to a maximum of approximately 8 fps when [14-bit] is selected or approximately 12 fps when [12-bit] is selected.

Mode		Description
Q	Quiet shutter-release	As for single frame, except that the mirror does not click back into place while the shutter-release button is fully pressed, allowing the user to control the timing of the click made by the mirror, which is also quieter than in single frame mode. In addition, a beep does not sound regardless of the setting selected for [Beep options] > [Beep on/off] in the setup menu.
Qc	Qc (quiet continuous) shutter-release	The camera takes pictures at up to 3 fps while the shutter-release button is pressed; camera noise is reduced.
	Self-timer	Take pictures with the self-timer (📖 183).
MUP	Mirror up	Choose this mode to minimize camera shake in telephoto or close-up photography or in other situations in which the slightest camera movement can result in blurred photographs (📖 185).

✓ Burst Photography

- Depending on shooting conditions and memory card performance, the memory card access lamp may light for anywhere from a few seconds to a few minutes. Do not remove the memory card while the memory card access lamp is lit. Not only could any unrecorded images be lost, but the camera or memory card could be damaged.
 - If the camera is switched off while the memory card access lamp is lit, the power will not turn off until all images in the buffer have been recorded.
 - If the battery is exhausted while images remain in the buffer, the shutter release will be disabled and the images transferred to the memory card.
-

✓ The Memory Buffer

- While the shutter-release button is pressed halfway, the camera will show the number of pictures that can be stored in the memory buffer.



- When the buffer is full, the display will show **r00** and the frame rate will drop.
- The number shown is approximate. The actual number of photos that can be stored in the memory buffer varies with camera settings and shooting conditions.
- Memory buffer capacity may drop briefly immediately after the camera is turned on.
- Memory buffer capacity can be viewed in the monitor during live view.

Frame Advance Rate

The figures for frame advance rate apply in mode **S** or **M** at shutter speeds of $1/250$ s or faster with **AF-C** selected for autofocus mode and other settings at default values. Frame advance rates may slow:

- at slow shutter speeds,
 - when **[On]** is selected for **[ISO sensitivity settings]** > **[Auto ISO sensitivity control]** in the photo shooting menu and ISO sensitivity is altered automatically by the camera,
 - when ISO sensitivity is set to a value of from Hi 0.3 to Hi 2,
 - if flicker is detected with **[Enable]** selected for **[Flicker reduction]** > **[Flicker reduction setting]** in the photo shooting menu,
 - at extremely small apertures (high f-numbers),
 - when vibration reduction (available with VR lenses) is on,
 - when the battery is low,
 - with certain lenses, or
 - if a non-CPU lens is attached with **[Aperture ring]** selected for Custom Setting f5 **[Customize command dials]** > **[Aperture setting]**.
-

Self-Timer Mode (☺)

The self-timer can be used to reduce camera shake or for self-portraits.

1 Select self-timer mode.

Press the release mode dial lock release and turn the release mode dial to ☺.

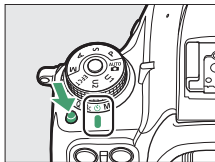

2 Frame the photograph and focus.

The timer will not start if the camera is unable to focus with **AF-S** selected for AF mode or in other situations in which the shutter cannot be released.



3 Start the timer.

- Press the shutter-release button all the way down to start the timer; the shutter will be released after about 10 seconds, during which the self-timer lamp will at first flash for approximately 8 seconds and then light for roughly 2 seconds.



- To turn the self-timer off before a photograph is taken, turn the release mode dial to another setting.
- The timer duration, the number shots taken, and the interval between shots can be selected using Custom Setting c3 [**Self-timer**].

Mirror up Mode (MUP)

Choose this mode to minimize blurring caused by camera movement when the mirror is raised. To use mirror-up mode, press the release mode dial lock release and rotate the release mode dial to **MUP** (mirror up). After pressing the shutter-release button halfway to set focus and exposure, press the shutter-release button the rest of the way down to raise the mirror. **rdy** will be displayed in the control panel; press the shutter-release button all the way down again to take the picture.

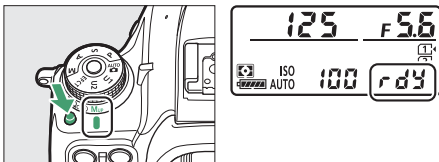

✓ Mirror Up

While the mirror is raised, photos cannot be framed in the viewfinder and autofocus and metering will not be performed.

Mirror-Up Mode

- Use of a tripod is recommended.
 - To prevent blurring caused by camera movement, press the shutter-release button smoothly.
 - The mirror lowers when shooting ends.
 - A picture will be taken automatically if no operations are performed for about 30 s after the mirror is raised.
 - In live view, the picture is taken the first time the shutter-release button is pressed all the way down.
-

Adjusting the Camera's Sensitivity to Light (ISO Sensitivity)

ISO Sensitivity

The camera's sensitivity to light can be adjusted according to the amount of light available. Choose from settings that range from ISO 100 and ISO 51200. Settings of from about 0.3 to 1 EV below ISO 100 and 0.3 to 2 EV above ISO 51200 are also available for special situations. The higher the ISO sensitivity, the less light needed to make an exposure, allowing higher shutter speeds or smaller apertures.

■ Adjusting ISO Sensitivity

Hold the **ISO** (FORMAT) button and rotate the main command dial.

- The selected option is displayed in the control panel and viewfinder.

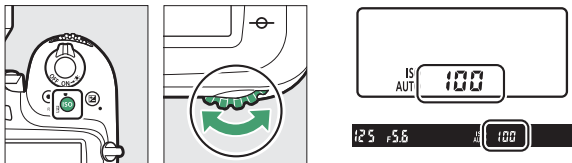

- **AUTO** and all **EFCT** modes other than **AF** also offer an ISO sensitivity of **Auto** ([Auto]). When **Auto** is selected, the camera adjusts ISO sensitivity automatically.
- By default, changes are made in increments of $\frac{1}{3}$ EV. The size of the increments can be changed using Custom Setting b1 [EV steps for exposure ctrl].

The Photo Shooting Menu [ISO Sensitivity Settings] Option

ISO sensitivity can also be adjusted using the [ISO sensitivity settings] item in the photo shooting menu.

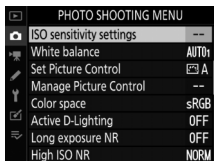

High ISO Sensitivities

The higher the ISO sensitivity, the less light needed to make an exposure, allowing pictures to be taken when lighting is poor and helping prevent blur when the subject is in motion. Note, however, that the higher the sensitivity, the more likely the image is to be affected by “noise” in the form of randomly-spaced bright pixels, fog, or lines.

- “Noise” can be reduced by enabling high ISO noise reduction. High ISO noise reduction can be enabled using the [High ISO NR] items in the photo and movie shooting menus.

Hi 0.3–Hi 2

A setting of [Hi 0.3] corresponds to an ISO sensitivity approximately 0.3 EV higher than ISO 51200 (ISO 64000) and [Hi 2.0] to an ISO sensitivity approximately 2 EV higher (ISO 204800). Note that pictures taken at these settings are particularly prone to “noise” in the form of randomly-spaced bright pixels, fog, or lines.

Lo 0.3–Lo 1

The settings [Lo 0.3] through [Lo 1.0] correspond to ISO sensitivities 0.3–1 EV below ISO 100 (ISO 80–50 equivalent). Use for larger apertures or slower shutter speeds when lighting is bright. Highlights may be overexposed. In most cases, ISO sensitivities of ISO [100] or above are recommended.

Auto ISO Sensitivity Control

Auto ISO sensitivity control automatically adjusts ISO sensitivity if optimal exposure cannot be achieved at the value selected by the user in **P**, **S**, **A**, and **M** modes.

■ Enabling Auto ISO Sensitivity Control

- 1 Select [ISO sensitivity settings] in the photo shooting menu, highlight [Auto ISO sensitivity control] and press .**

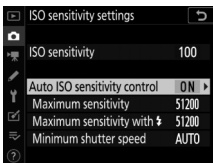

- 2 Select [On].**

- Highlight **[On]** and press  to enable auto ISO sensitivity control. If a flash is used, ISO sensitivity will be adjusted appropriately.
- If **[Off]** is selected, sensitivity will remain fixed at the value selected by the user.

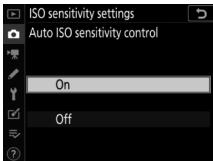

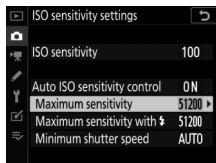

3 Adjust settings.

- Adjust auto ISO sensitivity control settings.



Option	Description
[Maximum sensitivity]	To prevent ISO sensitivity being raised too high, you can select an upper limit for ISO sensitivity control; choose from values of from ISO 200 to Hi 2. The minimum value that will be selected using auto ISO sensitivity control is ISO 100.
[Maximum sensitivity with flash]	Choose the maximum ISO sensitivity for flash photography; options range from ISO 200 to Hi 2. Selecting [Same as without flash] sets the maximum ISO sensitivity for flash photography to the value currently selected for [Maximum sensitivity] .

Option	Description
<p>[Minimum shutter speed]</p>	<p>In modes P and A, auto ISO sensitivity control only takes effect if shutter speed needed for optimal exposure would fall below this value; choose from settings of $1/4000$ s to 30 s. If [Auto] is selected, the camera will choose the minimum shutter speed based on lens focal length (CPU lenses only). For example, the camera will automatically choose faster minimum shutter speeds to prevent blur caused by camera shake when a long lens is attached.</p> <ul style="list-style-type: none"> • To view auto shutter-speed selection options, highlight [Auto] and press . Auto shutter-speed selection can be fine-tuned by choosing faster or slower minimums. Faster settings can be used to reduce blur when photographing fast-moving subjects. • Shutter speeds may drop below the selected minimum if optimal exposure cannot be achieved at the ISO sensitivity chosen for [Maximum sensitivity].

- Press  to save changes.

When [On] is selected for [Auto ISO sensitivity control], **ISO AUTO** indicators will appear in the control panel and viewfinder. When these indicators are lit (not flashing), pictures will be taken at the sensitivity selected for [ISO sensitivity]. When sensitivity is altered from the value selected by the user, the **ISO AUTO** indicators will flash and the altered value will be shown in the displays.

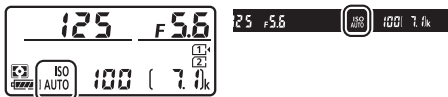

✔ Auto ISO Sensitivity Control

- If value currently selected for **[ISO sensitivity]** is higher than that chosen for **[Maximum sensitivity]**, the value chosen for **[ISO sensitivity]** will serve as the upper limit for auto ISO sensitivity control.
- During flash photography, shutter speed is limited to the range defined by the values selected for Custom Settings e1 **[Flash sync speed]** and e2 **[Flash shutter speed]**. If the value selected for **[Minimum shutter speed]** is not in this range, the value selected for Custom Setting e2 **[Flash shutter speed]** becomes the effective minimum shutter speed.
- If a non-CPU lens is used without lens data, the minimum shutter speed will be fixed at $1/30$ s.
- If an optional flash unit is attached, ISO sensitivity may be raised automatically when auto ISO sensitivity control is used in combination with slow sync flash modes, possibly preventing the camera from selecting slow shutter speeds (☐ 460, 465).

✔ Turning Auto ISO Sensitivity Control On or Off

You can turn **[Auto ISO sensitivity control]** on or off by pressing the **ISO** (☐) button and rotating the sub-command dial (☐ 93).

Achieving Natural Colors with Different Light Sources (White Balance)



White Balance

White balance ensures that colors are unaffected by the color of the light source. Auto white balance (**WB A**) is recommended with most light sources. If the desired results cannot be achieved with auto white balance, choose an option from the list below or use preset white balance.

- In modes other than **P**, **S**, **A**, and **M**, the camera adjusts white balance automatically according to the scene.

Option (K *)	Description
WB A [Auto]	White balance is adjusted automatically for optimal results with most light sources. When an optional flash unit is used, white balance will be adjusted according to the lighting produced by the flash.
WB A₀ [Keep white (reduce warm colors)] (3500–8000 K)	Eliminate warm color cast produced by incandescent lighting.
WB A₁ [Keep overall atmosphere] (3500–8000 K)	Partially preserve warm color cast produced by incandescent lighting.
WB A₂ [Keep warm lighting colors] (3500–8000 K)	Preserve warm color cast produced by incandescent lighting.

Option (K*)	Description
☀️ A [Natural light auto] (4500–8000 K)	When used under natural light, this option produces colors closer to those seen by the naked eye.
☀️ [Direct sunlight] (5200 K)	Use with subjects lit by direct sunlight.
☁️ [Cloudy] (6000 K)	Use in daylight under overcast skies.
🏠 [Shade] (8000 K)	Use in daylight with subjects in shade.
💡 [Incandescent] (3000 K)	Use under incandescent lighting.
💡 [Fluorescent]	Use under fluorescent lighting; choose bulb type according to light source.
[Sodium-vapor lamps] (2700 K)	
[Warm-white fluorescent] (3000 K)	
[White fluorescent] (3700 K)	
[Cool-white fluorescent] (4200 K)	
[Day white fluorescent] (5000 K)	
[Daylight fluorescent] (6500 K)	
[High temp. mercury-vapor] (7200 K)	

Option (K*)	Description
WB  [Flash] (5400 K)	Use with studio strobe lighting and other large flash units.
K [Choose color temperature] (2500–10000 K)	Choose color temperature from list of values or by holding ?/On (WB) button and rotating sub-command dial.
PRE [Preset manual]	Measure white balance for subject or light source (press and hold ?/On (WB) button to enter direct measurement mode,  209), copy white balance from existing photograph, or choose existing value by holding ?/On (WB) button and rotating sub-command dial.

* Color temperature. All values are approximate and do not reflect fine-tuning (if applicable).

WB A ([Auto])

The photo info for pictures shot using auto white balance lists the color temperature selected by the camera at the time the picture was taken. You can use this as reference when choosing a value for [Choose color temperature].

- To view shooting data during playback, go to [Playback display options] in the playback menu and select [Shooting data].

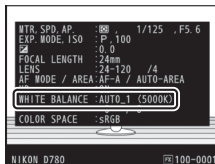

■ Choosing a White Balance Option

Hold the **WB** button and rotate the main command dial.

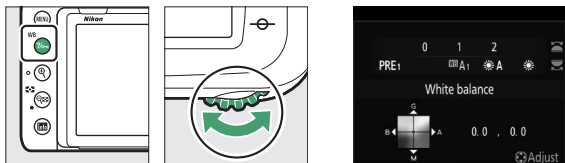

Options for the selected setting, if any, can be selected by holding the **WB** button and rotating the sub-command dial.

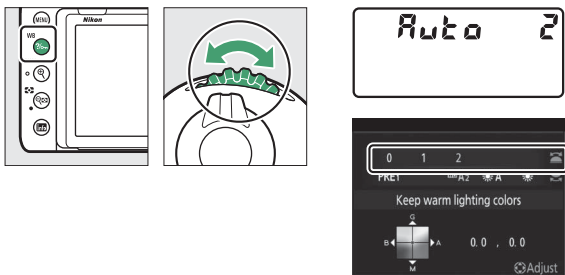



✓ Studio Flash Lighting

WB A ([Auto]) may not produce the desired results with large studio flash units. Use preset white balance or set white balance to **WB** ⚡ ([Flash]) and use fine-tuning to adjust white balance.

The [White Balance] Option

White balance can also be adjusted via the **[White Balance]** item in the photo and movie shooting menus.

A ([Natural Light Auto])

 **A ([Natural light auto])** may not produce the desired results under artificial light. Choose  **A ([Auto])** or an option that matches the light source.

Fine-Tuning White Balance

■ Using Buttons

If coordinates are displayed as shown, you can hold the **?/WB** (WB) button and use the multi selector to fine-tune white balance.

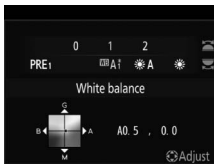
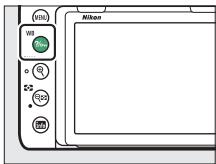

- Press or to fine-tune white balance on the amber-blue axis and or to fine-tune white balance on the green-magenta axis.
- The selected setting takes effect when the **?/WB** (WB) button is released.

■ Using the Menus

- 1 Select [White balance] in the photo shooting menu, highlight the desired option, and press  as often as necessary to display fine-tuning options.

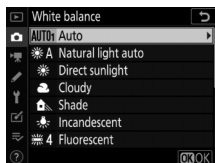

For information on fine-tuning preset manual white balance, see “Fine-Tuning Preset Manual White Balance” (📖 223).

2 Fine-tune white balance.

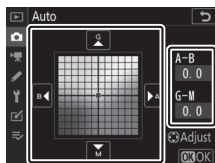

- Use the multi selector to position the cursor on the grid. The cursor can be moved up to six steps from the center along either of the A (amber)–B (blue) and G (green)–M (magenta) axes. The selected value is displayed to the right of the grid.
- The A (amber)–B (blue) axis corresponds to color temperature and is ruled in increments of 0.5. A change of 1 is equivalent to approximately 5 mired.
- The G (green)–M (magenta) axis has effects similar to color compensation filters and is ruled in increments of 0.25. A change of 1 is equivalent to approximately 0.05 diffuse density units.



3 Press .

Press  to save settings and return to the photo shooting menu.

Adjusting White Balance in the *i* Menu

To view white balance options, highlight **[White balance]** in the *i* menu and press . If an option other than **[Choose color temperature]** is selected, white balance can be fine-tuned by selecting an option and pressing  until fine-tuning options are displayed. The results of fine-tuning can be previewed in the display.

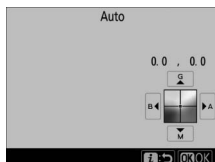

White Balance Fine-Tuning

The colors on the fine-tuning axes are relative, not absolute. For example, moving the cursor to B (blue) when a “warm” setting such as  (**[Incandescent]**) is selected for white balance will make photographs slightly “colder” but will not actually make them blue.

"Mired"

Any given change in color temperature produces a greater difference in color at low color temperatures than it would at higher color temperatures. For example, a change of 1000 K produces a much greater change in color at 3000 K than at 6000 K. Mired, calculated by multiplying the inverse of the color temperature by 10^6 , is a measure of color temperature that takes such variation into account, and as such is the unit used in color-temperature compensation filters. E.g.:

- 4000 K–3000 K (a difference of 1000 K)=83 mired
 - 7000 K–6000 K (a difference of 1000 K)=24 mired
-





Choosing a Color Temperature

■ Using Buttons (Amber–Blue Only)

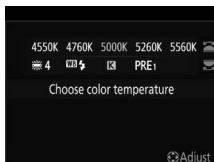
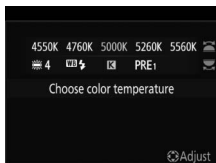
To adjust color temperature when [Choose color temperature] is selected for white balance, hold the **?/WB** button and use the multi selector or rotate the sub-command dial.

- Hold the **?/WB** button and rotate the sub-command dial to choose a color temperature in mireds.



- To highlight a digit, hold the **?/WB** button and press  or . Press  or  to edit the highlighted digit.

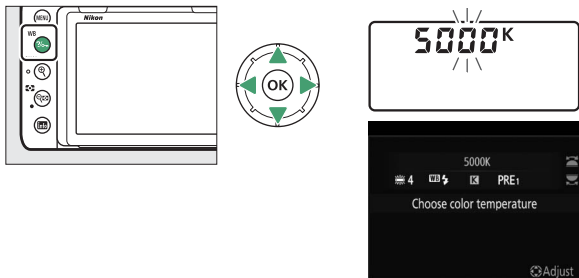

- Changes apply only to the A (amber)–B (blue) axis.
- The selected setting takes effect when the **?/WB** button is released.

✔ Choose Color Temperature

Note that the desired results will not be obtained with flash or fluorescent lighting. Choose ⚡ ([Flash]) or ☀ ([Fluorescent]) for these sources. With other light sources, take a test shot to determine if the selected value is appropriate.

✔ Color Temperature

The perceived color of a light source varies with the viewer and other conditions. Color temperature is an objective measure of the color of a light source, defined with reference to the temperature to which an object would have to be heated to radiate light in the same wavelengths. While light sources with a color temperature in the neighborhood of 5000–5500 K appear white, light sources with a lower color temperature, such as incandescent light bulbs, appear slightly yellow or red (①). Light sources with a higher color temperature appear tinged with blue (②).

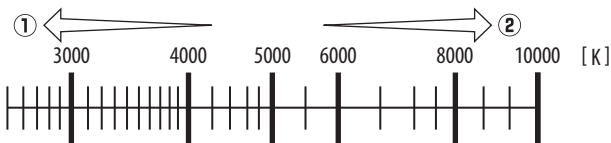

In general, choose lower values if your pictures have a red cast or to intentionally make colors colder, higher values if your pictures are tinged blue or to intentionally make colors warmer.





■ Using the Menus

Color temperature can be selected using the **[White balance]** options in the photo shooting menu. Enter values for the amber–blue and green–magenta axes as described below.





1 Select **[Choose color temperature]**.

Select **[White balance]** in the photo shooting menu, then highlight **[Choose color temperature]** and press .

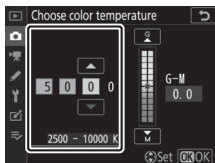
2 Select values for amber–blue and green–magenta.



- Press  or  to highlight digits on the amber (A)–blue (B) axis and press  or  to change.

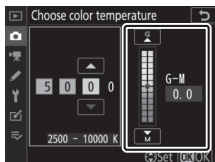

- Press  or  to highlight the value for the green (G)–magenta (M) axis and press  or  to change.



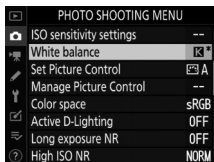

3 Press .

- Press  to save changes and return to the photo shooting menu.
- If a value other than 0 is selected for the green (G)–magenta (M) axis, an asterisk (“*”) will appear next to the  icon.



Choosing Color Temperature in the *i* Menu

To view white balance options, highlight **[White balance]** in the *i* menu and press .

When **[Choose color temperature]** is selected, color temperature options can be viewed by pressing .



Preset Manual

Preset manual is used to record and recall custom white balance settings for shooting under mixed lighting or to compensate for light sources with a strong color cast. The camera can store up to six values for preset white balance in presets d-1 through d-6. Two methods are available for setting preset white balance:

Method	Description
Direct measurement	Neutral gray or white object is placed under lighting that will be used in final photograph and white balance is measured by camera (☞ 210). During live view, white balance can be measured in a selected area of the frame (spot white balance, ☞ 216).
Copy from existing photograph	White balance is copied from photo on memory card (☞ 221).

■ Viewfinder Photography

Before Measuring White Balance:

- Place a neutral gray or white object under the lighting that will be used in the final photograph. In studio settings, a standard 18% gray panel can be used as a reference object.
- Note that exposure is automatically increased by 1 EV when white balance is measured using a neutral gray or white reference object. In mode **M**, adjust exposure so that the exposure indicator shows ± 0 (☞ 114).

1 Keeping the **WB** button pressed, rotate the main command dial to select PRE.



2 Select a preset.

Press the **WB** button and rotate the sub-command dial until the desired white balance preset (d-1 to d-6) is displayed.

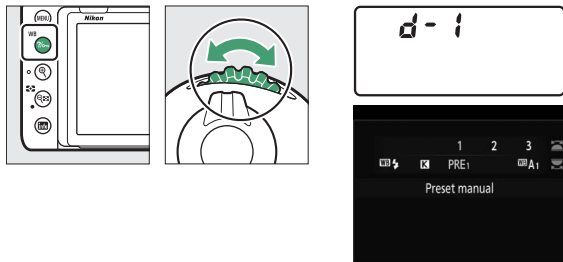

3 Select direct measurement mode.

- Release the **WB** button briefly and then press the button until the **P_rE** indicators in the control panel and viewfinder start to flash.



- In direct measurement mode, the focus point changes to a white balance target as shown and stays in the center of the frame.

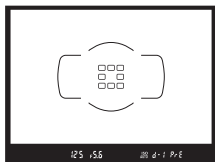

4 Before the **P_rE** indicators stop flashing, photograph the reference object.

- Position the reference object in the white balance target and press the shutter-release button all the way down to measure a value for white balance and store it in the preset selected in Step 2.
- No photograph will be recorded; white balance can be measured accurately even when the camera is not in focus.



5 Check the results.

- If the camera was able to measure a value for white balance, **Good** will flash in the control panel, while the viewfinder will show a flashing **Wd**. Press the shutter-release button halfway to exit to shooting mode.

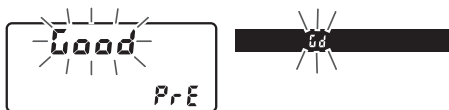

- If lighting is too dark or too bright, the camera may be unable to measure white balance. A flashing **no Wd** will appear in the control panel and viewfinder. Press the shutter-release button halfway to return to Step 4 and measure white balance again.



✔ **Time Restrictions on Measuring Preset Manual White Balance (Viewfinder Photography)**

If no operations are performed during viewfinder photography while the displays are flashing, direct measurement mode will end in the time selected for Custom Setting c2 [**Standby timer**].

✔ **Measuring Preset Manual White Balance (Viewfinder Photography)**

Preset manual white balance cannot be measured during time-lapse movie recording or while you are shooting a multiple exposure.

✔ **Protected Presets**

If the current preset is protected, the camera will be unable to measure a value for preset manual white balance; any attempt to measure white balance for a protected preset will be accompanied by a flashing **P r** in the control panel and viewfinder.

✍ Selecting a Preset

- Selecting [**Preset manual**] for [**White balance**] in the photo shooting menu displays white balance presets; highlight a preset and press **OK**.
- If no value currently exists for the selected preset, white balance will be set to 5200 K, the same as [**Direct sunlight**].

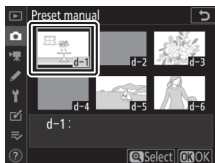

✍ Measuring Preset White Balance from the **i** Menu

With preset manual selected for white balance, display the **i** menu, highlight [**White balance**], and then press and hold **OK** to place the camera in direct measurement mode.

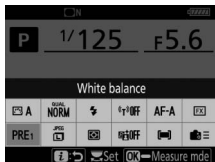

■ Live View (Spot White Balance)

During live view, white balance can be measured from white or gray objects in a smaller area of the frame than would be possible in viewfinder photography, eliminating the need to prepare a reference object or change lenses during telephoto photography.

- When measuring preset manual white balance for flash photography, use the viewfinder as described in “Viewfinder Photography” (📖 210).

1 Keeping the ?/WB (WB) button pressed, rotate the main command dial to select PRE.

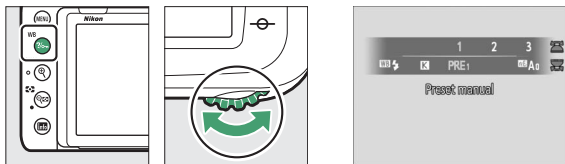

2 Select a preset.

Press the **?/WB** (WB) button and rotate the sub-command dial until the desired white balance preset (d-1 to d-6) is displayed.



3 Select direct measurement mode.

Release the **?/WB** (WB) button briefly and then press the button until the **PRE** icon in the monitor starts to flash.

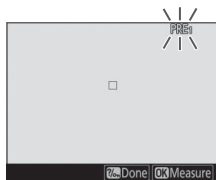

4 While the PRE icon is flashing, position the spot white balance target (□) over a white or gray area of the subject.

- To zoom in on the area around the target (□) for more precise positioning, press the \mathcal{R} (QUAL) button.
- You can also position the target (□) by tapping your subject in the monitor. Tapping the monitor positions the target (□) and measures white balance at the selected location. After measuring white balance, proceed to Step 6.

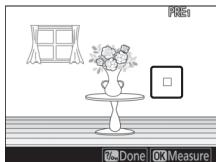

5 Measure a value for preset white balance either by pressing **OK** or by pressing the shutter-release button all the way down.

- If the camera is able to measure white balance, the new value will be reflected in the display.
- If the camera is unable to measure white balance, a message will be displayed and the camera will return to Step 4. Measure white balance again after repositioning the white balance target (□) or the like.

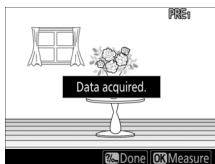

6 Press the **?/WB** (WB) button to exit direct measurement mode.

White balance presets can be viewed by selecting [**Preset manual**] for [**White balance**] in the photo or movie shooting menu. The position of the targets used to measure preset white balance is displayed on presets recorded during live view.

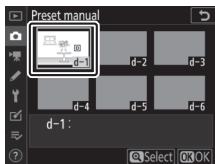

✔ **Time Restrictions on Measuring Preset Manual White Balance (Live View)**

The time available to measure white balance is that selected for Custom Setting c4 [**Monitor off delay**] > [**Live view**].

✔ **Measuring Preset Manual White Balance (Live View)**

Preset manual white balance cannot be measured while a multiple exposure is in progress.

■ Copying White Balance from a Photograph

Follow the steps below to copy a value for white balance from an existing photograph to a selected preset.

1 Select [Preset manual].

Select [**White balance**] in the photo shooting menu, then highlight [**Preset manual**] and press .

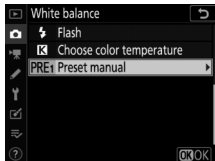

2 Select a destination.

Highlight the destination preset (d-1 to d-6) and press  (**QUAL**).

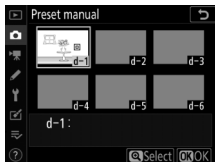

3 Choose Select image.

Highlight [**Select image**] and press .

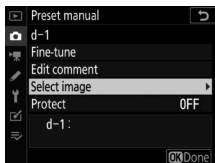

4 Highlight a source image.

Highlight the source image. To view the highlighted image full frame, press and hold the **Q** (**QUAL**) button.



5 Copy white balance.

- Press **Q** to copy the white balance value for the highlighted photograph to the selected preset.
- If the highlighted photograph has a comment, the comment will be copied to the comment for the selected preset.

Fine-Tuning Preset White Balance

The selected preset can be fine-tuned by selecting [**Fine-tune**] and adjusting white balance as described in “Fine-Tuning White Balance” (📖 200).

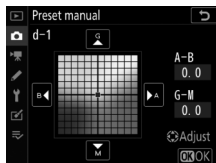

Edit Comment

To enter a descriptive comment of up to 36 characters for the current white-balance preset, select [**Edit comment**] in the preset manual white balance menu and enter a comment (📖 61).



Protect

To protect the current white-balance preset, select [**Protect**] in the preset manual white balance menu, then highlight [**On**] and press . Protected presets cannot be modified.

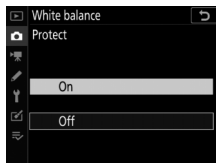

Varying Exposure or White Balance over a Series of Photographs (Bracketing)

Bracketing automatically varies exposure, flash level, Active D-Lighting (ADL), or white balance slightly with each shot, “bracketing” the current value. Choose in situations in which getting the right settings is difficult and there is not time to check results and adjust settings with each shot, or to experiment with different settings for the same subject.

- Bracketing is available in modes **P**, **S**, **A**, and **M** only.

Bracketing

Bracketing is adjusted using the **[Auto bracketing]** > **[Auto bracketing set]** item in the photo shooting menu, which contains the following options:

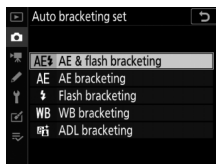

Option	Description
[AE & flash bracketing]	The camera varies exposure and flash level over a series of photographs.
[AE bracketing]	The camera varies exposure over a series of photographs.
[Flash bracketing]	The camera varies flash level over a series of photographs.
[WB bracketing]	The camera creates multiple copies of each photograph, each with a different white balance (☞ 195).
[ADL bracketing]	The camera varies Active D-Lighting over a series of photographs (☞ 254).

Exposure and Flash Bracketing

Vary exposure and/or flash level over a series of photographs.
To perform exposure and/or flash bracketing:



Exposure modified by:
0 EV



Exposure modified by:
-1 EV



Exposure modified by:
+1 EV

1 Choose the number of shots and exposure increment.

- Pressing the **BKT** button, rotate the main command dial to choose the number of shots in the bracketing sequence.



- At settings other than zero, a **BKT** icon and exposure and flash bracketing indicator will appear in the control panel and **BKT** will be displayed in the viewfinder.



- Pressing the **BKT** button, rotate the sub-command dial to choose the exposure increment.

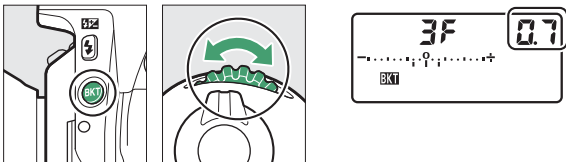

- When [**1/3 step**] is selected for Custom Setting b1 [**EV steps for exposure ctrl**], the size of the increment can be chosen from 0.3 ($1/3$), 0.7 ($2/3$), 1.0, 2.0, and 3.0 EV. Bracketing programs with an increment of 2.0 or 3.0 EV offer a maximum of 5 shots. If a value of 7 or 9 was selected in Step 1, the number of shots will automatically be set to 5.

- The bracketing programs with an increment of 0.3 (1/3) EV are listed below.

Control panel display	Exposure and flash bracketing indicator	No. of shots	Bracketing order (EVs)
0F 0.3	-.....°.....+	0	0
+3F 0.3	-.....°; ;.....+	3	0/+0.3/+0.7
--3F 0.3	-.....; ;°.....+	3	0/-0.7/-0.3
+2F 0.3	-.....°;.....+	2	0/+0.3
--2F 0.3	-.....; ;°.....+	2	0/-0.3
3F 0.3	-.....; ;°.....+	3	0/-0.3/+0.3
5F 0.3	-.....; ;°; ;.....+	5	0/-0.7/-0.3/+0.3/+0.7
7F 0.3	-.....; ;°; ;.....+	7	0/-1.0/-0.7/-0.3/+0.3/+0.7/+1.0
9F 0.3	-.....; ;°; ;.....+	9	0/-1.3/-1.0/-0.7/-0.3/+0.3/+0.7/+1.0/+1.3

2 Frame a photograph, focus, and shoot.



- The camera will vary exposure and/or flash level shot-by-shot according to the bracketing program selected. Modifications to exposure are added to those made with exposure compensation (📖 175).
- The modified values for shutter speed and aperture are shown in the display.
- While bracketing is in effect, a bracketing progress indicator will be displayed in the control panel. A segment will disappear from the indicator after each shot.

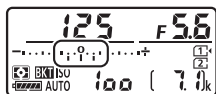

No. shots: 3;
increment: 0.7

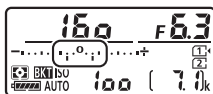

Display after first shot

✔ Exposure and Flash Bracketing

- **[Number of shots]** and **[Increment]** can also be selected via the **[Auto bracketing]** item in the photo shooting menu.
 - In continuous release modes, shooting will pause after the number of shots specified in the bracketing program have been taken. Shooting will resume the next time the shutter-release button is pressed.
 - If the memory card fills before all shots in the sequence have been taken, shooting can be resumed from the next shot in the sequence after the memory card has been replaced or shots have been deleted to make room on the memory card. If the camera is turned off before all shots in the sequence have been taken, bracketing will resume from the next shot in the sequence when the camera is turned on.
-

✔ Bracketing Options

When **[AE & flash bracketing]** is selected, the camera varies both exposure and flash level. Select **[AE bracketing]** to vary only exposure, **[Flash bracketing]** to vary only flash level. Note that flash bracketing is available in i-TTL and, where supported, auto aperture (A) flash control modes only (□ 462, 798).

✔ Exposure Bracketing

The camera modifies exposure by varying shutter speed and aperture (mode **P**), aperture (mode **S**), or shutter speed (modes **A** and **M**). If **[On]** is selected for **[ISO sensitivity settings]** > **[Auto ISO sensitivity control]** in modes **P**, **S**, and **A**, the camera will automatically vary ISO sensitivity for optimum exposure when the limits of the camera exposure system are exceeded; in mode **M**, the camera will first use auto ISO sensitivity control to bring exposure as close as possible to the optimum and then bracket this exposure by varying shutter speed.

■ ■ Canceling Bracketing

To cancel bracketing, press the **BKT** button and rotate the main command dial until the number of shots in the bracketing sequence is zero (0F) and **BKT** is no longer displayed. The program last in effect will be restored the next time bracketing is activated. Bracketing can also be cancelled by performing a two-button reset (☐ 282), although in this case the bracketing program will not be restored the next time bracketing is activated.

White Balance Bracketing

The camera creates multiple copies of each photograph, each with a different white balance. To use white balance bracketing:

- In continuous release modes, the camera will record only the number of photographs selected in the white balance bracketing program.

1 Choose the number of shots and exposure increment.

- Pressing the **BKT** button, rotate the main command dial to choose the number of shots in the bracketing sequence.

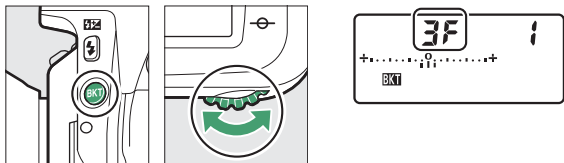

- At settings other than zero, a **BKT** icon and WB bracketing indicator will appear in the control panel and **BKT** will be displayed in the viewfinder.

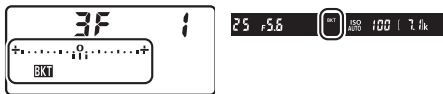

- Pressing the **BKT** button, rotate the sub-command dial to choose the white balance adjustment.

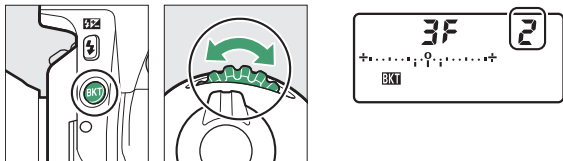

- The size of the increment can be chosen from 1 (1 step), 2 (2 steps), or 3 (3 steps).
- Each step is equivalent to 5 mired. Higher **A** values correspond to increased amounts of amber. Higher **B** values correspond to increased amounts of blue (☞ 200).

- The bracketing programs with an increment of 1 are listed below.

Control panel display	WB bracketing indicator	No. of shots	White balance increment	Bracketing order
0F	+ 0 +	0	1	0
b3F	+ iii +	3	1B	0/B1/B2
A3F	+ i +	3	1A	0/A2/A1
b2F	+ ii +	2	1B	0/B1
A2F	+ i +	2	1A	0/A1
3F	+ iii +	3	1A, 1B	0/A1/B1
5F	+ iiiii +	5	1A, 1B	0/A2/A1/B1/B2
7F	+ iiiiii +	7	1A, 1B	0/A3/A2/A1/B1/B2/B3
9F	+ iiiiii +	9	1A, 1B	0/A4/A3/A2/A1/B1/B2/B3/B4

2 Frame a photograph, focus, and shoot.



- Each shot will be processed to create the number of copies specified in the bracketing program, and each copy will have a different white balance. Modifications to white balance are added to the white balance adjustment made with white balance fine-tuning.
- If the number of shots in the bracketing program is greater than the number of exposures remaining, **FULL** and the icon for the affected card will flash in the control panel, a flashing **FuL** icon will appear in the viewfinder, and the shutter release will be disabled. Shooting can begin when a new memory card is inserted.

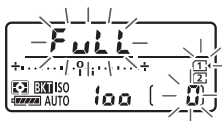

✔ White Balance Bracketing Restrictions

White balance bracketing is not available at image quality settings of NEF (RAW) or NEF (RAW) + JPEG.

✔ White Balance Bracketing

- [Number of shots] and [Increment] can also be selected via the [Auto bracketing] item in the photo shooting menu.
 - White balance bracketing affects only color temperature (the amber-blue axis in the white balance fine-tuning display,  200). No adjustments are made on the green-magenta axis.
 - If the camera is turned off while the memory card access lamp is lit, the camera will power off only after all photographs in the sequence have been recorded.
-

■ ■ Canceling Bracketing

To cancel bracketing, press the **BKT** button and rotate the main command dial until the number of shots in the bracketing sequence is zero (0F) and **BKT** is no longer displayed. The program last in effect will be restored the next time bracketing is activated. Bracketing can also be cancelled by performing a two-button reset (☐ 282), although in this case the bracketing program will not be restored the next time bracketing is activated.

ADL Bracketing

The camera varies Active D-Lighting over a series of exposures. To use ADL bracketing:

1 Choose the number of shots.

- Pressing the **BKT** button, rotate the main command dial to choose the number of shots in the bracketing sequence.

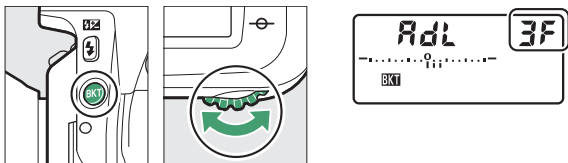

- At settings other than zero, a **BKT** icon and an ADL bracketing indicator appear in the control panel and **BKT** will be displayed in the viewfinder.





- Choose two shots to take one photograph with Active D-Lighting off and another at a selected value. Choose three to five shots to take a series of photographs with Active D-Lighting set to **[Off]**, **[Low]**, and **[Normal]** (three shots), **[Off]**, **[Low]**, **[Normal]**, and **[High]** (four shots), or **[Off]**, **[Low]**, **[Normal]**, **[High]**, and **[Extra high]** (five shots). If you choose more than two shots, proceed to Step 3.

2 If the number of shots in the bracketing sequence is 2, choose the Active D-Lighting amount.

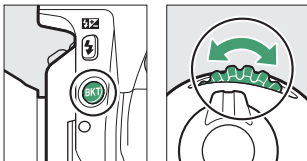
- Hold the **BKT** button and rotate the sub-command dial to choose the Active D-Lighting setting for the second shot.

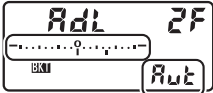
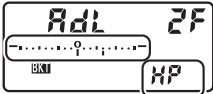
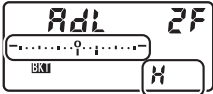
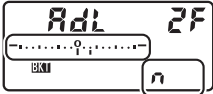

- Active D-Lighting is shown in the control panel.

ADL	Control panel display
暗A [Auto]	
暗H+ [Extra high]	
暗H [High]	
暗N [Normal]	
暗L [Low]	

3 Frame a photograph, focus, and shoot.

The camera will vary Active D-Lighting shot-by-shot according to the bracketing program selected. While bracketing is in effect, a bracketing progress indicator will be displayed in the control panel. A segment will disappear from the indicator after each shot.

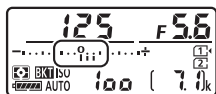

No. shots: 3

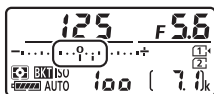

Display after first shot

ADL Bracketing

- **[Number of shots]** and **[Amount]** can also be selected via the **[Auto bracketing]** item in the photo shooting menu.
- In continuous release modes, shooting will pause after the number of shots specified in the bracketing program have been taken. Shooting will resume the next time the shutter-release button is pressed.
- If the memory card fills before all shots in the sequence have been taken, shooting can be resumed from the next shot in the sequence after the memory card has been replaced or shots have been deleted to make room on the memory card. If the camera is turned off before all shots in the sequence have been taken, bracketing will resume from the next shot in the sequence when the camera is turned on.

■ Canceling Bracketing

To cancel bracketing, press the **BKT** button and rotate the main command dial until the number of shots in the bracketing sequence is zero (0) and **BKT** is no longer displayed. The program last in effect will be restored the next time bracketing is activated. Bracketing can also be cancelled by performing a two-button reset (see 282), although in this case the bracketing program will not be restored the next time bracketing is activated.





Image Processing (Picture Controls)

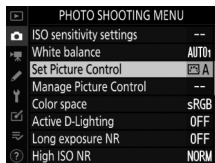





Selecting a Picture Control

Adjust image processing (Picture Control) settings according to your subject or creative intent. Picture Control options can be accessed via the **[Set Picture Control]** items in the photo and movie shooting menus (☞ 553, 577).



- In modes other than **P**, **S**, **A**, and **M**, the camera chooses a Picture Control automatically according to the scene.

	Option	Description
	[Auto]	The camera automatically adjusts hues and tones based on the [Standard] Picture Control. The complexions of portrait subjects will appear softer, and such elements as the foliage and sky in outdoor shots more vivid, than in pictures taken with the [Standard] Picture Control.
	[Standard]	Standard processing for balanced results. Recommended for most situations.
	[Neutral]	Minimal processing for natural results. Choose for photographs that will later be processed or retouched.
	[Vivid]	Pictures are enhanced for a vivid, photoprint effect. Choose for photographs that emphasize primary colors.

	Option	Description
 MC	[Monochrome]	Take monochrome photographs.
 PT	[Portrait]	Smooth complexions for natural-looking portraits.
 LS	[Landscape]	Shoot vibrant landscapes and cityscapes.
 FL	[Flat]	Details are preserved over a wide tone range, from highlights to shadows. Choose for photographs that will later be extensively processed or retouched.
 01 -  20	[Creative Picture Control]	Creative Picture Controls offer unique combinations of hue, tone, saturation, and other settings tuned for particular effects. Choose from a total of 20 options, including [Dream] and [Morning] .

Set Picture Control

The **[Set Picture Control]** item in the movie shooting menu also offers a **[Same as photo settings]** option that sets the Picture Control for movies to the same as that used for photographs.

Modifying Picture Controls

Picture Controls can be modified to suit the scene or the photographer's creative intent.

1 Select a Picture Control.

Highlight the desired Picture Control in the Picture Control list and press

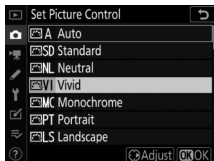

2 Adjust settings.

Press or to highlight the desired setting (247) and press or to choose a value in increments of 1, or rotate the sub-command dial to choose a value in increments of 0.25

(the options available vary with the Picture Control selected). To quickly adjust levels for balanced

[**Sharpening**], [**Mid-range sharpening**], and [**Clarity**],

highlight [**Quick sharp**] and press or . Repeat this step until all settings have been adjusted. Default settings can be restored by pressing the (**FORMAT**) button.



3 Save changes and exit.

Press **OK** to save changes and return to the Picture Control list. Picture Controls that have been modified from default settings are indicated by an asterisk (“*”).

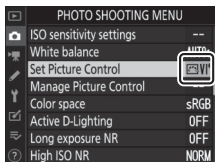

Picture Control Settings

Option	Description
[Effect level]	Mute or heighten the effect of Creative Picture Controls.
[Quick sharp]	Quickly adjust levels for balanced [Sharpening], [Mid-range sharpening], and [Clarity]. These parameters can also be adjusted individually.
[Sharpening]	[Sharpening]: Control the sharpness of details and outlines.
[Mid-range sharpening]	[Mid-range sharpening]: Adjust the sharpness of patterns and lines in the range between [Sharpening] and [Clarity].
[Clarity]	[Clarity]: Adjust overall sharpness and the sharpness of thicker outlines without affecting brightness or dynamic range.
[Contrast]	Adjust contrast.
[Brightness]	Raise or lower brightness without loss of detail in highlights or shadows.
[Saturation]	Control the vividness of colors.
[Hue]	Adjust hue.
[Filter effects]	Simulate the effect of color filters on monochrome pictures.
[Toning]	Choose the tint used in monochrome pictures. Pressing  when an option other than [B&W] (black-and-white) is selected displays saturation options.
[Toning] (Creative Picture Control)	Choose the shade of color used for Creative Picture Controls.

✓ [Filter Effects]

Choose from the following [Filter effects]:

Option	Description
[Y] (yellow) *	These options enhance contrast and can be used to tone down the brightness of the sky in landscape photographs. Orange ([O]) produces more contrast than yellow ([Y]), red ([R]) more contrast than orange.
[O] (orange) *	
[R] (red) *	
[G] (green) *	Green softens skin tones. Use for portraits and the like.

* The term in parentheses is the name of the corresponding third-party color filter for black-and-white photography.

✓ The *i* Menu

Highlighting [Set Picture Control] in the *i* menu and pressing \odot displays a Picture Control list. Highlight a Picture Control and press \odot to adjust settings.

- Press \odot or \odot to highlight settings. Press \odot or \odot to choose a value in increments of 1, or rotate the sub-command dial to choose a value in increments of 0.25.
- The options available vary with the Picture Control selected.
- Default settings can be restored by pressing the ⌫ (RESET) button.
- Press \odot to save changes and return to the *i* menu.
- Picture Controls that have been modified from default settings are indicated by an asterisk ("*").

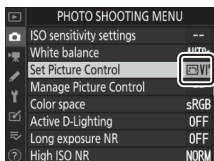
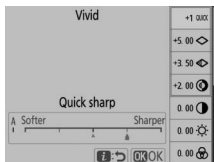

✓ The Δ Indicator

The Δ indicator under the value display in the Picture Control setting menu indicates the previous value for the setting.



✓ [A] (Auto)

- Selecting the [A] (auto) option available for some settings lets the camera adjust the setting automatically.
- Results vary with exposure and the position of the subject in the frame.



✓ The [Auto] Picture Control

Settings can be adjusted in the range [A-2] to [A+2].



Creating Custom Picture Controls

Save modified Picture Controls as custom Picture Controls.

Option	Description
[Save/edit]	Create a new custom Picture Control based on an existing preset or custom Picture Control, or edit existing custom Picture Controls.
[Rename]	Rename custom Picture Controls.
[Delete]	Delete custom Picture Controls.
[Load/save]	Copy custom Picture Controls to and from the memory card.

■ Creating Custom Picture Controls

The Picture Controls supplied with the camera can be modified and saved as custom Picture Controls.

1 Highlight [Manage Picture Control] in the photo or movie shooting menu and press .

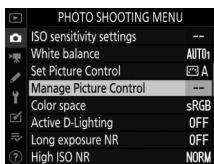

2 Select [Save/edit].

Highlight [Save/edit] and press  to view [Choose Picture Control] options.

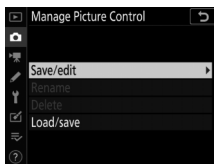

3 Select a Picture Control.

Highlight an existing Picture Control and press **▶**, or press **OK** to proceed to Step 5 to save a copy of the highlighted Picture Control without further modification.

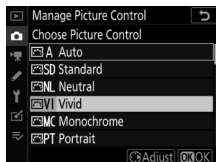

4 Edit the selected Picture Control.

To abandon any changes and start over from default settings, press the **FORMAT** button. Press **OK** when settings are complete.



5 Select a destination.

Choose a destination for the custom Picture Control (C-1 through C-9) and press **▶**.

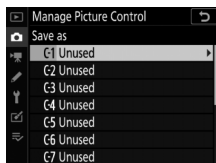

6 Name the Picture Control.

- A text-entry dialog will be displayed.
- By default, new Picture Controls are named by adding a two-digit number (assigned automatically) to the name of the existing Picture Control. Skip to Step 7 to proceed without renaming the Picture Control, or rename the Picture Control as described in “Text Entry” (61). Custom Picture Control names can be up to nineteen characters long. Any characters after the nineteenth will be deleted.



7 Press the QUAL (QUAL) button.

- Text entry will end.
- The new Picture Control will be added to the Picture Control list.

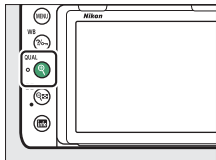

The Original Picture Control Icon

The original preset Picture Control on which the custom Picture Control is based is indicated by an icon in the top right corner of the edit display.

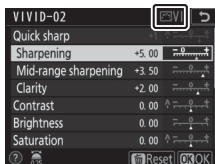

Custom Picture Control Options

The options available with custom Picture Controls are the same as those on which the custom Picture Control was based.

Sharing Custom Picture Controls

The **[Load/save]** item in the **[Manage Picture Control]** menu offers the options listed below. Use these options to copy custom Picture Controls to and from memory cards (these options are available only with the memory card in Slot 1 and cannot be used with the card in Slot 2). Once copied to memory cards, Picture Controls can be used with other cameras or compatible software.

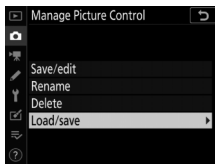

- **[Copy to camera]**: Copy custom Picture Controls from the memory card to custom Picture Controls C-1 through C-9 on the camera and name them as desired.
 - **[Delete from card]**: Delete selected custom Picture Controls from the memory card.
 - **[Copy to card]**: Copy a custom Picture Control (C-1 through C-9) from the camera to a selected destination (1 through 99) on the memory card.
-

Preserving Detail in Highlights and Shadows (Active D-Lighting and HDR)

Active D-Lighting

Active D-Lighting, accessed via the [**Active D-Lighting**] item in the photo or movie shooting menu, is used to preserve details in highlights and shadows, creating pictures with natural contrast. Use for high-contrast scenes, for example when photographing brightly-lit outdoor scenery through a door or window or taking pictures of shaded subjects on a sunny day. Active D-Lighting is most effective when [**Matrix metering**] is selected for metering.



[Off]



[Auto]

■ Active D-Lighting Options

Option		Description
暗A	[Auto]	The camera automatically adjusts Active D-Lighting in response to shooting conditions.
暗H*	[Extra high]	Choose the amount of Active D-Lighting performed from [Extra high], [High], [Normal], and [Low].
暗H	[High]	
暗N	[Normal]	
暗L	[Low]	
[Off]		Active D-Lighting off.

✓ Active D-Lighting and Movies

If [Same as photo settings] is selected for [Active D-Lighting] in the movie shooting menu and [Auto] is selected in the photo shooting menu, movies will be shot at a setting equivalent to [Normal].

✓ Active D-Lighting

- “Noise” in the form of randomly-spaced bright pixels, fog, or lines may appear in photos taken with Active D-Lighting.
- In mode M, [Auto] is equivalent to [Normal].
- Uneven shading may be visible with some subjects.
- Active D-Lighting does not apply at high ISO sensitivities (Hi 0.3–Hi 2), including high sensitivities selected via auto ISO sensitivity control.

High Dynamic Range (HDR)

The [**HDR (high dynamic range)**] item in the photo shooting menu can be used with high-contrast subjects to preserve details in highlights and shadows by combining two shots taken at different exposures. Use with high-contrast scenes and other subjects to preserve a wide range of details, from highlights to shadows.



■ HDR Options

The following options are available:

- [**HDR mode**]: Choose from [**On (series)**] (take a series of HDR photographs, ending when [**Off**] is selected), [**On (single photo)**] (take one HDR photograph), and [**Off**] (exit without taking additional HDR photographs).
- [**HDR strength**]: Choose the HDR strength. If [**Auto**] is selected, the camera will automatically adjust HDR strength to suit the scene.
- [**Save individual images (NEF)**]: Choose [**On**] to save each of the individual shots used to create the HDR image; the shots are saved in NEF (RAW) format.

■ Taking HDR Photographs



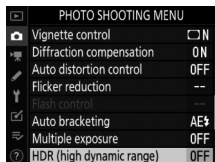

We recommend that you use the [**Matrix metering**] metering option when shooting with HDR.

1 Select [**HDR (high dynamic range)**].

Highlight [**HDR (high dynamic range)**] in the photo shooting menu and press .



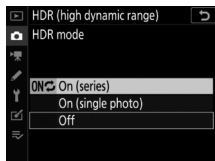
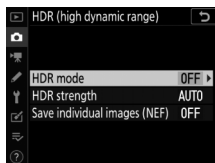

2 Select a mode.

- Highlight [**HDR mode**] and press .
- Choose an HDR mode using  or  and press .





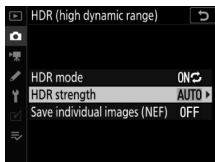

3 Choose the [HDR strength].

- To choose the difference in exposure between the two shots (HDR strength), highlight [**HDR strength**] and press .
- Highlight the desired option and press . If [**Auto**] is selected, the camera will automatically adjust HDR strength to suit the scene.



4 Choose whether to keep individual exposures.

To choose whether to save the individual NEF (RAW) images that make up the HDR photograph, highlight [**Save individual images (NEF)**] and press , then press  or  to choose the desired option and press  to select.

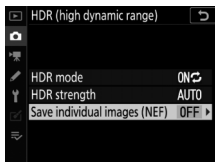

5 Frame a photograph, focus, and shoot.

- The camera takes two exposures when the shutter-release button is pressed all the way down. Flashing “bU5Y” and “b5Y” indicators will appear respectively in the control panel and viewfinder while the images are combined. No pictures can be taken until recording is complete.

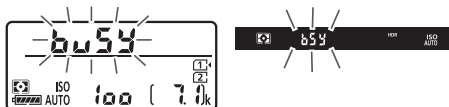

- If [**On (series)**] is selected, HDR will only turn off when [**Off**] is selected for HDR mode; if [**On (single photo)**] is selected, HDR turns off automatically after the photograph is taken.

✓ NEF (RAW)

HDR photographs taken when an NEF (RAW) or NEF (RAW) + JPEG option is selected for image quality will be recorded in JPEG format.

✔ HDR Photography

- The edges of the image will be cropped out.
- The desired results may not be achieved if the camera or subject moves during shooting. Use of a tripod is recommended.
- Depending on the scene, you may notice shadows around bright objects or halos around dark objects. In some cases, HDR may have little effect.
- Uneven shading may be visible with some subjects.
- With non-CPU lenses and when [**Spot metering**] or [**Center-weighted metering**] is selected, an [**HDR strength**] setting of [**Auto**] is equivalent to [**Normal**].
- Optional flash units will not fire.
- Regardless of the option currently selected for release mode, only one photograph will be taken each time the shutter-release button is pressed.
- Shutter speeds of **Bulb** (Bulb) and **Time** (Time) are not available.

✔ HDR Restrictions

HDR cannot be combined with some camera features, including:

- Modes other than **P**, **S**, **A**, and **M**
 - Flicker reduction
 - Bracketing
 - Multiple exposure
 - Interval-timer photography
 - Time-lapse movies
 - Focus shift
 - The negative digitizer
-

Choosing HDR Mode and Strength via the BKT Button and Command Dials

When [HDR (high dynamic range)] is selected for Custom Setting f3 [Custom controls] > [BKT button], [HDR mode] (Step 2) and [HDR strength] (Step 3) can be selected using the **BKT** button and command dials.

- Hold the **BKT** button and rotate the main command dial to choose from the following HDR modes: **OFF** ([Off]), **i** ([On (single photo)]), and **L** ([On (series)]).



- When **i** ([On (single photo)]) or **L** ([On (series)]) is selected, you can adjust HDR strength by holding the **BKT** button and rotating the sub-command dial.



Options for Movie Recording and Editing

Image Area: Choosing a Movie Crop

You can choose an image area using the **[Image area]** > **[Choose image area]** item in the movie shooting menu. Select **[FX]** to shoot movies in what is referred to as “FX-based movie format”, **[DX]** to shoot in “DX-based movie format”. The differences between the two are illustrated below.

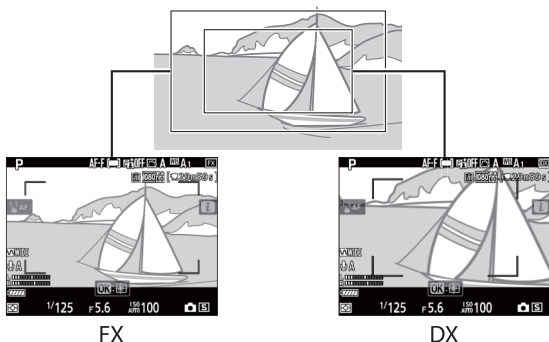





- The sizes of the areas recorded are approximately 35.9 × 20.2 mm (FX-based movie format) and 23.5 × 13.2 mm (DX-based movie format). Movies shot with a DX-format lens and **[On]** selected for **[Image area]** > **[Auto DX crop]** in the movie shooting menu are recorded in DX-based movie format.
- Enabling electronic vibration reduction by selecting **[On]** for **[Electronic VR]** in the movie shooting menu reduces the size of the crop, slightly increasing the apparent focal length.

Frame Size/Frame Rate and Movie Quality

The [**Frame size/frame rate**] item in the movie shooting menu is used to choose the movie frame size (in pixels) and frame rate. You can also choose from two [**Movie quality**] options: [**High quality**] and [**Normal**]. Together, these options determine the maximum bit rate and recording time, as shown in the following table.

Frame size/frame rate ¹		Max. bit rate (Mbps)		Max. recording time
		High quality	Normal	
$\frac{2160}{60} \frac{P}{F}$	[3840 × 2160; 30p] ²	144	— ³	29 min. 59 s ⁶
$\frac{2160}{50} \frac{P}{F}$	[3840 × 2160; 25p] ²			
$\frac{2160}{30} \frac{P}{F}$	[3840 × 2160; 24p] ²			
$\frac{1080}{60} \frac{P}{F}$	[1920 × 1080; 120p] ^{4, 5}			
$\frac{1080}{50} \frac{P}{F}$	[1920 × 1080; 100p] ^{4, 5}			
$\frac{1080}{60} \frac{P}{F} / \frac{1080}{60} \frac{P}{F}$	[1920 × 1080; 60p]	56	28	
$\frac{1080}{50} \frac{P}{F} / \frac{1080}{50} \frac{P}{F}$	[1920 × 1080; 50p]			
$\frac{1080}{30} \frac{P}{F} / \frac{1080}{30} \frac{P}{F}$	[1920 × 1080; 30p]			
$\frac{1080}{30} \frac{P}{F} / \frac{1080}{25} \frac{P}{F}$	[1920 × 1080; 25p]	28	14	
$\frac{1080}{30} \frac{P}{F} / \frac{1080}{24} \frac{P}{F}$	[1920 × 1080; 24p]			

Frame size/frame rate ¹		Max. bit rate (Mbps)		Max. recording time
		High quality	Normal	
	[1920 × 1080; 30p ×4 (slow-motion)] ^{4, 5, 7}	36	— ³	3 min.
	[1920 × 1080; 25p ×4 (slow-motion)] ^{4, 5, 7}			
	[1920 × 1080; 24p ×5 (slow-motion)] ^{4, 5, 7}	29		

- Actual frame rates for values listed as 120p, 60p, 30p, and 24p are respectively 119.88 fps, 59.94 fps, 29.97 fps, and 23.976 fps.
- Record movies in 4K UHD.
- [**Movie quality**] fixed at [**High quality**].
- Image area fixed at [**FX**]; face detection not enabled in [**Auto-area AF**] AF-area mode.
- Movies shot in  or  mode with 1920 × 1080 120p, 1920 × 1080 100p, or 1920 × 1080 slow-motion selected will be recorded at the following frame sizes and rates:
 - [1920 × 1080; 120p] or [1920 × 1080; 30p ×4 (slow-motion)] selected: recorded at [1920 × 1080; 30p]
 - [1920 × 1080; 100p] or [1920 × 1080; 25p ×4 (slow-motion)] selected: recorded at [1920 × 1080; 25p]
 - [1920 × 1080; 24p ×5 (slow-motion)] selected: recorded at [1920 × 1080; 24p]
- Each movie may be recorded across up to 8 files of up to 4 GB each. The number of files and the length of each file vary with the option selected for [**Movie quality**] in the movie shooting menu. Movies recorded to memory cards formatted in the camera will however be recorded as a single file regardless of size if the card has a capacity over 32 GB.
- See “Slow Motion Movies” (□ 266).

Slow-Motion Movies

To record silent slow-motion movies, select [**1920×1080; 30p ×4 (slow-motion)**], [**1920×1080; 25p ×4 (slow-motion)**], or [**1920×1080; 24p ×5 (slow-motion)**] for [**Frame size/frame rate**] in the movie shooting menu. Movies recorded at 4 or 5 times the rated speed are played back at the rated speed for a slow-motion effect. Movies shot at [**1920 × 1080; 30p ×4 (slow-motion)**], for example, are recorded at a frame rate of roughly 120 fps and play back at around 30 fps, meaning that 10 seconds recording produces about 40 seconds of footage.



- Recording and playback speeds are shown below.

Frame size/frame rate	Frame rate*	
	Recorded at	Plays back at
[1920 × 1080; 30p ×4 (slow-motion)]	120p	30p
[1920 × 1080; 25p ×4 (slow-motion)]	100p	25p
[1920 × 1080; 24p ×5 (slow-motion)]	120p	24p

* Actual frame rate is 119.88 fps for values listed as 120p, 29.97 fps for values listed as 30p, and 23.976 fps for values listed as 24p.

✔ **Slow-Motion Movies**

- When a slow-motion option is selected, quality is fixed at “high quality” and the image area is fixed at **[FX]** regardless of the lens used or the option selected for **[Image area]** > **[Choose image area]** in the movie shooting menu (☐ 129).
 - Features such as flicker reduction, electronic vibration reduction, and time code output cannot be used when a “slow-motion” option is selected.
-

Points to Note When Recording Movies

Note the following points when recording movies:

- Depending on memory card write speed, shooting may end before the maximum length (☞ 264) is reached.
- Note that the number of subjects that can be detected in face-detection AF drops during movie recording.
- A  icon indicates that movies cannot be recorded.
- [**Spot metering**] is not available during movie recording.
- Flash lighting cannot be used.

Movie Recording: Shooting Mode

- If the subject is over- or under-exposed in mode **P** or **S**, end live view and start live view again or select mode **A** and adjust aperture.
- The following exposure settings can be adjusted during filming:

Mode	Aperture	Shutter speed	ISO sensitivity²
P, S ¹	—	—	— ³
A	✓	—	— ³
M	✓	✓	✓ ⁴
Other shooting modes	—	—	—

- 1 Exposure for mode **S** is equivalent to mode **P**.
- 2 Regardless of the option chosen for **[ISO sensitivity settings]** > **[Maximum sensitivity]** or for **[ISO sensitivity (mode M)]**, the upper limit when **[On]** is selected for **[Electronic VR]** in the movie shooting menu is ISO 51200.
- 3 The upper limit for ISO sensitivity can be selected using the **[ISO sensitivity settings]** > **[Maximum sensitivity]** item in the movie shooting menu.
- 4 If **[On]** is selected for **[ISO sensitivity settings]** > **[Auto ISO control (mode M)]** in the movie shooting menu, the upper limit for ISO sensitivity can be selected using **[Maximum sensitivity]**.

Adjusting White Balance During Movie Recording

White balance can be adjusted during movie recording by pressing the **?/WB** (WB) button and rotating the main command dial. Options for the selected setting, if any, can be selected by holding the **?/WB** (WB) button and rotating the sub-command dial (☞ 195).

Recording Movies in Mode M

In mode **M** shutter speed can be set to values between $1/25$ s and $1/8000$ s (the slowest available shutter speed varies with the frame rate; ☞ 264).

Wireless Remote Controllers and Remote Cords





If **[Record movies]** is selected for Custom Setting g2 **[Custom controls]** > **[Shutter-release button]**, the shutter-release buttons on optional wireless remote controllers and remote cords can be pressed halfway to start live view or pressed all the way down to start and end movie recording.

Using an External Microphone

The optional ME-1 stereo microphone or ME-W1 wireless microphone can be used to record sound for movies.

Editing Movies

Movies can be edited using the following options:

	Option	Description
	[Choose start/end point]	Create a copy from which unwanted footage has been removed.
	[Save current frame]	Save a selected frame as a JPEG still.
	[Add index]	Add indices to movies during playback. Indices can be used to quickly locate frames during playback and editing (☞ 277).
	[Delete index]	Delete indices from movies (☞ 277).

Trimming Movies



To create trimmed copies of movies:

1 Display a movie full frame (📖 353).

2 Pause the movie on the new opening frame.

Play the movie back as described in “Viewing Movies” (📖 53), pressing **OK** to start and resume playback and **⏸** to pause and pressing **⏪** or **⏩** or rotating the main command dial to locate the desired frame. Your approximate position in the movie can be ascertained from the movie progress bar. Pause playback when you reach the new opening frame.



3 Select [Choose start/end point].

Press the **i** button, then highlight [Choose start/end point] and press .

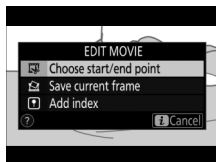

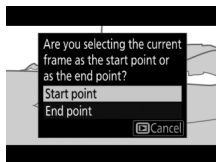

4 Choose the start point.

To create a copy that begins from the current frame, highlight [Start point] and press **OK**. The frames before the current frame will be removed when you save the copy in Step 10.





5 Confirm the new start point.

If the desired frame is not currently displayed, press  or  to advance or rewind (to skip to 10 s ahead or back, rotate the main command dial; to skip to the first or last frame, rotate the sub-command dial).



6 Choose the end point.

Press  (WB) to switch from the start point () to the end point () selection tool and then select the closing frame as described in Step 5. The frames after the selected frame will be removed when you save the copy in Step 10.

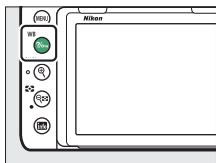

7 Create the copy.

Once the desired closing frame is displayed, press .

8 Preview the movie.

To preview the copy, highlight [**Preview**] and press **OK** (to interrupt the preview and return to the save options menu, press **ESC**). To abandon the current copy and select a new start point or end point as described above, highlight [**Cancel**] and press **OK**; to save the copy, proceed to Step 9.

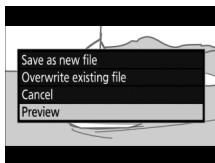

9 Choose a save option.

- [**Save as new file**]: Save the edited copy to a new file.
- [**Overwrite existing file**]: Replace the original movie with the edited copy.

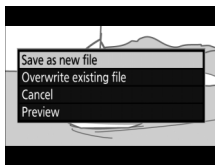

10 Save the copy.

Press **OK** to save the copy.

✓ **Trimming Movies**

- Movies must be at least two seconds long. The copy will not be saved if there is insufficient space available on the memory card.
 - Copies have the same time and date of creation as the original.
-

✓ **Removing Opening or Closing Footage**

To remove only the opening footage from the movie, proceed to Step 7 without pressing the **?/On (WB)** button in Step 6. To remove only the closing footage, select **[End point]** in Step 4, select the closing frame, and proceed to Step 7 without pressing the **?/On (WB)** button in Step 6.

✓ **The Retouch Menu [Trim Movie] Option**

Movies can also be edited using the **[Trim movie]** item in the retouch menu.

Saving Selected Frames

To save a copy of a selected frame as a JPEG still:

1 Pause the movie on the desired frame.

Play the movie back as described in “Viewing Movies” (📖 53), pressing **OK** to start and resume playback and **⏸** to pause. Pause the movie at the frame you intend to copy.

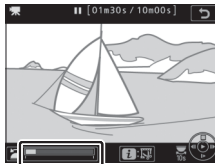

2 Choose [Save current frame].

Press the **i** button, then highlight **[Save current frame]** and press **OK** to create a JPEG copy of the current frame. The image will be recorded at the dimensions selected for **[Frame size/frame rate]** in the movie shooting menu.

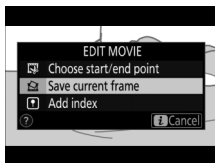



Save Current Frame

JPEG movie stills created using **[Save current frame]** cannot be retouched. JPEG movie stills lack some categories of photo information (📖 366).



Adding Indices to Movies

1 Pause playback on the desired frame.

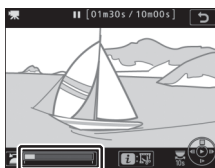
- Press  to pause playback.
- Press  or  to locate the desired frame.



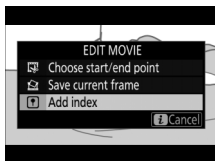

2 Select [Add index].

- Press the  button, highlight [Add index], and press  to add an index.
- Up to 20 indices can be added to each movie.



Deleting Indices

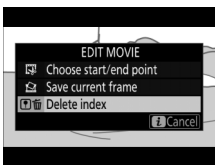

After rotating the sub-command dial to skip to the desired index, either while playback is in progress or while playback is paused, press the  button to display a menu. The selected index can then be deleted by highlighting [Delete index] and pressing .







Other Shooting Options

Using Two Memory Cards

To choose the role played by the memory card in Slot 2 when two memory cards are inserted, press the **MENU** button and select **[Role played by card in Slot 2]** in the photo shooting menu.

Option		Description
	[Overflow]	The card in Slot 2 is used only when the card in Slot 1 is full.
	[Backup]	Each picture is recorded twice, once to the card in Slot 1 and again to the card in Slot 2.
	[RAW Slot 1 - JPEG Slot 2]	<ul style="list-style-type: none">• The NEF (RAW) copies of photos taken at settings of NEF (RAW) + JPEG are recorded only to the card in Slot 1, the JPEG copies only to the card in Slot 2.• Pictures taken at other image quality settings are recorded twice at the same setting, once to the card in Slot 1 and again to the card in Slot 2.

✓ [RAW Slot 1 - JPEG Slot 2]

- If [On] is selected for [Multiple exposure] > [Save individual images (NEF)] in the photo shooting menu, or if [On] is selected for [HDR (high dynamic range)] > [Save individual images (NEF)] in the photo shooting menu, unprocessed copies of the individual NEF (RAW) photos that make up each multiple exposure or HDR image will be recorded to both memory cards together with the JPEG composite, regardless of the option selected for image quality.
- If [On] is selected for Custom Setting d8 [Save original (EFFECTS)], unprocessed NEF (RAW) copies of pictures taken in VI, POP, , , , and  modes will be saved to both memory cards together with the final JPEG picture, regardless of the option selected for image quality.

✓ [Backup] and [RAW Slot 1 - JPEG Slot 2]



- The control panel and viewfinder show the number of exposures remaining on the card with the least amount of space available.
- Shutter release will be disabled when either card is full.

✓ Recording Movies

When two memory cards are inserted in the camera, the slot used to record movies can be selected using the [Destination] item in the movie shooting menu.



Deleting Copies

When deleting pictures recorded using [**Backup**] or [**RAW Slot 1 - JPEG Slot 2**], you have the choice of erasing either both copies or only the copy on the card in the current slot.

- Pressing  (FORMAT) when picture created using either of these options is highlighted during playback displays a confirmation message.
- To delete only the copy on the card in the current slot, highlight [**Selected image**] and press  (FORMAT) again. The copy on the remaining card is not deleted.
- To delete both copies, highlight [**Same images on [1] and [2]**] and press  (FORMAT).



Two-Button Reset: Restoring Default Settings

The camera settings listed below can be restored to default values by holding the  () and  buttons down together for more than two seconds (these buttons are marked by a green dot). The control panel turns off briefly while settings are reset.

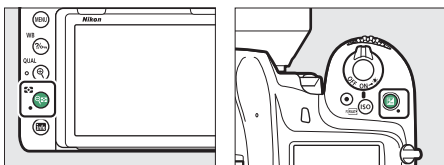

Settings Accessible from the Photo Shooting Menu

Option		Default
Image quality		JPEG normal
Image size		Large
ISO sensitivity settings		
ISO sensitivity	P, S, A, M	100
	Other modes	Auto
Auto ISO sensitivity control		On





Option	Default
White balance	Auto > Keep overall atmosphere
Fine tuning	A-B: 0, G-M: 0
Set Picture Control	Auto
Active D-Lighting	Off
Flicker reduction	
Flicker reduction setting	Disable
Flicker reduction indicator	On
Auto bracketing	Off ¹
Multiple exposure	Off ²
HDR (high dynamic range)	Off ³
Silent live view photography	Off



















- 1 Number of shots is reset to zero. Bracketing increment is reset to 1 EV (exposure/flash bracketing) or 1 (white balance bracketing). **[Auto]** is selected for the second shot of two-shot ADL bracketing programs.
- 2 If multiple exposure is currently in progress, shooting will end and multiple exposure will be created from exposures recorded to that point. If **[On (series)]** or **[On (single photo)]** is selected, the multiple exposure mode will be reset to **[Off]**. **[Overlay mode]**, **[Number of shots]**, and **[Save individual images (NEF)]** are not reset.
- 3 **[On (series)]** or **[On (single photo)]** will be reset to **[Off]**. **[HDR strength]** and **[Save individual images (NEF)]** are not reset.

Settings Accessible from the Movie Shooting Menu

Option	Default
ISO sensitivity settings	
Maximum sensitivity	51200
Auto ISO control (mode M)	On
ISO sensitivity (mode M)	100
White balance	Same as photo settings
Set Picture Control	Same as photo settings
Active D-Lighting	Off
Electronic VR	Off
Headphone volume	15

Other Settings

Option		Default
Focus point *		Center
Flexible program		Off
Exposure compensation		Off
AE lock hold		Off
AF-area mode	Viewfinder photography	 Single-point AF
		 Auto-area AF
	Live view photography	 Single-point AF
		 Auto-area AF

Option			Default	
Autofocus mode	Still photography	Viewfinder photography	AUTO, VI, POP,  ,  ,  P, S, A, M	AF-A
				AF-S
		Live view photography	AUTO,  , VI, POP,  ,  ,  P, S, A, M	AF-A
			 , 	AF-S
	Movie recording	 , VI, POP,  ,   , 	AF-S	
			 , 	AF-C
		 , P, S, A, M	AF-F	
	Metering			Matrix metering
Flash mode			Fill flash	
Flash compensation			Off	
FV lock			Off	
Multi-selector power aperture			Disable	
Multi selector exposure comp.			Disable	
Exposure delay mode			Off	
Exposure preview (Lv)			Off	
Highlight display			Off	



* Focus point not displayed if [Auto-area AF] is selected for AF-area mode.

Combining Multiple Exposures in a Single Photo (Multiple Exposure)

Use the [**Multiple exposure**] item in the photo shooting menu to record two to ten NEF (RAW) exposures as a single photograph.

Multiple Exposure Options

Option	Description
[Multiple exposure mode]	<ul style="list-style-type: none">• [On (series)]: Take a series of multiple exposures. Select [Off] to resume normal shooting.• [On (single photo)]: Take one multiple exposure.• [Off]: Exit without creating additional multiple exposures.
[Number of shots]	Choose the number of exposures that will be combined to form a single photograph.

Option	Description
<p data-bbox="135 358 239 413">[Overlay mode]</p>	<ul data-bbox="283 103 912 365" style="list-style-type: none"> <li data-bbox="283 103 778 161">• [Add]: The exposures are overlaid without modification; gain is not adjusted. <li data-bbox="283 168 912 299">• [Average]: Before the exposures are overlaid, the gain for each is divided by the total number of exposures taken (gain for each exposure is set to $1/2$ for 2 exposures, $1/3$ for 3 exposures, etc). <li data-bbox="283 307 871 365">• [Lighten]: The camera compares the pixels in each exposure and uses only the brightest. <div data-bbox="319 369 891 486">  </div> <ul data-bbox="283 493 866 551" style="list-style-type: none"> <li data-bbox="283 493 866 551">• [Darken]: The camera compares the pixels in each exposure and uses only the darkest. <div data-bbox="319 556 907 672">  </div>
<p data-bbox="125 700 249 824">[Save individual images (NEF)]</p>	<ul data-bbox="283 685 891 838" style="list-style-type: none"> <li data-bbox="283 685 891 773">• [On]: Save both the multiple exposure and the shots that make it up; the pictures are saved in NEF (RAW) format. <li data-bbox="283 780 881 838">• [Off]: Discard the individual shots and save only the multiple exposure.

Option	Description
[Overlay shooting]	<ul style="list-style-type: none"> • [On]: Earlier exposures are superimposed on the view through the lens during live view photography. The earlier exposures aid composition of the next shot. • [Off]: Earlier exposures are not displayed while shooting is in progress.
[Select first exposure (NEF)]	Choose the first exposure from the NEF (RAW) images on the memory card.



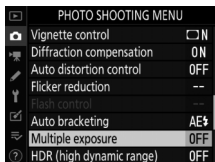

Creating a Multiple Exposure

1 Select [Multiple exposure].

Highlight [Multiple exposure] in the photo shooting menu and press .





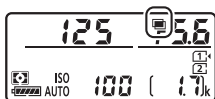
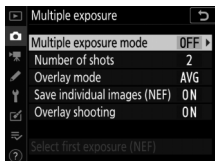

2 Select a mode.

- Highlight [Multiple exposure mode] and press , then press  or  to choose the desired mode and press .
- If [On (series)] or [On (single photo)] is selected, a  icon will be displayed in the control panel.





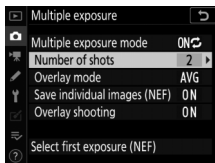

3 Choose the number of shots.

- Highlight [Number of shots] and press .
- Press  or  to choose the number of exposures that will be combined to form a single photograph and press .





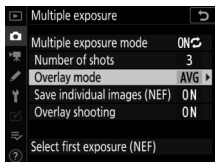

4 Choose the overlay mode.

Highlight [**Overlay mode**] and press , then press  or  to choose the desired mode and press  to select.





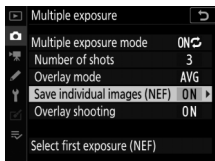

5 Choose whether to keep individual exposures.

- Highlight [**Save individual images (NEF)**] and press .
- Highlight an option using  or  and press .
- To save both the multiple exposure and the shots that make it up, select [**On**]; the individual shots are saved in NEF (RAW) format. To save only the multiple exposure, select [**Off**].



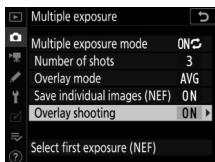

6 Choose whether to view progress in the display.

To choose whether earlier exposures are superimposed over the view through the lens as shooting progresses (live view only), highlight [**Overlay shooting**] and press , then press  or  to choose the desired option and press  to select.



7 Choose the first exposure.

- To choose the first exposure from existing NEF (RAW) photos, highlight [**Select first exposure (NEF)**] and press .
- Use the multi selector to highlight the desired picture.
- To view the highlighted picture full screen, press and hold the  (**QUAL**) button.
- After choosing the desired picture, press .
- If the NEF (RAW) image selected for the first exposure was recorded at an ISO sensitivity of Hi 0.3 to Hi 2, the electronic front-curtain shutter will not be used during the multiple exposure even if [**Enable**] is selected for Custom Setting d5 [**Electronic front-curtain shutter**].



8 Frame a photograph, focus, and shoot.



- The  icon starts to flash when the first shot is taken.
- Take the selected number of shots. If you chose an existing NEF (RAW) image as the first exposure using [**Select first exposure (NEF)**] in Step 7, shooting will start from the second exposure.



- The number of exposures remaining in the current multiple exposure can be displayed by pressing the shutter-release button halfway between shots.



- In [**On (single photo)**] mode, the  icon clears from the display and multiple exposure shooting ends automatically when the multiple exposure is complete.

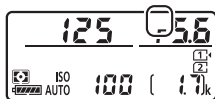

- In [**On (series)**] mode, multiple exposure shooting continues until you select [**Off**] for [**Multiple exposure mode**].

✓ NEF (RAW)

Multiple exposures shot with an NEF (RAW) or NEF (RAW) + JPEG option selected for image quality will be recorded in JPEG format.

✓ Multiple Exposure

- If the monitor turns off during playback or menu operations and no operations are performed for about 30 s, shooting will end and a multiple exposure will be created from the exposures that have been recorded to that point. The time available to record the next exposure can be extended by choosing longer times for Custom Setting c2 [**Standby timer**].
 - Multiple exposures may be affected by noise (randomly-spaced bright pixels, fog, or lines).
 - In continuous shooting modes, the camera records all exposures in a single burst. If [**On (single photo)**] is selected, multiple exposure shooting will end after the first multiple exposure is recorded. If [**On (series)**] is selected, an additional multiple exposure will be recorded each time the shutter-release button is pressed.
 - In self-timer mode (□ 183), the camera will automatically record the number of exposures selected in Step 3, regardless of the option selected for Custom Setting c3 [**Self-timer**] > [**Number of shots**]; the interval between shots is however controlled by Custom Setting c3 [**Self-timer**] > [**Interval between shots**].
 - The shooting settings and photo info for multiple exposure photographs are those for the first exposure.
 - Do not remove or replace the memory card while recording a multiple exposure.
 - While a multiple exposure is being shot, memory cards cannot be formatted and some menu items are grayed out and cannot be changed.
-

The BKT Button

If **[Multiple exposure]** is selected for Custom Setting f3 **[Custom controls] > [BKT button]**, you can select an option for **[Multiple exposure mode]** by pressing the **BKT** button and rotating the main command dial and a value for **[Number of shots]** by pressing the **BKT** button and rotating the sub-command dial.

- Press the **BKT** button and rotate the main command dial to choose from **OFF** (**[Off]**), **i** (**[On (single photo)]**), and **L** (**[On (series)]**).



- Press the **BKT** button and rotate the sub-command dial to choose the number of shots.

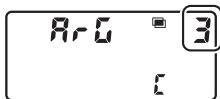



Multiple Exposure: Restrictions



Multiple exposure cannot be combined with some camera features, including:

- Modes other than **P**, **S**, **A**, and **M**
 - Movie recording
 - Bracketing
 - HDR (high dynamic range)
 - Interval-timer photography
 - Time-lapse movies
 - Focus shift
 - The negative digitizer
-

Using the **i** Button

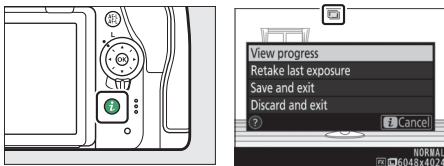

Pictures can be viewed by pressing the  button while a multiple exposure is in progress. The most recent shot in the current multiple exposure is indicated by a  icon; pressing the **i** button when this icon is present displays the multiple exposure **i** menu.



- Use the touch screen or navigate the menu using the multi selector, pressing  or  to highlight items and pressing  to select.

Option	Description
[View progress]	View a preview created from the exposures recorded to the current point.
[Retake last exposure]	Retake the most recent exposure.
[Save and exit]	Create a multiple exposure from the exposures taken to current point.
[Discard and exit]	Exit without recording a multiple exposure. If [On] is selected for [Save individual images (NEF)], the individual exposures will be kept.

Ending Multiple Exposures

To end a multiple exposure before the specified number of exposures have been taken, select [**Off**] for multiple exposure mode or press the  button followed by the  button and select either [**Save and exit**] or [**Discard and**

exit]. If shooting ends or you select [**Save and exit**] before the specified number of exposures have been taken, a multiple exposure will be created from the exposures that have been recorded to that point. If [**Average**] is selected for [**Overlay mode**], gain will be adjusted to reflect the number of exposures actually recorded. Note that shooting will end automatically if:

- A two-button reset is performed
- The camera is turned off
- The battery is exhausted

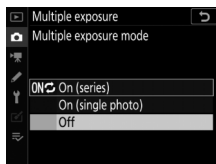

Taking Photos at a Set Interval (Interval Timer Shooting)

Use the **[Interval timer shooting]** item in the photo shooting menu to take photographs at a selected interval until a specified number of shots has been recorded. Select a release mode other than  and **MUP** when using the interval timer.

Interval Timer Shooting Options

Option	Description
[Start]	Start interval-timer photography, either after 3 s ([Now] selected for [Choose start day/time]) or at a selected date and time [Choose day/time] . Shooting will continue at the selected interval until all shots have been taken.
[Choose start day/time]	Choose a start option. To start shooting immediately, select [Now] . To start shooting at a chosen date and time, select [Choose day/time] .
[Interval]	Choose the interval (hours, minutes, and seconds) between shots.
[Intervals× shots/interval]	Choose the number of intervals and the number of shots per interval.

Option	Description
<p>[Exposure smoothing]</p>	<p>Selecting [On] allows the camera to adjust exposure to match the previous shot.</p> <ul style="list-style-type: none"> • Large changes in subject brightness during shooting may result in apparent variations in exposure. This can be addressed by shortening the interval between shots. • Exposure smoothing will not take effect in mode M if [Off] is selected for [ISO sensitivity settings] > [Auto ISO sensitivity control] in the photo shooting menu.
<p>[Silent photography]</p>	<p>Select [On] to silence the shutter and eliminate the vibrations it produces during shooting.</p> <ul style="list-style-type: none"> • Selecting [On] does not completely silence the camera. Camera sounds may still be audible, for example during autofocus or aperture adjustment, in the latter case most noticeably at apertures smaller (i.e., at f-numbers higher) than f/5.6.

Option	Description
[Interval priority]	<ul style="list-style-type: none"> • [On]: Select [On] to ensure that frames shot in modes P and A are taken at the chosen interval. <ul style="list-style-type: none"> - Flash photography is disabled. - The number of shots is set to 1, even if the number of shots chosen for [Intervalsxshots/interval] is 2 or more. - If AF-S is selected for autofocus mode, or if AF-A is selected and photographs are being taken using AF-S, select [Release] for Custom Setting a2 [AF-S priority selection]. If AF-C is selected, or if AF-A is selected and photographs are being taken using AF-C, select [Release] for Custom Setting a1 [AF-C priority selection]. - If [On] is selected for [ISO sensitivity settings] > [Auto ISO sensitivity control] and the time chosen for [Minimum shutter speed] is longer than the interval, the time selected for the interval will take priority over the selected shutter speed. • [Off]: Select [Off] to ensure that photos are correctly exposed.
[Focus before each shot]	If [On] is selected, the camera will focus before each shot after the first.

Option	Description
[Options]	<p>Combine interval-timer photography with other options.</p> <ul style="list-style-type: none"> • [AE bracketing]: Perform exposure bracketing during interval-timer photography. • [Time-lapse movie]: Use the photos taken during interval-timer photography to create a time-lapse movie with an aspect ratio of 16:9. The camera saves both the photos and the time-lapse movie. <ul style="list-style-type: none"> - Selecting [1:1 (24×24)] for [Image area] > [Choose image area] in the photo shooting menu disables the shutter release. - Movies created using [Time-lapse movie] are recorded in the [sRGB] color space, regardless of the option selected for [Color space] in the photo shooting menu. • [Off]: Do not perform additional operations during interval-timer photography.
[Starting storage folder]	<p>Highlight either of the following options and press  to select or deselect:</p> <ul style="list-style-type: none"> • [New folder]: A new folder is created for each new sequence. • [Reset file numbering]: File numbering is reset to 0001 whenever a new folder is created.

✔ Before Shooting

- Before beginning interval-timer photography, take a test shot at current settings.
 - Select [**Time zone and date**] in the setup menu and make sure that the camera clock is set to the correct time and date.
 - We recommend using a tripod and disabling lens vibration reduction (VR). Mount the camera on a tripod before shooting begins.
 - To ensure that shooting is not interrupted, be sure the camera battery is fully charged. If in doubt, charge the battery before use or use an AC adapter and power connector (available separately).
 - When taking photos with your eye from the viewfinder and [**Off**] selected for [**Silent photography**], remove the rubber eyecup and cover the viewfinder with the supplied eyepiece cap to prevent light entering via the viewfinder interfering with photographs and exposure (📖 10).
-

Interval-Timer Photography

- 1 Highlight [Interval timer shooting] in the photo shooting menu and press .



2 Adjust interval timer settings.

Adjust interval timer settings as described below.

- To choose a start day and time:

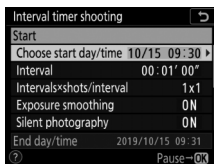

Highlight [**Choose start day/time**] and press .

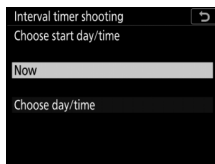

Highlight an option and press .

- To start shooting immediately, select [**Now**]. To start shooting at a chosen date and time, select [**Choose day/time**], then choose the date and time and press .

• To choose the interval between shots:

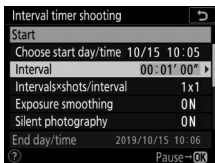

Highlight [**Interval**] and press

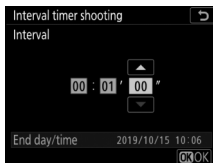

Choose an interval (hours, minutes, and seconds) and press

• To choose the number of shots per interval:

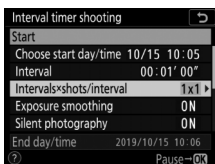

Highlight [**Intervalsxshots/interval**] and press

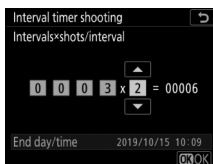

Choose the number of intervals and the number of shots per interval and press

- In **S** (single frame) mode, the photographs for each interval will be taken at the rate for **CH** release mode.
- When [**Off**] is selected for [**Silent photography**], the maximum number of intervals will vary with the number of shots per interval.

- **To enable or disable exposure smoothing:**

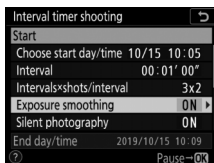

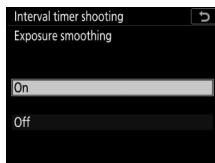

Highlight [**Exposure smoothing**] and press .



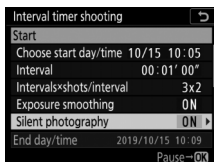

Highlight an option and press .

- **To enable or disable silent photography:**

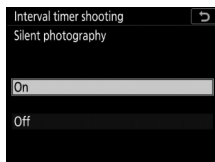

Highlight [**Silent photography**] and press .



Highlight an option and press .

- If [**On**] is selected, the only time the sound of the shutter or mirror will be heard is when the mirror is raised or lowered at the start and end of shooting.

- **To choose an interval priority option:**

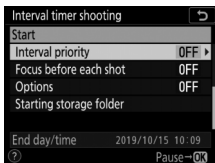

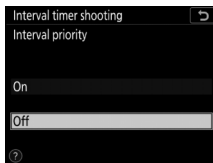

Highlight [**Interval priority**] and press .



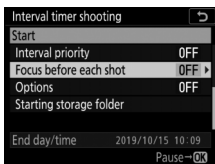

Highlight an option and press .

- **Choose whether the camera focuses before each shot after the first:**

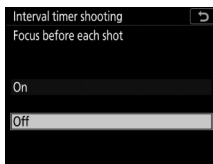

Highlight [**Focus before each shot**] and press .



Highlight an option and press .

• To choose additional options:

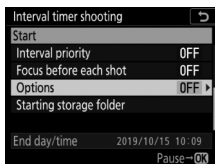

Highlight [**Options**] and press

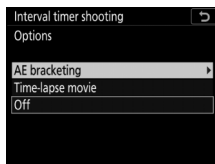

Highlight [**AE bracketing**] or [**Time-lapse movie**] and press

- Choose the [**Number of shots**] and [**Increment**] ([**AE bracketing**]) or the [**Frame size/frame rate**] and [**Destination**] ([**Time-lapse movie**]).

• Choosing start folder options:



Highlight [**Starting storage folder**] and press

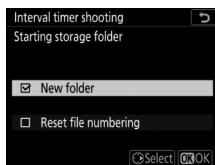

Highlight options and press to select or deselect. Press to proceed.

3 Start shooting.

Highlight [**Start**] and press \odot . The first series of shots will be taken at the specified starting time, or after about 3 s if [**Now**] was selected for [**Choose start day/time**] in Step 2.

Shooting will continue at the selected interval until all shots have been taken.

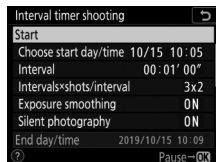

✓ Interval-Timer Photography

- Choose an interval longer than the time needed to take the selected number of shots at the predicted shutter speed. Note that during actual interval-timer photography, the camera must not only take shots at the selected interval but must also have sufficient time to complete the exposures and perform such tasks as processing the photographs. If the interval is too short to take the selected number of photos, the camera may skip to the next interval without shooting.
- If the interval is too short, the total number of shots taken may be less than that selected for **[Intervalsxshots/interval]**.
- If you are using a flash, choose an interval longer than the time needed for the flash to charge. If the interval is too short, the flash may fire at less than the power needed for full exposure.
- If shooting cannot proceed at current settings—for example, if shutter speed is set to **B** (Bulb) or **-** (Time), the interval is **[00:00'00"]**, or the start time is in less than a minute—a warning will be displayed in the monitor.
- If **[On]** is selected for **[Silent photography]** or **[Time-lapse movie]** is selected for **[Options]**, the standby timer will not expire during interval-timer photography, regardless of the option selected for Custom Setting c2 **[Standby timer]**.
- If the memory card is full, the interval timer will remain active but no pictures will be taken. Insert another memory card and resume shooting (☞ 312).

- Interval-timer photography will pause if:
 - The camera is turned off and then on again (when the camera is off, batteries and memory cards can be replaced without ending interval-timer photography)
 -  or **MUP** is selected for release mode
- Changing camera settings while the interval timer is active may cause shooting to end.

Release Mode

Regardless of the release mode selected, the camera will take the specified number of shots at each interval.

Adjusting Settings Between Shots

Pictures can be viewed and shooting and menu settings adjusted between shots. Note, however, that the monitor will turn off approximately 2 s before the next shot is taken.

Interval-Timer Photography: Restrictions

Interval-timer photography cannot be combined with some camera features, including:

- Live view
- Movie recording
- Long time-exposures (bulb or time photography)
- The self-timer
- Bracketing
- Multiple exposure
- HDR (high dynamic range)
- Focus shift
- The negative digitizer

✓ When [On] Is Selected for [Silent Photography]

Selecting [On] for [Silent photography] disables some camera features, including:

- ISO sensitivities of Hi 0.3 through Hi 2
- Flash photography
- Exposure delay mode
- Long exposure noise reduction
- Flicker reduction

✓ Interval Timer Settings

Turning the camera off or selecting a new release mode does not affect interval-timer photography settings.

✓ During Shooting

During interval-timer photography, the memory card access lamp will flash. Immediately before the next shooting interval begins, the shutter speed display will show the number of intervals remaining, and the aperture display will show the number of shots remaining in the current interval.

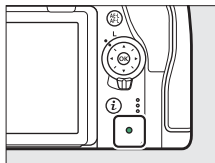

- Between shots, the number of intervals remaining and the number of shots in each interval can be viewed by pressing the shutter-release button halfway.
 - If [Time-lapse movie] is selected for [Options], the memory card access lamp will remain lit during interval-timer photography.
-

Pausing Interval-Timer Photography

Interval-timer photography can be paused between intervals by pressing **OK** or by selecting [**Interval timer shooting**] in the photo shooting menu, highlighting [**Pause**], and pressing **OK**. Note that the menus may not be displayed when the **MENU** button is pressed if the time selected for [**Interval**] is very short.

- If [**Time-lapse movie**] is selected for [**Options**], pressing **OK** between intervals will end interval-timer photography.

Resuming Interval-Timer Photography

Shooting can be resumed using the **[Interval timer shooting]** item in the photo shooting menu. The procedure is as follows:

To resume shooting immediately:

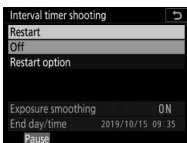

Highlight **[Restart]** and press **OK**.

To resume shooting at a specified time:

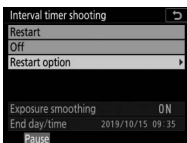

For **[Restart option]**, highlight **[Choose day/time]** and press

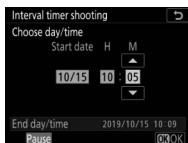

Choose a starting date and time and press **OK**.

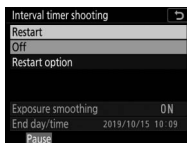

Highlight **[Restart]** and press **OK**.

Ending Interval-Timer Photography

To end interval-timer photography before all the photos are taken, select [**Off**] for [**Interval timer shooting**]. Note that the menus may not be displayed when the MENU button is pressed if the time selected for [**Interval**] is very short. In this case you will need to press \odot to pause interval-timer photography and then select [**Interval timer shooting**] in the photo shooting menu, highlight [**Off**], and press \odot .

Creating a Movie from Photos (Time-Lapse Movie)

Use the [**Time-lapse movie**] item in the photo shooting menu to create silent time-lapse movies from photos taken automatically at a selected interval.

Time-Lapse Movie Options

Option	Description
[Start]	Start time-lapse recording. Shooting starts after about 3 s and continues at the selected interval for the selected shooting time.
[Interval]	Choose the interval between shots in minutes and seconds.
[Shooting time]	Choose how long the camera will continue to take pictures (hours and minutes).
[Exposure smoothing]	Selecting [On] smooths abrupt changes in exposure in modes other than M (note that exposure smoothing only takes effect in mode M if auto ISO sensitivity control is on). Large changes in subject brightness during shooting may result in apparent variations in exposure, in which case it may be necessary to shorten the interval between shots.

Option	Description
[Silent photography]	Select [On] to silence the shutter and eliminate the vibrations it produces during shooting. <ul style="list-style-type: none"> • Selecting [On] does not completely silence the camera. Camera sounds may still be audible, for example during autofocus or aperture adjustment, in the latter case most noticeably at apertures smaller (i.e., at f-numbers higher) than f/5.6.
[Image area]	<ul style="list-style-type: none"> • [Choose image area]: Choose the image area for time-lapse movies from [FX] and [DX]. • [Auto DX crop]: If [On] is selected, the camera will automatically choose the [DX] crop when a DX lens is attached.
[Frame size/ frame rate]	Choose the frame size and rate for the final movie.

Option	Description
[Interval priority]	<ul style="list-style-type: none"> • [On]: Select [On] to ensure that frames shot in modes P and A are taken at the chosen interval. <ul style="list-style-type: none"> - If AF-S is selected for autofocus mode, or if AF-A is selected and photographs are being taken using AF-S, select [Release] for Custom Setting a2 [AF-S priority selection]. If AF-C is selected, or if AF-A is selected and photographs are being taken using AF-C, select [Release] for Custom Setting a1 [AF-C priority selection]. - If [On] is selected for [ISO sensitivity settings] > [Auto ISO sensitivity control] and the time chosen for [Minimum shutter speed] is longer than the interval, the time selected for the interval will take priority over the selected shutter speed. • [Off]: Select [Off] to ensure that photos are correctly exposed.
[Focus before each shot]	If [On] is selected, the camera will focus before each shot after the first.
[Destination]	Choose the slot used to record time-lapse movies when two memory cards are inserted.

Recording Time-Lapse Movies

✔ Before Shooting

- Choose a mode other than **EFCT**.
- Before shooting a time-lapse movie, take a test shot at current settings and view the results.
- Time-lapse movies are shot using the movie crop.
- Select [**Time zone and date**] in the setup menu and make sure that the camera clock is set to the correct time and date.
- We recommend using a tripod and disabling lens vibration reduction (VR). Mount the camera on a tripod before shooting begins.
- To ensure that shooting is not interrupted, use an optional AC adapter and power connector or a fully-charged battery.
- When taking photos with your eye from the viewfinder and [**Off**] selected for [**Silent photography**], remove the rubber eyecup and cover the viewfinder with the supplied eyepiece cap to prevent light entering via the viewfinder interfering with photographs and exposure (📖 10).

1 Highlight [Time-lapse movie] in the photo shooting menu and press .

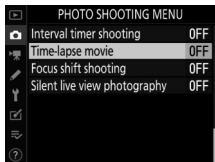

2 Adjust time-lapse movie settings.

Adjust time-lapse movie settings as described below.

- **To choose the interval between frames:**

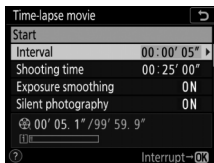

Highlight [**Interval**] and press .

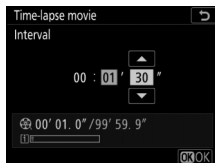

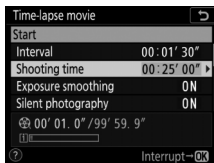

Choose an interval longer than the slowest anticipated shutter speed (minutes and seconds) and press .

- **To choose the total shooting time:**

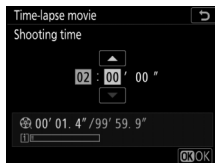

Highlight [**Shooting time**] and press .



Choose shooting time (up to 7 hours 59 minutes) and press .

- **To enable or disable exposure smoothing:**

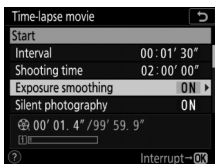

Highlight [**Exposure smoothing**] and press **OK**.

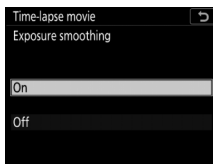

Highlight an option and press **OK**.

- Select [**On**] to smooth changes in exposure for natural-looking footage.

- **To enable or disable silent photography:**

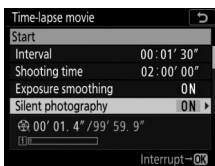

Highlight [**Silent photography**] and press **OK**.



Highlight an option and press **OK**.

- If [**On**] is selected, the only time the sound of the shutter or mirror will be heard is when the mirror is raised or lowered at the start and end of shooting.

• **To choose the image area:**

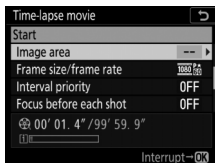

Highlight [**Image area**] and press \odot .

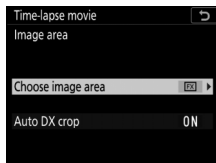

Highlight [**Choose image area**] or [**Auto DX crop**] and press \odot .

- If you selected [**Choose image area**], choose [**FX**] or [**DX**]; if you selected [**Auto DX crop**], highlight [**On**] or [**Off**] and press \odot .

• **To choose the frame size and rate:**

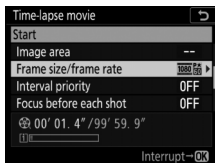

Highlight [**Frame size/frame rate**] and press \odot .



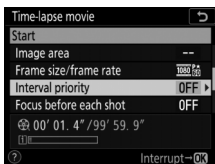

Highlight an option and press \odot .

- **To choose an interval priority option:**



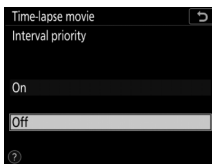

Highlight [**Interval priority**] and press .



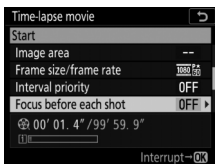

Highlight an option and press .

- **Choose whether the camera focuses before each shot after the first:**

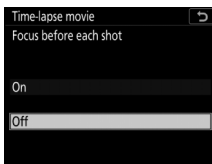

Highlight [**Focus before each shot**] and press .



Highlight an option and press .

- If [**On**] is selected for [**Focus before each shot**], the camera will focus before each shot according to the option currently selected for autofocus mode.

• **Choose a destination:**

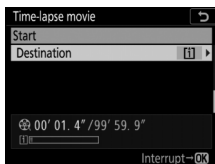

Highlight [**Destination**] and press .

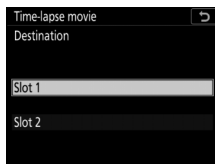

Highlight the slot that will be used to record time-lapse movies when two memory cards are inserted and press .

3 Highlight [**Start**] and press .

- Shooting starts after about 3 s.
- The camera takes photographs at the [**Interval**] and for the [**Shooting time**] selected in Step 2.

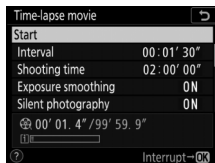

Ending Shooting

To end shooting before all the photos are taken, press **OK** or select [**Time-lapse movie**] in the photo shooting menu, highlight [**Off**], and press **OK**. Note that the menu may not be displayed when the **MENU** button is pressed if the time selected for [**Interval**] is very short.

- A movie will be created from the frames shot to the point where shooting ended and normal photography will resume.

Calculating the Length of the Final Movie

The total number of frames in the final movie can be calculated by dividing the shooting time by the interval, rounding up, and adding 1. The length of the final movie can then be calculated by dividing the number of shots by the frame rate selected for [**Frame size/frame rate**]. A 48-frame movie recorded at 1920 × 1080; 24p, for example, will be about two seconds long. The maximum length for time-lapse movies is 20 minutes.

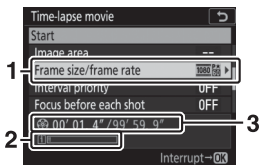



- 1 Frame size/frame rate
- 2 Memory card indicator
- 3 Length recorded/maximum length

Image Review

The **Review** button cannot be used to view pictures while shooting is in progress, but the current frame will be displayed for a few seconds after each shot if [**On**] is selected for [**Image review**] in the playback menu (the frame may not be displayed if the interval is very short). Other playback operations cannot be performed while the frame is displayed.

✔ Time-Lapse Movies

- Sound is not recorded with time-lapse movies.
- The shutter speed and the time needed to record the image to the memory card may vary from shot to shot. As a result, the interval between a shot being recorded and the start of the next shot may vary.
- Shooting will not begin if a time-lapse movie cannot be recorded at current settings, for example if:
 - The value selected for **[Interval]** is longer than that selected for **[Shooting time]**
 - **[00:00'00"]** is selected for **[Interval]** or **[Shooting time]**
 - The memory card is full
- The  button cannot be used to view pictures while time-lapse recording is in progress.
- For consistent coloration, choose a white balance setting other than  **A** (**[Auto]**) or  **A** (**[Natural light auto]**) when recording time-lapse movies.
- Regardless of the option selected for Custom Setting c2 **[Standby timer]**, the standby timer will not expire while recording is in progress.
- Shooting may end if camera controls are used or settings are changed or HDMI cable is connected. A movie will be created from the frames shot to the point where shooting ended.
- The following end shooting without a beep sounding or a movie being recorded:
 - Disconnecting the power source
 - Ejecting the memory card

✓ **During Shooting**

- During shooting, the memory card access lamp will light and a time-lapse recording indicator will be displayed in the control panel. The time remaining (in hours and minutes) appears in the control panel shutter-speed display immediately before each frame is recorded.
- At other times, the time remaining can be viewed by pressing the shutter-release button halfway.



✓ **Adjusting Settings Between Shots**

Shooting and menu settings can be adjusted between shots. Note, however, that the monitor will turn off approximately 2 s before the next shot is taken.

✓ **Time-Lapse Movies: Restrictions**

Time-lapse movie recording cannot be combined with some camera features, including:

- **EFCT** mode
- Live view photography
- Movie recording
- Long time-exposures (bulb or time photography)
- The self-timer
- Bracketing
- Multiple exposure
- HDR (high dynamic range)
- Interval-timer photography
- Focus shift
- The negative digitizer

✔ **When [On] Is Selected for [Silent Photography]**

Selecting **[On]** for **[Silent photography]** disables some camera features, including:

- ISO sensitivities of Hi 0.3 through Hi 2
 - Flash photography
 - Exposure delay mode
 - Long exposure noise reduction
 - Flicker reduction
-

Varying Focus over a Series of Photos (Focus Shift Shooting)



Use the [**Focus shift shooting**] item in the photo shooting menu to vary focus automatically over a series of photographs. This feature can be used to take photos that can later be copied to a computer and combined using third-party focus-stacking software.

Focus Shift Shooting Options

Option	Description
[Start]	Start shooting. Shooting will take the selected number of shots, changing the focus distance by the selected amount with each shot.
[No. of shots]	Choose the number of shots (maximum 300).
[Focus step width]	Choose the amount the focus distance changes with each shot.
[Interval until next shot]	The time between shots, in seconds. Select [00] to take photos at up to about 3 fps. To ensure the correct exposure when using a flash, choose an interval long enough for the flash to charge.
[First-frame exposure lock]	If [On] is selected, the camera will lock exposure for all images at the setting for the first frame.
[Silent photography]	Select [On] to silence the shutter and eliminate the vibrations it produces during shooting. <ul style="list-style-type: none">• Selecting [On] does not completely silence the camera. Camera sounds may still be audible, for example during autofocus or aperture adjustment, in the latter case most noticeably at apertures smaller (i.e., at f-numbers higher) than f/5.6.

Option	Description
[Starting storage folder]	Highlight either of the following options and press  to select or deselect: <ul style="list-style-type: none"> • [New folder]: A new folder is created for each new sequence. • [Reset file numbering]: File numbering is reset to 0001 whenever a new folder is created.

Before Shooting

- Use an AF-S or AF-P lens.
- Choose a release mode other than .
- For best results, we recommend that you choose mode **A** or **M** so that aperture does not change during shooting. Focus shift is not available in  and **EFCT** modes.
- We recommend that you stop aperture down two or three stops from the maximum.
- We recommend that you take all shots at the same ISO sensitivity.
- Take a test shot at current settings and view the results.
- We recommend using a tripod and disabling lens vibration reduction (VR).
- To ensure that shooting is not interrupted, use an optional AC adapter and power connector or a fully-charged battery.
- When taking photos with your eye from the viewfinder and **[Off]** selected for **[Silent photography]**, remove the rubber eyecup and cover the viewfinder with the supplied eyepiece cap to prevent light entering via the viewfinder interfering with photographs and exposure ( 10).

Focus-Shift Photography

1 Rotate the focus-mode selector to AF.

Focus shift is not available with manual focus lenses.

2 Focus.

- The camera takes a series of shots starting from a selected focus position and continuing toward infinity. The starting focus position should be slightly in front of the closest point on the subject.
 - Do not move the camera after focusing.
-

3 Highlight [Focus shift shooting] in the photo shooting menu and press .

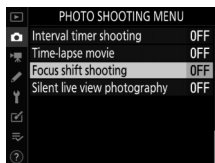

4 Adjust focus shift settings.

Adjust focus shift settings as described below.

• To choose the number of shots:

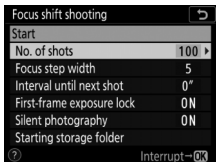

Highlight [**No. of shots**] and press .

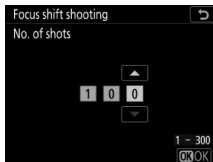

Choose the number of shots (max. 300) and press .

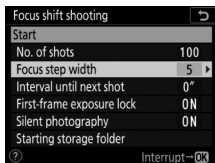

- We recommend taking more shots than you think you'll need and winnowing them down during focus stacking. More than 100 shots may be required for photographs of insects or other small objects, while only a few are needed to photograph a landscape from front to back with a wide-angle lens.

- To choose the amount the focus distance changes with each shot:

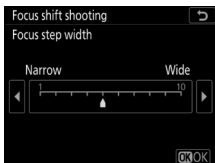

Highlight [**Focus step width**] and press .



Press  to reduce the focus step width,  to increase. Press  to proceed.

- A value of 5 or less is recommended, as higher settings increase the risk that some areas will be out of focus when the shots are stacked. Try experimenting with different settings before shooting.

- **To choose the interval between shots:**

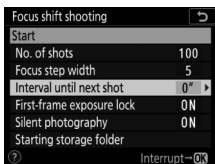

Highlight [**Interval until next shot**] and press .

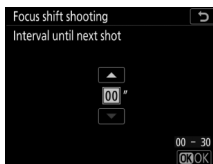

Choose the number of seconds between shots and press .

- Select **00** to take photos at up to approximately 3 fps. A setting of **00** is recommended when shooting without a flash; to ensure the correct exposure when using a flash, choose an interval long enough for the flash to charge.

• **To enable or disable first-frame exposure lock:**

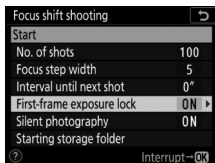

Highlight [**First-frame exposure lock**] and press \odot .

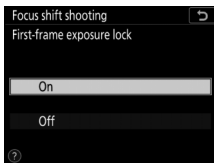

Highlight an option and press \odot .

- [**Off**] is recommended if lighting and other conditions will not change during shooting, [**On**] when photographing landscapes and the like under variable lighting.
- Selecting [**On**] locks exposure at the value for the first shot, ensuring that all photos have the same exposure. Large changes in subject brightness during shooting may however result in apparent variations in exposure. This can be addressed by selecting [**Off**].

• To enable or disable silent photography:

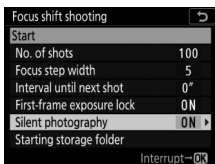

Highlight [**Silent photography**] and press

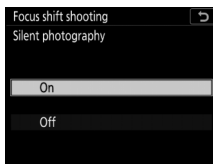

Highlight an option and press

- If [**On**] is selected, the only time the sound of the shutter or mirror will be heard is when the mirror is raised or lowered at the start and end of shooting.

• Choose start folder options:

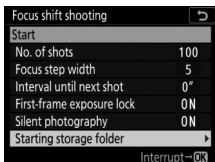

Highlight [**Starting storage folder**] and press

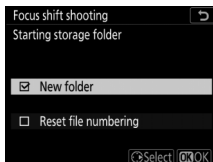

Highlight options and press to select or deselect. Press to proceed.

- Select [**New folder**] to create a new folder for each new sequence, [**Reset file numbering**] to reset file numbering to 0001 whenever a new folder is created.

5 Start shooting.

Highlight [**Start**] and press \odot .

Shooting starts after about 3 s. The camera takes photographs at the selected interval, starting at the focus distance selected at the start of shooting and progressing out toward infinity by the selected focus step distance with each shot. Shooting ends when the selected number of shots has been taken or focus reaches infinity. To end shooting before all shots have been taken, select [**Off**] for [**Focus shift shooting**] in the photo shooting menu or press the shutter-release button halfway or press the \odot button between shots.

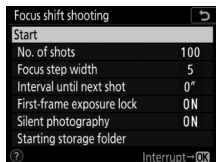

✓ Focus-Shift Photography

- The shutter speed and the time needed to record the image may vary from shot to shot. As a result, the interval between a shot being recorded and the start of the next shot may vary.
- Regardless of the option selected for Custom Setting c2 [**Standby timer**], the standby timer will not expire while shooting is in progress.
- If you are using a flash, choose an interval longer than the time needed for the flash to charge. If the interval is too short, the flash may fire at less than the power needed for full exposure.
- If shooting cannot proceed at current settings, for example because shutter speed is set to **b** **w** **l** **b** (bulb) or - - (time), a warning will be displayed.
- Changing camera settings while focus-shift photography is in progress may cause shooting to end.

✓ Adjusting Settings Between Shots

Shooting and menu settings adjusted between shots. Note, however, that the monitor will turn off approximately 2 s before the next shot is taken.

✓ Close-ups

Because depth of focus is reduced at short focus distances, we recommend choosing smaller focus steps and increasing the number of shots when photographing subjects close to the camera.

During Shooting

Immediately before each shot taken during focus-shift photography, the shutter-speed display in the control panel will show the number of shots remaining.



Focus-Shift Photography: Restrictions

- Focus-shift photography will not start if:
 - The camera clock is not set
 - An incompatible lens is attached (use only AF-S or AF-P lenses)
 - No memory card is inserted
- Focus-shift photography cannot be combined with some camera features, including:
 - Live view
 - Movie recording
 - Long time-exposures (bulb or time photography)
 - The self-timer
 - Bracketing
 - Multiple exposure
 - HDR (high dynamic range)
 - Interval-timer photography
 - Time-lapse movies
 - The negative digitizer

When [On] Is Selected for [Silent Photography]

Selecting [On] for [Silent photography] disables some camera features, including:

- ISO sensitivities of [Hi 0.3] through [Hi 2.0]
 - Flash photography
 - Exposure delay mode
 - Long exposure noise reduction
 - Flicker reduction
-

The Electronic Shutter (Silent Live View Photography)

To enable the electronic shutter during live view photography, muting the shutter and eliminating the vibrations it produces, select [On] for [**Silent live view photography**] in the photo shooting menu. Use for landscapes, still lifes, and other static subjects.

- Use of a tripod is recommended.
- Enabling silent live view photography changes the frame advance rates for continuous release modes (📖 178).

Silent Live View Photography

- Selecting [On] for [Silent live view photography] does not completely silence the camera. Camera sounds may still be audible, for example during autofocus or aperture adjustment, in the latter case most noticeably at apertures smaller (i.e., at f-numbers higher) than f/5.6.
- During silent live view, you may notice the following in the display. These phenomena will also be visible in the final pictures.
 - Flicker or banding in scenes lit by such sources as fluorescent, mercury vapor, or sodium lamps
 - Distortion associated with motion (individual subjects such as trains or cars moving at high speed through the frame may be distorted, or the entire frame may appear distorted when the camera is panned horizontally)
 - Jagged edges, color fringing, *moiré*, and bright spots in the display
 - Bright regions or bands in scenes lit by flashing signs and other intermittent light sources or when the subject is briefly illuminated by a strobe or other bright, momentary light source
- Selecting [On] for [Silent live view photography] mutes the shutter, but this does not absolve photographers of the need to respect their subjects' privacy and image rights.

Silent Photography

Selecting **[On]** for **[Silent live view photography]** disables some camera features, including:

- ISO sensitivities of Hi 0.3 through Hi 2
- Flash photography
- Long exposure noise reduction
- Flicker reduction

Silent Burst Photography

Custom Setting d13 **[Live view in continuous mode]** controls whether the monitor remains on during burst photography in silent mode.

Photographing Film Negatives (Negative Digitizer)

Create positive copies of color or black-and-white film negatives. [Negative Digitizer] is accessed via the **i** menu during live view photography.

1 Position the negatives in front of a featureless white or gray background.

- We recommend using an AF-S Micro NIKKOR 60mm f/2.8G ED or other micro lens and an ES-2 film digitizing adapter.
- We recommend using either natural light or an artificial light source with a high Ra (color rendering index), such as a light box or a high-CRI fluorescent lamp.

2 Rotate the mode dial to A.

We recommend that you choose a sensitivity of ISO 100 and an aperture of f/8.

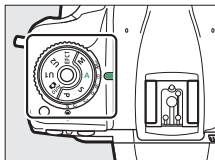

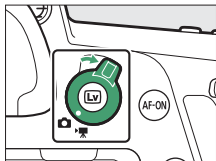

3 Rotate the live view selector to and press .

The view through the lens will be displayed in the monitor.





4 In live view, press the button and select [Negative digitizer].

- Highlight [Negative digitizer] using the multi selector and press ; the colors in the display will be reversed.
- The flash mode is automatically set to . To use a flash, choose a flash mode other than .



5 Choose the film type.

Press  or  to highlight [Color negatives] or [Monochrome negatives] and then press .



6 Compose the shot to capture a frame of the film negative.

7 Adjust exposure.

- Press **OK** to display brightness adjustment options. Press **←** or **→** to adjust exposure. Press **OK** again to save changes and exit.
- To view your subject at a higher magnification, press **Q** (**QUAL**).

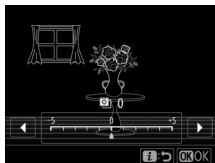

8 Take photographs.

- The photographs will be saved in JPEG format.
- Press the **i** button to exit negative digitizer mode.

✔ **Negative Digitizer**

- No options are available for correcting dust, scratches, or uneven colors due to faded film.
- Photos are saved in JPEG format even when **[NEF (RAW)]** is selected for image quality. Photos taken with a JPEG option selected will be saved at the chosen setting, while photos taken with **[NEF (RAW)]** selected will be saved in **[JPEG fine★]** format.

✔ **Negative Digitizer: Restrictions**

Some camera features cannot be used with the negative digitizer, including:

- Modes other than **A**
 - Movie recording
 - Bracketing
 - Multiple exposure
 - HDR (high dynamic range)
 - Interval-timer photography
 - Time-lapse movies
 - Focus shift
-

Customizing the **i** Menu: Customize **i** Menu

Choose the items displayed in the **i** menu during shooting. Use Custom Setting f1 [**Customize **i** menu**] to choose the items displayed during viewfinder photography, Custom Setting f2 [**Customize **i** menu (Lv)**] to choose the items displayed during live view photography, and Custom Setting g1 [**Customize **i** menu**] to choose the items displayed during movie recording. The procedure is described below.

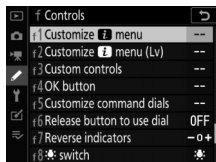

1 Highlight the position you want to change and press **OK**.

A list of the items available for the selected position will be displayed.

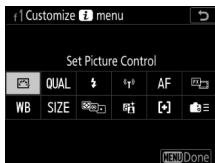

2 Highlight the desired item and press **OK**.

- The item will be assigned to the selected position and the options shown in Step 1 will be displayed.
- Repeat Steps 1 and 2 as desired.



3 Press the **MENU** button.

Changes will be saved and the Custom Settings menu will be displayed.

Using Non-CPU Lenses (Non-CPU Lens Data)

Non-CPU lenses (📖 786) can be used in modes **A** and **M**, with aperture set using the lens aperture ring. By specifying lens data (lens focal length and maximum aperture), the user can gain access to the following CPU lens functions.

- **If the focal length of the lens is known:**

- Power zoom can be used with optional flash units
- Lens focal length is listed (with an asterisk) in the playback photo info display

- **If the maximum aperture of the lens is known:**

- The aperture value is displayed in the control panel and viewfinder
- Flash level is adjusted for changes in aperture if the flash unit supports A (auto aperture) mode
- Aperture is listed (with an asterisk) in the playback photo info display

- **Specifying both the focal length and maximum aperture of the lens:**

- Enables color matrix metering (note that it may be necessary to use [**Center-weighted metering**] or [**Spot metering**] to achieve accurate results with some lenses, including Reflex-NIKKOR lenses)
 - Improves the precision of [**Center-weighted metering**] and [**Spot metering**] and i-TTL flash control
-

- ✓ **Teleconverters and Zoom Lenses**

- If the correct focal length is not available, for example because you are using a teleconverter or zoom lens, choose the next largest value.
 - The maximum aperture for teleconverters is the combined maximum aperture of the teleconverter and the lens.
-



Entering Lens Data

1 Select Non-CPU lens data.

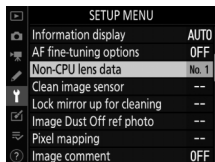
Highlight [**Non-CPU lens data**] in the setup menu and press .



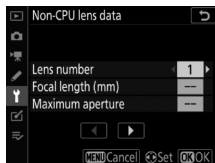

2 Select a lens number.

Highlight [**Lens number**] and press  or  to choose a lens number.



3 Enter the focal length and aperture.

Highlight [**Focal length (mm)**] or [**Maximum aperture**] and press  or  to edit the highlighted item.

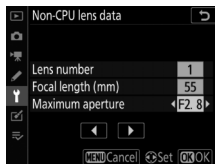

4 Save settings and exit.

Press . The specified focal length and aperture will be stored under the chosen lens number.

Recalling Non-CPU Lens Data

1 Assign non-CPU lens number selection to a camera control.

Assign [**Choose non-CPU lens number**] to a control using Custom Setting f3 [**Custom controls**].

2 Use the selected control to choose a lens number.

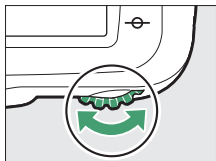

Press the selected CPU and rotate a command dial until the desired lens number is displayed in the control panel.



- | | |
|---|------------------|
| 1 | Focal length |
| 2 | Maximum aperture |
| 3 | Lens number |

Zoom Lenses

Lens data are not adjusted when non-CPU lenses are zoomed in or out. The data for different focal lengths can be entered as separate lens numbers, or the data for the lens can be edited to reflect the new values for lens focal length and maximum aperture each time zoom is adjusted.





Playback

Viewing Pictures

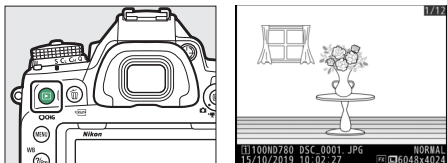

Full-Frame Playback

Press the  button to view the most recent picture full frame in the display.





- Additional pictures can be displayed by pressing  or ; to view additional information on the current photograph, press  or  ( 366).

Thumbnail Playback

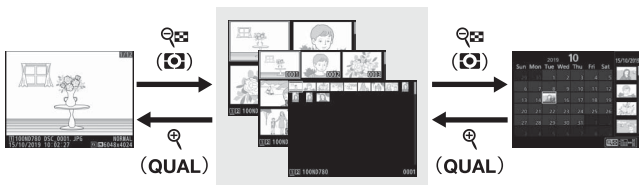
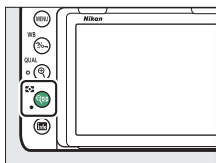
To view multiple images, press the  () button when a picture is displayed full frame.



- The number of images displayed increases from 4 to 9 to 72 each time the  () button is pressed, and decreases with each press of the  (**QUAL**) button. Use the multi selector to highlight images.

Calendar Playback

To view images taken on a selected date, press the () button when 72 images are displayed.

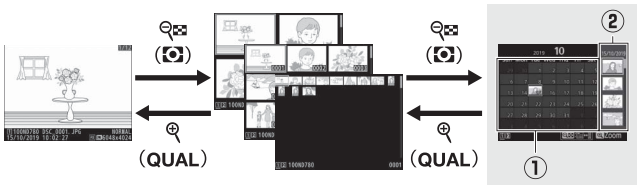

- Use the multi selector (, , , or) to highlight a date in the date list (①) and press () to place the cursor in the thumbnail list (②). Press or to highlight pictures in the thumbnail list. To return to the date list, press the () button a second time.
- To zoom in on the picture highlighted in the thumbnail list, press and hold the (QUAL) button.
- To exit to thumbnail playback, press (QUAL) when the cursor is in the date list.

Playback Controls

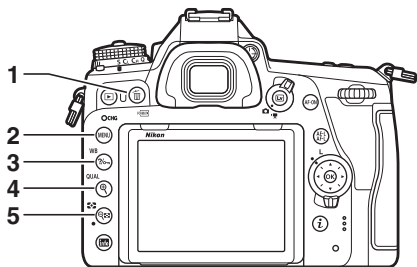

1 (FORMAT): Delete the current picture (☞ 383)

2 MENU: View the menus (☞ 57)

3 (WB): Protect the current picture (☞ 378)

4 (QUAL): Zoom in (☞ 376)

5 (VIEW): View multiple pictures (☞ 354)

✓ Touch Controls

Touch controls can be used when pictures are displayed in the monitor (☞ 14).

✓ Rotate Tall

To display “tall” (portrait-orientation) photographs in tall orientation, select [On] for [Rotate tall] in the playback menu.



Image Review

When **[On]** is selected for **[Image review]** in the playback menu, photographs are automatically displayed in the monitor after shooting (because the camera is already in the correct orientation, images are not rotated automatically during image review). In **CL**, **CH**, and **QC** modes, display begins when shooting ends, with the first photograph in the current series displayed.

Using the Touch Screen

During playback, the touch sensitive monitor can be used for the following operations.

■ Viewing Other Pictures

Flick left or right to view other pictures.

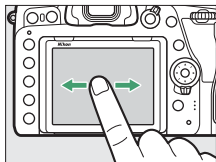

■ Scrolling Rapidly to Other Pictures

In full frame playback, you can touch the bottom of the display to display a frame advance bar, then slide your finger left or right to scroll rapidly to other pictures.

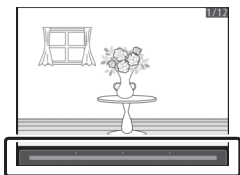
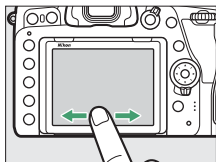

■ Zoom (Photos Only)

Use stretch and pinch gestures to zoom in and out and slide to scroll (📖 376). You can also give the display two quick taps to zoom in from full-frame playback or cancel zoom.

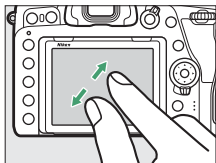



■ Viewing Thumbnails

To “zoom out” to a thumbnail view (📖 354), use a pinch gesture in full-frame playback.

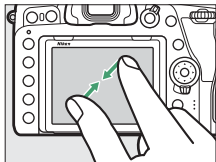
- Use pinch and stretch to choose the number of images displayed from 4, 9, and 72 frames.
- Using a pinch gesture when 72 frames are displayed takes you to calendar playback. To return to 72-frame playback, use a stretch gesture.



■ View Movies

Tap the on-screen guide to start movie playback (movies are indicated by a  icon). Tap the display to pause or resume, or tap  to exit to full-frame playback (note that some of the icons in the movie playback display do not respond to touch-screen operations).

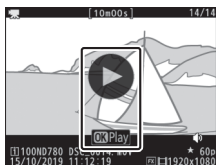



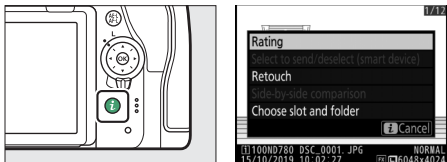

The **i** Button

Pressing the **i** button during playback zoom or full-frame or thumbnail playback displays the **i** menu for playback mode. Select options using the multi selector and **OK** button and press the **i** button to exit the menu and return to playback.



■ Photos

Option	Description
[Quick crop] ¹	Save a copy of the current image cropped to the area visible in the display. This option is not available when histograms are displayed (☐ 369).
[Rating]	Rate the current picture (☐ 380).
[Select to send/deselect (smart device)]	Select the current picture for upload (☐ 381). The option displayed varies with the type of device connected.
[Select to send/deselect (PC)]	
[Select to send/deselect (WT)]	
[Retouch]	Use the options in the retouch menu (☐ 709) to create a retouched copy of the current photograph.
[Side-by-side comparison] ²	Compare retouched copies to the original photographs.
[Choose slot and folder]	Choose a folder for playback. Highlight a slot and press  to list the folders on the selected card, then highlight a folder and press  to view the pictures in the highlighted folder.
[Select R, G, B] ³	Press  or  to choose the color channel for the highlight display.







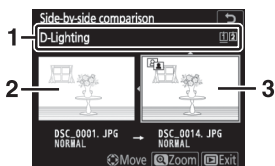

- 1 Displayed only during playback zoom.
- 2 Available only when a retouched copy (indicated by a  icon) or the source picture for a retouched copy is selected.
- 3 Available only when highlights or RGB histograms are displayed.

[Side-by-Side Comparison]

Choose [**Side-by-side comparison**] to compare retouched copies with the unretouched originals.



- 1 Options used to create copy
- 2 Source image
- 3 Retouched copy

- The source image is displayed on the left, the retouched copy on the right.
 - The options used to create the copy are listed at the top of the display.
 - Press  or  to switch between the source image and the retouched copy.
 - If the copy was created from multiple source images using [**Image overlay**], press  or  to view the other images.
 - If the source has been copied multiple times, press  or  to view the other copies.
 - To view the highlighted picture full screen, press and hold the  (**QUAL**) button.
 - Press  to return to playback with the highlighted image displayed full-frame.
 - To exit to playback, press the  button.
 - The source image will not be displayed if the copy was created from a photograph that is now protected.
 - The source image will not be displayed if the copy was created from a photograph that has since been deleted.
-

■ Movies

Option	Description
[Rating]	Rate the current movie (📖 380).
[Select to send/deselect (PC)]	Select the current movie for upload (📖 381). The option displayed varies with the type of device connected.
[Select to send/deselect (WT)]	
[Volume control]	Adjust playback volume.
[Trim movie]	Trim footage from the current movie and save the edited copy in a new file (📖 272).
[Choose slot and folder]	Choose a folder for playback. Highlight a slot and press ⏪ to list the folders on the selected card, then highlight a folder and press ⏩ to view the pictures in the highlighted folder.
[Select R, G, B] *	Press ⏪ or ⏩ to choose a color channel for the highlight display.

* Available in the highlight and RGB histogram displays only.

■ Movies (Playback Paused)





	Option	Description
	[Choose start/end point]	Trim footage from the current movie and save the edited copy in a new file (📖 272).
	[Save current frame]	Save a selected frame as a JPEG still (📖 277).
	[Add index]	Add indices to movies during playback (📖 278). Indices can be used to quickly locate frames during playback and editing.
	[Delete index]	Delete indices (📖 278).

Photo Information

Photo information is superimposed on images displayed in full-frame playback. Press or to cycle through photo information as shown below.

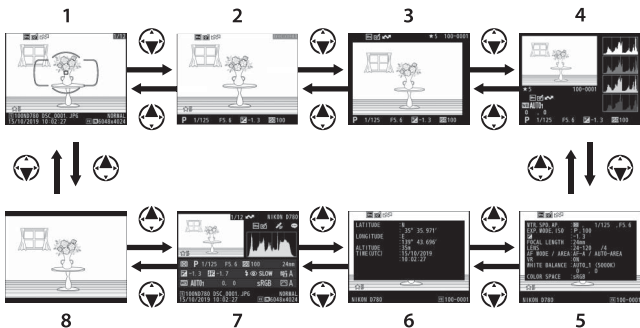

1 File information

2 Exposure data ¹

3 Highlights ¹

4 RGB histogram ¹

5 Shooting data ¹

6 Location data ²

7 Overview data ¹

8 None (image only) ¹

- 1 Displayed only if the corresponding option is selected for [**Playback display options**] in the playback menu.
- 2 Displayed only if embedded in the picture.

File Information

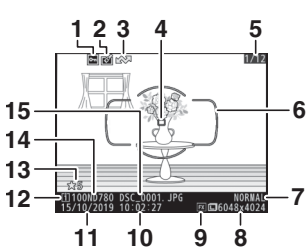

- 1 Protect status (📖 378)
- 2 Retouch indicator (📖 709)
- 3 Upload marking (📖 381)
- 4 Focus point* (📖 36)

- 5 Frame number/total number of frames
- 6 AF-area brackets*
- 7 Image quality (📖 134)
- 8 Image size (📖 137)
- 9 Image area (📖 129)
- 10 Time of recording (📖 658)
- 11 Date of recording (📖 658)
- 12 Current card slot (📖 279)
- 13 Rating (📖 380)
- 14 Folder name (📖 545)
- 15 File name (📖 550)

* Displayed only if **[Focus point]** is selected for **[Playback display options]**.

Exposure Data

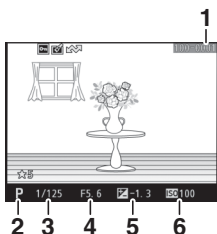

- 1 Folder number-frame number (☞ 545)
- 2 Shooting mode (☞ 107)
- 3 Shutter speed (☞ 110, 113)
- 4 Aperture (☞ 111, 113)
- 5 Exposure compensation (☞ 175)
- 6 ISO sensitivity* (☞ 187)

* Displayed in red if photo was taken in mode **P**, **S**, **A**, or **M** with auto ISO sensitivity control on.

Highlights

To choose a color channel for the highlight display, select **[Select R, G, B]** in the **i** menu and press **⬅** or **➡**.

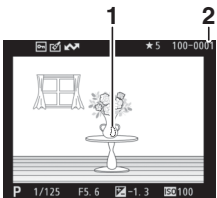

- 1 Highlights (areas that may be overexposed)
- 2 Folder number-frame number (☞ 545)

RGB Histogram

To choose a color channel for the highlight display, select [Select R, G, B] in the **i** menu and press **⏪** or **⏩**.

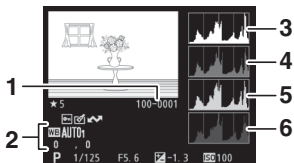

- 1 Folder number-frame number (□ 545)
- 2 White balance (□ 195)
Color temperature (□ 204)
Preset manual (□ 209)
White balance fine-tuning (□ 200)
- 3 Histogram (RGB channel)
- 4 Histogram (red channel)
- 5 Histogram (green channel)
- 6 Histogram (blue channel)

✔ Playback Zoom

To zoom in on the photograph when the histogram is displayed, press **Q** (QUAL). Use the **Q** (QUAL) and **Q** (QUAL) buttons to zoom in and out and scroll the image with the multi-selector. The histogram will be updated to show only the data for the portion of the image visible in the display.

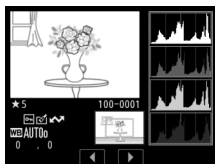

✔ Histograms

Histograms show tone distribution, with pixel brightness (tone) plotted on the horizontal axis and the number of pixels on the vertical axis.

Camera histograms are intended as a guide only and may differ from those displayed in imaging applications. Some sample histograms are shown below:

- If the image contains objects with a wide range of brightnesses, the distribution of tones will be relatively even.



- If the image is dark, tone distribution will be shifted to the left.



- If the image is bright, tone distribution will be shifted to the right.



Increasing exposure compensation shifts the distribution of tones to the right, while decreasing exposure compensation shifts the distribution to the left. Histograms can provide a rough idea of overall exposure when bright ambient lighting makes it difficult to see pictures in the display.

Shooting Data

View the settings in effect at the time the picture was taken.

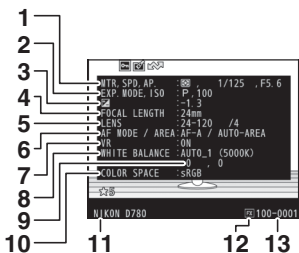

- 1 Metering (☞ 166)
Shutter speed (☞ 110, 113)
Aperture (☞ 111, 113)
- 2 Shooting mode (☞ 107)
ISO sensitivity¹ (☞ 187)

- 3 Exposure compensation (☞ 175)
Optimal exposure tuning² (☞ 604)
- 4 Focal length³
- 5 Lens data
- 6 Autofocus mode (☞ 140)
AF-area mode (☞ 145)
- 7 Lens vibration reduction (VR) on/off
- 8 White balance⁴ (☞ 195)
- 9 White balance fine-tuning (☞ 200)
- 10 Color space (☞ 554)
- 11 Camera name
- 12 Image area (☞ 129)
- 13 Folder number–frame number

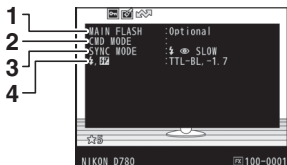

- 1 Flash type⁵
- 2 Remote flash control⁵
- 3 Flash mode⁵ (📖 465)
- 4 Flash control mode⁵ (📖 463)
Flash compensation⁵ (📖 469)

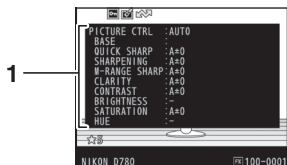

- 1 Picture Control⁶ (📖 243)

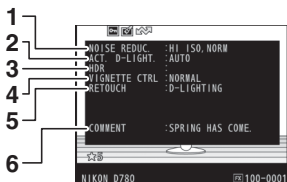

- 1 High ISO noise reduction (📖 557)
Long exposure noise reduction (📖 556)
- 2 Active D-Lighting (📖 254)
- 3 HDR strength (📖 256)
- 4 Vignette control (📖 558)
- 5 Retouch history (📖 709)
- 6 Image comment (📖 681)



- 1 Name of photographer⁷
(☞ 682)
- 2 Copyright holder⁷ (☞ 682)

- 1 Displayed in red if photo was taken in mode **P**, **S**, **A**, or **M** with auto ISO sensitivity control on.
- 2 Displayed if Custom Setting b5 [**Fine-tune optimal exposure**] has been set to a value other than zero for any metering method.
- 3 Also includes the magnification for pictures taken with a teleconverter.
- 4 Also includes color temperature of photos taken using **WB A** ([**Auto**]).
- 5 Displayed only if photo was taken with optional flash unit (☞ 459, 477).
- 6 The items displayed vary with the Picture Control selected when the picture was taken.
- 7 Copyright information is only displayed if recorded with the photograph using the [**Copyright information**] item in the setup menu.

Location Data

The latitude, longitude, and other location data are supplied by and vary with the smart device (☞ 687). In the case of movies, the data give the location at the start of recording.

Overview Data

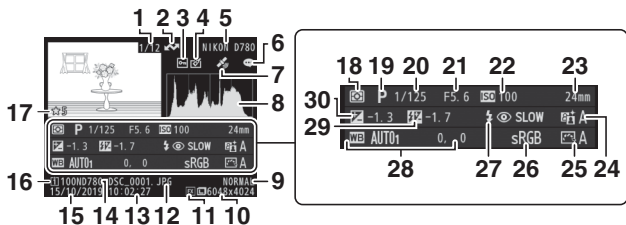

- 1** Frame number/total number of frames
- 2** Upload marking (📖 381)
- 3** Protect status (📖 378)
- 4** Retouch indicator (📖 709)
- 5** Camera name
- 6** Image comment indicator (📖 681)
- 7** Location data indicator (📖 687)
- 8** Histogram (📖 370)
- 9** Image quality (📖 134)
- 10** Image size (📖 137)
- 11** Image area (📖 129)
- 12** File name (📖 550)

- 13** Time of recording (📖 658)
- 14** Folder name (📖 545)
- 15** Date of recording (📖 658)
- 16** Current card slot (📖 279)
- 17** Rating (📖 380)
- 18** Metering (📖 166)
- 19** Shooting mode (📖 107)
- 20** Shutter speed (📖 110, 113)
- 21** Aperture (📖 111, 113)
- 22** ISO sensitivity¹ (📖 187)
- 23** Focal length
- 24** Active D-Lighting (📖 254)

25	Picture Control (☞ 243)
26	Color space (☞ 554)
27	Flash mode ² (☞ 465)
28	White balance (☞ 195) Color temperature (☞ 204) Preset manual (☞ 209) White balance fine-tuning (☞ 200)
29	Flash compensation ² (☞ 469) Commander mode ²
30	Exposure compensation (☞ 175)

- 1 Displayed in red if photo was taken in mode **P**, **S**, **A**, or **M** with auto ISO sensitivity control on.
- 2 Displayed only if photo was taken with optional flash unit.

Taking a Closer Look: Playback Zoom

To zoom in on an image displayed in full-frame playback, press the **QUAL** or **OK** button or give the display two quick taps.

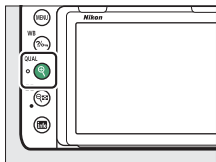

Playback Zoom

To	Description
Zoom in or out/view other areas of image	<p>Press QUAL or use stretch gestures to zoom in to maximum of approximately 24× (large images in FX/36 × 24 format), 18× (medium images) or 12× (small images). Press QUAL or use pinch gestures to zoom out. While photo is zoomed in, use multi selector or slide finger over screen to view areas of image not visible in monitor. Keep multi selector pressed to scroll rapidly to other areas of frame. Navigation window is displayed when zoom ratio is altered; area currently visible in monitor is indicated by yellow border. Bar under navigation window shows zoom ratio, turning green at 1 : 1.</p>



To	Description
Crop image	To create crop image to area currently visible in monitor, press i , highlight [Quick crop] and press OK . Note that [Quick crop] is not available when RGB histogram is displayed (□ 369).
Select faces	Faces detected during zoom are indicated by white borders in navigation window. Rotate sub-command dial or tap on-screen guide to view other faces. 
View other images	Rotate main command dial or tap ◀ or ▶ icons at bottom of display to view same location in other photos at current zoom ratio. Playback zoom is cancelled when a movie is displayed.
Change protect status	Press ?/WB to protect or remove protection from images (□ 378).
Return to shooting mode	Press the shutter-release button halfway or press the ▶ button to exit to shooting mode.
Display menus	Press MENU to view the menus.

Protecting Photographs from Deletion

In full-frame, zoom, and thumbnail playback, the **?**/**WB** button can be used to protect photographs from accidental deletion. Protected files cannot be deleted using the **FORMAT** button or the **[Delete]** item in the playback menu. Note that protected images will be deleted when the memory card is formatted (656).

To protect a photograph:

1 Select an image.

Display the image in full-frame playback or playback zoom or highlight it in the thumbnail list.

2 Press the **?**/**WB** button.

The photograph will be marked with a **WB** icon. To remove protection from the photograph so that it can be deleted, display the photograph or highlight it in the thumbnail list and then press the **?**/**WB** button.

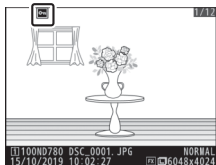
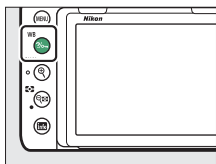

Removing Protection from All Images

To remove protection from all images in the folder or folders currently selected for **[Playback folder]** in the playback menu, press the **?/On** (**WB**) and  (**FORMAT**) buttons together for about two seconds during playback.

Rating Pictures

Rate pictures or mark them as candidates for later deletion. Ratings can also be viewed in NX Studio. Rating is not available with protected images.

1 Select a picture.

Display the image or highlight it in the thumbnail list in thumbnail playback.

2 Display playback options.

Press the **i** button to display playback options.

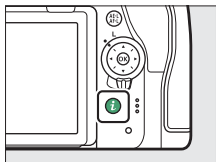

3 Select [Rating].

Highlight **[Rating]** and press **▶**.

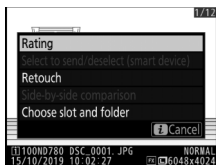

4 Choose a rating.

Press **◀** or **▶** to choose a rating of from zero to five stars, or select **✖** to mark the picture as a candidate for later deletion. Press **OK** to complete the operation.

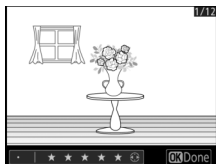

Selecting Pictures for Upload

Follow the steps below to select the current picture for upload to a smart device, computer, or ftp server.

- The **i** menu items used to select pictures for upload vary with the type of device connected:
 - [**Select to send/deselect (smart device)**]: Displayed when the camera is connected to a smart device via built-in Bluetooth using the [**Connect to smart device**] item in the setup menu (☞ 692).
 - [**Select to send/deselect (PC)**]: Displayed when the camera is connected to a computer via built-in Wi-Fi using the [**Connect to PC**] item in the setup menu (☞ 696).
 - [**Select to send/deselect (WT)**]: Displayed when the camera is connected to a computer or ftp server via an WT-7 wireless transmitter (available separately) using the [**Wireless transmitter (WT-7)**] item in the setup menu (☞ 700).
- Movies cannot be selected for upload when the camera is connected to a smart device via the SnapBridge app.
- The maximum file size for movies uploaded by other means is 4 GB.

1 Select a picture.

Display a picture in full-frame playback or playback zoom or select it in the thumbnail list.

2 Choose [Select to send/deselect].

Press the **i** button to display the **i** menu, then highlight [**Select to send/deselect**] and press **OK**. Pictures selected for upload are indicated by a **↗** icon; to deselect, repeat Steps 1 and 2.

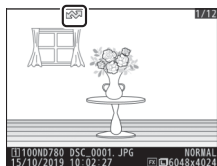
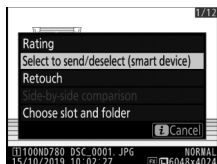

Deleting Pictures

Press the  (FORMAT) button to delete the current picture or use the [Delete] item in the playback menu to delete multiple selected pictures, all pictures taken on a selected date, or all pictures in the current playback folder (protected pictures cannot be deleted). Exercise caution when deleting pictures, as pictures cannot be recovered once deleted.

During Playback



Press the  (FORMAT) button to delete the current photograph.

1 Press the (FORMAT) button.

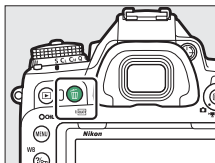
A confirmation dialog will be displayed.



2 Press the (FORMAT) button again.

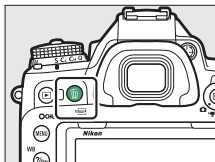

To delete the picture, press the  (FORMAT) button again. To exit without deleting the picture, press .



✔ Calendar Playback

During calendar playback, you can delete all photographs taken on a selected date by highlighting the date in the date list and pressing the  (FORMAT) button.



✔ Deleting Copies

If the picture selected in the playback display when the  (FORMAT) button is pressed was recorded with two memory cards inserted and **[Backup]** or **[RAW Slot 1 - JPEG Slot 2]** selected for **[Role played by card in Slot 2]**, you will be prompted to choose whether to delete both copies or only the copy on the card in the current slot ( 281).







The Playback Menu

The **[Delete]** item in the playback menu contains the following options. Note that depending on the number of images, some time may be required for deletion.

Option	Description
 [Selected]	Delete selected pictures.
 [Select date]	Delete all pictures taken on a selected date ( 387).
ALL [All]	Delete all pictures in the folder currently selected for playback. If two cards are inserted, you can select the card from which pictures will be deleted.

Selected

1 Select pictures.

- Use the multi selector to highlight a picture and press the  () button to select or deselect. Selected pictures are marked by a  icon (to view the highlighted picture full screen, press and hold the /QUAL button).

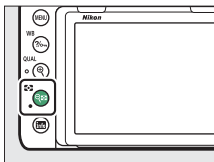

- Repeat as desired to select additional pictures.

2 Press to complete the operation.

A confirmation dialog will be displayed; highlight [Yes] and press .

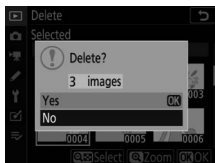

■ Select Date

1 Select dates.

Highlight a date and press to select all pictures taken on the highlighted date. Selected dates are marked with a icon. Repeat as desired to select additional dates; to deselect a date, highlight it and press .

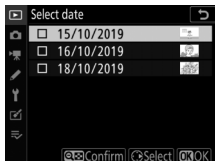

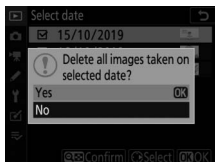

2 Delete the pictures taken on the selected dates.

Press . A confirmation dialog will be displayed; highlight [Yes] and press .



■ All

1 Choose a slot.

Press  or  to highlight the slot containing the memory card from which the pictures will be deleted and press .



2 Delete the pictures.

- Highlight [Yes] and press  to delete all pictures in the folder currently selected for [Playback folder] in the playback menu.
- Note that depending on the number of images, some time may be required for deletion.



Connecting to Computers and TVs

Connecting to Computers

To upload pictures to a computer, connect the camera via a wireless network or using the supplied USB cable.

Connecting via USB

Connect the camera using the supplied USB cable. You can then use NX Studio software to copy pictures to the computer for viewing and editing.

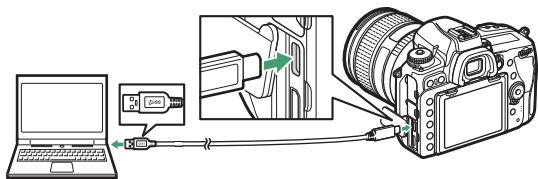

■ ■ Installing NX Studio

You will need an Internet connection when installing NX Studio. Visit the Nikon website for the latest information, including system requirements.

- Download the latest NX Studio installer from the website below and follow the on-screen instructions to complete installation.

<https://downloadcenter.nikonimglib.com/>

- Note that you may be unable to download pictures from the camera using earlier versions of NX Studio.

■ Copying Pictures to a Computer Using NX Studio

See online help for detailed instructions.

1 Connect the camera to the computer.

After turning the camera off and ensuring that a memory card is inserted, connect the supplied USB cable as shown.

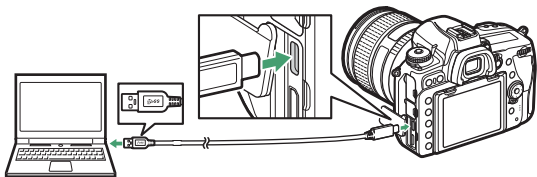

✔ Using a Card Reader

Pictures can also be copied from a memory card inserted in a third-party card reader. You should however check that the card is compatible with the card reader.

2 Turn the camera on.

- The Nikon Transfer 2 component of NX Studio will start. Nikon Transfer 2 image transfer software is installed as part of NX Studio.
- If a message is displayed prompting you to choose a program, select Nikon Transfer 2.
- If Nikon Transfer 2 does not start automatically, launch NX Studio and click the “Import” icon.

3 Click [Start Transfer].

Pictures on the memory card will be copied to the computer.

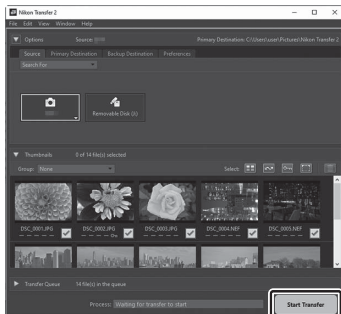

4 Turn the camera off.

Disconnect the USB cable when transfer is complete.

✓ Windows 10 and Windows 8.1

Windows 10 and Windows 8.1 may display an AutoPlay prompt when the camera is connected.

Click the dialog and then click [**Nikon Transfer 2**] to select Nikon Transfer 2.

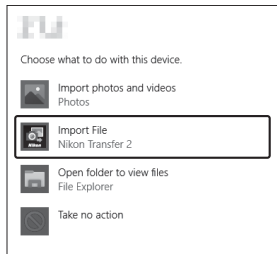
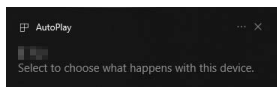

✔ macOS

If Nikon Transfer 2 does not start automatically, confirm that the camera is connected and then launch Image Capture (an application that comes with macOS) and select Nikon Transfer 2 as the application that opens when the camera is detected.

✔ Caution: Transferring Videos

Do not attempt to transfer videos from the memory card while it is inserted in a camera of a different make or model. Doing so could result in the videos being deleted without being transferred.

✔ Cautions: Connecting to Computers

- Do not turn the camera off or disconnect the USB cable while transfer is in progress.
- Do not use force or attempt to insert the connectors at an angle. Be sure also to keep the connectors straight when disconnecting the cable.
- Always turn the camera off before connecting or disconnecting a cable.
- To ensure that data transfer is not interrupted, be sure the camera battery is fully charged.

✔ USB Hubs

Connect the camera directly to the computer; do not connect the cable via a USB hub or keyboard. Connect the camera to a pre-installed USB port.

Wireless Networks (Wi-Fi)

The following methods can be used to connect to a computer via Wi-Fi. For more information, see “Network Connections” (📖 402).

■ Built-in Wi-Fi

Use the [**Connect to PC**] item in the camera setup menu to connect to computers either directly or via a wireless router.



Connection via a wireless router



Direct wireless connection

■ The WT-7 Wireless Transmitter

Connecting a WT-7 wireless transmitter enables the [**Wireless transmitter (WT-7)**] item in the setup menu. With Camera Control Pro 2 (available separately), the camera can be controlled and pictures saved to the computer as they are taken.

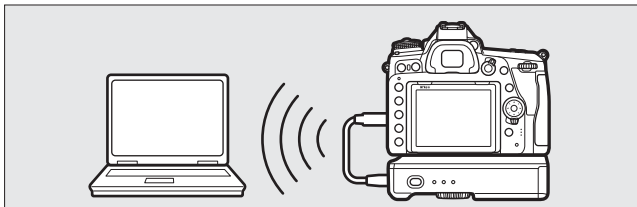

- The WT-7 can be used to upload pictures to computers or ftp servers.
- You can also connect via Ethernet.
- Use the WT-7 for connections that are more reliable than those offered by the camera's built-in Wi-Fi.

Connecting to HDMI Devices

The optional High-Definition Multimedia Interface (HDMI) cable or a type C HDMI cable (available separately from third-party suppliers) can be used to connect the camera to high-definition video devices. Always turn the camera off before connecting or disconnecting an HDMI cable.

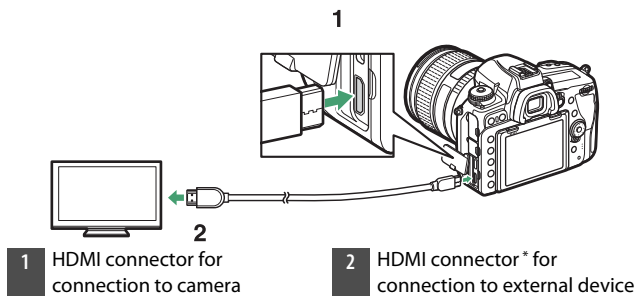

* Choose a cable with a connector that matches the connector on the HDMI device.

Connecting to HDMI TVs

- After connecting the camera to an HDMI television or other display, tune the device to the HDMI channel, then turn the camera on and press the  button. During playback, images will be displayed on the television screen.
- Volume can be adjusted using television controls; the camera controls cannot be used.
- If the camera is paired with a smart device running the SnapBridge app, the device can be used to control playback remotely while the camera is connected to a TV. See the SnapBridge app online help for details.

Connecting to HDMI Recorders

The camera can record video directly to connected HDMI recorders. Some recorders will even start and stop recording in response to camera controls. Use the [**HDMI**] item in the setup menu to adjust settings for HDMI output.





■ Output Resolution

Choose the format for images output to the HDMI device. If **[Auto]** is selected, the camera will automatically select the appropriate format.

■ Advanced

Adjust settings for connection to the HDMI device.

Option	Description
[Output range]	[Auto] is recommended in most situations. If the camera is unable to determine the correct RGB video signal output range for the HDMI device, you can choose [Limited range] for devices with an RGB video signal input range of 16 to 235 or [Full range] for devices with an RGB video signal input range of 0 to 255. Choose [Limited range] if you notice a loss of detail in shadows, [Full range] if shadows are “washed out” or too bright.

Option	Description
<p>[External recording control]</p>	<p>Enabling external recording control allows camera controls to be used to start and stop recording when the camera is connected via HDMI to a third-party recorder that supports the Atomos Open Protocol (Atomos SHOGUN, NINJA, or SUMO-series Monitor recorders). An icon will be displayed in the camera monitor:  STBY is displayed in movie live view, while  REC is displayed during movie recording. During recording, check the recorder and recorder display to ensure that footage is being saved to the device (note that the footage output to the device may be disrupted while external recording control is in effect). The camera display will turn off automatically when the standby timer expires, ending HDMI output; when recording movies to an external device, select Custom Setting c2 [Standby timer] and choose [No limit] or a time longer than the anticipated recording time. See the manual provided with the recorder for more information on device features and operation.</p>
<p>[Output data depth]</p>	<p>Choose from [8 bit] and [10 bit].</p>

Option	Description
[N-Log/HDR output options]	<p>Preserve details in highlights and shadows and avoid over-saturated colors when recording movies. [N-Log] is intended for footage that will be color graded during post-production. [HDR (HLG)] is used to record footage in HLG format for such applications as HDR broadcasting.</p> <ul style="list-style-type: none"> • The footage will be recorded directly to the external device. It cannot be saved to the camera memory card. • This option is available only when [10 bit] is selected for [Output data depth] in modes other than EFCT. • The [ISO sensitivity settings] > [Maximum sensitivity] and [ISO sensitivity (Mode M)] items in the movie shooting menu can be set respectively to values of from ISO 1600 to 51200 and from ISO 800 to 51200.
[View assist]	<p>Choose [On] for a live preview of video footage recorded with [N-Log] or [HDR (HLG)] selected for [N-Log/HDR output options]. The colors in the preview are simplified for enhanced contrast, but this has no effect on the footage actually recorded.</p>

✔ HDMI Output

HDMI output is not available when movies are recorded at frame sizes of 1920 × 1080 120p, 1920 × 1080 100p, or 1920 × 1080 slow-motion or when the camera is connected to a device running Camera Control Pro 2.

✔ [10 Bit] Selected for [Output Data Depth]

[10 bit] can be used only with compatible recorders. No photos can be taken; during movie recording, the following additional restrictions apply when 3840 × 2160 is selected for frame size:

- Movies are not recorded to memory cards inserted in the camera.
- Icons and characters in the monitor will display at low resolution.
- The angle of view is about 90%.

✔ HDR (HLG) Output

Optimal color reproduction can only be achieved if your equipment, including your storage device, computer, monitor, operating system, and software, support HDR (HLG). If a signal is received from the connected device indicating that it supports HDR (HLG), the camera will respond with a “gamma: HLG” identifier.

Network Connections

Camera and Network System Chart

This section is chiefly devoted to describing how to connect to a wireless local area network (LAN) using the camera's built-in Wi-Fi and how to use network features once connected. The types of network connection available with the camera and optional accessories are shown below.

- For information on connecting to networks using a WT-7 wireless transmitter, see the manual supplied with the WT-7.

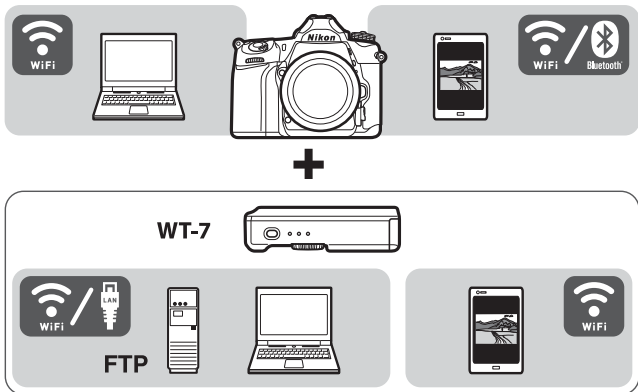

Connecting to Smart Devices

To connect to the camera from a smartphone or tablet (below, “smart device”), download the SnapBridge app.

The SnapBridge App

Use the SnapBridge app for wireless connections between the camera and smart devices.

The SnapBridge app is available free of charge from the Apple App Store® and on Google Play™. Visit the Nikon website for the latest SnapBridge news.



What SnapBridge Can Do for You

Using the SnapBridge app, you can:

- **Download pictures from the camera**
Download existing pictures or download new pictures as they are taken.
- **Control the camera remotely (remote photography)**
Control the camera and take pictures from the smart device.

For details, see the SnapBridge app online help:

<https://nikonimglib.com/snbr/onlinehelp/en/index.html>

Wireless Connections

Using the SnapBridge app, you can connect via Wi-Fi (📖 406) or Bluetooth (📖 415). Connecting using the SnapBridge app allows you to set the camera clock and update location data using information provided by the smart device. Connecting using Bluetooth allows pictures to be uploaded automatically as they are taken.

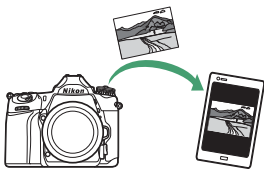

Wi-Fi

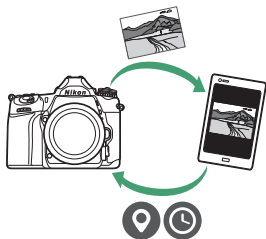

Bluetooth

Connecting via Wi-Fi (Wi-Fi Mode)

Follow the steps below to connect to the camera via Wi-Fi.

✔ Before Connecting

Before connecting, enable Wi-Fi on the smart device (for details, see the documentation provided with the device), check that there is space available on the camera memory card, and ensure that the batteries in the camera and smart device are fully charged to prevent the devices turning off unexpectedly.

1 Smart device: Launch the SnapBridge app.

If this is the first time you have launched the app, tap [Skip]. If you have launched the app before, you can instead proceed to Step 2.



2 Open the  tab and tap  > [Wi-Fi mode].

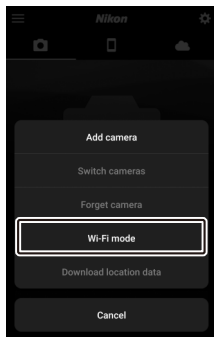

3 Smart device: Tap [Wi-Fi connection] when prompted.

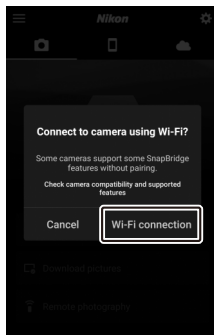

4 Camera/smart device: Turn the camera on.

The smart device will instruct you to ready the camera. Turn the camera on. Do not tap **[Next]** until you have completed the next step.

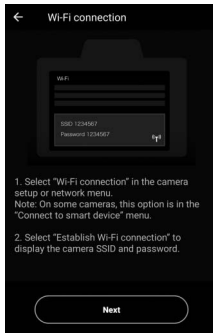

5 Camera: Enable Wi-Fi.

Select [**Connect to smart device**] > [**Wi-Fi connection**] in the setup menu, then highlight [**Establish Wi-Fi connection**] and press **OK**.

The camera SSID and password will be displayed.



✓ Enabling Wi-Fi

You can also enable Wi-Fi by selecting [**Wi-Fi connection**] > [**Establish Wi-Fi conn. with smart device**] in the **i** menu for shooting mode.



6 Smart device: Tap [Next].

Tap **[Next]** once you have enabled Wi-Fi on the camera as described in the preceding step.

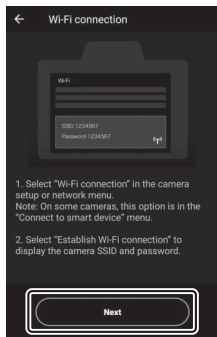

7 Smart device: After reading the instructions, tap [Open the device settings app].

- **Android devices:** Wi-Fi settings will be displayed.
- **iOS devices:** The “Settings” app will launch. Tap [< **Settings**] to open the “Settings” app. Next, scroll up and tap [**Wi-Fi**], which you’ll find near the top of the settings list.

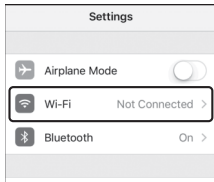
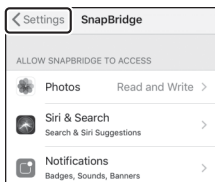
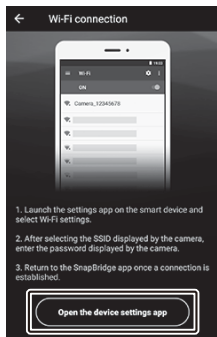

8 Smart device: Enter the camera SSID and password.

- Enter the SSID and password displayed by the camera in Step 5.
 - **Android device** (actual displays may differ)

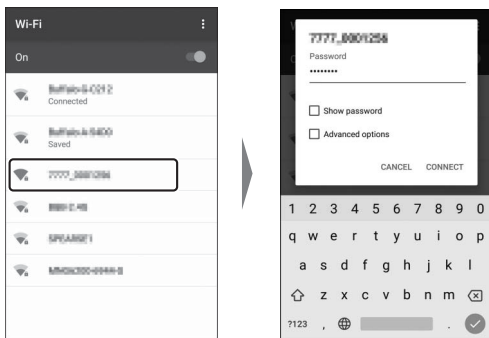

- **iOS device** (actual displays may differ)

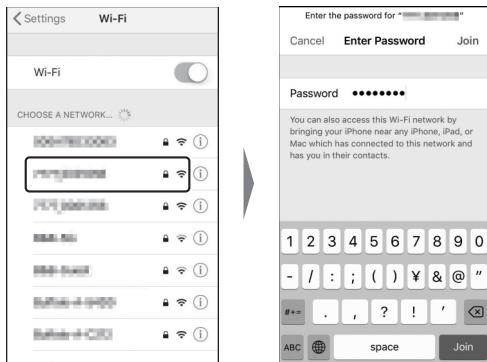



- You will not be required to enter the password when next you connect to the camera.

9 Smart device: Return to the SnapBridge app.

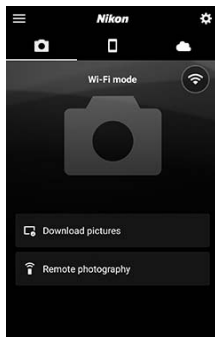
After a Wi-Fi connection is established, Wi-Fi mode options will be displayed. See online help for information on using the SnapBridge app.



✓ Terminating Wi-Fi Mode

To end the Wi-Fi connection, tap . When the icon changes to , tap  and select [Exit Wi-Fi mode.].

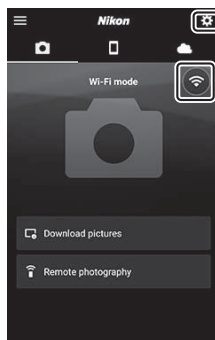

Connecting via Bluetooth

Before connecting via Bluetooth for the first time, you will need to pair the camera and smart device as described below. The pairing instructions for Android and iOS differ slightly.

✔ Before Pairing

Before beginning pairing, enable Bluetooth on the smart device (for details, see the documentation provided with the device), check that there is space available on the camera memory card, and ensure that the batteries in the camera and smart device are fully charged to prevent the devices turning off unexpectedly.

■ Android: Connecting for the First Time (Pairing)

For information on pairing the camera with iOS devices, see “iOS: Connecting for the First Time (Pairing)” (📖 422).

1 Camera: Ready the camera.

Select [**Connect to smart device**] > [**Pairing (Bluetooth)**] in the setup menu, then highlight [**Start pairing**] and press **OK**...

...to display the camera name.

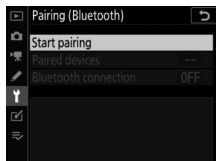

2 Android device: Launch the SnapBridge app.

- *If this is the first time you have launched the app,* tap [**Connect to camera**] and proceed to Step 3.



- If you have launched the app before, open the  tab and tap [**Connect to camera**].

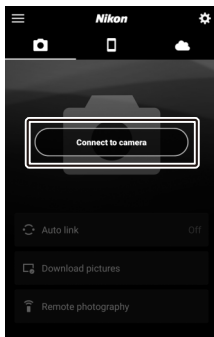

3 Android device: Choose the camera.

Tap the camera name.

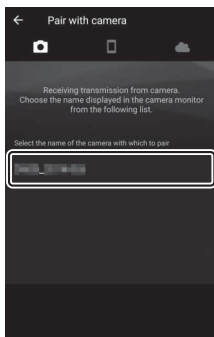

4 Camera/Android device: Check the authentication code.

Confirm that the camera and Android device display the same authentication code (circled in the illustration).

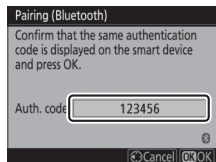
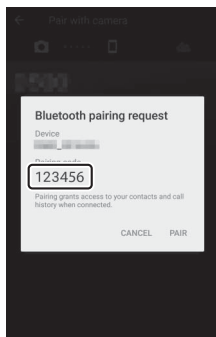

5 Camera/Android device: Initiate pairing.

- **Camera:** Press **OK**.

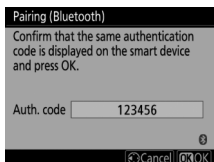

- **Android device:** Tap the button indicated in the illustration (the label may differ depending on the version of Android you are using).

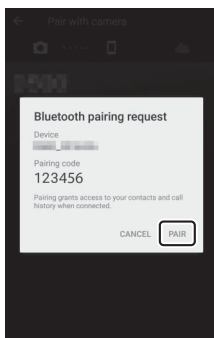

✓ Pairing Error

If you wait too long between pressing the button on the camera and tapping the button on the Android device, pairing will fail and an error will be displayed.

Camera: Press **OK** and return to Step 1.

Android device: Tap **[OK]** and return to Step 2.

6 Camera/Android device: Follow the on-screen instructions.

- **Camera:** Press **OK**. The camera will display a message stating that the devices are connected.



- **Android device:** Pairing is complete. Tap **OK** to exit to the  tab.

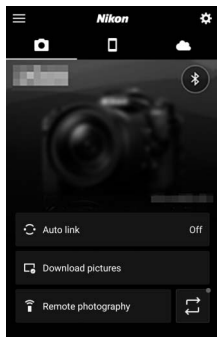
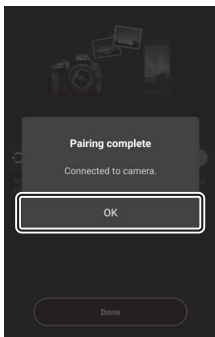

Pairing for the First Time

The first time you pair the Android device with a camera after installing the SnapBridge app, you will be prompted to select auto link (auto upload and auto clock and location synchronization) options. This prompt will not appear again, but auto link settings can be accessed at any time using **Auto link** in the  tab.

Pairing is now complete. The next time you use the SnapBridge app, you can connect as described in “Connecting to a Paired Device” (📖 429).

✔ **Disabling Bluetooth**

To disable Bluetooth, select [**Disable**] for [**Connect to smart device**] > [**Pairing (Bluetooth)**] > [**Bluetooth connection**] in the camera setup menu.

■ iOS: Connecting for the First Time (Pairing)

For information on pairing the camera with Android devices, see “Android: Connecting for the First Time (Pairing)” (📖 416).

1 Camera: Ready the camera.

Select [**Connect to smart device**] > [**Pairing (Bluetooth)**] in the setup menu, then highlight [**Start pairing**] and press **OK**...

...to display the camera name.

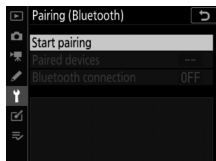

2 iOS device: Launch the SnapBridge app.

- *If this is the first time you have launched the app, tap [**Connect to camera**]* and proceed to Step 3.



- If you have launched the app before, open the  tab and tap [**Connect to camera**].

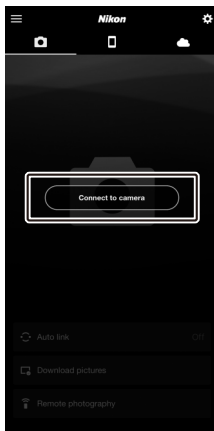

3 iOS device: Choose the camera.

Tap the camera name.

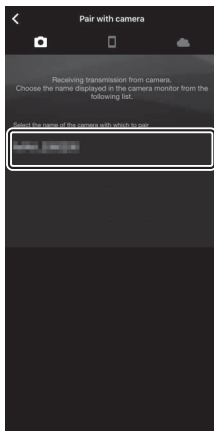

4 iOS device: Read the instructions.

Read the pairing instructions carefully and tap **[Understood]**.

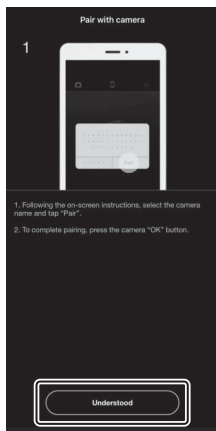

5 iOS device: Select an accessory.

When prompted to select an accessory, tap the camera name again.

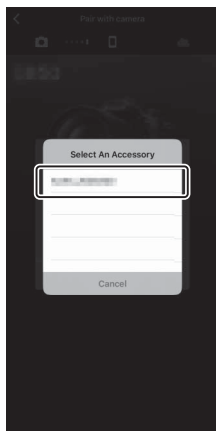

6 Camera/iOS device: Initiate pairing.

- **Camera:** Press .



- **iOS device:** Tap the button indicated in the illustration (the label may differ depending on the version of iOS you are using).

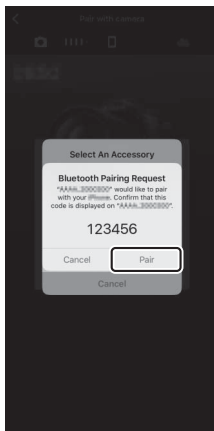

✔ Pairing Error

If you wait too long between pressing the button on the camera and tapping the button on the iOS device, pairing will fail and an error will be displayed.

Camera: Press  and return to Step 1.

iOS device: Dismiss the SnapBridge app and check that it is not running in the background, then open the iOS “Settings” app and request iOS to “forget” the camera as shown in the illustration before returning to Step 2.



7 Camera/iOS device: Follow the on-screen instructions.

- **Camera:** Press **OK**. The camera will display a message stating that the devices are connected.

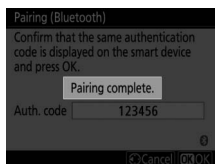

- **iOS device:** Pairing is complete. Tap **[OK]** to exit to the  tab.

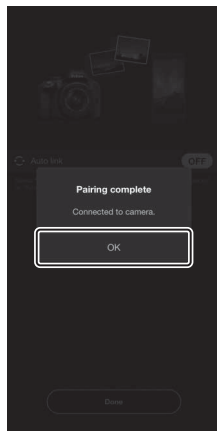

✔ **Pairing for the First Time**

The first time you pair the iOS device with a camera after installing the SnapBridge app, you will be prompted to select auto link (auto upload and auto clock and location synchronization) options. This prompt will not appear again, but auto link settings can be accessed at any time using [**Auto link**] in the  tab.

Pairing is now complete. The next time you use the SnapBridge app, you can connect as described in “Connecting to a Paired Device” (📖 429).

✔ **Disabling Bluetooth**

To disable Bluetooth, select [**Disable**] for [**Connect to smart device**] > [**Pairing (Bluetooth)**] > [**Bluetooth connection**] in the camera setup menu.

■ Connecting to a Paired Device

Connecting to a smart device that has already been paired with the camera is quick and easy.

1 Camera: Enable Bluetooth.

In the setup menu, select **[Connect to smart device] > [Pairing (Bluetooth)] > [Bluetooth connection]**, then highlight **[Enable]** and press **OK**.

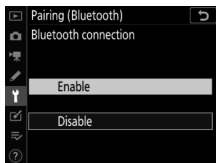

2 Smart device: Launch the SnapBridge app.

A Bluetooth connection will be established automatically.

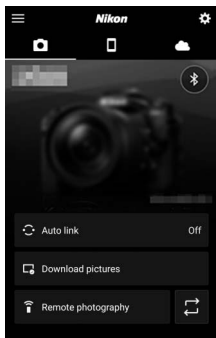

Connecting to Computers via Wi-Fi

What Wi-Fi Can Do for You

Connect via Wi-Fi to upload selected pictures to a computer.

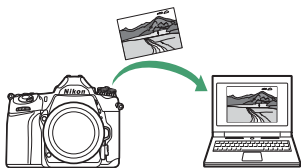

The Wireless Transmitter Utility

After configuring the camera for connection, you will need to pair it with the computer using the Wireless Transmitter Utility before you will be able to upload images via Wi-Fi. Once the devices are paired, you will be able to connect to the computer from the camera.

- The Wireless Transmitter Utility is a computer application available for download from the Nikon Download Center: <https://downloadcenter.nikonimglib.com/>
- Be sure to download the latest version after reading the release notes and system requirements.

Infrastructure and Access-Point Modes

The camera can connect either via a wireless router on an existing network (infrastructure mode) or by direct wireless link (access-point mode).

■ Access-Point Mode

The camera and computer connect via direct wireless link, with the camera acting as a wireless LAN access point and without the need for complicated adjustments to settings.



Choose this option when working outdoors or in other situations in which the computer is not already connected to a wireless network. The computer cannot connect to the Internet while connected to the camera.

- To create a new host profile, select **[Direct connection to PC]** in the connection wizard.

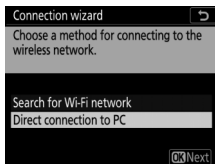

■ Infrastructure Mode

The camera connects to a computer on an existing network (including home networks) via a wireless router.



The computer can still connect to the Internet while connected to the camera.

- To create a new network profile, select **[Search for Wi-Fi network]** in the connection wizard.

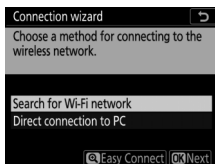

✓ Infrastructure Mode

This guide assumes you are connecting via an existing wireless network. Connection to computers beyond the local area network is not supported.

Connecting in Access-Point Mode

Follow the steps below to create a direct wireless link to a computer in access-point mode.

1 Display network settings.

Select [**Connect to PC**] in the camera setup menu, then highlight [**Network settings**] and press .

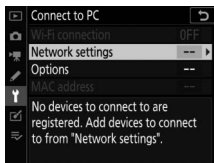

2 Select [Create profile].

Highlight [**Create profile**] and press .

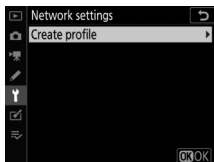

3 Select [Direct connection to PC].

- Highlight [**Direct connection to PC**] and press .
- The camera SSID and encryption key will be displayed.

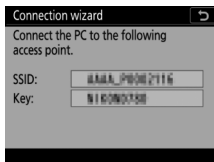
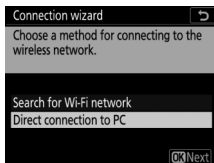

4 Connect from the computer.

Windows:

Click the wireless LAN icon in the taskbar and select the SSID displayed by the camera in Step 3. When prompted to enter the network security key, enter the encryption key displayed by the camera in Step 3.

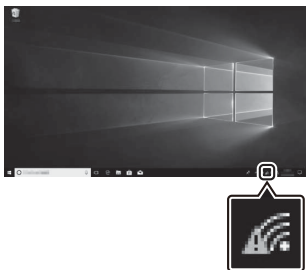

macOS:

Click the wireless LAN icon in the menu bar and select the SSID displayed by the camera in Step 3. When prompted to supply a password, enter the encryption key displayed by the camera in Step 3.



5 Launch the Wireless Transmitter Utility.

When prompted, launch the Wireless Transmitter Utility on the computer.



6 Select the camera.

In the Wireless Transmitter Utility, select the camera name displayed in Step 5 and click **[Next]**.

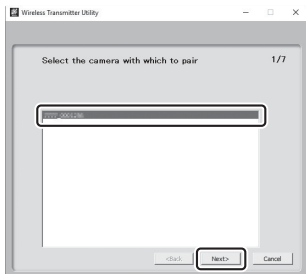

7 Enter the authentication code.

- The camera will display an authentication code.
- Enter the authentication code in the dialog displayed by the Wireless Transmitter Utility and click **[Next]**.

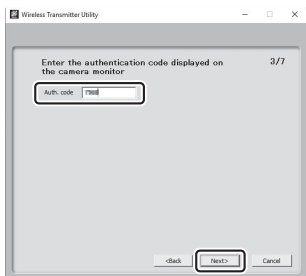

8 Complete the pairing process.

- When the camera displays a message stating that pairing is complete, press **OK**.



- In the Wireless Transmitter Utility, click **[Next]**. You will be prompted to choose the destination folder; for more information, see online help for the Wireless Transmitter Utility.

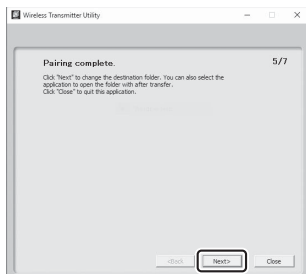

- A wireless connection will be established between the camera and computer when pairing is complete.

9 Check the connection.

- When a connection is established, the network SSID will be displayed in green in the camera [Connect to PC] menu.
- If the camera SSID is not displayed in green, connect to the camera via the wireless network list on your computer.

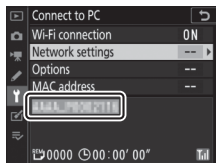

Now that a wireless connection has been established, you can upload images to the computer as described in “Uploading Pictures” (📖 447).

Connecting in Infrastructure Mode

Follow the steps below to connect to a computer on an existing network in infrastructure mode.

1 Display network settings.

Select [**Connect to PC**] in the camera setup menu, then highlight [**Network settings**] and press .

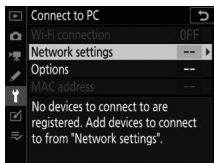

2 Select [Create profile].

Highlight [**Create profile**] and press .

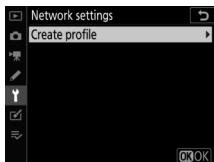

3 Search for existing networks.

Highlight [**Search for Wi-Fi network**] and press **OK**. The camera will search for networks currently active in the vicinity and list them by name (SSID).

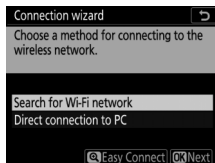

✓ [Easy Connect]

To connect without entering an SSID or encryption key, press **QUAL** in Step 3, then press **OK** and choose from the following options:

- **[Push-button WPS]**: For routers that support push-button WPS. Press the WPS button on the router and then press the camera **OK** button to connect.
- **[PIN-entry WPS]**: The camera will display a PIN; to connect, use a computer to enter the PIN into the router (for more information, see the documentation provided with the router).

After connecting, proceed to Step 6.

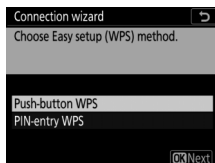

4 Choose a network.

Highlight a network SSID and press **OK** (if the desired network is not displayed, press **Q/QUAL** to search again). Encrypted networks are indicated by a **lock** icon; if the selected network is encrypted, you will be prompted to enter the encryption key as described in Step 5. If the network is not encrypted, proceed to Step 6.

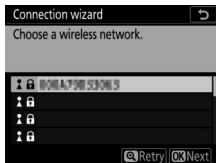

✓ Hidden SSIDs

Networks with hidden SSIDs are indicated by blank entries in the network list. If you highlight a blank entry and press **OK**, you will be prompted to provide the network name; press **OK**, enter a name, and then press **Q (QUAL)**. Press **Q (QUAL)** again to proceed to Step 5.

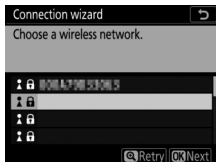

5 Enter the encryption key.

- When prompted to enter the encryption key for the wireless router, press **OK**.
- Next, enter the key as described below. For information on the encryption key, see the documentation for the wireless router. Press **QUAL** when entry is complete.
- Press **QUAL** again to initiate the connection. A message will be displayed for a few seconds when the connection is established.

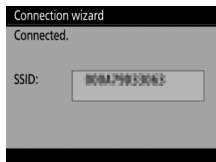
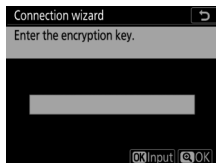

6 Obtain or select an IP address.

- Highlight one of the following options and press **OK**.
 - [**Obtain automatically**]: Select this option if the network is configured to supply the IP address automatically.
 - [**Enter manually**]: Press **OK**; a dialog will be displayed where you can manually enter an IP address. Rotate the main command dial to highlight segments, press **Left** or **Right** to change, and press **OK** to accept. Press **QUAL** to exit to the “IP address configuration complete” dialog when entry is complete. Pressing **QUAL** again displays the sub-net mask, which you can edit by pressing **Up** and **Down**, pressing **OK** to exit when entry is complete.
- Confirm the IP address and press **OK** to proceed.

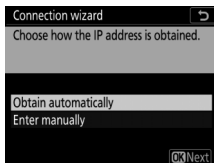

7 Launch the Wireless Transmitter Utility.

When prompted, launch the Wireless Transmitter Utility on the computer.

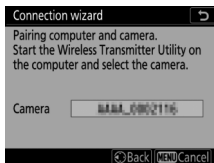

8 Select the camera.

In the Wireless Transmitter Utility, select the camera name displayed in Step 7 and click **[Next]**.

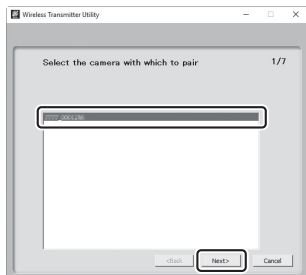

9 Enter the authentication code.

- The camera will display an authentication code.
- Enter the authentication code in the dialog displayed by the Wireless Transmitter Utility and click **[Next]**.

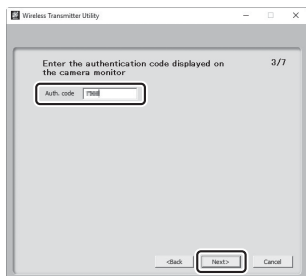

10 Complete the pairing process.

- When the camera displays a message stating that pairing is complete, press **OK**.
- In the Wireless Transmitter Utility, click **[Next]**. You will be prompted to choose the destination folder; for more information, see online help for the Wireless Transmitter Utility.

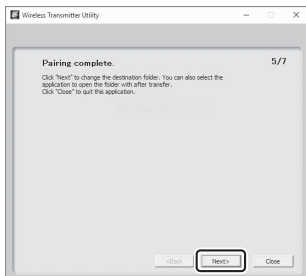
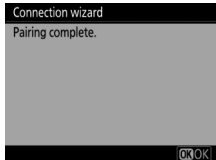

- A wireless connection will be established between the camera and computer when pairing is complete.

11 Check the connection.

- When a connection is established, the network SSID will be displayed in green in the camera [Connect to PC] menu.
- If the camera SSID is not displayed in green, connect to the camera via the wireless network list on your computer.

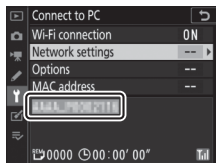

Now that a wireless connection has been established, you can upload images to the computer as described in “Uploading Pictures” (📖 447).

Uploading Pictures

You can select pictures for upload in the camera playback display or upload pictures as they are taken.

✔ Destination Folders

By default, images are uploaded to the following folders:

- Windows: \Users*(user name)*\Pictures\Wireless Transmitter Utility
- macOS: /Users/*(user name)*/Pictures/Wireless Transmitter Utility

The destination folder can be selected using the Wireless Transmitter Utility. For more information, see the utility's online help.

✔ Access Point Mode

Computers cannot access the Internet while connected to the camera in access point mode. To access the Internet, terminate the connection to the camera and then reconnect to a network with Internet access.

■ Selecting Pictures for Upload

Follow the steps below to select pictures for upload.

1 Start playback.

Press the  button on the camera and select full-frame or thumbnail playback.

2 Display or highlight the desired picture and press the *i* button.

3 Choose [Select to send/deselect (PC)].

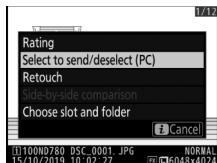

Highlight [**Select to send/deselect (PC)**] and press **OK**. A white transfer icon will appear on the picture. If the camera is currently connected to a network, upload will begin immediately; otherwise, upload will begin when a connection is established. The transfer icon turns green during upload. Repeat Steps 2–3 to upload additional images.

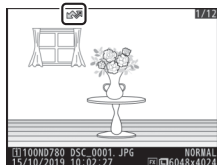

✓ Deselecting Pictures

- To remove transfer marking from selected pictures, repeat Steps 2 and 3.
- To remove transfer marking from all pictures, select [**Connect to PC**] > [**Options**] > [**Deselect all?**] in the setup menu.

■ ■ Uploading Photos as They Are Taken

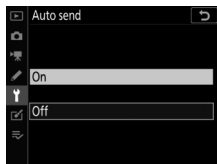

To upload new photos as they are taken, select **[On]** for **[Connect to PC]** >

[Options] > **[Auto send]**. Upload begins only after the photo has been recorded to the memory card; be sure a memory card is inserted in the camera. Movies, as well as any photographs taken during filming, are not uploaded automatically when recording is complete but must instead be uploaded from the playback display.



■ ■ The Transfer Icon

Upload status is indicated by the transfer icon.

-  **(white):Send.** The picture has been selected for upload but upload has not yet begun.
-  **(green):Sending.** Upload in progress.
-  **(blue): Sent.** Upload complete.

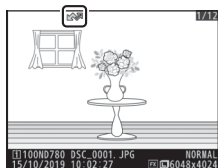

■ The Upload Status Display

The [**Connect to PC**] display shows the following information:

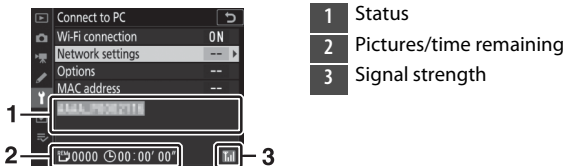

- **Status:** The status of the connection to the host. The host name is displayed in green when a connection is established. While files are being transferred, the status display shows “Now sending” preceded by the name of the file being sent. Any errors that occur during transfer are also displayed here.
- **Pictures/time remaining:** The estimated time required to send the remaining pictures.
- **Signal strength:** Wireless signal strength.

✓ Loss of Signal

Wireless transmission may be interrupted if the signal is lost, but can be resumed by turning the camera off and then on again.

Disconnecting and Reconnecting

The camera's link to an existing network can be suspended or resumed as described below.

■ Disconnecting

You can disconnect by turning the camera off, selecting **[Disable]** for **[Connect to PC] > [Wi-Fi connection]** in the setup menu, or selecting **[Wi-Fi connection] > [Close Wi-Fi connection]** in the still-photography **i** menu. The connection to the computer will also end if you use Wi-Fi or Bluetooth to connect to a smart device.

✓ Access-Point Mode

An error will occur if the computer's wireless connection is disabled before the camera's. Disable camera Wi-Fi first.

■ Reconnecting

To reconnect to an existing network, either:

- select **[Enable]** for **[Connect to PC]** > **[Wi-Fi connection]** in the setup menu, or
- choose **[Wi-Fi connection]** > **[Establish Wi-Fi connection with PC]** in the still-photography **i** menu.



✓ Access-Point Mode

Enable camera Wi-Fi before connecting.

✓ Multiple Network Profiles

If the camera has profiles for more than one network, it will reconnect to the last network used. Other networks can be selected using the **[Connect to PC]** > **[Network settings]** item in the setup menu.

Connecting to Networks Using the WT-7

The WT-7

When attached to the camera, the optional WT-7 wireless transmitter can be used to connect to computers, ftp servers, or other devices over Ethernet or wireless networks.

Before Using the WT-7

Before using the WT-7, confirm that the firmware for the camera and WT-7 have been updated to the latest versions. For more information, visit the Nikon website for your region.

What the WT-7 Can Do for You

Using the WT-7, you can:

■ **Upload existing photos and movies to an ftp server or computer**

Not only can you copy pictures to computers (image transfer mode), you can also upload them to ftp servers (ftp upload mode). Pictures can be uploaded as they are taken.

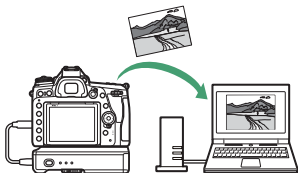

■ **Control the camera and take pictures remotely from a computer**

Installing Camera Control Pro 2 (available separately) on a network computer gives you complete control over camera settings and lets you take pictures remotely and save them directly to the computer hard disk (camera control mode).

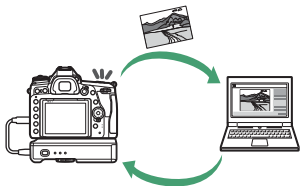

■ Control the camera and take pictures remotely from a web browser

Using a web browser, you can control the camera from network computers and smart devices for remote control that requires no dedicated app or computer software (http server mode).

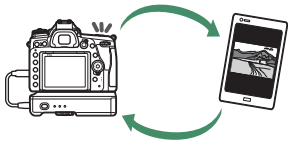

Connecting Using the WT-7

Connect the WT-7 using the USB cable supplied with the camera.

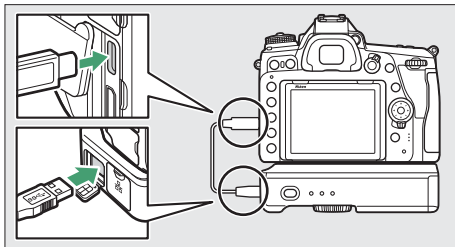

Turn the transmitter on and select **[Wireless transmitter (WT-7)]** > **[Wireless transmitter]** > **[Use]** in the camera setup menu.

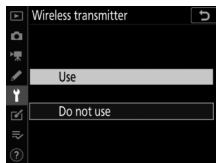

Menu Items for the WT-7

All menu items for the WT-7 can be found in the setup menu under **[Wireless transmitter (WT-7)]**. For more information, see the manual provided with the WT-7.

See the manual provided with the WT-7 for more information.

Troubleshooting Wireless Issues

Solutions to some common issues are listed below.

- Troubleshooting information for the SnapBridge app can be found in the app's online help, which can be viewed at: <https://nikonimglib.com/snbr/onlinehelp/en/index.html>
- For information on the WT-7 wireless transmitter, see the manual provided with the WT-7.
- For information on the Wireless Transmitter Utility or Camera Control Pro 2, see the online help for the application in question.

Problem	Solution
The camera displays a TCP/IP error.	Check settings for the host computer or wireless router and adjust camera settings appropriately (☞ 696).
The camera displays a “no memory card” error.	Confirm that the memory card is correctly inserted (☞ 27).
Upload is interrupted and fails to resume.	Upload will resume if the camera is turned off and then on again (☞ 447).
The connection is unreliable.	If [Auto] is selected for [Channel], choose [Manual] and select the channel manually (☞ 695).
	If the camera is connected to a computer in infrastructure mode, check that the router is set to a channel between 1 and 8 (☞ 696).
[Connect to smart device] and [Connect to PC] are grayed out and cannot be selected.	These options are not available when the WT-7 is connected. Turn the WT-7 off (☞ 700).

On-Camera Flash Photography

“On-Camera” Versus “Remote”

You can take pictures using a flash unit mounted on the camera accessory shoe or one or more remote flash units.

Camera-Mounted Flash Units

Take pictures using a flash unit mounted on the camera (📖 460).



Remote Flash Photography

Take pictures with one or more remote flash units using wireless flash control (Advanced Wireless Lighting, or AWL) as described in “Remote Flash Photography” (📖 477).

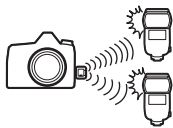

Using an On-Camera Flash

Follow the steps below to mount an optional flash unit on the camera and take photographs using the flash.

1 Mount the unit on the accessory shoe.

See the manual provided with the unit for details.

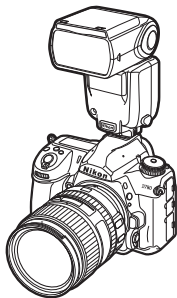

2 Turn on the camera and flash unit.

The flash will begin charging; the flash-ready indicator (⚡) will be displayed in the viewfinder when charging is complete.

3 Adjust flash settings.



Choose the flash control mode (📖 463) and flash mode (📖 465).

4 Adjust shutter speed and aperture.

5 Take pictures.

✔ Shutter Speed

Shutter speed can be set as follows when an optional flash unit is used:

Mode	Shutter speed
 P, A, EFCT ( and  excluded)	Set automatically by camera ($1/200$ s– $1/60$ s) *
S	Value selected by user ($1/200$ s–30 s)
M	Value selected by user ($1/200$ s–30 s, Bulb, Time)

* Shutter speed may be set as slow as 30 s if slow sync, slow rear-curtain sync, or slow sync with red-eye reduction is selected for flash mode.

✔ Third-Party Flash Units

The camera cannot be used with flash units that would apply voltages over 250 V to the camera's X contacts or short-circuit contacts on the accessory shoe. Use of such flash units could not only interfere with normal operation of the camera but also damage the flash sync circuits of the camera and/or flash.

✓ i-TTL Flash Control

When an optional flash unit that supports the Nikon Creative Lighting System is attached and set to TTL, the camera uses monitor preflashes for balanced or standard i-TTL fill-flash flash control. i-TTL flash control is not available with flash units that do not support the Nikon Creative Lighting System. The camera supports the following types of i-TTL flash control:

Flash control	Description
i-TTL balanced fill-flash	The camera uses i-TTL balanced fill-flash flash control for a natural balance between the main subject and ambient background lighting. After the shutter-release button is pressed and immediately before the main flash, the flash unit emits a series of monitor preflashes which the camera uses to optimize flash output for a balance between the main subject and ambient background lighting.
Standard i-TTL fill-flash	Flash output is adjusted to bring lighting in the frame to standard level; the brightness of the background is not taken into account. Recommended for shots in which the main subject is emphasized at the expense of background details, or when exposure compensation is used.



- Standard i-TTL fill-flash is activated automatically when [**Spot metering**] is selected.

Flash Control Mode

When a flash unit that supports unified flash control (an SB-5000, SB-500, SB-400, or SB-300) is mounted on the camera, the flash control mode, flash level, and other flash settings can be adjusted using the **[Flash control]** >

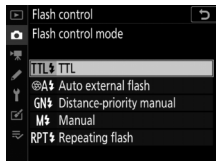
[Flash control mode] item in the photo shooting menu (in the case of the SB-5000, these settings can also be adjusted using the controls on the flash unit). The options available vary with the flash used, while the options displayed under **[Flash control mode]** vary with the mode selected. Settings for other flash units can only be adjusted using flash unit controls.



- **[TTL]**: i-TTL mode. In the cases of the SB-500, SB-400, and SB-300, flash compensation can be adjusted holding the  () button and rotating the sub-command dial.
- **[Auto external flash]**: In this mode, output is adjusted automatically according to the amount of light reflected by the subject; flash compensation is also available. Auto external flash supports “auto aperture” () and “non-TTL auto” (**A**) modes. See the flash unit manual for details.





- **[Distance-priority manual]**: Choose the distance to the subject; flash output will be adjusted automatically. Flash compensation is also available.
- **[Manual]**: Choose the flash level manually.
- **[Repeating flash]**: The flash fires repeatedly while the shutter is open, producing a multiple-exposure effect. Choose the flash level (**[Output]**), the maximum number of times the unit fires (**[Times]**), and the number of times the flash fires per second (**[Frequency]**, measured in Hertz). The options available for **[Times]** vary depending on the options selected for **[Output]** and **[Frequency]**; see the documentation provided with the flash unit for details.



✔ **Unified Flash Control**



Unified flash control allows the camera and flash unit to share settings. If a flash unit that supports unified flash control is mounted on the camera, changes to flash settings made with either the camera or flash unit are reflected on both devices, as are changes made using optional Camera Control Pro 2 software.

Flash Modes

The options available depend on the mode selected with the mode dial.

	Option	Description	Available in
	[Fill flash] (front-curtain sync)	This mode is recommended for most situations. In modes P and A , shutter speed will automatically be set to values between $1/200$ s (or $1/8000$ s with Auto FP High-Speed Sync) and $1/60$ s.	AUTO, P, S, A, M, EFCT (🚫) and  excluded)
	[Red-eye reduction] (red-eye reduction)	Use for portraits. The flash fires before the photograph is taken, reducing “red-eye” (a flash unit with red-eye reduction is required). Not recommended with moving subjects or in other situations in which quick shutter response is required. Do not move camera during shooting.	AUTO, P, S, A, M, EFCT (🚫) and  excluded)

Option	Description	Available in
 [Slow sync] (slow sync)	As for [Fill flash] except that shutter speed slows automatically to capture background lighting at night or under low light. Use when you want to capture both subject and background. Use of a tripod is recommended to prevent blurring caused by camera shake.	P, A
 [Slow sync + red-eye] (red-eye reduction with slow sync)	As for [Red-eye reduction] except that shutter speed slows automatically to capture background lighting at night or under low light. Use when you want to include background lighting in portraits. Use of a tripod is recommended to prevent blurring caused by camera shake.	P, A

Option	Description	Available in
 [Rear-curtain sync] (rear-curtain sync)	The flash fires just before the shutter closes, creating the effect of a stream of light behind moving light sources. Use of a tripod is recommended to prevent blurring caused by camera shake. Selecting P or A after choosing this option sets the flash mode to slow sync.	P, S, A, M
 [Flash off]	The flash does not fire.	<small>AUTO</small>  , P, S, A, M, EFCT

Studio Strobe Lighting

Rear-curtain sync cannot be used with studio flash systems, as the correct synchronization cannot be obtained.

Choosing a Flash Mode

Hold the  (1/2) button and rotate the main command dial.

- The selected option is displayed in the monitor.

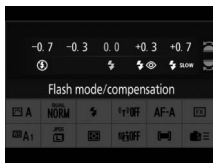
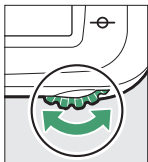
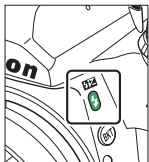

Flash Compensation

Flash compensation is used to deliberately alter flash output to, for example, change the brightness of the subject relative to the background. Flash output can be increased to make the main subject appear brighter, reduced to prevent glare, or otherwise fine-tuned to produce the desired result.

Adjusting Flash Compensation

Hold the **⚡ (Fn)** button and rotate the sub-command dial. The selected option will be displayed in the monitor, control panel, and viewfinder.

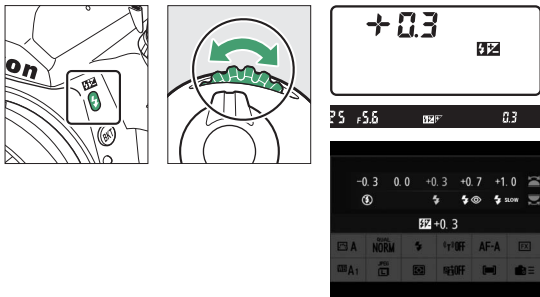

- Flash output can set to values of from -3 to $+1$ EV.
- At default settings, changes to flash output are made in increments of $1/3$ EV. The size of the increment can be selected using Custom Setting b1 [**EV steps for exposure ctrl**].
- In general, choose positive values for brighter lighting, negative values to ensure that the subject is not too brightly lit.
- Normal flash output can be restored by setting flash compensation to ± 0.0 . Flash compensation is not reset when the camera is turned off.

FV Lock

This feature is used to lock flash output for CLS-compatible flash units, allowing photographs to be recomposed without changing the flash level and ensuring that flash output is appropriate to the subject even when the subject is not positioned in the center of the frame. Flash output is adjusted automatically for any changes in ISO sensitivity and aperture. FV lock is not available in **AUTO** and **EFCT** modes.

To use FV lock:

1 Assign [FV lock] to a camera control.

Assign [**FV lock**] to a control using Custom Setting f3 [**Custom controls**].

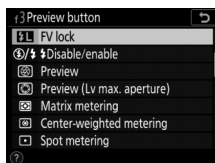

2 Attach a CLS-compatible flash unit.

Mount a CLS-compatible flash unit on the camera accessory shoe.

3 Set the flash unit to the appropriate mode.

Turn the flash unit on and select [TTL] or [**Auto external flash**] for [**Flash control**] > [**Flash control mode**] (SB-5000, SB-500, SB-400, or SB-300) or set the flash control mode to TTL, monitor pre-flash  **A**, or monitor pre-flash **A** (other flash units; see the documentation provided with the flash unit for details).

4 Focus.

Position the subject in the center of the frame and press the shutter-release button halfway to focus.



5 Lock flash level.

After confirming that the flash-ready indicator (⚡)



appears in the viewfinder, press the control selected in Step 1. The flash unit will emit a monitor pre-flash to determine the appropriate flash level. Flash output will be locked at this level and FV lock icon (🔒) will appear in the viewfinder.

6 Recompose the photograph.



7 Take the photograph.

Press the shutter-release button the rest of the way down to shoot. If desired, additional pictures can be taken without releasing FV lock.

8 Release FV lock.

Press the control selected in Step 1 to release FV lock. Confirm that the FV lock icon (🔒) is no longer displayed in the viewfinder.

Flash Info for On-Camera Units

When a unit that supports unified flash control (the SB-5000, SB-500, SB-400, or SB-300) is mounted on the camera accessory shoe, flash info can be viewed in the camera display. To view flash info during viewfinder photography, press the **Info** button to activate the information display (☞ 776) and then press the **Info** button again.

Flash Control Mode Displays

■ TTL

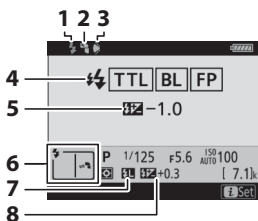

- 1 Flash-ready indicator (☞ 460)
- 2 Bounce icon (displayed if flash head is tilted up, left, or right)
- 3 Zoom head position warning (displayed if zoom head is not in correct position)
- 4 Flash control mode (☞ 463)
FP indicator (☞ 618)
- 5 Flash compensation (TTL; ☞ 469)
- 6 Flash mode (☞ 465)
- 7 FV lock indicator (☞ 471)
- 8 Flash compensation (☞ 469)

■ Auto External Flash

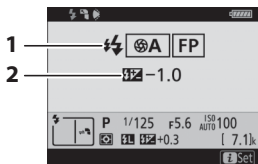

- 1 Flash control mode (⚡ 463)
FP indicator (book 618)
- 2 Auto external flash compensation (FP) (book 469)

■ Distance-Priority Manual

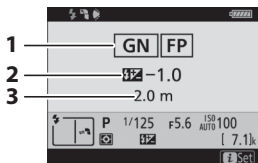

- 1 Flash control mode (GN) (book 463)
FP indicator (book 618)
- 2 Flash compensation (distance-priority manual) (book 469)
- 3 Distance (book 463)

■ Manual

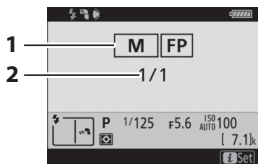

- 1 Flash control mode (M) (book 463)
FP indicator (book 618)
- 2 Flash level (book 469)

■ Repeating Flash

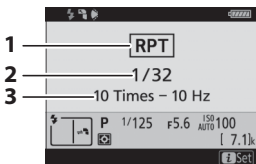

- 1 Flash control mode (☰ 463)
- 2 Flash level (output; ☰ 463)
- 3 Number emitted (times; ☰ 463)
Frequency (☰ 463)

✓ Flash Info and Camera Settings

The flash information display shows selected camera settings, including shooting mode, shutter speed, aperture, and ISO sensitivity.



✓ Changing Flash Settings

Flash settings can be changed by pressing the **i** button in the flash info display. The options available vary with the flash unit and the settings selected. You can also test-fire the flash.

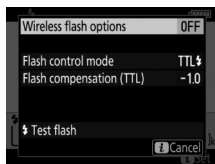

Remote Flash Photography

What Is Remote Flash Photography?

The camera can be used with one or more remote flash units (Advanced Wireless Lighting, or AWL). For information on using a flash unit mounted on the camera accessory shoe, see “On-Camera Flash Photography” (📖 459).

Throughout this chapter, operations involving an accessory connected to the camera are indicated by 📷, operations involving remote flash units by 📷. For more information on 📷, see the manual provided with the flash unit.

Using Remote Flash Units

Remote flash units can be controlled via optical signals from a flash unit mounted on the camera accessory shoe (*optical AWL*) or via radio signals from a WR-R10 (available separately) connected to the camera (*radio AWL*). These forms of flash control can be combined as follows:

- **Radio AWL with one or more remote flash units** (📖 479)

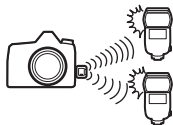

- **Optical AWL with one or more remote flash units** (📖 494)

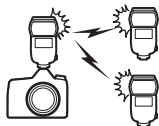

- **Radio AWL with additional lighting provided by a shoe-mounted flash unit** (📖 493)



- **Radio AWL combined with optical AWL provided by a shoe-mounted flash unit** (📖 506)

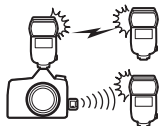

Radio AWL

Radio AWL is available with SB-5000 flash units. Attach a WR-R10 wireless remote controller to the camera and establish a wireless connection between the flash units and the WR-R10.

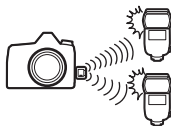

Establishing a Wireless Connection

Before using radio AWL, establish a wireless connection between the WR-R10 and the remote flash units.

1 **Connect the WR-R10.**

For more information, see the documentation provided with the WR-R10.

2 **Select [Radio AWL].**

Select **[Radio AWL]** for **[Flash control]** > **[Wireless flash options]** in the photo shooting menu.

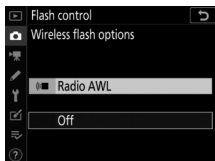

The WR-R10 Wireless Remote Controller

Be sure to update the WR-R10 firmware to version 3.0 or later; for information on firmware updates, see the Nikon website for your area.

3 : Choose a channel.

Set the WR-R10 channel selector to the desired channel.

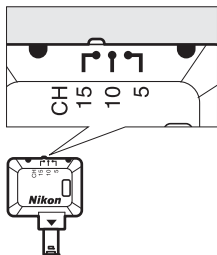

4 : Choose a link mode.

Select [**Wireless remote (WR) options**] > [**Link mode**] in the setup menu and choose from the following options:

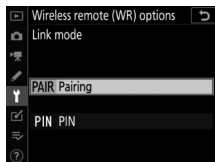

Option	Description
[Pairing]	The camera connects only to devices with which it has previously been paired, preventing signal interference from other devices in the vicinity. Given that each device must be paired separately, [PIN] is recommended when connecting to a large number of devices.
[PIN]	Communication is shared among all devices with the same four-digit PIN, making this a good choice for photography featuring a large number of remote devices. If there are multiple cameras present that share the same PIN, the flash units will be under the sole control of the camera that connects first, preventing all other cameras from connecting (the LEDs on the WR-R10 units connected to the affected cameras will blink).

5 : Establish a wireless connection.

Set the remote flash units to radio AWL remote mode and set the devices to the channel you selected in Step 3, then pair each of the remote units with the WR-R10 according to the option selected in Step 4:

- **[Pairing]**: Initiate pairing on the remote unit and press the WR-R10 pairing button. Pairing is complete when the **LINK** lamps on the WR-R10 and flash unit flash orange and green; once a connection is established, the **LINK** lamp on the remote flash unit will light green.
- **[PIN]**: Use the controls on the remote flash unit to enter the PIN you selected in Step 4. The **LINK** lamp on the remote unit will light green once a connection is established.

6 : Confirm that the flash-ready lights for all flash units are lit.

In radio AWL, the flash-ready indicator will light in the camera viewfinder or flash information display when all flash units are ready.

✓ Listing Remote Flash Units

To view the flash units currently controlled using radio AWL, select **[Flash control]** > **[Radio remote flash info]** in the photo shooting menu. The identifier (remote flash unit name) for each unit can be changed using flash unit controls.

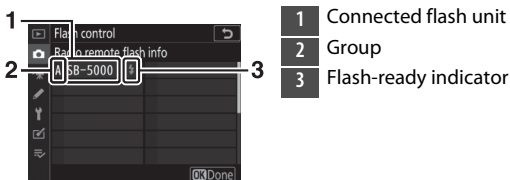

✓ Reconnecting

As long as the channel, link mode, and other settings remain the same, the WR-R10 will automatically connect to previously paired flash units when you select remote mode and Steps 3–5 can be omitted. The flash unit **LINK** lamp lights green when a connection is established.

Adjusting Flash Settings

After selecting [Radio AWL] for [Flash control] > [Wireless flash options] in the photo shooting menu, select [Group flash], [Quick wireless control], or [Remote repeating] for [Remote flash control] and adjust settings as described below.

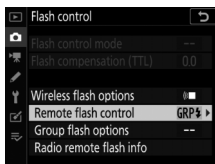

■ Group Flash

Select this item to adjust settings separately for each group.

1 📷: Select [Group flash].

Select [Group flash] for [Flash control] > [Remote flash control] in the photo shooting menu.

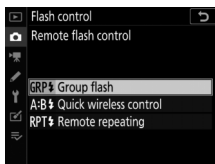

2 📷: Select [Group flash options].

Highlight [Group flash options] in the flash control display and press .

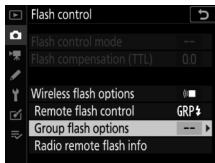

3 : Choose the flash control mode.

Choose the flash control mode and flash level for the master flash and the flash units in each group:

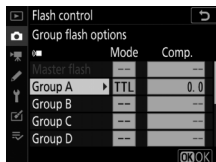



Option	Description
TTL	i-TTL flash control.
 A	Auto aperture (available only with compatible flash units).
M	Choose the flash level manually.
-- (off)	The units do not fire and the flash level cannot be adjusted.

4 : Group the remote flash units.

- Choose a group (A–F) for each of the remote flash units.
- The master flash can control up to 18 flash units in any combination.

5 : Compose the shot.

- Compose the shot and arrange the flash units. See the documentation provided with the flash units for more information.
- After arranging the units, press the **i** button in the flash info display ( 510) and select [ **Test flash**] to test-fire the units and confirm that they are functioning normally.

6 : Take the photograph.

■ Quick Wireless Control

Select this item to control overall flash compensation for, and the relative balance between, groups A and B, while setting output for group C manually.

1 : Select [Quick wireless control].

Select [Quick wireless control] for [Flash control] > [Remote flash control] in the photo shooting menu.

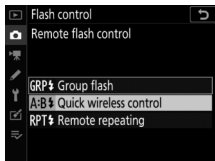

2 : Select [Quick wireless control options].

Highlight [Quick wireless control options] in the flash control display and press .

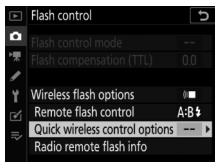

3 Adjust flash settings.

- Choose the balance between groups A and B.

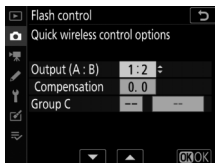

- Adjust flash compensation for groups A and B.

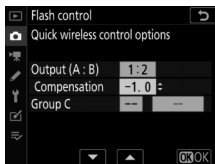

- Choose a flash control mode and flash level for the units in group C:

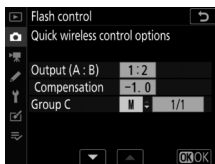

- [M]: Choose the flash level manually.
- [---]: The units in group C do not fire.



4 Group the remote flash units.

- Choose a group (A, B, or C).
- The master flash can control up to 18 flash units in any combination.

5 : Compose the shot.

- Compose the shot and arrange the flash units. See the documentation provided with the flash units for more information.
- After arranging the units, press the **i** button in the flash info display ( 510) and select [ **Test flash**] to test fire the units and confirm that they are functioning normally.

6 : Take the photograph.

■ Remote Repeating

When “remote repeating” is enabled, the flash units fire repeatedly while the shutter is open, producing a multiple-exposure effect.

1 📷: Select [Remote repeating].

Select **[Remote repeating]** for **[Flash control]** > **[Remote flash control]** in the photo shooting menu.

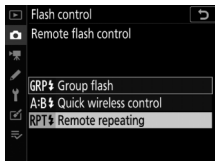

2 📷: Select [Remote repeating options].

Highlight **[Remote repeating options]** in the flash control display and press **⏏**.

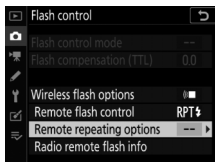

3 : Adjust flash settings.

- Choose the flash level ([**Output**]), the maximum number of times the flash units fire ([**Times**]), and the number of times the flash units fire per second ([**Frequency**]).

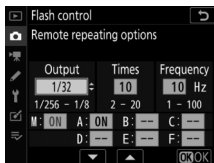

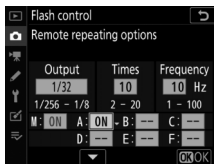

- Enable or disable selected groups. Select [**ON**] to enable the selected group, [---] to disable the selected group.



4 : Group the remote flash units.

- Choose a group (A–F) for each of the remote flash units.
- The master flash can control up to 18 flash units in any combination.

5 : Compose the shot.

- Compose the shot and arrange the flash units. See the documentation provided with the flash units for more information.
- After arranging the units, press the **i** button in the flash info display ( 510) and select [ **Test flash**] to test-fire the units and confirm that they are functioning normally.

6 : Take the photograph.

Adding a Shoe-Mounted Flash Unit

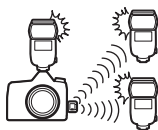

Radio-controlled flash units (📖 479) can be combined with any of the following flash units mounted on the camera accessory shoe:



- **SB-5000:** Before attaching the flash unit, set it to radio-controlled master flash mode (a 📶 icon will appear at the top left corner of the display) and choose group or remote repeating flash control. Once the unit is attached, settings can be adjusted using the controls on the flash unit or the options listed in the camera menus under **[Group flash options] > [Master flash]** or under “M” in the **[Remote repeating options]** display.
- **SB-910, SB-900, SB-800, SB-700, SB-600:** Configure the flash for standalone use and use the controls on the flash unit to adjust flash settings.
- **SB-500, SB-400, SB-300:** Mount the unit on the camera and adjust settings using the **[Group flash options] > [Master flash]** item in the camera menus.

Optical AWL

Remote flash units can be controlled via optical signals from an optional flash unit mounted on the camera accessory shoe and functioning as a master flash (optical AWL; for information on compatible flash units, see

“The Nikon Creative Lighting System”,  798). If the flash unit in question is an SB-5000 or SB-500, settings can be adjusted from the camera ( 495); otherwise settings must be adjusted using flash unit controls as described in the documentation provided with the unit. For information on flash placement and other topics, see the documentation provided with the flash units.

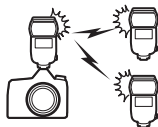

Using Optical AWL with the SB-5000 or SB-500

Mount the flash unit on the camera accessory shoe and select [**Optical AWL**] for [**Flash control**] > [**Wireless flash options**] in the photo shooting menu. Group flash settings can be adjusted using [**Flash control**] > [**Remote flash control**]; the [**Remote flash control**] item for the SB-5000 also offers [**Quick wireless control**] and [**Remote repeating**] settings.

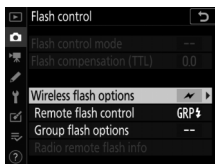

✓ The SB-5000

When an SB-5000 is mounted on the camera accessory shoe, [**Flash control**] settings can also be changed using the controls on the flash unit.

■ Group Flash

Select this item to adjust settings separately for each group.

1 📷: Select [Group flash].

Select [**Group flash**] for [**Flash control**] > [**Remote flash control**] in the photo shooting menu.

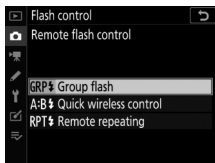

2 📷: Select [Group flash options].

Highlight [**Group flash options**] in the flash control display and press .

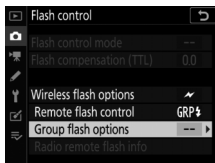

3 : Adjust flash settings.

- Choose the flash control mode and flash level for the master flash and the flash units in each group:

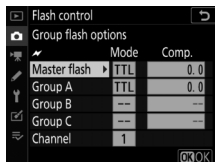

Option	Description
TTL	i-TTL flash control.
 A	Auto aperture (available only with compatible flash units).
M	Choose the flash level manually.
-- (off)	The units do not fire and the flash level cannot be adjusted.

- Choose a channel for the master flash. If the remote flash units include an SB-500, you must choose channel 3, but otherwise you can choose any channel between 1 and 4.

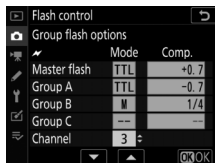



4 : Set the remote flash units to the same channel as the master flash.

Set the remote flash units to the channel selected in Step 3.

5 : Group the remote flash units.

- Choose a group (A, B, or C, or if you are using an SB-500 master flash, A or B) for each remote flash unit.
- Although there is no limit on the number of remote flash units that may be used, the practical maximum is three per group. With more than this number, the light emitted by the remote flash units will interfere with performance.

6 / : Compose the shot.

- Compose the shot and arrange the flash units. See the documentation provided with the flash units for more information.
- After arranging the units, press the test button on the master flash to test-fire the flash and confirm that the units are functioning normally. Flash units can also be test-fired by pressing the **i** button in the flash info display ( 510) and selecting [ **Test flash**].

7 / : Take the photograph.

Take the photograph after confirming that the flash-ready lights for all flash units are lit.

■ Quick Wireless Control (SB-5000 Only)

Select this item to control overall flash compensation for, and the relative balance between, groups A and B, while setting output for group C manually.

1 : Select [Quick wireless control].

Select [Quick wireless control] for [Flash control] > [Remote flash control] in the photo shooting menu.

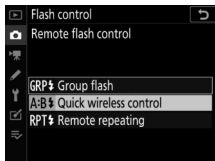

2 : Select [Quick wireless control options].

Highlight [Quick wireless control options] in the flash control display and press .

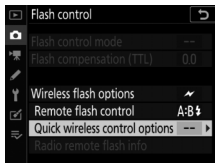

3 Adjust flash settings.

- Choose the balance between groups A and B.

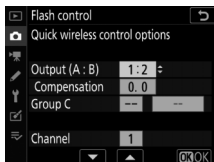

- Adjust flash compensation for groups A and B.

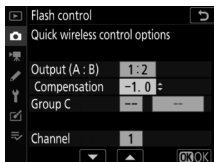

- Choose a flash control mode and flash level for the units in group C:

- **[M]**: Choose the flash level manually.

- **[---]**: The units in group C do not fire.

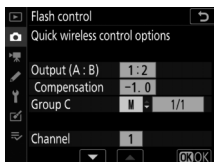

- Choose a channel for the master flash. If the remote flash units include an SB-500, you must choose channel 3, but otherwise you can choose any channel between 1 and 4.

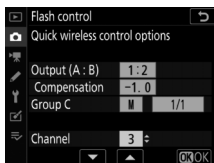



4 : Set the remote flash units to the same channel as the master flash.

Set the remote flash units to the channel selected in Step 3.

5 : Group the remote flash units.

- Choose a group (A, B, or C).
 - Although there is no limit on the number of remote flash units that may be used, the practical maximum is three per group. With more than this number, the light emitted by the remote flash units will interfere with performance.
-

6 /: Compose the shot.

- Compose the shot and arrange the flash units. See the documentation provided with the flash units for more information.
 - After arranging the units, press the test button on the master flash to test-fire the flash and confirm that the units are functioning normally. Flash units can also be test-fired by pressing the  button in the flash info display ( 510) and selecting [ **Test flash**].
-

7 /: Take the photograph.

Take the photograph after confirming that the flash-ready lights for all flash units are lit.

■ Remote Repeating (SB-5000 Only)

When “remote repeating” is enabled, the flash units fire repeatedly while the shutter is open, producing a multiple-exposure effect.

1 Select [Remote repeating].

Select **[Remote repeating]** for **[Flash control]** > **[Remote flash control]** in the photo shooting menu.

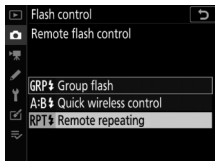

2 Select [Remote repeating options].

Highlight **[Remote repeating options]** in the flash control display and press .

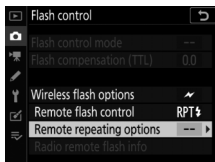

3 : Adjust flash settings.

- Choose the flash level ([**Output**]), the maximum number of times the flash units fire ([**Times**]), and the number of times the flash units fire per second ([**Frequency**]).
- Enable or disable selected groups. Select [**ON**] to enable the selected group, [—] to disable the selected group.
- Choose a channel for the master flash. If the remote flash units include an SB-500, you must choose channel 3, but otherwise you can choose any channel between 1 and 4.

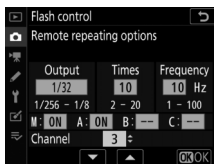
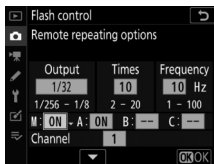
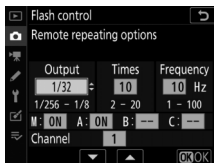

4 : **Set the remote flash units to the same channel as the master flash.**

Set the remote flash units to the channel selected in Step 3.

5 : **Group the remote flash units.**

- Choose a group (A, B, or C) for each remote flash unit.
 - Although there is no limit on the number of remote flash units that may be used, the practical maximum is three per group. With more than this number, the light emitted by the remote flash units will interfere with performance.
-

6 : **Compose the shot.**

- Compose the shot and arrange the flash units. See the documentation provided with the flash units for more information.
- After arranging the units, press the test button on the master flash to test-fire the flash and confirm that the units are functioning normally. Flash units can also be test-fired by pressing the **i** button in the flash info display (📖 510) and selecting [**⚡ Test flash**].

7 : Take the photograph.

Take the photograph after confirming that the flash-ready lights for all flash units are lit.

Optical AWL

Position the sensor windows on the remote flash units to pick up the light from the master flash (particular care is required if the camera is not mounted on a tripod). Be sure that direct light or strong reflections from the remote flash units do not enter the camera lens (in TTL mode) or the photocells on the remote flash units (A mode), as this may interfere with exposure. To prevent low-intensity timing flashes emitted by the master flash from appearing in photographs taken at short range, choose low ISO sensitivities or small apertures (high f-numbers). After positioning the remote flash units, take a test shot and view the results in the camera display.

Optical/Radio AWL

Optical and radio AWL can be used together. Radio flash control is provided by a WR-R10 connected to the camera, optical control by an SU-800 wireless Speedlight commander or an SB-910, SB-900, SB-800, SB-700, or SB-500 flash unit mounted on the camera accessory shoe.

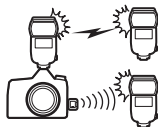

- Before proceeding, establish a wireless connection between the radio-controlled flash units and the WR-R10 (📖 479).
- If an SB-500 is mounted on the camera accessory shoe, select [**Optical/radio AWL**] for [**Flash control**] > [**Wireless flash options**] in the photo shooting menu; with other flash units or the SU-800, this option is selected automatically.
- The only option available for [**Remote flash control**] will be [**Group flash**].
- Choose a group (A–F) for each of the remote flash units. Place optically-controlled flash units in groups A through C and radio-controlled units in groups D through F (to display options for groups D through F, press ⏪ or ⏩ in the [**Group flash options**] display).

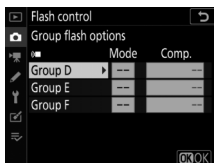

Flash Info for Remote Units

The camera can display flash info for SB-5000 and SB-500 flash units mounted on the camera accessory shoe and configured as a master flash for optical AWL, as well as for remote flash units controlled via radio AWL using a WR-R10. To view flash info during viewfinder photography, press the **Info** button to activate the information display (☞ 68) and then press the **Info** button again.

Flash Control Mode Displays

■ Group Flash

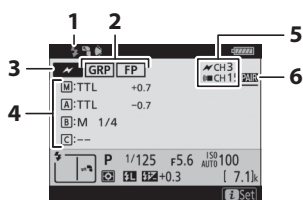

- 1 Flash-ready indicator¹
- 2 Remote flash control (☞ 566)
FP indicator (☞ 618)
- 3 Remote flash control mode²
(☞ 566)
- 4 Group flash control mode³
Group flash mode (☞ 484,
496)
Flash compensation/flash
level (output; ☞ 484, 496)
- 5 Channel² (☞ 479, 496)
- 6 Link mode⁴ (☞ 689)

Quick Wireless Control

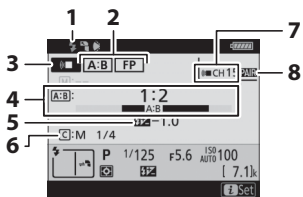

- 1 Flash-ready indicator¹
- 2 Remote flash control (☞ 566)
- 3 Remote flash control mode² (☞ 566)
- 4 A : B ratio (☞ 487, 499)
- 5 Flash compensation (☞ 487, 499)
- 6 Group C flash control mode and flash level (output; ☞ 487, 499)
- 7 Channel² (☞ 479, 499)
- 8 Link mode⁴ (☞ 689)

Remote Repeating

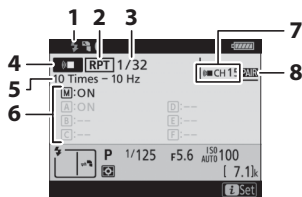

- 1 Flash-ready indicator¹
- 2 Remote flash control (☐ 566)
- 3 Flash level (output; ☐ 490, 502)
- 4 Remote flash control mode² (☐ 566)
- 5 Number emitted (times; ☐ 490, 502)
Frequency (☐ 490, 502)
- 6 Group status (enabled/disabled; ☐ 490, 502)
- 7 Channel² (☐ 479, 502)
- 8 Link mode⁴ (☐ 689)

- 1 Displayed in radio AWL when all flash units are ready.
- 2 Optical AWL is indicated by ⚡, radio AWL by ☐, joint optical and radio AWL by ⚡☐ and ☐⚡. Optical AWL channel for joint optical and radio AWL is displayed only when SB-500 is used as master flash.
- 3 Icons are displayed for each group when joint optical and radio AWL is used.
- 4 Displayed only when radio AWL or joint optical and radio AWL is used.

✓ Flash Info and Camera Settings

The flash information display shows selected camera settings, including shooting mode, shutter speed, aperture, and ISO sensitivity.



✓ Changing Flash Settings

Flash settings can be changed by pressing the **i** button in the flash info display. The options available vary with the flash unit and the settings selected. You can also test-fire the flash.

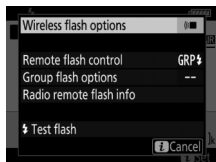

Menu Guide

Defaults

The defaults for the playback, photo shooting, movie shooting, Custom Settings, and setup menus are listed below.

Playback Menu Defaults

Playback menu option	Default
[Delete]	—
[Playback folder]	All
[Playback display options]	
[Focus point]	<input type="checkbox"/>
[Exposure info]	<input type="checkbox"/>
[Highlights]	<input type="checkbox"/>
[RGB histogram]	<input type="checkbox"/>
[Shooting data]	<input type="checkbox"/>
[Overview]	<input type="checkbox"/>
[None (image only)]	<input type="checkbox"/>
[Copy image(s)]	—
[Image review]	Off
[After delete]	Show next
[Rotate tall]	On
[Slide show]	
[Image type]	Still images and movies
[Frame interval]	2 s
[Rating]	—

Photo Shooting Menu Defaults



Photo shooting menu option	Default
[Reset photo shooting menu]	—
[Storage folder]	
[Rename]	ND780
[Select folder by number]	100
[Select folder from list]	—
[File naming]	DSC
[Role played by card in Slot 2]	Overflow
[Image area]	
[Choose image area]	FX (36×24)
[Auto DX crop]	On
[Viewfinder mask display]	Off
[Image quality]	JPEG normal
[Image size]	Large
[NEF (RAW) recording]	
[NEF (RAW) compression]	Lossless compressed
[NEF (RAW) bit depth]	14-bit
[ISO sensitivity settings]	
[ISO sensitivity]	
 AUTO, EFCT	Auto
P, S, A, M	100
[Auto ISO sensitivity control]	On
[Maximum sensitivity]	51200
[Maximum sensitivity with 	Same as without flash
[Minimum shutter speed]	Auto

Photo shooting menu option	Default
[White balance]	Auto: Keep overall atmosphere
[Fine-tune]	A-B: 0, G-M: 0
[Choose color temperature]	5000 K
[Preset manual]	d-1
[Set Picture Control]	Auto
[Manage Picture Control]	—
[Color space]	sRGB
[Active D-Lighting]	Off
[Long exposure NR]	Off
[High ISO NR]	Normal
[Vignette control]	Normal
[Diffraction compensation]	On
[Auto distortion control]	Off
[Flicker reduction]	
[Flicker reduction setting]	Disable
[Flicker reduction indicator]	On
[Flash control]	
[Flash control mode]	TTL
[Wireless flash options]	Off
[Remote flash control]	Group flash
[Auto bracketing]	
[Auto bracketing set]	AE & flash bracketing
[Number of shots]	0
[Increment]	1.0

Photo shooting menu option	Default
[Multiple exposure]*	
[Multiple exposure mode]	Off
[Number of shots]	2
[Overlay mode]	Average
[Save individual images (NEF)]	On
[Overlay shooting]	On
[Select first exposure (NEF)]	—
[HDR (high dynamic range)]	
[HDR mode]	Off
[HDR strength]	Auto
[Save individual images (NEF)]	Off
[Interval timer shooting]	
[Choose start day/time]	Now
[Interval]	1 min
[Intervals×shots/interval]	0001×1
[Exposure smoothing]	On
[Silent photography]	On
[Interval priority]	Off
[Focus before each shot]	Off
[Options]	Off
[Starting storage folder]	
[New folder]	<input type="checkbox"/>
[Reset file numbering]	<input type="checkbox"/>

Photo shooting menu option	Default
[Time-lapse movie]	
[Interval]	5 s
[Shooting time]	25 min.
[Exposure smoothing]	On
[Silent photography]	On
[Image area]	
[Choose image area]	FX
[Auto DX crop]	On
[Frame size/frame rate]	1920×1080; 60p
[Interval priority]	Off
[Focus before each shot]	Off
[Destination]	Slot 1
[Focus shift shooting]	
[No. of shots]	100
[Focus step width]	5
[Interval until next shot]	0
[First-frame exposure lock]	On
[Silent photography]	On
[Starting storage folder]	
[New folder]	<input type="checkbox"/>
[Reset file numbering]	<input type="checkbox"/>
[Silent live view photography]	Off

* Photo shooting menu reset is not available while a multiple exposure is in progress.

Movie Shooting Menu Defaults

Movie shooting menu option	Default
[Reset movie shooting menu]	—
[File naming]	DSC
[Destination]	Slot 1
[Image area]	
[Choose image area]	FX
[Auto DX crop]	On
[Frame size/frame rate]	1920×1080; 60p
[Movie quality]	High quality
[Movie file type]	MOV
[ISO sensitivity settings]	
[Maximum sensitivity]	51200
[Auto ISO control (mode M)]	On
[ISO sensitivity (mode M)]	100
[White balance]	Same as photo settings
[Fine-tune]	A-B: 0, G-M: 0
[Choose color temperature]	5000 K
[Preset manual]	d-1
[Set Picture Control]	Same as photo settings
[Manage Picture Control]	—
[Active D-Lighting]	Off
[High ISO NR]	Normal

Movie shooting menu option	Default
[Diffraction compensation]	On
[Flicker reduction]	Auto
[Electronic VR]	Off
[Microphone sensitivity]	Auto
[Attenuator]	Disable
[Frequency response]	Wide range
[Wind noise reduction]	Off
[Headphone volume]	15
[Timecode]	
[Record timecodes]	Off
[Count-up method]	Record run
[Timecode origin]	—
[Drop frame]	On





Custom Settings Menu Defaults

Custom Settings menu option		Default
[Reset custom settings]		—
a1	[AF-C priority selection]	Release
a2	[AF-S priority selection]	Focus
a3	[Focus tracking with lock-on]	3
a4	[3D-tracking face-detection]	On
a5	[Auto-area AF face/eye detection]	Face and eye detection on
a6	[Focus points used]	All points
a7	[Store points by orientation]	No
a8	[AF activation]	Shutter/AF-ON
a9	[Focus point wrap-around]	No wrap
a10	[Focus point options]	
	[Focus point illumination]	Auto
	[Manual focus mode]	On
	[Dynamic-area AF assist]	On
a11	[Low-light AF]	Off
a12	[Manual focus ring in AF mode]	Enable
b1	[EV steps for exposure cntrl]	1/3 step
b2	[Easy exposure compensation]	Off
b3	[Matrix metering]	Face detection on
b4	[Center-weighted area]	φ12 mm
b5	[Fine-tune optimal exposure]	
	[Matrix metering]	0
	[Center-weighted metering]	0
	[Spot metering]	0
	[Highlight-weighted metering]	0

	Custom Settings menu option	Default
c1	[Shutter-release button AE-L]	Off
c2	[Standby timer]	6 s
c3	[Self-timer]	
	[Self-timer delay]	10 s
	[Number of shots]	1
	[Interval between shots]	0.5 s
c4	[Monitor off delay]	
	[Playback]	10 s
	[Menus]	1 min
	[Information display]	10 s
	[Image review]	4 s
	[Live view]	10 min
d1	[CL mode shooting speed]	3 fps
d2	[Max. continuous release]	100
d3	[Sync. release mode options]	Sync
d4	[Exposure delay mode]	Off
d5	[Electronic front-curtain shutter]	Disable
d6	[Extended shutter speeds (M)]	Off
d7	[File number sequence]	On
d8	[Save original (EFFECTS)]	Off
d9	[Exposure preview (Lv)]	Off
d10	[Framing grid display]	Off

Custom Settings menu option		Default
d11	[Peaking highlights]	
	[Peaking level]	Off
	[Peaking highlight color]	Red
d12	[LCD illumination]	Off
d13	[Live view in continuous mode]	On
d14	[Optical VR]	On
e1	[Flash sync speed]	1/200 s
e2	[Flash shutter speed]	1/60 s
e3	[Exposure comp. for flash]	Entire frame
e4	[Auto $\frac{1}{2}$ ISO sensitivity control]	Subject and background
e5	[Modeling flash]	On
e6	[Bracketing order]	MTR > under > over
f1	[Customize  Menu]	Set Picture Control, Image quality, Flash mode, Wi-Fi connection, Autofocus mode, Choose image area, White balance, Image size, Metering, Active D-Lighting, AF-area mode, Custom controls

	Custom Settings menu option	Default
f2	[Customize  Menu (Lv)]	Set Picture Control, Image quality, Flash mode, Wi-Fi connection, Autofocus mode, Negative digitizer, White balance, Image size, Metering, Active D-Lighting, AF-area mode, Exposure preview
f3	[Custom controls]	
	[Preview button]	Preview
	[Fn button]	Choose image area
	[AE-L/AF-L button]	AE/AF lock
	[AF-ON button]	AF-ON
	[BKT button]	Auto bracketing
	[Movie record button]	None
f4	[OK button]	
	[Viewfinder photography]	Select center focus point
	[Live view]	Select center focus point
	[Playback mode]	Zoom on/off
	[Zoom on/off]	1 : 1 (100%)

	Custom Settings menu option	Default
f5	[Customize command dials]	
	[Reverse rotation]	Exposure compensation: <input type="checkbox"/> Shutter speed/aperture: <input type="checkbox"/>
	[Change main/sub]	Exposure setting: Off, Autofocus setting: Off
	[Aperture setting]	Sub-command dial
	[Menus and playback]	Off
	[Sub-dial frame advance]	10 frames
f6	[Release button to use dial]	No
f7	[Reverse indicators]	
f8	[ switch]	LCD backlight ()
g1	[Customize  Menu]	Set Picture Control, Frame size and rate/ Image quality, Wind noise reduction, Wi-Fi connection, Autofocus mode, Destination, White balance, Microphone sensitivity, Metering, Active D-Lighting, AF-area mode, Electronic VR

	Custom Settings menu option	Default
g2	[Custom controls]	
	[Preview button]	None
	[Fn button]	None
	[AE-L/AF-L button]	AE/AF lock
	[AF-ON button]	AF-ON
	[Shutter-release button]	Take photos
g3	[AF speed]	0
	[When to apply]	Always
g4	[AF tracking sensitivity]	4
g5	[Highlight display]	
	[Display pattern]	Off
	[Highlight display threshold]	248

Setup Menu Defaults

Setup menu option	Default
[Format memory card]	—
[Save user settings]	—
[Reset user settings]	—
[Language]	(Default varies with country of purchase)
[Time zone and date]	
[Time zone]	(Default varies with country of purchase)
[Date and time]	—
[Date format]	(Default varies with country of purchase)
[Daylight saving time]	Off
[Monitor brightness]	0
[Monitor color balance]	A-B: 0, G-M: 0
[Virtual horizon]	—
[Information display]	Auto
[Manual]	Dark on light
[AF fine-tuning options]	
[AF fine-tune on/off]	Off
[Fine-tune and save lens]	—
[Default]	—
[List saved values]	—

Setup menu option	Default
[Non-CPU lens data]	
[Lens number]	1
[Focal length (mm)]	—
[Maximum aperture]	—
[Clean image sensor]	
[Clean at startup/shutdown]	Clean at startup & shutdown
[Lock mirror up for cleaning]	—
[Image Dust Off ref photo]	—
[Pixel mapping]	—
[Image comment]	
[Attach comment]	<input type="checkbox"/>
[Copyright information]	
[Attach copyright information]	<input type="checkbox"/>
[Beep options]	
[Beep on/off]	Off
[Volume]	2
[Pitch]	Low
[Touch controls]	
[Enable/disable touch controls]	Enable
[Full-frame playback flicks]	Left → Right

Setup menu option	Default
[HDMI]	
[Output resolution]	Auto
[Advanced]	
[Output range]	Auto
[External recording control]	Off
[Output data depth]	8 bit
[N-Log/HDR output options]	Off
[View assist]	Off
[Location data]	
[Standby timer]	Enable
[Position]	—
[Set clock from satellite]	Yes
[Wireless remote (WR) options]	
[LED lamp]	On
[Link mode]	Pairing
[Assign remote (WR) Fn button]	None
[Airplane mode]	Disable
[Connect to smart device]	
[Pairing (Bluetooth)]	
[Bluetooth connection]	Disable
[Select to send (Bluetooth)]	
[Auto select to send]	Off
[Wi-Fi connection]	—
[Send while off]	On

Setup menu option	Default
[Connect to PC]	
[Wi-Fi connection]	Disable
[Network settings]	—
[Options]	
[Auto send]	Off
[Delete after send]	No
[Send file as]	NEF (RAW) + JPEG
[Deselect all?]	—
[MAC address]	—



Setup menu option	Default
[Wireless transmitter (WT-7)]	
[Wireless transmitter]	Do not use
[Choose hardware]	Wired LAN
[Network settings]	—
[Options]	
[Auto send]	Off
[Delete after send]	No
[Send file as]	NEF (RAW) + JPEG
[Overwrite if same name]	No
[Protect if marked to send]	No
[Send marking]	Off
[Send folder]	—
[Deselect all?]	—
[HTTP user settings]	—
[Battery info]	—
[Power saving]	Prioritize network speed
[Auto power off delay]	—
[MAC address]	—
[Firmware version]	—
[Conformity marking]	—
[Battery info]	—
[Slot empty release lock]	Enable release
[Save/load menu settings]	—
[Reset all settings]	—
[Firmware version]	—

The Playback Menu: Managing Images

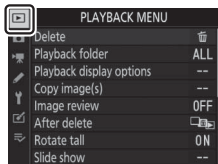
To display the playback menu, select the  (playback menu) tab in the camera menus.





The playback menu contains the following items:

Item		Item	
[Delete]	530	[After delete]	539
[Playback folder]	530	[Rotate tall]	540
[Playback display options]	531	[Slide show]	540
[Copy image(s)]	532	[Rating]	543
[Image review]	538		

Delete

MENU button ➡  playback menu

Delete multiple images. For more information, see “The Playback Menu” (📖 385).

Option	Description
 [Selected]	Delete selected pictures.
 [Select date]	Delete all pictures taken on selected dates.
ALL [All]	Delete all pictures in the folder currently selected for [Playback folder] in the playback menu. <ul style="list-style-type: none">• If two memory cards are inserted, you can select the card from which pictures will be deleted.

Playback Folder

MENU button ➡  playback menu

Choose a folder for playback.



Option	Description
(Folder name)	Pictures in all folders with the selected name will be visible during playback. Folders can be renamed using the [Storage folder] > [Rename] option in the photo shooting menu.
[All]	Pictures in all folders will be visible during playback.
[Current]	Only pictures in the current folder will be visible during playback.

Playback Display Options

MENU button ➡  playback menu

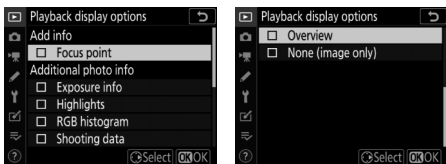
Choose whether the focus points used when the photograph was taken are displayed during full-frame playback. You can also choose the types of photo information that can be viewed during full-frame playback.



- Highlight options and press  to select () or deselect (.
- To complete the operation, press .

Copy Image(s)

MENU button ➡  playback menu

Copy pictures from one memory card to another when two memory cards are inserted.

Option	Description
[Select source]	Choose the card from which pictures will be copied.
[Select image(s)]	Select pictures to be copied.
[Select destination folder]	Select the destination folder on the remaining card (the card not selected for [Select source]).
[Copy image(s)?]	Copy the pictures.

Copying Pictures

1 Choose [Select source].

Highlight [**Select source**] and press  to display the [**Select source**] dialog.

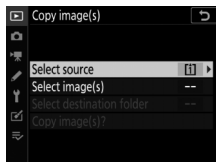

2 Select the card containing the pictures to be copied.

Highlight the slot for the card containing the pictures to be copied and press  to select the highlighted slot and return to the [**Copy image(s)**] menu.

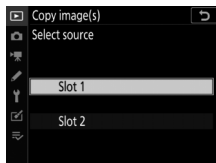

3 Choose [Select image(s)].

Highlight [**Select image(s)**] and press  to select the highlighted option and return to the [**Select image(s)**] menu.

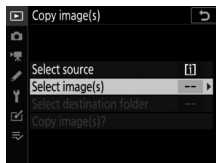

4 Select the source folder.

- Highlight the folder containing the images to be copied and press **▶** to select the highlighted folder and display the [**Images selected by default**] menu.
- To copy all pictures from the card in the selected slot, highlight [**All images in slot**], press **OK**, and proceed to Step 10.

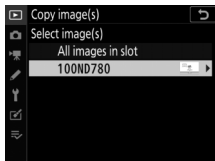





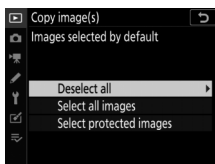

5 Make the initial selection.

Choose the pictures that will be selected by default.



Option	Description
[Deselect all]	None of the pictures in the chosen folder will be selected by default. <ul style="list-style-type: none">• Choose this option when you want to select pictures individually.
[Select all images]	All of the pictures in the chosen folder will be selected by default. <ul style="list-style-type: none">• Choose this option if you want to copy all or most of the pictures in the folder.
[Select protected images]	Only the protected images in the folder will be selected by default.

6 Select additional images.

- Highlight pictures and press the  () button to select; selected pictures are marked with a ✓. To deselect the current picture, press the  () button again; the ✓ will no longer be displayed.
- To view the highlighted picture full screen, press and hold the  (**QUAL**) button.
- After confirming that all the pictures you want to copy have ✓ marks, press  to return to the **[Copy image(s)]** menu.



7 Choose [Select destination folder].

Highlight **[Select destination folder]** and press  to display the **[Select destination folder]** menu.

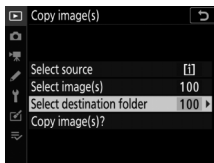

8 Choose a destination folder.

Choose one of the following options and press .

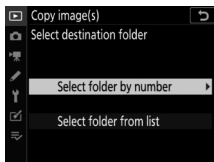

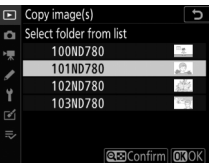
Option	Description
[Select Folder by Number]	Enter the number of the destination folder (📖 546). If the folder with the selected number does not already exist, a new folder will be created. 
[Select Folder from List]	Choose the destination folder from a list of existing folders. 

9 Select the folder.

After entering a folder number or highlighting the folder name, press  to select the folder and return to the **[Copy image(s)]** menu.

10 Choose [Copy image(s)].

Highlight [**Copy image(s)?**] and press **OK** to display a confirmation dialog.

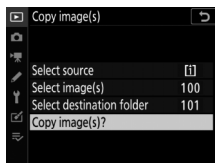

11 Choose [Yes].

- The camera will display the message "[**Copy?**]" together with the number of pictures that will be copied.
- Highlight [**Yes**] and press **OK** to copy the selected pictures.
- Press **OK** again to exit when copying is complete.



✔ Copying Pictures

- Pictures will not be copied if there is insufficient space on the destination card.
- If the destination folder contains a file with the same name as one of the pictures to be copied, a confirmation dialog will be displayed. Select [**Replace existing image**] or [**Replace all**] to replace the existing file or files. Protected files in the destination folder will not be replaced. To continue without replacing existing files, select [**Skip**]. Select [**Cancel**] to exit without copying any further pictures.
- Ratings and protected status are copied with the pictures.
- To prevent loss of power while copying is in progress, be sure the battery is fully charged before copying movies.

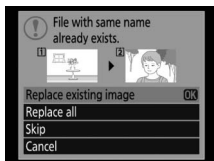



Image Review



MENU button ➡  playback menu

Choose whether pictures are automatically displayed in the monitor immediately after shooting. If [**Off**] is selected, pictures can only be displayed by pressing the  button.

After Delete

MENU button ➡  playback menu

Choose the picture displayed after an image is deleted.

	Option	Description
	[Show next]	<ul style="list-style-type: none">• The following picture is displayed.• If the deleted image was the last picture, the preceding picture will be displayed.
	[Show previous]	<ul style="list-style-type: none">• The preceding picture is displayed.• If the deleted image was the first picture, the next picture will be displayed.
	[Continue as before]	<ul style="list-style-type: none">• If you were scrolling through pictures in the order recorded, the following picture will be displayed as described for [Show next].• If you were scrolling through pictures in reverse order, the next picture will be displayed as described for [Show previous].

Rotate Tall

MENU button ➡  playback menu

If **[On]** is selected, “tall” (portrait-orientation) pictures will be automatically rotated for display during playback.

✔ Rotate Tall

Images are not rotated automatically during image review even when **[On]** is selected for **[Rotate tall]**.

Slide Show

MENU button ➡  playback menu

View a slide show; pictures are displayed in the order recorded. The pictures in the folder currently selected for **[Playback folder]** ( 530) will be displayed one-by-one in the order recorded.

Option	Description
[Start]	Start the slide show.
[Image type]	<ul style="list-style-type: none">• Choose the type of picture displayed.• Select [By rating] to view only pictures with selected ratings. Highlight ratings and press  to select (<input checked="" type="checkbox"/>) or deselect (<input type="checkbox"/>)
[Frame interval]	Choose how long each picture will be displayed.

Viewing Slide Shows

To start the slide show, highlight **[Start]** and press **OK**.

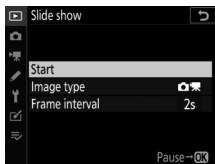

The following operations can be performed while the show is in progress:

To	Description
Skip back/skip ahead	Press ⏮ to return to the previous frame, ⏭ to skip to the next frame.
View additional photo info	If more than one page of photo info is selected for [Playback display options] in the playback menu, you can press ⏴ or ⏵ during full-frame playback to choose the information displayed.
Pause	Press OK to pause the slide show. To restart, highlight [Restart] and press OK .
Adjust volume	Press QUAL to increase volume, QUAL (🔊) to decrease.
Exit to the playback menu	Press MENU to end the slide show and return to the playback menu.
Exit to playback mode	Press ▶ to end the slide show and exit to playback.
Exit to shooting mode	Press the shutter-release button halfway to return to shooting mode.







A dialog is displayed when the show ends. To restart, highlight [**R**estart] and press **OK**. To end the show, highlight [**E**xit] and press **OK**.



Rating

MENU button ➡  playback menu

Rate pictures.

- Highlight pictures using the multi selector.
- Hold the  () button and press  or  to choose a rating of from zero to five stars, or select  to mark the picture as a candidate for later deletion.
- To view the highlighted picture full screen, press and hold the  (**QUAL**) button.
- Press  to save changes.



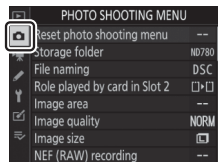

The Photo Shooting Menu: Shooting Options

To view the photo shooting menu, select the  tab in the camera menus.



The photo shooting menu contains the following items:

Item		Item	
[Reset photo shooting menu]	545	[Long exposure NR]	556
[Storage folder]	545	[High ISO NR]	557
[File naming]	545	[Vignette control]	558
[Role played by card in Slot 2]	551	[Diffraction compensation]	559
[Image area]	551	[Auto distortion control]	560
[Image quality]	551	[Flicker reduction]	561
[Image size]	551	[Flash control]	563
[NEF (RAW) recording]	552	[Auto bracketing]	567
[ISO sensitivity settings]	553	[Multiple exposure]	569
[White balance]	553	[HDR (high dynamic range)]	569
[Set Picture Control]	553	[Interval timer shooting]	569
[Manage Picture Control]	554	[Time-lapse movie]	570
[Color space]	554	[Focus shift shooting]	570
[Active D-Lighting]	555	[Silent live view photography]	570

Reset Photo Shooting Menu

MENU button ➡ 📷 photo shooting menu

Restore photo shooting menu options to their default values (📖 512).

Storage Folder

MENU button ➡ 📷 photo shooting menu

Choose the folder in which subsequent pictures will be stored.

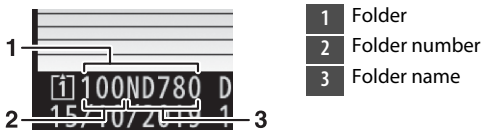

Renaming Folders

The default folder name, which appears after the folder number, is “ND780”. To change the name assigned to new folders, select **[Rename]**.

- Existing folders cannot be renamed.
- If desired, the default name can be restored for subsequent folders by pressing and holding the  (FORMAT) button while the keyboard is displayed.

Select Folder by Number

The folder in which subsequent pictures will be stored can be selected by number. If a folder with the specified number does not already exist, a new folder will be created.

1 Choose [Select folder by number].







- Highlight [Select folder by number] and press \blacktriangleright to display the [Select folder by number] dialog.
- The card on which the new folder will be created is underlined in the card slot display area at the top right corner of the [Select folder by number] dialog. The card used for new folders depends on the option currently selected for [Role played by card in Slot 2].







2 Choose a folder number.

- Press \blacktriangleleft or \blacktriangleright to highlight digits.
- To change the highlighted digit, press \blacktriangleup or \blacktriangledown .

3 Save changes and exit.

- If a folder with the selected number already exists, a , , or  icon will be displayed to the left of the folder number. Press  to complete the operation and return to the main menu; if you chose a folder marked  or , it will be selected as the folder for new pictures.
- If you chose a folder number that does not already exist, a new folder will be created with that number when you press .
- In either case, subsequent pictures will be stored in the chosen folder.
- To exit without changing the storage folder, press the **MENU** button.

Folder Icons

Folders in the [**Select folder by number**] dialog are shown by  if empty, by  if full (containing either 5000 pictures or a picture numbered 9999), or by  if partially full. A  icon indicates that no further pictures can be stored in the folder.

Select Folder from List



To choose from a list of existing folders:

1 Choose [Select folder from list].

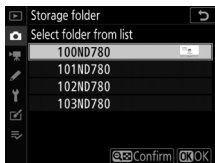
Highlight [Select folder from list] and press  to display the [Select folder from list] dialog.



2 Highlight a folder.

Press  or  to highlight a folder.

3 Select the highlighted folder.

- Press  to select the highlighted folder and return to the main menu.
- Subsequent photographs will be stored in the selected folder.

✔ Folder and File Numbers

- Once the folder number has reached 999, the camera will stop creating new folders automatically and disable the shutter release if:
 - The number of files in the folder reaches 5000 (or during movie recording, if camera calculates that the addition of the number of files needed to create a movie of maximum length would bring the total over 5000)
 - The file number reaches 9999 (or during movie recording, when camera calculates that the number of files needed to create a movie of maximum length would result in a file numbered higher than 9999)
- If there is space on the memory card, you will nevertheless be able to continue shooting by:
 - Creating a folder with a number less than 999 and selecting it as the storage folder
 - Changing the options selected for [**Frame size/frame rate**] and [**Movie quality**] before recording movies

✔ Startup Time

Additional time may be required for camera startup if the memory card contains a very large number of files or folders.

File Naming

MENU button →  photo shooting menu

Pictures are saved using file names consisting of “DSC_” followed by a four-digit number and a three-letter extension. **[File naming]** is used to select three letters to replace the “DSC” portion of the file name. For information on text entry, see “Text Entry” (📖 61).

✔ File Names

- File names take the form “DSC_nnnn.xxx”. nnnn is a number from 0001 to 9999. xxx is one of the following extensions, assigned according to the options selected for image quality and file type:
 - NEF: NEF (RAW) photos
 - JPG: JPEG (fine, normal, or basic) photos
 - MOV: MOV movies
 - MP4: MP4 movies
 - NDF: Dust off reference data
- Images created with **[Adobe RGB]** selected for **[Color space]** have file names of the form “_DSCnnnn.xxx”.
- In each pair of photographs recorded at image-quality settings of NEF (RAW)+JPEG, the NEF and JPEG images have the same file names but different extensions.

Role Played by Card in Slot 2

MENU button ➡  photo shooting menu

Choose the role played by the card in Slot 2 when two memory cards are inserted in the camera. For more information, see “Using Two Memory Cards” (📖 279).

Image Area

MENU button ➡  photo shooting menu

Adjust image area settings. For more information, see “Adjusting Image Area Settings” (📖 129).

Image Quality

MENU button ➡  photo shooting menu

Choose a file format for photographs. For more information, see “Adjusting Image Quality” (📖 134).

Image Size

MENU button ➡  photo shooting menu



Choose the size, in pixels, of pictures recorded with the camera. For more information, see “Choosing an Image Size” (📖 137).

NEF (RAW) Recording

MENU button →  photo shooting menu

Choose a compression type and bit depth for NEF (RAW) photographs.

NEF (RAW) Compression

	Option	Description
ON 	[Lossless compressed]	NEF images are compressed using a reversible algorithm. The resulting files are about 60% to 80% the size of uncompressed pictures.
ON 	[Compressed]	NEF images are compressed using a non-reversible algorithm. The resulting files are about 45% to 65% the size of uncompressed pictures.

NEF (RAW) Bit Depth

	Option	Description
12-bit	[12-bit]	NEF (RAW) images are recorded at a bit depth of 12 bits.
14-bit	[14-bit]	NEF (RAW) images are recorded at a bit depth of 14 bits. Files recorded at a bit depth of 14 bits contain more color data than pictures recorded using [12-bit]. Files recorded at a bit depth of 14 bits are also larger than pictures recorded using [12-bit].

ISO Sensitivity Settings

MENU button ➔  photo shooting menu

Adjust ISO sensitivity settings for photographs. For more information, see “Adjusting the Camera’s Sensitivity to Light (ISO Sensitivity)” (📖 187).

White Balance

MENU button ➔  photo shooting menu

Adjust white balance to match the color of the light source. For more information, see “Achieving Natural Colors with Different Light Sources (White Balance)” (📖 195).

Set Picture Control

MENU button ➔  photo shooting menu

Choose image processing (“Picture Control”) options for new photos according to the scene or your creative intent. For more information, see “Image Processing (Picture Controls)” (📖 243).

Manage Picture Control

MENU button →  photo shooting menu

Save modified Picture Controls as custom Picture Controls. For more information, see “Creating Custom Picture Controls” (📖 250).

Color Space

MENU button →  photo shooting menu

The color space determines the gamut of colors available for color reproduction. [sRGB] is recommended for general-purpose printing and display. With a broader gamut of colors than [sRGB], [Adobe RGB] is a better choice for professional publication and commercial printing.

✔ Color Space

The selected color space may be overwritten when pictures are opened in third-party software. NX Studio can open pictures in the color space selected on the camera.

✔ Adobe RGB

For accurate color reproduction, Adobe RGB images require applications, displays, and printers that support color management.

Active D-Lighting

MENU button ➔  photo shooting menu

Preserve details in highlights and shadows, creating pictures with natural contrast. For more information, see “Active D-Lighting” ( 254).

Long Exposure NR

MENU button →  photo shooting menu

Reduce “noise” (bright spots or fog) in photographs taken at slow shutter speeds.

Option	Description
[On]	Reduce noise in photographs taken at shutter speeds slower than 1 s.
[Off]	Long-exposure noise reduction disabled.

- Long-exposure noise reduction is performed after the photo is taken. During processing, “**Job nr**” will flash in the control panel and viewfinder. Pictures cannot be taken until the display stops flashing. The time required to process photos after shooting roughly doubles.

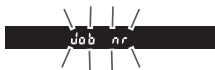
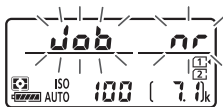

✓ Long-Exposure Noise Reduction

If the camera is turned off before processing is complete, the picture will be saved but noise reduction will not be performed.

High ISO NR

MENU button ➡  photo shooting menu

Photographs taken at high ISO sensitivities can be processed to reduce “noise” (randomly-spaced bright pixels).

Option	Description
[High]	Reduce noise in photographs taken at all ISO sensitivities.
[Normal]	The higher the sensitivity, the greater the effect. Choose the amount of noise reduction performed from [High], [Normal], and [Low].
[Low]	
[Off]	Noise reduction is performed only as required. The amount of noise reduction performed is always lower than when [Low] is selected.

Vignette Control

MENU button →  photo shooting menu

Vignette control reduces “vignetting”—a drop in brightness at the edges of a photograph—by an amount that varies from lens to lens. Its effects are most noticeable at maximum aperture. Vignette control applies only to photographs taken with type G, E, and D lenses (PC lenses excluded).

Option	Description
<input type="checkbox"/> H [High]	Choose the amount of vignette control performed from (in order from high to low) [High], [Normal], and [Low].
<input type="checkbox"/> N [Normal]	
<input type="checkbox"/> L [Low]	
[Off]	Vignette control disabled.

Vignette Control

- Vignette control does not apply to:
 - Pictures taken using the [Multiple exposure] item in the photo shooting menu
 - Movies
- Depending on the scene, shooting conditions, and type of lens, JPEG images may exhibit “noise” (fog) or over-processing at the edge of the frame that introduces variations in peripheral brightness. In addition, custom Picture Controls and preset Picture Controls that have been modified from default settings may not produce the desired effect. Take test shots and view the results in the monitor.

Diffraction Compensation

MENU button ➔  photo shooting menu

Select [**On**] to reduce diffraction at small apertures (high f/-numbers).

- To apply diffraction compensation to pictures taken with non-CPU lenses, enter the lens data using the [**Non-CPU lens data**] item in the setup menu.

Auto Distortion Control

MENU button →  photo shooting menu

Select [**On**] to reduce barrel distortion when shooting with wide-angle lenses and to reduce pin-cushion distortion when shooting with long lenses.

- [**Auto distortion control**] is available only with type G, E, and D lenses. Some lenses of these types, including PC and fisheyes lenses, are, however, not supported. Results are not guaranteed with lenses that are not supported.

✓ Auto Distortion Control

- When [**On**] is selected, the time needed to process photographs before recording begins may increase.
 - The greater the amount of distortion control, the greater the area cropped from the edges of the frame.
 - Before using auto distortion control with DX lenses, choose [**On**] for [**Image area**] > [**Auto DX crop**] or select [**DX (24×16)**] for [**Choose image area**]. Selecting other options may result in heavily cropped photographs or in photographs with severe peripheral distortion.
 - Auto distortion control does not apply to movies.
-

Flicker Reduction

MENU button ➔  photo shooting menu

Reduce the effects of flicker from such light sources as fluorescent or mercury-vapor lamps. Flicker can cause uneven exposure or (in photographs taken in continuous release modes) inconsistent exposure or coloration.

Option	Description
[Flicker reduction setting]	<p>When [Enable] is selected, the camera will time photographs to reduce the effects of flicker.</p> <ul style="list-style-type: none">• Note that the frame rate for burst shooting may drop or become erratic when [Enable] is selected.
[Flicker reduction indicator]	<p>Choose whether a FLICKER icon is displayed in the monitor or viewfinder when [Enable] is selected for [Flicker reduction setting]. When [On] is selected, the FLICKER icon will be displayed at different times during viewfinder and live view photography. The differences are as follows:</p> <ul style="list-style-type: none">• During viewfinder photography, the FLICKER icon is displayed if flicker is detected when the shutter-release button is pressed halfway.• During live view photography, the FLICKER icon will be displayed at all times whether or not flicker has been detected.

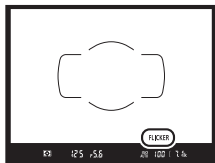

✓ **Flicker Reduction: Restrictions**

The [**Flicker reduction**] item in the photo shooting menu does not take effect under some conditions, including when:

- **MUP** is selected for release mode
- **CH** is selected for release mode during live view photography
- [**On**] is selected for [**Silent live view photography**] in the photo shooting menu during live view photography
- [**On**] is selected for [**Silent photography**] in the respective sub-menu during interval-timer photography, time-lapse movie recording, or focus shift
- HDR is enabled
- Exposure delay mode is on
- Shutter speed is set to **bulb** (bulb) or **- -** (time)

✓ **Flicker Reduction**

- Take a test shot and view the results before taking additional photographs.
 - Depending on the light source, flicker reduction may slightly delay shutter response. During burst shooting, the frame rate may slow or become erratic.
 - Flicker reduction can detect flicker at 100 and 120 Hz (associated respectively with AC power supplies of 50 and 60 Hz). The desired results may not be achieved if the frequency of the power supply changes during burst photography.
 - Flicker may not be detected or the desired results may not be achieved depending on the light source and shooting conditions, for example with scenes that are brightly lit or feature dark backgrounds.
 - The desired results may also not be achieved with decorative lighting displays and other non-standard lighting.
-

Flash Control

MENU button ➡ 📷 photo shooting menu

Choose a flash control mode and flash level and adjust other settings for wireless remote flash units or optional flash units mounted on the camera accessory shoe.

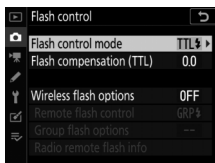

- For information on adjusting settings for optional flash units mounted on the camera accessory shoe, see “On-Camera Flash Photography” (📖 459).
- For information on adjusting settings for wireless remote flash units, see “Remote Flash Photography” (📖 477).

Flash Control Mode



Choose a flash control mode and adjust other settings for SB-5000, SB-500, SB-400, or SB-300 flash units mounted on the camera accessory shoe.

- The options available in the flash control display vary with the option selected for [**Flash control mode**].
- Settings for flash units other than the SB-5000, SB-500, SB-400, and SB-300 can only be adjusted using flash unit controls.
- Settings for an SB-5000 mounted on the accessory shoe can also be adjusted using the controls on the flash unit.

	Option	Description
TTL↕	[TTL]	Flash output is adjusted automatically in response to shooting conditions.
A↕	[Auto external flash]	Flash output is adjusted automatically according to the amount of light reflected by the subject.
GN↕	[Distance-priority manual]	Choose the distance to the subject; flash output will be adjusted automatically.
M↕	[Manual]	Choose the flash level manually.
RPT↕	[Repeating flash]	The flash fires repeatedly while the shutter is open, producing a multiple-exposure effect.

Wireless Flash Options

Adjust settings for simultaneous wireless control of multiple remote flash units. This item is available only when an SB-5000 or SB-500 flash unit or a WR-R10 wireless remote controller is mounted on the camera.

Option		Description
	[Optical AWL]	The remote flash units are controlled using low-intensity flashes emitted by the master flash (☞ 494).
	[Optical/ radio AWL]	Choose this option when using both optically- and radio-controlled flash units (☞ 506).
	[Radio AWL]	The remote flash units are controlled by radio signals from a WR-R10 attached to the camera (☞ 479).
[Off]		Remote flash photography disabled.

Remote Flash Control

Choose the remote flash control mode. Flash options can be adjusted in the flash control display; the options available vary with the option selected for **[Remote flash control]**.

	Option	Description
GRP ↕	[Group flash]	Choose a separate flash control mode for each group of remote flash units (☐ 484, 496).
A:B ↕	[Quick wireless control]	Choose the balance between groups A and B and set the output for group C manually (☐ 487, 499).
RPT ↕	[Remote repeating]	The flash units fire repeatedly while the shutter is open, producing a multiple-exposure effect (☐ 490, 502).

Radio Remote Flash Info

View the flash units currently controlled via radio AWL.

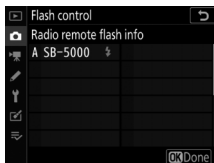

Auto Bracketing

MENU button ➡  photo shooting menu

Vary exposure, flash level, Active D-Lighting (ADL), or white balance slightly with each shot, “bracketing” the current value. Bracketing can be used in situations in which getting the right settings is difficult and there is not time to check results and adjust settings with each shot, or to experiment with different settings for the same subject. For more information, see “Varying Exposure or White Balance over a Series of Photographs (Bracketing)” ( 224).

Option	Description
[Auto bracketing set]	Choose the setting or settings bracketed when auto bracketing is in effect. <ul style="list-style-type: none"> • [AE & flash bracketing]: Perform both exposure and flash-level bracketing. • [AE bracketing]: Bracket only exposure. • [Flash bracketing]: Perform only flash-level bracketing. • [WB bracketing]: Perform white-balance bracketing. • [ADL bracketing]: Perform bracketing using Active D-Lighting.
[Number of shots]	Choose the number of shots in the bracketing sequence.
[Increment]	Choose the amount the selected settings vary with each shot when an option other than [ADL bracketing] is selected for [Auto bracketing set] .
[Amount]	Choose how Active D-Lighting varies with each shot when [ADL bracketing] is selected for [Auto bracketing set] .

Multiple Exposure

MENU button ➔  photo shooting menu

Record two to ten NEF (RAW) exposures as a single photograph. For more information, see “Combining Multiple Exposures in a Single Photo (Multiple Exposure)” (📖 287).

HDR (High Dynamic Range)

MENU button ➔  photo shooting menu

Used with high contrast subjects, High Dynamic Range (HDR) preserves details in highlights and shadows by combining two shots taken at different exposures. For more information, see “High Dynamic Range (HDR)” (📖 256).

Interval Timer Shooting

MENU button ➔  photo shooting menu

Take photographs at the selected interval until the specified number of shots has been recorded. For more information, see “Taking Photos at a Set Interval (Interval Timer Shooting)” (📖 298).

Time-Lapse Movie

MENU button →  photo shooting menu

The camera automatically takes photos at selected intervals to create a time-lapse movie. For more information, see “Creating a Movie from Photos (Time-Lapse Movie)” (📖 315).

Focus Shift Shooting

MENU button →  photo shooting menu

Focus shift automatically varies focus over a series of shots. Use it to take photos that will later be combined using focus stacking to create a single image with increased depth of field. For more information, see “Varying Focus over a Series of Photos (Focus Shift Shooting)” (📖 328).

Silent Live View Photography

MENU button →  photo shooting menu

Enable the electronic shutter during live view photography to mute shutter sounds and eliminate the vibrations produced by the mechanical shutter. For more information, see “The Electronic Shutter (Silent Live View Photography)” (📖 340).

🎬 The Movie Shooting Menu: Movie Shooting Options

To view the movie shooting menu, select the 🎬 tab in the camera menus.

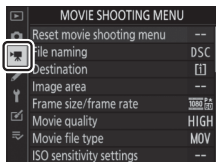

The movie shooting menu contains the following items:

Item		Item	
[Reset movie shooting menu]	572	[Active D-Lighting]	577
[File naming]	572	[High ISO NR]	578
[Destination]	572	[Diffraction compensation]	578
[Image area]	573	[Flicker reduction]	579
[Frame size/frame rate]	573	[Electronic VR]	580
[Movie quality]	574	[Microphone sensitivity]	581
[Movie file type]	574	[Attenuator]	582
[ISO sensitivity settings]	575	[Frequency response]	582
[White balance]	576	[Wind noise reduction]	583
[Set Picture Control]	577	[Headphone volume]	583
[Manage Picture Control]	577	[Timecode]	584

Reset Movie Shooting Menu

MENU button ➡  movie shooting menu

Restore movie shooting menu options to their default values (📖 516).

File Naming

MENU button ➡  movie shooting menu

Choose the three-letter prefix used in naming the image files in which movies are stored; the default prefix is “DSC” (📖 550).

Destination

MENU button ➡  movie shooting menu

Choose the slot to which movies are recorded when two memory cards are inserted.

- The menu shows the time available on each card.
- Recording ends automatically when no time remains on the current card.

Image Area

MENU button →  movie shooting menu

Choose the image area for movies.

Auto DX Crop

Choose whether the camera automatically uses the [DX] image area for movies recorded with a DX lens.

Frame Size/Frame Rate

MENU button →  movie shooting menu

Choose the movie frame size (in pixels) and frame rate. For more information, see “Frame Size/Frame Rate and Movie Quality” (📖 264).

Movie Quality

MENU button ➡  movie shooting menu

Choose from [**High quality**] and [**Normal**]. For more information, see “Frame Size/Frame Rate and Movie Quality” (📖 264).

Movie File Type

MENU button ➡  movie shooting menu

Record movies in MOV or MP4 format.

ISO Sensitivity Settings

MENU button →  movie shooting menu

Adjust the following ISO sensitivity settings for use during filming.

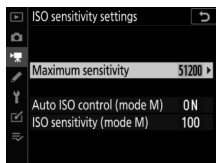

Option	Description
[Maximum sensitivity]	<ul style="list-style-type: none">Choose the upper limit for auto ISO sensitivity control from values between ISO 200 and Hi 2.The selected value serves as the upper limit for ISO sensitivity in modes P, S, and A and when [On] is selected for [Auto ISO control (mode M)] in mode M.
[Auto ISO control (mode M)]	<ul style="list-style-type: none">[On]: Enable auto ISO sensitivity control in mode M.[Off]: Use the value selected for [ISO sensitivity (mode M)].Regardless of the option selected, auto ISO sensitivity control is used in modes other than M.
[ISO sensitivity (mode M)]	Choose the ISO sensitivity for mode M from values between ISO 100 and Hi 2.

✓ Auto ISO Sensitivity Control

- At high ISO sensitivities, “noise” (randomly-spaced bright pixels, fog, or lines) may increase.
- At high ISO sensitivities, the camera may have difficulty focusing.
- The foregoing can be prevented by choosing a lower value for [ISO sensitivity settings] > [Maximum sensitivity].

White Balance

MENU button ➡  movie shooting menu

Choose the white balance for movies.

Select [**Same as photo settings**] to use the option currently selected for photos (📖 553).

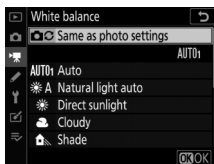

Set Picture Control

MENU button →  movie shooting menu

Choose a Picture Control for movies.
Select [**Same as photo settings**] to use the option currently selected for photos (📖 553).

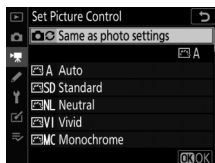

Manage Picture Control

MENU button →  movie shooting menu

Save modified Picture Controls as custom Picture Controls (📖 554).

Active D-Lighting

MENU button →  movie shooting menu

Preserve details in highlights and shadows, creating movies with natural contrast. Select [**Same as photo settings**] to use the option currently selected for photos (📖 254).





High ISO NR

MENU button ➡  movie shooting menu

Reduce “noise” (randomly-spaced bright pixels) in movies recorded at high ISO sensitivities ( 557).

Diffraction Compensation

MENU button ➡  movie shooting menu

Reduce diffraction in movies ( 559).

Flicker Reduction

MENU button →  movie shooting menu

Reduce flicker and banding when shooting under fluorescent or mercury-vapor lighting during live view or movie recording.

Choose [**Auto**] to allow the camera to automatically choose the correct frequency. If [**Auto**] fails to produce the desired results, select [**50 Hz**] or [**60 Hz**] according to the frequency of the local power supply. Choose [**50 Hz**] for areas with a 50 Hz power supply, [**60 Hz**] for areas with a 60 Hz power supply.

Flicker Reduction

- If [**Auto**] fails to produce the desired results and you are unsure as to the frequency of the local power supply, test both the 50 and 60 Hz options and choose the one that produces the best results.
- Flicker reduction may not produce the desired results if the subject is very bright. If this is the case, try choosing a smaller aperture (higher f-number).
- Flicker reduction may fail to produce the desired results in modes other than **M**. If this is the case, select mode **M** and choose a shutter speed adapted to the frequency of the local power supply:
 - 50 Hz: $\frac{1}{100}$ s, $\frac{1}{50}$ s, $\frac{1}{25}$ s
 - 60 Hz: $\frac{1}{125}$ s, $\frac{1}{60}$ s, $\frac{1}{30}$ s

Electronic VR

MENU button ➡  movie shooting menu

Choose whether to enable electronic vibration reduction during movie recording.

Option	Description
[On]	<ul style="list-style-type: none">• Enable electronic vibration reduction during movie recording.• Electronic vibration reduction is not available in EFCT modes or at frame sizes of 1920 × 1080; 120p, 1920 × 1080; 100p, or 1920 × 1080 (slow-motion).• Note that when electronic vibration reduction is [On], the angle of view will be reduced, slightly increasing the apparent focal length.• The maximum sensitivity for movie recording is fixed at ISO 51200.
[Off]	Electronic vibration reduction is disabled.

Microphone Sensitivity

MENU button →  movie shooting menu

Turn built-in or external microphones on or off or adjust microphone sensitivity.

Option	Description
[Auto]	Adjust microphone sensitivity automatically.
[Manual]	Select microphone sensitivity manually. Choose from values of from 1 to 20. The higher the value, the higher the sensitivity; the lower the value, the lower the sensitivity.
[Microphone off]	Turn sound recording off.

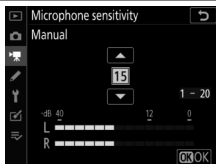

✓ Movies Without Sound

Movies that were recorded with [Microphone off] selected for [Microphone sensitivity] are indicated by a  icon.

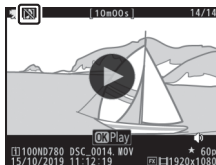

Attenuator



MENU button ➡  movie shooting menu

Select [**Enable**] to reduce microphone gain and prevent audio distortion when recording movies in loud environments.

Frequency Response

MENU button ➡  movie shooting menu

Choose the range of frequencies to which built-in and external microphones respond.

	Option	Description
	[Wide range]	Record a wide range of frequencies. Choose for everything from music to the bustling hum of a city street.
	[Vocal range]	Choose for human voices.

Wind Noise Reduction



MENU button →  movie shooting menu

Select [**On**] to enable the low-cut filter, reducing noise produced by wind blowing over the built-in microphone. Note that other sounds may also be affected.

Selecting [**On**] for [**Wind noise reduction**] has no effect on optional stereo microphones. Wind-noise reduction for optional stereo microphones that support this feature can be enabled or disabled using microphone controls.

Headphone Volume

MENU button →  movie shooting menu

Press  or  to adjust headphone volume.

Timecode

MENU button ➡  movie shooting menu

Choose whether to record time codes giving the hour, minute, second, and frame number for each frame when shooting movies. Time codes are available only with movies recorded in MOV format.

Option	Description
[Record timecodes]	<ul style="list-style-type: none">• [On]: Record time codes. The time code appears in the monitor.• [On (with HDMI output)]: Time codes will be included with footage saved to external recorders connected to the camera via an HDMI cable. The camera supports Atomos SHOGUN, NINJA, and SUMO-series Monitor recorders.• [Off]: Time codes are not recorded.
[Count-up method]	<ul style="list-style-type: none">• [Record run]: Time codes are incremented only while recording is in progress.• [Free run]: Time codes are incremented continuously. Time codes continue to be incremented while the camera is off.

Option	Description
[Timecode origin]	<ul style="list-style-type: none"> • [Reset]: Reset the time code to 00:00:00.00. • [Enter manually]: Enter the hour, minute, second, and frame number manually. • [Current time]: Set the time code to the current time as reported by the camera clock. Before using this option, select [Time zone and date] in the setup menu and confirm that the camera clock is set to the correct date and time.
[Drop frame]	Select [On] to compensate for discrepancies between the frame count and the actual recording time at frame rates of 30 and 60 fps.

HDMI Devices

Selecting [On (with HDMI output)] for [Record timecodes] may disrupt footage output to HDMI devices.

✎ Custom Settings: Fine-Tuning Camera Settings

To view Custom Settings, select the ✎ tab in the camera menus.

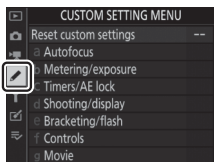

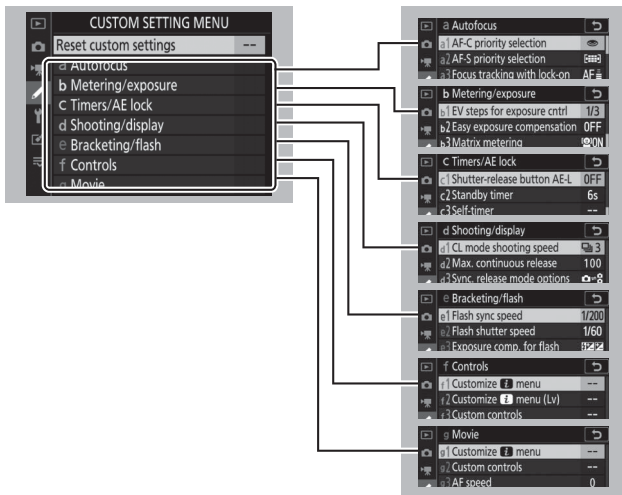

Custom Settings are used to customize camera settings to suit individual preferences. The Custom Settings menu is divided into levels.









The following Custom Settings are available: ¹

Item		
[Reset custom settings]		590
a [Autofocus]		
a1	[AF-C priority selection]	590
a2	[AF-S priority selection]	591
a3	[Focus tracking with lock-on]	592
a4	[3D-tracking face-detection]	592
a5	[Auto-area AF face/eye detection]	593
a6	[Focus points used]	594
a7	[Store points by orientation]	595
a8	[AF activation]	597
a9	[Focus point wrap-around]	597
a10	[Focus point options]	598
a11	[Low-light AF]	599
a12	[Manual focus ring in AF mode]²	600

Item		
b [Metering/exposure]		
b1	[EV steps for exposure cntrl]	601
b2	[Easy exposure compensation]	602
b3	[Matrix metering]	603
b4	[Center-weighted area]	603
b5	[Fine-tune optimal exposure]	604
c [Timers/AE lock]		
c1	[Shutter-release button AE-L]	605
c2	[Standby timer]	605
c3	[Self-timer]	606
c4	[Monitor off delay]	606

Item		
d [Shooting/display]		
d1	[CL mode shooting speed]	607
d2	[Max. continuous release]	607
d3	[Sync. release mode options]	608
d4	[Exposure delay mode]	608
d5	[Electronic front-curtain shutter]	609
d6	[Extended shutter speeds (M)]	610
d7	[File number sequence]	611
d8	[Save original (EFFECTS)]	613
d9	[Exposure preview (Lv)]	614
d10	[Framing grid display]	615
d11	[Peaking highlights]	615
d12	[LCD illumination]	616
d13	[Live view in continuous mode]	616
d14	[Optical VR] ³	617

Item		
e [Bracketing/flash]		
e1	[Flash sync speed]	618
e2	[Flash shutter speed]	620
e3	[Exposure comp. for flash]	620
e4	[Auto $\frac{1}{2}$ ISO sensitivity control]	621
e5	[Modeling flash]	621
e6	[Bracketing order]	622
f [Controls]		
f1	[Customize  menu]	623
f2	[Customize  menu (Lv)]	626
f3	[Custom controls]	628
f4	[OK button]	635
f5	[Customize command dials]	637
f6	[Release button to use dial]	641
f7	[Reverse indicators]	642
f8	[ switch]	642

Item		
g [Movie]		
g1	[Customize  menu]	643
g2	[Custom controls]	645
g3	[AF speed]	650
g4	[AF tracking sensitivity]	652
g5	[Highlight display]	653

- 1 Items modified from default values are indicated by asterisks (“*”).
- 2 This item is available with compatible lenses only.
- 3 This item is available only with compatible AF-P lenses not equipped with a vibration reduction switch.

Reset Custom Settings

MENU button ➡  Custom Settings menu



Restore Custom Settings to their default values ( 518).

a: Autofocus

a1: AF-C Priority Selection

MENU button ➡  Custom Settings menu



Choose whether photos can be taken before the camera focuses when **AF-C** is selected.

Option		Description
	[Release]	Photos can be taken whenever the shutter-release button is pressed (release priority).
	[Focus]	Photos can be taken only when the camera is in focus (focus priority).

a2: AF-S Priority Selection

MENU button ➡  Custom Settings menu

Choose whether photos can be taken before the camera focuses when **AF-S** is selected.

	Option	Description
	[Release]	Photos can be taken whenever the shutter-release button is pressed (release priority).
	[Focus]	Photos can be taken only when the camera is in focus (focus priority).

a3: Focus Tracking with Lock-On

MENU button ➡  Custom Settings menu

Choose how quickly focus responds if something passes between the subject and the camera during viewfinder photography in autofocus mode **AF-C** or when **AF-A** is selected and the camera is shooting using **AF-C**.

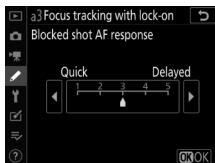

- Choose [**5 (Delayed)**] to help maintain focus on your original subject.
- Choose [**1 (Quick)**] to make it easier to shift focus to objects crossing your field of view.
- Note that [**2**] and [**1 (Quick)**] are equivalent to [**3**] when [**3D-tracking**] or [**Auto-area AF**] is selected for AF-area mode.

a4: 3D-Tracking Face-Detection

MENU button ➡  Custom Settings menu

Choose whether the camera detects and focuses on faces when [**3D-tracking**] is selected for AF-area mode during viewfinder photography.

a5: Auto-Area AF Face/Eye Detection

MENU button ➡  Custom Settings menu

Choose whether the camera detects and focuses on faces or on faces and eyes when [**Auto-area AF**] is selected for AF-area mode.

Option	Description
[Face and eye detection on]	If the camera detects a portrait subject during live view photography, it will automatically focus on one or the other of the subject's eyes. During viewfinder photography or movie recording or if the eyes are not detected, the camera will instead focus on the subject's face.
[Face detection on]	When the camera detects a portrait subject, it automatically focuses on the subject's face.
[Off]	Face and eye detection disabled.

a6: Focus Points Used

MENU button ➡  Custom Settings menu

Choose the number of focus points available for manual focus-point selection when an option other than [**Auto-area AF**] is selected for AF-area mode.



Option		Description
ALL	[All points]	Every focus point available in the current AF-area mode can be selected. The number of points available varies with the AF-area mode.
1/2	[Every other point]	The number of available focus points is reduced to one quarter of the number available when [All points] is selected. Use for quick focus-point selection. <ul style="list-style-type: none">• This has no effect on the number of focus points available for live view photography in [Pinpoint AF] and [Wide-area AF (L)] modes.

a7: Store Points by Orientation



MENU button ➡  Custom Settings menu

Choose whether separate focus points can be selected for “wide” (landscape) orientation, for “tall” (portrait) orientation with the camera rotated 90° clockwise, and for “tall” orientation with the camera rotated 90° counterclockwise. Separate options are available for the viewfinder (shown in the illustrations) and for live view.

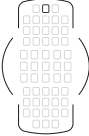
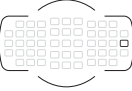
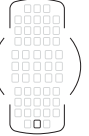
- Select [**No**] to use the same focus point regardless of camera orientation.

		
		
Camera rotated 90° counter-clockwise	Landscape (wide) orientation	Camera rotated 90° clockwise

- Select **[Yes]** to enable separate focus-point selection.

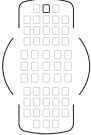
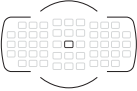
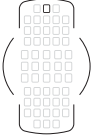
		
		
Camera rotated 90° counter-clockwise	Landscape (wide) orientation	Camera rotated 90° clockwise

a8: AF Activation

MENU button ➡  Custom Settings menu

Choose whether the shutter-release button can be used to focus. If [**AF-ON only**] is selected, the camera will not focus when the shutter-release button is pressed halfway. Focus can only be adjusted using the **AF-ON** button or other controls to which AF-ON has been assigned using Custom Setting f3 [**Custom controls**].

a9: Focus Point Wrap-Around

MENU button ➡  Custom Settings menu

Choose whether focus-point selection “wraps around” from one edge of the display to another.

If [**Wrap**] is selected, focus-point selection will “wrap around” from top to bottom, bottom to top, right to left, and left to right, so that, for example, pressing  when a focus point at the right edge of the viewfinder display is highlighted selects the corresponding focus point at the left edge of the display.

a10: Focus Point Options

MENU button ➡  Custom Settings menu

Choose from the following focus point display options:

Focus Point Illumination

Choose whether the active focus point is highlighted in the viewfinder.

Option	Description
[Auto]	The selected focus point is automatically highlighted in red as needed to establish contrast with the background.
[On]	The selected focus point is always highlighted in red, regardless of the brightness of the background. Depending on the brightness of the background, the selected focus point may be difficult to see.
[Off]	The selected focus point is not highlighted.

Manual Focus Mode

Option	Description
[On]	The focus point is displayed at all times in manual focus mode.
[Off]	The focus point is displayed only during focus point selection.

Dynamic-Area AF Assist

Choose whether both the selected focus point and the surrounding focus points are displayed in dynamic-area AF mode.

Option	Description
[On]	Display both the selected focus point and surrounding focus points.
[Off]	Display only the selected focus point.

a11: Low-Light AF

MENU button ➡  Custom Settings menu

Choose [On] for more accurate focus under low-light conditions during live view when **AF-S** is selected for autofocus mode or when **AF-A** is selected and the camera is shooting using **AF-S**.

- Low-light AF applies only during still photography.
- Low-light AF is not available in  and **EFCT** modes.
- Low-light AF is not available during interval-timer photography or time-lapse movie recording.
- The camera may require more time to focus when [On] is selected.
- While low-light AF is in effect, “Low-light” will appear in the monitor. In addition, the display refresh rate may drop.

a12: Manual Focus Ring in AF Mode

MENU button ➡  Custom Settings menu

This item is available with compatible lenses only. Choose whether the lens focus ring can be used for manual focus in autofocus mode.

Option	Description
[Enable]	Autofocus can be over-ridden by rotating the lens focus ring (autofocus with manual override). The focus ring can be used for manual focus while the shutter-release button is pressed halfway. To refocus using autofocus, lift your finger from the shutter-release button and then press it halfway again.
[Disable]	The lens focus ring cannot be used for manual focus while autofocus mode is selected.

b: Metering/Exposure

b1: EV Steps for Exposure Cntrl

MENU button ➡  Custom Settings menu

Select the increments used for adjustments to shutter speed, aperture, ISO sensitivity, bracketing, and exposure and flash compensation.

b2: Easy Exposure Compensation

MENU button ➡  Custom Settings menu

Choose whether the  button is needed for exposure compensation.



Option	Description
[On (Auto reset)]	Exposure compensation can be adjusted rotating the command dial not currently used for shutter speed or aperture. The setting selected with the command dial is reset when the camera turns off or the standby timer expires.
[On]	Exposure compensation can be adjusted rotating the command dial not currently used for shutter speed or aperture. Exposure compensation is not reset when the camera turns off or the standby timer expires.
[Off]	Exposure compensation is set by pressing the  button and rotating the main command dial.

- This setting takes effect in modes **P**, **S**, and **A**. Easy exposure compensation is not available in other modes.
- The command dial used varies with the shooting mode.

b3: Matrix Metering

MENU button ➡  Custom Settings menu

Choose whether [**Matrix metering**] assigns priority to faces detected by the camera. This setting applies only during viewfinder photography.

	Option	Description
	[Face detection on]	Matrix metering assigns priority to faces detected by the camera.
	[Face detection off]	Matrix metering does not assign priority to faces detected by the camera.

b4: Center-Weighted Area

MENU button ➡  Custom Settings menu

When [**Center-weighted metering**] is selected, the camera assigns the greatest weight to an area in the center of the viewfinder when setting exposure. Custom Setting b4 [**Center-weighted area**] is used to choose the size of the area given the greatest weight when [**Center-weighted metering**] is selected.

- If a non-CPU or AF-S Fisheye NIKKOR 8–15mm f/3.5–4.5E ED lens is attached, the size of the area is fixed at $\phi 12$ mm.

b5: Fine-Tune Optimal Exposure

MENU button ➡  Custom Settings menu

Use this item to fine-tune the exposure value selected by the camera; exposure can be fine-tuned separately for each metering method. Exposure can be adjusted up for brighter exposures or down for darker exposures in the range +1 to -1 EV in steps of $\frac{1}{6}$ EV. The default is 0.

✔ Fine-Tuning Exposure



- Regardless of the option selected for Custom Setting b5 [**Fine-tune optimal exposure**], the exposure compensation icon () will not be displayed. The only way to determine how much exposure has been altered is to view the amount in the fine-tuning menu for Custom Setting b5.
 - The values selected are not affected by two-button resets.
-

c: Timers/AE Lock

c1: Shutter-Release Button AE-L

MENU button ➡  Custom Settings menu

Choose whether exposure locks when the shutter-release button is pressed.

Option		Description
 ON	[On (half press)]	Pressing the shutter-release button halfway locks exposure.
 ON	[On (burst mode)]	Exposure only locks while the shutter-release button is pressed all the way down.
[Off]		Pressing the shutter-release button does not lock exposure.

c2: Standby Timer

MENU button ➡  Custom Settings menu



The camera continues to meter exposure for a set time after the shutter-release button is pressed halfway. Choose how long the camera continues to meter exposure when no operations are performed.

- The shutter-speed and aperture displays in the control panel and viewfinder turn off automatically when the standby timer expires.

c3: Self-Timer

MENU button ➡  Custom Settings menu

Choose the length of the shutter release delay, the number of shots taken, and the interval between shots in self-timer mode.

Option	Description
[Self-timer delay]	Choose the length of the shutter-release delay.
[Number of shots]	Press  and  to choose the number of shots taken each time the shutter-release button is pressed; choose from values of from 1 to 9.
[Interval between shots]	Choose the interval between shots when [Number of shots] is more than 1.

c4: Monitor Off Delay

MENU button ➡  Custom Settings menu

Choose how long the monitor remains on when no operations are performed.

- Separate monitor off delays can be selected for [**Playback**], [**Image review**], [**Menus**], [**Information display**], and [**Live view**].
- The default delays are: for [**Playback**] and [**Information display**], 10 s; for [**Menus**], 1 minute; for [**Image review**], 4 s; and for [**Live view**], 10 minutes.
- Choose shorter monitor-off delays for greater battery endurance.

d: Shooting/Display

d1: CL Mode Shooting Speed

MENU button ➡  Custom Settings menu

Choose the frame advance rate for low-speed continuous release mode; options range from [6 fps] to [1 fps].

d2: Max. Continuous Release

MENU button ➡  Custom Settings menu

The maximum number of shots that can be taken in a single burst in continuous release modes can be set to any value between 1 and 100.

- Note that regardless of the option selected, there is no limit to the number of photos that can be taken in a single burst when a shutter speed of 4 s or slower is selected in mode **S** or **M**.

The Memory Buffer

Custom Setting d2 [**Max. continuous release**] is used to select the number of shots that can be taken in a single burst. The number of shots that can be taken before the memory buffer fills and shooting slows varies with image quality and other settings. When the buffer is full, the camera will display **r00** and the frame advance rate will drop.

d3: Sync. Release Mode Options

MENU button ➡  Custom Settings menu

Choose whether the shutters on the remote cameras are synchronized with the shutter on the master camera when using an optional wireless remote controller.

d4: Exposure Delay Mode

MENU button ➡  Custom Settings menu

In situations where the slightest camera movement can blur pictures, shutter release can be delayed by from about 0.2 to 3 seconds after the mirror is raised.

d5: Electronic Front-Curtain Shutter

MENU button ➡  Custom Settings menu

Enable or disable the electronic front-curtain shutter. Enabling the electronic front-curtain helps reduce blur caused by camera shake. The electronic front-curtain shutter is available in **Q**, **QC**, and **MUP** modes.

Option	Description
[Enable]	Enable the electronic front-curtain shutter.
[Disable]	Use a mechanical shutter.

The Electronic Front-Curtain Shutter

- Pictures taken with lenses of types other than G, E, or D may contain “noise” such as lines or fog. Select [Disable] should you notice this to be the case.
- Regardless of the option selected, the camera uses the mechanical shutter in modes other than **Q**, **QC**, and **MUP**.
- The fastest shutter speed and maximum ISO sensitivity available with the electronic front-curtain shutter are $1/2000$ s and ISO 51200, respectively.

d6: Extended Shutter Speeds (M)

MENU button ➡  Custom Settings menu

Extend the range of shutter speeds available in mode **M**; the slowest shutter speed available when **[On]** is selected is 900 s (15 minutes). Extended shutter speeds can be used for pictures of the night sky and in other situations that require that the shutter remain open for long periods.

- To use extended shutter speeds, choose **[On]** and select a shutter speed of 60 s or slower.

d7: File Number Sequence

MENU button ➡  Custom Settings menu

Choose a file numbering option.

Option	Description
[On]	When a new folder is created or a new memory card is inserted in the camera, file numbering will continue from the last number used. This simplifies file management by minimizing the occurrence of duplicate file names when multiple cards are used.
[Off]	When a new folder is created or a new memory card is inserted, file numbering restarts from 0001. If the current folder already contains images, file numbering will instead continue from the highest file number in the current folder. If you select [Off] after selecting [On] , the camera will store the current file number. File numbering will resume from the previously-stored value the next time [On] is selected.
[Reset]	Reset the file numbering for [On] . If the current folder is empty, file numbering will restart from 0001 with the next picture taken. If the current folder contains images, the next picture taken will be assigned a file number by adding one to the highest file number in the current folder.

✔ File Number Sequence

- If a picture is taken when the current folder contains a picture numbered 9999, a new folder will be created and file numbering will restart from 0001.
- When the current folder number reaches 999, the camera will no longer be able to create new folders and the shutter release will be disabled if:
 - The current folder contains 5000 pictures (in addition, movie recording will be disabled if the camera calculates that the number of files needed to record a movie of the maximum length would result in the folder containing over 5000 files)
 - The current folder contains a picture numbered 9999 (in addition, movie recording will be disabled if the camera calculates that the number of files needed to record a movie of the maximum length would result in a file numbered over 9999)





To resume shooting, choose [**Reset**] for Custom Setting d7 [**File number sequence**] and then either format the current memory card or insert a new memory card.

✔ Folder Numbering

- If a picture is taken when the current folder contains 5000 pictures or a picture numbered 9999, a new folder will be created and selected as the current folder.
 - The new folder is assigned a number one higher than current folder number. If a folder with that number already exists, the new folder will be assigned the lowest available folder number.
-

d8: Save Original (EFFECTS)

MENU button ➡  Custom Settings menu

In VI, POP, , , , and  modes, you can choose whether in addition to saving pictures in JPEG format, the camera saves NEF (RAW) copies without the effects applied.

Option	Description
[On]	The camera saves an NEF (RAW) copy in addition to a JPEG copy to which the effect has been applied.
[Off]	The camera saves only a JPEG copy to which the effect has been applied.

d9: Exposure Preview (Lv)

MENU button ➔  Custom Settings menu

Select [**On**] to preview how the options currently selected for shutter speed, aperture, and ISO sensitivity affect exposure while taking photographs in modes **P**, **S**, **A**, and **M**.

Exposure Preview

- Exposure preview is not available when **B** (Bulb) or **-** (Time) is selected for shutter speed. Note that the preview may not accurately reflect the final results when:
 - [**On**] is selected for Custom Setting d6 [**Extended shutter speeds (M)**] and shutter speed is 60 s or slower
 - Flash lighting is used
 - [**Active D-Lighting**] or [**HDR (high dynamic range)**] is in effect
 - **x 200** is selected for shutter speed
 - Bracketing is in effect
 - If the subject is very bright or very dark, the exposure indicators will flash to warn that the preview may not accurately reflect exposure.
 - Exposure can be adjusted by ± 5 EV, although only values between -3 and $+3$ EV are reflected in the preview display.
-

d10: Framing Grid Display

MENU button ➡  Custom Settings menu

Choose whether to display a grid for reference when framing shots.

d11: Peaking Highlights

MENU button ➡  Custom Settings menu

When focus peaking is enabled during live view photography in manual focus mode, objects that are in focus are indicated by colored outlines in the display. You can choose the color.

Option	Description
[Peaking level]	Choose from [3 (high sensitivity)], [2 (standard)], [1 (low sensitivity)], and [Off]. The higher the value, the greater the depth that will be shown as being in focus. Focus peaking is not performed in special effects modes.
[Peaking highlight color]	Choose a peaking highlight color from [Red], [Yellow], [Blue], and [White].

d12: LCD Illumination

MENU button ➡  Custom Settings menu

Choose when the control panel backlight lights.

- If [**Off**] is selected, the backlight will light when the power switch is rotated to . The backlight turns off when the shutter-release button is pressed halfway or all the way down.
- If [**On**] is selected, the backlight will light while the standby timer is active. Note that this increases the drain on the battery. The backlight will turn off while the shutter-release button is pressed halfway or all the way down, but will turn on again when the button is released.

d13: Live View in Continuous Mode

MENU button ➡  Custom Settings menu

Choose whether the monitor remains on in live view while burst photography is in progress. If [**Off**] is selected, not only the monitor but also the monitor backlight will turn off during exposures.

d14: Optical VR

MENU button ➡  Custom Settings menu

This item is available only with compatible AF-P lenses not equipped with a vibration reduction switch. Selecting [**On**] enables vibration reduction, which takes effect whenever the shutter-release button is pressed halfway. Select [**Off**] to disable vibration reduction.

e: Bracketing/Flash

e1: Flash Sync Speed

MENU button ➡  Custom Settings menu

Choose the flash sync speed.

Option	Description
[1/200 s (Auto FP)]	Auto FP high-speed sync is enabled with compatible flash units and the maximum sync speed for other flash units is set to $1/200$ s. <ul style="list-style-type: none">• When the camera shows a shutter speed of $1/200$ s in mode P or A, auto FP high-speed sync will be activated if the actual shutter speed is faster than $1/200$ s. If the flash supports auto FP high-speed sync, the camera can select shutter speeds as fast as $1/8000$ s.• In modes S and M, the user can select shutter speeds as fast as $1/8000$ s when using flash units that support auto FP high-speed sync.
[1/200 s]	
[1/160 s]	
[1/125 s]	Flash sync speed set to selected value, which can be from $1/200$ to $1/60$ s.
[1/100 s]	
[1/80 s]	
[1/60 s]	

✔ Fixing Shutter Speed at the Flash Sync Speed Limit

In modes **S** and **M**, shutter speed can be fixed at the value selected for Custom Setting e1 [**Flash sync speed**] by selecting the next shutter speed after the slowest possible shutter speed (30 s or - -). An **X** (flash sync indicator) will be displayed in the viewfinder and control panel together with the flash sync speed.

✔ Auto FP High-Speed Sync

- Auto FP high-speed sync allows the flash to be used at the highest shutter speed supported by the camera. When [**1/200 s (Auto FP)**] is selected, the camera automatically enables auto FP high-speed sync at shutter speeds faster than the flash sync speed. This makes it possible to choose the maximum aperture for reduced depth of field even when the subject is backlit in bright sunlight.
 - The flash information display shows "FP" when auto [**1/200 s (Auto FP)**] is selected.
-

e2: Flash Shutter Speed

MENU button ➡  Custom Settings menu



Choose the slowest shutter speed available with a flash in mode **P** or **A**.

Regardless of the setting chosen for e2 [**Flash shutter speed**], shutter speeds can be as slow as 30 s in modes **S** and **M** or at flash settings of slow sync, slow rear-curtain sync, or red-eye reduction with slow sync.



e3: Exposure Comp. for Flash

MENU button ➡  Custom Settings menu



Choose how the camera adjusts flash level when exposure compensation is used.

	Option	Description
	[Entire frame]	The camera adjusts both the flash level and exposure. This changes the exposure for the entire frame.
	[Background only]	Exposure compensation is adjusted for the background only.



e4: Auto ISO Sensitivity Control

MENU button   Custom Settings menu

Choose how the camera adjusts flash level when auto ISO sensitivity control is enabled.

	Option	Description
	[Subject and background]	The camera takes both the main subject and background lighting into account when adjusting ISO sensitivity.
	[Subject only]	ISO sensitivity is adjusted only to ensure that the main subject is correctly exposed.

e5: Modeling Flash

MENU button   Custom Settings menu

Select [On] to enable the modeling flash emitted if the **Pv** button is pressed when the camera is used with an optional flash unit that supports the Nikon Creative Lighting system.

e6: Bracketing Order

MENU button ➡  Custom Settings menu

Choose the order in which the shots in the bracketing program are taken.

	Option	Description
N	[MTR > under > over]	The unmodified shot is taken first, followed by the shot with the lowest value, followed by the shot with the highest value.
->+	[Under > MTR > over]	Shooting proceeds in order from the lowest to the highest value.











- Custom Setting e6 [**Bracketing order**], has no effect on the order of the shots taken when [**ADL bracketing**] is selected for [**Auto bracketing**] > [**Auto bracketing set**] in the photo shooting menu.





f: Controls





f1: Customize Menu

MENU button ➔  Custom Settings menu

Choose the items listed in the **i** menu displayed when the **i** button is pressed during viewfinder photography. For information on customizing the **i** menu, see “Customizing the **i** Menu: Customize **i** Menu” (📖 347).

Item		📖	Item		📖
	[Choose image area]	129		[Active D-Lighting]	254
QUAL	[Image quality]	134		[Long exposure NR]	556
SIZE	[Image size]	137	ISO NR	[High ISO NR]	557
	[View memory card info]	624		[Metering]	166
	[Exposure compensation]	175		[Flash mode]	465
ISO	[ISO sensitivity settings]	187		[Flash compensation]	469
WB	[White balance]	195	AF	[Autofocus mode]	140
	[Set Picture Control]	243		[AF-area mode]	145
RGB	[Color space]	554	BKT	[Auto bracketing]	224
				[Multiple exposure]	287
			HDR	[HDR (high dynamic range)]	256

Item		📖
	[Interval timer shooting]	298
	[Time-lapse movie]	315
	[Focus shift shooting]	328
	[View release mode]	624

Item		📖
	[Custom controls]	628
	[Exposure delay mode]	608
	[Bluetooth connection]	625
	[Wi-Fi connection]	625

View Memory Card Info

View the slot currently selected as the destination for new pictures and the role played by the card in Slot 2 when two memory cards are inserted. This item can be used to view but not to change the option selected.

- The role played by the card in Slot 2 can be selected using **[Role played by card in Slot 2]** in the photo shooting menu (📖 279).

View Release Mode

View the current release mode. This item can be used to view but not change the option selected.

Bluetooth Connection



Turn the Bluetooth connection on or off.





Wi-Fi Connection





Enable or disable Wi-Fi.









- Enable Wi-Fi to establish wireless connections to computers or between the camera and smartphones or tablets (smart devices) running the SnapBridge app.
- To turn Wi-Fi off, highlight [**Wi-Fi connection**] in the **i** menu and press **OK**; if Wi-Fi is currently enabled, a [**Close Wi-Fi connection**] prompt will be displayed. Press **OK** to end the connection.







f2: Customize Menu (Lv)







MENU button   Custom Settings menu

Choose the items listed in the  menu displayed when the  button is pressed during live view. For information on customizing the  menu, see “Customizing the  Menu: Customize  Menu” (📖 347).

	Item	
	[Choose image area]	129
QUAL	[Image quality]	134
SIZE	[Image size]	137
	[View memory card info]	624
	[Exposure compensation]	175
ISO	[ISO sensitivity settings]	187
WB	[White balance]	195
	[Set Picture Control]	243
RGB	[Color space]	554

	Item	
	[Active D-Lighting]	254
	[Long exposure NR]	556
ISO NR	[High ISO NR]	557
	[Metering]	166
	[Flash mode]	465
	[Flash compensation]	469
AF	[Autofocus mode]	140
	[AF-area mode]	145
BKT	[Auto bracketing]	224
	[Multiple exposure]	287
HDR	[HDR (high dynamic range)]	256

Item		📖
	[Interval timer shooting]	298
	[Time-lapse movie]	315
	[Focus shift shooting]	328
	[Silent live view photography]	570
	[View release mode]	624
	[Custom controls]	628

Item		📖
	[Exposure delay mode]	608
	[Exposure preview]	614
	[Peaking highlights]	615
	[Monitor brightness]	658
	[Bluetooth connection]	625
	[Wi-Fi connection]	625
	[Negative digitizer]	343





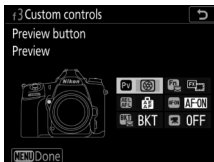

f3: Custom Controls

MENU button ➔  Custom Settings menu









Choose the functions performed either by pressing camera controls or by pressing controls and rotating command dials during still photography.

- Choose the roles played by the controls below. Highlight the desired control and press .









Option	
	[Preview button]
	[Fn button]
	[AE-L/AF-L button]
	[AF-ON button]
	[BKT button]
	[Movie record button]







- The roles that can be assigned to these controls are as follows:



Option		PV	Fn	AE-L	AF-ON	BKT	
	[AF-ON]	✓	✓	✓	✓	—	—
	[AF lock only]	✓	✓	✓	✓	—	—
	[AE lock (Hold)]	✓	✓	✓	✓	—	—
	[AE lock (Reset on release)]	✓	✓	✓	✓	—	—
	[AE lock only]	✓	✓	✓	✓	—	—
	[AE/AF lock]	✓	✓	✓	✓	—	—
	[FV lock]	✓	✓	✓	—	—	—









Option		Pv	Fn	AEL/AF-L	AF-ON	BKT	Q
	[Disable/enable]	✓	✓	—	—	—	—
	[Preview]	✓	✓	—	—	—	—
	[Preview (Lv max. aperture)]	✓	✓	—	—	—	—
	[Matrix metering]	✓	✓	—	—	—	—
	[Center-weighted metering]	✓	✓	—	—	—	—
	[Spot metering]	✓	✓	—	—	—	—
	[Highlight-weighted metering]	✓	✓	—	—	—	—
BKT	[Bracketing burst]	✓	✓	—	—	—	—
+RAW	[+ NEF (RAW)]	✓	✓	—	—	—	—
	[Framing grid display]	✓	✓	—	—	—	—
	[Viewfinder virtual horizon]	✓	✓	—	—	—	—
	[MY MENU]	✓	✓	—	—	—	—
	[Access top item in MY MENU]	✓	✓	—	—	—	—
	[Playback]	✓	✓	—	—	—	—
	[Choose image area]	✓	✓	—	—	—	✓
	[Active D-Lighting]	✓	✓	—	—	—	—
	[Metering]	—	—	—	—	—	✓
BKT	[Auto bracketing]	—	—	—	—	✓	—
	[Multiple exposure]	—	—	—	—	✓	—
HDR	[HDR (high dynamic range)]	—	—	—	—	✓	—
DLY	[Exposure delay mode]	✓	✓	—	—	—	—
	[1 step spd/aperture]	✓	✓	—	—	—	—
Non-CPU	[Choose non-CPU lens number]	✓	✓	—	—	—	—
[None]		✓	✓	✓	✓	✓	✓



- The following options are available:

	Option	Description
	[AF-ON]	Pressing the control initiates autofocus, duplicating the function of the AF-ON button.
	[AF lock only]	Focus locks while the control is pressed.
	[AE lock (Hold)]	Exposure locks when the control is pressed. Exposure lock does not end when the shutter is released. Exposure remains locked until the control is pressed a second time or the standby timer expires.
	[AE lock (Reset on release)]	Exposure locks when the control is pressed. Exposure remains locked until the control is pressed a second time, the shutter is released, or the standby timer expires.
	[AE lock only]	Exposure locks while the control is pressed.
	[AE/AF lock]	Focus and exposure lock while the control is pressed.
	[FV lock]	Press the control to lock flash value for optional flash units; press again to cancel FV lock.

Option		Description
	[Disable/enable]	If the flash is currently enabled, it will be disabled while the control is pressed. If the flash is currently off, front-curtain sync will be selected while the control is pressed.
	[Preview]	Hold the control to stop aperture down and preview depth of field during viewfinder photography. During live view, pressing the control stops aperture down to the selected value.
	[Preview (Lv max. aperture)]	Press the control to temporarily select maximum aperture for an improved focus preview during live view.
	[Matrix metering]	[Matrix metering] is activated while the control is pressed.
	[Center-weighted metering]	[Center-weighted metering] is activated while the control is pressed.
	[Spot metering]	[Spot metering] is activated while the control is pressed.
	[Highlight-weighted metering]	[Highlight-weighted metering] is activated while the control is pressed.

Option	Description
 [Bracketing burst]	<ul style="list-style-type: none"> • If the control is pressed when an option other than [WB bracketing] is selected for [Auto bracketing] > [Auto bracketing set] in the photo shooting menu in release mode CH, CL, or QC, the camera will take all the shots in the current bracketing program and repeat the bracketing burst while the shutter-release button is pressed. In release modes S and Q, shooting will end after the first bracketing burst. • If [WB bracketing] is selected for [Auto bracketing] > [Auto bracketing set], the camera will take pictures while the shutter-release button is pressed and apply white balance bracketing to each shot.
 [+ NEF (RAW)]	<ul style="list-style-type: none"> • If a JPEG option is currently selected for image quality, an NEF (RAW) copy will be recorded with the next picture taken after the control is pressed (until the picture is taken, "RAW" will appear in the monitor image quality display). The original image quality setting will be restored when you remove your finger from the shutter-release button or press the control again, canceling [+ NEF (RAW)]. • NEF (RAW) copies are recorded at the settings currently selected for [NEF (RAW) recording] in the photo shooting menu.

	Option	Description
	[Framing grid display]	Press the control to display a framing grid in the viewfinder or monitor. Press the control again to turn the display off.
	[Viewfinder virtual horizon]	Press the control to view a virtual horizon display in the viewfinder. Press the control again to turn the display off.
	[MY MENU]	Press the control to display "MY MENU".
	[Access top item in MY MENU]	Press the control to jump to the top item in "MY MENU." Select this option for quick access to a frequently-used menu item.
	[Playback]	Press the control to start playback.
	[Choose image area]	Press the control and rotate a command dial to choose the image area.
	[Active D-Lighting]	Press the control and rotate a command dial to adjust Active D-Lighting.
	[Metering]	Press the control and rotate a command dial to choose a metering option.
BKT	[Auto bracketing]	Press the control and rotate the main command dial to choose the number of shots and the sub-command dial to select the bracketing increment or Active D-Lighting amount.





	Option	Description
	[Multiple exposure]	Press the control and rotate the main command dial to choose the mode and the sub-command dial to choose the number of shots.
HDR	[HDR (high dynamic range)]	Press the control and rotate the main command dial to choose the mode and the sub-command dial to choose HDR strength.
	[Exposure delay mode]	Press the control and rotate a command dial to choose the shutter-release delay.
	[1 step spd/aperture]	<p>Make adjustments to shutter speed and aperture in increments of 1 EV, regardless of the option selected for Custom Setting b1 [EV steps for exposure cntrl].</p> <ul style="list-style-type: none"> • In modes S and M, shutter speed can be adjusted in increments of 1 EV by holding the control and rotating the main command dial. • In modes A and M, aperture can be adjusted in increments of 1 EV by holding the control and rotating the sub-command dial.
Non-CPU	[Choose non-CPU lens number]	Press the control and rotate a command dial to choose a lens number saved using the [Non-CPU lens data] item in the setup menu.
	[None]	The control has no effect.

f4: OK Button







MENU button ➡  Custom Settings menu

Choose the role assigned to the  button during still photography and playback.

Viewfinder Photography





Option		Description
RESET	[Select center focus point]	Pressing  selects the center focus point.
	[Highlight active focus point]	Pressing  highlights the active focus point.
[None]		Pressing  during shooting has no effect.

Live View

Option		Description
RESET	[Select center focus point]	Pressing  selects the center focus point.
	[Zoom on/off]	Press  to zoom the display in on the area around the current focus point. Press  again to return to the previous display. To choose the zoom ratio, highlight [Zoom on/off] and press  .
[None]		Pressing  during shooting has no effect.

Playback Mode

Regardless of the option selected, pressing **OK** when a movie is displayed full frame starts movie playback.

	Option	Description
	[Thumbnail on/off]	Press OK to toggle between full-frame and 4-, 9-, or 72-frame thumbnail playback.
	[View histograms]	A histogram is displayed while the OK button is pressed. The histogram display is available in both full-frame and thumbnail playback.
	[Zoom on/off]	Press OK to zoom the display in on the area around the active focus point. Press OK again to return to the previous display. <ul style="list-style-type: none">• To choose the zoom ratio, highlight [Zoom on/off] and press ↻.• Zoom is available in both full-frame and thumbnail playback.
	[Choose slot and folder]	Press OK to display the [Choose slot and folder] dialog, where you can then choose a slot and folder for playback.



f5: Customize Command Dials

MENU button ➔  Custom Settings menu

Customize the operation of the main and sub-command dials.

Reverse Rotation

Reverse the direction of rotation of the command dials for selected operations.

- Highlight [**Exposure compensation**] or [**Shutter speed/aperture**] and press  to select () or deselect ().
- Press  to save changes and exit.

Change Main/Sub

Reverse the roles of the main- and sub-command dials.

Option	Description
[Exposure setting]	If [On] is selected, the main command dial will control aperture and the sub-command dial shutter speed. If [On (Mode A)] is selected, the main command dial will be used to set aperture in mode A only.
[Autofocus setting]	If [On] is selected, AF-area mode can be selected by keeping the AF-mode button pressed and rotating the main command dial, autofocus mode by keeping the AF-mode button pressed and rotating the sub-command dial.

Aperture Setting

Choose whether aperture can be adjusted using the aperture ring on CPU lenses in modes **A** and **M**.



Option	Description
[Sub-command dial]	Aperture can only be adjusted with the sub-command dial (or with the main command dial if [On] is selected for [Change main/sub] > [Exposure setting]).
[Aperture ring]	Aperture can be adjusted with the lens aperture ring. The camera aperture display shows aperture in increments of 1 EV, although fractions of 1 EV can still be selected using the aperture ring.

- Regardless of the option selected for **[Aperture setting]**, aperture for lenses not equipped with an aperture ring (type G and E lenses) must be adjusted using the sub-command dial.
- When using non-CPU lenses, supply lens data using the **[Non-CPU lens data]** item in the setup menu (📖 349) and adjust aperture using the lens aperture ring.

Menus and Playback





Choose the roles played by the multi selector and command dials during playback and menu navigation.

Option	Description
[On]	Playback: <ul style="list-style-type: none">• The main command dial can be used to choose the picture displayed during full-frame playback. The sub-command dial can be used to skip forward or back according to the option selected for [Sub-dial frame advance].• During thumbnail playback, the main command dial can be used to highlight thumbnails and the sub-command dial to page up or down. Menus*: <p>Use the main command dial to highlight menu items. Rotating the sub-command dial clockwise displays the sub-menu for the highlighted option. Rotating it counter-clockwise displays the previous menu.</p>
ON [Ⓞ]	[On (image review excluded)] As for [On] except that the command dials cannot be used for playback during image review.
[Off]	Use the multi selector to choose the picture displayed during full-frame playback or to highlight pictures or menu items.

* The sub-command dial cannot be used to select highlighted items. To select highlighted items, press  or .

Sub-Dial Frame Advance





Choose the number of frames that can be skipped by rotating the sub-command dial during full-frame playback. This option only takes effect when **[On]** or **[On (image review excluded)]** is selected for **[Menus and playback]**.

Option	Description
[10 frames]	Skip forward or back 10 frames at a time.
[50 frames]	Skip forward or back 50 frames at a time.
★ [Rating]	Skip to the next or previous pictures with the selected rating. To choose the rating, highlight [Rating] and press  .
 [Protect]	Skip to the next or previous protected picture.
 [Still images only]	Skip to the next or previous photo.
 [Movies only]	Skip to the next or previous movie.
 [Folder]	Rotate the sub-command dial to select a folder.

f6: Release Button to Use Dial

MENU button ➡  Custom Settings menu



Selecting [Yes] allows adjustments that are normally made by holding a button and rotating a command dial to be made by rotating the command dial after the button is released. This ends when the button is pressed again, the shutter-release button is pressed halfway, or the standby timer expires.

- [Release button to use dial] applies to the , ISO (FORMAT), BKT, , ?/WB (WB), , (QUAL), , and AF mode buttons.
- [Release button to use dial] also applies to controls to which the following roles have been assigned using Custom Settings f3 or g2 [Custom controls]: [Choose image area], [Active D-Lighting], [Metering], [Auto bracketing], [Multiple exposure], [HDR (high dynamic range)], [Exposure delay mode], [1 step spd/aperture], and [Choose non-CPU lens number].

f7: Reverse Indicators

MENU button ➡  Custom Settings menu

Choose whether the exposure indicators in the viewfinder, control panel, and information display are displayed with negative values on the left and positive values on the right, or with positive values on the left and negative values on the right.

	Option	Description
+0-		The indicator is displayed with positive values on the left and negative values on the right.
-0+		The indicator is displayed with negative values on the left and positive values on the right.



f8: Switch

MENU button ➡  Custom Settings menu

Choose whether rotating the power switch to  activates only the control panel backlight or also turns on the information display.

















g: Movie





g1: Customize Menu





MENU button   Custom Settings menu

Choose the items listed in the **i** menu displayed when the **i** button is pressed during movie recording. For information on customizing the **i** menu, see “Customizing the **i** Menu:



Customize  Menu” ( 347).

Item			Item		
	[Choose image area]	129	AF	[Autofocus mode]	140
	[Frame size and rate/Image quality]	264	[+]	[AF-area mode]	145
	[Destination]	572		[Electronic VR]	580
	[Exposure compensation]	175		[Microphone sensitivity]	581
ISO	[ISO sensitivity settings]	187		[Attenuator]	582
WB	[White balance]	195		[Frequency response]	582
	[Set Picture Control]	243		[Wind noise reduction]	583
	[Active D-Lighting]	254		[Headphone volume]	583
	[Metering]	166		[Custom controls]	628



Item		
	[Peaking highlights]	615
	[Highlight display]	653
	[Monitor brightness]	658
	[Bluetooth connection]	625

Item		
	[Wi-Fi connection]	625
	[Multi-selector power aperture]	644
	[Multi selector exposure comp.]	644

Multi-Selector Power Aperture

Choose whether the multi selector can be used for power aperture. Select [**Enable**] to enable power aperture. Press  to widen the aperture,  to narrow the aperture.

Multi Selector Exposure Comp.





Choose whether the multi selector can be used to adjust exposure compensation. Selecting [**Enable**] allows exposure compensation to be set by pressing  or .

g2: Custom Controls

MENU button ➔  Custom Settings menu





Choose the functions performed either by pressing camera controls or by pressing controls and rotating command dials during filming.

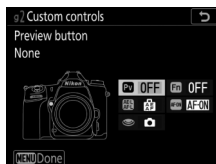







- Choose the roles played by the controls below. Highlight the desired control and press .

Option	
	[Preview button]
	[Fn button]
	[AE-L/AF-L button]
	[AF-ON button]
	[Shutter-release button]











- The roles that can be assigned to these controls are as follows:





Option	Pv	Fn	AE-L/AF-L	AF-ON	Shutter-release
 [Power aperture (open)]	✓	—	—	—	—
 [Power aperture (close)]	—	✓	—	—	—
 [Exposure compensation +]	✓	—	—	—	—
 [Exposure compensation -]	—	✓	—	—	—
 [Framing grid display]	✓	✓	—	—	—



Option		Pv	Fn	AEL/AF-L	AF-ON	
	[Choose image area]	✓	✓	—	—	—
	[Active D-Lighting]	✓	✓	—	—	—
	[AF-ON]	—	—	✓	✓	—
	[AF lock only]	—	—	✓	✓	—
	[AE lock (Hold)]	—	—	✓	✓	—
	[AE lock only]	—	—	✓	✓	—
	[AE/AF lock]	—	—	✓	✓	—
	[Take photos]	—	—	—	—	✓
	[Record movies]	—	—	—	—	✓
	[None]	✓	✓	✓	✓	—

- The following options are available:

Option		Description
	[Power aperture (open)]	Aperture widens while the Pv button is pressed. Use in combination with Custom Setting g2 [Custom controls] > [Fn button] > [Power aperture (close)] for button-controlled aperture adjustment.
	[Power aperture (close)]	Aperture narrows while the Fn button is pressed. Use in combination with Custom Setting g2 [Custom controls] > [Preview button] > [Power aperture (open)] for button-controlled aperture adjustment.

	Option	Description
	[Exposure compensation +]	Exposure compensation increases while the Pv button is pressed. Use in combination with Custom Setting g2 [Custom controls] > [Fn button] > [Exposure compensation –] for button-controlled exposure compensation.
	[Exposure compensation –]	Exposure compensation decreases while the Fn button is pressed. Use in combination with Custom Setting g2 [Custom controls] > [Preview button] > [Exposure compensation +] for button-controlled exposure compensation.
	[Framing grid display]	Press the control to display a framing grid in the monitor. Press the control again to turn the display off.
	[Choose image area]	Press the control and rotate a command dial to choose the image area for movies. Note that the image area cannot be changed while recording is in progress.
	[Active D-Lighting]	Press the control and rotate a command dial to adjust Active D-Lighting for movies.
	[AF-ON]	Pressing the control initiates autofocus, duplicating the function of the AF-ON button.

Option	Description
 [AF lock only]	Focus locks while the control is pressed.
 [AE lock (Hold)]	Exposure locks when the control is pressed. Exposure lock does not end when the shutter is released. Exposure remains locked until the control is pressed a second time or the standby timer expires.
 [AE lock only]	Exposure locks while the control is pressed.
 [AE/AF lock]	Focus and exposure lock while the control is pressed.
 [Take photos]	Press the shutter-release button all the way down to take a photograph with an aspect ratio of 16:9.

Option	Description
 [Record movies]	<p>Press the shutter-release button halfway to start live view. If the focus mode selector is in the AF position, you can then press the shutter-release button halfway again to focus. To start movie recording, press the shutter-release button the rest of the way down. Press the shutter-release button again to end recording.</p> <ul style="list-style-type: none"> • When [Record movies] is selected, the shutter-release button cannot be used for any purpose other than recording movies. • To end live view, press the  button. • The shutter-release buttons on optional wireless remote controllers or remote cords function in the same way as the camera shutter-release button.
[None]	The control has no effect.

Power Aperture

- Power aperture is available only in modes **A** and **M**.
- A  icon displayed in the monitor indicates that power aperture cannot be used.
- The display may flicker while aperture is adjusted.

g3: AF Speed

MENU button ➔  Custom Settings menu

Choose the focus speed for movie recording when using lenses compatible with this option.

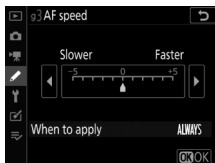

Use [**When to apply**] to choose when the selected option applies.

	Option	Description
ALWAYS	[Always]	The selected option applies whenever the live view selector is rotated to  .
REC	[Only while recording]	The selected option applies only when recording is in progress. At other times, the focus speed is "+5", or in other words as fast possible.

✔ Compatible Lenses

The value selected for **[AF speed]** applies only to AF-P lenses and the lenses listed below. All other lenses focus at maximum speed.

- AF-S Fisheye NIKKOR 8–15mm f/3.5–4.5E ED
 - AF-S DX NIKKOR 16–80mm f/2.8–4E ED VR
 - AF-S DX NIKKOR 18–55mm f/3.5–5.6G VR II
 - AF-S DX NIKKOR 18–140mm f/3.5–5.6G ED VR
 - AF-S DX NIKKOR 18–300mm f/3.5–6.3G ED VR
 - AF-S NIKKOR 20mm f/1.8G ED
 - AF-S NIKKOR 24mm f/1.8G ED
 - AF-S NIKKOR 24–70mm f/2.8E ED VR
 - AF-S NIKKOR 28mm f/1.4E ED
 - AF-S NIKKOR 35mm f/1.8G ED
 - AF-S DX NIKKOR 55–200mm f/4–5.6G ED VR II
 - AF-S NIKKOR 58mm f/1.4G
 - AF-S NIKKOR 70–200mm f/2.8E FL ED VR
 - AF-S NIKKOR 105mm f/1.4E ED
 - AF-S NIKKOR 120–300mm f/2.8E FL ED SR VR
 - AF-S NIKKOR 180–400mm f/4E TC1.4 FL ED VR
 - AF-S NIKKOR 200–500mm f/5.6E ED VR
 - AF-S NIKKOR 300mm f/4E PF ED VR
 - AF-S NIKKOR 400mm f/2.8E FL ED VR
 - AF-S NIKKOR 500mm f/4E FL ED VR
 - AF-S NIKKOR 500mm f/5.6E PF ED VR
 - AF-S NIKKOR 600mm f/4E FL ED VR
-

g4: AF Tracking Sensitivity

MENU button ➔  Custom Settings menu

Choose how quickly focus responds when your subject leaves the focus point or something passes between the subject and the camera during filming; the options available range from 1 to 7.

- Choose [**7 (Low)**] to help maintain focus on your original subject.
- If the subject leaves the selected focus area when [**1 (High)**] is selected, the camera will respond by quickly shifting focus to a new subject in the same area.

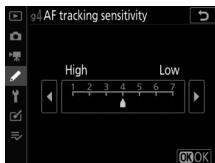

g5: Highlight Display

MENU button ➡  Custom Settings menu

Choose whether shading is used to indicate highlights (bright areas of the frame) during movie recording.

Display Pattern

To enable the highlight display for movie recording, select [**Pattern 1**] or [**Pattern 2**].

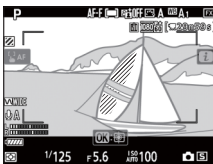

Pattern 1

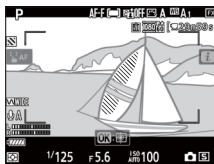

Pattern 2

Highlight Display Threshold

Choose the brightness needed to trigger the movie highlight display. The lower the value, the greater the range of brightnesses that will be shown as highlights. If [**255**] is selected, the highlight display will show only areas that are potentially overexposed.

Highlight Display

If both the highlight display and peaking highlights are enabled, only peaking highlights will be displayed in manual focus mode. To view the highlight display in manual focus mode, select [**Off**] for Custom Setting d11 [**Peaking highlights**] > [**Peaking level**].

Y The Setup Menu: Camera Setup

To view the setup menu, select the Y tab in the camera menus.

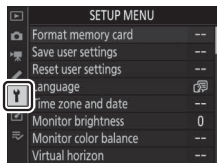

The setup menu contains the following items:

Item		Item	
[Format memory card]	656	[Clean image sensor]	673
[Save user settings]	657	[Lock mirror up for cleaning]*	674
[Reset user settings]	657	[Image Dust Off ref photo]	675
[Language]	657	[Pixel mapping]	679
[Time zone and date]	658	[Image comment]	681
[Monitor brightness]	658	[Copyright information]	682
[Monitor color balance]	659	[Beep options]	684
[Virtual horizon]	661	[Touch controls]	686
[Information display]	662	[HDMI]	686
[AF fine-tuning options]	663	[Location data]	687
[Non-CPU lens data]	672		

Item	
[Wireless remote (WR) options]	688
[Assign remote (WR) Fn button]	691
[Airplane mode]	691
[Connect to smart device]	692
[Connect to PC]	696
[Wireless transmitter (WT-7)]	700

Item	
[Conformity marking]	700
[Battery info]	701
[Slot empty release lock]	702
[Save/load menu settings]	703
[Reset all settings]	708
[Firmware version]	708

* Not available at battery levels of  or below.

Format Memory Card

MENU button ➔  setup menu







Format memory cards. To begin formatting, choose a memory card slot and select **[Yes]**. *Note that formatting permanently deletes all pictures and other data on the card.* Before formatting, be sure to make backup copies as required.



✓ During Formatting

Do not turn the camera off or remove memory cards until the message **[Formatting memory card.]** clears from the display.

🔍 Two-Button Format

- Press and hold the  (FORMAT) and **ISO** () buttons simultaneously for over two seconds until **F**  **r** starts to flash in the control panel and viewfinder and a flashing memory card indicator appears in the control panel; you can then press the two buttons ( and **ISO**/) again to format the current memory card.
 - If two memory cards are inserted, the flashing indicator will show the card selected for formatting. To select a different card, rotate the main command dial while the **F**  **r** indicator is flashing.
 - Do not turn the camera off or remove the battery or memory card during formatting.
-

Save User Settings

MENU button ➡  setup menu

Frequently-used combinations of settings can be assigned to the **U1** and **U2** positions on the mode dial (📖 115).

Reset User Settings

MENU button ➡  setup menu

Reset settings for **U1** and **U2** to default values (📖 118).

Language

MENU button ➡  setup menu

Choose a language for camera menus and messages. The languages available vary with the country or region in which the camera was originally purchased.

Time Zone and Date

MENU button ➡  setup menu



Change time zones and set the camera clock. We recommend that the camera clock be adjusted regularly.

Option	Description
[Time zone]	Choose a time zone. [Date and time] is automatically set to the time in the new time zone.
[Date and time]	Set the camera clock to the time in the selected [Time zone].
[Date format]	Choose the order in which the day, month, and year are displayed.
[Daylight saving time]	Select [On] to turn daylight saving time on, [Off] to turn it off. Selecting [On] automatically advances the clock one hour. The default setting is [Off].

If the clock is reset, a **CLOCK** icon will flash in the control panel and a flashing  indicator will appear in the information display.

Monitor Brightness





MENU button ➡  setup menu

Press  or  to adjust monitor brightness. Choose higher values for increased brightness, lower values for reduced brightness.

Monitor Color Balance

MENU button ➔  setup menu



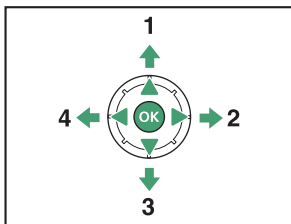
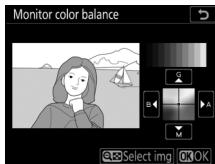

Adjust monitor color balance to your taste.

- Color balance is adjusted using the multi selector. Press , , , or  to adjust color balance as shown below. Press  to save changes.



- 1 Increase green
- 2 Increase amber
- 3 Increase magenta
- 4 Increase blue

- Monitor color balance applies only to menus, playback, and the view through the lens displayed during live view; pictures taken with the camera are not affected.
- The reference image is either the last picture taken or, in playback mode, the picture last displayed. If the memory card contains no pictures, an empty frame will be displayed instead.

- To choose a different image, press the  () button. Highlight the desired picture and press  to select it as the reference image.
- To view the highlighted image full frame, press and hold  (**QUAL**).

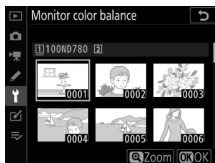

Virtual Horizon

MENU button ➡ 🧭 setup menu

Display roll and pitch information based on information from the camera tilt sensor.

- If the camera is tilted neither left nor right, the roll reference line will turn green. If the camera is tilted neither forward nor back, the dot (●) in the center of the display will turn green.
- Each division is equivalent to 5°.



Camera level

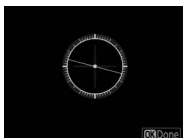

Camera tilted left or right



Camera tilted forward or back

✔ Tilting the Camera

The virtual horizon display is not accurate when the camera is tilted at a sharp angle forward or back. If the camera is unable to measure tilt, the amount of tilt will not be displayed.

Information Display

MENU button →  setup menu

Adjust the appearance of the information display according to lighting conditions.

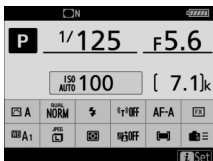

Dark on light



Light on dark

Option	Description
[Auto]	The camera adjusts the color of the lettering in the information display to make it easier to read. Black is used in bright locations, a dim white in dark locations.
[Manual]	Manually choose the color of the lettering. B [Dark on light]: To make the display easier to read in bright locations, the monitor lights and the lettering is displayed in black. W [Light on dark]: To make the display easier to read in dark locations, the monitor dims and the lettering is displayed in white.

AF Fine-Tuning Options



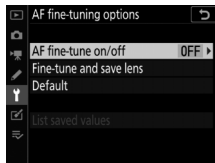

MENU button ➡  setup menu

Fine-tune focus for the current lens.

- Use only as required.
- We recommend that you perform fine-tuning at a focus distance you use frequently. If you perform fine-tuning at a short focus distance, for example, you may find it less effective at longer distances.



Option	Description
[AF fine-tune on/off]	<ul style="list-style-type: none">• [On]: Turn AF fine-tuning on.• [Off]: Turn AF fine-tuning off.
[Fine-tune and save lens]	<p>Fine-tune focus for the current CPU lens; separate focus positions can be selected for viewfinder and live view photography (📖 665).</p> <ul style="list-style-type: none">• The camera can store values for up to 20 lens types.• The camera will not save fine-tuning values for non-CPU lenses.• New values overwrite existing values. Separate values can be saved for lenses with teleconverters attached, even if values already exist for the same lenses without teleconverters.
[Default]	<p>Choose the AF tuning values used for viewfinder and live view photography with lenses for which no values have been saved using [Fine-tune and save lens] (📖 667).</p>

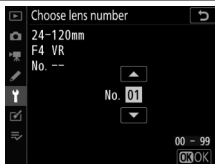

Option	Description
<p>[List saved values]</p>	<p>List values saved using [Fine-tune and save lens].</p> <p>Highlighting a lens in the list and pressing  displays a [Choose lens number] dialog.</p> <ul style="list-style-type: none"> The [Choose lens number] dialog is used to choose the lens identifier. Press  or  to choose an identifier and press  to save changes and exit. While [Fine-tune and save lens] stores only one set of values for each lens type, choosing different identifiers lets you save separate fine-tuning values for two or more lenses of the same type, for example by choosing an identifier that is the same as the lens serial number.



✓ Deleting Saved Values

To delete values saved using [Fine-tune and save lens], highlight the desired lens in the [List saved values] list and press  (FORMAT).

Creating and Saving Fine-Tuning Values

- 1 Attach the lens to the camera.**
- 2 Select [AF fine-tuning options] in the setup menu, then highlight [Fine-tune and save lens] and press .**
- 3 Highlight [For viewfinder photography] or [For live view photography] and press .**

An AF fine-tuning dialog will be displayed. The options displayed vary with whether the attached lens is a zoom lens or has a fixed focal-length.





Zoom lens



Fixed focal-length lens

4 Press or to fine-tune autofocus.

- Choose from values between +20 and -20.
- The current value is shown by ▲, the previously-selected value by △.
- If a zoom lens is attached, you can choose separate fine-tuning values for maximum angle (WIDE) and maximum zoom (TELE). Use  and  to choose between the two.
- The larger the fine-tuning value, the farther the focal point from the lens; the smaller the value, the closer the focal point.

5 Press to save the new value.

Auto AF Fine-Tuning

Use auto AF fine-tuning to fine-tune autofocus automatically while viewing the results in the live view display. Pressing the  button in the [For viewfinder photography] display in Step 3 takes you Step 2 of “Auto AF Fine-Tuning” (📖 668).

Choosing a Default Fine-Tuning Value

1 Select [AF fine-tuning options] in the setup menu, then highlight [Default] and press .

2 Highlight [For viewfinder photography] or [For live view photography] and press .

An AF fine-tuning dialog will be displayed.

3 Press  or  to fine-tune autofocus.

- Choose from values between +20 and –20.
 - The current value is shown by ▲, the previously-selected value by △.
 - The larger the fine-tuning value, the farther the focal point from the lens; the smaller the value, the closer the focal point.
-

4 Press  to save the new value.

Auto AF Fine-Tuning

Auto AF fine-tuning is performed as described below.

- 1 Rotate the live view selector to  and press the  button.**

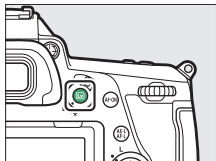

- 2 Press the AF-mode and movie-record buttons simultaneously and keep them pressed for over two seconds.**

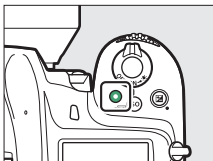
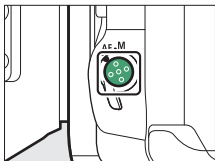

Zoom Lenses

- The camera will display options for fine-tuning autofocus separately at maximum angle and maximum zoom.

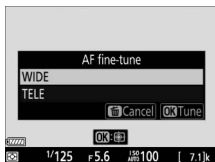

- Highlight **[WIDE]** (maximum angle) or **[TELE]** (maximum zoom) and press **OK**; the camera will select the center focus point and the auto AF fine-tuning dialog will be displayed.

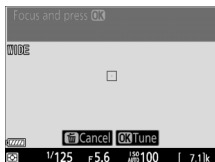

Fixed Focal-Length Lenses

The camera will select the center focus point and the auto AF fine-tuning dialog will be displayed.



3 Press the shutter-release button halfway to focus.

- If you are using a zoom lens, rotate the zoom ring all the way to select either the maximum angle or maximum zoom before focusing.
- Before focusing, mount the camera on a tripod and aim the camera at a flat, high-contrast subject parallel to the camera focal plane.

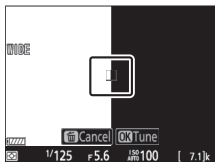
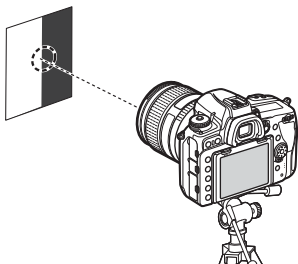

- Note that auto AF fine-tuning works best at maximum aperture.
- Zoom in on the view through the lens to confirm that the subject is in focus. Focus can be adjusted manually if necessary.
- Note that live view autofocus and auto AF fine-tuning may not function in dark surroundings.

4 Press **OK**.

- The AF fine-tuning value for the current lens will be added to the **[List saved values]** list (CPU lenses only).
- If auto fine-tuning is successful, AF fine-tuning will be enabled and the **[AF fine-tune on/off]** item will change to **[On]**.
- If you are using a zoom lens, after completing AF fine-tuning for either the maximum angle or maximum zoom, you will need to repeat the process for the remaining item. Press the **Q (QUAL)** button and repeat Steps 2 to 4.
- New values overwrite existing values.

5 Press **OK** to save changes and exit.

✓ If Auto Fine-Tuning Fails

If auto fine-tuning fails, a message will be displayed. Press **Q (QUAL)** to attempt auto fine-tuning again, or press **OK** to exit without performing AF fine-tuning. Pressing **Q (QUAL)** returns you to Step 2.

Non-CPU Lens Data

MENU button ➡  setup menu

Record data for non-CPU lenses. Recording the focal length and maximum aperture of non-CPU lenses allows them to be used with some functions normally reserved for CPU lenses.

Option	Description
[Lens number]	Choose a number to identify the lens.
[Focal length (mm)]	Enter the focal length.
[Maximum aperture]	Enter the maximum aperture.

Clean Image Sensor

MENU button ➡  setup menu

Dirt or dust entering the camera when lenses are exchanged or the body cap is removed may adhere to the low-pass filter and affect your photographs. The “clean image sensor” option vibrates the sensor to remove dust.

Option	Description
[Clean now]	Perform image sensor cleaning immediately.
[Clean at startup/shutdown]	<ul style="list-style-type: none">• [Clean at startup]: The image sensor is automatically cleaned each time the camera is turned on.• [Clean at shutdown]: The image sensor is automatically cleaned during shutdown each time the camera is turned off.• [Clean at startup & shutdown]: The image sensor is cleaned automatically at startup and at shutdown.• [Cleaning off]: Automatic image sensor cleaning off.

Lock Mirror Up for Cleaning

MENU button ➔  setup menu

Use [**Lock mirror up for cleaning**] to lock the mirror up so that dust that cannot be removed using the “clean image sensor” option can be removed manually. Note, however, that because the low-pass filter is extremely delicate and easily damaged, we recommend that manual cleaning be performed only by a Nikon-authorized service representative. For information on cleaning the low-pass filter, see “Manual Cleaning” (📖 827).

Image Dust Off Ref Photo

MENU button ➡ Y setup menu

Acquire reference data for the Image Dust Off option in NX Studio. Image Dust Off processes NEF (RAW) pictures to mitigate effects caused by dust adhering in front of the camera image sensor. For more information, refer to NX Studio's online help.

Acquiring Image Dust Off Reference Data

1 Choose a start option.

- Highlight [**Start**] and press **OK** to immediately display the [**Image Dust Off ref photo**] dialog.
- Highlight [**Clean sensor and then start**] and press **OK** to clean the image sensor before starting. The [**Image Dust Off ref photo**] dialog will be displayed when image sensor cleaning is complete.



- “rEF” will appear in the viewfinder and control panel displays.



- To exit without acquiring Image Dust Off reference data, press MENU.

2 With the lens about ten centimeters (four inches) from a well-lit, featureless white object, frame the object so that it fills the display and then press the shutter-release button halfway.

- In autofocus mode, focus will automatically be set to infinity.
- In manual focus mode, set focus to infinity manually.

3 Press the shutter-release button the rest of the way down to acquire Image Dust Off reference data.

- The monitor turns off when the shutter-release button is pressed.
- If the reference object is too bright or too dark, the camera may be unable to acquire Image Dust Off reference data and a message will be displayed and the camera will return to the display shown in Step 1. Choose another reference object and press the shutter-release button again.



✔ Image Sensor Cleaning

Dust off reference data recorded before image sensor cleaning is performed cannot be used with photographs taken after image sensor cleaning is performed. Select [**Clean sensor and then start**] only if the Image Dust Off reference data will not be used with existing photographs.

✔ Acquiring Image Dust Off Reference Data

- [Image Dust Off ref photo] is not available when a non-CPU lens is mounted on the camera.
- An FX-format CPU lens with a focal length of at least 50 mm is recommended.
- When using a zoom lens, zoom all the way in.
- The same reference data can be used for photographs taken with different lenses or at different apertures.
- Reference images cannot be viewed using computer imaging software.
- A grid pattern is displayed when reference images are viewed on the camera.

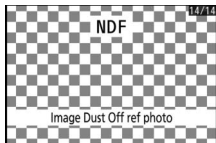

Pixel Mapping

MENU button ➡  setup menu

Pixel mapping checks and optimizes camera image sensor. If you notice unexpected bright spots appearing in pictures taken with the camera, perform pixel mapping as described below.

- Use a fully-charged battery to prevent unexpected loss of power.
- Pixel mapping is performed with the lens cap (front cap) attached and the camera viewfinder eyepiece covered by the supplied eyepiece cap.

1 Select [Pixel mapping] in the setup menu.

Turn the camera on, press the **MENU** button, and select [**Pixel mapping**] in the setup menu.

2 Select [Start].

Pixel mapping will start. **b u 5 5** appears in the control panel while the operation is in progress.

3 Turn the camera off when pixel mapping is complete.

Pixel Mapping



- Do not attempt to operate the camera while pixel mapping is in progress. Do not turn the camera off or remove or disconnect the power source.
 - Pixel mapping may not be available if the camera's internal temperature is elevated.
-

Image Comment



MENU button ➡  setup menu

Add a comment to new photographs as they are taken. Comments can be viewed in the NX Studio [**Info**] tab.

Input Comment

Input a comment of up to 36 characters. Highlight [**Input comment**] and press  to display a text-entry dialog. For information on text entry, see “Text Entry” ( 61).

Attach Comment

To attach the comment to subsequent photographs, highlight [**Attach comment**], press , and confirm that a check () appears in the adjacent check box. Press  to save changes and exit; the comment will be attached to all subsequent photographs.

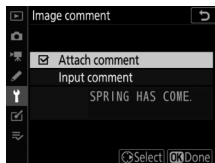

Photo Info

Comments can be viewed on the shooting data page in the photo information display.

Copyright Information

MENU button ➔  setup menu

Add copyright information to new photographs as they are taken. Copyright information can be viewed in the NX Studio [Info] tab.

Entering the Names of the Photographer and Copyright Holder

Enter the names of the photographer (maximum 36 characters) and copyright holder (maximum 54 characters). Highlight [Artist] or [Copyright] and press  to display a text-entry dialog. For information on text entry, see “Text Entry” (📖 61).

Attach Copyright Information

To attach copyright information to subsequent photographs, highlight [**Attach copyright information**], press **▶**, and confirm that a check () appears in the adjacent check box. Press **OK** to save changes and exit; copyright information will be attached to all subsequent photographs.



Copyright Information

- To prevent unauthorized use of the artist or copyright holder names, make sure that [**Attach copyright information**] is not selected before lending or transferring the camera to another person. You will also need to make sure that the artist and copyright fields are blank.
- Nikon does not accept liability for any damages or disputes arising from the use of the [**Copyright information**] option.

Photo Info

Copyright information is included in the shooting data shown in the photo information display.

Beep On/Off

Turn the beep speaker on or off.

- If [**On**] is selected for [**Beep on/off**], beeps sound when:
 - The self-timer is in operation
 - The shutter-release button is pressed for a second time during mirror-up photography
 - Interval-timer photography, time-lapse movie recording, or focus shift ends
 - The camera focuses—note that a beep will not sound when the camera focuses if [**Release**] is selected for Custom Setting a2 [**AF-S priority selection**], if **AF-C** is selected for autofocus mode, or if **AF-A** is selected and the camera focuses using **AF-C**
- The touch screen is used
- The shutter-release button is pressed with a write-protected memory card inserted in the camera

- Select [**Off (touch controls only)**] to disable the beep during keyboard entry while enabling it for other purposes.
- Note that regardless of the option selected, a beep will not sound when the camera focuses during movie recording or in quiet-shutter release modes (modes **Q** and **Qc**) or when [**On**] is selected for [**Silent live view photography**].

Volume

Adjust beep volume.

Pitch

Choose the pitch of the beep from [**High**] and [**Low**].

Touch Controls

MENU button ➡  setup menu

Adjust settings for monitor touch controls.

Enable/Disable Touch Controls

Enable or disable touch-screen controls. Select [**Playback only**] to enable touch-screen controls in playback mode only.

Full-Frame Playback Flicks

Choose whether the next image in full-frame playback is displayed by flicking left or by flicking right.

Option	Description
← [Left←Right]	Flick left to display the next picture.
➡ [Left→Right]	Flick right to display the next picture.

HDMI

MENU button ➡  setup menu

Adjust settings for connection to HDMI devices ( 396).

Location Data

MENU button ➡  setup menu

Adjust settings for use when the camera is connected to a device that provides location data, namely a GPS receiver or a smart device running the SnapBridge app. For more information on SnapBridge, see the app's online help.

Option	Description
[Standby timer]	If [Enable] is selected when a GPS receiver is connected, the exposure meters will turn off automatically if no operations are performed for the period specified using Custom Setting c2 [Standby timer]. The drain on the battery is reduced.
[Position]	View the location data supplied by the GPS receiver or smart device. The items displayed vary with the source.
[Set clock from satellite]	Select [Yes] to synchronize the camera clock with the time reported by the GPS device.

Wireless Remote (WR) Options

MENU button ➔  setup menu

Adjust status LED and link mode settings for optional WR-R10 wireless remote controllers. You can also choose a link mode for connection to optional radio-controlled flash units that support Advanced Wireless Lighting.

The WR-R10 Wireless Remote Controller

Be sure the firmware for the WR-R10 has been updated to the latest version (version 3.0 or later). For information on firmware updates, see the Nikon website for your area.





LED Lamp

Enable or disable the status LEDs on a WR-R10 wireless remote controller mounted on the camera. For more information, see the documentation supplied with the wireless remote controller.

Link Mode

Choose a link mode for WR-R10 wireless remote controllers mounted on other cameras or radio-controlled flash units that support Advanced Wireless Lighting. Be sure that the same mode is selected for the other devices.

Option	Description
[Pairing]	<p>The camera connects only to devices with which it has previously been paired. Press the pairing button on the WR-R10 wireless remote controller connected to the camera to pair it with other devices.</p> <ul style="list-style-type: none">• As camera will not communicate with devices with which it has not been paired, this option can be used to prevent signal interference from other devices in the vicinity.• Given that each device must be paired separately, however, PIN is recommended when connecting to a large number of devices.

Option	Description
<p data-bbox="153 336 211 361">[PIN]</p>	<p data-bbox="270 103 619 259">Communication is shared among all devices with the same four-digit PIN. You can enter any four-digit PIN of your choice.</p> <ul data-bbox="270 267 909 598" style="list-style-type: none"> <li data-bbox="270 267 909 361">• Press  or  to highlight digits and press  or  to change. Press  to enter and display the selected PIN. <li data-bbox="270 369 909 428">• This option is a good choice for photography featuring a large number of remote devices. <li data-bbox="270 436 909 598">• If there are multiple cameras present that share the same PIN, the flash units will be under the sole control of the camera that connects first (the LEDs on the WR-R10 units connected to the affected cameras will blink).













- Regardless of the option selected for **[Link mode]**, signals from paired wireless remote controllers will always be received by the WR-R10. Users of the WR-1 wireless remote controller will need to select pairing as the WR-1 link mode.

Assign Remote (WR) Fn Button

MENU button ➡  setup menu

Choose the role played by the **Fn** button on optional wireless remote controllers equipped with an **Fn** button. See Custom Setting f3 [**Custom controls**] for more information.

Option		Option	
 [AF-ON]	[AF-ON]	 [Disable/enable]	[Disable/enable]
 [AF lock only]	[AF lock only]	 [Preview]	[Preview]
 [AE lock (Reset on release)]	[AE lock (Reset on release)]	 [Preview (Lv max. aperture)]	[Preview (Lv max. aperture)]
 [AE lock only]	[AE lock only]	 [+ RAW]	[+ NEF (RAW)]
 [AE/AF lock]	[AE/AF lock]	 [Lv]	[Live view] *
 [FV lock]	[FV lock]	[None]	

* Performs the same function as the camera  button.

Airplane Mode

MENU button ➡  setup menu

Select [**Enable**] to disable the camera's built-in Bluetooth and Wi-Fi functions.

- The wireless functions of optional peripheral devices connected to the camera can only be disabled by disconnecting the devices.

Connect to Smart Device

MENU button ➔  setup menu

Adjust settings for connection to a smart device.

Pairing (Bluetooth)

Pair with or connect to smart devices using Bluetooth.

Option	Description
[Start pairing]	Pair the camera with a smart device (📄 415).
[Paired devices]	List paired smart devices or switch from one device to another.
[Bluetooth connection]	Select [Enable] to enable Bluetooth.

Select to Send (Bluetooth)

Select pictures for upload to a smart device or choose whether to mark pictures for upload as they are taken. Upload begins immediately when a connection is established.

Option	Description
[Auto select to send]	If [On] is selected, photos will be marked for upload to a smart device as they are taken. Regardless of the option selected with the camera, photos are uploaded in JPEG format at size of 2 megapixels. Photos taken during filming will not be uploaded automatically. Photos taken during filming must be selected for upload manually.
[Manual select to send]	Mark selected pictures for upload to a smart device.
[Deselect all]	Remove transfer marking from all images.

Wi-Fi Connection

Connect to smart devices via Wi-Fi.

■ Establish Wi-Fi Connection

Initiate a Wi-Fi connection.

- The camera SSID and password will be displayed. To connect, select the camera SSID and enter the password on the smart device (📖 406).
- Once a connection is established, this option will change to [**Close Wi-Fi connection**].
- Select [**Close Wi-Fi connection**] to end the connection when desired.

■ Wi-Fi Connection Settings

Access the following Wi-Fi settings:

Option	Description
[SSID]	Set the camera SSID.
[Authentication/encryption]	Choose [OPEN] or [WPA2-PSK-AES].
[Password]	Change the camera password.
[Channel]	Choose a channel. <ul style="list-style-type: none">• Select [Auto] to have the camera choose the channel automatically.• Select [Manual] to choose the channel manually.
[Current settings]	View current Wi-Fi settings.
[Reset connection settings]	Select [Yes] to reset Wi-Fi settings to default values.

■ Send While Off

If [On] is selected, upload of images to smart devices connected via Bluetooth will continue even when the camera is off.

Connect to PC

MENU button ➔  setup menu



Adjust settings for connection to computers using the camera's built-in Wi-Fi.

Wi-Fi Connection

Select [**Enable**] to connect using the settings currently selected for [**Network settings**].

Network Settings

Select [**Create profile**] to create a new network profile (📖 433, 439).

- If more than one profile already exists, you can press  to select a profile from a list.
- To edit an existing profile, highlight it and press . The following options will be displayed:

Option	Description
[General]	<ul style="list-style-type: none">• [Profile name]: Rename the profile. By default, the profile name is the same as the network SSID.• [Password protection]: Select [On] to require that a password be entered before the profile can be changed. To change the password, highlight [On] and press .

Option	Description
[Wireless]	<p>Infrastructure connections: Adjust settings to match those used on the network.</p> <ul style="list-style-type: none"> • [SSID]: Enter the network SSID. • [Channel]: The channel is selected automatically. • [Authentication/encryption]: Choose from [OPEN] and [WPA2-PSK-AES]. • [Password]: Enter the network password. <p>Ad-hoc connections: Choose the settings used for connection to the camera.</p> <ul style="list-style-type: none"> • [SSID]: Enter the camera SSID. • [Channel]: Select [Auto] for automatic channel selection or [Manual] to choose the channel manually. • [Authentication/encryption]: Choose from [OPEN] and [WPA2-PSK-AES]. • [Password]: Choose the password used for connection to the camera when [WPA2-PSK-AES] is selected for [Authentication/encryption].
[TCP/IP]	<p>Enter TCP/IP information for infrastructure connections. An IP address is required.</p> <ul style="list-style-type: none"> • If [Enable] is selected for [Obtain automatically], the IP address and sub-net mask will be acquired via a DHCP server or automatic IP addressing. • Select [Disable] manually to enter the IP address ([Address]) and sub-net mask ([Mask]).

Options

Adjust upload settings.

■ Auto Send

Select [**On**] to upload new photos as they are taken.

- Upload begins only after the photo has been recorded to the memory card; be sure a memory card is inserted in the camera.
- Movies, together with any photos taken during filming, are not uploaded automatically when recording is complete but must instead be uploaded from the playback display (☐ 447).

■ Delete After Send

Select [**Yes**] to delete photographs from the camera memory card automatically once upload is complete.

- Files marked for transfer before [**Yes**] is selected are not deleted.
- Deletion may be suspended during some camera operations.

■ ■ **Send File As**

When uploading NEF+JPEG images, choose whether to upload both the NEF (RAW) and JPEG files or only the JPEG copy.

■ ■ **Deselect All?**

Select [**Yes**] to remove transfer marking from all images. Upload of images with a “sending” icon will immediately be terminated.

MAC Address

Display the MAC address.

Wireless Transmitter (WT-7)

MENU button ➡  setup menu

Adjust settings for connection to computers or ftp servers via wireless or Ethernet networks using an optional WT-7 wireless transmitter. This item is available only when an optional WT-7 wireless transmitter is connected.

- These settings take effect when the WT-7 is connected and turned on, in which case the options selected for [**Connect to smart device**] and [**Connect to PC**] are automatically disabled.
- Information on [**Wireless transmitter**] can be found below; for information on [**Choose hardware**], [**Network settings**], and [**Options**], see the manual provided with the WT-7.

Wireless Transmitter

Select [**Use**] to enable WT-7 when it is connected to the camera.

Conformity Marking

MENU button ➡  setup menu



View some of the standards with which the camera complies.

Battery Info

MENU button ➡  setup menu

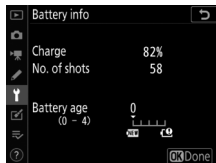
View information on the battery currently inserted in the camera.



Option	Description
[Charge]	The current battery level expressed as a percentage.
[No. of shots]	The number of times the battery has been used to release the shutter since it was last charged.
[Battery age]	A five-level display showing battery age. <ul style="list-style-type: none">• A value of "0" () indicates that battery performance is unimpaired.• A value of "4" () indicates that the battery has reached the end of its charging life. Replace the battery.

✔ Number of Shots

[**No. of shots**] shows the number of times the shutter has been released. Note that the camera may sometimes release the shutter without recording a photograph, for example when measuring preset white balance.

✔ Charging Batteries at Low Temperatures

Batteries in general exhibit a drop in capacity at low ambient temperatures. Even fresh batteries charged at temperatures under about 5 °C (41 °F) may show a temporary increase from “0” to “1” in the value shown for [**Battery age**], but the display will return to normal once the battery has been recharged at a temperature of about 20 °C (68 °F) or higher.

Slot Empty Release Lock

MENU button ➔  setup menu

Choose whether the shutter can be released when no memory card is inserted in the camera.

	Option	Description
LOCK	[Release locked]	The shutter cannot be released when no memory card is inserted.
OK	[Enable release]	The shutter can be released with no memory card inserted. No pictures will be recorded; during playback, the camera displays “Demo”.

Save/Load Menu Settings

MENU button ➡  setup menu

Save current camera menu settings to a memory card. You can also load saved settings, allowing menu settings to be shared among cameras of the same model.

- If two memory cards are inserted, the settings will be saved to the card in Slot 1.
- The following settings are saved:

Settings that can be saved and loaded

PLAYBACK MENU	[Playback display options]
	[Image review]
	[After delete]
	[Rotate tall]

Settings that can be saved and loaded

PHOTO SHOOTING MENU	[File naming]
	[Role played by card in Slot 2]
	[Image area]
	[Image quality]
	[Image size]
	[NEF (RAW) recording]
	[ISO sensitivity settings]
	[White balance]
	[Set Picture Control] (Custom Picture Controls are saved as [Auto])
	[Color space]
	[Active D-Lighting]
	[Long exposure NR]
	[High ISO NR]
	[Vignette control]
	[Diffraction compensation]
	[Auto distortion control]
	[Flicker reduction]
	[Flash control]
[Auto bracketing]	
[Silent live view photography]	

Settings that can be saved and loaded

MOVIE SHOOTING MENU	[File naming]
	[Destination]
	[Image area]
	[Frame size/frame rate]
	[Movie quality]
	[Movie file type]
	[ISO sensitivity settings]
	[White balance]
	[Set Picture Control] (Custom Picture Controls are saved as [Auto])
	[Active D-Lighting]
	[High ISO NR]
	[Diffraction compensation]
	[Flicker reduction]
	[Electronic VR]
	[Microphone sensitivity]
	[Attenuator]
[Frequency response]	
[Wind noise reduction]	
[Headphone volume]	
[Timecode] (excepting [Timecode origin])	
CUSTOM SETTING MENU	All Custom Settings

Settings that can be saved and loaded

SETUP MENU	[Save user settings]
	[Language]
	[Time zone and date] (excepting [Date and time])
	[Information display]
	[Non-CPU lens data]
	[Clean image sensor]
	[Image comment]
	[Copyright information]
	[Beep options]
	[Touch controls]
	[HDMI]
	[Location data] (excepting [Position])
	[Wireless remote (WR) options]
	[Assign remote (WR) Fn button]
	[Slot empty release lock]

Save Menu Settings

Save settings to the memory card. If the card is full, an error will be displayed and settings will not be saved. Saved settings can only be used with other cameras of the same model.

Load Menu Settings

Load saved settings from the memory card. Note that [**Load Menu Settings**] is available only when a memory card containing saved settings is inserted.

Saved Settings

Settings are saved to files named "NCSET****". "****" is an identifier that varies from camera to camera. The camera will not be able to load settings if the file name is changed.

Reset All Settings

MENU button ➡  setup menu

Reset all settings except [**Language**] and [**Time zone and date**] to their default values. Copyright information and other user-generated entries are also reset. Once reset, settings cannot be restored.

We recommend that you save settings using the [**Save/load menu settings**] item in the setup menu before performing a reset.

Firmware Version

MENU button ➡  setup menu

View the current camera firmware version.





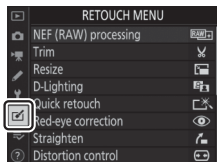







The Retouch Menu: Creating Retouched Copies

To view the retouch menu, select the  tab in the camera menus.



The items in the retouch menu are used to trim or retouch existing pictures.

- The retouch menu is only displayed when a memory card containing photographs is inserted in the camera.
- Retouched copies are saved to new files, separate from the original pictures.
- The retouch menu contains the following items:

Item			Item	
	[NEF (RAW) processing]	713		[Straighten] 729
	[Trim]	719		[Distortion control] 730
	[Resize]	720		[Perspective control] 732
	[D-Lighting]	726		[Monochrome] 733
	[Quick retouch]	727		[Image overlay]* 734
	[Red-eye correction]	728		[Trim movie] 743

* Not displayed when [Retouch] is selected in the playback **i** menu.

Creating Retouched Copies

1 Select an item in the retouch menu.

Press \uparrow or \downarrow to highlight an item, \rightarrow to select.

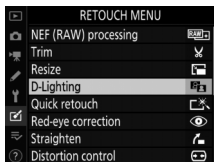

2 Select a picture.

- Highlight a picture using the multi selector.
- To view the highlighted picture full screen, press and hold the QUAL button.
- Press OK to select the highlighted picture.



3 Select retouch options.

- For more information, see the section for the selected item.
- To exit without creating a retouched copy, press **MENU**. The retouch menu will be displayed.

4 Create a retouched copy.

- Press **OK** to create a retouched copy.
- Retouched copies are indicated by a  icon.

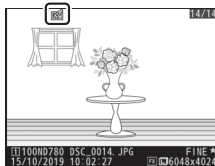

✓ Retouching the Current Image

To create a retouched copy of the current image, press **i** and select **[Retouch]**.

✓ Retouch

- The camera may not be able to display or retouch images that were taken or retouched using other cameras or that have been retouched on a computer.
- If no actions are performed for a brief period, the display will turn off and any unsaved changes will be lost. To increase the time the display remains on, choose a longer menu display time using Custom Setting c4 **[Monitor off delay]** > **[Menus]**.

✓ Retouching Copies

- Most options can be applied to copies created using other retouch options, although multiple edits may result in reduced image quality or faded colors.
- With the exception of **[Trim movie]**, each option can be applied only once.
- Some options may be unavailable depending on the options used to create the copy.
- Options that cannot be applied to the current image are grayed out and unavailable.

✔ Image Quality

- Copies created from NEF (RAW) images are saved at an **[Image quality]** of **[JPEG fine★]**.
- Copies created from JPEG images are the same quality as the original.
- In the case of images recorded to the same memory card at image quality settings of NEF + JPEG, only the NEF (RAW) image will be retouched.

✔ Image Size

Except in the case of copies created with **[NEF (RAW) processing]**, **[Trim]**, and **[Resize]**, copies are the same size as the original.

NEF (RAW) Processing: Creating JPEG Copies of NEF (RAW) Images Without a Computer

MENU button ➡  retouch menu



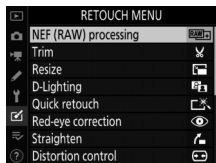

“NEF (RAW) processing” is used to save NEF (RAW) photos in other formats, such as JPEG. JPEG copies of NEF (RAW) photos can be created on the camera as described below.

1 Select [NEF (RAW) processing] in the retouch menu.

Highlight [NEF (RAW) processing] and press .



2 Choose a destination.

- If two memory cards are inserted, you can choose a destination for the retouched copies by highlighting [**Choose destination**] and pressing .
- [**Choose destination**] is not available when only one memory card is inserted. Proceed to Step 3.
- Press  or  to highlight a card slot and press .

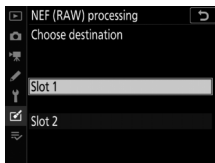
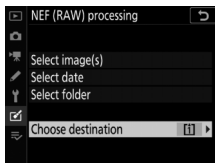

3 Choose how images are selected.

Option	Description
[Select image(s)]	Create JPEG copies of selected NEF (RAW) images. Multiple NEF (RAW) images can be selected.
[Select date]	Create JPEG copies of all the NEF (RAW) images taken on selected dates.
[Select folder]	Create JPEG copies of all the NEF (RAW) images in a selected folder.

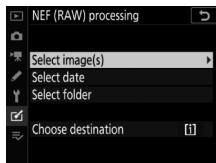

If you chose [**Select image(s)**], proceed to Step 5.





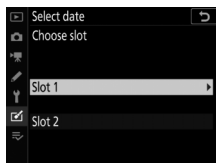

4 Select the source slot.

- Highlight the slot with the card containing the NEF (RAW) images and press .
- You will not be prompted to select the slot if only one memory card is inserted.





5 Select photographs.

If you chose [Select image(s)]:

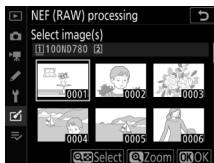
- Highlight images using the multi selector.
- To view the highlighted picture full screen, press and hold the  (QUAL) button.
- To select the highlighted image, press the  (Select) button. Selected images are indicated by a  icon. To deselect the current picture, press the  button again; the  will no longer be displayed. All images will be processed using the same settings.
- Press  to save changes.



If you chose [Select date]:

- Highlight dates using the multi selector and press  to select () or deselect () .
- All images taken on dates marked with a check () will be processed using the same settings.
- Press  to save changes.

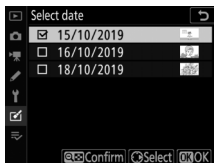

If you chose [Select folder]:

Highlight a folder and press  to select; all images in the selected folder will be processed using the same settings.

6 Choose settings for the JPEG copies.

- The settings in effect when the photograph was taken appear below a preview.
- To use the setting in effect when the photograph was taken, if applicable, select [**Original**].

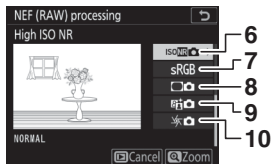
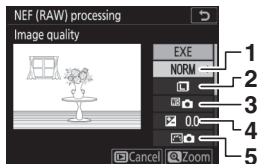

- 1 Image quality (📖 134)
- 2 Image size (📖 137)
- 3 White balance (📖 195)
- 4 Exposure compensation (📖 175)
- 5 Set Picture Control (📖 243)

- 6 High ISO NR (📖 557)
- 7 Color space (📖 554)
- 8 Vignette control (📖 558)
- 9 Active D-Lighting (📖 254)
- 10 Diffraction compensation (📖 559)

7 Copy the photographs.

- Highlight **[EXE]** and press **OK** to create a JPEG copy of the selected photograph.
- If multiple photos are selected, a confirmation dialog will be displayed after you highlight **[EXE]** and press **OK**; highlight **[Yes]** and press **OK** to create JPEG copies of the selected photos.
- To exit without copying the photographs, press the **MENU** button.

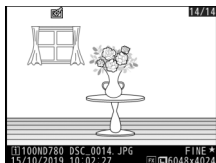



✓ NEF (RAW) Processing

- NEF (RAW) processing is available only with NEF (RAW) images created with this camera. Images in other formats and NEF (RAW) images taken with other cameras or Camera Control Pro 2 cannot be selected.
- **[Exposure compensation]** can only be set to values between -2 and $+2$ EV.

Trim

MENU button ➡  retouch menu

Create a cropped copy of the selected photograph. The photograph is displayed with the selected crop shown in yellow; create a cropped copy as described below.

To	Description
Size the crop	Press  (QUAL) or  (CROP) to choose the crop size.
To change the crop aspect ratio	Rotate the main command dial.
To position the crop	Use the multi selector.
To create a cropped copy	Press  to save the current crop as a separate file.

Cropped Images

- Depending on the size of the cropped copy, playback zoom may not be available when cropped copies are displayed.
- The crop size appears at upper left in the crop display. The size of the copy varies with crop size and aspect ratio.

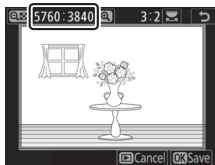

Resize

MENU button ➡  retouch menu

Create small copies of selected photographs. If two memory cards are inserted, you can choose the card used to store the resized copies.

Resizing Multiple Images



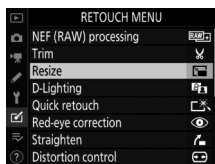

If you accessed the retouch menu via the MENU button, you can resize multiple selected images.

1 Select [Resize] in the retouch menu.

Highlight [Resize] and press .



2 Choose a destination.

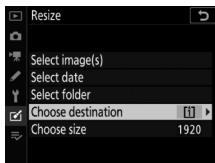

- If two memory cards are inserted, you can choose a destination for the retouched copies by highlighting [**Choose destination**] and pressing .
- [**Choose destination**] is not available when only one memory card is inserted. Proceed to Step 3.
- Press  or  to highlight a card slot and press .



3 Choose a size.

- Highlight [**Choose size**] and press .



- Highlight the desired size (length in pixels) using  and  and press .

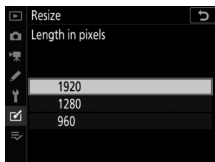

4 Choose how images are selected.

Option	Description
[Select image(s)]	Resize selected images. Multiple images can be selected.
[Select date]	Resize all the images taken on selected dates.
[Select folder]	Resize all the images in a selected folder.

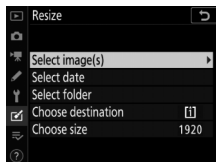

If you chose [Select image(s)], proceed to Step 6.

5 Select the source slot.

- Highlight the slot with the card containing the images and press .
- You will not be prompted to select the slot if only one memory card is inserted.

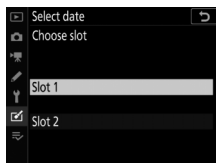

6 Choose pictures.

If you chose [Select image(s)]:

- Highlight pictures using the multi selector.
- To view the highlighted picture full screen, press and hold the **QUAL** button.
- To select the highlighted image, press the **Select** button. Selected pictures are marked by a **Select** icon. To deselect the highlighted picture, press the **Select** button again; the **Select** icon will no longer be displayed. The selected pictures will all be copied at the size selected in Step 3.
- Press **OK** to proceed once selection is complete.



If you chose [Select date]:

- Highlight dates using the multi selector and press **▶** to select () or deselect ()
- All images taken on dates marked with a check () will be copied at the size selected in Step 3.
- Press **Ⓚ** to proceed after selecting the desired dates.

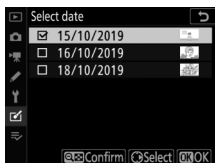

If you chose [Select folder]:

- Highlight a folder and press **Ⓚ** to select; all images in the selected folder will be copied at the size selected in Step 3.

7 Save the resized copies.

A confirmation dialog will be displayed; highlight [Yes] and press **Ⓚ** to save the resized copies.

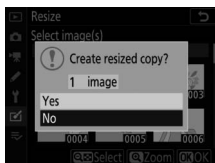

✓ Resize

Depending on the size of the resized copy, playback zoom may not be available when resized copies are displayed.

D-Lighting

MENU button ➡  retouch menu

D-Lighting brightens shadows. It is ideal for dark or backlit photographs.

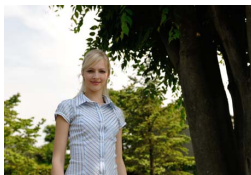



Before



After

The edit display shows before and after images.

- Press  or  to choose the amount of correction performed. The effect can be previewed in the edit display.
- Press  to save the retouched copy.





Quick Retouch

MENU button ➡  retouch menu

Create a copy with enhanced colors and contrast.

The camera uses D-Lighting to brighten shadows and enhance contrast and color saturation (vividness).

- Press  or  to choose the amount of correction performed. The effect can be previewed in the edit display.
- Press  to save the retouched copy.

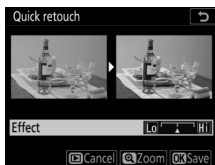

Red-Eye Correction

MENU button ➡  retouch menu

Correct “red-eye” caused by light from the flash reflecting from the retinas of portrait subjects.

- Red-eye correction is available only with photographs taken using a flash.
- Red-eye that cannot be detected by the camera will not be corrected.
- Press  to save the retouched copy.



Red-Eye Correction

- Note the following:
 - Red-eye correction may not always produce the expected results.
 - In very rare circumstances, red-eye correction may be applied to portions of the image that are not affected by red-eye.
 - Check the preview thoroughly before proceeding.
-

Straighten

MENU button ➡  retouch menu

Rotate pictures by up to $\pm 5^\circ$ in increments of approximately 0.25° .

- The effect can be previewed in the edit display.
- The greater the rotation, the more will be trimmed from the edges.
- Press  or  to choose the amount of straightening performed.
- Press  to save the retouched copy.

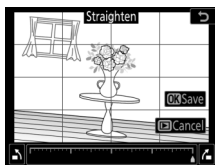

Distortion Control



MENU button ➡  retouch menu

Create copies with reduced peripheral distortion; this can reduce barrel distortion in pictures taken with wide-angle lenses or pin-cushion distortion in pictures taken with telephoto lenses.

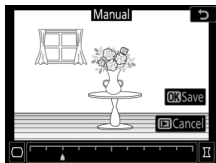
Select [**Auto**] to let the camera correct distortion automatically and then make fine adjustments using the multi selector. Select [**Manual**] to reduce distortion manually.



- The effect can be previewed in the edit display.
- [**Auto**] is for use only with pictures taken with type G, E, and D lenses. Note, however, that some lenses of these types, including PC and fisheyes lenses, cannot be used. Results are not guaranteed with other lenses.

- Note that [**Manual**] must be used with copies created using the [**Auto**] option and with photos taken using the [**Auto distortion control**] option in the photo shooting menu. Manual distortion control cannot be further applied to copies created using [**Manual**].
- Press  to reduce pincushion distortion,  to reduce barrel distortion.
- Press  to save the retouched copy.

Distortion Control

- Note that greater amounts of distortion control result in more of the edges being cropped out.
 - Distortion control may heavily crop or distort the edges of copies created from photographs taken with DX lenses at image areas other than [**DX (24×16)**].
-

Perspective Control

MENU button ➡  retouch menu

Create copies that reduce the effects of perspective in photos taken looking up from the base of a tall object.

- The effect can be previewed in the edit display.
- Note that greater amounts of perspective control result in more of the edges being cropped out.
- Use the multi selector (⬆️, ⬇️, ⬅️, or ⬇️) to adjust perspective.
- Press **OK** to save the retouched copy.

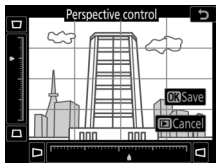

Before





After

Monochrome

MENU button ➡  retouch menu

Copy photographs in monochrome. [**Monochrome**] gives you a choice of the following monochrome tints:

Option	Description
[Black-and-white]	Copy photographs in black-and-white.
[Sepia]	Copy photographs in sepia.
[Cyanotype]	Copy photographs in blue-and-white monochrome.

- The effect can be previewed in the edit display.
- In the case of [**Sepia**] or [**Cyanotype**], color saturation can be adjusted using the multi selector. Press  to increase,  to decrease. The changes are reflected in the preview.
- Press  to save the retouched copy.

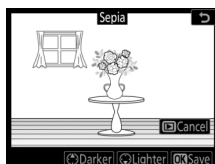

Image Overlay

MENU button ➡  retouch menu

Image overlay combines existing photographs to create a single picture that is saved separately from the originals. One NEF (RAW) image can be overlaid on another using additive blending (**[Add]**), or multiple images can be combined using **[Lighten]** or **[Darken]** blending.

Add

Overlay two NEF (RAW) images to create a single new JPEG copy.



1 Select [Image overlay] in the retouch menu.

Highlight **[Image overlay]** and press .

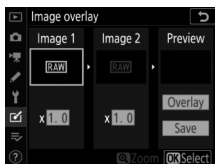

2 Select [Add].

Highlight **[Add]** and press  to display image overlay options with **[Image 1]** highlighted.

3 Highlight the first image.

- Press **OK** to display a picture selection dialog listing only NEF (RAW) images, where you can use the multi selector to highlight the first photograph in the overlay.
- To view the highlighted picture full screen, press and hold the **QUAL** button.

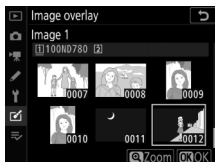

4 Select the first image.

Press **OK** to select the highlighted photograph and return to the preview display; the selected image will appear as **[Image 1]**.

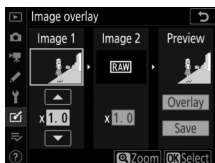

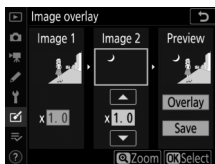

5 Select the second image.

Press **QUAL** and select **[Image 2]**, then select the second photo as described in Steps 3 and 4.



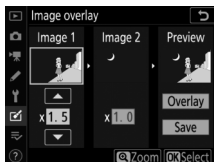

6 Adjust gain.

- The overlay of [**Image 1**] and [**Image 2**] can be previewed in the “Preview” column. Highlight [**Image 1**] or [**Image 2**] and optimize exposure for the overlay by pressing  or  to adjust gain.
- Choose from values between 0.1 and 2.0 in increments of 0.1.
- The effects are relative to the default value of 1.0 (no gain). For example, selecting 0.5 halves gain.





7 Select the “Preview” column.

- Press  or  to place the cursor in the “Preview” column.
- To proceed without previewing the overlay, highlight [**Save**] and press .



8 Preview the overlay.

- To preview the overlay, highlight [**Overlay**] and press .
- To select new photos or adjust gain, press  (). You will be returned to Step 6.



9 Save the overlay.

Press **OK** while the preview is displayed to save the overlay and display the resulting image.



✓ [Add]

- Colors and brightness in the preview may differ from the final image.
- Image overlay is available only with NEF (RAW) images created with this camera. Images created with other cameras or in other formats cannot be selected.
- The overlay is saved at an **[Image quality]** of **[JPEG fine★]**.
- NEF (RAW) images can be combined only if they were created with the same options selected for:
 - **[Image area]** > **[Choose image area]**
 - **[NEF (RAW) recording]** > **[NEF (RAW) bit depth]**
- The overlay has the same photo info (including date of recording, metering, shutter speed, aperture, shooting mode, exposure compensation, focal length, and image orientation) and values for white balance and Picture Control as the photograph selected for **[Image 1]**. Copyright information, however, is not copied to the new image. The comment is similarly not copied; instead, the comment currently active on the camera, if any, is appended.

Lighten and Darken

The camera compares multiple selected pictures and selects only the brightest or darkest pixels at each point in the image to create a single new JPEG copy.

1 Select **[Lighten]** or **[Darken]**.

After selecting **[Image overlay]** in the retouch menu, highlight either **[Lighten]** or **[Darken]** and press .

- **Lighten:** The camera compares the pixels in each picture and uses only the brightest.



- **Darken:** The camera compares the pixels in each picture and uses only the darkest.



2 Choose how images are selected.





Option	Description
[Select individual images]	Select pictures for the overlay one-by-one.
[Select consecutive images]	Select two pictures; the overlay will include the two pictures and all images between them.
[Select folder]	The overlay will include all pictures in the selected folder.

3 Select the source slot.







- Highlight the slot with the card containing the pictures and press .
- You will not be prompted to select the slot if only one memory card is inserted.

4 Select pictures.

If you chose [Select individual images]:

- Highlight pictures using the multi selector.
- To view the highlighted picture full screen, press and hold the  (QUAL) button.
- To select the highlighted image, press the  button. Selected pictures are marked by a icon. To deselect the highlighted picture, press the  button again; the icon will no longer be displayed. The selected pictures will be combined using the option selected in Step 1.
- Press  to proceed once selection is complete.

If you chose [Select consecutive images]:

- All pictures in a range chosen using the multi selector will be combined using the option selected in Step 1.
 - Use the  () button to select the first and last pictures in the desired range.
 - The first and last pictures are indicated by  icons and the pictures between them by  icons.
 - You can alter your selection by using the multi selector to highlight different pictures to serve as the first or last frame. Press the  (WB) button to choose the current picture as the new start or end point.
- To view the highlighted picture full screen, press and hold the  (QUAL) button.
- Press  to proceed once selection is complete.

If you chose [Select folder]:

Highlight the desired folder and press  to overlay all pictures in the folder using the option selected in Step 1.

5 Save the overlay.

- A confirmation dialog will be displayed; highlight **[Yes]** and press **OK** to save the overlay and display the resulting picture.
- To interrupt the process before the overlay is complete, press **MENU**.

[Lighten]/[Darken]

- The overlay will include only pictures created with this camera. Pictures created with other cameras cannot be selected.
 - The overlay will include only pictures created with the same options selected for:
 - **[Image area]** > **[Choose image area]**
 - **[Image size]**
 - Overlays that include pictures taken at different image quality settings will be saved at the same setting as the image with the highest image quality.
 - Overlays that include NEF (RAW) pictures will be saved at an image quality of **[JPEG fine★]**.
 - Overlays that include both NEF (RAW) and JPEG pictures will be the same size as the JPEG pictures.
-

Trim Movie

MENU button ➡  retouch menu

Create a copy from which unwanted footage has been removed ( 271).

☰ MY MENU / ⌚ RECENT SETTINGS

To view **[MY MENU]**, select the ☰ tab in the camera menus.

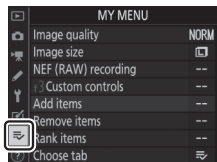

My Menu: Creating a Custom Menu

My Menu can be used to create and edit a customized list of up to 20 items from the playback, photo shooting, movie shooting, Custom Settings, setup, and retouch menus. Items can be added, deleted, and reordered as described below.

■ Adding Items to My Menu

1 Select [Add items] in [MY MENU].

Highlight [**Add items**] and press .

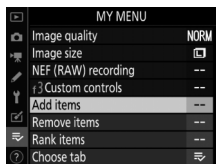

2 Select a menu.

Highlight the name of the menu containing the item you wish to add and press .

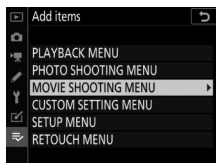

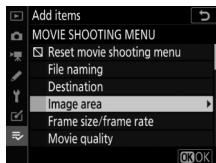

3 Select an item.

Highlight the desired menu item and press .



4 Position the new item.

Press  or  to position the new item and press  to add it to My Menu.



5 Add more items.

- The items currently displayed in My Menu are indicated by a check mark (✓).
- Items indicated by a  icon cannot be selected.
- Repeat Steps 1–4 to select additional items.

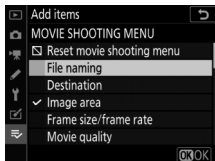

■ Removing Items from My Menu

1 Select [Remove items] in [⇨ MY MENU].



Highlight [Remove items] and press .

2 Select items.

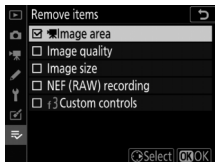
- Highlight items and press  to select () or deselect.
- Continue until all the items you wish to remove are selected ()



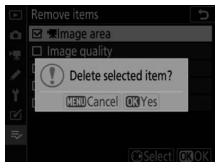

3 Remove the selected items.

Press ; a confirmation dialog will be displayed. Press  again to remove the selected items.



✓ Removing Items While in My Menu

Items can also be removed by highlighting them in [⇨ MY MENU] and pressing the  button; a confirmation dialog will be displayed. Press  again to remove the selected item.

■ Reordering Items in My Menu

1 Select [Rank items] in [⇨ MY MENU].



Highlight [Rank items] and press .

2 Select an item.

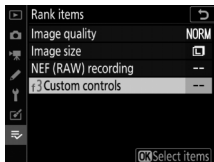
Highlight the item you wish to move and press .



3 Position the item.

- Press  or  to move the item up or down in My Menu and press .
- Repeat Steps 2–3 to reposition additional items.



4 Exit to [⇨ MY MENU].

Press the MENU button to return to [⇨ MY MENU].

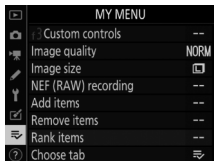
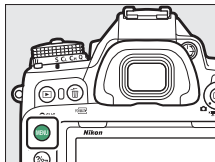



■ Displaying Recent Settings

1 Select [Choose tab] in [MY MENU].

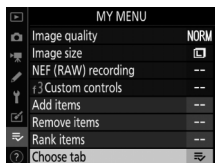
Highlight [**Choose tab**] and press .



2 Select [RECENT SETTINGS].

- Highlight [ **RECENT SETTINGS**] in the [**Choose tab**] menu and press .
- The name of the menu will change from [**MY MENU**] to [**RECENT SETTINGS**].

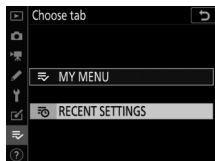



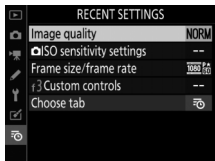

Recent Settings: Accessing Recently-Used Settings

How Items Are Added to Recent Settings



Menu items are added to the top of the recent settings menu as they are used. The twenty most recently settings are listed.



Removing Items from the Recent Settings Menu

To remove an item from the [RECENT SETTINGS] menu, highlight it and press the  () button; a confirmation dialog will be displayed. Press  () again to remove the selected item.

Displaying My Menu

Selecting [**Choose tab**] in the recent settings menu displays the items shown in Step 2 of “Displaying Recent Settings” ( 749). Highlight [ **MY MENU**] and press  to view My Menu.

Troubleshooting

Before Contacting Customer Support

You may be able to resolve any issues with the camera by following the steps below. Check this list before consulting your retailer or Nikon-authorized service representative.

STEP 1

Check the common problems listed in the following sections:

- “Problems and Solutions” (□ 753)
- “Alerts and Error Messages” (□ 765)

STEP 2

Turn the camera off and remove the battery, then wait about a minute, re-insert the battery and turn the camera on.

- ✓ The camera may continue to write data to the memory card after shooting. Wait at least a minute before removing the battery.

STEP 3

Search Nikon websites.

- For support information and answers to frequently asked questions, visit the website for your country or region (□ xlv).
(□ xlv).
- To download the latest firmware for your camera, visit: <https://downloadcenter.nikonimglib.com/>

STEP 4

Consult a Nikon-authorized service representative.

✓ Restoring Default Settings

- Depending on current settings, some menu items and other features may be unavailable. To access menu items that are grayed out or features that are otherwise unavailable, try restoring default settings using the **[Reset all settings]** item in the setup menu.
 - Note, however, that wireless network profiles, copyright information, and other user-generated entries will also be reset. Once reset, settings cannot be restored.
-

Problems and Solutions

Solutions to some common issues are listed below.

Battery/Display

● **The camera is on but does not respond:**

- Wait for recording and other operations to end.
 - If the problem persists, turn the camera off.
 - If the camera does not turn off, remove and reinsert the battery.
 - If you are using an AC adapter, disconnect and reconnect the AC adapter.
 - Any data currently being recorded will be lost.
 - Data that have already been recorded are not affected by removing or disconnecting the power source.
-

● **The viewfinder is out of focus:**

- Rotate the diopter adjustment control to adjust viewfinder focus.
 - If adjusting viewfinder focus does not correct the problem, set the autofocus mode to **AF-S** and the AF-area mode to [**Single-point AF**]. Next, select the center focus point, choose a high-contrast subject, and focus using autofocus. With the camera in focus, use the diopter adjustment control to bring the subject into clear focus in the viewfinder.
 - If necessary, viewfinder focus can be further adjusted using optional corrective lenses.
-

● **The viewfinder is dark:**

Is the battery charged? The viewfinder may dim if the battery is exhausted or not inserted.

● **The display in the viewfinder, control panel, or monitor turns off without warning:**

Choose longer delays for Custom Setting c2 [**Standby timer**] or c4 [**Monitor off delay**].

● **The display in control panel or viewfinder is dim and unresponsive:**

The response times and brightness of these displays vary with temperature.

● **Patterns appear in the viewfinder:**

The viewfinder display may turn red when a focus point is highlighted, but this is normal for this type of viewfinder and does not indicate a malfunction.

Shooting

● **The camera takes time to turn on:**

More time will be needed to find files if the memory card contains large numbers of files or folders.

● **The shutter cannot be released:**

- Is a memory card inserted, and if so, does it have space available?
- Is the memory card write-protected?
- Is the in-focus indicator (●) displayed?
- When a CPU lens of a type other than G or E is attached, the shutter cannot be released unless the aperture ring is locked at minimum aperture (the highest f-number). If **fE E** is displayed in the control panel, select [**Aperture ring**] for Custom Setting f5 [**Customize command dials**] > [**Aperture setting**] and adjust aperture using the lens aperture ring.
- If you selected mode **S** after selecting a shutter speed of **b u l b** (Bulb) or **- -** (Time) in mode **M**, choose a different shutter speed.
- Is [**Release locked**] selected for [**Slot empty release lock**] in the setup menu?

● **The camera is slow to respond to the shutter-release button:**

Select [**Off**] for Custom Setting d4 [**Exposure delay mode**].

● **Burst shooting is unavailable:**

Burst shooting cannot be used in conjunction with HDR.

● **Photos are out of focus:**

- Is the camera in manual focus mode? To enable autofocus, rotate the focus-mode selector to **AF**.
- Autofocus does not perform well under the following conditions. In these cases, use manual focus or focus lock. Autofocus does not perform well if: there is little or no contrast between the subject and the background, the focus point contains objects at different distances from the camera, the subject is dominated by regular geometric patterns, the focus point contains areas of sharply contrasting brightness, background objects appear larger than the subject, or the subject contains many fine details.

● **The beep does not sound:**

- A beep does not sound when **AF-C** is selected for autofocus mode or **AF-A** is selected and the camera is shooting using **AF-C**.
- Select an option other than **[Off]** for **[Beep options]** > **[Beep on/off]** in the setup menu.

● **The full range of shutter speeds is not available:**

Using a flash restricts the range of shutter speeds available. Flash sync speed can be set to values of $1/200$ – $1/60$ s using Custom Setting e1 **[Flash sync speed]**. When using flash units that support auto FP high-speed sync, choose **[1/200 s (Auto FP)]** for a full range of shutter speeds.

● **Focus does not lock when the shutter-release button is pressed halfway:**

If **AF-C** is selected for autofocus mode or **AF-A** is selected and the camera is shooting using **AF-C**, focus can be locked using the **AE-L/AF-L** button.

● **Focus-point selection is not available:**

- Is the focus selector lock in the **L** (lock) position?
- Focus-point selection is not available when [**Auto-area AF**] is selected for AF-area mode.
- Focus point selection is not available in playback mode or when menus are in use.
- Has the standby timer expired? To enable focus-point selection, press the shutter-release button halfway.

● **Image size cannot be changed:**

[**Image quality**] set to [**NEF (RAW)**].

● **The camera is slow to record photos:**

Is [**On**] selected for [**Long exposure NR**] in the photo shooting menu?

● **“Noise” (bright spots, randomly-spaced bright pixels, fog, or lines) appears in photos:**

- To reduce noise, adjust settings such as ISO sensitivity, shutter speed, or Active D-Lighting.
 - At high ISO sensitivities, noise may become more noticeable in long exposures or in pictures recorded when the camera temperature is elevated.
-

● **Photographs and movies do not appear to have the same exposure as the preview shown in the monitor during live view:**

Changes to monitor brightness during live view have no effect on images recorded with the camera.

● **Flicker or banding appears in the display during movie recording:**

Select [**Flicker reduction**] in the movie shooting menu and choose an option that matches the frequency of the local AC power supply.

● **Bright regions or bands appear in live view:**

Bright regions or bands may occur if a flashing sign, flash, or other light source with brief duration is used during live view.

● **Smudges appear in photographs:**

- Are there smudges on the front or rear (mount-side) lens elements?
 - Is there foreign matter on the low-pass filter? Perform image sensor cleaning.
-

● **Pictures are affected by noticeable ghosting or flare:**

You may notice ghosting or flare in shots that include the sun or other bright light sources. These effects can be mitigated by attaching a lens hood or by composing shots with bright light sources well out of the frame. You can also try such techniques as removing lens filters, choosing a different shutter speed, or using silent photography.

● **Live view ends unexpectedly or does not start:**

- Live view may end automatically to prevent damage to the camera's internal circuits, for example if:
 - The ambient temperature is high
 - The camera has been used for extended periods in live view or to record movies
 - The camera has been used in continuous release modes for extended periods
 - If the camera is running hot and live view does not start, wait for the internal circuits to cool and then try again. Note that the camera may feel warm to the touch, but this does not indicate a malfunction.
-

● **“Noise” (bright spots, randomly-spaced bright pixels, fog, or lines) appears during live view:**

- Randomly-spaced bright pixels, fog, or bright spots may arise as a result of increases in the temperature of the camera’s internal circuits during live view. Exit live view when the camera is not in use.
- Randomly-spaced bright pixels, fog, lines or unexpected colors may appear if you press the **Q** (**QUAL**) button to zoom in on the view through the lens during live view.
- In movies, the amount and distribution of randomly-spaced bright pixels, fog, and bright spots are affected by the option selected for [**Frame size/frame rate**] in the movie shooting menu.
- Note that the distribution of noise in the monitor may differ from that in the final picture.

● **The camera cannot measure a value for preset manual white balance:**

The subject is too dark or too bright.

● **Certain pictures cannot be selected as sources for preset white balance:**

Pictures created with cameras of other types cannot serve as sources for preset manual white balance.

● **White balance (WB) bracketing is unavailable:**

- White balance bracketing is not available when an NEF (RAW) or NEF + JPEG option is selected for image quality.
- White balance bracketing cannot be used in multiple exposure and HDR modes.

● **The effects of [Set Picture Control] differ from image to image:**

[Auto] is selected for [Set Picture Control] or as the basis for a custom Picture Control created using [Manage Picture Control], or [A] (auto) is selected for [Quick sharp], [Contrast], or [Saturation]. For consistent results over a series of photographs, choose a setting other than [A] (auto).

● **The option selected for metering cannot be changed:**

The option selected for metering cannot be changed during exposure lock.

● **Exposure compensation is not available:**

Changes to exposure compensation in mode **M** apply only to the exposure indicator and have no effect on shutter speed or aperture.

● **Uneven shading may appear in long exposures:**

Uneven shading may appear in long exposures shot at shutter speeds of **b** **u** **l** **b** (Bulb) or - - (Time). The effect can be mitigated by selecting [On] for [Long exposure NR] in the photo shooting menu.

● **Sound is not recorded with movies:**

Is [Microphone off] selected for [Microphone sensitivity] in the movie shooting menu?

Playback

● **NEF (RAW) pictures are not visible during playback:**

The camera displays only the JPEG copies of pictures taken with [NEF(RAW) + JPEG fine★], [NEF(RAW) + JPEG fine], [NEF(RAW) + JPEG normal★], [NEF(RAW) + JPEG normal], [NEF(RAW) + JPEG basic★], or [NEF(RAW) + JPEG basic] selected for [Image quality].

● **Pictures taken with other cameras are not displayed:**

Pictures recorded with other types of camera may not display correctly.

● **Not all photos are visible during playback:**

Select [All] for [Playback folder] in the playback menu.

● **“Tall” (portrait) orientation photos are displayed in “wide” (landscape) orientation:**

- Is [Off] selected for [Rotate tall] in the playback menu?
 - Auto image rotation is not available during image review.
 - Camera orientation may not be correctly recorded in photos taken with the camera pointing up or down.
-

● **Pictures cannot be deleted:**

Are the pictures protected?

● **Pictures cannot be retouched:**

- The pictures cannot be further edited with this camera.
 - There is insufficient space on the memory card to record the retouched copy.
-

● **The camera displays the message, [Folder contains no images]:**

Select [All] for [Playback folder] in the playback menu.

● **Pictures are not displayed on HDMI devices:**

Confirm that an HDMI cable is correctly connected.

● **The Image Dust Off option in NX Studio does not have desired effect:**

Image sensor cleaning changes the position of dust on the low-pass filter and will not have the desired effect if:

- Dust off reference data recorded after image sensor cleaning is performed are used with photographs taken before image sensor cleaning is performed
- Dust off reference data recorded before image sensor cleaning is performed are used with photographs taken after image sensor cleaning is performed

● **The effects of [Set Picture Control], [Active D-Lighting], or [Vignette control] are not visible:**

In the case of NEF (RAW) pictures, the effects can only be viewed using Nikon software. View NEF (RAW) pictures using NX Studio.

● **Pictures cannot be copied to a computer:**

Depending on the operating system, you may be unable to upload pictures when the camera is connected to a computer. Copy pictures from the memory card to a computer using a card reader or other device.

Bluetooth and Wi-Fi (Wireless Networks)

- **Smart devices do not display the camera SSID (network name):**
 - Navigate to the setup menu and confirm both that [**Disable**] is selected for [**Airplane mode**] and that [**Enable**] is selected for [**Connect to smart device**] > [**Pairing (Bluetooth)**] > [**Bluetooth connection**].
 - Try disabling and re-enabling wireless network features on the smart device.
-

- **The camera cannot connect to printers and other wireless devices:**

The camera cannot establish wireless connections to devices other than smartphones, tablets, and computers.

Miscellaneous

- **The date of recording is not correct:**

Is the camera clock set correctly? The clock is less accurate than most watches and household clocks; check it regularly against more accurate timepieces and reset as necessary.

- **Menu items cannot be selected:**







- Some items are not available at certain combinations of settings.
 - The [**Battery info**] item in the setup menu is not available when camera is powered by an optional power connector and AC adapter.
-







Alerts and Error Messages

This section lists the alerts and error messages that appear in the viewfinder, control panel, and monitor.

Alerts

The following alerts appear in the control panel and viewfinder:

Alert		Problem/solution
Control panel	Viewfinder	
 (flashes)	 (flashes)	Lens aperture ring is not set to minimum aperture. Set lens aperture ring to minimum aperture (highest f-number).
		Low battery. Ready spare battery.
 (flashes)	 (flashes)	Battery exhausted. <ul style="list-style-type: none">• Replace with spare battery.• Charge battery.
		Battery info not available. <ul style="list-style-type: none">• Battery cannot be used. Contact Nikon-authorized service representative.• Battery level is extremely low; charge battery.
		Battery cannot supply data to camera. Replace third-party batteries with genuine Nikon batteries.
		High battery temperature. Remove battery and wait for it to cool.

Alert		Problem/solution
Control panel	Viewfinder	
ΔF	ΔF	<p>Aperture shown in stops from maximum aperture. No lens attached, or non-CPU lens attached without specifying maximum aperture.</p> <p>Aperture value will be displayed if maximum aperture is specified.</p>
—	 (flashes)	<p>Camera unable to focus using autofocus.</p> <p>Change composition or focus manually.</p>
 (flashes)	 (flashes)	<p> (Bulb) selected in mode S.</p> <ul style="list-style-type: none"> • Change shutter speed. • Select mode M.
-- (flashes)	-- (flashes)	<p>-- (Time) selected in mode S.</p> <ul style="list-style-type: none"> • Change shutter speed. • Select mode M.
 (flashes)	 (flashes)	<p>Processing in progress.</p> <p>Wait for processing to complete.</p>
—	 (flashes)	<p>Flash has fired at full power.</p> <p>Photo may be underexposed. Check distance to subject and settings such as aperture, flash range, and ISO sensitivity.</p>



Alert		Problem/solution
Control panel	Viewfinder	
(Exposure indicators and shutter speed or aperture display flash)		<p>Subject too bright; limits of camera exposure metering system exceeded.</p> <ul style="list-style-type: none"> • Lower ISO sensitivity. • Mode P: Use third-party ND (neutral density) filter (filter can also be used if alert is still displayed after following settings are adjusted in mode S or A). • Mode S: Choose faster shutter speed. • Mode A: Choose smaller aperture (higher f-number).
		<p>Subject too dark; limits of camera exposure metering system exceeded.</p> <ul style="list-style-type: none"> • Increase ISO sensitivity. • Mode P: Use optional flash unit (flash can also be used if alert is still displayed after following settings are adjusted in mode S or A). • Mode S: Choose slower shutter speed. • Mode A: Choose wider aperture (lower f-number).

Alert		Problem/solution
Control panel	Viewfinder	
 (flashes)	—	<p>Flash unit that does not support red-eye reduction attached and flash mode set to red-eye reduction or red-eye reduction with slow sync.</p> <ul style="list-style-type: none"> • Use flash unit that supports red-eye reduction. • Change flash mode.
FULL (flashes)	Ful (flashes)	<p>Memory insufficient to record further photos.</p> <ul style="list-style-type: none"> • Delete pictures from memory card until there is room for additional pictures to be recorded. Copy pictures you wish to keep to computer or other device before proceeding. • Insert new memory card. <hr/> <p>Camera has run out of file numbers.</p> <ul style="list-style-type: none"> • Delete pictures from memory card until there is room for additional pictures to be recorded. Copy pictures you wish to keep to computer or other device before proceeding. • Insert new memory card.
Err (flashes)	Err (flashes)	<p>Camera malfunction.</p> <p>Press shutter-release button again. If error persists or appears frequently, consult Nikon-authorized service representative.</p>

Error Messages

The following alerts may appear in the monitor and control panel:

Alert		Problem/solution
Monitor	Control panel	
No memory card.	[- E -]	Memory card not inserted or inserted incorrectly. Check that card is inserted correctly.
Cannot access this memory card. Insert another card.	[Err], [Err] (flashes)	Error accessing memory card. <ul style="list-style-type: none">• Check that camera supports memory card.• If error persists after card has been repeatedly ejected and reinserted, card may be damaged. Contact retailer or Nikon-authorized service representative. Unable to create new folder. <ul style="list-style-type: none">• Delete pictures from memory card until there is room for additional pictures to be recorded. Copy pictures you wish to keep to computer or other device before proceeding.• Insert new memory card.

Alert		Problem/solution
Monitor	Control panel	
Memory card is locked. Slide lock to "write" position.	 (flashes)	Memory card is locked (write protected). Slide card write-protect switch to "write" position.
This card is not formatted. Format the card.	 (flashes)	Memory card is not correctly formatted. <ul style="list-style-type: none"> • Format memory card. • Replace with correctly-formatted memory card.
Unable to start live view. Please wait.	—	Camera's internal temperature is elevated. Suspend shooting until camera has cooled.
The camera is too hot. It cannot be used until it cools. Please wait.		

Alert		Problem/solution
Monitor	Control panel	
Folder contains no images.	—	Folder contains no pictures. Insert memory card that contains pictures.
		No pictures in folder selected for playback. Use [Playback folder] item in playback menu to select folder that contains pictures.
Cannot display this file.	—	File has been modified using computer application or does not conform to DCF file standard. Do not overwrite images using computer applications.
		File is corrupt. Do not overwrite images using computer applications.
Cannot select this file.	—	Selected picture cannot be retouched. Retouch options are available only with pictures taken with or previously retouched on camera.

Alert		Problem/solution
Monitor	Control panel	
This movie cannot be edited.	—	<p>Selected movie cannot be edited.</p> <ul style="list-style-type: none"> • Movies created with other devices cannot be edited. • Movies under two seconds long cannot be edited.
<p>This file cannot be saved to the destination memory card.</p> <p>See the camera's user's manual for details.</p>	—	<p>Files 4 GB or larger can only be saved to memory cards formatted for exFAT. They cannot be saved to cards formatted for other file systems, such as FAT32.</p> <p>Use a memory card with a capacity over 32 GB formatted in the camera or keep file size to under 4 GB.</p>

Technical Notes

Camera Displays

For illustrative purposes, the displays are shown with all indicators lit.

The Viewfinder

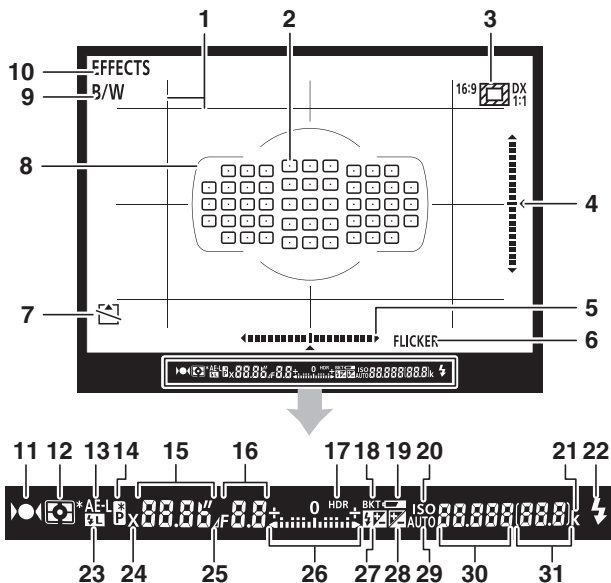

1	Framing grid ¹ (☐ 615)	18	Exposure/flash bracketing indicator (☐ 226)
2	Focus points (☐ 36, 145)		WB bracketing indicator (☐ 232)
3	Image area (☐ 129)		ADL bracketing indicator (☐ 238)
4	Pitch indicator ^{2,3} (☐ 628)	19	Low battery warning (☐ 33)
5	Roll indicator ^{2,4} (☐ 628)	20	ISO sensitivity indicator (☐ 187)
6	Flicker detection (☐ 561)	21	"k" (appears when memory remains for over 1000 exposures; ☐ 34)
7	"No memory card" indicator (☐ 28)	22	Flash-ready indicator ⁶ (☐ 460)
8	AF area brackets (☐ 36)	23	FV lock indicator (☐ 471)
9	Monochrome indicator ⁵ (☐ 119, 243)	24	Flash sync indicator (☐ 619)
10	Special effects mode indicator (☐ 119)	25	Aperture stop indicator (☐ 112, 795)
11	Focus indicator (☐ 36)	26	Exposure indicator Exposure (☐ 114) Exposure compensation (☐ 175) Exposure/flash bracketing (☐ 226) WB bracketing (☐ 232) ADL bracketing (☐ 238)
12	Metering (☐ 166)	27	Flash compensation indicator (☐ 469)
13	Autoexposure (AE) lock (☐ 173)		
14	Flexible program indicator (☐ 109)		
15	Shutter speed (☐ 110, 113) Autofocus mode (☐ 140)		
16	Aperture (f-number; ☐ 111, 113) Aperture (number of stops; ☐ 112, 795)		
17	HDR indicator (☐ 256)		

28	Exposure compensation indicator (☐ 175)
29	Auto ISO sensitivity indicator (☐ 190)
30	ISO sensitivity (☐ 187) Preset white balance recording indicator (☐ 210) Active D-Lighting amount (☐ 254)

31	Number of exposures remaining (☐ 34, 861) Number of shots remaining before memory buffer fills (☐ 181, 861) Exposure compensation value (☐ 175) Flash compensation value (☐ 469) PC mode indicator (☐ 819)
----	--

- 1 Displayed when **[On]** is selected for Custom Setting d10 **[Framing grid display]**.
- 2 Can be displayed by pressing a button to which **[Viewfinder virtual horizon]** has been assigned using Custom Setting f3 **[Custom controls]**.
- 3 Functions as a roll indicator when camera is rotated to take pictures in “tall” (portrait) orientation.
- 4 Functions as a pitch indicator when camera is rotated to take pictures in “tall” (portrait) orientation.
- 5 Displayed in  mode or when the **[Monochrome]** Picture Control or a Picture Control based on **[Monochrome]** is selected.
- 6 Displayed when an optional flash unit is attached. The flash-ready indicator lights when the flash is charged.

The Information Display

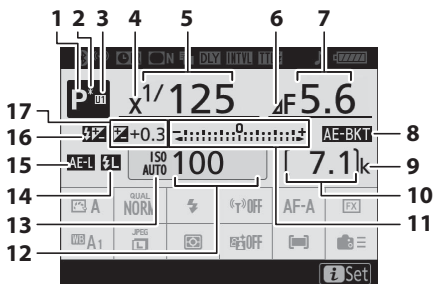

- | | |
|---|---|
| 1 | Shooting mode (☞ 107) |
| 2 | Flexible program indicator (☞ 109) |
| 3 | User setting mode (☞ 115) |
| 4 | Flash sync indicator (☞ 619) |
| 5 | Shutter speed (☞ 110, 113) |
| 6 | Aperture stop indicator (☞ 112, 795) |
| 7 | Aperture (f-number; ☞ 111, 113)
Aperture (number of stops; ☞ 112, 795) |

- | | |
|----|--|
| 8 | Exposure/flash bracketing indicator (☞ 226)
WB bracketing indicator (☞ 232)
ADL bracketing indicator (☞ 238)
HDR indicator (☞ 256)
Multiple exposure indicator (☞ 287) |
| 9 | "k" (appears when memory remains for over 1000 exposures; ☞ 34) |
| 10 | Number of exposures remaining (☞ 34, 861)
PC mode indicator (☞ 819) |

- | | | | |
|-----------|---|-----------|--|
| 11 | Exposure indicator
Exposure (📖 114)
Exposure compensation
(📖 175)
Exposure/flash bracketing
(📖 226)
WB bracketing (📖 232)
ADL bracketing (📖 238) | 14 | FV lock indicator (📖 471) |
| 12 | ISO sensitivity (📖 187) | 15 | Autoexposure (AE) lock
(📖 173) |
| 13 | ISO sensitivity indicator
(📖 187)
Auto ISO sensitivity indicator
(📖 190) | 16 | Flash compensation indicator
(📖 469) |
| | | 17 | Exposure compensation
indicator (📖 175)
Exposure compensation value
(📖 175) |

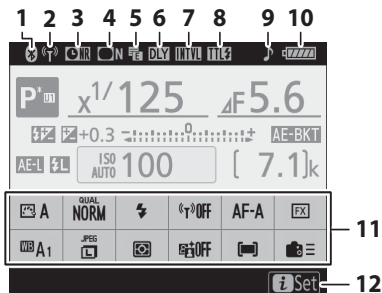

- | | | | |
|----------|---|-----------|---|
| 1 | Bluetooth connection indicator (📖 692)
Airplane mode (📖 691) | 6 | Exposure delay mode (📖 608) |
| 2 | Wi-Fi connection indicator (📖 696) | 7 | Interval timer indicator (📖 298)
⌚ (“clock not set”) indicator (📖 779) |
| 3 | Long exposure noise reduction indicator (📖 556) | 8 | Flash control mode (📖 463) |
| 4 | Vignette control indicator (📖 558) | 9 | “Beep” indicator (📖 684) |
| 5 | Electronic front-curtain shutter (📖 609) | 10 | Battery indicator (📖 33) |
| | | 11 | i menu display area (📖 63) |
| | | 12 | Guide |

✓ The ☺ Icon

A flashing ☺ icon indicates that the camera clock has been reset. The date and time recorded with new photographs will not be correct; use the [Time zone and date] > [Date and time] option in the setup menu to set the clock to the correct time and date.

✍ Using the *i* Menu

To access the *i* menu, press the *i* button or tap the guide in the information display. Press the *i* button again or press the info button to return to the information display when settings are complete.







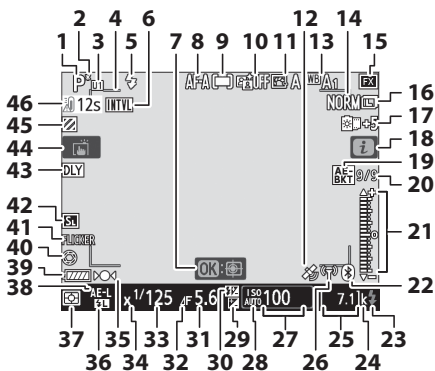













Live View (Still Photography/Movies)

■ Still Photography



1	Shooting mode (☐ 107)	7	Subject tracking AF (☐ 158)
2	Flexible program indicator (☐ 109)	8	Autofocus mode (☐ 142)
3	User setting mode (☐ 115)	9	AF-area mode (☐ 150)
4	AF-area brackets (☐ 40)	10	Active D-Lighting (☐ 254)
5	Flash mode (☐ 101, 465)	11	Picture Control (☐ 243)
6	Interval timer indicator (☐ 298)	12	Location data indicator (☐ 687)
	⊕ (“clock not set”) indicator (☐ 779)	13	White balance (☐ 195)
	“No memory card” indicator (☐ 28)	14	Image quality (☐ 134)

15	Image area (☞ 129)	21	Exposure indicator Exposure (☞ 114) Exposure compensation (☞ 175) Auto bracketing (☞ 224)
16	Image size (☞ 137)	22	Bluetooth connection indicator (☞ 692) Airplane mode (☞ 691)
17	Negative film digitizer exposure adjustment (☞ 343)	23	Flash-ready indicator* (☞ 460)
18	⚡ icon (☞ 63)	24	“k” (appears when memory remains for over 1000 exposures; ☞ 34)
19	Exposure and flash bracketing indicator (☞ 226) WB bracketing indicator (☞ 232) ADL bracketing indicator (☞ 238) HDR indicator (☞ 256) Multiple exposure indicator (☞ 287)	25	Number of exposures remaining (☞ 34, 861)
20	Position of current frame in exposure/flash bracketing sequence (☞ 226) Position of current frame in white balance bracketing sequence (☞ 232) Position of current frame in ADL bracketing sequence (☞ 238) Number of exposures (multiple exposure; ☞ 287)	26	Wi-Fi connection indicator (☞ 696)
		27	ISO sensitivity (☞ 187)
		28	ISO sensitivity indicator (☞ 187) Auto ISO sensitivity indicator (☞ 190)
		29	Exposure compensation indicator (☞ 175)
		30	Flash compensation indicator (☞ 469)

31	Aperture (f-number;  111, 113) Aperture (number of stops;  112, 795)	40	Maximum aperture indicator ( 628)
32	Aperture stop indicator ( 112, 795)	41	Flicker detection ( 561)
33	Shutter speed ( 110, 113)	42	Silent photography ( 340) Electronic front-curtain shutter ( 609)
34	Flash sync indicator ( 619)	43	Exposure delay mode ( 608)
35	Focus indicator ( 164)	44	Touch shooting ( 14)
36	FV lock indicator ( 471)	45	Highlight display indicator ( 653)
37	Metering ( 166)	46	Temperature warning ( 44) Live view time remaining ( 44)
38	Autoexposure (AE) lock ( 173)		
39	Battery indicator ( 33)		

* Displayed when an optional flash unit is attached. The flash-ready indicator lights when the flash is charged.

Temperature Warnings

- If the camera temperature becomes elevated, a temperature warning and count-down timer will be displayed. When the timer reaches zero, the monitor will turn off.
 - The timer turns red when the thirty second mark is reached. In some cases, the timer may be displayed immediately after the camera is turned on.
-

■ Filming

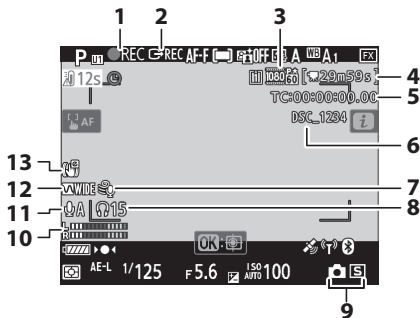

- | | | | |
|---|--|----|---|
| 1 | Recording indicator (45)
“No movie” indicator (268) | 7 | Wind noise reduction (583) |
| 2 | External recording control
(397)
N-Log indicator (397) | 8 | Headphone volume (583) |
| 3 | Frame size and rate/image
quality (264) | 9 | Release mode (still
photography; 50) |
| 4 | Time remaining (45) | 10 | Sound level (45) |
| 5 | Time code (584) | 11 | Microphone sensitivity
(581) |
| 6 | File name (550) | 12 | Frequency response (582) |
| | | 13 | Electronic VR indicator
(580) |

The Control Panel

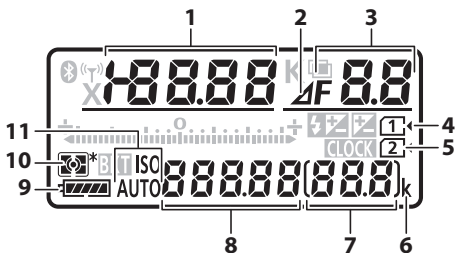

1	Shutter speed (☞ 110, 113)	7	Number of exposures remaining (☞ 34, 861) PC mode indicator (☞ 819)
2	Aperture stop indicator (☞ 112, 795)	8	ISO sensitivity (☞ 187) Autofocus mode (☞ 140)
3	Aperture (☞ 111, 113)	9	Battery indicator (☞ 33)
4	Memory card icon (Slot 1; ☞ 34)	10	Metering (☞ 166)
5	Memory card icon (Slot 2; ☞ 34)	11	ISO sensitivity indicator (☞ 187) Auto ISO sensitivity indicator (☞ 190)
6	"k" (appears when memory remains for over 1000 exposures; ☞ 34)		

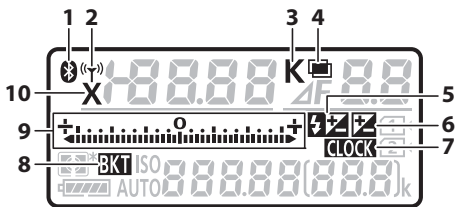

- | | | | |
|---|---|----|--|
| 1 | Bluetooth connection indicator (☞ 692) | 7 | CLOCK ("clock not set") indicator (☞ 32) |
| 2 | Wi-Fi connection indicator (☞ 696) | 8 | Bracketing indicator (☞ 224) |
| 3 | Color temperature (☞ 204) | 9 | Exposure indicator
Exposure (☞ 114)
Exposure compensation (☞ 175)
Exposure/flash bracketing (☞ 226) |
| 4 | Multiple exposure indicator (☞ 287) | 10 | Flash sync indicator (☞ 619) |
| 5 | Flash compensation indicator (☞ 469) | | |
| 6 | Exposure compensation indicator (☞ 175) | | |

Compatible F Mount Lenses

CPU lenses are recommended (but note that IX-NIKKOR lenses cannot be used). Types G, E, and D, which grant access to a full range of camera features, are particularly recommended.

CPU Lenses

Lens ¹ /accessory	Autofocus ²	Shooting mode		Metering			
		P S	A M	☒		☒ ☐	☐ [*]
				3D- RGB	RGB		
Type G, E, or D ³ ; AF-S, AF-P, AF-I	✓	✓	✓	✓	—	✓ ⁴	✓
PC NIKKOR 19mm f/4E ED ⁶	—	✓ ⁵	✓ ⁵	✓ ⁵	—	✓ ^{4,5}	✓ ⁵
PC-E NIKKOR series ⁶	—	✓ ⁵	✓ ⁵	✓ ⁵	—	✓ ^{4,5}	✓ ⁵
PC Micro 85mm f/2.8D ^{6,7}	—	—	✓ ⁸	✓ ⁵	—	✓ ^{4,5}	✓ ⁵
AF-S/AF-I Teleconverter ⁹	✓	✓	✓	✓	—	✓ ⁴	✓
Other AF NIKKOR (except lenses for F3AF)	✓ ¹⁰	✓	✓	—	✓	✓ ⁴	—
AI-P NIKKOR	—	✓	✓	—	✓	✓ ⁴	—

- 1 IX-NIKKOR lenses cannot be used.
 - 2 **M** (manual focus) is available with all lenses.
 - 3 Vibration reduction (VR) is supported with VR lenses.
 - 4 [**Spot metering**] meters the selected focus point.
 - 5 Cannot be used with shifting or tilting.
 - 6 Fog, lines, and other image artifacts (“noise”) may appear in photos taken with the electronic front-curtain shutter. This can be prevented by selecting [**Disable**] for Custom Setting d5 [**Electronic front-curtain shutter**].
 - 7 The camera’s exposure metering and flash control systems will not function as expected when the lens is shifted and/or tilted, or when an aperture other than the maximum aperture is used.
 - 8 Mode **M** (manual) only.
 - 9 For information on the focus points available for autofocus and electronic rangefinding, see “AF-S/AF-I Teleconverters” (☐ 790).
 - 10 When an AF 80–200mm f/2.8, AF 35–70mm f/2.8, AF 28–85mm f/3.5–4.5 <New>, or AF 28–85mm f/3.5–4.5 lens is focused at the minimum distance at maximum zoom, the in-focus indicator may be displayed when the image on the matte screen in the viewfinder is not in focus. Adjust focus manually until the image in the viewfinder is in focus.
- “Noise” in the form of lines may appear during autofocus at high ISO sensitivities. Use manual focus or focus lock. Lines may also appear at high ISO sensitivities when aperture is adjusted during movie recording or live view photography.

✔ Lens f-Number

The f-number is a measure of lens “speed”, its maximum (widest) aperture. It appears at the end of the lens name, for example as “f/2.8” or “f/3.5–5.6”.

✔ VR Lenses

The lenses listed below are not recommended for long exposures or photographs taken at high ISO sensitivities, as due to the design of the vibration reduction (VR) control system the resulting photos may be marred by fog.

- AF-S VR Zoom-Nikkor 24–120mm f/3.5–5.6G IF-ED
- AF-S VR Zoom-Nikkor 70–200mm f/2.8G IF-ED
- AF-S VR Zoom-Nikkor 70–300mm f/4.5–5.6G IF-ED
- AF-S VR Nikkor 200mm f/2G IF-ED
- AF-S VR Nikkor 300mm f/2.8G IF-ED
- AF-S NIKKOR 16–35mm f/4G ED VR
- AF-S NIKKOR 24–120mm f/4G ED VR
- AF-S NIKKOR 28–300mm f/3.5–5.6G ED VR
- AF-S NIKKOR 400mm f/2.8G ED VR
- AF-S NIKKOR 500mm f/4G ED VR
- AF-S DX VR Zoom-Nikkor 18–200mm f/3.5–5.6G IF-ED
- AF-S DX NIKKOR 16–85mm f/3.5–5.6G ED VR
- AF-S DX NIKKOR 18–200mm f/3.5–5.6G ED VR II
- AF-S DX Micro NIKKOR 85mm f/3.5G ED VR
- AF-S DX NIKKOR 55–300mm f/4.5–5.6G ED VR

We recommend turning vibration reduction off when using other VR lenses.

✓ Calculating Angle of View

The camera can be used with Nikon lenses for 35 mm format cameras. If a 35 mm format lens or a lens that supports the FX format is attached, the angle of view will be the same as a frame of 35 mm film.

- You can also take pictures at angles of view that differ from that of the current lens by selecting different options for **[Image area] > [Choose image area]** in the photo shooting menu. For example, if a 35 mm format lens or a lens that supports the FX format is attached, you can reduce the angle of view by selecting **[DX (24×16)]**.

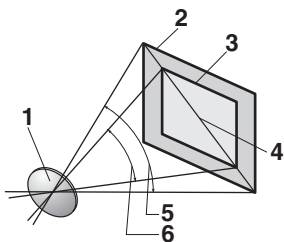







1	Lens
2	[FX (36×24)] picture size (35.9 × 23.9 mm, equivalent to 35 mm format camera)
3	[DX (24×16)] picture size (23.5 × 15.7 mm)
4	Picture diagonal
5	[FX (36×24)] angle of view (35 mm format)
6	[DX (24×16)] angle of view

- The picture diagonal for 35 mm format is about 1.5 times that of the **[DX (24×16)]** crop. Selecting **[DX (24×16)]** therefore multiplies the apparent focal length of 35 mm format lenses attached to the camera by about 1.5×. For example, selecting **[DX (24×16)]** when a lens with a focal length of 50 mm is attached increases the apparent focal length to about 75 mm.

✓ AF-S/AF-I Teleconverters

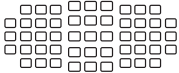
- The table below shows the focus points available for autofocus and electronic rangefinding in viewfinder photography when an AF-S/AF-I teleconverter is attached. Note that the camera may be unable to focus on dark or low-contrast subjects if the combined aperture is slower than f/5.6.

Teleconverter	Max. lens aperture	Focus points
TC-14E, TC-14E II, TC-14E III	f/4 or faster	
	f/5.6	 1
TC-17E II	f/2.8 or faster	
	f/4	 1
	f/5.6	— 2
TC-20E, TC-20E II, TC-20E III	f/2.8 or faster	
	f/4	 3
	f/5.6	— 2
TC-800-1.25E ED	f/5.6	 1

- 1 Single-point AF is used when 3D-tracking or auto-area AF is selected for AF-area mode.
 - 2 Autofocus not available.
 - 3 Focus data for focus points other than the center focus point are obtained from line sensors.
- Autofocus is not available when teleconverters are used with the AF-S VR Micro-Nikkor 105mm f/2.8G IF-ED.

Recognizing CPU and Type G, E, and D Lenses

CPU lenses can be identified by the presence of CPU contacts (①). Type G lenses are marked with a "G", type E lenses with an "E", and type D lenses with a "D". Type G and E lenses are not equipped with a lens aperture ring (②).

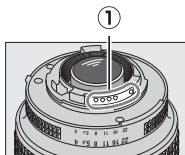

CPU lens

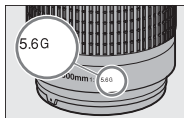



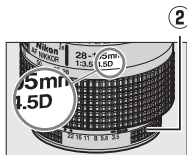

Type G or E lens



Type D lens

Non-CPU Lenses and Other Accessories

Lens ¹ /accessory	Shooting mode		Metering			
	P S	A M				 *
			3D- RGB	RGB		
AI-, AI-modified NIKKOR or Nikon Series E lenses ²	—	✓ ³	—	✓ ⁴	✓ ⁵	—
Medical-NIKKOR 120mm f/4	—	✓ ⁶	—	—	—	—
Reflex-NIKKOR	—	✓ ³	—	—	✓ ⁵	—
PC-NIKKOR	—	✓ ⁷	—	—	✓	—
AI-type Teleconverter ⁸	—	✓ ³	—	✓ ⁴	✓ ⁵	—
PB-6 Bellows Focusing Attachment ⁹	—	✓ ¹⁰	—	—	✓	—
Auto extension rings (PK-series 11A, 12, or 13; PN-11)	—	✓ ³	—	—	✓	—

- 1 Some lenses cannot be used ( 794).
- 2 The range of rotation for the AI 80–200mm f/2.8 ED tripod mount is limited by the camera body. Filters cannot be exchanged while an AI 200–400mm f/4 ED is mounted on camera.
- 3 If the maximum aperture is specified using the **[Non-CPU lens data]** item in the setup menu, the aperture value will be displayed in the viewfinder and control panel.

- 4 Can be used only if the lens focal length and maximum aperture are specified using the **[Non-CPU lens data]** item in the setup menu. Some lenses may, however, fail to produce the desired results even if the focal length and maximum aperture are supplied. Use **[Spot metering]** or **[Center-weighted metering]** if the desired results are not achieved.
- 5 For improved precision, specify the lens focal length and maximum aperture using the **[Non-CPU lens data]** item in the setup menu.
- 6 Can be used in mode **M** at shutter speeds one step or more slower than the flash sync speed.
- 7 Use stop-down metering. In mode **A**, stop aperture down using the controls on the lens and lock exposure before shifting the lens. In mode **M**, stop aperture down using the controls on the lens and meter exposure before shifting the lens.
- 8 Exposure compensation required with AI 28–85mm f/3.5–4.5, AI 35–105mm f/3.5–4.5, AI 35–135mm f/3.5–4.5, or AF-S 80–200mm f/2.8D lenses.
- 9 Requires a PK-12 or PK-13 auto extension ring. A PB-6D may be required depending on camera orientation.
- 10 Can be used with stop-down metering; in mode **A**, stop aperture down using the controls on the bellows attachment and meter exposure before taking photographs.
 - Lines may appear at high ISO sensitivities when aperture is adjusted during movie recording or live view photography.

✔ Incompatible Lenses and Accessories

The following non-CPU lenses and accessories cannot be used. Attempting to mount them on the camera could damage the camera or lens.

- TC-16A AF teleconverters
 - Non-AI lenses (lenses with pre-AI exposure couplings)
 - Lenses that require the AU-1 focusing unit (400mm f/4.5, 600mm f/5.6, 800mm f/8, 1200mm f/11)
 - Fisheye (6mm f/5.6, 7.5mm f/5.6, 8mm f/8, OP 10mm f/5.6)
 - 2.1cm f/4
 - K2 extension rings
 - 180–600mm f/8 ED lenses (serial numbers 174041–174180)
 - 360–1200mm f/11 ED lenses (serial numbers 174031–174127)
 - 200–600mm f/9.5 lenses (serial numbers 280001–300490)
 - AF lenses for the F3AF (AF 80mm f/2.8, AF 200mm f/3.5 ED, TC-16 AF teleconverters)
 - PC 28mm f/4 lenses (serial numbers 180900 or earlier)
 - PC 35mm f/2.8 lenses (serial numbers 851001–906200)
 - PC 35mm f/3.5 lenses (old type)
 - Reflex 1000mm f/6.3 lenses (old type)
 - Reflex 1000mm f/11 lenses (serial numbers 142361–143000)
 - Reflex 2000mm f/11 lenses (serial numbers 200111–200310)
-

Compatible Non-CPU Lenses

- Specifying the lens focal length and maximum aperture using the [**Non-CPU lens data**] item in the setup menu allows many of the features available with CPU lenses, including aperture value display and color matrix metering, to be used with non-CPU lenses. If the focal length and maximum aperture are not provided and [**Matrix metering**] is selected for metering, [**Center-weighted metering**] will be used instead.
 - Aperture must be set using the lens aperture ring. If the maximum aperture is not provided using [**Non-CPU lens data**], the aperture displays in the camera control panel and viewfinder will show the number of stops from maximum aperture and the actual aperture value must be read off the lens aperture ring.
-

The Electronic Rangefinder

The conditions under which the electronic rangefinder can be used vary with the lens.

■ CPU lenses

Lens/accessory	Viewfinder photography	Live view
Type G, E, or D; AF-S, AF-P, AF-I	✓	✓
PC NIKKOR 19mm f/4E ED	✓ ¹	—
PC-E NIKKOR series	✓ ¹	—
PC Micro 85mm f/2.8D	✓ ¹	—
AF-S/AF-I Teleconverter	✓	✓
Other AF NIKKOR (except lenses for F3AF)	✓ ²	✓
AI-P NIKKOR	✓ ³	✓

- 1 Cannot be used with shifting or tilting.
- 2 When an AF 80–200mm f/2.8, AF 35–70mm f/2.8, AF 28–85mm f/3.5–4.5 <New>, or AF 28–85mm f/3.5–4.5 lens is focused at the minimum distance at maximum zoom, the in-focus indicator may be displayed when the image on the matte screen in the viewfinder is not in focus. Adjust focus manually until the image in the viewfinder is in focus.
- 3 With a maximum aperture of f/5.6 or faster.

■ Non-CPU Lenses and Other Accessories

Lens/accessory	Viewfinder photography	Live view
AI-, AI-modified NIKKOR or Nikon Series E lenses	✓ ¹	—
Medical-NIKKOR 120mm f/4	✓	—
Reflex-NIKKOR	—	—
PC-NIKKOR	✓ ²	—
AI-type Teleconverter	✓ ³	—
PB-6 Bellows Focusing Attachment	✓ ³	—
Auto extension rings (PK-series 11A, 12, or 13; PN-11)	✓ ³	—

- 1 With a maximum aperture of f/5.6 or faster.
- 2 Cannot be used with shifting or tilting.
- 3 With a maximum effective aperture of f/5.6 or faster.

Compatible Flash Units

The Nikon Creative Lighting System (CLS)





Nikon's advanced Creative Lighting System (CLS) supports a variety of features thanks to improved communication between the camera and compatible flash units.

■ Features Available with CLS-Compatible Flash Units

Supported features		Flash unit									
		SB-5000	SB-800	SB-900/ SB-800	SB-910/ SB-800	SB-700	SB-600	SB-500	SU-800	SB-R200	SB-400
Single flash	i-TTL	i-TTL balanced fill-flash for digital SLR ¹	✓	✓	✓	✓	✓	—	—	✓	✓
		Standard i-TTL fill-flash for digital SLR	✓ ²	✓ ²	✓	✓ ²	✓	—	—	✓	✓
	 A	Auto aperture	✓	✓ ³	—	—	—	—	—	—	—
	A	Non-TTL auto	—	✓ ³	—	—	—	—	—	—	—
	GN	Distance-priority manual	✓	✓	✓	—	—	—	—	—	—
	M	Manual	✓	✓	✓	✓	✓ ⁴	—	—	✓ ⁴	✓ ⁴
	RPT	Repeating flash	✓	✓	—	—	—	—	—	—	—

Supported features		Flash unit									
		SB-5000	SB-800	SB-910/ SB-900/ SB-800	SB-700	SB-600	SB-500	SU-800	SB-R200	SB-400	SB-300
Optical Advanced Wireless Lighting	Master	Remote flash control	✓	✓	✓	—	✓ ⁴	✓	—	—	—
		i-TTL i-TTL	✓	✓	✓	—	✓ ⁴	—	—	—	—
		[A : B] Quick wireless flash control	✓	—	✓	—	—	✓ ⁵	—	—	—
		⊗A Auto aperture	✓	✓	—	—	—	—	—	—	—
		A Non-TTL auto	—	—	—	—	—	—	—	—	—
		M Manual	✓	✓	✓	—	✓ ⁴	—	—	—	—
	RPT Repeating flash	✓	✓	—	—	—	—	—	—	—	
	Remote	i-TTL i-TTL	✓	✓	✓	✓	✓	—	✓	—	—
		[A : B] Quick wireless flash control	✓	✓	✓	✓	✓	—	✓	—	—
		⊗A/A Auto aperture/non-TTL auto	✓ ⁶	✓ ⁶	—	—	—	—	—	—	—
M Manual		✓	✓	✓	✓	✓	—	✓	—	—	
RPT Repeating flash		✓	✓	✓	✓	✓	—	—	—	—	

Supported features	Flash unit									
	SB-5000	SB-900/ SB-800	SB-910/ SB-900/ SB-800	SB-700	SB-600	SB-500	SU-800	SB-R200	SB-400	SB-300
Radio-controlled Advanced Wireless Lighting	✓ ⁷	—	—	—	—	—	—	—	—	—
Color Information Communication (flash)	✓	✓	✓	✓	✓	—	—	—	✓	✓
Color Information Communication (LED light)	—	—	—	—	—	✓	—	—	—	—
Auto FP high-speed sync ⁸	✓	✓	✓	✓	✓	✓	✓	✓	—	—
FV lock ⁹	✓	✓	✓	✓	✓	✓	✓	✓	✓	✓
Red-eye reduction	✓	✓	✓	✓	✓	—	—	—	✓	—
Camera modeling illumination	✓	✓	✓	✓	✓	✓	✓	—	—	—
Unified flash control	✓	—	—	—	—	✓	—	—	✓	✓
Camera flash unit firmware update	✓	✓ ¹⁰	✓	—	—	✓	—	—	—	✓

- 1 Not available with spot metering.
- 2 Can also be selected via the flash unit.
- 3 A/A mode selection is performed on the flash unit using custom settings.
- 4 Can be selected using the [**Flash control**] item in the camera menus.
- 5 Available during close-up photography only.
- 6 Choice of A and A depends on the option selected with the master flash.
- 7 Supports the same features as remote flash units with optical AWL.
- 8 Available only in i-TTL, A, A, GN, and M flash-control modes.
- 9 Available only in i-TTL flash control mode or when the flash is configured to emit monitor preflashes in A or A flash control mode.
- 10 Firmware updates for the SB-910 and SB-900 can be performed from the camera.

■ The SU-800 Wireless Speedlight Commander

When mounted on a CLS-compatible camera, the SU-800 can be used as a commander for SB-5000, SB-910, SB-900, SB-800, SB-700, SB-600, SB-500, or SB-R200 flash units. Group flash control is supported for up to three groups. The SU-800 itself is not equipped with a flash.

✓ Other Flash Units

The following flash units can be used in non-TTL auto (**A**) and manual modes. The options available do not vary with the lens used.

Supported features		Flash unit				
		SB-80DX SB-28DX	SB-50DX	SB-28 SB-26 SB-25 SB-24	SB-30 SB-27 ¹ SB-22S SB-22 SB-20 SB-16B SB-15	SB-23 SB-29 SB-21B SB-29S
A	Non-TTL auto	✓	—	✓	✓	—
M	Manual	✓	✓	✓	✓	✓
	Repeating flash	✓	—	✓	—	—
REAR ²	Rear-curtain sync	✓	✓	✓	✓	✓

- 1 Mounting an SB-27 on the camera automatically sets the flash mode to **TTL**, but setting the flash mode to **TTL** disables the shutter release. Set the SB-27 to **A**.
- 2 Available when the camera is used to select the flash mode.

✔ Metering Areas for FV Lock

The areas metered when FV lock is used with optional flash units are as follows:

Picture taken with	Flash control mode	Metered area
Stand-alone flash unit	i-TTL	6-mm circle in center of frame
	Auto aperture (⊗A)	Area metered by flash exposure meter
Remote flash units controlled via Advanced Wireless Lighting	i-TTL	Entire frame
	Auto aperture (⊗A)	Area metered by flash exposure meter
	Non-TTL auto (A)	

✔ Notes on Optional Flash Units

- Refer to the flash unit manual for detailed instructions.
- If the unit supports CLS, refer to the section on CLS-compatible digital SLR cameras. This camera is not included in the “digital SLR” category in the SB-80DX, SB-28DX, and SB-50DX manuals.
- If the flash-ready indicator (⚡) flashes for about three seconds after a photograph is taken in i-TTL or non-TTL auto mode, the flash has fired at full power and the photograph may be underexposed (CLS-compatible flash units only).
- i-TTL flash control can be used at ISO sensitivities between 100 and 12800.
- At ISO sensitivities over 12800, the desired results may not be achieved at some ranges or aperture settings.

- In mode **P**, the maximum aperture (minimum f-number) is limited according to ISO sensitivity, as shown below:

Maximum aperture (f-number) at ISO equivalent of:							
100	200	400	800	1600	3200	6400	12800
4	5	5.6	7.1	8	10	11	13

- * If the maximum aperture of the lens is smaller than given above, the maximum value for aperture will be the maximum aperture of the lens.
- The SB-5000, SB-910, SB-900, SB-800, SB-700, SB-600, SB-500, and SB-400 provide red-eye reduction in red-eye reduction and slow-sync with red-eye reduction flash modes.
- “Noise” in the form of lines may appear in flash photographs taken with an SD-9 or SD-8A high-performance battery pack attached directly to the camera. Reduce ISO sensitivity or increase the distance between the camera and the battery pack.
- During viewfinder photography, the SB-5000, SB-910, SB-900, SB-800, SB-700, SB-600, and SU-800 provide AF-assist illumination as required.
- The SB-5000 supports AF-assist illumination with 24–135 mm AF lenses. During viewfinder photography, AF-assist is available with the focus points highlighted in the illustration.

Focus points for which AF-assist illumination is available		
Focal length 24–30 mm	Focal length 31–48 mm	Focal length 49–135 mm

- The SB-910 and SB-900 support AF-assist illumination with 17–135 mm AF lenses. During viewfinder photography, AF-assist illumination is available with the focus points highlighted in the illustration.

Focus points for which AF-assist illumination is available



- The SB-800, SB-600, and SU-800 support AF-assist illumination with 24–105 mm AF lenses. During viewfinder photography, AF-assist illumination is available with the focus points highlighted in the illustration.

Focus points for which AF-assist illumination is available

Focal length 24–31 mm	Focal length 32–105 mm

- The SB-700 supports AF-assist illumination with 24–135 mm AF lenses. During viewfinder photography, AF-assist illumination is available with the focus points highlighted in the illustration.

Focus points for which AF-assist illumination is available



- Depending on the lens used and scene recorded, the in-focus indicator (●) may be displayed when the subject is not in focus, or the camera may be unable to focus and the shutter release will be disabled.
- When an SC-series 17, 28, or 29 sync cable is used for off-camera flash photography, correct exposure may not be achieved in i-TTL mode. We recommend that you select standard i-TTL fill-flash. Take a test shot and view the results in the monitor.
- In i-TTL, do not use any form of flash panel (diffusion panel) other than the flash unit's built-in flash panel or bounce adapters provided with the flash unit. Using other panels may produce incorrect exposure.

✓ Flash Compensation for Optional Flash Units

In i-TTL and auto aperture (⊗A) flash control modes, the flash compensation selected with the optional flash unit or the **[Flash control]** item in the photo shooting menu is added to the flash compensation selected with the **⚡ (1/2)** button.

Modeling Illumination

- Optional CLS-compatible flash units emit a modeling flash when the camera **Pv** button is pressed.
 - This feature can be used with Advanced Wireless Lighting to preview the total lighting effect achieved with multiple flash units.
 - Modeling illumination can be turned off by selecting [**Off**] for Custom Setting e5 [**Modeling flash**].
-

Other Compatible Accessories

A variety of accessories are available for your Nikon camera.

● Power Sources

- **EN-EL15b Rechargeable Li-ion Battery:** EN-EL15b batteries can be used with Nikon D780 digital cameras.
 - EN-EL15c/EN-EL15a/EN-EL15 batteries can also be used. Note, however, that fewer pictures may sometimes be taken on a single charge with an EN-EL15 than with an EN-EL15c/EN-EL15b/EN-EL15a (☞ 867).
- **MH-25a Battery Charger:** The MH-25a can be used to recharge EN-EL15b batteries.
 - MH-25 battery chargers can also be used.
- **EH-7P Charging AC Adapter:** The EH-7P can be used to charge EN-EL15c/EN-EL15b batteries inserted in the camera.
 - The battery only charges when the camera is off.
 - The EH-7P cannot be used to charge EN-EL15a/EN-EL15 batteries.
- **EP-5B Power Connector, EH-5d, EH-5c, and EH-5b AC Adapters:** Use AC adapters to power the camera for extended periods.
 - The EP-5B is required to connect the camera to the AC adapter. See “Attaching a Power Connector and AC Adapter” (☞ 816) for details.

● Accessory Shoe Covers

BS-3/BS-1 Accessory Shoe Covers: Accessory shoe covers protect the accessory shoe when no flash unit is attached.

● Body Caps

BF-1B Body Cap/BF-1A Body Cap: Body caps prevent dust entering the camera when no lens is in place.

● Viewfinder Eyepiece Accessories

- **DK-20C Eyepiece Correction Lenses:** Lenses are available with diopters of -5 , -4 , -3 , -2 , 0 , $+0.5$, $+1$, $+2$, and $+3$ m^{-1} when the camera diopter adjustment control is in the neutral position (-1 m^{-1}). Test eyepiece correction lenses before purchase to ensure that the desired focus can be achieved. Use eyepiece correction lenses only if the desired focus cannot be achieved with the built in diopter adjustment control (-3 to $+1$ m^{-1}). The rubber eyecup cannot be used with eyepiece correction lenses.
- **DK-21M Magnifying Eyepiece:** The DK-21M magnifies the view through the viewfinder by approximately $1.17 \times$ (50 mm $f/1.4$ lens at infinity; -1.0 m^{-1}) for greater precision when framing.
- **DG-2 Magnifier:** The DG-2 magnifies the scene displayed in the center of the viewfinder for greater precision during focusing.
- **DK-22 Eyepiece Adapter:** The DK-22 is used when attaching the DG-2 magnifier.
- **DR-6 Right-Angle Viewing Attachment:** The DR-6 attaches at a right angle to the viewfinder eyepiece, allowing the image in the viewfinder to be viewed at right angles to the lens (for example, from directly above when the camera is horizontal).

● Filters

- Neutral Color (NC) filters can be used to protect the lens.
- The camera cannot be used with linear polarizing filters. Use the C-PL or C-PLII circular polarizing filter instead.
- Filters may cause ghosting when the subject is framed against a bright light, or when a bright light source is in the frame. Filters can be removed if ghosting occurs.
- RGB and 3D-RGB matrix metering may not produce the desired results with filters with exposure factors (filter factors) over 1× (Y44, Y48, Y52, O56, R60, X0, X1, C-PL, ND2S, ND4, ND4S, ND8, ND8S, ND400, A2, A12, B2, B8, B12); we suggest that [**Center-weighted metering**] be selected instead. See the filter manual for details.
- Filters intended for special-effects photography may interfere with autofocus or the electronic rangefinder.

● Wireless Transmitters

WT-7 Wireless Transmitter*: Use the WT-7 to upload pictures over a wireless network or control the camera from a computer running Camera Control Pro 2 (available separately). You can also take and browse pictures remotely from a computer or smart device.

- * Requires a wireless network and some basic network knowledge. Be sure to update the wireless transmitter software to the latest version.

● **Wireless Remote Controllers**

• **WR-R10 Wireless Remote Controller/WR-T10 Wireless Remote**

Controller: When a WR-R10 wireless remote controller is attached to accessory terminal, the camera can be controlled remotely using a WR-T10 wireless remote controller.

- The WR-R10 can also be used to control radio-controlled flash units.
- For synchronized release involving more than one camera, ready multiple cameras with paired WR-R10 units attached.

* When connecting the WR-R10, be sure the covers for the accessory terminal and the USB and HDMI connectors are fully open.

• **WR-1 Wireless Remote Controller:** WR-1 units are used with WR-R10 or WR-T10 wireless remote controllers or with other WR-1 remote controllers, with the WR-1 units functioning as either transmitters or receivers. When a WR-R10 or a WR-1 configured as a receiver is connected to the camera accessory terminal, a WR-T10 or a second WR-1 configured as a transmitter can be used to take pictures remotely. Camera settings can also be adjusted using a WR-1 configured as a transmitter.

* Be sure the firmware for the WR-R10 and WR-1 has been updated to the latest versions (WR-R10 firmware version 3.0 or later and WR-1 firmware version 1.0.1 or later). For information on firmware updates, see the Nikon website for your area. Consult a Nikon-authorized service representative when updating the firmware for the WR-R10 from versions prior to version 2.0 to version 3.0 or later.

● Remote Cords

MC-DC2 Remote Cord (length 1 m/3 ft 4 in.): When connected to the camera accessory terminal, the MC-DC2 can be used to release the shutter remotely.

● USB Cables

- **UC-E24 USB Cable:** A USB cable with a type C connector for connection to the camera and a type A connector for connection to the USB device.
- **UC-E25 USB Cable:** A USB cable with two type C connectors.

● HDMI Cables

HC-E1 HDMI Cable: An HDMI cable with a type C connector for connection to the camera and a type A connector for connection to HDMI devices.

● Microphones

- **ME-1 Stereo Microphone:** Connect the ME-1 to the camera microphone jack to record stereo sound. Using an external microphone also reduces the chance of picking up equipment noise, such as the sounds produced by the lens during autofocus.
- **ME-W1 Wireless Microphone:** A wireless Bluetooth microphone. Use the ME-W1 for off-camera recording.

● Film Digitizing Adapters

ES-2 Film Digitizing Adapter: The ES-2 film digitizing adapter is used to fix 35 mm film in place so it can be photographed. It can be used with Nikon lenses mounted on Nikon SLR cameras. For information on compatible lenses, see the manual for the ES-2.

● **Accessory Terminal Accessories**

The following accessories can be connected to the accessory terminal.

- **WR-R10 Wireless Remote Controller**
- **WR-1 Wireless Remote Controller**
- **MC-DC2 Remote Cord**

Close the camera connector cover when the terminal is not in use. Foreign matter in the connector could cause malfunction.

✔ **Compatible Accessories**

- Availability may vary with country or region.
- See our website or brochures for the latest information.

✔ **Attaching and Removing the Accessory Shoe Cover**

The accessory shoe cover (available separately) slides into the accessory shoe as shown. To remove the cover, hold the camera firmly, press the cover down with a thumb and slide it in the direction shown.

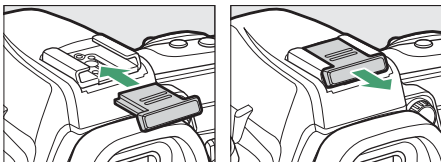

Attaching a Power Connector and AC Adapter

Turn the camera off before attaching an optional power connector and AC adapter.

- 1 Open the battery-chamber (①) and power connector (②) covers.**

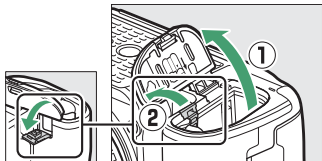

- 2 Insert the EP-5B power connector.**

- Be sure to insert the connector in the correct orientation.
- Using the connector to keep the orange battery latch pressed to one side, slide the connector into the battery chamber until the latch locks the connector in place.

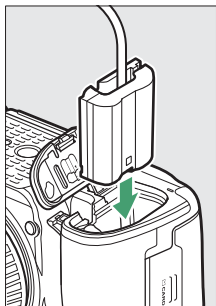

3 Close the battery-chamber cover.

Position the power connector cable so that it passes through the power connector slot and close the battery-chamber cover.

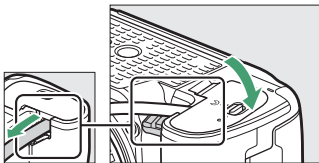

4 Connect the EH-5d/EH-5c/EH-5b AC adapter.

- Connect the AC adapter power cable to the AC socket on the AC adapter (③).
- Connect the power cable to the DC socket (④).
- A  icon is displayed in the monitor when the camera is powered by the AC adapter and power connector.

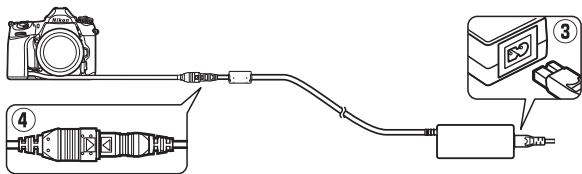

Charging AC Adapters

- When inserted in the camera, EN-EL15c/EN-EL15b rechargeable Li-ion batteries will charge while the camera is connected to an optional EH-7P charging AC adapter.
- Charging AC adapters cannot be used to charge EN-EL15a/EN-EL15 batteries. Use the MH-25a battery charger instead.
- An exhausted battery will fully charge in about two hours and 35 minutes.
- Note that in countries or regions where required, charging AC adapters are supplied with a plug adapter attached; the shape of the plug adapter varies with the country of sale.

1 Insert the EN-EL15c/EN-EL15b into the camera (📖 24).

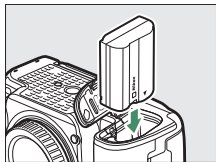

2 After confirming that the camera is off, connect the charging AC adapter and plug the adapter in.

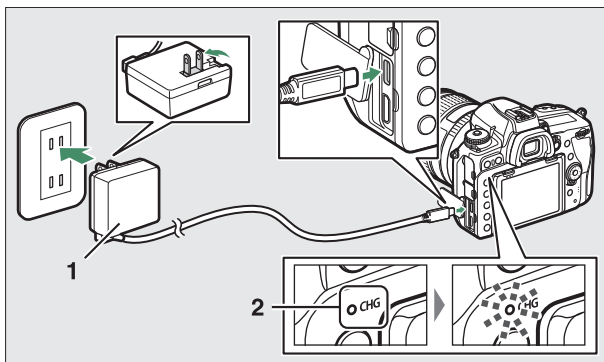

1 EH-7P Charging AC Adapter

2 Charge lamp

- Insert the plug straight into the socket rather than at an angle.
- The charge lamp lights amber while charging is in progress. The charge lamp turns off when charging is complete.
- The battery will not charge while the camera is on.
- Note that although the camera can be used while connected, the camera will not draw power from the charging AC adapter while the camera is on.

3 Unplug the charging AC adapter when charging is complete.

Disconnect the charging AC adapter from the camera.

✔ The Charging AC Adapter

If the battery cannot be charged using the charging AC adapter, for example because the battery is not compatible or the temperature of the camera is elevated, the charge lamp will flash rapidly for about 30 seconds and then turn off. If the charge lamp is off and you did not observe the battery charging, turn the camera on and check the battery level.

Software

The following Nikon software can be used with the camera:

● Computer Software

- **Camera Control Pro 2** (available for purchase): Control the camera remotely from a computer and save photographs directly to the computer hard disk. If [PC] is selected as the destination in Camera Control Pro 2, a PC connection indicator (P C) will be displayed in the camera control panel if Camera Control Pro 2 is launched while the camera is connected to the computer.
- **NX Tether**: Use for tethered photography when the camera is connected to a computer. Exposure, white balance, and other camera settings can be adjusted remotely using controls in the computer display.
- **NX Studio** *: View and edit photos and videos shot with Nikon digital cameras. NX Studio can be used to fine-tune files in Nikon's unique NEF/NRW (RAW) format and convert them to JPEG or TIFF (NEF/RAW processing). It supports not only NEF/NRW (RAW) pictures but also JPEG and TIFF photos shot with Nikon digital cameras for such tasks as editing tone curves and enhancing brightness and contrast.
* Existing users should be sure to download the latest version, as earlier versions may be unable to download pictures from the camera or open NEF (RAW) pictures.

- **Wireless Transmitter Utility:** The Wireless Transmitter Utility is required if the camera is to be connected to a network. Pair the camera with the computer and download pictures via Wi-Fi. Nikon computer software is available from the Nikon Download Center. Check the version and system requirements and be sure to download the latest version.

<https://downloadcenter.nikonimglib.com/>

● **Smartphone (Tablet) Apps**

SnapBridge: Upload photos and movies from the camera to a smart device via a wireless connection.

- The SnapBridge app is available for download from the Apple App Store® or on Google Play™.
- Visit the Nikon website for the latest information on the SnapBridge app.

Caring for the Camera

Storage

When the camera will not be used for an extended period, remove the battery. Before removing the battery, confirm that the camera is off.

Do not store the camera in locations that:

- are poorly ventilated or subject to humidities of over 60%
- are next to equipment that produces strong electromagnetic fields, such as televisions or radios
- are exposed to temperatures above 50 °C (122 °F) or below –10 °C (14 °F)

Cleaning

The procedure varies with the part that requires cleaning. The procedures are detailed below.

- Do not use alcohol, thinner, or other volatile chemicals.

■ Camera body

Use a blower to remove dust and lint, then wipe gently with a soft, dry cloth. After using the camera at the beach or seaside, wipe off sand or salt with a cloth lightly dampened in distilled water and dry the camera thoroughly.

Important: *Dust or other foreign matter inside the camera may cause product malfunction. Damage due to the presence of foreign matter inside the camera is not covered under warranty.*

■ Lens, mirror, and viewfinder

These glass elements are easily damaged: remove dust and lint with a blower. If using an aerosol blower, keep the can vertical to prevent the discharge of liquid that could damage glass elements. To remove fingerprints and other stains, apply a small amount of lens cleaner to a soft cloth and clean with care.

■ Monitor

Remove dust and lint with a blower. When removing fingerprints and other stains, wipe the surface lightly with a soft cloth or chamois leather. Do not apply pressure, as this could result in damage or malfunction.

The Low-Pass Filter

Dirt or dust entering the camera when lenses are exchanged or the body cap is removed may adhere to the low-pass filter and affect your photographs. The “clean image sensor” option vibrates the filter to remove dust.

The filter can be cleaned at any time from the menus, or cleaning can be performed automatically when the camera is turned on or off.

■ Using the Menu

- For maximum effect, hold the camera in normal orientation (base down).

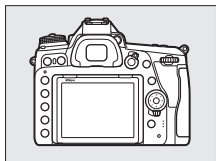

- Select [**Clean image sensor**] in the setup menu, then highlight [**Clean now**] and press \odot to begin cleaning.
- Camera controls cannot be used while cleaning is in progress. Do not remove or disconnect the power source.
- The setup menu will be displayed when cleaning is complete.

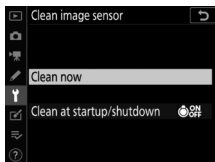

■ Cleaning the Image Sensor at Startup and/or Shutdown

	Option	Description
ON	[Clean at startup]	The image sensor is automatically cleaned each time the camera is turned on.
OFF	[Clean at shutdown]	The image sensor is automatically cleaned during shutdown each time the camera is turned off.
ON/OFF	[Clean at startup & shutdown]	The image sensor is cleaned automatically at startup and at shutdown.
	[Cleaning off]	Automatic image sensor cleaning off.

1 Select [Clean at startup/shutdown] for [Clean image sensor].

Pressing  when [Clean at startup/shutdown] is highlighted displays [Clean at startup/shutdown] options.



2 Highlight an option.

Press  to select the highlighted option.

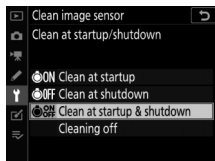

✔ Image Sensor Cleaning

- Using camera controls interrupts any image sensor cleaning begun in response to the operation of the power switch.
 - Image sensor cleaning may not fully remove all foreign matter from the filter. Clean the filter manually (☞ 827) or consult a Nikon-authorized service representative.
 - If image sensor cleaning is performed several times in succession, image sensor cleaning may be temporarily disabled to protect the camera's internal circuitry. Cleaning can be performed again after a short wait.
-

Manual Cleaning

If foreign matter cannot be removed from the low-pass filter using the “clean image sensor” option (☐ 823), the filter can be cleaned manually as described below. Note, however, that because the filter is extremely delicate and easily damaged, we recommend that manual cleaning be performed only by a Nikon-authorized service representative.

- To prevent loss of power during the operation, use a fully-charged battery or connect an optional AC adapter and power connector.
- Manual cleaning requires use of the **[Lock mirror up for cleaning]** item in the setup menu. The **[Lock mirror up for cleaning]** item is not available at battery levels of  or below or if the camera is connected to a smart device via Bluetooth or other devices via USB.

1 Turn the camera off and remove the lens.

After removing the lens, turn the camera on.

2 Highlight [Lock mirror up for cleaning] in the setup menu and press .

The camera will prepare to lock the mirror up.



3 Press .

- The mirror will be raised and the shutter curtain will open.
- The display in the control panel will flash. The display in the viewfinder will turn off.
- To restore normal operation without inspecting the low-pass filter, turn the camera off.

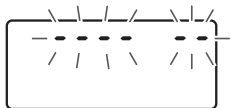

4 Holding the camera so that light can enter the camera, examine the filter for dust or lint.

If no foreign objects are present, proceed to Step 6.

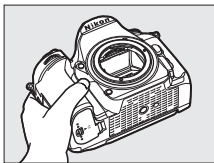

5 Remove any dust and lint from the low-pass filter with a blower.

- Do not use a blower-brush. The bristles could damage the filter.
- Dirt that cannot be removed with a blower can only be removed by Nikon-authorized service personnel. Under no circumstances should you touch or wipe the filter.

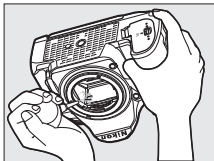

6 Turn the camera off and replace the lens.

The mirror will return to the down position and the shutter curtain will close.

✔ Use a Reliable Power Source

The shutter curtain is delicate and easily damaged. If the camera powers off while the mirror is raised, the curtain will close automatically. To prevent damage to the curtain caused by the shutter closing inadvertently during the operation, observe the following precautions:

- Do not turn the camera off while the mirror is raised.
- Do not remove or disconnect the power source while the mirror is raised.
- If the battery runs low while the mirror is raised, a beep will sound and the self-timer lamp will flash. The shutter curtain will close and the mirror will be lowered after about two minutes; end cleaning or inspection immediately.

✔ Foreign Matter on the Low-Pass Filter

Foreign matter entering the camera when lenses or body caps are removed or exchanged (or in rare circumstances lubricant or fine particles from the camera itself) may adhere to the low-pass filter, where it may appear in photographs taken under certain conditions. To prevent entry of foreign matter when attaching the body cap or exchanging lenses, avoid dusty environments and be sure to remove all dust and other foreign matter that may be adhering to the camera mount, lens mount, or body cap. To protect the camera when no lens is in place, be sure to replace the supplied body cap. Should you encounter foreign matter that cannot be removed using the image sensor cleaning option (☐ 823), clean the low-pass filter as described in “Manual Cleaning” (☐ 827), or have the filter cleaned by authorized Nikon service personnel.

Photographs affected by the presence of foreign matter on the sensor can be retouched using the clean image options available in some imaging applications.

✓ Servicing the Camera and Accessories

The camera is a precision device and requires regular servicing; Nikon recommends that the camera be inspected once every one to two years, and that it be serviced once every three to five years (note that fees apply to these services).

- Frequent inspection and servicing are particularly recommended if the camera is used professionally.
 - Any accessories regularly used with the camera, such as lenses or optional flash units, should be included when the camera is inspected or serviced.
-

Caring for the Camera and Battery: Cautions

Camera Care

● **Do Not Drop**

Do not drop the camera or lens or subject them to blows. The product may malfunction if subjected to strong shocks or vibration.

● **Keep Dry**

Keep the camera dry. Rusting of the internal mechanism caused by water inside the camera can not only be expensive to repair but can in fact cause irreparable damage.

● **Avoid Sudden Changes in Temperature**

Sudden changes in temperature, such as those that occur when entering or leaving a heated building on a cold day, can cause condensation inside the device. To prevent condensation, place the device in a carrying case or plastic bag before exposing it to sudden changes in temperature.

● **Keep Away from Strong Magnetic Fields**

Static charges or the magnetic fields produced by equipment such as radio transmitters could interfere with the monitor, corrupt data stored on the memory card, or affect the product's internal circuitry.

● **Do Not Leave the Lens Pointed at the Sun**

Do not leave the lens pointed at the sun or other strong light source for extended periods. Intense light may damage the image sensor or cause fading or "burn in". Photographs taken with the camera may exhibit a white blur effect.

● Lasers and other bright light sources

Do not direct lasers or other extremely bright light sources toward the lens, as this could damage the camera's image sensor.

● Cleaning

When cleaning the camera body, use a blower to gently remove dust and lint, then wipe gently with a soft, dry cloth. After using the camera at the beach or seaside, wipe off any sand or salt using a cloth lightly dampened in fresh water and then dry the camera thoroughly. In rare instances, static electricity may cause the LCD display to light up or go dark; this does not indicate a malfunction. The display will soon return to normal.

● Cleaning the Lens and Mirror

These elements are easily damaged: remove dust and lint with a blower. If using an aerosol blower, keep the can vertical to prevent the discharge of liquid that could damage glass elements. To remove fingerprints and other stains from the lens, apply a small amount of lens cleaner to a soft cloth and wipe the lens carefully.

● Cleaning the Low-Pass Filter

For information on cleaning the low-pass filter, see "The Low-Pass Filter" (☞ 823) and "Manual Cleaning" (☞ 827).

● The Lens Contacts

Keep the lens contacts clean.

● **Do Not Touch the Shutter Curtain**

- The shutter curtain is extremely thin and easily damaged: under no circumstances should you exert pressure on the curtain, poke it with cleaning tools, or subject it to powerful air currents from a blower. These actions could scratch, deform, or tear the curtain.
- The shutter curtain may appear to be unevenly colored; this does not indicate a malfunction. It also has no effect on pictures.

● **Store in a Well-Ventilated Area**

To prevent mold or mildew, store the camera in a dry, well-ventilated area. Do not store the camera with naphtha or camphor moth balls, next to equipment that produces strong electromagnetic, or where it will be exposed to extremely high temperatures, for example near a heater or in an enclosed vehicle on a hot day. Failure to observe these precautions could result in product malfunction.

● **Long-Term Storage**

To prevent damage caused by, for example, leaking battery fluid, remove the battery if the product will not be used for an extended period. Store the camera in a plastic bag containing a desiccant. Do not, however, store the camera case in a plastic bag, as this may cause the material to deteriorate. Store the battery in a cool, dry place. Note that desiccant gradually loses its capacity to absorb moisture and should be replaced at regular intervals. To prevent mold or mildew, take the camera out of storage at least once a month, insert the battery, and release the shutter a few times.

● **Turn the Product Off Before Removing or Disconnecting the Power Source**

Removing or disconnecting the power source while the camera is on could damage the product. Particular care should be taken not to remove or disconnect the power source while images are being recorded or deleted.

● **Notes on the Monitor**

- The monitor is constructed with extremely high precision; at least 99.99% of pixels are effective, with no more than 0.01% being missing or defective. Hence while these displays may contain pixels that are always lit (white, red, blue, or green) or always off (black), this is not a malfunction. Images recorded with the device are unaffected. Your understanding is requested.
- Images in the monitor may be difficult to see in a bright light.
- Do not apply pressure to the monitor. The monitor could malfunction or suffer damage. Dust or lint on the monitor can be removed with a blower. Stains can be removed by wiping the monitor lightly with a soft cloth or chamois leather. Should the monitor break, care should be taken to avoid injury from broken glass. Be careful that liquid crystal from the monitor does not touch the skin or enter the eyes or mouth.

● **Bright Lights and Back-Lit Subjects**

Noise in the form of lines may in rare cases appear in pictures that include bright lights or back-lit subjects.

Battery Care

● Precautions for Use

- If improperly handled, batteries may rupture or leak, causing the product to corrode. Observe the following precautions when handling batteries:
 - Turn the product off before replacing the battery.
 - Batteries may be hot after extended use.
 - Keep the battery terminals clean.
 - Use only batteries approved for use in this equipment.
 - Do not short or disassemble batteries or expose them to flame or excessive heat.
 - Replace the terminal cover when the battery is not inserted in the camera or charger.
- If the battery is hot, for example immediately after use, wait for it to cool before charging. Attempting to charge the battery while its internal temperature is elevated will impair battery performance, and the battery may not charge or charge only partially.
- If the battery will not be used for some time, insert it in the camera and run it flat before removing it from the camera for storage. The battery should be stored in a cool location with an ambient temperature of 15 °C to 25 °C (59 °F to 77 °F). Avoid hot or extremely cold locations.
- Batteries should be charged within six months of use. During long periods of disuse, charge the battery and use the camera to run it flat once every six months before returning it to a cool location for storage.

- Remove the battery from the camera or charger when not in use. The camera and charger draw minute amounts of charge even when off and could draw the battery down to the point that it will no longer function.
- Do not use the battery at ambient temperatures below 0 °C (32 °F) or above 40 °C (104 °F). Failure to observe this precaution could damage the battery or impair its performance. Charge the battery indoors at ambient temperatures of 5 °C–35 °C (41 °F–95 °F). The battery will not charge if its temperature is below 0 °C (32 °F) or above 60 °C (140 °F).
- Capacity may be reduced and charging times increase at battery temperatures from 0 °C (32 °F) to 15 °C (59 °F) and from 45 °C (113 °F) to 60 °C (140 °F).
- Batteries in general exhibit a drop in capacity at low ambient temperatures. Even fresh batteries charged at temperatures under about 5 °C (41 °F) may show a temporary increase from “0” to “1” in the setup menu [**Battery info**] age display, but the display will return to normal once the battery has been recharged at a temperature of about 20 °C (68 °F) or higher.
- Battery capacity drops at low temperatures. The change in capacity with temperature is reflected in the camera battery-level display. As a result, the battery display may show a drop in capacity as the temperature drops, even if the battery is fully charged.
- Batteries may be hot after use. Observe due caution when removing batteries from the camera.

● **Charge Batteries Before Use**

Charge the battery before use. The supplied battery is not fully charged at shipment.

● **Ready Spare Batteries**

Before taking photographs, ready a spare battery and keep it fully charged. Depending on your location, it may be difficult to purchase replacement batteries on short notice.

● **Have Fully-Charged Spare Batteries Ready on Cold Days**

Partially-charged batteries may not function on cold days. In cold weather, charge one battery before use and keep another in a warm place, ready to be exchanged as necessary. Once warmed, a cold battery may recover some of its charge.

● **Battery Level**

- Turning the camera on or off repeatedly when the battery is fully discharged will shorten battery life. Batteries that have been fully discharged must be charged before use.
- A marked drop in the time a fully charged battery retains its charge when used at room temperature indicates that it requires replacement. Purchase a new rechargeable battery.

● **Do Not Attempt to Charge Fully-Charged Batteries**

Continuing to charge the battery after it is fully charged can impair battery performance.

● **Recycling Used Batteries**

Recycle rechargeable batteries in accord with local regulations, being sure to first insulate the terminals with tape.

Using the Charger

- Do not move the charger or touch the battery during charging; failure to observe this precaution could in very rare instances result in the charger showing that charging is complete when the battery is only partially charged. Remove and reinsert the battery to begin charging again.
- Do not short the charger terminals. Failure to observe this precaution could result in overheating and damage to the charger.
- Unplug the charger when it is not in use.
- Use the MH-25a with compatible batteries only.
- Do not use chargers with damage that leaves the interior exposed or that produce unusual sounds when used.

Using the Charging AC Adapter

- Do not move the camera or touch the battery during charging. Failure to observe this precaution could in very rare instances result in the camera showing that charging is complete when the battery is only partially charged. Disconnect and reconnect the adapter to begin charging again.
- Do not short the adapter terminals. Failure to observe this precaution could result in overheating and damage to the adapter.
- Unplug the adapter when it is not in use.
- Do not use adapters with damage that leaves the interior exposed or that produce unusual sounds when used.

Specifications

Nikon D780 Digital Camera

Type	
Type	Single-lens reflex digital camera
Lens mount	Nikon F mount (with AF coupling and AF contacts)
Effective angle of view	Nikon FX format
Effective pixels	
Effective pixels	24.5 million
Image sensor	
Type	35.9 × 23.9 mm CMOS sensor
Total pixels	25.28 million
Dust-reduction system	Image sensor cleaning, Image Dust Off reference data (requires NX Studio)

Storage

Image size (pixels)	<ul style="list-style-type: none">• FX (36×24) image area:<ul style="list-style-type: none">- 6048 × 4024 (Large: 24.3 M)- 4528 × 3016 (Medium: 13.7 M)- 3024 × 2016 (Small: 6.1 M)• DX (24×16) image area:<ul style="list-style-type: none">- 3936 × 2624 (Large: 10.3 M)- 2944 × 1968 (Medium: 5.8 M)- 1968 × 1312 (Small: 2.6 M)• 1:1 (24×24) image area:<ul style="list-style-type: none">- 4016 × 4016 (Large: 16.1 M)- 3008 × 3008 (Medium: 9.0 M)- 2000 × 2000 (Small: 4.0 M)• 16:9 (36×20) image area:<ul style="list-style-type: none">- 6048 × 3400 (Large: 20.6 M)- 4528 × 2544 (Medium: 11.5 M)- 3024 × 1696 (Small: 5.1 M)• Photographs taken while filming movies at a frame size of 3840 × 2160: 3840 × 2160• Photographs taken while filming movies at other frame sizes: 1920 × 1080
File format (image quality)	<ul style="list-style-type: none">• NEF (RAW): 12 or 14 bit (lossless compressed or compressed)• JPEG: JPEG-Baseline compliant with fine (approx. 1:4), normal (approx. 1:8), or basic (approx. 1:16) compression; size-priority and optimal-quality compression available• NEF (RAW)+JPEG: Single photograph recorded in both NEF (RAW) and JPEG formats

Storage	
Picture Control System	Auto, Standard, Neutral, Vivid, Monochrome, Portrait, Landscape, Flat, Creative Picture Controls (Dream, Morning, Pop, Sunday, Somber, Dramatic, Silence, Bleached, Melancholic, Pure, Denim, Toy, Sepia, Blue, Red, Pink, Charcoal, Graphite, Binary, Carbon); selected Picture Control can be modified; storage for custom Picture Controls
Media	SD (Secure Digital) and UHS-II compliant SDHC and SDXC memory cards
Double card slots	The card in Slot 2 can be used for overflow or backup storage or for separate storage of NEF (RAW) and JPEG images; pictures can be copied between cards.
File system	DCF 2.0, Exif 2.31
Viewfinder	
Viewfinder	Eye-level pentaprism single-lens reflex viewfinder
Frame coverage	<ul style="list-style-type: none"> • FX: Approx. 100% horizontal and 100% vertical • DX: Approx. 97% horizontal and 97% vertical • 1:1: Approx. 97% horizontal and 100% vertical • 16:9: Approx. 100% horizontal and 97% vertical
Magnification	Approx. 0.7 \times (50 mm f/1.4 lens at infinity, -1.0 m^{-1})
Eyepoint	21 mm (-1.0 m^{-1} ; from center surface of viewfinder eyepiece lens)
Diopter adjustment	$-3 - +1 \text{ m}^{-1}$

Viewfinder	
Focusing screen	Type B BriteView Clear Matte Mark VIII screen (with AF-area brackets; framing grid can be displayed)
Reflex mirror	Quick return
Depth-of-field preview	Pressing Pv button stops lens aperture down to value selected by user (A and M modes) or by camera (P and S modes)
Lens aperture	Instant return, electronically controlled

Lens	
Compatible lenses	<ul style="list-style-type: none"> • Types G, E, and D (some restrictions apply to PC lenses) • Other AF NIKKOR lenses (excluding IX NIKKOR lenses and lenses for the F3AF) • AI-P NIKKOR lenses • DX lenses (using [DX (24 × 16)] image area) • Non-CPU AI lenses (modes A and M only) • During viewfinder photography, the electronic rangefinder can be used with lenses that have a maximum aperture of f/5.6 or faster. With lenses that have a maximum aperture of f/8 or faster, the electronic rangefinder supports 11 focus points.

Shutter	
Type	Electronically-controlled vertical-travel focal-plane mechanical shutter; electronic front-curtain shutter; electronic shutter
Speed	$1/8000$ –30 s (choose from step sizes of $1/3$ and $1/2$ EV, extendable to 900 s in mode M); Bulb; Time; X200
Flash sync speed	$X=1/200$ s; synchronizes with shutter at $1/200$ s or slower <ul style="list-style-type: none"> • Auto FP high-speed sync supported
Release	
Release mode	S (single frame), CL (continuous low speed), CH (continuous high speed), Q (quiet shutter-release), QC (quiet continuous shutter-release), \odot (self-timer), MUP (mirror up)
Approximate frame advance rate	<ul style="list-style-type: none"> • CL: 1 – 6 fps (viewfinder photography); 1–3 fps (live view photography) • CH: 7 fps; when shooting NEF/RAW pictures during silent photography, either 8 fps (bit depth 14 bits) or 12 fps (bit depth 12 bits) • QC: 3 fps
Self-timer	2 s, 5 s, 10 s, 20 s; 1 – 9 exposures at intervals of 0.5, 1, 2, or 3 s



Exposure	
Metering system	<ul style="list-style-type: none"> • Viewfinder photography: TTL exposure metering using RGB sensor with approximately 180K (180,000) pixels • Live view: TTL exposure metering performed by image sensor
Metering mode	<ul style="list-style-type: none"> • Matrix: 3D color matrix metering III (type G, E, and D lenses); color matrix metering III (other CPU lenses); color matrix metering available with non-CPU lenses if user provides lens data • Center-weighted: Weight of 75% given to 12 mm circle in center of frame; diameter of circle can be changed to 8, 15, or 20 mm, or weighting can be based on average of entire frame (non-CPU and AF-S Fisheye NIKKOR 8–15mm f/3.5–4.5E ED lenses use 12-mm circle) • Spot: Meters circle approximately 4 mm in diameter (about 1.5% of frame) centered on selected focus point (on center focus point when non-CPU or AF-S Fisheye NIKKOR 8–15mm f/3.5–4.5E ED lens is used) • Highlight-weighted: Available with type G, E, and D lenses
Range *	<ul style="list-style-type: none"> • Matrix and center-weighted metering: –3 – +20 EV • Spot metering: 2 – 20 EV • Highlight-weighted metering: 0 – 20 EV <p>* Figures are for ISO 100 and f/1.4 lens at 20 °C/68 °F</p>

Exposure	
Exposure meter coupling	Combined CPU and AI
Mode	<p>AUTO: Auto, P: programmed auto with flexible program, S: shutter-priority auto, A: aperture-priority auto, M: manual</p> <ul style="list-style-type: none"> • EFCT Special effects modes: night vision; VI super vivid; POP pop; photo illustration; toy camera effect; miniature effect; selective color; silhouette; high key; low key • U1 and U2: user settings
Exposure compensation	-5 – +5 EV; -3 – +3 EV when filming movies (choose from step sizes of 1/3 and 1/2 EV) available in P , S , A , M , and EFCT modes
Exposure lock	Luminosity locked at detected value
ISO sensitivity (Recommended Exposure Index)	ISO 100–51200 (choose from step sizes of 1/3 and 1/2 EV); can also be set to approx. 0.3, 0.5, 0.7, or 1 EV (ISO 50 equivalent) below ISO 100 or to approx. 0.3, 0.5, 0.7, 1, or 2 EV (ISO 204800 equivalent) above ISO 51200; auto ISO sensitivity control available
Active D-Lighting	Can be selected from Auto, Extra high, High, Normal, Low, or Off

Autofocus

Type	<ul style="list-style-type: none">• Viewfinder photography: TTL phase detection performed using Advanced Multi-CAM 3500 II autofocus sensor module with support for 51 focus points (including 15 cross-type sensors; f/8 supported by 11 sensors); autofocus fine-tuning supported• Live view: Hybrid phase-detection/contrast-detect AF performed by image sensor; autofocus fine-tuning supported
Detection range	<ul style="list-style-type: none">• Viewfinder photography¹: -3 – +19 EV• Live view²: -5 – +19 EV; -7 – +19 EV with low-light AF <ol style="list-style-type: none">1 Figures are for ISO 100 at 20 °C/68 °F.2 Still photography using single-servo AF (AF-S) and apertures of f/1.4 at dark end of range and f/5.6 at bright end of range; ISO 100; 20 °C/68 °F
Lens servo	<ul style="list-style-type: none">• Autofocus (AF): Single-servo AF (AF-S); continuous-servo AF (AF-C); AF mode auto-switch (AF-A, still photography only); full-time AF (AF-F, movie recording only); predictive focus tracking activated automatically according to subject status• Manual focus (M): Electronic rangefinder can be used
Focus points	<ul style="list-style-type: none">• Viewfinder photography: 51 points with [All points] selected for Custom Setting a6 [Focus points used], 11 points with [Every other point] selected• Live view[*]: 273 points with [All points] selected for Custom Setting a6 [Focus points used], 77 points with [Every other point] selected <p>[*] Still photography, [FX (36x24)] image area, single-point AF</p>

Autofocus	
AF-area mode	<ul style="list-style-type: none"> • Viewfinder photography: Single-point AF, 9-, 21-, or 51- point dynamic-area AF, 3D-tracking, group-area AF, auto-area AF • Live view: Pinpoint AF (still photography only, single-servo AF/AF-S), single-point AF, dynamic-area AF (still photography only, continuous-servo AF/AF-C), wide-area AF (S), wide-area AF (L), auto-area AF
Focus lock	Focus can be locked by pressing shutter-release button halfway (single-servo AF/ AF-S) or by pressing AF-L button
Flash	
Flash control	<ul style="list-style-type: none"> • Viewfinder photography: TTL flash control performed by RGB sensor with approximately 180K (180,000) pixels • Live view photography: TTL flash control performed by image sensor • i-TTL balanced fill flash for digital SLR available with matrix, center-weighted, and highlight-weighted metering; standard i-TTL fill-flash for digital SLR available with spot metering
Flash mode	Front-curtain sync, red-eye reduction, slow sync, red-eye reduction with slow sync, rear-curtain sync, off
Flash compensation	-3 – +1 EV (choose from step sizes of $\frac{1}{3}$ and $\frac{1}{2}$ EV) available in P , S , A , and M modes

Flash	
Flash-ready indicator	Lights when optional flash unit is fully charged; flashes after flash is fired at full output
Accessory shoe	ISO 518 hot-shoe with sync and data contacts and safety lock
Nikon Creative Lighting System (CLS)	i-TTL flash control, radio-controlled Advanced Wireless Lighting, optical Advanced Wireless Lighting, modeling illumination, FV lock, Color Information Communication, auto FP high-speed sync, AF-assist for multi-area AF (viewfinder photography), unified flash control
Sync terminal	AS-15 sync terminal adapter (available separately)
White balance	
White balance	Auto (3 types), natural light auto, direct sunlight, cloudy, shade, incandescent, fluorescent (7 types), flash, choose color temperature (2500 K–10,000 K), preset manual (up to 6 values can be stored, spot white balance measurement available during live view photography), all except choose color temperature with fine-tuning
Bracketing	
Bracketing	Exposure and/or flash, white balance, and ADL
Live view	
Mode	 (photo live view),  (movie live view)

Movie	
Metering system	TTL metering using camera image sensor
Metering mode	Matrix, center-weighted, or highlight-weighted
Frame size (pixels) and frame rate	<ul style="list-style-type: none"> • 3840 × 2160 (4K UHD); 30p (progressive), 25p, 24p • 1920 × 1080; 120p, 100p, 60p, 50p, 30p, 25p, 24p • 1920 × 1080 (slow-motion); 30p ×4, 25p ×4, 24p ×5 <p>* Actual frame rates for 120p, 100p, 60p, 50p, 30p, 25p, and 24p are 119.88, 100, 59.94, 50, 29.97, 25, and 23.976 fps respectively</p> <p>* Quality selection available at all sizes except 3840 × 2160, 1920 × 1080 120p/100p, and 1920 × 1080 slow-motion, when quality is fixed at ★ (high)</p>
File format	MOV, MP4
Video compression	H.264/MPEG-4 Advanced Video Coding
Audio recording format	Linear PCM, AAC
Audio recording device	Built-in stereo or external microphone with attenuator option; sensitivity adjustable

Movie	
ISO sensitivity (Recommended Exposure Index)	Manual selection (ISO 100 to 51200; choose from step sizes of $\frac{1}{3}$ and $\frac{1}{2}$ EV) with additional options available equivalent to approximately 0.3, 0.5, 0.7, 1, or 2 EV (ISO 204800 equivalent) above ISO 51200; auto ISO sensitivity control (ISO 100 to Hi 2) available with selectable upper limit
Active D-Lighting	Can be selected from Same as photo settings, Extra high, High, Normal, Low, or Off
Other options	Time-lapse movie recording, electronic vibration reduction, time codes, logarithmic (N-Log) and HDR (HLG) movie output
Monitor	
Monitor	8-cm/3.2-in., approx. 2359k-dot (XGA) tilting TFT touch-sensitive LCD with 170° viewing angle, approximately 100% frame coverage, 11-level manual brightness adjustment, and color balance control

Playback	
Playback	Full-frame and thumbnail (4, 9, or 72 images or calendar) playback with playback zoom, playback zoom cropping, movie playback, photo and/or movie slide shows, histogram display, highlights, photo information, location data display, picture rating, auto image rotation, and index marking
Interface	
USB	Type C USB connector (SuperSpeed USB); connection to built-in USB port is recommended
HDMI output	Type C HDMI connector
Audio input	Stereo mini-pin jack (3.5mm diameter; plug-in power supported)
Audio output	Stereo mini-pin jack (3.5mm diameter)
Accessory terminal	Built-in (can be used with accessories such as the MC-DC2 remote cord)

Wi-Fi

- **Standards:**
 - IEEE 802.11b/g/n (Africa, Asia, and Oceania)
 - IEEE 802.11b/g/n/a/ac (Europe, U.S.A., Canada, and Mexico)
 - IEEE 802.11b/g/n/a (other countries in the Americas)
- **Operating frequency:**
 - 2412–2462 MHz (channel 11; Africa, Asia, and Oceania)
 - 2412–2462 MHz (channel 11) and 5180–5825 MHz (U.S.A., Canada, and Mexico)
 - 2412–2462 MHz (channel 11) and 5180–5805 MHz (other countries in the Americas)
 - 2412–2462 MHz (channel 11) and 5745–5805 MHz (Georgia)
 - 2412–2462 MHz (channel 11) and 5180–5320 MHz (other European countries)
- **Maximum output power (EIRP):**
 - 2.4 GHz band: 2.9 dBm
 - 5 GHz band: 5.7 dBm (Georgia)
 - 5 GHz band: 8.7 dBm (other countries)
- **Authentication:** Open system, WPA2-PSK

Wi-Fi/Bluetooth	
Bluetooth	<ul style="list-style-type: none"> • Communication protocols: Bluetooth Specification Version 4.2 • Operating frequency: <ul style="list-style-type: none"> - Bluetooth: 2402–2480 MHz - Bluetooth Low Energy: 2402–2480 MHz • Maximum output power (EIRP): <ul style="list-style-type: none"> - Bluetooth: –2.6 dBm - Bluetooth Low Energy: –4.1 dBm
Range (line of sight)	<p>Approximately 10 m (32 ft) *</p> <p>* Without interference. Range may vary with signal strength and presence or absence of obstacles.</p>
Power source	
Battery	<p>One EN-EL15b rechargeable Li-ion battery *</p> <p>* EN-EL15c/EN-EL15a/EN-EL15 batteries can also be used. Note, however, that fewer pictures may sometimes be taken on a single charge with the EN-EL15 than with an EN-EL15c/EN-EL15b/EN-EL15a. EH-7P charging AC adapter can be used to charge EN-EL15c/EN-EL15b batteries only.</p>
AC adapter	<p>EH-5d/EH-5c/EH-5b AC adapter; requires EP-5B power connector (available separately)</p>

Tripod socket**Tripod socket** 0.635 cm (1/4 in., ISO 1222)**Dimensions/weight****Dimensions (W × H × D)** Approx. 143.5 × 115.5 × 76 mm (5.7 × 4.6 × 3 in.)**Weight** Approx. 840 g (1 lb. 13.7 oz.) with battery and SD memory card but without body cap; approx. 755 g/1 lb. 10.7 oz. (camera body only)**Operating environment****Temperature** 0 °C–40 °C (+32 °F–104 °F)**Humidity** 85% or less (no condensation)

- Unless otherwise stated, all measurements are performed in conformity with Camera and Imaging Products Association (CIPA) standards or guidelines.
- All figures are for a camera with a fully-charged battery.
- The sample images displayed on the camera and the images and illustrations in the manuals are for expository purposes only.
- Nikon reserves the right to change the appearance and specifications of the hardware and software described in this manual at any time and without prior notice. Nikon will not be held liable for damages that may result from any mistakes that this manual may contain.

■ MH-25a Battery Charger

Rated input	AC 100–240 V, 50/60 Hz, 0.23–0.12 A
Rated output	DC 8.4 V/1.2 A
Supported batteries	EN-EL15c/EN-EL15b/EN-EL15a/EN-EL15 rechargeable Li-ion batteries
Charging time	Approx. 2 hours and 35 minutes * Time required to charge battery at an ambient temperature of 25 °C (77 °F) when no charge remains
Operating temperature	0 °C–40 °C (+32 °F–104 °F)
Dimensions (W × H × D)	Approx. 95 × 33.5 × 71 mm (3.7 × 1.3 × 2.8 in.), excluding projections
Length of power cable	Approx. 1.5 m (4.9 ft), if supplied
Weight	Approx. 115 g (4.1 oz), excluding supplied power connector (power cable or AC wall adapter)

The symbols on this product represent the following:

~ AC, — DC,  Class II equipment (the construction of the product is double-insulated)

■ EN-EL15b Rechargeable Li-ion Battery:

Type	Rechargeable lithium-ion battery
Rated capacity	7.0 V/1900 mAh
Operating temperature	0 °C–40 °C (+32 °F–104 °F)
Dimensions (W × H × D)	Approx. 40 × 56 × 20.5 mm (1.6 × 2.2 × 0.8 in.)
Weight	Approx. 80 g (2.9 oz), excluding terminal cover

✔ Disposing of Data Storage Devices

Please note that deleting images or formatting memory cards or other data storage devices does not completely erase the original image data. Deleted files can sometimes be recovered from discarded storage devices using commercially available software, potentially resulting in the malicious use of personal image data. Ensuring the privacy of such data is the user's responsibility.

Before discarding a data storage device or transferring ownership to another person, erase all data using commercial deletion software, or format the device and then completely refill it with images containing no private information (for example, pictures of empty sky). Care should be taken to avoid injury when physically destroying data storage devices. Before discarding the camera or transferring ownership to another person, you should also use the **[Reset all settings]** item in the camera setup menu to delete network settings and other personal information.

✔ Supported Standards

- **DCF Version 2.0:** The Design Rule for Camera File System (DCF) is a standard widely used in the digital camera industry to ensure compatibility among different makes of camera.
 - **Exif version 2.31:** The camera supports Exif (Exchangeable Image File Format for Digital Still Cameras) version 2.31, a standard introduced with the goal of improving the interoperability of printers and digital cameras, making it easier to produce high-quality prints. Information stored with photographs is used for optimal color reproduction when the images are output on Exif-compliant printers. See the printer manual for details.
 - **HDMI:** High-Definition Multimedia Interface is a standard for multimedia interfaces used in consumer electronics and AV devices. This standard ensures that audiovisual data and control signals can be transmitted to HDMI-compliant devices via a single cable connection.
-

Approved Memory Cards

- The camera can be used with SD, SDHC, and SDXC memory cards.
- UHS-I and UHS-II are supported.
- Cards rated UHS Speed Class 3 or better are recommended for movie recording and playback. Slower speeds may result in recording or playback being interrupted.
- When choosing cards for use in card readers, be sure they are compatible with the device.
- Contact the manufacturer for information on features, operation, and limitations on use.



Memory Card Capacity

The following table shows the approximate number of pictures that can be stored on a 64 GB ¹ card at different image area, image quality, and image size settings. Actual capacity varies with shooting conditions and the type of card.

[FX (36 × 24)] Selected for Image Area

The following table shows the memory card and buffer capacity when **[FX (36 × 24)]** is selected for **[Image area] > [Choose image area]** in the photo shooting menu.

- This category also includes images taken with non-DX lenses when **[On]** is selected for **[Image area] > [Auto DX crop]**.

Image quality	Image size	File size	Number of exposures remaining ²	Buffer capacity ^{2, 3}
NEF (RAW), Lossless compressed, 12-bit	—	Approx. 21.7 MB	1400 frames	100 frames
NEF (RAW), Lossless compressed, 14-bit	—	Approx. 27.7 MB	1200 frames	68 frames
NEF (RAW), Compressed, 12-bit	—	Approx. 19.4 MB	1800 frames	100 frames
NEF (RAW), Compressed, 14-bit	—	Approx. 24.1 MB	1500 frames	100 frames

Image quality	Image size	File size	Number of exposures remaining²	Buffer capacity^{2,3}
JPEG fine⁴	Large	Approx. 9.8 MB	3600 frames	100 frames
	Medium	Approx. 6.7 MB	6000 frames	100 frames
	Small	Approx. 4.1 MB	11,200 frames	100 frames
JPEG normal⁴	Large	Approx. 6.6 MB	7000 frames	100 frames
	Medium	Approx. 4.0 MB	11,700 frames	100 frames
	Small	Approx. 2.2 MB	21,900 frames	100 frames
JPEG basic⁴	Large	Approx. 2.3 MB	13,700 frames	100 frames
	Medium	Approx. 1.7 MB	21,900 frames	100 frames
	Small	Approx. 1.2 MB	40,100 frames	100 frames

[DX (24 × 16)] Selected for Image Area

The following table shows the memory card and buffer capacity when **[DX (24 × 16)]** is selected for **[Image area] > [Choose image area]** in the photo shooting menu.

- This category also includes images taken with DX lenses when **[On]** is selected for **[Image area] > [Auto DX crop]**.

Image quality	Image size	File size	Number of exposures remaining ²	Buffer capacity ^{2, 3}
NEF (RAW), Lossless compressed, 12-bit	—	Approx. 9.9 MB	3000 frames	100 frames
NEF (RAW), Lossless compressed, 14-bit	—	Approx. 12.5 MB	2600 frames	100 frames
NEF (RAW), Compressed, 12-bit	—	Approx. 8.8 MB	3800 frames	100 frames
NEF (RAW), Compressed, 14-bit	—	Approx. 10.8 MB	3300 frames	100 frames

Image quality	Image size	File size	Number of exposures remaining²	Buffer capacity^{2,3}
JPEG fine⁴	Large	Approx. 4.8 MB	7600 frames	100 frames
	Medium	Approx. 3.5 MB	11,700 frames	100 frames
	Small	Approx. 2.4 MB	19,200 frames	100 frames
JPEG normal⁴	Large	Approx. 3.2 MB	14,600 frames	100 frames
	Medium	Approx. 2.1 MB	21,900 frames	100 frames
	Small	Approx. 1.3 MB	34,400 frames	100 frames
JPEG basic⁴	Large	Approx. 1.2 MB	26,700 frames	100 frames
	Medium	Approx. 1.0 MB	40,100 frames	100 frames
	Small	Approx. 0.7 MB	60,200 frames	100 frames

- 1 Figures are for a 64 GB SanDisk SD UHS-II memory card (SDSDXPK-064G-JNJIP, measured in September 2019).
- 2 Number of pictures that can be saved to memory card or stored in memory buffer varies with scene recorded.
- 3 Maximum number of exposures that can be stored in memory buffer at ISO 100. May drop in some situations, including when:
 - An optimal-compression (★) JPEG option is selected for **[Image quality]**
 - **[On]** is selected for **[Auto distortion control]**
- 4 Figures assume a size-priority option (an option not marked with ★) is selected for **[Image quality]**. Selecting an optimal-compression option (★) increases file size; the number of images and buffer capacity drop accordingly.

✓ **Maximum Number of Photos per Burst**

The maximum number of photographs that can be taken in a single burst can be set to any amount between 1 and 100 using Custom Setting d2 **[Max. continuous release]**.

Battery Endurance

The movie footage or number of shots that can be recorded with a fully-charged EN-EL15b (1900 mAh) rechargeable Li-ion battery is given below.¹ Actual endurance varies with such factors as the condition of the battery, the interval between shots, and the options selected in the camera menus.

- Photographs, single-frame release mode: Approximately 2260 (CIPA standard²)
- Photographs, continuous release modes: Approximately 4570 (Nikon standard³)
- Movies: Approximately 95 minutes⁴

Actions such as the following can reduce battery endurance:

- Using the monitor, for example for live view photography
- Keeping the shutter-release button pressed halfway
- Repeated autofocus operations
- Taking NEF (RAW) photographs
- Slow shutter speeds
- Using camera Wi-Fi (wireless LAN) and Bluetooth features
- Using the camera with optional accessories connected
- Using VR (vibration reduction) mode with VR lenses
- Repeatedly zooming in and out with an AF-P lens
- Taking pictures at low ambient temperatures

To ensure that you get the most from rechargeable Nikon EN-EL15b batteries:

- Keep the battery contacts clean. Soiled contacts can reduce battery performance.
 - Use batteries immediately after charging. Batteries will lose their charge if left unused.
- 1 EN-EL15c/EN-EL15a/EN-EL15 batteries can also be used. Note, however, that fewer pictures may sometimes be taken on a single charge with the EN-EL15 than with an EN-EL15c/EN-EL15b/EN-EL15a.
 - 2 Lens cycled from infinity to minimum range and one photograph taken at default settings once every 30 s. Live view not used. Measured at 23 °C/73.4 °F (± 2 °C/3.6 °F) with an AF-S NIKKOR 24–120mm f/4G ED VR lens. Figures are for a 32 GB SanDisk SD UHS-II memory card (SDSDXPK-032G-JNJIP – 32GB, measured in September 2019).
 - 3 Image quality set to JPEG normal, image size set to large, shutter speed $1/250$ s, focus cycled from infinity to minimum range three times after shutter-release button has been pressed halfway for 3 s; six shots are then taken in succession and monitor turned on for 5 s and then turned off; no operations performed until stand-by timer has expired. The cycle is then repeated. Measured at 23 °C/73.4 °F (± 2 °C/3.6 °F) with an AF-S NIKKOR 70–200mm f/2.8E FL ED VR lens (VR off). Figures are for a 32 GB SanDisk SD UHS-II memory card (SDSDXPK-032G-JNJIP – 32GB, measured in September 2019).

- 4 Actual battery endurance as measured under conditions specified by the Camera and Imaging Products Association (CIPA). Measured at 23 °C/73.4 °F (± 2 °C/3.6 °F) with an AF-S NIKKOR 24–120mm f/4G ED VR lens. Figures are for a 32 GB SanDisk SD UHS-II memory card (SDSDXPK-032G-JNJIP – 32GB, measured in September 2019). Measurement performed at default settings.
- Each shot can be up to 29 minutes 59 seconds in length.
 - If camera temperature rises, recording may end before maximum length or size is reached.

Trademarks and Licenses

- The SD, SDHC, and SDXC logos are trademarks of SD-3C, LLC.
- Windows is either a registered trademark or a trademark of Microsoft Corporation in the United States and/or other countries.
- Apple®, App Store®, the Apple logos, iPhone®, iPad®, iPod touch®, Mac, macOS, and OS X are trademarks of Apple Inc. registered in the U.S. and/or other countries.
- Android, Google Play and the Google Play logo are trademarks of Google LLC. The Android robot is reproduced or modified from work created and shared by Google and used according to terms described in the Creative Commons 3.0 Attribution License.
- IOS is a trademark or registered trademark of Cisco Systems, Inc., in the United States and/or other countries and is used under license.
- HDMI, the HDMI logo and High-Definition Multimedia Interface are trademarks or registered trademarks of HDMI Licensing, LLC.

HDMI

- The Bluetooth® word mark and logo are registered trademarks owned by Bluetooth SIG, Inc., and any use of such marks by Nikon is under license.
- Wi-Fi and the Wi-Fi logo are trademarks or registered trademarks of the Wi-Fi Alliance.
- All other trade names mentioned in this manual or the other documentation provided with your Nikon product are trademarks or registered trademarks of their respective holders.

Use of the Made for Apple badge means that an accessory has been designed to connect specifically to the Apple products identified in the badge, and has been certified by the developer to meet Apple performance standards. Apple is not responsible for the operation of this device or its compliance with safety and regulatory standards. Please note that the use of this accessory with an Apple product may affect wireless performance.

✔ **FreeType License (FreeType2)**

Portions of this software are copyright © 2012 The FreeType Project (<https://www.freetype.org>). All rights reserved.

✔ **MIT License (HarfBuzz)**

Portions of this software are copyright © 2018 The HarfBuzz Project (<https://www.freedesktop.org/wiki/Software/HarfBuzz>). All rights reserved.

✔ Unicode® Character Database License (Unicode® Character Database)

The software for this product uses the Unicode® Character Database License open-source software. The terms of the software license are as follows:

COPYRIGHT AND PERMISSION NOTICE

Copyright © 1991-2019 Unicode, Inc. All rights reserved.

Distributed under the Terms of Use in

<https://www.unicode.org/copyright.html>.

Permission is hereby granted, free of charge, to any person obtaining a copy of the Unicode data files and any associated documentation (the "Data Files") or Unicode software and any associated documentation (the "Software") to deal in the Data Files or Software without restriction, including without limitation the rights to use, copy, modify, merge, publish, distribute, and/or sell copies of the Data Files or Software, and to permit persons to whom the Data Files or Software are furnished to do so, provided that either

- (i) this copyright and permission notice appear with all copies of the Data Files or Software, or
- (ii) this copyright and permission notice appear in associated Documentation.

THE DATA FILES AND SOFTWARE ARE PROVIDED "AS IS", WITHOUT WARRANTY OF ANY KIND, EXPRESS OR IMPLIED, INCLUDING BUT NOT LIMITED TO THE WARRANTIES OF MERCHANTABILITY, FITNESS FOR A PARTICULAR PURPOSE AND NONINFRINGEMENT OF THIRD PARTY RIGHTS.

IN NO EVENT SHALL THE COPYRIGHT HOLDER OR HOLDERS INCLUDED IN THIS NOTICE BE LIABLE FOR ANY CLAIM, OR ANY SPECIAL INDIRECT OR CONSEQUENTIAL DAMAGES, OR ANY DAMAGES WHATSOEVER RESULTING FROM LOSS OF USE, DATA OR PROFITS, WHETHER IN AN ACTION OF CONTRACT, NEGLIGENCE OR OTHER TORTIOUS ACTION, ARISING OUT OF OR IN CONNECTION WITH THE USE OR PERFORMANCE OF THE DATA FILES OR SOFTWARE.

Except as contained in this notice, the name of a copyright holder shall not be used in advertising or otherwise to promote the sale, use or other dealings in these Data Files or Software without prior written authorization of the copyright holder.

AVC Patent Portfolio License

THIS PRODUCT IS LICENSED UNDER THE AVC PATENT PORTFOLIO LICENSE FOR THE PERSONAL AND NON-COMMERCIAL USE OF A CONSUMER TO (i) ENCODE VIDEO IN COMPLIANCE WITH THE AVC STANDARD ("AVC VIDEO") AND/OR (ii) DECODE AVC VIDEO THAT WAS ENCODED BY A CONSUMER ENGAGED IN A PERSONAL AND NONCOMMERCIAL ACTIVITY AND/OR WAS OBTAINED FROM A VIDEO PROVIDER LICENSED TO PROVIDE AVC VIDEO. NO LICENSE IS GRANTED OR SHALL BE IMPLIED FOR ANY OTHER USE. ADDITIONAL INFORMATION MAY BE OBTAINED FROM MPEG LA, L.L.C. SEE

<https://www.mpegla.com>

Kit Lens Manual

Kit Lenses

AF-S NIKKOR 24–120mm f/4G ED VR Lens Manual

This section is included as a lens manual for purchasers of the AF-S NIKKOR 24–120mm f/4G ED VR lens kit.

- Note that lens kits may not be available in some countries or regions.

Parts of the Lens

The parts of the AF-S NIKKOR 24–120mm f/4G ED VR are listed below.

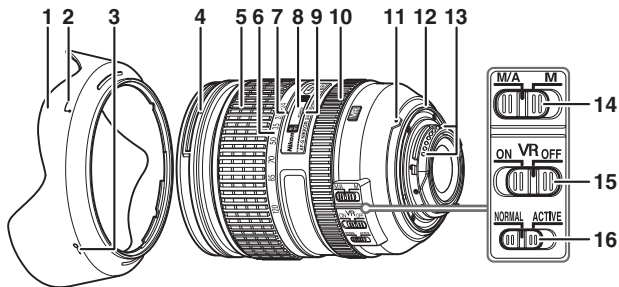

- | | |
|---|----------------------------------|
| 1 | Lens hood (☞ 882) |
| 2 | Lens hood alignment mark (☞ 882) |
| 3 | Lens hood lock mark (☞ 882) |
| 4 | Lens hood mounting mark (☞ 882) |
| 5 | Zoom ring |
| 6 | Focal length scale |
| 7 | Focal length mark |
| 8 | Focus distance indicator |

- | | |
|----|------------------------------------|
| 9 | Focus distance mark |
| 10 | Focus ring (☞ 162) |
| 11 | Lens mounting mark (☞ 25) |
| 12 | Rubber lens-mount gasket |
| 13 | CPU contacts (☞ 791) |
| 14 | Focus-mode switch (☞ 162) |
| 15 | Vibration reduction switch (☞ 880) |
| 16 | Vibration reduction mode switch |

■ Focus

Supported focus modes are shown in the following table.

Camera focus mode	Lens focus mode	
	M/A	M
AF (A/S/C)	Autofocus with manual override (manual priority)	Manual focus with electronic rangefinder
MF	Manual focus with electronic rangefinder	

For information on camera focus modes, see the camera manual.

M/A (Autofocus with Manual Override)

1 Slide the lens focus-mode switch to M/A.

2 If desired, autofocus can be over-ridden by rotating the lens focus ring while the shutter-release button is pressed halfway or the AF-ON button is pressed.

3 To refocus using autofocus, press the shutter-release button halfway or press the AF-ON button again.

■ Zoom and Depth of Field

Before focusing, rotate the zoom ring to adjust the focal length and frame the photograph. If the camera offers depth-of-field preview (stop down), depth of field can be previewed in the viewfinder.

- The lens uses Nikon's Internal Focusing (IF) system. Focal length decreases as the focus distance shortens.
- The focus distance indicator is intended only as a guide and may not accurately show the distance to the subject. In addition, the focus distance indicator may, due to depth of field or other factors, not show ∞ when the camera is focused on a distant object.

■ Aperture

Aperture is adjusted using camera controls.

■ Using the Lens on Cameras with a Built-in Flash

When using the camera's built-in flash:

- Be sure the subject is at a range of at least 0.6 m (2 ft).
 - Remove lens hoods to prevent them casting shadows in pictures taken with the flash.
- * If the flash is partially obscured by the lens hood or the tip of the lens, shadows will appear on subjects close to the camera.

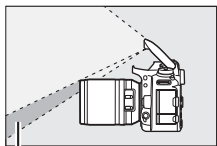

1

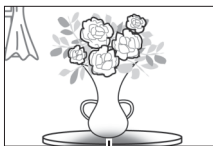

2

1 Shadow

2 Shadow

- When the lens is mounted on the following cameras, the built-in flash may be unable to light the entire subject at ranges less than those given below:

Digital SLR camera	Zoom position/minimum distance without shadows
D750 (FX format)/ D610 (FX format)/ D600 (FX format)	<ul style="list-style-type: none"> • 24 mm/2.0 m (6 ft 7 in.) • 28 mm/1.0 m (3 ft 4 in.) • 50 mm and up/no shadows
D810 series (FX format)/ D800 series (FX format)	<ul style="list-style-type: none"> • 28 mm/1.0 m (3 ft 4 in.) • 35 mm and up/no shadows
D700 (FX format)	<ul style="list-style-type: none"> • 24 mm/3.0 m (9 ft 11 in.) • 35 mm and up/no shadows
D300 series/D200/D100	<ul style="list-style-type: none"> • 24 mm/1.0 m (3 ft 4 in.) • 35 mm and up/no shadows
D90/D80/D70 series/D50	<ul style="list-style-type: none"> • 24 mm/1.5 m (5 ft) • 35 mm and up/no shadows
D5600/D5500/D5300/D5200/ D5100/D3300/D3200	<ul style="list-style-type: none"> • 24 mm/1.5 m (5 ft) • 28 mm and up/no shadows
D5000/D3100/D3000/D60/ D40 series	<ul style="list-style-type: none"> • 24 mm/2.5 m (8 ft 3 in.) • 35 mm and up/no shadows
D3400	<ul style="list-style-type: none"> • 24 mm/1.5 m (5 ft) • 28 mm/1.0 m (3 ft 4 in.) • 35 mm and up/no shadows

■ Vibration Reduction (VR)

Using the Vibration Reduction Switch

ON: Enable vibration reduction. Vibration reduction is activated when the shutter-release button is pressed halfway, reducing the effects of camera shake for improved framing and focus.

OFF: Vibration reduction off.

Using the Vibration Reduction Mode Switch

The option selected with the vibration reduction mode switch takes effect when the vibration reduction switch is in the **ON** position.

NORMAL: Compensate chiefly for normal forms of vibration. Vibration reduction also applies when the camera is panned.

ACTIVE: Reduce the effects of vibration when shooting from a moving vehicle, and in other situations with active camera motion. The camera does not detect panning motion.

✔ Using Vibration Reduction: Notes

- When using vibration reduction, press the shutter-release button halfway and wait for the image in the viewfinder to stabilize before pressing the shutter-release button the rest of the way down.
 - When vibration reduction is active, the image in the viewfinder may jiggle after the shutter is released, but this does not indicate a malfunction.
 - Slide the vibration reduction mode switch to **NORMAL** for panning shots. In **NORMAL** mode, vibration reduction applies only to motion that is not part of a pan. If the camera is panned horizontally, for example, vibration reduction will be applied only to vertical shake.
 - Do not turn the camera off or remove the lens while vibration reduction is in effect. If power to the lens is cut while vibration reduction is on, the lens may rattle when shaken, but this does not indicate a malfunction. The rattling will end when the lens is reattached and the camera turned on.
 - If the camera is equipped with a built-in flash, vibration reduction will be disabled while the flash charges.
 - In the case of cameras equipped with an AF-ON button, vibration reduction will not be performed when the button is pressed.
 - Select **OFF** when the camera is mounted on a tripod. Note, however, that **ON** is recommended if the tripod head is unsecured or the camera is mounted on a monopod.
-

■ The Lens Hood

The lens hood protects the lens and blocks stray light that would otherwise cause flare or ghosting.

Attaching the Hood

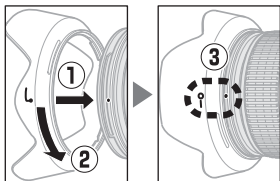

- Confirm that the lens hood mounting mark (●) is aligned with the lens hood lock mark (—○) as shown in the illustration (③).
- When attaching or removing the hood, avoid gripping it too tightly. When attaching or removing the hood, hold it near the hood alignment mark (└─).
- Vignetting may occur if the hood is not correctly attached.
- The hood can be reversed and mounted on the lens when not in use.

■ Supplied Accessories

- LC-77 Lens Cap (front cap)
 - LF-4 Lens Cap (rear cap) *
 - HB-53 Lens Hood
 - CL-1218 Flexible Lens Pouch
- * A different cap may be supplied with lens kits.

■ Compatible Accessories

- 77 mm screw-on filters

■ Specifications

Type	Type G AF-S lens with built-in CPU and F mount
Focal length	24–120 mm
Maximum aperture	f/4
Lens construction	17 elements in 13 groups (including 2 ED lens elements, 3 aspherical lens elements, and lens elements with Nano Crystal Coat)
Angle of view	84° – 20° 20' (Nikon FX-format D-SLR cameras) 61° – 13° 20' (Nikon DX-format D-SLR cameras)
Focal length scale	Graduated in millimeters (24, 28, 35, 50, 70, 85, 120)
Distance information	Output to camera
Zoom	Manual zoom using independent zoom ring
Focusing	Nikon Internal Focusing (IF) System with autofocus controlled by Silent Wave Motor and separate focus ring for manual focus
Vibration reduction	Lens shift using voice coil motors (VCMs)
Focus distance indicator	0.45 m to infinity (∞)
Minimum focus distance	0.45 m (1.48 ft) from focal plane at all zoom positions

Diaphragm blades	9 (rounded diaphragm opening)
Diaphragm	Fully automatic
Aperture range	f/4–22
Metering system	Full aperture
Filter-attachment size	77 mm (P = 0.75 mm)
Dimensions	Approx. 84 mm maximum diameter × 103.5 mm (distance from camera lens mount flange)
Weight	Approx. 710 g (1 lb 9.1 oz)

















- Nikon reserves the right to change the appearance and specifications of the hardware and software described in this manual at any time and without prior notice.
- Nikon will not be held liable for damages that may result from any mistakes that this manual may contain.



















✔ Lens Care

- Keep the CPU contacts clean.
 - Should the rubber lens-mount gasket be damaged, cease use immediately and take the lens to a Nikon-authorized service center for repair.
 - Use a blower to remove dust and lint from the lens surfaces. To remove smudges and fingerprints, apply a small amount of ethanol or lens cleaner to a soft, clean cotton cloth or lens-cleaning tissue and clean from the center outwards using a circular motion, taking care not to leave smears or touch the glass with your fingers.
 - Never use organic solvents such as paint thinner or benzine to clean the lens.
 - Neutral Color (NC) filters can be used to protect the front lens element. The lens hood can also be used.
 - Attach the lens caps before placing the lens in its case.
 - When a lens hood is attached, do not pick up or hold the lens or camera using only the hood.
 - If the lens will not be used for an extended period, store it in a cool, dry location to prevent mold and rust. Do not store in direct sunlight or with naphtha or camphor moth balls.
 - Keep the lens dry; rusting of the internal mechanism could damage the lens.
 - Do not leave the lens near heaters or in other hot locations. Extreme heat could damage or warp parts made from reinforced plastic.
-

Index

Symbols

 (Auto mode).....	36
P (Programmed auto).....	109
S (Shutter-priority auto).....	110
A (Aperture-priority auto).....	111
M (Manual).....	113
EFCT (Special effects).....	119
U1/U2	115
 (Night vision).....	119
VI (Super vivid).....	119
POP (Pop).....	119
 (Photo illustration).....	119, 122
 (Toy camera effect).....	120, 123
 (Miniature effect).....	120, 124
 (Selective color).....	120, 126
 (Silhouette).....	120
 (High key).....	120
 (Low key).....	120
S (Single frame).....	73, 179
CL (Continuous low speed).....	73, 179
CH (Continuous high speed).....	74, 179
Q (Quiet shutter-release).....	74, 180
QC (Quiet continuous shutter-release).....	74, 180
 (Self-timer).....	74, 180, 183
MUP	74, 180, 185
 (Pinpoint AF).....	80, 150
 (Single-point AF).....	78, 80, 145
 (Wide-area AF (S)).....	80, 150
 (Wide-area AF (L)).....	80, 150
 (Dynamic-area AF).....	78, 80, 145
[3D] (3D-tracking).....	79, 146
 (Group-area AF).....	79, 146

 (Auto-area AF).....	79, 81, 147, 151, 155
 (Matrix metering).....	100, 166, 603
 (Center-weighted metering).....	100, 166
 (Spot metering).....	100, 167
 * (Highlight-weighted metering).....	100, 167
 (Help).....	62
 button.....	68, 69, 474
 AE-L/AF-L button.....	82
  (WB) button.....	86
 button.....	94
 (QUAL) button.....	95, 376
  button.....	99, 282, 376
 (Z) button.....	101, 103
 button.....	63, 361
 menu.....	63, 347
 (Memory buffer).....	181
 switch.....	642

Numerics

1 : 1 (24 × 24).....	130
16 : 9 (36 × 20).....	130
3D-tracking.....	79, 146
3D-tracking face-detection.....	592

A

AC adapter.....	808, 814
Access-point mode.....	431, 433
Active D-Lighting.....	254
ADL bracketing.....	238

ADL bracketing (Auto bracketing set).....	238
AE & flash bracketing.....	226
AE bracketing.....	226
AE lock.....	83, 173
AE-L indicator.....	84, 173
AF activation.....	597
AF fine-tuning options.....	663
AF mode auto-switch.....	77, 140, 142
AF speed.....	650
AF tracking sensitivity.....	652
AF-A.....	77, 140, 142
AF-area mode.....	78, 145
AF-C.....	77, 140, 142
AF-C priority selection.....	590
AF-F.....	77, 143
AF-mode button.....	76, 144, 154
AF-ON button.....	82
AF-S.....	77, 140, 142
AF-S priority selection.....	591
After delete.....	539
Airplane mode.....	691
All (Delete).....	388
Angle of view.....	789
Aperture.....	111, 113, 638
Aperture-priority auto.....	111
Assign remote (WR) Fn button.....	691
Attaching a lens.....	25
Attenuator.....	582
Auto (Set Picture Control).....	243
Auto (White balance).....	88, 195
Auto bracketing.....	104, 224, 567
Auto bracketing set.....	224
Auto  ISO Sensitivity Control.....	621
Auto distortion control.....	560
Auto DX crop.....	133
Auto ISO sensitivity control.....	93, 190
Auto send.....	449
Auto-area AF.....	79, 81, 147, 151

Auto-area AF face/eye detection.....	593
Autofocus mode.....	77, 140

B

Backup (Role played by card in Slot 2).....	279
Battery.....	22, 24
Battery charger.....	22
Battery info.....	701
Beep options.....	684
BKT button.....	104, 226, 232, 238, 295
Black-and-white (Monochrome).....	733
Bluetooth.....	415
Bracketing.....	226, 232, 238
Bracketing order.....	622
Brightness.....	247
Bulb.....	170
Bulb photography.....	170

C

Calendar playback.....	355
Center-weighted.....	166
Center-weighted area.....	603
Center-weighted metering.....	100, 166
Charging AC adapter.....	816
Choose color temp. (White balance).....	89, 197
Choose image area.....	551
Choose start/end point.....	271
CL mode shooting speed.....	607
Clarity.....	247
Clean image sensor.....	673, 823
Cloudy (White balance).....	88, 196
Color space.....	554

Color temperature.....	204, 206
Compatible lenses.....	786
Conformity marking.....	700
Connect to PC.....	696
Connect to smart device.....	409, 416, 422, 429, 692
Continuous AF.....	77, 140, 142
Continuous high speed.....	74, 179
Continuous low speed.....	73, 179
Continuous release mode.....	178
Contrast.....	247
Copy image(s).....	532
Copyright.....	682
CPU lens.....	786, 791
Creative Picture Control.....	244
Custom controls.....	628, 645
Custom Settings.....	586
Customize command dials.....	637
Customize Fn menu.....	347, 623, 626, 643
Cyanotype (Monochrome).....	733

D

Delete.....	56, 383, 530
Depth of field.....	111, 112
Destination.....	572
Detaching lenses.....	26
Diffraction compensation.....	559, 578
Diopter adjustment control.....	11
Direct connection to PC.....	433
Direct sunlight (White balance).....	88, 196
Distortion control.....	730
D-Lighting.....	726
DX (24 × 16).....	130, 133
DX format.....	130
DX-based movie format.....	263
Dynamic-area AF.....	78, 80, 145, 151

E

Easy connect.....	440
Easy exposure compensation.....	602
Edit movie.....	271, 277
Effect level.....	247
Electronic front-curtain shutter.....	609
Electronic rangefinder.....	164
Electronic VR.....	580
Encryption key.....	433, 442
EV steps for exposure cntrl.....	601
Exposure comp. for flash.....	620
Exposure compensation.....	94, 175
Exposure delay mode.....	608
Exposure indicator.....	114
Exposure preview (Lv).....	614
Extended shutter speeds (M).....	610
External microphone.....	49, 812
Eye-detection AF.....	155

F

Face detection.....	155
File information.....	367
File naming.....	550, 572
File number sequence.....	611
Fill flash.....	102, 465
Filter effects.....	247
Fine-tune optimal exposure.....	604
Firmware version.....	708
Flash.....	460
Flash (White balance).....	89, 197
Flash bracketing.....	226
Flash compensation.....	469
Flash control.....	463, 563
Flash info.....	474, 507
Flash mode.....	101, 465
Flash off.....	102, 467
Flash shutter speed.....	620

Flash sync speed.....	618	HDMI.....	396
Flash-ready indicator.....	849	HDR (high dynamic range).....	256
Flat (Set Picture Control).....	244	Headphone volume.....	583
Flexible program.....	109	Hi (Sensitivity).....	189
Flicker reduction.....	561, 579	High Dynamic Range (HDR).....	256
Fluorescent (White balance).....	89, 196	High ISO NR.....	557, 578
Fn button.....	106	High key (Special effect).....	120
Focal plane mark.....	165	Highlight display.....	368, 653
Focus lock.....	83	Highlight-weighted metering.....	100, 167
Focus mode.....	139, 162	Histogram.....	69, 70
Focus point.....	145, 159	Hue.....	247
Focus point options.....	598		
Focus point wrap-around.....	597		
Focus points used.....	594		
Focus ring.....	162, 875		
Focus shift shooting.....	328		
Focus tracking with lock-on.....	592		
Focus-mode selector.....	139, 162		
Format memory card.....	656		
Frame rate.....	264		
Frame size/frame rate.....	264		
Framing grid display.....	615		
Frequency response.....	582		
FTP server.....	454		
Full-frame playback.....	353		
Full-time AF.....	77, 143		
FV lock.....	471		
FX (36 × 24).....	130		
FX format.....	130		
FX-based movie format.....	263		

G

Group-area AF.....	79, 146
--------------------	---------

H

H.264.....	850
------------	-----

I

Image area.....	129, 262
Image comment.....	681
Image Dust Off ref photo.....	675
Image overlay.....	734
Image quality.....	95, 134
Image review.....	357, 538
Image size.....	97, 137
Incandescent (White balance).....	88, 196
Information display.....	662
Infrastructure mode.....	432, 439
Interval timer shooting.....	569
IP address.....	443
ISO (FORMAT) button.....	91, 93, 656
ISO sensitivity.....	91, 187, 190
ISO sensitivity settings.....	553, 575

L

L (large).....	97, 137
L (Preset manual).....	209
Landscape (Set Picture Control).....	244
Language.....	657

LCD illumination	616	Monitor brightness.....	658
Live view in continuous mode	616	Monitor color balance	659
Live view selector	40, 45	Monitor off delay	606
Lo (Sensitivity)	189	Monochrome.....	733
Location data.....	373, 687	Monochrome (Set Picture Control)	244
Lock mirror up for cleaning.....	827	Movie file type.....	574
Long exposure NR.....	556	Movie quality.....	264, 574
Long time-exposures	170	Movie shooting menu	571
Low key (Special effect).....	120	Movies.....	45, 53, 271
Low-light AF	599	Multiple exposure.....	569
Low-pass filter	823	My Menu	744

M

M (Manual focus)	162
M (medium)	97, 137
MAC address.....	699
Manage Picture Control.....	250
Manual (Shooting mode)	113
Manual focus	162
Manual focus ring in AF mode	600
Matrix metering	100, 166, 603
Max. continuous release.....	607
Maximum aperture.....	349, 788
Maximum sensitivity.....	191
Memory card capacity.....	861
MENU button.....	57
Metering.....	99, 166
Microphone sensitivity	581
Mid-range sharpening	247
Miniature effect (Special effect).....	120, 124
Minimum aperture.....	108
Minimum shutter speed.....	192
Mired.....	203
Mirror up mode.....	74, 180, 185
Mode dial.....	36, 71
Mode dial lock release.....	72
Modeling flash	621

N

Natural light auto (White balance)	88, 196
NEF (RAW) processing.....	713
NEF (RAW) recording	552
Negative digitizer.....	343
Network settings.....	433, 439, 696
Neutral (Set Picture Control)	243
Night vision (Special effect)	119
Non-CPU lens	349, 792, 795
Non-CPU lens data.....	349, 351, 672

O

OK button.....	635
Optical VR.....	617
Overflow (Role played by card in Slot 2).....	279
Overview data.....	374

P

Pairing.....	692
Peaking highlights	615
Perspective control.....	732

Photo illustration (Special effect) ...	
119, 122	
Photo information	366, 371
Photo shooting menu	544
Picture Controls	243
Picture size	789
PIN-entry WPS	440
Pinpoint AF	80, 150
Pitching	661
Pixel mapping	679
Playback	51, 53, 353
Playback display options	531
Playback folder	530
Playback menu	529
Playback zoom	376
Pop (Special effect)	119
Portrait (Set Picture Control)	244
Power connector	808, 814
Predictive focus tracking	141
Preset manual (White balance) .89,	
197, 209	
Press the shutter-release button all	
the way down	38
Programmed auto	109
Protect	378
Push-button WPS	440
Pv button	105, 112

Q

Quick crop	362, 377
Quick retouch	727
Quick sharp	247
Quiet continuous shutter-release ..	
74, 180	
Quiet shutter-release	74, 180

R

Rating	380, 543
RAW Slot 1 - JPEG Slot 2 (Role	
played by card in Slot 2)	279
Rear-curtain sync	102, 467
Recent settings	744, 750
Red-eye correction	728
Red-eye reduction	102, 465
Release button to use dial	641
Release mode	73, 178
Release mode dial	73
Release mode dial lock release ..	73
Remote flash photography	477
Remote photography	404
Reset	282
Reset all settings	708
Reset custom settings	590
Reset movie shooting menu	572
Reset photo shooting menu	545
Reset user settings	118
Resize	720
Retouch menu	709
Reverse indicators	642
RGB histogram	369
Role played by card in Slot 2	279
Rotate tall	540

S

S (small)	97, 137
Saturation	247
Save original (EFFECTS)	613
Save user settings	115
Save/load menu settings	703
SD memory card	27, 860
Search for Wi-Fi network	440
Select date (Delete)	387
Select to send (Bluetooth)	693

Select to send/deselect.....	381
Select to send/deselect (PC).....	448
Selected (Delete).....	386
Selective color (Special effect).....	120, 126
Self-timer.....	183, 606
Send while off.....	695
Sepia (Monochrome).....	733
Setup menu.....	654
Shade (White balance).....	88, 196
Sharpening.....	247
Shutter speed.....	110, 113
Shutter-priority auto.....	110
Shutter-release button AE-L.....	605
Silent live view photography.....	340
Silhouette (Special effect).....	120
Single AF.....	77, 140, 142
Single frame.....	178
Single-point AF.....	78, 80, 145, 150
Slide show.....	540
Slot empty release lock.....	702
Slow sync.....	102, 466
Slow-motion movie.....	266
SnapBridge.....	403
Specifying the focal length.....	349
Spot metering.....	100, 167
Spot white balance.....	216
SSID.....	433, 441
Standard (Set Picture Control).....	243
Standby timer.....	39, 605
Storage folder.....	545
Store points by orientation.....	595
Straighten.....	729
Subject tracking AF.....	158
Super vivid (Special effect).....	119
Sync. release mode options.....	608

T

Thumbnail playback.....	354
Time photography.....	170
Time zone and date.....	658
Timecode.....	584
Time-lapse movie.....	315
Timer.....	183
Toning.....	247
Touch controls.....	358, 686
Touch screen.....	14
Toy camera effect (Special effect).....	120, 123
Trim.....	719
Trimming movies.....	743
Two-button reset.....	282
Type D lens.....	791
Type E lens.....	791
Type G lens.....	791

U

USB cable.....	ii
User settings.....	115

V

Viewfinder eyepiece cap.....	10
Viewfinder mask display.....	133
Vignette Control.....	558
Virtual horizon.....	69, 70, 661
Vivid (Set Picture Control).....	243

W

WB bracketing.....	232
White balance.....	86, 195
Wide-area AF (L).....	80, 150
Wide-area AF (S).....	80, 150

Wi-Fi connection	625, 694, 696
Wi-Fi mode	406
Wind noise reduction	583
Wireless remote (WR) options..	688
Wireless transmitter	430
Wireless transmitter (WT-7)	700
Wireless Transmitter Utility	430
WR-R10	479, 688
WT-7	453, 810

No reproduction in any form of this manual, in whole or in part (except for brief quotation in critical articles or reviews), may be made without written authorization from NIKON CORPORATION.

NIKON CORPORATION

© 2020 Nikon Corporation



SB2F05(11)
6MB45911-05