

Nikon

DIGITAL CAMERA















D7000

User's Manual

En

Where to Find It

Find what you're looking for from:

	The Table of Contents		 iv–xi
Find items by function or menu name.			
	The Q&A Index		 ii–iii
Know what you want to do but don't know the function name? Find it from the "question and answer" index.			
	The Index		 322–325
Search by key word.			
	Error Messages		 305–308
If the camera displays a warning, find the solution here.			
	Troubleshooting		 299–304
Camera behaving unexpectedly? Find the solution here.			

For Your Safety

Before using the camera for the first time, read the safety instructions in "For Your Safety" ( xii–xvii).









































Help

Use the camera's on-board help feature for help on menu items and other topics. See page 18 for details.

Digitutor

"Digitutor", a series of "watch and learn" manuals in movie form, is available from the following website: http://www.nikondigitutor.com/index_eng.html

D7000

Q&A Index	 ii
Table of Contents	 iv
 Introduction	 1
 Basic Photography and Playback	 35
 Live View	 49
 Recording and Viewing Movies	 57
 P, S, A, and M Modes	 67
 User Settings: U1 and U2 Modes	 75
 Release Mode	 77
 Image Recording Options	 85
 Focus	 91
 ISO Sensitivity	 101
 Exposure/Bracketing	 105
 White Balance	 117
 Image Enhancement	 131
 Flash Photography	 143
 Other Shooting Options	 151
 More on Playback	 163
 Connections	 179
 Menu Guide	 195
 Technical Notes	 269

Q&A Index

Find what you're looking for using this "question and answer" index.



Taking Photographs



Shooting Modes and Framing Options

Is there a quick and easy way to take snapshots (mode Q)?	35–39
How do I quickly adjust settings for different scenes?	40–45
Can I choose a shutter speed (mode S)?	69
Can I choose an aperture (mode A)?	70
How do I make long ("time") exposures (mode M)?	73
Can I frame photos in the monitor?	49–55
Can I shoot movies?	57–61



Release Modes

Can I take photos one at a time or in quick succession?	7, 77
How do I take pictures with the self-timer or a remote control?	80
Can I reduce shutter noise in quiet surroundings?	7, 77



Focus

Can I choose how the camera focuses?	91–95
Can I choose the focus point?	96



Image Quality and Size

How do I take pictures for printing at large sizes?	85–88
How can I get more pictures on the memory card?	



Exposure

Can I make photos brighter or darker?	107
How do I preserve details in shadows and highlights?	139



Using the Flash

Can I set the flash to fire automatically when needed?	143–145
How do I keep the flash from firing?	
How do I avoid "red-eye"?	



Viewing Photographs



Playback

How do I view photographs on the camera?	46, 163
How do I view more information about a photo?	165–170
Can I view photos in an automatic slide show?	201
Can I view photos on a TV?	191–194
Can I protect photos from accidental deletion?	174



Deletion

How do I delete unwanted photos?	47, 175–177
----------------------------------	-------------



Retouching Photographs



How do I create retouched copies of photos?	248–264
How do I remove “red-eye”?	251
How do I make JPEG copies of RAW (NEF) photos?	258
Can I overlay two NEF (RAW) photos to make a single image?	256–257
Can I create a copy of a photo that looks like a painting?	262
Can I trim movie footage on the camera?	63–66



Menus and Settings



How do I use the menus?	18–20
How do I display menus in another language?	27, 238
How do I use the command dials?	13–16
How do I keep the displays from turning off?	215
How do I focus the viewfinder?	34
Can I display a framing grid in the viewfinder or the monitor?	53, 216
How do I tell if the camera is level?	245
How do I set the camera clock?	27, 237
How do I format memory cards?	32, 236
How do I restore default settings?	151, 202, 207
How do I get help for a menu or message?	18, 305



Connections



How do I copy photos to a computer?	179–181
How do I print photos?	182–190
Can I print the date of recording on my photos?	184, 190



Maintenance and Optional Accessories



What memory cards can I use?	319
What lenses can I use?	269
What optional flash units (Speedlights) can I use?	275
What other accessories are available for my camera?	280–281
What software is available for my camera?	
What do I do with the supplied eyepiece cap?	81
How do I clean the camera?	
Where should I take my camera for servicing and repairs?	283

Table of Contents

Q&A Index	ii
For Your Safety	xii
Notices.....	xiv

Introduction **1**

Overview	1
Getting to Know the Camera.....	2
The Camera Body	2
The Mode Dial.....	6
The Release-Mode Dial	7
The Control Panel	8
The Viewfinder.....	9
The Information Display.....	10
The Command Dials	13
The BM-11 Monitor Cover	17
Camera Menus.....	18
Using Camera Menus	19
First Steps	21
Charge the Battery	21
Insert the Battery	24
Attach a Lens.....	25
Basic Setup.....	27
Insert a Memory Card.....	29
Format the Memory Card	32
Adjust Viewfinder Focus	34

Basic Photography and Playback **35**

“Point-and-Shoot” Photography (📷 and 📷 Modes).....	35
Step 1: Turn the Camera On.....	35
Step 2: Select 📷 or 📷 Mode	36
Step 3: Frame the Photograph	37
Step 4: Focus	38
Step 5: Shoot	38

Creative Photography (Scene Modes)	40
Portrait.....	41
Landscape	41
Child.....	41
Sports.....	41
Close Up.....	42
Night Portrait	42
Night Landscape.....	42
Party/Indoor	42
Beach/Snow	43
Sunset.....	43
Dusk/Dawn.....	43
Pet Portrait.....	43
Candlelight.....	44
Blossom.....	44
Autumn Colors	44
Food.....	44
Silhouette.....	45
High Key.....	45
Low Key.....	45
Basic Playback.....	46
Deleting Unwanted Photographs.....	47

Live View **49**

Framing Photographs in the Monitor	49
--	----

Recording and Viewing Movies **57**

Recording Movies	57
Viewing Movies	62
Editing Movies	63
Trimming Movies.....	63
Saving Selected Frames.....	66

P, S, A, and M Modes **67**

Mode P (Programmed Auto)	68
Mode S (Shutter-Priority Auto)	69
Mode A (Aperture-Priority Auto).....	70
Mode M (Manual).....	71
Long Time-Exposures (M Mode Only)	73

User Settings: U1 and U2 Modes **75**

Saving User Settings.....	75
Recalling User Settings.....	76
Resetting User Settings.....	76

Release Mode **77**

Choosing a Release Mode	77
Continuous Mode (C \bar{H} /C \bar{L}).....	78
Self-Timer and Remote Modes	80
Mirror up Mode	83

Image Recording Options **85**

Image Quality and Size	85
Image Quality.....	85
Image Size	88
Using Two Memory Cards	89

Focus **91**

Autofocus	91
Autofocus Mode	91
AF-Area Mode	94
Focus Point Selection.....	96
Focus Lock.....	97
Manual Focus	99

ISO Sensitivity **101**

Auto ISO Sensitivity Control	103
------------------------------------	-----

Exposure/Bracketing **105**

Metering	105
Autoexposure Lock.....	106
Exposure Compensation.....	107
Bracketing	109

White Balance **117**

Fine-Tuning White Balance	119
Choosing a Color Temperature	122
Preset Manual	123

Image Enhancement **131**

Picture Controls	131
Selecting a Picture Control	131
Modifying Picture Controls	133
Creating Custom Picture Controls	136
Sharing Custom Picture Controls	138
Active D-Lighting	139
Color Space	141

Flash Photography **143**

Using the Built-in Flash	143
Flash Mode	144
Flash Compensation	148
FV Lock	149

Other Shooting Options **151**



Restoring Default Settings	151
Multiple Exposure	152
Interval Timer Photography	155
Non-CPU Lenses	159
The GP-1 GPS Unit	162





More on Playback **163**

Full-Frame Playback	163
Photo Information	165
Thumbnail Playback	171
Calendar Playback	172
Taking a Closer Look: Playback Zoom	173
Protecting Photographs from Deletion	174
Deleting Photographs	175
Full-Frame, Thumbnail, and Calendar Playback	175
The Playback Menu	176

Connecting to a Computer	179
Before Connecting the Camera	179
Connecting the Camera	180
Wireless and Ethernet Networks	181
Printing Photographs	182
Connecting the Printer	182
Printing Pictures One at a Time	183
Printing Multiple Pictures	185
Creating Index Prints	188
Creating a DPOF Print Order: Print Set	189
Viewing Photographs on TV	191
Standard Definition Devices	191
High-Definition Devices	193

▶ The Playback Menu: <i>Managing Images</i>	195
Playback Folder	195
Hide Image	196
Display Mode	197
Copy Image(s)	197
Image Review	200
After Delete	200
Rotate Tall	200
Slide Show	201
📷 The Shooting Menu: <i>Shooting Options</i>	202
Reset Shooting Menu	202
Storage Folder	203
File Naming	204
Auto Distortion Control	205
Long Exp. NR (Long Exposure Noise Reduction)	205
High ISO NR	205
✎ Custom Settings: <i>Fine-Tuning Camera Settings</i>	206
🔧: Reset Custom Settings	207
a: Autofocus	208
a1: AF-C Priority Selection	208
a2: AF-S Priority Selection	208
a3: Focus Tracking with Lock-On	209
a4: AF Point Illumination	209
a5: Focus Point Wrap-Around	209
a6: Number of Focus Points	210
a7: Built-in AF-assist Illuminator	210
a8: Live View/Movie AF	211

b: Metering/Exposure.....	211
b1: ISO Sensitivity Step Value	211
b2: EV Steps for Exposure Cntrl	211
b3: Easy Exposure Compensation	212
b4: Center-Weighted Area	213
b5: Fine Tune Optimal Exposure.....	213
c: Timers/AE Lock.....	213
c1: Shutter-Release Button AE-L	213
c2: Auto Meter-off Delay	214
c3: Self-Timer.....	214
c4: Monitor off Delay.....	215
c5: Remote on Duration	215
d: Shooting/Display.....	215
d1: Beep	215
d2: Viewfinder Grid Display	216
d3: ISO Display and Adjustment	216
d4: Viewfinder Warning Display.....	216
d5: Screen Tips.....	216
d6: CL Mode Shooting Speed	217
d7: Max. Continuous Release	217
d8: File Number Sequence.....	218
d9: Information Display.....	219
d10: LCD Illumination	219
d11: Exposure Delay Mode	219
d12: Flash Warning	219
d13: MB-D11 Battery Type	220
d14: Battery Order.....	221
e: Bracketing/Flash	222
e1: Flash Sync Speed	222
e2: Flash Shutter Speed.....	223
e3: Flash Cntrl for Built-in Flash	223
e4: Modeling Flash.....	228
e5: Auto Bracketing Set.....	229
e6: Bracketing Order.....	229
f: Controls.....	229
f1:  Switch.....	229
f2: OK Button (Shooting Mode)	229
f3: Assign Fn Button	230
f4: Assign Preview Button.....	232
f5: Assign AE-L/AF-L Button.....	232
f6: Customize Command Dials	233
f7: Release Button to Use Dial	234
f8: Slot Empty Release Lock	234
f9: Reverse Indicators	234
f10: Assign MB-D11  Button.....	235

 The Setup Menu: <i>Camera Setup</i>	236
Format Memory Card	236
LCD Brightness	237
Video Mode	237
Flicker Reduction	237
Time Zone and Date	237
Language	238
Image Comment	238
Auto Image Rotation	239
Image Dust Off Ref Photo	240
Battery Info	242
Copyright Information	243
Save/Load Settings	244
Virtual Horizon	245
AF Fine Tune	246
Eye-Fi Upload	247
Firmware Version	247
 The Retouch Menu: <i>Creating Retouched Copies</i>	248
Creating Retouched Copies	249
D-Lighting	251
Red-Eye Correction	251
Trim	252
Monochrome	253
Filter Effects	254
Color Balance	255
Image Overlay	256
NEF (RAW) Processing	258
Resize	259
Quick Retouch	260
Straighten	261
Distortion Control	261
Fisheye	261
Color Outline	262
Color Sketch	262
Perspective Control	263
Miniature Effect	263
Side-by-side Comparison	264
 My Menu/  Recent Settings	265
Recent Settings	268

- Compatible Lenses..... 269
- Optional Flash Units (Speedlights) 275
 - The Nikon Creative Lighting System (CLS) 276
- Other Accessories 280
 - Attaching a Power Connector and AC Adapter 282
- Caring for the Camera 283
 - Storage..... 283
 - Cleaning 283
 - The Low-Pass Filter 284
 - “Clean Now” 284
 - “Clean at Startup/Shutdown” 285
 - “Manual Cleaning” 286
- Caring for the Camera and Battery: Cautions 289
- Available Settings 292
- Defaults 295
- Exposure Program (Mode **P**)..... 298
- Troubleshooting 299
 - Display 299
 - Shooting (All Modes) 300
 - Shooting (**P, S, A, M**)..... 302
 - Playback 303
 - Miscellaneous..... 304
- Error Messages..... 305
- Specifications 309
- Approved Memory Cards..... 319
- Memory Card Capacity 320
- Battery Life 321
- Index..... 322

For Your Safety

To prevent damage to your Nikon product or injury to yourself or to others, read the following safety precautions in their entirety before using this equipment. Keep these safety instructions where all those who use the product will read them.

The consequences that could result from failure to observe the precautions listed in this section are indicated by the following symbol:



This icon marks warnings. To prevent possible injury, read all warnings before using this Nikon product.

■ ■ WARNINGS

Keep the sun out of the frame

Keep the sun well out of the frame when shooting backlit subjects. Sunlight focused into the camera when the sun is in or close to the frame could cause a fire.

Do not look at the sun through the viewfinder

Viewing the sun or other strong light source through the viewfinder could cause permanent visual impairment.

Using the viewfinder diopter adjustment control

When operating the viewfinder diopter adjustment control with your eye to the viewfinder, care should be taken not to put your finger in your eye accidentally.

Turn off immediately in the event of malfunction

Should you notice smoke or an unusual smell coming from the equipment or AC adapter (available separately), unplug the AC adapter and remove the battery immediately, taking care to avoid burns. Continued operation could result in injury. After removing the battery, take the equipment to a Nikon-authorized service center for inspection.

Do not use in the presence of flammable gas

Do not use electronic equipment in the presence of flammable gas, as this could result in explosion or fire.

Keep out of reach of children

Failure to observe this precaution could result in injury.

Do not disassemble

Touching the product's internal parts could result in injury. In the event of malfunction, the product should be repaired only by a qualified technician. Should the product break open as the result of a fall or other accident, remove the battery and/or AC adapter and then take the product to a Nikon-authorized service center for inspection.

Do not place the strap around the neck of an infant or child

Placing the camera strap around the neck of an infant or child could result in strangulation.

Observe caution when using the flash

- Using the camera with the flash in close contact with the skin or other objects could cause burns.
- Using the flash close to the subject's eyes could cause temporary visual impairment. Particular care should be observed when photographing infants, when the flash should be no less than one meter (39 in.) from the subject.

Avoid contact with liquid crystal

Should the monitor break, care should be taken to avoid injury due to broken glass and to prevent the liquid crystal from the monitor touching the skin or entering the eyes or mouth.

⚠ Observe proper precautions when handling batteries

Batteries may leak or explode if improperly handled. Observe the following precautions when handling batteries for use in this product:

- Use only batteries approved for use in this equipment.
- Do not short or disassemble the battery.
- Be sure the product is off before replacing the battery. If you are using an AC adapter, be sure it is unplugged.
- Do not attempt to insert the battery upside down or backwards.
- Do not expose the battery to flame or to excessive heat.
- Do not immerse in or expose to water.
- Replace the terminal cover when transporting the battery. Do not transport or store the battery with metal objects such as necklaces or hairpins.
- Batteries are prone to leakage when fully discharged. To avoid damage to the product, be sure to remove the battery when no charge remains.
- When the battery is not in use, attach the terminal cover and store in a cool, dry place.
- The battery may be hot immediately after use or when the product has been used on battery power for an extended period. Before removing the battery turn the camera off and allow the battery to cool.
- Discontinue use immediately should you notice any changes in the battery, such as discoloration or deformation.

⚠ Observe proper precautions when handling the charger

- Keep dry. Failure to observe this precaution could result in fire or electric shock.
- Do not short the charger terminals. Failure to observe this precaution could result in overheating and damage to the charger.
- Dust on or near the metal parts of the plug should be removed with a dry cloth. Continued use could result in fire.
- Do not handle the power cable or go near the charger during thunderstorms. Failure to observe this precaution could result in electric shock.
- Do not damage, modify, or forcibly tug or bend the power cable. Do not place it under heavy objects or expose it to heat or flame. Should the insulation be damaged and the wires become exposed, take the power cable to a Nikon-authorized service representative for inspection. Failure to observe this precaution could result in fire or electric shock.
- Do not handle the plug or charger with wet hands. Failure to observe this precaution could result in electric shock.
- Do not use with travel converters or adapters designed to convert from one voltage to another or with DC-to-AC inverters. Failure to observe this precaution could damage the product or cause overheating or fire.

⚠ Use appropriate cables

When connecting cables to the input and output jacks, use only the cables provided or sold by Nikon for the purpose to maintain compliance with product regulations.

⚠ CD-ROMs

CD-ROMs containing software or manuals should not be played back on audio CD equipment. Playing CD-ROMs on an audio CD player could cause hearing loss or damage the equipment.

Notices

- No part of the manuals included with this product may be reproduced, transmitted, transcribed, stored in a retrieval system, or translated into any language in any form, by any means, without Nikon's prior written permission.
- Nikon reserves the right to change the specifications of the hardware and software described in these manuals at any time and without prior notice.
- Nikon will not be held liable for any damages resulting from the use of this product.
- While every effort has been made to ensure that the information in these manuals is accurate and complete, we would appreciate it were you to bring any errors or omissions to the attention of the Nikon representative in your area (address provided separately).

Notices for Customers in Canada

CAUTION

This Class B digital apparatus complies with Canadian ICES-003.

ATTENTION

Cet appareil numérique de la classe B est conforme à la norme NMB-003 du Canada.

Notices for Customers in Europe

CAUTION

RISK OF EXPLOSION IF BATTERY IS REPLACED BY AN INCORRECT TYPE. DISPOSE OF USED BATTERIES ACCORDING TO THE INSTRUCTIONS.

This symbol indicates that this product is to be collected separately.



This symbol on the battery indicates that the battery is to be collected separately.



The following apply only to users in  European countries:

- This product is designated for separate collection at an appropriate collection point. Do not dispose of as household waste.
- For more information, contact the retailer or the local authorities in charge of waste management.

The following apply only to users in European countries:

- All batteries, whether marked with this symbol or not, are designated for separate collection at an appropriate collection point. Do not dispose of as household waste.
- For more information, contact the retailer or the local authorities in charge of waste management.

Notices for Customers in the U.S.A.

Power Cable

At voltages over AC 125 V (U.S.A. only): The power cable must be rated for the voltage in use, be at least AWG no. 18 gauge, and have SVG insulation or better with a NEMA 6P-15 plug rated for AC 250 V 15 A.

Federal Communications Commission (FCC) Radio Frequency Interference Statement

This equipment has been tested and found to comply with the limits for a Class B digital device, pursuant to Part 15 of the FCC rules. These limits are designed to provide reasonable protection against harmful interference in a residential installation. This equipment generates, uses, and can radiate radio frequency energy and, if not installed and used in accordance with the instructions, may cause harmful interference to radio communications. However, there is no guarantee that interference will not occur in a particular installation. If this equipment does cause harmful interference to radio or television reception, which can be determined by turning the equipment off and on, the user is encouraged to try to correct the interference by one or more of the following measures:

- Reorient or relocate the receiving antenna.
- Increase the separation between the equipment and receiver.
- Connect the equipment into an outlet on a circuit different from that to which the receiver is connected.
- Consult the dealer or an experienced radio/television technician for help.



CAUTIONS

Modifications

The FCC requires the user be notified that any changes or modifications made to this device that are not expressly approved by Nikon Corporation may void the user's authority to operate the equipment.

Interface Cables

Use the interface cables sold or provided by Nikon for your equipment. Using other interface cables may exceed the limits of Class B Part 15 of the FCC rules.

Notice for Customers in the State of California

WARNING: Handling the cord on this product may expose you to lead, a chemical known to the State of California to cause birth defects or other reproductive harm. *Wash hands after handling.*

Nikon Inc., 1300 Walt Whitman Road, Melville, New York 11747-3064, U.S.A.
Tel.: 631-547-4200

Notice Concerning Prohibition of Copying or Reproduction

Note that simply being in possession of material that has been digitally copied or reproduced by means of a scanner, digital camera, or other device may be punishable by law.

- **Items prohibited by law from being copied or reproduced**

Do not copy or reproduce paper money, coins, securities, government bonds, or local government bonds, even if such copies or reproductions are stamped "Sample."

The copying or reproduction of paper money, coins, or securities which are circulated in a foreign country is prohibited.

Unless the prior permission of the government has been obtained, the copying or reproduction of unused postage stamps or post cards issued by the government is prohibited.

The copying or reproduction of stamps issued by the government and of certified documents stipulated by law is prohibited.

- **Cautions on certain copies and reproductions**

The government has issued cautions on copies or reproductions of securities issued by private companies (shares, bills, checks, gift certificates, etc.), commuter passes, or coupon tickets, except when a minimum of necessary copies are to be provided for business use by a company. Also, do not copy or reproduce passports issued by the government, licenses issued by public agencies and private groups, ID cards, and tickets, such as passes and meal coupons.

- **Comply with copyright notices**

The copying or reproduction of copyrighted creative works such as books, music, paintings, woodcuts, prints, maps, drawings, movies, and photographs is governed by national and international copyright laws. Do not use this product for the purpose of making illegal copies or to infringe copyright laws.

Disposing of Data Storage Devices

Please note that deleting images or formatting memory cards or other data storage devices does not completely erase the original image data. Deleted files can sometimes be recovered from discarded storage devices using commercially available software, potentially resulting in the malicious use of personal image data. Ensuring the privacy of such data is the user's responsibility.

Before discarding a data storage device or transferring ownership to another person, erase all data using commercial deletion software, or format the device and then completely refill it with images containing no private information (for example, pictures of empty sky). Be sure to also replace any pictures selected for preset manual (☐ 123). Care should be taken to avoid injury when physically destroying data storage devices.

Use Only Nikon Brand Electronic Accessories

Nikon cameras are designed to the highest standards and include complex electronic circuitry. Only Nikon brand electronic accessories (including chargers, batteries, AC adapters, and flash accessories) certified by Nikon specifically for use with this Nikon digital camera are engineered and proven to operate within the operational and safety requirements of this electronic circuitry.

The use of non-Nikon electronic accessories could damage the camera and may void your Nikon warranty. The use of third-party rechargeable Li-ion batteries not bearing the Nikon holographic seal shown at right could interfere with normal operation of the camera or result in the batteries overheating, igniting, rupturing, or leaking. For more information about Nikon brand accessories, contact a local authorized Nikon dealer.

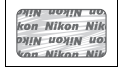

AVC Patent Portfolio License

THIS PRODUCT IS LICENSED UNDER THE AVC PATENT PORTFOLIO LICENSE FOR THE PERSONAL AND NON-COMMERCIAL USE OF A CONSUMER TO (i) ENCODE VIDEO IN COMPLIANCE WITH THE AVC STANDARD ("AVC VIDEO") AND/OR (ii) DECODE AVC VIDEO THAT WAS ENCODED BY A CONSUMER ENGAGED IN A PERSONAL AND NON-COMMERCIAL ACTIVITY AND/OR WAS OBTAINED FROM A VIDEO PROVIDER LICENSED TO PROVIDE AVC VIDEO. NO LICENSE IS GRANTED OR SHALL BE IMPLIED FOR ANY OTHER USE. ADDITIONAL INFORMATION MAY BE OBTAINED FROM MPEG LA, L.L.C. SEE <http://www.mpegla.com>

Before Taking Important Pictures

Before taking pictures on important occasions (such as at weddings or before taking the camera on a trip), take a test shot to ensure that the camera is functioning normally. Nikon will not be held liable for damages or lost profits that may result from product malfunction.

Life-Long Learning

As part of Nikon's "Life-Long Learning" commitment to ongoing product support and education, continually-updated information is available on-line at the following sites:

- **For users in the U.S.A.:** <http://www.nikonusa.com/>
- **For users in Europe and Africa:** <http://www.europe-nikon.com/support/>
- **For users in Asia, Oceania, and the Middle East:** <http://www.nikon-asia.com/>

Visit these sites to keep up-to-date with the latest product information, tips, answers to frequently-asked questions (FAQs), and general advice on digital imaging and photography. Additional information may be available from the Nikon representative in your area. See the following URL for contact information: <http://imaging.nikon.com/>



Introduction

Overview

Thank you for your purchase of a Nikon single-lens reflex (SLR) digital camera. To get the most from your camera, please be sure to read all instructions thoroughly and keep them where they will be read by all who use the product.

■ *Symbols and Conventions*

To make it easier to find the information you need, the following symbols and conventions are used:



This icon marks cautions; information that should be read before use to prevent damage to the camera.



This icon marks notes; information that should be read before using the camera.



This icon marks references to other pages in this manual.



Use Only Nikon Brand Accessories

Only Nikon brand accessories certified by Nikon specifically for use with your Nikon digital camera are engineered and proven to operate within its operational and safety requirements. **THE USE OF NON-NIKON ACCESSORIES COULD DAMAGE YOUR CAMERA AND MAY VOID YOUR NIKON WARRANTY.**



Servicing the Camera and Accessories

The camera is a precision device and requires regular servicing. Nikon recommends that the camera be inspected by the original retailer or a Nikon-authorized service representative once every one to two years, and that it be serviced once every three to five years (note that fees apply to these services). Frequent inspection and servicing are particularly recommended if the camera is used professionally. Any accessories regularly used with the camera, such as lenses or optional flash units, should be included when the camera is inspected or serviced.



Camera Settings

The explanations in this manual assume that default settings are used.



Getting to Know the Camera

Take a few moments to familiarize yourself with camera controls and displays. You may find it helpful to bookmark this section and refer to it as you read through the rest of the manual.

The Camera Body

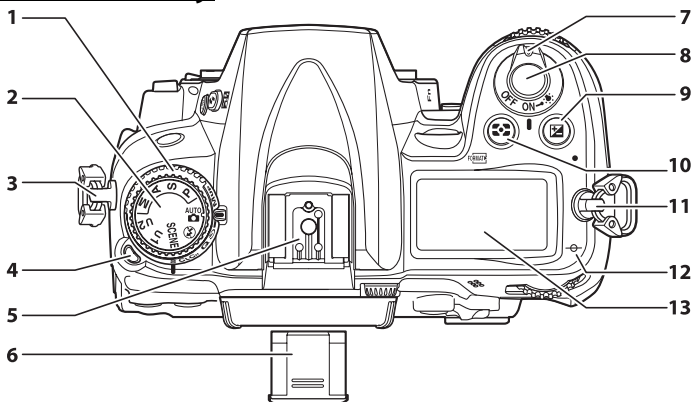

1 Release mode dial.....	7, 77	9 (exposure compensation) button.....	107
2 Mode dial.....	6	10 (metering) button.....	151
3 Eyelet for camera strap		11 (format) button.....	105
4 Release mode dial lock release.....	7, 77	12 Focal plane mark (⊖).....	32
5 Accessory shoe (for optional flash unit).....	275	13 Control panel.....	8
6 Accessory shoe cover.....	275		
7 Power switch.....	2		
8 Shutter-release button.....	38, 39		

The Power Switch

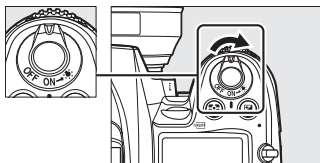

Rotate the power switch as shown to turn the camera on.

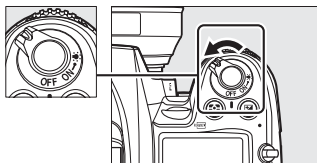

Rotate the power switch as shown to turn the camera off.

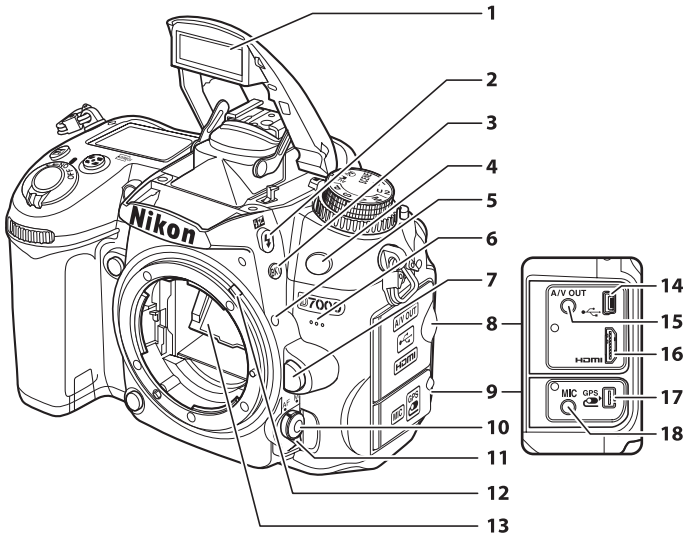



1 Built-in flash	143	10 AF-mode button.....	50, 92, 95
2  (flash mode) button	143	11 Focus-mode selector.....	91, 99
3  (flash compensation) button.....	148	12 Meter coupling lever	310
4 BKT (bracketing) button.....	109, 164	13 Mirror	83, 286
5 Infrared receiver (front).....	81	14 USB connector	
6 Mounting mark	25	Connecting to a computer	180
7 Built-in microphone	58, 60	Connecting to a printer.....	182
8 Lens release button.....	26	15 A/V connector	191
9 Connector cover.....	180, 182, 191, 193	16 HDMI mini-pin connector	193
9 Cover for accessory terminal and external		17 Accessory terminal	162, 281
microphone connectors	57	18 Connector for external microphone.....	57

The Camera Body (Continued)

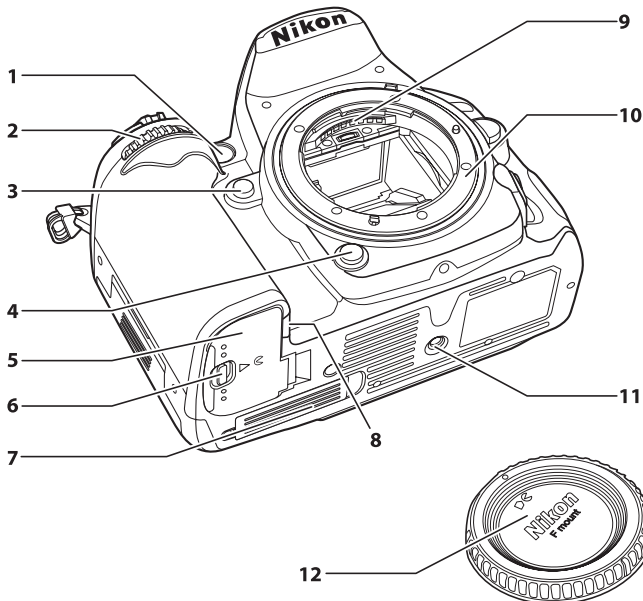

<p>1 AF-assist illuminator..... 210</p> <p>Self-timer lamp.....81</p> <p>Red-eye reduction lamp 145</p> <p>2 Sub-command dial.....13, 233</p> <p>3 Fn button..... 149, 230</p> <p>4 Depth-of-field preview button.....72, 232</p> <p>5 Battery-chamber cover.....24</p> <p>6 Battery-chamber cover latch24</p>	<p>7 Contact cover for optional MB-D11 battery pack280</p> <p>8 Power connector cover282</p> <p>9 CPU contacts</p> <p>10 Lens mount..... 25, 100</p> <p>11 Tripod socket</p> <p>12 Body cap..... 25, 281</p>
--	--

The Microphone and Speaker

Do not place the microphone or speaker in close proximity to magnetic devices. Failure to observe this precaution could affect the data recorded on the magnetic devices.

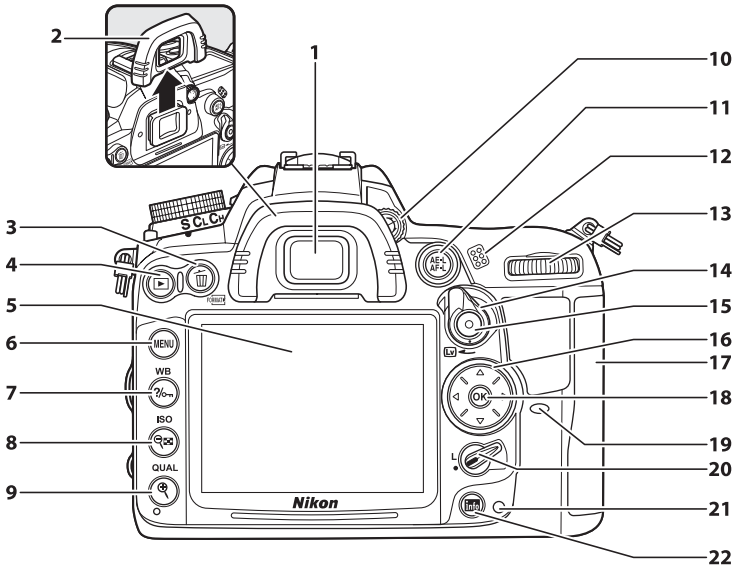

1	Viewfinder eyepiece.....	81	9	⏪ (playback zoom in) button	173
2	Rubber eyecup.....	81	QUAL	(image quality/size) button.....	86, 88
3	⏻ (delete) button			Two-button reset button	151
	Deleting pictures	47	10	Diopter adjustment control.....	34
	Deleting pictures during playback.....	175	11	AE-L/AF-L (AE-L/AF-L) button	97, 106, 232
	FORMAT (format) button	32	12	Speaker	62
4	▶ (playback) button	46, 163	13	Main command dial	13, 233
5	Monitor		14	Live view switch	49, 57
	Viewing settings	10	15	Movie-record button.....	58
	Live view	49, 57	16	Multi selector	19
	Viewing pictures.....	46	17	Memory card slot cover.....	29
	Full-frame playback	163	18	OK (OK) button	19
6	MENU (menu) button	18, 195	19	Infrared receiver (rear)	81
7	?/protect (help/protect) button	18, 174	20	Focus selector lock.....	96
	WB (white balance) button.....	117	21	Memory card access lamp	29, 38
8	⏪ (thumbnail/playback zoom out) button		22	info (info) button	10, 12, 53
	171, 172			
	ISO (ISO sensitivity) button	101			



The Mode Dial

The camera offers a choice of the following modes:

Mode dial

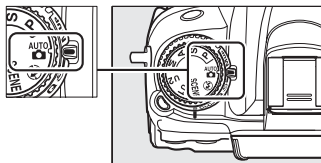

P, S, A, and M Modes

Select these modes for full control over camera settings.

- **P—Programmed auto** (☞ 68)
- **S—Shutter-priority auto** (☞ 69)
- **A—Aperture-priority auto** (☞ 70)
- **M—Manual** (☞ 71)

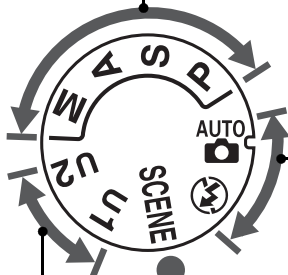

Auto Modes

Select these modes for simple, point-and-shoot photography.

-  **Auto** (☞ 35)
-  **Auto (flash off)** (☞ 35)

Scene Modes (☞ 40)

The camera automatically optimizes settings to suit the selected scene. Match your selection to the scene being photographed.

U1 and U2 Modes (☞ 75)

Store and recall customized shooting settings.

Non-CPU Lenses

Non-CPU (☞ 270) lenses can be used only in modes **A** and **M**. Selecting another mode when a non-CPU lens is attached disables the shutter release.







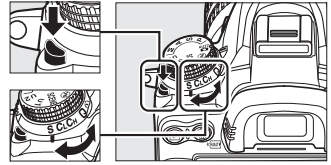

The Release-Mode Dial

To choose a release mode, press the release mode dial lock release and turn the release mode dial to the desired setting (☞ 77).

Release mode dial lock release



Release mode dial

Mode	Description
 S Single frame	One photograph is taken each time the shutter-release button is pressed.
 CL Continuous low speed	The camera takes photographs at about 1 to 5 frames per second while the shutter-release button is pressed.
 CH Continuous high speed	The camera takes photographs at up to 6 frames per second while the shutter-release button is pressed.
 Q Quiet shutter-release	As for single-frame, except that camera noise is reduced.
  Self-timer	Take pictures with the self-timer.
  Remote control	Take pictures with an optional ML-L3 remote control.
 MUP Mirror up	Raise the mirror before taking photographs.



The Control Panel

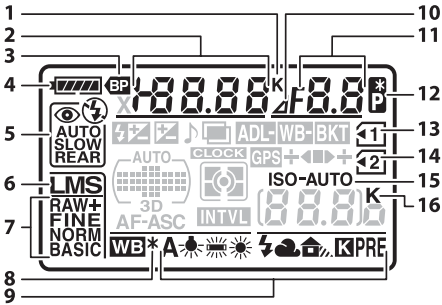

1	Color temperature indicator	122
2	Shutter speed	69, 71
	Exposure compensation value	107
	Flash compensation value	148
	White balance fine-tuning.....	120
	Color temperature	122
	White balance preset number	123, 128
	Number of shots in bracketing sequence	109, 112, 114
	Number of intervals for interval timer photography	156
	Focal length (non-CPU lenses)	159

3	MB-D11 battery indicator	221
4	Battery indicator.....	35
5	Flash mode	144
6	Image size	88
7	Image quality	85
8	White balance fine-tuning indicator	120
9	White balance	117
10	Aperture stop indicator	70, 270
11	Aperture (f-number).....	70, 71
	Aperture (number of stops).....	70, 270
	Bracketing increment.....	110, 112
	Number of shots per interval	156
	Maximum aperture (non-CPU lenses)	159
	PC mode indicator	181
12	Flexible program indicator	68
13	Memory card indicator (Slot 1)	30, 89
14	Memory card indicator (Slot 2)	30, 89
15	ISO sensitivity indicator	101
	Auto ISO sensitivity indicator	104
16	"K" (appears when memory remains for over 1000 exposures)	36

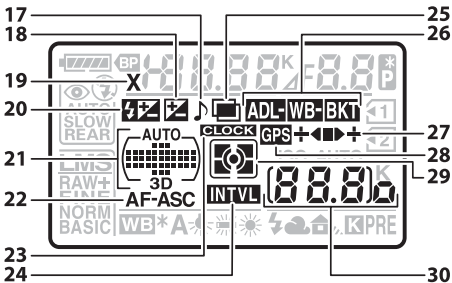

17	"Beep" indicator	215
18	Exposure compensation indicator.....	107
19	Flash sync indicator	222
20	Flash compensation indicator	148
21	Auto-area AF indicator	95
	AF-area mode indicator.....	95
	3D-tracking indicator.....	94
22	Autofocus mode.....	91

23	"Clock not set" indicator.....	28, 237
24	Interval timer indicator	157
25	Multiple exposure indicator	153
26	Exposure and flash bracketing indicator	109
	WB bracketing indicator.....	112
	ADL bracketing indicator	114
27	Bracketing progress indicator	109, 112, 115
28	GPS connection indicator.....	162
29	Metering.....	105
30	Number of exposures remaining	36
	Number of shots remaining before memory buffer fills	38, 79
	Capture mode indicator	181
	ISO sensitivity.....	101
	Preset white balance recording indicator	124
	Active D-Lighting amount	139
	Manual lens number	161
	HDMI-CEC connection indicator.....	194

The Viewfinder

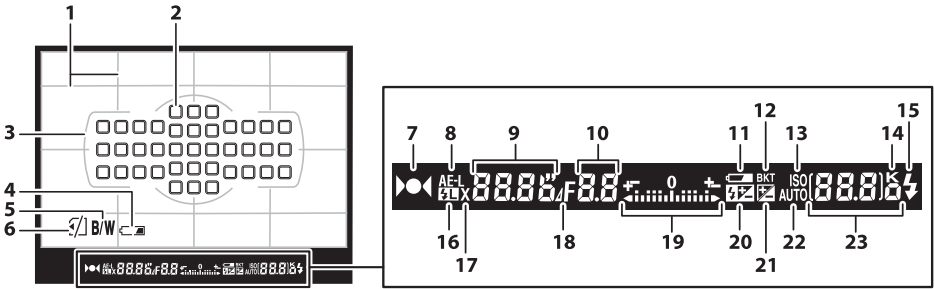

<p>1 Framing grid (displayed when On is selected for Custom Setting d2)216</p> <p>2 Focus points 38, 96 AF-area mode94</p> <p>3 AF area brackets37, 165</p> <p>4 Low battery warning *35, 216</p> <p>5 Black-and-white indicator *216</p> <p>6 “No memory card” indicator *30, 216</p> <p>7 Focus indicator 38, 97, 100</p> <p>8 Autoexposure (AE) lock106</p> <p>9 Shutter speed 69, 71 AF mode91</p> <p>10 Aperture (f-number) 70, 71 Aperture (number of stops)70, 270</p> <p>11 Low battery warning35</p> <p>12 Exposure and flash bracketing indicator109 WB bracketing indicator112 ADL bracketing indicator114</p> <p>13 ISO sensitivity indicator101</p> <p>14 “K” (appears when memory remains for over 1000 exposures)36</p>	<p>15 Flash-ready indicator39, 219</p> <p>16 FV lock indicator 149</p> <p>17 Flash sync indicator222</p> <p>18 Aperture stop indicator70, 270</p> <p>19 Exposure indicator72 Exposure compensation display 107 Tilt indicator 231</p> <p>20 Flash compensation indicator 148</p> <p>21 Exposure compensation indicator 107</p> <p>22 Auto ISO sensitivity indicator 104</p> <p>23 Number of exposures remaining36 Number of shots remaining before memory buffer fills38, 79 ISO sensitivity 101 Preset white balance recording indicator 124 Exposure compensation value 107 Flash compensation value 148 Active D-Lighting amount 139 AF-area mode94</p>
---	---

* Display can be turned off with Custom Setting d4.

No Battery

When the battery is totally exhausted or no battery is inserted, the display in the viewfinder will dim. This is normal and does not indicate a malfunction. The viewfinder display will return to normal when a fully-charged battery is inserted.

The Control Panel and Viewfinder Displays

The brightness of the control panel and viewfinder displays varies with temperature, and the response times of the displays may drop at low temperatures. This is normal and does not indicate a malfunction.



The Information Display

Press the **Info** button to display shutter speed, aperture, the number of exposures remaining, AF-area mode, and other shooting information in the monitor.

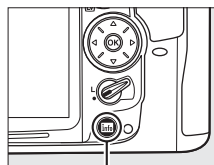

Info button

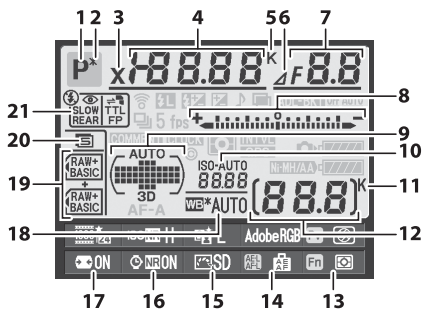

1	Shooting mode.....	6
2	Flexible program indicator	68
3	Flash sync indicator	222
4	Shutter speed	69, 71
	Exposure compensation value	107
	Flash compensation value	148
	Number of shots in bracketing sequence	109, 112, 114
	Focal length (non-CPU lenses)	159
	Color temperature	122
5	Color temperature indicator	122
6	Aperture stop indicator.....	70, 270
7	Aperture (f-number)	70, 71
	Aperture (number of stops)	70, 270
	Bracketing increment	110, 112
	Maximum aperture (non-CPU lenses)	159

8	Exposure indicator	72
	Exposure compensation display.....	107
	Bracketing progress indicator	
	Exposure and flash bracketing	109
	WB bracketing	112
9	Auto-area AF indicator.....	95
	Focus points indicator.....	37, 96
	AF-area mode indicator	95
	3D-tracking indicator	94
10	ISO sensitivity indicator	101
	Auto ISO sensitivity indicator	104
11	"K" (appears when memory remains for over 1000 exposures)	36
12	Number of exposures remaining	36
	Manual lens number	161
13	Fn button assignment	230
14	AE-L/AF-L button assignment	232
15	Picture Control indicator	132
16	Long exposure noise reduction indicator	205
17	Auto distortion control	205
18	White balance	117
	White balance fine-tuning indicator	120
19	Image quality	85
	Role played by card in slot 2.....	89
20	Image size	88
21	Flash mode	144

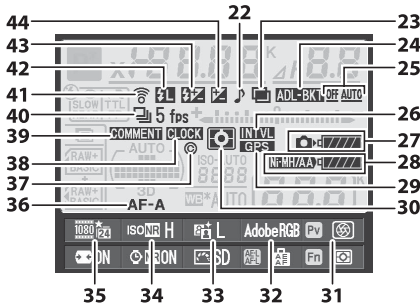

22	"Beep" indicator	215
23	Multiple exposure indicator	153
24	Exposure and flash bracketing indicator	109
	WB bracketing indicator	112
	ADL bracketing indicator	114
25	ADL bracketing amount	114
26	Interval timer indicator	157
27	Camera battery indicator	35

28	MB-D11 battery type display	220
	MB-D11 battery indicator	221
29	GPS connection indicator	162
30	Metering	105
31	Depth-of-field preview button assignment ...	232
32	Color space	141
33	Active D-Lighting indicator	139
34	High ISO noise reduction indicator	205
35	Movie quality	60
36	Autofocus mode	91
37	Copyright information	243
38	"Clock not set" indicator	28, 237
39	Image comment indicator	238
40	Release mode	7, 77
	Continuous shooting speed	78, 217
41	Eye-Fi connection indicator	247
42	FV lock indicator	149
43	Flash compensation indicator	148
44	Exposure compensation indicator	107

Turning the Monitor Off

To clear shooting information from the monitor, press the button twice more or press the shutter-release button halfway. The monitor will turn off automatically if no operations are performed for about 10 seconds.

See Also

For information on choosing how long the monitor stays on, see Custom Setting c4 (**Monitor off delay**, 215). For information on changing the color of the lettering in the information display, see Custom Setting d9 (**Information display**, 219).

■ Changing Settings in the Information Display

To change settings for the items listed below, press the **info** button in the information display. Highlight items using the multi selector and press **OK** to view options for the highlighted item.

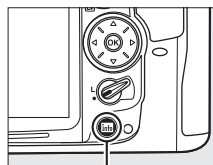

info button

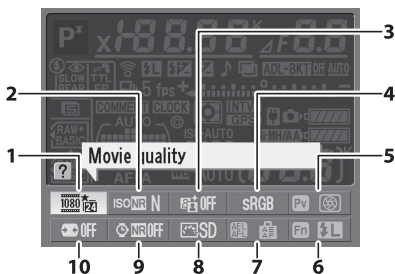

1	Movie quality.....	60
2	High ISO noise reduction	205
3	Active D-Lighting	139
4	Color space	141
5	Depth-of-field preview button assignment ...	232
6	Fn button assignment	230
7	AE-L/AF-L button assignment	232
8	Picture Control	132
9	Long exposure noise reduction	205
10	Auto distortion control	205

Tool Tips

A tool tip giving the name of the selected item appears in the information display. Tool tips can be turned off using Custom Setting d5 (**Screen Tips**;  216).

The Command Dials

The main- and sub-command dials are used alone or in combination with other controls to adjust a variety of settings.

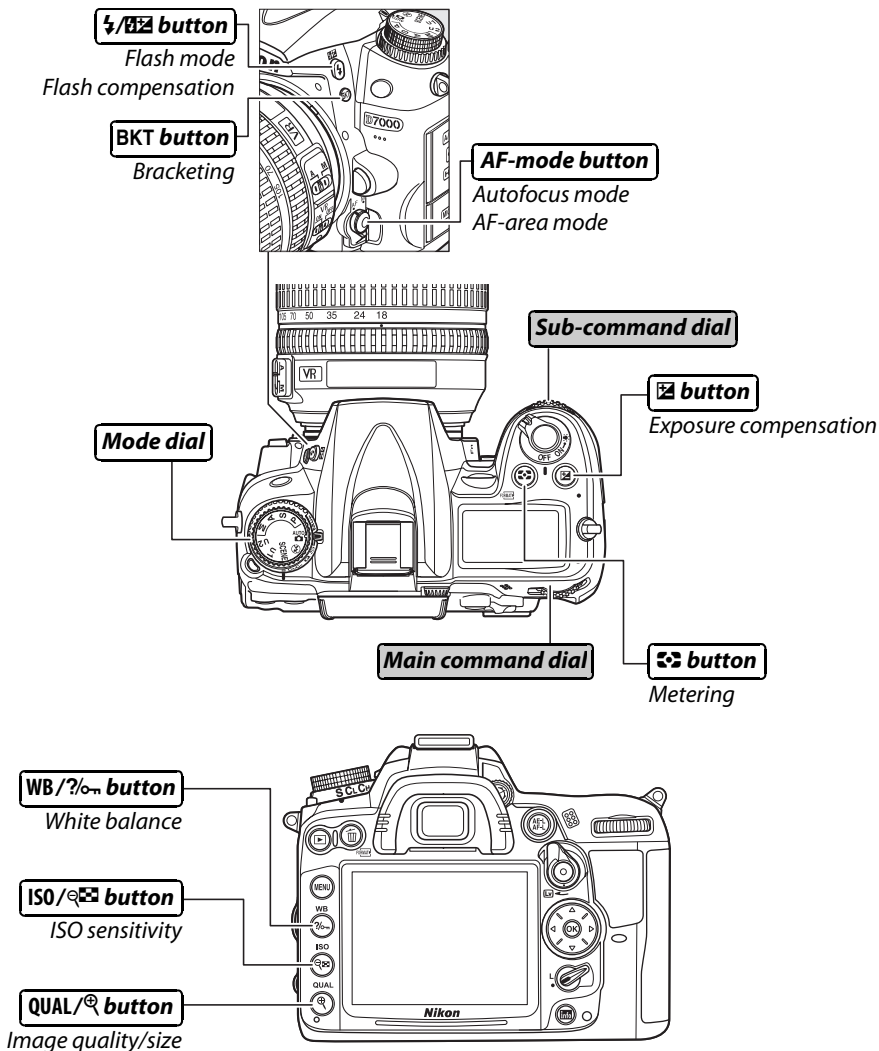

■ Scene Mode

Choose a scene (SCENE; 41).

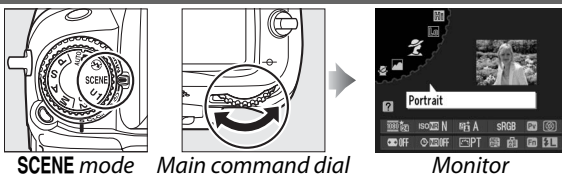

SCENE mode

Main command dial

Monitor

■ Image Quality and Size

Set image quality (86).

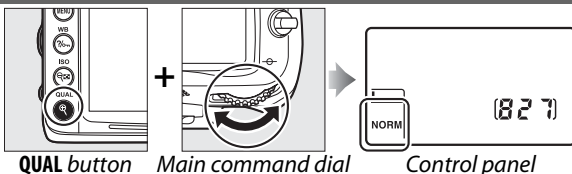

QUAL button

Main command dial

Control panel

Choose an image size (88).

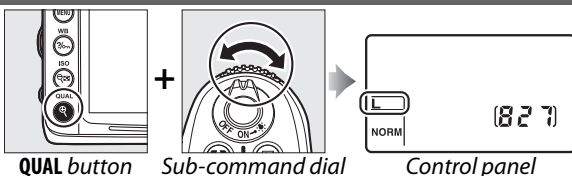

QUAL button

Sub-command dial

Control panel

■ Autofocus

Choose an autofocus mode (92).

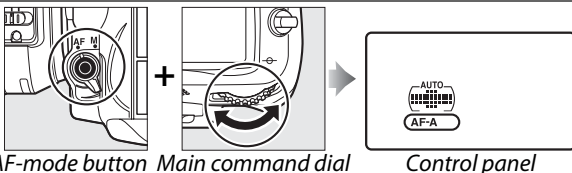

AF-mode button

Main command dial

Control panel

Choose an AF-area mode (95).

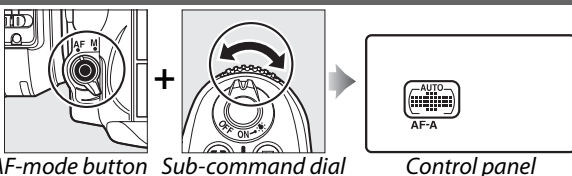

AF-mode button

Sub-command dial

Control panel

■ ISO Sensitivity

Set ISO sensitivity (101).

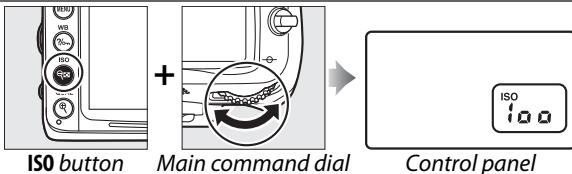

ISO button

Main command dial

Control panel

■ Exposure

Choose a combination of aperture and shutter speed (mode **P**;  68).

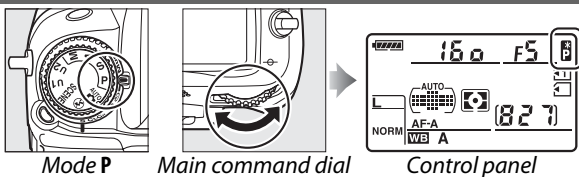

Choose a shutter speed (mode **S** or **M**;  69, 71).

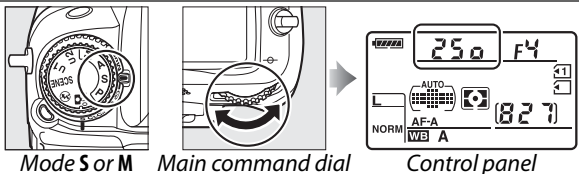

Choose an aperture (mode **A** or **M**;  70, 71).

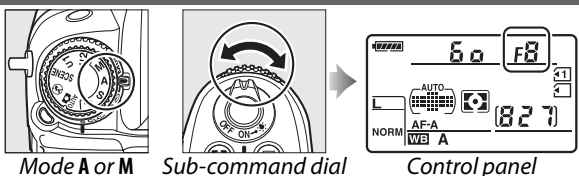

Choose a metering option (mode **P**, **S**, **A**, or **M**;  105).

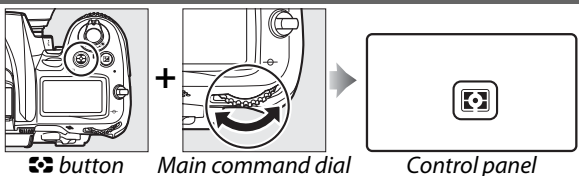

Set exposure compensation (mode **P**, **S**, **A**, or **M**;  107).

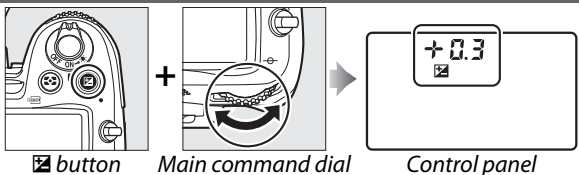

Activate or cancel bracketing/ select number of shots in bracketing sequence (mode **P**, **S**, **A**, or **M**;  109, 112, 114).

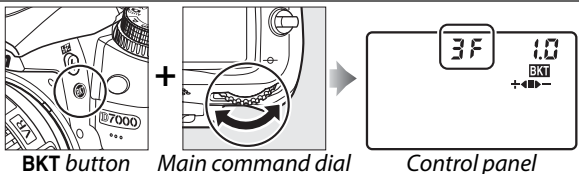

Select bracketing increment
(mode **P**, **S**, **A**, or **M**; 110, 112).

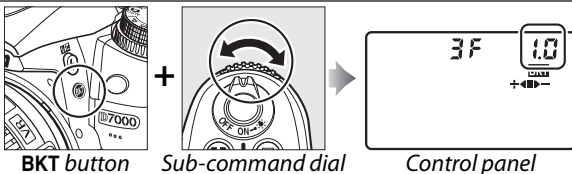

BKT button

Sub-command dial

Control panel

White Balance

Choose a white balance option
(mode **P**, **S**, **A**, or **M**; 117).

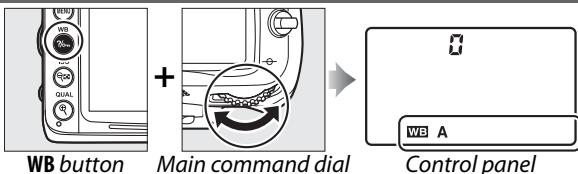

WB button

Main command dial

Control panel

Fine-tune white balance
(120), set color temperature
(122), or choose a white
balance preset (128) in mode
P, **S**, **A**, or **M**.

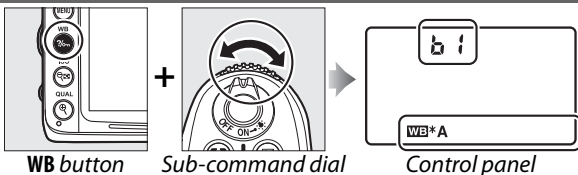

WB button

Sub-command dial

Control panel

Flash Settings

Choose a flash mode (144).

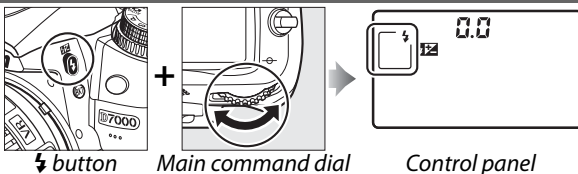

Flash button

Main command dial

Control panel

Set flash compensation (mode **P**,
S, **A**, or **M**; 148).

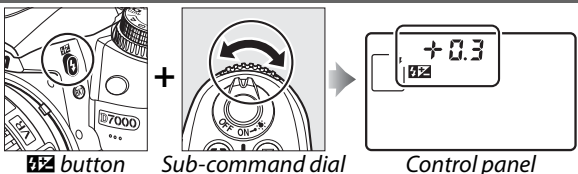

Flash button

Sub-command dial

Control panel

The BM-11 Monitor Cover

A clear plastic cover is provided with the camera to keep the monitor clean and protect it when the camera is not in use. To attach the cover, insert the projection on the top of the cover into the matching indentation above the camera monitor (①) and press the bottom of the cover until it clicks into place (②).

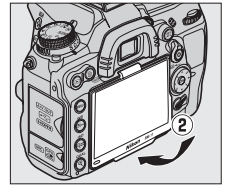
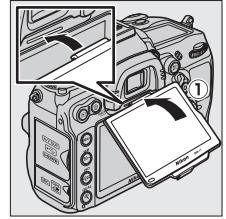

To remove the cover, hold the camera firmly and pull the bottom of the cover gently outwards as shown at right.

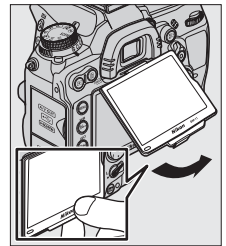

Camera Menus

Most shooting, playback, and setup options can be accessed from the camera menus. To view the menus, press the MENU button.

MENU button

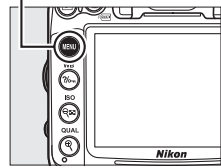

Tabs

Choose from the following menus:

- : **Playback** (☞ 195)
- : **Shooting** (☞ 202)
- : **Custom Settings** (☞ 206)
- : **Setup** (☞ 236)
- : **Retouch** (☞ 248)
- : **My Menu or Recent settings** (defaults to My Menu; ☞ 265)

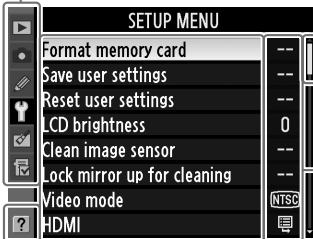

Slider shows position in current menu.

Current settings are shown by icons.

Menu options

Options in current menu.



If a icon is displayed at the bottom left corner of the monitor, help can be displayed by pressing the button. A description of the currently selected option or menu will be displayed while the button is pressed. Press or to scroll through the display.

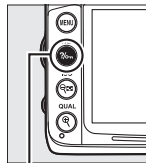

button

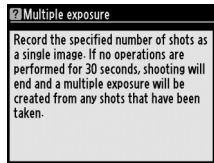

Using Camera Menus

The multi selector and **OK** button are used to navigate the camera menus.

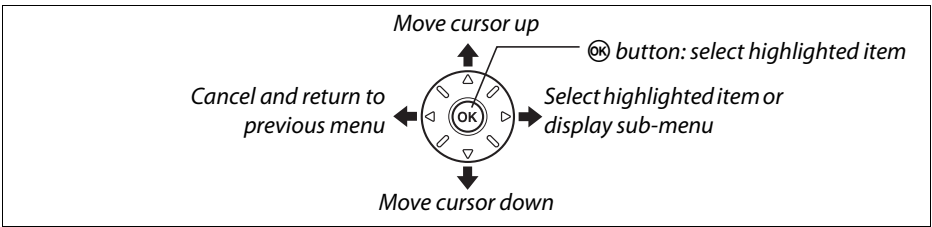

Follow the steps below to navigate the menus.

1 Display the menus.

Press the **MENU** button to display the menus.

MENU button

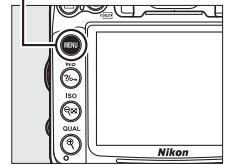

2 Highlight the icon for the current menu.

Press **◀** to highlight the icon for the current menu.



3 Select a menu.

Press **▲** or **▼** to select the desired menu.



4 Position the cursor in the selected menu.

Press **▶** to position the cursor in the selected menu.

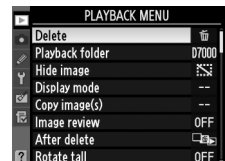

5 Highlight a menu item.

Press ▲ or ▼ to highlight a menu item.

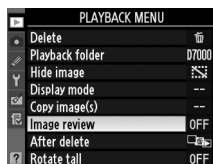

6 Display options.

Press ► to display options for the selected menu item.

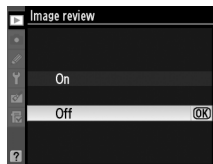

7 Highlight an option.

Press ▲ or ▼ to highlight an option.



8 Select the highlighted item.

Press **OK** to select the highlighted item. To exit without making a selection, press the **MENU** button.



Note the following:

- Menu items that are displayed in gray are not currently available.
- While pressing ► generally has the same effect as pressing **OK**, there are some cases in which selection can only be made by pressing **OK**.
- To exit the menus and return to shooting mode, press the shutter-release button halfway (☐ 39).

First Steps

Charge the Battery

The camera is powered by an EN-EL15 rechargeable Li-ion battery (supplied). To maximize shooting time, charge the battery in the supplied MH-25 battery charger before use. About 2 hours and 35 minutes are required to fully recharge the battery when no charge remains.



1 Connect the AC power cable or wall adapter.

Connect the power cable as shown at right. Use the AC adapter plug in the position shown; do not rotate.

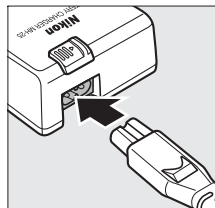

Depending on the country or region of purchase, an AC wall adapter may also be supplied with the charger. To use the adapter, insert it into the charger AC inlet (1). Slide the AC wall adapter latch in the direction shown (2) and rotate the adapter 90° to fix it in the position shown (3). Reverse these steps to remove the adapter.

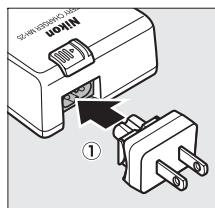

AC wall adapter latch

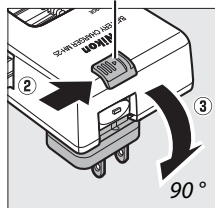

2 Remove the terminal cover.

Remove the terminal cover from the battery.

3 Insert the battery.

Place the battery in the battery bay as shown in the illustration on the charger.

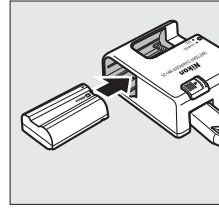

4 Plug the charger in.

The **CHARGE** lamp will blink while the battery charges.

Charging the Battery

Charge the battery indoors at ambient temperatures between 5–35°C (41–95°F). The battery will not charge if its temperature is below 0°C (32°F) or above 60°C (140°F).

Battery charging *Charging complete*

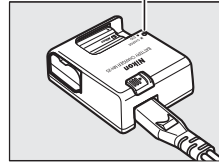
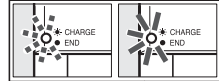

5 Remove the battery when charging is complete.

Charging is complete when the **CHARGE** lamp stops blinking. Unplug the charger and remove the battery.

The Battery and Charger

Read and follow the warnings and cautions on pages xii–xiii and 289–291 of this manual. Do not use the battery at ambient temperatures below 0°C/32°F or above 40°C/104°F; failure to observe this precaution could damage the battery or impair its performance. Capacity may be reduced and charging times may increase at battery temperatures from 0°C/32°F to 15°C/59°F and from 45°C/113°F to 60°C/140°F.

Do not move the charger or touch the battery during charging. Failure to observe this precaution could in very rare instances result in the charger showing that charging is complete when the battery is only partially charged. Remove and reinsert the battery to begin charging again.

If the **CHARGE** lamp flickers (i.e., flashes about eight times a second) during charging, confirm that the temperature is in the correct range and then unplug the charger and remove and reinsert the battery. If the problem persists, cease use immediately and take battery and charger to your retailer or a Nikon-authorized service representative.

The supplied power cable and AC wall adapter are for use with the MH-25 only. Use the charger with compatible batteries only. Unplug when not in use.

EN-EL15 Rechargeable Li-ion Batteries

The supplied EN-EL15 shares information with compatible devices, enabling the camera to show battery charge state in six levels (📖 35). The **Battery info** option in the setup menu details battery charge, battery life, and the number of pictures taken since the battery was last charged (📖 242).



Insert the Battery

1 Turn the camera off.

Inserting and Removing Batteries

Always turn the camera off before inserting or removing batteries.

2 Open the battery-chamber cover.

Unlatch (1) and open (2) the battery-chamber cover.

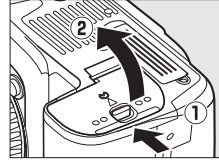

3 Insert the battery.

Insert the battery in the orientation shown (1), using the battery to keep the orange battery latch pressed to one side. The latch locks the battery in place when the battery is fully inserted (2).

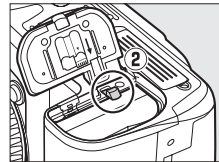
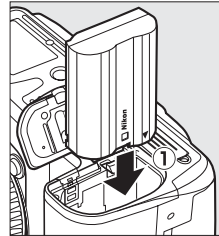

Battery latch

4 Close the battery-chamber cover.

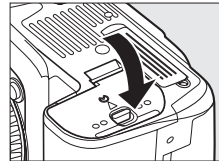

Removing the Battery

Turn the camera off and open the battery-chamber cover. Press the battery latch in the direction shown by the arrow to release the battery and then remove the battery by hand.

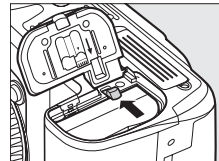

Attach a Lens

Care should be taken to prevent dust from entering the camera when the lens is removed. The lens generally used in this manual for illustrative purposes is an AF-S DX NIKKOR 18–105 mm f/3.5–5.6G ED VR.

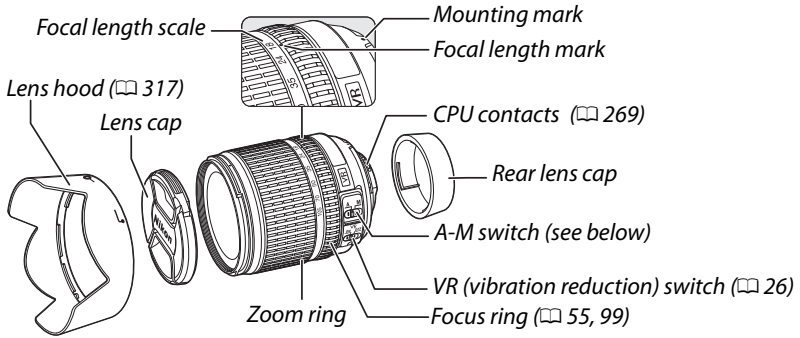

1 Turn the camera off.

2 Remove the rear lens cap and the camera body cap.

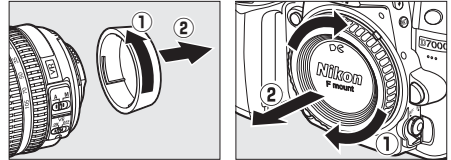

3 Attach the lens.

Keeping the mounting mark on the lens aligned with the mounting mark on the camera body, position the lens in the camera's bayonet mount (1). Being careful not to press the lens-release button, rotate the lens counter-clockwise until it clicks into place (2).

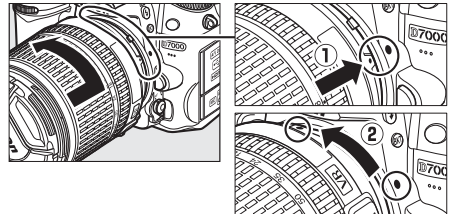

Slide the **A-M** switch to **A** (autofocus; if the lens has an **M/A-M** switch, select **M/A** for autofocus with manual override).



■ ■ **Vibration Reduction (VR)**

AF-S DX NIKKOR 18–105 mm f/3.5–5.6G ED VR lenses support vibration reduction (VR), which reduces blur caused by camera shake even when the camera is panned, allowing shutter speeds to be slowed by approximately 3 EV (Nikon measurements; effects vary with the user and shooting conditions).

To use vibration reduction, slide the VR switch to **ON**. Vibration reduction is activated when the shutter-release button is pressed halfway, reducing the effects of camera shake on the image in the viewfinder and simplifying the process of framing the subject and focusing in both autofocus and manual focus modes. When the camera is panned, vibration reduction applies only to motion that is not part of the pan (if the camera is panned horizontally, for example, vibration reduction will be applied only to vertical shake), making it much easier to pan the camera smoothly in a wide arc.

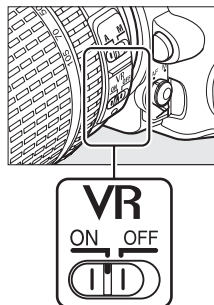

Vibration reduction can be turned off by sliding the VR switch to **OFF**. Turn vibration reduction off when the camera is securely mounted on a tripod, but leave it on if the tripod head is not secured or when using a monopod.

Detaching the Lens

Be sure the camera is off when removing or exchanging lenses. To remove the lens, press and hold the lens release button (1) while turning the lens clockwise (2). After removing the lens, replace the lens caps and camera body cap.

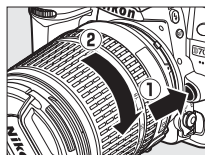

CPU Lenses with Aperture Rings

In the case of CPU lenses equipped with an aperture ring (□ 269), lock aperture at the minimum setting (highest f-number).

Vibration Reduction

Do not turn the camera off or remove the lens while vibration reduction is in effect. If power to the lens is cut while vibration reduction is on, the lens may rattle when shaken. This is not a malfunction, and can be corrected by reattaching the lens and turning the camera on. Vibration reduction is disabled while the built-in flash is charging. When vibration reduction is active, the image in the viewfinder may be blurred after the shutter is released. This does not indicate a malfunction.

Basic Setup

A language-selection dialog will be displayed the first time the camera is turned on. Choose a language and set the time and date. Photographs can not be taken until you have set the time and date.

1 Turn the camera on.

A language-selection dialog will be displayed.

2 Select a language.

Press ▲ or ▼ to highlight the desired language and press **OK**.



3 Choose a time zone.

A time-zone selection dialog will be displayed. Press ◀ or ▶ to highlight the local time zone (the **UTC** field shows the difference between the selected time zone and Coordinated Universal Time, or UTC, in hours) and press **OK**.



4 Choose a date format.

Press ▲ or ▼ to choose the order in which the year, month, and day will be displayed. Press **OK** to proceed to the next step.

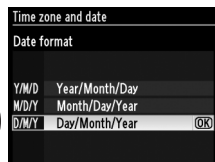

5 Turn daylight saving time on or off.

Daylight saving time options will be displayed. Daylight saving time is off by default; if daylight saving time is in effect in the local time zone, press ▲ to highlight **On** and press **OK**.

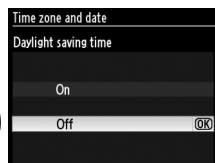

6 Set the date and time.

The dialog shown at right will be displayed. Press ◀ or ▶ to select an item, ▲ or ▼ to change. Press **OK** to set the clock and exit to shooting mode.

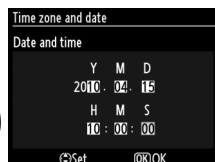

 **Setting the Clock**

Language and date/time settings can be changed at any time using the **Language** (☐ 238) and **Time zone and date** (☐ 237) options in the setup menu. The camera clock can also be synchronized with GPS devices (☐ 162).

 **The Clock Battery**

The camera clock is powered by an independent, rechargeable power source, which is charged as necessary when the main battery is installed or the camera is powered by an optional EP-5B power connector and EH-5a AC adapter (☐ 280). Two days of charging will power the clock for about three months. If the **CLOCK** icon flashes in the control panel, the clock battery is exhausted and the clock has been reset. Set the clock to the correct time and date.

 **The Camera Clock**

The camera clock is less accurate than most watches and household clocks. Check the clock regularly against more accurate time pieces and reset as necessary.

Insert a Memory Card

The camera stores pictures on Secure Digital (SD) memory cards (available separately; □ 319). The camera has two memory card slots (Slot 1 and Slot 2); if you will be using only one memory card, insert it in Slot 1 (□ 30).

1 Turn the camera off.

Inserting and Removing Memory Cards

Always turn the camera off before inserting or removing memory cards.

2 Open the card slot cover.

Slide the card slot cover out (①) and open the card slot (②).

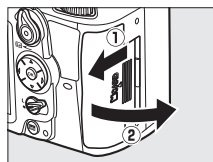

3 Insert the memory card.

Holding the memory card as shown at right, slide it in until it clicks into place. The memory card access lamp will light for a few seconds.

Inserting Memory Cards

Inserting memory cards upside down or backwards could damage the camera or the card. Check to be sure the card is in the correct orientation.

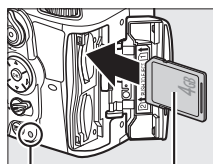

Front

Access lamp

Close the memory card slot cover. If this is the first time the memory card will be used in the camera or the card has been formatted in another device, format the card as described on page 32.

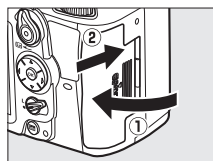

No Memory Card

If no memory card is inserted, the displays in the control panel and at the bottom of the viewfinder will show (- E -) and a “no memory card” icon will be displayed in the viewfinder screen while the battery has charge remaining, even when the camera is off.

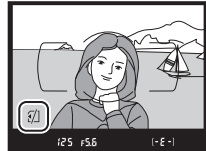
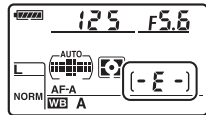

Removing Memory Cards

After confirming that the access lamp is off, turn the camera off, open the memory card slot cover, and press the card in to eject it (1). The card can then be removed by hand (2).

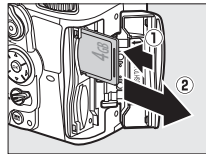

Using Two Memory Cards

Slot 1 is for the main card; the card in slot 2 plays a backup or secondary role. If the default setting of **Overflow** is selected for **Role played by card in Slot 2** (☐ 89) when two memory cards are inserted, the card in slot 2 will only be used when the card in slot 1 is full.

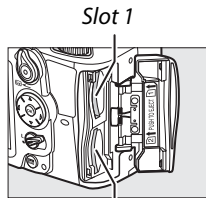

Slot 2

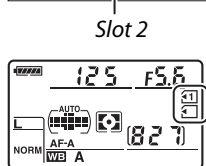

The control panel shows the slot or slots that currently hold a memory card (the example at right shows the icons displayed when a card is inserted in each slot). If the memory card is full or locked or an error has occurred, the icon for the affected card will blink (☐ 307).

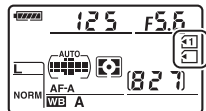

Control panel

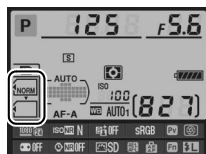

Information display

☑ Memory Cards

- Memory cards may be hot after use. Observe due caution when removing memory cards from the camera.
- Do not remove memory cards from the camera, turn the camera off, or remove or disconnect the power source during formatting or while data are being recorded, deleted, or copied to a computer. Failure to observe these precautions could result in loss of data or in damage to the camera or card.
- Do not touch the card terminals with your fingers or metal objects.
- Do not bend, drop, or subject to strong physical shocks.
- Do not apply force to the card casing. Failure to observe this precaution could damage the card.
- Do not expose to water, heat, high levels of humidity, or direct sunlight.



Format the Memory Card







Memory cards must be formatted before first use or after being used or formatted in other devices.

✓ Formatting Memory Cards

Formatting memory cards permanently deletes any data they may contain. Be sure to copy any photographs and other data you wish to keep to a computer before proceeding (179).



1 Turn the camera on.

2 Press the buttons.

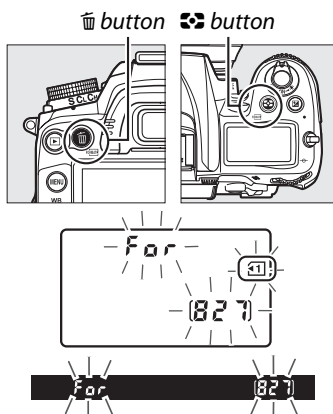
Hold the  ( and ) buttons down simultaneously until a blinking **F o r** appears in the shutter-speed displays in the control panel and viewfinder. If two memory cards are inserted, the card in Slot 1 (179 30) will be selected; you can choose the card in Slot 2 by rotating the main command dial. To exit without formatting the memory card, wait until **F o r** stops blinking (about six seconds) or press any button other than the  ( and ) buttons.



3 Press the buttons again.

Press the  ( and ) buttons together a second time while **F o r** is blinking to format the memory card. *Do not remove the memory card or remove or disconnect the power source during formatting.* When formatting is complete, the control panel and viewfinder will show the number of photographs that can be recorded at current settings.

The Write Protect Switch

Memory cards are equipped with a write protect switch to prevent accidental loss of data. When this switch is in the “lock” position, the memory card can not be formatted and photos can not be deleted or recorded (a warning will be displayed in the monitor if you attempt to release the shutter). To unlock the memory card, slide the switch to the “write” position.

See Also

See page 236 for information on formatting memory cards using the **Format memory card** option in the setup menu.

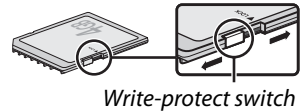

Adjust Viewfinder Focus

The camera is equipped with diopter adjustment to accommodate individual differences in vision. Check that the display in the viewfinder is in focus before framing pictures in the viewfinder.

1 Remove the lens cap.

2 Turn the camera on.



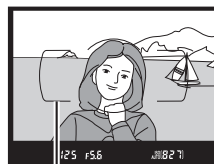
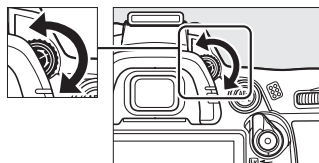

3 Focus the viewfinder.

Rotate the diopter adjustment control until the AF area brackets are in sharp focus. When operating the diopter adjustment control with your eye to the viewfinder, be careful not to put your fingers or fingernails in your eye.



AF area brackets

Adjusting Viewfinder Focus

If you are unable to focus the viewfinder as described above, select single-servo autofocus (**AF-S**;  91), single-point AF ( 94), and the center focus point ( 96), and then frame a high-contrast subject in the center focus point and press the shutter-release button halfway to focus the camera. With the camera in focus, use the diopter adjustment control to bring the subject into clear focus in the viewfinder. If necessary, viewfinder focus can be further adjusted using optional corrective lenses ( 281).



Basic Photography and Playback

“Point-and-Shoot” Photography

(and Modes)

This section describes how to take photographs in (auto) mode, an automatic “point-and-shoot” mode in which the majority of settings are controlled by the camera in response to shooting conditions, and in which the flash will fire automatically if the subject is poorly lit. To take photographs with the flash off while leaving the camera in control of other settings, rotate the mode dial to to select auto (flash off) mode.

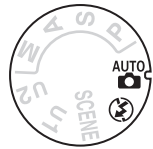

Step 1: Turn the Camera On

1 Turn the camera on.

Remove the lens cap and turn the camera on. The control panel will turn on and the display in the viewfinder will light.

2 Check the battery level.

Check the battery level in the control panel or viewfinder.

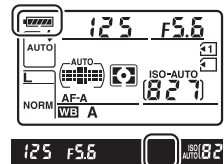

Control panel*	Viewfinder*	Description
	—	Battery fully charged.
	—	Battery partially discharged.
	—	
	—	
		Low battery. Charge battery or ready spare battery.
(blinks)	(blinks)	Shutter release disabled. Charge or exchange battery.

* No icon displayed when camera is powered by optional EP-5B power connector and EH-5a AC adapter. appears in information display.

Image Sensor Cleaning

The camera vibrates the low-pass filter covering the image sensor to remove dust when the camera is turned on or off (284).



3 Check the number of exposures remaining.

The control panel and viewfinder show the number of photographs that can be taken at current settings (values over 1,000 are rounded down to the nearest hundred; e.g., values between 1,200 and 1,299 are shown as 1.2 K). If two memory cards are inserted, the displays show the space available on the card in Slot 1 (☐ 30). When the number of exposures remaining reaches 0, the number will flash, **FULL** or **FULL** will blink in the shutter-speed displays, and the icon for the affected card will blink. Insert another memory card (☐ 29) or delete some photos (☐ 47, 175).

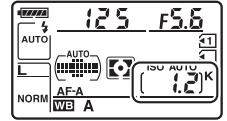



Camera Off Display

If the camera is turned off with a battery and memory card inserted, the memory card icon and number of exposures remaining will be displayed (some memory cards may in rare cases only display this information when the camera is on).



Control panel

Step 2: Select ^{AUTO} or Mode

To shoot where use of a flash is prohibited, photograph infants, or capture natural lighting under low light conditions, rotate the mode dial to . Otherwise, rotate the mode dial to ^{AUTO} .

Mode dial

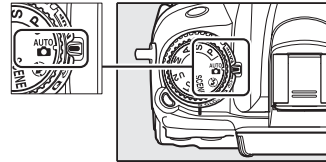

 mode



^{AUTO}  mode

Step 3: Frame the Photograph

1 Ready the camera.

When framing photographs in the viewfinder, hold the handgrip in your right hand and cradle the camera body or lens with your left. Keep your elbows propped lightly against your torso for support and place one foot half a pace ahead of the other to keep your upper body stable.

Hold the camera as shown at right when framing photographs in portrait (tall) orientation.

In \odot mode, shutter speeds slow when lighting is poor; use of a tripod is recommended.

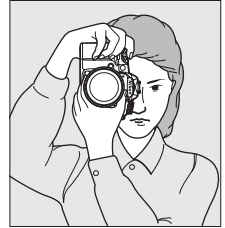
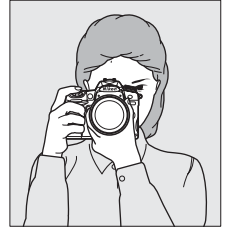

2 Frame the photograph.

Frame a photograph in the viewfinder with the main subject in the AF area brackets.

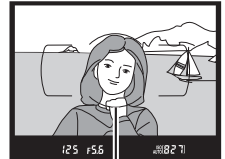

AF area brackets

Using a Zoom Lens

Use the zoom ring to zoom in on the subject so that it fills a larger area of the frame, or zoom out to increase the area visible in the final photograph (select longer focal lengths on the lens focal length scale to zoom in, shorter focal lengths to zoom out).

The AF-S DX NIKKOR 18–105 mm f/3.5–5.6G ED VR

In the case of the AF-S DX NIKKOR 18–105 mm f/3.5–5.6G ED VR (□ 315, 316), changes to zoom can alter maximum aperture by up to $1\frac{1}{3}$ EV. The camera however automatically takes this into account when setting exposure, and no modifications to camera settings are required following adjustments to zoom.

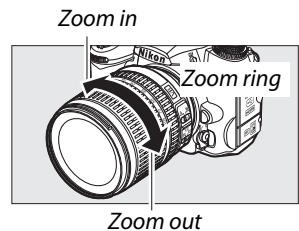

Step 4: Focus

1 Press the shutter-release button halfway.

Press the shutter-release button halfway to focus. The active focus point will be displayed. If the subject is poorly lit, the flash may pop up and the AF-assist illuminator may light.



2 Check the indicators in the viewfinder.

When the focus operation is complete, the in-focus indicator (●) will appear in the viewfinder.

In-focus indicator	Description
●	Subject in focus.
▶	Focus point is between camera and subject.
◀	Focus point is behind subject.
▶ ◀ (blinks)	Camera unable to focus using autofocus. See page 93.

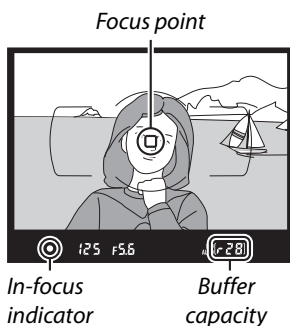

While the shutter-release button is pressed halfway, the number of exposures that can be stored in the memory buffer ("79"; □ 79) will be displayed in the viewfinder.

Step 5: Shoot

Smoothly press the shutter-release button the rest of the way down to release the shutter and record the photograph. The access lamp next to the memory card slot cover will light while the photograph is being recorded to the memory card. *Do not eject the memory card or remove or disconnect the power source until the lamp has gone out and recording is complete.*

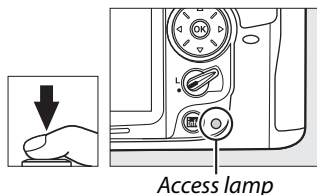

The Shutter-Release Button

The camera has a two-stage shutter-release button. The camera focuses when the shutter-release button is pressed halfway. To take the photograph, press the shutter-release button the rest of the way down.



Focus: press halfway



Shoot: press all the way down

Auto-Meter Off

The viewfinder and the control panel shutter speed and aperture displays will turn off if no operations are performed for about 6 seconds (auto meter off), reducing the drain on the battery. Press the shutter-release button halfway to reactivate the display. The auto-meter off delay can be selected using Custom Setting c2 (**Auto meter-off delay**,  214).

6 s

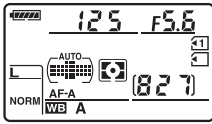

Exposure meters on

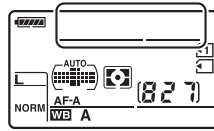

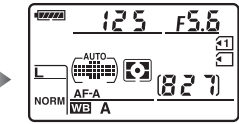

Exposure meters off



Exposure meters on

The Built-in Flash

If additional lighting is required for correct exposure in  mode, the built-in flash will pop up automatically when the shutter-release button is pressed halfway. If the flash is raised, photographs can only be taken when the flash-ready indicator () is displayed. If the flash-ready indicator is not displayed, the flash is charging; remove your finger briefly from the shutter-release button and try again.

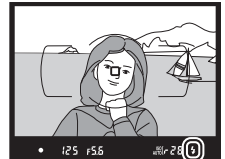
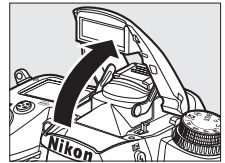

To save battery power when the flash is not in use, return it to its closed position by pressing it gently downward till the latch clicks into place.

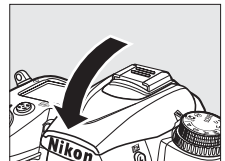

Creative Photography (Scene Modes)

The camera offers a choice of “scene” modes. Choosing a scene mode automatically optimizes settings to suit the selected scene, making creative photography as simple as selecting a mode, framing a picture, and shooting as described on pages 35–39.

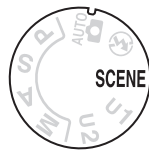

■■ SCENE Mode

To select a scene, rotate the mode dial to **SCENE** and then rotate the main command dial until the desired scene is displayed in the monitor. The monitor turns on automatically when the dial is rotated.

Mode dial

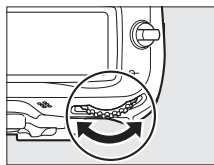
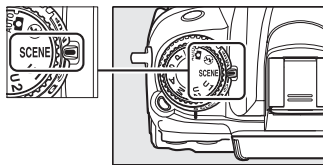

Main command dial



Monitor

Portrait 	Landscape 	Child 	Sports 	Close up 	Night portrait 	Night landscape
Party/indoor 	Beach/snow 	Sunset 	Dusk/dawn 	Pet portrait 	Candlelight 	Blossom
Autumn colors 	Food 	Silhouette 	High key 	Low key 		

■ Scene Modes

Portrait



Use for portraits with soft, natural-looking skin tones. If the subject is far from the background or a telephoto lens is used, background details will be softened to lend the composition a sense of depth.

Landscape

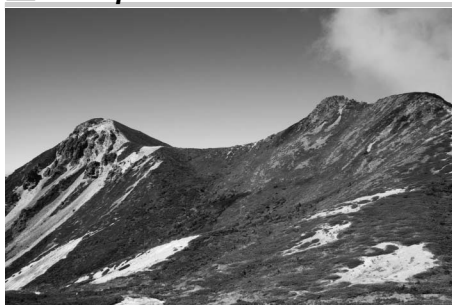

Use for vivid landscape shots in daylight. The built-in flash and AF-assist illuminator turn off; use of a tripod is recommended to prevent blur when lighting is poor.

Child



Use for snapshots of children. Clothing and background details are vividly rendered, while skin tones remain soft and natural.

Sports



Fast shutter speeds freeze motion for dynamic sports shots in which the main subject stands out clearly. The built-in flash and AF-assist illuminator turn off. To take a sequence of shots, select continuous release mode (📖 7, 77, 78).



Close Up



Use for close-up shots of flowers, insects, and other small objects (a macro lens can be used to focus at very close ranges). Use of a tripod is recommended to prevent blur.



Night Landscape



Reduce noise and unnatural colors when photographing night landscapes, including street lighting and neon signs. The built-in flash and AF-assist illuminator turn off; use of a tripod is recommended to prevent blur.

Night Portrait



Use for a natural balance between the main subject and the background in portraits taken under low light. Use of a tripod is recommended to prevent blur when lighting is poor.

Party/Indoor



Capture the effects of indoor background lighting. Use for parties and other indoor scenes.

 **Beach/Snow**



Capture the brightness of sunlight expanses of water, snow, or sand. The built-in flash and AF-assist illuminator turn off.

 **Dusk/Dawn**



Preserves the colors seen in the weak natural light before dawn or after sunset. The built-in flash and AF-assist illuminator turn off; use of a tripod is recommended to prevent blur when lighting is poor.

 **Sunset**



Preserves the deep hues seen in sunsets and sunrises. The built-in flash and AF-assist illuminator turn off; use of a tripod is recommended to prevent blur when lighting is poor.

 **Pet Portrait**



Use for portraits of active pets. The AF-assist illuminator turns off.



Candlelight



For photographs taken by candlelight. The built-in flash turns off; use of a tripod is recommended to prevent blur when lighting is poor.

Autumn Colors



Captures the brilliant reds and yellows in autumn leaves. The built-in flash turns off; use of a tripod is recommended to prevent blur when lighting is poor.

Blossom



Use for fields of flowers, orchards in bloom, and other landscapes featuring expanses of blossoms. The built-in flash turns off; use of a tripod is recommended to prevent blur when lighting is poor.

Food



Use for vivid photographs of food. Use of a tripod is recommended to prevent blur; the flash can also be used (□ 143).

Silhouette



Silhouette subjects against bright backgrounds. The built-in flash turns off; use of a tripod is recommended to prevent blur when lighting is poor.

Low Key



Use when shooting dark scenes to create dark, somber images that bring out highlights. The built-in flash turns off; use of a tripod is recommended to prevent blur when lighting is poor.



High Key



Use when shooting bright scenes to create bright images that seem filled with light. The built-in flash turns off.

Basic Playback



1 Press the button.



A photograph will be displayed in the monitor. The memory card containing the picture currently displayed is shown by an icon.

 button



2 View additional pictures.

Additional pictures can be displayed by pressing  or .

To view additional information on the current photograph, press  and  (📖 165).

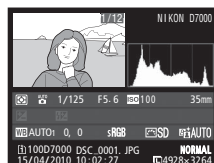

To end playback and return to shooting mode, press the shutter-release button halfway.



Image Review

When **On** is selected for **Image review** in the playback menu (📖 200), photographs are automatically displayed in the monitor for about 4 s after shooting.

See Also

See page 164 for information on choosing a memory card slot.

Deleting Unwanted Photographs



To delete the photograph currently displayed in the monitor, press the  button. *Note that photographs can not be recovered once deleted.*

1 Display the photograph.

Display the photograph you wish to delete as described on the preceding page.





2 Delete the photograph.

Press the  button. A confirmation dialog will be displayed with an icon at bottom left showing the location of the current picture; press the  button again to delete the image and return to playback (to exit without deleting the picture, press ).

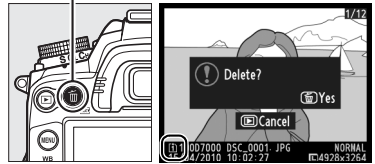
 button



Delete

To delete selected images ( 176), all images taken on a selected date ( 177), or all images in a chosen location on a selected memory card ( 176), use the **Delete** option in the playback menu.



Framing Photographs in the Monitor

Follow the steps below to take photographs in live view.

1 Rotate the live view switch.

The mirror will be raised and the view through the lens will be displayed in the camera monitor. The subject will no longer be visible in the viewfinder.

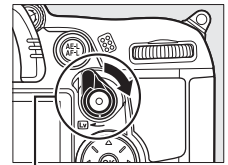

Live view switch

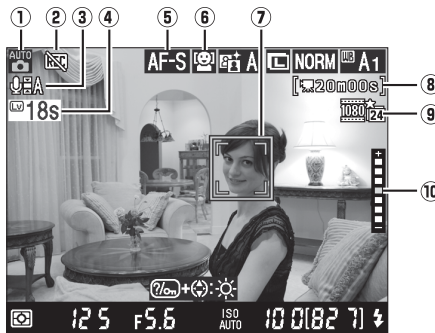

Note: For illustrative purposes, monitor is shown with all indicators displayed.

Item	Description	
① Shooting mode	The mode currently selected with the mode dial.	6
② "No movie" icon	Indicates that movies can not be recorded.	57
③ Audio recording indicator	Indicates whether sound is being recorded with movies.	60
④ Time remaining	The amount of time remaining before live view ends automatically. Displayed if shooting will end in 30 s or less.	54, 59
⑤ AF mode	The current autofocus mode.	50
⑥ AF-area mode	The current AF-area mode.	50
⑦ Focus point	The current focus point. The display varies with the option selected for AF-area mode (□ 50).	51
⑧ Time remaining (movie mode)	The recording time remaining in movie mode.	58
⑨ Movie quality	The frame size and quality of movies recorded in movie mode.	60
⑩ Monitor brightness	Displayed while the $\% \rightarrow$ button is pressed; keep the button pressed and press \blacktriangle or \blacktriangledown to adjust brightness (this applies to the monitor only; exposure is not affected).	—

2 Choose a focus mode.

To choose an autofocus mode, rotate the focus-mode selector to **AF**, and then press the AF-mode button and rotate the main command dial until the desired mode is displayed in the monitor.

Mode	Description
AF-S	Single-servo AF: For stationary subjects. Focus locks when shutter-release button is pressed halfway.
AF-F	Full time-servo AF: For moving subjects. Camera focuses continuously until shutter-release button is pressed. Focus locks when shutter-release button is pressed halfway.

Focus-mode selector

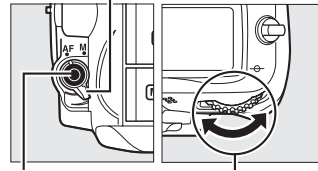

AF-mode button Main command dial button



Monitor

To use manual focus, rotate the focus-mode selector to **M** and proceed to Step 6 after focusing as described on page 55.

3 Choose an AF-area mode.

To choose an AF-area mode, press the AF-mode button and rotate the sub-command dial until the desired mode is displayed in the monitor.

Mode	Description
	Face-priority AF: The camera automatically detects and focuses on portrait subjects facing the camera. Use for portraits.
	Wide-area AF: Use for hand-held shots of landscapes and other non-portrait subjects. Use the multi selector to select the focus point.
	Normal-area AF: Use for pin-point focus on a selected spot in the frame. A tripod is recommended.
	Subject-tracking AF: Track a selected subject as it moves through the frame.

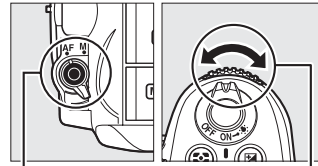

AF-mode button Sub-command dial button



Monitor

Live View AF and AF-Area Modes

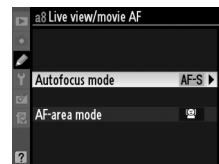

The AF and AF-area modes for live view can also be chosen using Custom Setting a8 (**Live view/movie AF**; 211).





4 Choose the focus point.

 **(face-priority AF):** A double yellow border will be displayed when the camera detects a portrait subject facing the camera (if multiple faces, up to a maximum of 35, are detected, the camera will focus on the closest subject; to choose a different subject, press the multi selector up, down, left, or right).

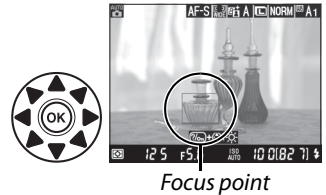

 **(wide- and normal-area AF):** Use the multi selector to move the focus point anywhere in the frame, or press  to position the focus point in the center of the frame.



 **(subject-tracking AF):** Position the focus point over your subject and press . The focus point will track the selected subject as it moves through the frame.

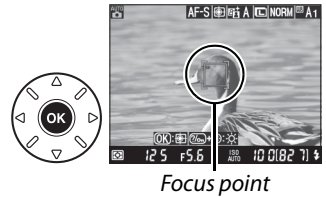

Using Autofocus in Live View

Use an AF-S lens. The desired results may not be achieved with other lenses or teleconverters. Note that in live view, autofocus is slower and the monitor may brighten or darken while the camera focuses. The focus point may sometimes be displayed in green when the camera is unable to focus. The camera may be unable to focus in the following situations:

- The subject contains lines parallel to the long edge of the frame
- The subject lacks contrast
- The subject in the focus point contains areas of sharply contrasting brightness, or the subject is lit by spot lighting or by a neon sign or other light source that changes in brightness
- Flicker or banding appears under fluorescent, mercury-vapor, sodium-vapor, or similar lighting
- A cross (star) filter or other special filter is used
- The subject appears smaller than the focus point
- The subject is dominated by regular geometric patterns (e.g., blinds or a row of windows in a skyscraper)
- The subject is moving

5 Focus.

Press the shutter-release button halfway to focus.



AF-L (face-priority AF): The camera sets focus for the face in the double yellow border while the shutter-release button is pressed halfway; if the camera can no longer detect the subject (because, for example, the subject has looked away), borders will no longer be displayed.

Wide/Norm (wide- and normal-area AF): The camera focuses on the subject in the selected focus point while the shutter-release button is pressed halfway.

AF-ON (subject-tracking AF): The camera focuses on the current subject. To end tracking, press **OK**.

Subject Tracking

The camera may be unable to track subjects if they are small, moving quickly, or a similar color to the background, or if both the subject and the background are very bright or very dark, the brightness and color of the subject or background varies greatly, the subject leaves the frame, or the subject visibly changes size.

The focus point will blink green while the camera focuses. If the camera is able to focus, the focus point will be displayed in green; if the camera is unable to focus, the focus point will blink red (note that pictures can be taken even when the focus point blinks red; check focus in the monitor before shooting).

Exposure can be locked by pressing the **AE-L/AF-L** button (106). Focus can be locked by pressing the shutter-release button halfway.

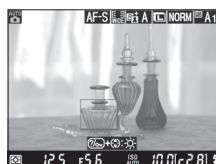
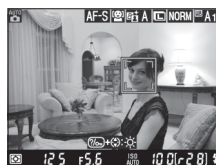

6 Take the picture.

Press the shutter-release button the rest of the way down to shoot. The monitor will turn off.



7 Exit live view mode.

Rotate the live view switch to exit live view mode.

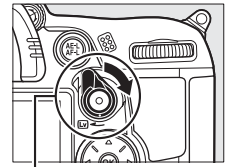

Live view switch

Live View/Movie Recording Display Options

Press the  button to cycle through display options as shown below.

Show photo indicators



Show movie indicators* 



Hide all indicators* 

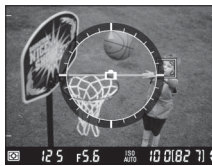

Virtual horizon*

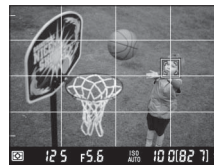

Framing grid*

* A crop showing the area recorded is displayed during movie recording when frame sizes other than 640 × 424 are selected for **Movie settings > Movie quality** in the shooting menu (□ 60; when movie indicators are displayed, the area outside the crop is greyed out).

Flicker

You may notice flicker or banding in the monitor during live view or when shooting movies under certain types of lighting, such as fluorescent or mercury-vapor lamps. Flicker and banding can be reduced by choosing a **Flicker reduction** option that matches the frequency of the local AC power supply (□ 237).

Exposure

Depending on the scene, exposure may differ from that which would be obtained when live view is not used. Metering in live view is adjusted to suit the live view display, producing photographs with exposure close to what is seen in the monitor. In **P**, **S**, **A**, and **M** modes, exposure can be adjusted by ±5 EV (□ 107). Note that the effects of values over +3 EV or under -3 EV can not be previewed in the monitor.



HDMI

When the camera is attached to an HDMI video device, the camera monitor will turn off and the video device will display the view through the lens as shown at right. If the device supports HDMI-CEC, select **Off** for the **HDMI > Device control** option in the setup menu (☞ 194) before shooting in live view.



Shooting in Live View Mode

To prevent light entering via the viewfinder from interfering with exposure, remove the rubber eyecup and cover the viewfinder with the supplied DK-5 eyepiece cap before shooting (☞ 81).

Although they will not appear in the final picture, flicker, banding, or distortion may be visible in the monitor under fluorescent, mercury vapor, or sodium lamps or if the camera is panned horizontally or an object moves at high speed through frame. Bright light sources may leave after-images in the monitor when the camera is panned. Bright spots may also appear. When shooting in live view mode, avoid pointing the camera at the sun or other strong light sources. Failure to observe this precaution could result in damage to the camera's internal circuitry.

Live view ends automatically if the lens is removed.

Live view may end automatically to prevent damage to the camera's internal circuits; exit live view when the camera is not use. Note that the temperature of the camera's internal circuits may rise and noise (bright spots, randomly-spaced bright pixels, or fog) may be displayed in the following instances (the camera may also become noticeably warm, but this does not indicate a malfunction):

- The ambient temperature is high
- The camera has been used for extended periods in live view or to record movies
- The camera has been used in continuous release mode for extended periods

If a warning is displayed when you attempt to start live view, wait for the internal circuits to cool and then try again.



The Count Down Display

A count down will be displayed 30 s before live view ends automatically (☞ 49; the timer turns red 5 s before the expiry of the time selected **Monitor off delay > Live view**—☞ 215—or if live view is about to end to protect the internal circuits). Depending on shooting conditions, the timer may appear immediately when live view is selected. Note that although the count down does not appear during playback, live view will still end automatically when the timer expires.

Manual Focus

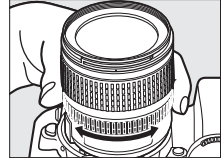
To focus in manual focus mode (📖 99), rotate the lens focus ring until the subject is in focus.



To magnify the view in the monitor up to about 7.7 × for precise focus, press the  button. While the view through the lens is zoomed in, a navigation window will appear in a gray frame at the bottom right corner of the display. Use the multi selector to scroll to areas of the frame not visible in the monitor (available only if wide- or normal-area AF is selected for AF-area mode), or press  to zoom out.

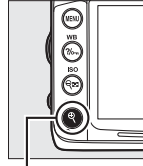

 button



Navigation window





Recording and Viewing Movies

Recording Movies

Movies can be recorded in live view mode. If desired, choose a Picture Control (□ 131) and color space (□ 141) before recording.

1 Rotate the live view switch.

The mirror is raised and the view through the lens is displayed in the monitor instead of the viewfinder.

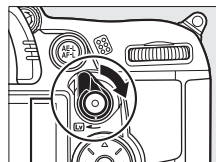

Live view switch

The Icon

A  icon (□ 49) indicates that movies can not be recorded.

Before Recording

Set aperture before recording in mode **A** or **M**. Note that movies may be over- or under-exposed at some aperture settings.

Before shooting, check the brightness of the scene in the monitor; if the picture is too bright or too dark, end live view and adjust aperture as necessary.

2 Choose a focus mode.

Choose a focus mode as described in Step 2 of “Live View” (□ 50).

Using an External Microphone

The built-in microphone may record lens noise during autofocus or vibration reduction. This can be prevented by using a commercially-available external microphone with a stereo mini-pin jack (3.5 mm diameter). External microphones can also be used to record in stereo.

3 Choose an AF-area mode.

See Step 3 on page 50 for more information.

4 Focus.

Frame the opening shot and focus as described in Steps 4 and 5 of “Live View” (□ 51–52). Note that the number of subjects that can be detected in face-priority AF drops during movie recording.



5 Start recording.

Press the movie-record button to start recording (the camera can record both video and sound; do not cover the microphone on the front of the camera during recording). A recording indicator and the time available are displayed in the monitor. Exposure can be locked by pressing the **AE-L/AF-L** button (□ 106) or (in modes **P**, **S**, **A**, and **M**) altered by up to ± 3 EV in steps of $\frac{1}{3}$ EV using exposure compensation (□ 107; note that depending on the brightness of the subject, changes to exposure may have no visible effect), and that exposure compensation is not available when **On** is selected for **Manual movie settings** in mode **M** as described on page 60. In autofocus mode, focus can be locked by pressing the shutter-release button halfway.

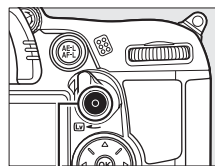

Movie-record button

Recording indicator



Time remaining

See Also

The behavior of the **AE-L/AF-L** button can be adjusted using Custom Setting f5 (**Assign AE-L/AF-L button**; □ 232).

6 End recording.

Press the movie-record button again to end recording (to end recording, return to live view, and take a photograph, press the shutter-release button all the way down). Recording will end automatically when the maximum length is reached, or the memory card is full.

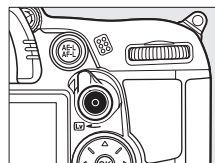

Maximum Length

Each movie file can be up to 4 GB in size and 20 minutes long; note that depending on memory card write speed, shooting may end before this length is reached (□ 319).

Recording Movies

Flicker, banding, or distortion may be visible in the monitor and in the final movie under fluorescent, mercury vapor, or sodium lamps or if the camera is panned horizontally or an object moves at high speed through frame (flicker and banding can be reduced by choosing a **Flicker reduction** option that matches the frequency of the local AC power supply;  237). Bright light sources may leave after-images when the camera is panned. Jagged edges, false colors, moiré, and bright spots may also appear. When recording movies, avoid pointing the camera at the sun or other strong light sources. Failure to observe this precaution could result in damage to the camera's internal circuitry.

Recording ends automatically if the lens is removed or when the mode dial is rotated.

Live view may end automatically to prevent damage to the camera's internal circuits; exit live view when the camera is not use. Note that the temperature of the camera's internal circuits may rise and noise (bright spots, randomly-spaced bright pixels, or fog) may be displayed in the following instances (the camera may also become noticeably warm, but this does not indicate a malfunction):

- The ambient temperature is high
- The camera has been used for extended periods in live view or to record movies
- The camera has been used in continuous release mode for extended periods

If a warning is displayed when you attempt to start live view or movie recording, wait for the internal circuits to cool and then try again.

Shutter speed and ISO sensitivity are adjusted automatically unless **On** is selected for **Manual movie settings** ( 60) and the camera is in mode **M**.

The Count-Down Display

A count down will be displayed 30 s before movie recording ends automatically ( 49). Depending on shooting conditions, the timer may appear immediately when movie recording begins. Note that regardless of the amount of recording time available, live view will still end automatically when the timer expires. Wait for the internal circuits to cool before resuming movie recording.



■ ■ Movie Settings

Use the **Movie settings** option in the shooting menu to choose movie quality, sound, destination, and manual movie settings options.

- **Movie quality:** Choose from frame sizes of $\overline{1080}$ **1920 × 1080**, $\overline{720}$ **1280 × 720**, and $\overline{424}$ **640 × 424** and from ★ **high** and **normal** quality. The frame rate depends on the option currently selected for **Video mode** in the setup menu (□ 237):

Frame size (pixels)	NTSC		PAL	
	Frame rate	Maximum length	Frame rate	Maximum length
1920 × 1080	24 fps*	20 min.	24 fps*	20 min.
1280 × 720	Choose from 24* and 30 fps†		Choose from 24* and 25 fps	
640 × 424	30 fps†		25 fps	

* Listed value. Actual rate is 23.976 fps.

† Listed value. Actual rate is 29.97 fps.

- **Microphone:** Turn the built-in or external microphone on or off or to adjust microphone sensitivity. Selecting **Microphone off** turns sound recording off; selecting any other option turns recording on and sets the microphone to the selected sensitivity.
- **Destination:** To record movies to the memory card in Slot 1, select **Slot 1**. Select **Slot 2** to record movies to the card in Slot 2. The menu shows the time available on each card; recording ends automatically when no time remains.
- **Manual movie settings:** Choose **On** to allow manual adjustments to shutter speed and ISO sensitivity when the camera is in mode **M**. Shutter speed can be chosen from values between $1/8,000$ s and $1/30$ s, ISO sensitivity from values between ISO 100 and Hi 2 (□ 101). Note that ISO sensitivity is fixed at the value selected; the camera does not adjust ISO sensitivity automatically when **On** is selected for **ISO sensitivity settings > Auto ISO sensitivity control** in the shooting menu (□ 103). Exposure compensation is not available.

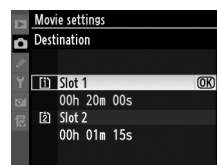

1 Select **Movie settings**.

Press the **MENU** button to display the menus. Highlight **Movie settings** in the shooting menu and press ►.

MENU button

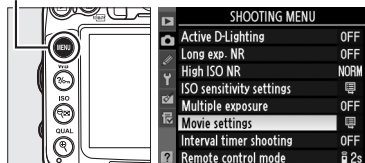

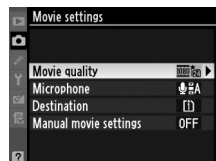

2 Choose movie options.

Highlight the desired item and press ►, then highlight an option and press **OK**.







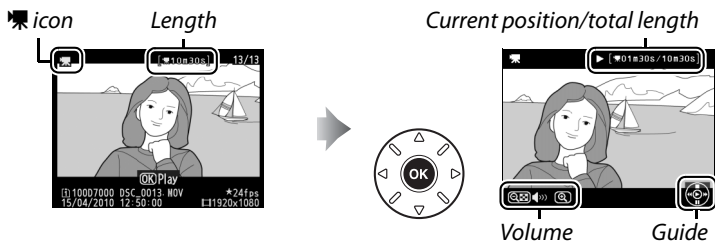





Viewing Movies

Movies are indicated by a  icon in full-frame playback (163). Press  to start playback.

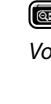

 The following operations can be performed:

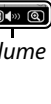
To	Use	Description
Pause		Pause playback.
Play		Resume playback when movie is paused or during rewind/advance.
Advance/ rewind		Speed doubles with each press, from 2x to 4x to 8x to 16x; keep pressed to skip to beginning or end of movie. If playback is paused, movie rewinds or advances one frame at a time; keep pressed for continuous rewind or advance.
Adjust volume		Press  to increase volume,  to decrease.
Edit movie		To edit movie, press  while movie is paused (163).
Return to full-frame playback		Press  or  to exit to full-frame playback.
Exit to shooting mode		Press shutter-release button halfway. Monitor will turn off; photographs can be taken immediately.
Display menus	MENU	See page 195 for more information.

The Icon

 is displayed in full-frame and movie playback if the movie was recorded without sound.



Editing Movies



Trim footage to create edited copies of movies or save selected frames as JPEG stills.

Option	Description
Choose start point	Create a copy from which the opening footage has been removed.
Choose end point	Create a copy from which the ending footage has been removed.
Save selected frame	Save a selected frame as a JPEG still.

Trimming Movies

To create trimmed copies of movies:



1 Display a movie full frame.

Press the  button to display pictures full frame in the monitor and press  and  to scroll through pictures until the movie you wish to edit is displayed.

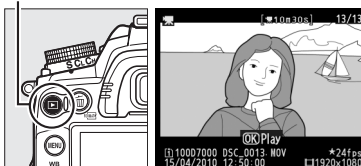
 button





2 Choose a starting or end point.

Play the movie back as described on page 62, pressing  to start and resume playback and  to pause. If you intend to trim the opening footage from the copy, pause on the first frame you wish to keep; if you will be editing out the ending footage pause on the last frame you wish to keep.



Starting and Ending Frames

The first frame is shown by a , the final frame by a  icon.



-
- 3 Display the retouch menu.**
Press **?/○** to display the retouch menu.

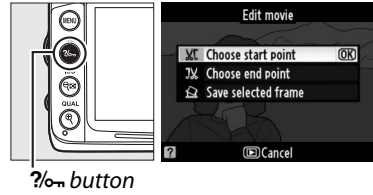

?/○ button

-
- 4 Choose an option.**
To create a copy that includes the current frame and all following frames, highlight **Choose start point** in the edit movie menu and press **OK**. Select **Choose end point** to create a copy that includes the current frame and all preceding frames.



-
- 5 Delete frames.**
Press **▲** to delete all frames before (**Choose start point**) or after (**Choose end point**) the current frame.



-
- 6 Save the copy.**
Highlight **Yes** and press **OK** to save the edited copy. If necessary, the copy can be trimmed as described above to remove additional footage. Edited copies are indicated by a **Ⓜ** icon in full-frame playback.

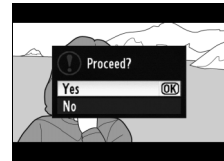

✓ **Trimming Movies**

Movies must be at least two seconds long. If a copy can not be created at the current playback position, the current position will be displayed in red in Step 5 and no copy will be created. The copy will not be saved if there is insufficient space available on the memory card.

To prevent the camera from turning off unexpectedly, use a fully-charged battery when editing movies.

✎ **The Retouch Menu**

Movies can also be edited using the **Edit movie** option in the retouch menu (□ 248).



Saving Selected Frames

To save a copy of a selected frame as a JPEG still:

1 View the movie and choose a frame.

Play the movie back as described on page 62. Pause the movie at the frame you intend to copy.



2 Display the retouch menu.

Press **?**/**o** to display the retouch menu.

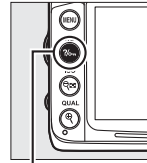

?/o button

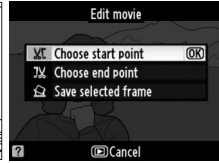

3 Choose Save selected frame.

Highlight **Save selected frame** and press **OK**.



4 Create a still copy.

Press **▲** to create a still copy of the current frame.



5 Save the copy.

Highlight **Yes** and press **OK** to create a JPEG copy of the selected frame. Movie stills are indicated by a  icon in full-frame playback.

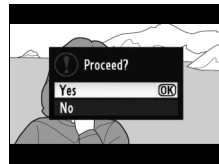

Save Selected Frame

JPEG movie stills created with the **Save selected frame** option can not be retouched. JPEG movie stills lack some categories of photo information (📷 165).

P, S, A, and M Modes

P, S, A, and M modes offer different degrees of control over shutter speed and aperture:



Mode	Description
P	Programmed auto (☐ 68): Camera sets shutter speed and aperture for optimal exposure. Recommended for snapshots and in other situations in which there is little time to adjust camera settings.
S	Shutter-priority auto (☐ 69): User chooses shutter speed; camera selects aperture for best results. Use to freeze or blur motion.
A	Aperture-priority auto (☐ 70): User chooses aperture; camera selects shutter speed for best results. Use to blur background or bring both foreground and background into focus.
M	Manual (☐ 71): User controls both shutter speed and aperture. Set shutter speed to “bulb” or “time” for long time-exposures.

🔍 Lens Types

When using a CPU lens equipped with an aperture ring (☐ 269), lock the aperture ring at the minimum aperture (highest f-number). Type G lenses are not equipped with an aperture ring.

Non-CPU lenses can only be used in modes **A** (aperture-priority auto) and **M** (manual), when aperture can only be adjusted using the lens aperture ring. Selecting any other mode disables the shutter release.

🔍 Shutter Speed and Aperture

The same exposure can be achieved with different combinations of shutter speed and aperture. Fast shutter speeds and large apertures freeze moving objects and soften background details, while slow shutter speeds and small apertures blur moving objects and bring out background details.

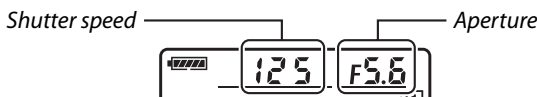

Fast shutter speed
($1/1,600$ s)



Slow shutter speed
(1 s)



Large aperture (f/3)



Small aperture (f/36)

(Remember, the higher the f-number, the smaller the aperture.)

Mode P (Programmed Auto)

In this mode, the camera automatically adjusts shutter speed and aperture for optimal exposure in most situations. This mode is recommended for snapshots and other situations in which you want to leave the camera in charge of shutter speed and aperture. To take photographs in programmed auto:

1 Rotate the mode dial to P.

Mode dial

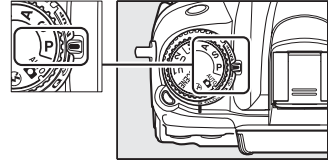

2 Frame a photograph, focus, and shoot.

Flexible Program

In mode P, different combinations of shutter speed and aperture can be selected by rotating the main command dial while the exposure meters are on ("flexible program"). Rotate the dial to the right for large apertures (low f-numbers) that blur background details or fast shutter speeds that "freeze" motion.

Rotate the dial to the left for small apertures (high f-numbers) that increase depth of field or slow shutter speeds that blur motion. All combinations produce the same exposure. While flexible program is in effect, a  indicator appears in the control panel. To restore default shutter speed and aperture settings, rotate the main command dial until the indicator is no longer displayed, choose another mode, or turn the camera off.

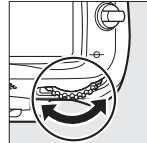

Main command dial

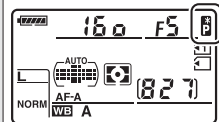

See Also

See page 298 for information on the built-in exposure program. For information on activating the exposure meters, see "Auto-Meter Off" on page 39.

Mode S (Shutter-Priority Auto)

In shutter-priority auto, you choose the shutter speed while the camera automatically selects the aperture that will produce the optimal exposure. Use slow shutter speeds to suggest motion by blurring moving subjects, fast shutter speeds to “freeze” motion.



Fast shutter speed ($1/1,600$ s)



Slow shutter speed ($1/6$ s)

To take photographs in shutter-priority auto:

1 Rotate the mode dial to S.

Mode dial

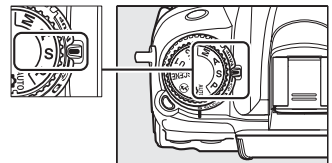

PS
AM

2 Choose a shutter speed.

While the exposure meters are on, rotate the main command dial to choose the desired shutter speed from “x 250” or values between 30 s and $1/8,000$ s.



Main command dial

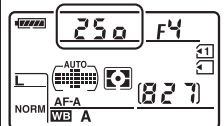

3 Frame a photograph, focus, and shoot.

See Also

See page 306 for information on what to do if flashing “bulb” or “- -” indicator appears in the shutter-speed displays.

Mode A (Aperture-Priority Auto)

In aperture-priority auto, you choose the aperture while the camera automatically selects the shutter speed that will produce the optimal exposure. Large apertures (low f-numbers) reduce depth of field, blurring objects behind and in front of the main subject. Small apertures (high f-numbers) increase depth of field, bringing out details in the background and foreground. Short field depths are generally used in portraits to blur background details, long field depths in landscape photographs to bring the foreground and background into focus.



Large aperture (f/2.8)



Small aperture (f/36)

To take photographs in aperture-priority auto:

1 Rotate the mode dial to A.

Mode dial

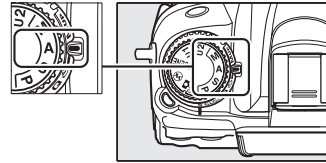

2 Choose an aperture.

While the exposure meters are on, rotate the sub-command dial to choose the desired aperture from values between the minimum and maximum for the lens.



Sub-command dial

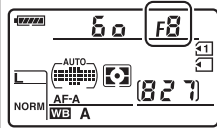

3 Frame a photograph, focus, and shoot.

Non-CPU Lenses (270)

Use the lens aperture ring to adjust aperture. If the maximum aperture of the lens has been specified using the **Non-CPU lens data** item in setup menu (159) when a non-CPU lens is attached, the current f-number will be displayed in the viewfinder and control panel, rounded to the nearest full stop. Otherwise the aperture displays will show only the number of stops (ΔF , with maximum aperture displayed as $\Delta F0$) and the f-number must be read from the lens aperture ring.

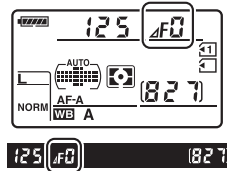

Mode M (Manual)

In mode M, you control both shutter speed and aperture. To take photographs in mode M:

1 Rotate the mode dial to M.

Mode dial

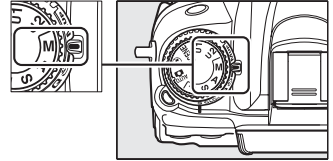

2 Choose aperture and shutter speed.

While the exposure meters are on, rotate the main command dial to choose a shutter speed, and the sub-command dial to set aperture. Shutter speed can be set to "x 250" or to values between 30 s and 1/8,000 s, or the shutter can be held open indefinitely for a long time-exposure (bulb, □ 73). Aperture can be set to values between the minimum and maximum for the lens. Use the exposure indicators to check exposure.

PS
AM

Shutter speed

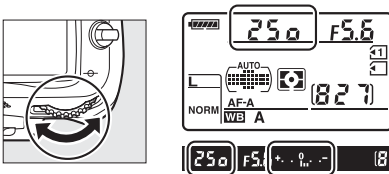

Main command dial

Aperture

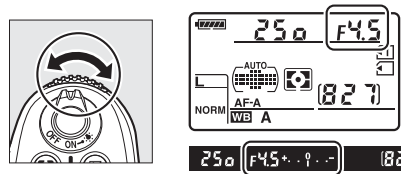

Sub-command dial

3 Frame a photograph, focus, and shoot.

Depth-of-Field Preview

To preview the effects of aperture, press and hold the depth-of-field preview button. The lens will be stopped down to the aperture value selected by the camera (modes **P** and **S**) or the value chosen by the user (modes **A** and **M**), allowing depth of field to be previewed in the viewfinder.

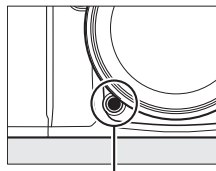

Depth-of-field preview button

Custom Setting e4—Modeling Flash

This setting controls whether the built-in flash and optional flash units that support the Creative Lighting System (CLS; see page 276) will emit a modeling flash when the depth-of-field preview button is pressed. See page 228 for more information.

AF Micro NIKKOR Lenses



Provided that an external exposure meter is used, the exposure ratio need only be taken into account when the lens aperture ring is used to set aperture.

The Exposure Indicator

If a shutter speed other than “bulb” or “time” is selected, the exposure indicator in the viewfinder shows whether the photograph would be under- or over-exposed at current settings (if **Lo** or **Hi** is displayed, the indicators show the amount of under- or over-exposure). Depending on the option chosen for Custom Setting b2 (**EV steps for exposure ctrl.**,  211), the amount of under- or over-exposure is shown in increments of $\frac{1}{3}$ EV or $\frac{1}{2}$ EV (the illustrations below show the display in the viewfinder when **1/3 step** is selected for Custom Setting b2). If the limits of the exposure metering system are exceeded, the displays will flash.

Optimal exposure	Underexposed by $\frac{1}{3}$ EV	Overexposed by over 2 EV
+ . . 0 . . -	+ . . 0 . . -	+ . . 0 . . -

Reverse Indicators

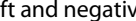
If  (+0-) is selected for Custom Setting f9 (**Reverse indicators**,  234), the exposure indicators in the viewfinder and information display are displayed with positive values on the left and negative values on the right. Select  (-0+) to display negative values on the left and positive values on the right.

■ Long Time-Exposures (M Mode Only)

Select the following shutter speeds for long time-exposures of moving lights, the stars, night scenery, or fireworks.



35 s exposure
at aperture
f/25

- **Bulb (b u l b):** The shutter remains open while the shutter-release button is held down. To prevent blur, use a tripod or an optional MC-DC2 remote cord (□ 281).
- **Time (- -):** Requires an optional ML-L3 remote control (□ 281). Start the exposure by pressing the ML-L3 shutter-release button. The shutter remains open for thirty minutes or until the button is pressed a second time.

1 Ready the camera.

Mount the camera on a tripod or place it on a stable, level surface. To avoid loss of power during the exposure, use a fully charged EN-EL15 battery or an optional EH-5a AC adapter and EP-5B power connector. Note that noise (randomly-spaced bright pixels or fog) may occur in long exposures; before shooting, choose **On** for **Long exp. NR** in the shooting menu (□ 205).



2 Rotate the mode dial to M.

Mode dial

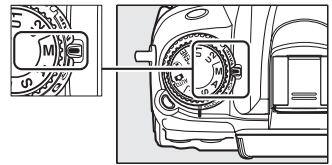

3 Choose a shutter speed.

While the exposure meters are on, rotate the main command dial to choose a shutter speed of **b u l b**. For a shutter speed of “time” (- -), select remote mode (□ 80) after choosing the shutter speed.

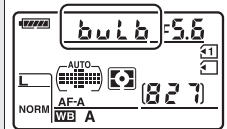

Main command dial

4 Open the shutter.

Bulb: After focusing, press the shutter-release button on the camera or optional MC-DC2 remote cord all the way down. Keep the shutter-release button pressed until the exposure is complete.

Time: Press the ML-L3 shutter-release button all the way down to start shooting.

5 Close the shutter.

Bulb: Take your finger off the shutter-release button.

Time: Press the ML-L3 shutter-release button all the way down. Shooting ends automatically after thirty minutes.



User Settings: U1 and U2 Modes

Assign frequently-used settings to the **U1** and **U2** positions on the mode dial.

Saving User Settings

1 Select a mode.

Rotate the mode dial to the desired mode.

Mode dial

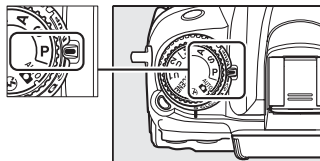

2 Adjust settings.

Make the desired adjustments to flexible program (mode **P**), shutter speed (modes **S** and **M**), aperture (modes **A** and **M**), exposure and flash compensation, flash mode, focus point, metering, AF and AF-area modes (viewfinder photography only), bracketing, and settings in the shooting (📖 202) and Custom Settings (📖 206) menus (note that the camera will not store the options selected for **Storage folder**, **File naming**, **Manage Picture Control**, **Multiple exposure**, or **Interval timer shooting**).

3 Select Save user settings.

Press the **MENU** button to display the menus. Highlight **Save user settings** in the setup menu and press ▶.

MENU button

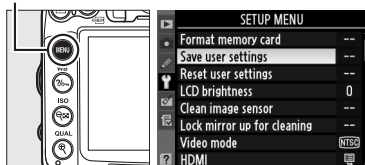

4 Select U1 or U2.

Highlight **U1** or **U2** and press ▶.

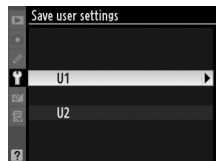

5 Save user settings.

Highlight **Save settings** and press **OK** to assign the settings selected in Steps 1 and 2 to the mode dial position selected in Step 4.

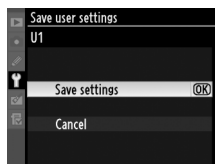

Recalling User Settings

Simply rotate the mode dial to **U1** to recall the settings assigned to **U1**, or to **U2** to recall the settings assigned to **U2**.

Mode dial

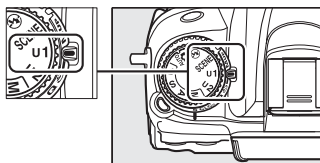

Resetting User Settings

To reset settings for **U1** or **U2** to default values:

1 Select Reset user settings.

Press the **MENU** button to display the menus. Highlight **Reset user settings** in the setup menu and press **▶**.

MENU button

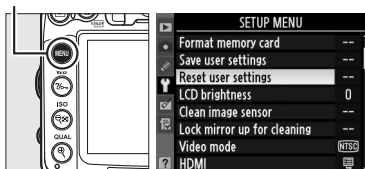

2 Select U1 or U2.

Highlight **U1** or **U2** and press **▶**.

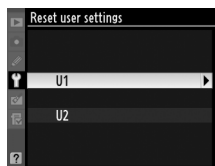

3 Reset user settings.

Highlight **Reset** and press **OK**.

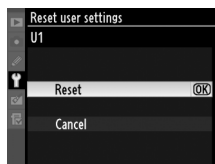



Release Mode

Choosing a Release Mode

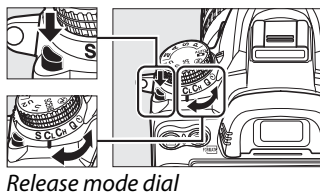
To choose a release mode, press the release mode dial lock release and turn the release mode dial to the desired setting.



Mode	Description
S	Single frame: Camera takes one photograph each time shutter-release button is pressed.
CL	Continuous low speed: While shutter-release button is held down, camera records 1–5 frames per second. ¹ Frame rate can be chosen using Custom Setting d6 (CL mode shooting speed , □ 217).
CH	Continuous high speed: While shutter-release button is held down, camera records up to 6 frames per second. ²
Q	Quiet shutter-release: As for single frame, except that mirror does not click back into place while shutter-release button is fully pressed, allowing user to control timing of click made by mirror, which is also quieter than in single frame mode. In addition, beep does not sound regardless of setting selected for Custom Setting d1 (Beep ; □ 215).
	Self-timer: Use self-timer for self-portraits or to reduce blurring caused by camera shake (□ 80).
	Remote control: Shutter is controlled using shutter-release button on optional ML-L3 remote control (□ 80).
MUP	Mirror up: Choose this mode to minimize camera shake in telephoto or close-up photography or in other situations in which the slightest camera movement can result in blurred photographs (□ 83).

- 1 Average frame rate with an EN-EL15 battery, continuous-servo AF, manual or shutter-priority auto exposure, a shutter speed of $1/250$ s or faster, remaining settings other than Custom Setting d6 at default values, and memory remaining in memory buffer.
- 2 Average frame rate with an EN-EL15 battery, continuous-servo AF, manual or shutter-priority auto exposure, a shutter speed of $1/250$ s or faster, other settings at default values, and memory remaining in memory buffer.

Continuous Mode (CH/CL)

To take pictures in **CH** (continuous high speed) and **CL** (continuous low speed) modes:

1 Select CH or CL mode.

Press the release mode dial lock release and turn the release mode dial to **CH** or **CL**.

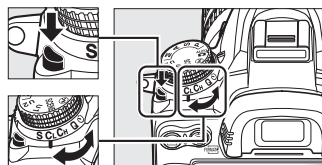

Release mode dial

2 Frame a photograph, focus, and shoot.

While the shutter-release button is pressed all the way down, pictures will be taken at about 6 fps in continuous high speed mode, or at the frame rate selected for Custom Setting d6 (**CL mode shooting speed**,  217) in continuous low speed mode. Frame rates may slow when the battery is low.



The Memory Buffer

The camera is equipped with a memory buffer for temporary storage, allowing shooting to continue while photographs are being saved to the memory card. Up to 100 photographs can be taken in succession; note, however, that frame rate will drop when the buffer is full.

While photographs are being recorded to the memory card, the access lamp next to the memory card slot will light. Depending on shooting conditions and memory card performance, recording may take from a few seconds to a few minutes. *Do not remove the memory card or remove or disconnect the power source until the access lamp has gone out.* If the camera is switched off while data remain in the buffer, the power will not turn off until all images in the buffer have been recorded. If the battery is exhausted while images remain in the buffer, the shutter release will be disabled and the images transferred to the memory card.

Buffer Size

The approximate number of images that can be stored in the memory buffer at current settings is shown in the exposure-count displays in the viewfinder and control panel while the shutter-release button is pressed. The illustration at right shows the display when space remains in the buffer for about 28 pictures.

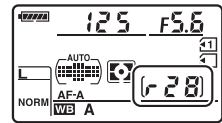

See Also

For information on choosing the maximum number of photographs that can be taken in a single burst, see Custom Setting d7 (**Max. continuous release**,  217). For information on the number of pictures that can be taken in a single burst, see page 320.



Self-Timer and Remote Modes

The self-timer and optional ML-L3 remote control (☐ 281) can be used to reduce camera shake or for self-portraits.

1 Mount the camera on a tripod.

Mount the camera on a tripod or place the camera on a stable, level surface.

2 Select a release mode.

Press the release mode dial lock release and rotate the release-mode dial to ☺ (self-timer) or ☐ (remote) mode.

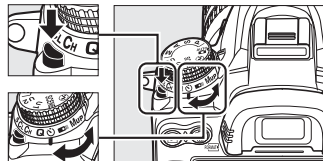

Release mode dial

In remote mode, the timing of the shutter release can be selected using the **Remote control mode** option in the shooting menu. After pressing the MENU button to display the menus, highlight **Remote control mode** in the shooting menu and press ► to display the following menu and press ► to display the following options. Press the selector up or down to highlight an option and press OK.

MENU button

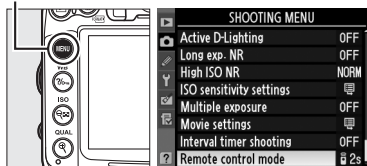

Option	Description
☐ 2s Delayed remote	Shutter is released 2 s after ML-L3 shutter-release button is pressed.
☐ Quick-response remote	Shutter is released when ML-L3 shutter-release button is pressed.
☐ Mirr Remote mirror-up	Press ML-L3 shutter-release button once to raise mirror, again to release shutter and take photograph. Prevents blur caused by camera moving when mirror is raised.

3 Frame the photograph.

Cover the Viewfinder

When taking photos without your eye to the viewfinder, remove the DK-21 rubber eyecup (①) and insert the supplied DK-5 eyepiece cap as shown (②). This prevents light entering via the viewfinder interfering with exposure. Hold the camera firmly when removing the rubber eyecup.

DK-21 rubber eyecup

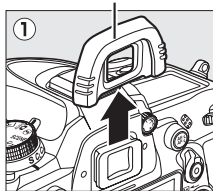

DK-5 eyepiece cap

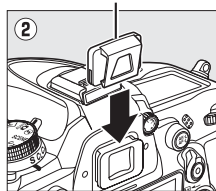

4 Take the photograph.

Self-timer mode: Press the shutter-release button halfway to focus, and then press the button the rest of the way down to start the self-timer (note that the timer will not start if the camera is unable to focus or in other situations in which the shutter can not be released). The self-timer lamp will start to blink. Two seconds before the photograph is taken, the self-timer lamp will stop blinking. The shutter will be released ten seconds after the timer starts.



Remote control mode: From a distance of 5 m (16 ft.) or less, aim the transmitter on the ML-L3 at either of the infrared receivers on the camera (☐ 3, 5) and press the ML-L3 shutter-release button. *In delayed remote mode*, the self-timer lamp will light for about two seconds before the shutter is released. *In quick-response remote mode*, the self-timer lamp will flash after the shutter has been released. *In remote mirror-up mode*, pressing the ML-L3 shutter-release button once raises the mirror; the shutter will be released and the self-timer lamp will flash after 30 s or when the button is pressed a second time.

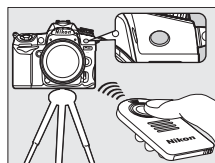



To cancel shooting, select another release mode.

✔ Before Using the Remote Control

Before using the remote control for the first time, remove the clear plastic battery-insulator sheet.

✔ Using the Built-in Flash

Before taking a photograph with the flash in **P**, **S**, **A**, **M**, or **Hi** modes, press the  button to raise the flash and wait for the  indicator to be displayed in the viewfinder (□ 143). Shooting will be interrupted if the flash is raised while remote control mode is in effect or after the self-timer has started. If the flash is required, the camera will only respond to the ML-L3 shutter-release button once the flash has charged. In auto or scene modes in which the flash pops up automatically, the flash will begin charging when remote mode is selected; once the flash is charged, it will automatically pop up and fire when required. Note that only one photograph will be taken when the flash fires, regardless of the number of exposures selected for Custom Setting c3 (**Self-timer**; □ 214).

In flash modes that support red-eye reduction, the red-eye reduction lamp will light for about one second before the shutter is released. In delayed remote mode, the self-timer lamp will light for two seconds, followed by the red-eye reduction lamp which light for one second before the shutter is released.

✍ Focusing in Remote Control Mode

The camera will not adjust focus in remote mirror-up mode or when continuous-servo autofocus is selected; note however that if any autofocus mode is selected, you can focus by pressing the camera shutter-release button halfway before shooting (pressing the button all the way down will not release the shutter). If auto- or single-servo autofocus is selected or the camera is in live view in delayed or quick-response remote mode, the camera will automatically adjust focus before shooting; if the camera is unable to focus in viewfinder photography, it will return to stand-by without releasing the shutter.

✍ Remote Mirror-up Mode

Metering is not performed in remote mirror-up mode. Photos can not be framed in the viewfinder while the mirror is raised.

✍

In self-timer mode, a shutter speed of    is equivalent to approximately ¼ s.

✍ See Also

For information on choosing the duration of the self-timer, the number of shots taken, and the interval between shots, see Custom Setting c3 (**Self-timer**; □ 214). For information on choosing the length of time the camera will remain in stand-by mode waiting for a signal from the remote control, see Custom Setting c5 (**Remote on duration**; □ 215). For information on controlling the beeps that sound when the self-timer and remote control are used, see Custom Setting d1 (**Beep**; □ 215).

Mirror up Mode

Choose this mode to minimize blurring caused by camera movement when the mirror is raised. Use of a tripod is recommended.

1 Select mirror up mode.

Press the release mode dial lock release and rotate the release mode dial to **MUP**.

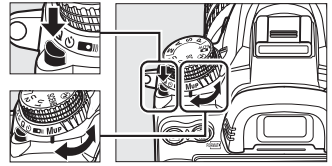

Release mode dial

2 Raise the mirror.

Frame the picture, focus, and then press the shutter-release button the rest of the way down to raise the mirror.



Mirror Up

While the mirror is raised, photos can not be framed in the viewfinder and autofocus and metering will not be performed.

3 Take a picture.

Press the shutter-release button all the way down again to take a picture. To prevent blurring caused by camera movement, press the shutter-release button smoothly, or use an optional remote cord (□ 281). The mirror lowers when shooting ends.



Mirror up Mode

A picture will be taken automatically if no operations are performed for about 30 s after the mirror is raised.

See Also

For information on using the optional ML-L3 remote control for mirror-up photography, see page 80.







Image Recording Options

Image Quality and Size

Together, image quality and size determine how much space each photograph occupies on the memory card. Larger, higher quality images can be printed at larger sizes but also require more memory, meaning that fewer such images can be stored on the memory card (□ 320).

Image Quality

Choose a file format and compression ratio (image quality).

Option	File type	Description
NEF (RAW)	NEF	Raw data from the image sensor are saved directly to the memory card. Settings such as white balance and contrast can be adjusted on a computer after shooting.
JPEG fine	JPEG	Record JPEG images at a compression ratio of roughly 1:4 (fine quality).*
JPEG normal		Record JPEG images at a compression ratio of roughly 1:8 (normal quality).*
JPEG basic		Record JPEG images at a compression ratio of roughly 1:16 (basic quality).*
NEF (RAW)+ JPEG fine	NEF/ JPEG	Two images are recorded, one NEF (RAW) image and one fine-quality JPEG image.
NEF (RAW)+ JPEG normal		Two images are recorded, one NEF (RAW) image and one normal-quality JPEG image.
NEF (RAW)+ JPEG basic		Two images are recorded, one NEF (RAW) image and one basic-quality JPEG image.

* **Size priority** selected for **JPEG compression**.



Image quality is set by pressing the **QUAL** button and rotating the main command dial until the desired setting is displayed in the control panel.

The Shooting Menu

Image quality can also be adjusted using the **Image quality** option in the shooting menu (📖 202).

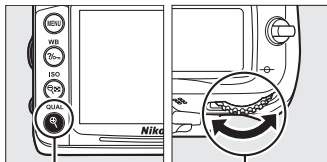
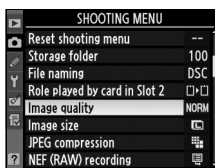

QUAL button *Main command dial*





Control panel

The following options can be accessed from the shooting menu. Press the **MENU** button to display the menus, highlight the desired option and press **▶**.



■ ■ **JPEG Compression**

Choose the type of compression for JPEG images.

Option	Description
 Size priority	Images are compressed to produce relatively uniform file size.
 Optimal quality	Optimal image quality. File size varies with scene recorded.

■ ■ **NEF (RAW) Recording > Type**

Choose the type of compression for NEF (RAW) images.

Option	Description
ON  Lossless compressed	NEF images are compressed using a reversible algorithm, reducing file size by about 20–40% with no effect on image quality.
ON  Compressed	NEF images are compressed using a non-reversible algorithm, reducing file size by about 40–55% with almost no effect on image quality.

■ ■ **NEF (RAW) Recording > NEF (RAW) Bit Depth**

Choose a bit depth for NEF (RAW) images.

Option	Description
12-bit 12-bit	NEF (RAW) images are recorded at a bit-depth of 12 bits.
14-bit 14-bit	NEF (RAW) images are recorded at a bit-depth of 14 bits, producing larger files but increasing the color data recorded.

NEF (RAW) Images

NEF (RAW) images can be viewed on the camera or using software such as Capture NX 2 (available separately; □ 281) or ViewNX 2 (available on the supplied ViewNX 2 CD). JPEG copies of NEF (RAW) images can be created using the **NEF (RAW) processing** option in the retouch menu (□ 258). Note that the option selected for image size does not affect the size of NEF (RAW) images.



NEF+JPEG

When photographs taken at settings of NEF (RAW) + JPEG are viewed on the camera with only one memory card inserted, only the JPEG image will be displayed. If both copies are recorded to the same memory card, both copies will be erased when the photo is deleted. If the JPEG copy is recorded to a separate memory card using the **Role played by card in Slot 2 > RAW Slot 1—JPEG Slot 2** option, deleting the JPEG copy will not delete the NEF (RAW) image.



Image Size

Image size is measured in pixels. Choose from the following options:

Image size	Size (pixels)	Print size (cm/in.)*
 Large	4,928 × 3,264	41.7 × 27.6/16.4 × 10.9
 Medium	3,696 × 2,448	31.3 × 20.7/12.3 × 8.2
 Small	2,464 × 1,632	20.9 × 13.8/8.2 × 5.4

* Approximate size when printed at 300 dpi. Print size in inches equals image size in pixels divided by printer resolution in dots per inch (dpi; 1 inch=approximately 2.54 cm).

Image size is set by pressing the **QUAL** button and rotating the sub-command dial until the desired setting is displayed in the control panel.

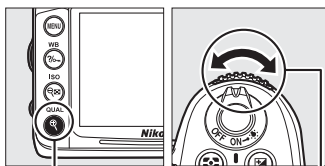

QUAL button Sub-command dial

The Shooting Menu

Image size can also be adjusted using the **Image size** option in the shooting menu (☐ 202).

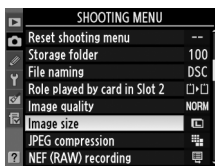

Control panel

Using Two Memory Cards

When two memory cards are inserted in the camera, you can use the **Role played by card in Slot 2** item in the shooting menu to choose the role played by the card in Slot 2. Choose from **Overflow** (the card in Slot 2 is used only when the card in Slot 1 is full), **Backup** (each picture is recorded twice, once to the card in Slot 1 and again to the card in Slot 2), and **RAW Slot 1—JPEG Slot 2** (as for **Backup**, except that the NEF/RAW copies of photos recorded at settings of NEF/RAW + JPEG are recorded only to the card in Slot 1 and the JPEG copies only to the card in Slot 2).

“Backup” and “RAW Slot 1—JPEG Slot 2”

The camera shows the number of exposures remaining on the card with the least amount of memory. Shutter release will be disabled when either card is full.

Recording Movies

When two memory cards are inserted in the camera, the slot used to record movies can be selected using the **Movie settings > Destination** option in the shooting menu (📖 60).





Focus

This section describes the focus options available when photographs are framed in the viewfinder. Focus can be adjusted automatically (see below) or manually (□ 99). The user can also select the focus point for automatic or manual focus (□ 96) or use focus lock to focus to recompose photographs after focusing (□ 97).

Autofocus

To use autofocus, rotate the focus-mode selector to **AF**.

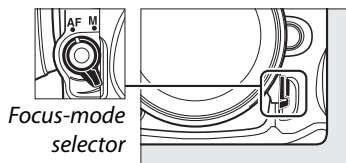

Autofocus Mode

Choose from the following autofocus modes:

Mode	Description
AF-A	Auto-servo AF: Camera automatically selects single-servo autofocus if subject is stationary, continuous-servo autofocus if subject is moving.
AF-S	Single-servo AF: For stationary subjects. Focus locks when shutter-release button is pressed halfway. At default settings, shutter can only be released when in-focus indicator is displayed (<i>focus priority</i> ; □ 208).
AF-C	Continuous-servo AF: For moving subjects. Camera focuses continuously while shutter-release button is pressed halfway; if subject moves, camera will engage <i>predictive focus tracking</i> (□ 93) to predict final distance to subject and adjust focus as necessary. At default settings, shutter can be released whether or not subject is in focus (<i>release priority</i> ; □ 208).



To select the autofocus mode, press the AF-mode button and rotate the main command dial until the desired setting is displayed in the viewfinder or control panel.

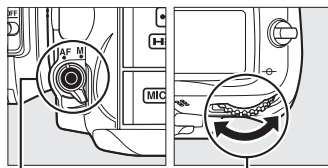

AF-mode button

Main command dial

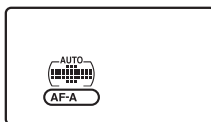

Control panel



Viewfinder



Predictive Focus Tracking

In **AF-C** mode or when continuous-servo autofocus is selected in **AF-A** mode, the camera will initiate predictive focus tracking if the subject moves toward or away from the camera while the shutter-release button is pressed halfway. This allows the camera to track focus while attempting to predict where the subject will be when the shutter is released.

Getting Good Results with Autofocus

Autofocus does not perform well under the conditions listed below. The shutter release may be disabled if the camera is unable to focus under these conditions, or the in-focus indicator (●) may be displayed and the camera may sound a beep, allowing the shutter to be released even when the subject is not in focus. In these cases, focus manually (□ 99) or use focus lock (□ 97) to focus on another subject at the same distance and then recompose the photograph.

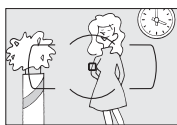

There is little or no contrast between the subject and the background.

Example: Subject is the same color as the background.

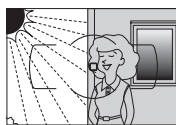

The focus point contains areas of sharply contrasting brightness.

Example: Subject is half in the shade.



The focus point contains objects at different distances from the camera.

Example: Subject is inside a cage.

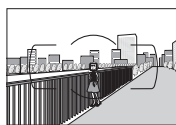

Background objects appear larger than the subject.

Example: A building is in the frame behind the subject.



The subject is dominated by regular geometric patterns.

Example: Blinds or a row of windows in a skyscraper.

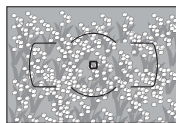

The subject contains many fine details.

Example: A field of flowers or other subjects that are small or lack variation in brightness.

See Also

For information on using focus priority in continuous-servo AF, see Custom Setting a1 (**AF-C priority selection**, □ 208). For information on using release priority in single-servo AF, see Custom Setting a2 (**AF-S priority selection**, □ 208). See page 50 for information on the autofocus options available in live view or during movie recording.



AF-Area Mode

Choose how the focus point for autofocus is selected.

- **Single-point AF:** Select the focus point as described on page 96; the camera will focus on the subject in the selected focus point only. Use with stationary subjects.
- **Dynamic-area AF:** Select the focus point as described on page 96. In **AF-A** and **AF-C** focus modes, the camera will focus based on information from surrounding focus points if the subject briefly leaves the selected point. The number of focus points varies with the mode selected:
 - **9-point dynamic-area AF:** Choose when there is time to compose the photograph or when photographing subjects that are moving predictably (e.g., runners or race cars on a track).
 - **21-point dynamic-area AF:** Choose when photographing subjects that are moving unpredictably (e.g., players at a football game).
 - **39-point dynamic-area AF:** Choose when photographing subjects that are moving quickly and can not be easily framed in the viewfinder (e.g., birds).
- **3D-tracking:** Select the focus point as described on page 96. In **AF-A** and **AF-C** focus modes, the camera will track subjects that leave the selected focus point and select new focus points as required. Use to quickly compose pictures with subjects that are moving erratically from side to side (e.g., tennis players). If the subject leaves viewfinder, remove your finger from the shutter-release button and recompose the photograph with the subject in the selected focus point.

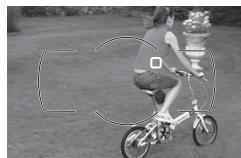
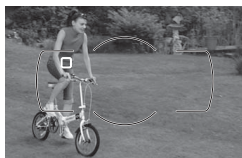

3D-tracking

When the shutter-release button is pressed halfway, the colors in the area surrounding the focus point are stored in the camera. Consequently 3D-tracking may not produce the desired results with subjects that are the same color as the background or that occupy a very small area of the frame.

- **Auto-area AF:** The camera automatically detects the subject and selects the focus point. If a type G or D lens is used, the camera can distinguish human subjects from the background for improved subject detection. The active focus points are highlighted briefly after the camera focuses; in **AF-C** mode or when continuous-servo autofocus is selected in **AF-A** mode, the main focus point remains highlighted after the other focus points have turned off.

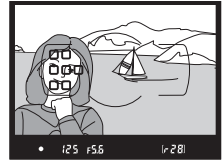

To select the AF-area mode, press the AF-mode button and rotate the sub-command dial until the desired setting is displayed in the viewfinder or control panel.

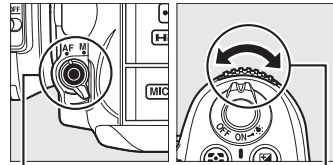

AF-mode button

Sub-command dial

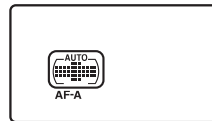

Control panel

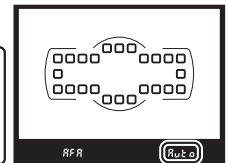

Viewfinder

AF-Area Mode

AF-area mode is shown in the control panel and viewfinder.

AF-area mode	Control panel	Viewfinder	AF-area mode	Control panel	Viewfinder
Single-point AF	(.)	S	39-point dynamic-area AF*	([grid])	d39
9-point dynamic-area AF*	([grid])	d9	3D-tracking*	([grid]) 3D	3d
21-point dynamic-area AF*	([grid])	d21	Auto-area AF	([grid]) AUTO	RuLo

* Only active focus point is displayed in the viewfinder. Remaining focus points provide information to assist focus operation.

Manual Focus

Single-point AF is automatically selected when manual focus is used.

See Also

For information on adjusting how long the camera waits before refocusing when an object moves in front of the camera, see Custom Setting a3 (**Focus tracking with lock-on**, 209). See page 50 for information on the autofocus options available in live view or during movie recording.



Focus Point Selection

The camera offers a choice of 39 focus points that can be used to compose photographs with the main subject positioned almost anywhere in the frame.

1 Rotate the focus selector lock to ●.

This allows the multi selector to be used to select the focus point.

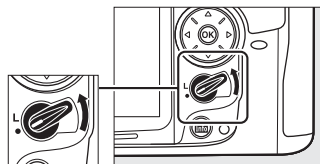

Focus selector lock

2 Select the focus point.

Use the multi selector to select the focus point in the viewfinder while the exposure meters are on. Press **OK** to select the center focus point.

The focus selector lock can be rotated to the locked (L) position following selection to prevent the selected focus point from changing when the multi selector is pressed.

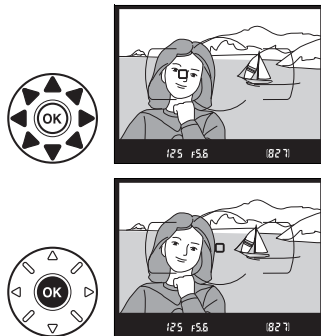

Auto-area AF

The focus point for auto-area AF is selected automatically; manual focus-point selection is not available.

See Also

For information on choosing when the focus point is illuminated, see Custom Setting a4 (**AF point illumination**, □ 209). For information on setting focus-point selection to “wrap around,” see Custom Setting a5 (**Focus point wrap-around**, □ 209). For information on choosing the number of focus points that can be selected using the multi selector, see Custom Setting a6 (**Number of focus points**, □ 210). For information on changing the role of the **OK** button, see Custom Setting f2, **OK button (shooting mode)**; □ 229.

Focus Lock

Focus lock can be used to change the composition after focusing, making it possible to focus on a subject that will not be in a focus point in the final composition. If the camera is unable to focus using autofocus (□ 93), focus lock can also be used to recompose the photograph after focusing on another object at the same distance as your original subject. Focus lock is most effective when an option other than auto-area AF is selected for AF-area mode (□ 94).

1 Focus.

Position the subject in the selected focus point and press the shutter-release button halfway to initiate focus. Check that the in-focus indicator (●) appears in the viewfinder.

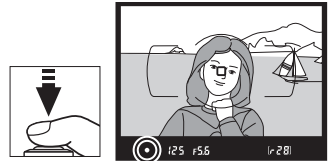

2 Lock focus.

AF-A and AF-C focus modes: With the shutter-release button pressed halfway (①), press the **AE-L/AF-L** button (②) to lock both focus and exposure (an **AE-L** icon will be displayed in the viewfinder). Focus will remain locked while the **AE-L/AF-L** button is pressed, even if you later remove your finger from the shutter-release button.

AF-S focus mode: Focus will lock automatically when the in-focus indicator appears, and remain locked until you remove your finger from the shutter-release button. Focus can also be locked by pressing the **AE-L/AF-L** button (see above).

Shutter-release button

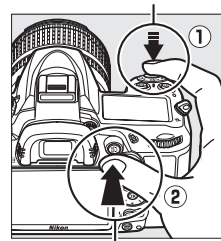

AE-L/AF-L button



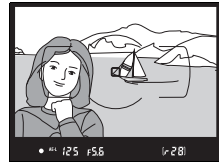

3 Recompose the photograph and shoot.

Focus will remain locked between shots if you keep the shutter-release button pressed halfway (**AF-S**) or keep the **AE-L/AF-L** button pressed, allowing several photographs in succession to be taken at the same focus setting.



Do not change the distance between the camera and the subject while focus lock is in effect. If the subject moves, focus again at the new distance.

See Also

See Custom setting c1 (**Shutter-release button AE-L**,  213) for information on using the shutter-release button to lock exposure, Custom Setting f5 (**Assign AE-L/AF-L button**,  232) for information on choosing the role played by the **AE-L/AF-L** button.



Manual Focus

Manual focus is available for lenses that do not support autofocus (non-AF NIKKOR lenses) or when the autofocus does not produce the desired results (□ 93).

- **AF-S lenses:** Set the lens focus mode switch to **M**.

AF-S Lenses

Users of AF-S lenses (including the AF-S DX NIKKOR 18–105mm f/3.5–5.6G ED VR lens used in this manual for illustrative purposes; □ 315, 316) can select manual focus simply by setting the lens focus-mode switch to **M**.

- **AF lenses:** Set the lens focus mode switch (if present) and camera focus-mode selector to **M**.

AF Lenses

Do not use AF lenses with the lens focus mode switch set to **M** and the camera focus-mode selector set to **AF**. Failure to observe this precaution could damage the camera.

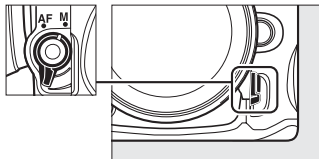

- **Manual focus lenses:** Set the camera focus-mode selector to **M**.

To focus manually, adjust the lens focus ring until the image displayed on the clear matte field in the viewfinder is in focus. Photographs can be taken at any time, even when the image is not in focus.

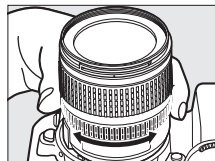

■ ■ The Electronic Rangefinder

If the lens has a maximum aperture of $f/5.6$ or faster, the viewfinder focus indicator can be used to confirm whether the subject in the selected focus point is in focus (the focus point can be selected from any of the 39 focus points). After positioning the subject in the selected focus point, press the shutter-release button halfway and rotate the lens focus ring until the in-focus indicator (●) is displayed. Note that with the subjects listed on page 93, the in-focus indicator may sometimes be displayed when the subject is not in focus; confirm focus in the viewfinder before shooting.

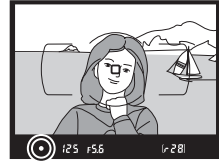
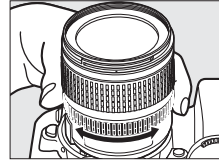

Focal Plane Position

To determine the distance between your subject and the camera, measure from the focal plane mark on the camera body. The distance between the lens mounting flange and the focal plane is 46.5 mm (1.83 in.).

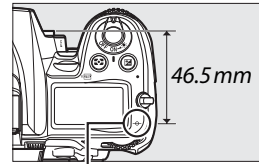

Focal plane mark



ISO Sensitivity

“ISO sensitivity” is the digital equivalent of film speed. Choose from settings that range from a value roughly equivalent to ISO 100 to one roughly equivalent to ISO 6400 in steps equivalent to $\frac{1}{3}$ EV. For special situations, ISO sensitivity can be raised above ISO 6400 by from about 0.3 EV (Hi 0.3, equivalent to ISO 8000) to about 2 EV (Hi 2, equivalent to ISO 25600). Auto and scene modes also offer an **AUTO** option, which allows the camera to set ISO sensitivity automatically in response to lighting conditions. The higher the ISO sensitivity, the less light needed to make an exposure, allowing higher shutter speeds or smaller apertures.

ISO sensitivity can be adjusted by pressing the **ISO** button and rotating the main command dial until the desired setting is displayed in the control panel or viewfinder.

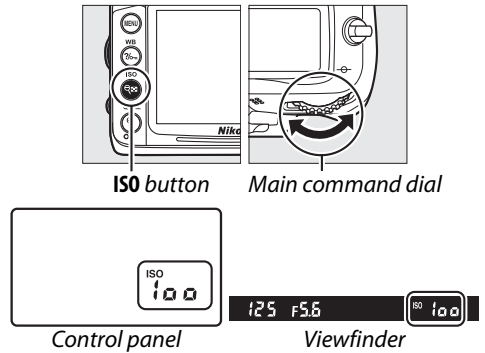

AUTO

If the mode dial is rotated to **P**, **S**, **A**, or **M** after **AUTO** is selected for ISO sensitivity in another mode, the ISO sensitivity last selected in **P**, **S**, **A**, or **M** mode will be restored.

Hi 0.3–Hi 2

Pictures taken at these settings are more likely to be subject to noise (randomly-spaced bright pixels, fog, or lines).

See Also

For information on choosing the ISO sensitivity step size, see Custom Setting b1 (**ISO sensitivity step value**;  211). For information on using the **High ISO NR** option in the shooting menu to reduce noise at high ISO sensitivities, see page 205.

The Shooting Menu

ISO sensitivity can also be adjusted using the **ISO sensitivity settings** option in the shooting menu ( 202).



Auto ISO Sensitivity Control (P, S, A, and M Modes Only)

If **On** is selected for **ISO sensitivity settings** > **Auto ISO sensitivity control** in the shooting menu, ISO sensitivity will automatically be adjusted if optimal exposure can not be achieved at the value selected by the user (ISO sensitivity is adjusted appropriately when the flash is used).

1 Select Auto ISO sensitivity control.

Press the **MENU** button and select **ISO sensitivity settings** in the shooting menu. Highlight **Auto ISO sensitivity control** and press **▶**.

MENU button

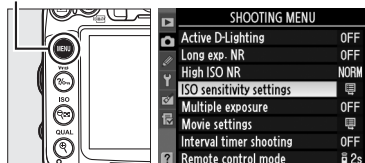

2 Select On.

Highlight **On** and press **OK** (if **Off** is selected, ISO sensitivity will remain fixed at the value selected by the user).

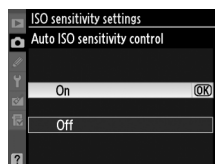

3 Adjust settings.

The maximum value for auto ISO sensitivity can be selected using **Maximum sensitivity** (choose lower values to prevent noise in the form of randomly-spaced bright pixels, fog, or lines); the minimum value for auto ISO sensitivity is automatically set to ISO 100.

In modes **P** and **A**, sensitivity will only be adjusted if underexposure would result at the shutter speed selected for **Minimum shutter speed** ($1/4000-1$ s; in modes **S** and **M**, sensitivity will be adjusted for optimal exposure at the shutter speed selected by the user). Slower shutter speeds will be used only if optimum exposure can not be achieved at the ISO sensitivity value selected for **Maximum sensitivity**. If the ISO sensitivity selected by the user is higher than the value selected for **Maximum sensitivity**, the value selected for **Maximum sensitivity** will be used instead.

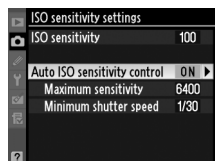

Press **OK** to exit when settings are complete. When **On** is selected, the display at right appears in the viewfinder and control panel. When sensitivity is altered from the value selected by the user, these indicators blink and the altered value is shown in the information display.

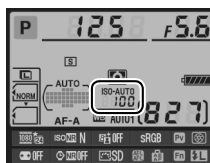
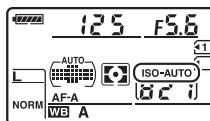

Auto ISO Sensitivity Control

Noise is more likely at higher sensitivities. Use the **High ISO NR** option in the shooting menu to reduce noise (see page 205). When a flash is used, the value selected for **Minimum shutter speed** is ignored in favor of the option selected for Custom Setting e1 (**Flash sync speed**,  222). Note that ISO sensitivity may be raised automatically when auto ISO sensitivity control is used in combination with slow sync flash modes (available with the built-in flash and SB-900, SB-800, SB-700, SB-600, and SB-400 flash units), possibly preventing the camera from selecting slow shutter speeds.





Exposure/Bracketing

Metering

(P, S, A, and M Modes Only)

Choose how the camera sets exposure in **P**, **S**, **A**, and **M** modes (in other modes, the camera selects the metering method automatically).

Option	Description
	Matrix: Produces natural results in most situations. Camera meters a wide area of the frame and set exposure according to tone distribution, color, composition, and, with type G or D lenses (☞ 269), distance information (3D color matrix metering II; with other CPU lenses, camera uses color matrix metering II, which does not include 3D distance information). With non-CPU lenses, camera uses color matrix metering if focal length and maximum aperture are specified using Non-CPU lens data option in setup menu (☞ 159); otherwise camera uses center-weighted metering.
	Center-weighted: Camera meters entire frame but assigns greatest weight to center area (if CPU lens is attached, size of area can be selected using Custom Setting b4, Center-weighted area , ☞ 213; if non-CPU lens is attached, area is 8 mm in diameter). Classic meter for portraits; recommended when using filters with an exposure factor (filter factor) over 1x.*
	Spot: Camera meters circle 3.5 mm (0.14 in.) in diameter (approximately 2.5% of frame). Circle is centered on current focus point, making it possible to meter off-center subjects (if non-CPU lens is used or if auto-area AF is in effect, camera will meter center focus point). Ensures that subject will be correctly exposed, even when background is much brighter or darker.*

* For improved precision with non-CPU lenses, specify lens focal length and maximum aperture in **Non-CPU lens data** menu (☞ 159).

To choose a metering option, press the  button and rotate the main command dial until the desired setting is displayed in the control panel.

See Also

For information on making separate adjustments to optimal exposure for each metering method, see Custom Setting b5 (**Fine tune optimal exposure**, ☞ 213).

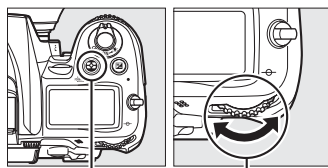

 button Main command dial





Control panel



Autoexposure Lock

Use autoexposure lock to recompose photographs after metering exposure:

1 Set metering to or (📖 105).

Choose  to assign the greatest weight to the center of frame, or  to set exposure for a 3.5-mm circle centered on the active focus point.  will not produce the desired results.

2 Lock exposure.

Position the subject in the selected focus point and press the shutter-release button halfway. With the shutter-release button pressed halfway and the subject positioned in the focus point, press the **AE-L/AF-L** button to lock focus and exposure (if you are using autofocus, confirm that the ● in-focus indicator appears in the viewfinder).

Shutter-release button

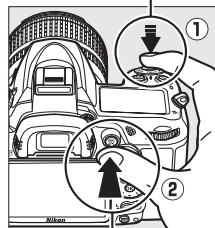

AE-L/AF-L button

While exposure lock is in effect, an **AE-L** indicator will appear in the viewfinder.



3 Recompose the photograph.

Keeping the **AE-L/AF-L** button pressed, recompose the photograph and shoot.

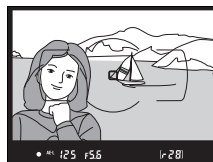

Adjusting Shutter Speed and Aperture

While exposure lock is in effect, the following settings can be adjusted without altering the metered value for exposure:

Mode	Setting
P	Shutter speed and aperture (flexible program; 📖 68)
S	Shutter speed
A	Aperture

The new values can be confirmed in the viewfinder and control panel. Note that metering can not be changed while exposure lock is in effect.

See Also

If **On** is selected for Custom Setting c1 (**Shutter-release button AE-L**, 📖 213), exposure will lock when the shutter-release button is pressed halfway. For information on changing the role of the **AE-L/AF-L** button, see Custom Setting f5 (**Assign AE-L/AF-L button**, 📖 232).

Exposure Compensation

(P, S, A, and M Modes Only)

Exposure compensation is used to alter exposure from the value suggested by the camera, making pictures brighter or darker. It is most effective when used with center-weighted or spot metering (☐ 105). Choose from values between -5 EV (underexposure) and $+5$ EV (overexposure) in increments of $1/3$ EV. In general, positive values make the subject brighter while negative values make it darker.



-1 EV



No exposure compensation



$+1$ EV

To choose a value for exposure compensation, press the  button and rotate the main command dial until the desired value is displayed in the control panel or viewfinder.

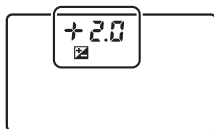
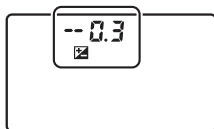
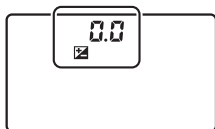

± 0 EV

( button pressed)





-0.3 EV

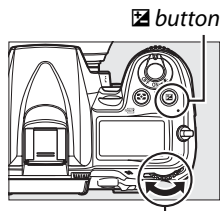

$+2.0$ EV



Main command dial

At values other than ± 0.0 , the 0 at the center of the exposure indicators will flash (modes P, S, and A only) and a  icon will be displayed in the control panel and viewfinder after you release the  button. The current value for exposure compensation can be confirmed in the exposure indicator by pressing the  button.

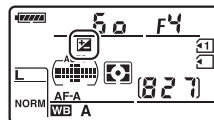

Normal exposure can be restored by setting exposure compensation to ± 0 . Exposure compensation is not reset when the camera is turned off.



Mode M

In mode **M**, exposure compensation affects only the exposure indicator; shutter speed and aperture do not change.

Using a Flash

When a flash is used, exposure compensation affects both background exposure and flash level.

See Also

For information on choosing the size of the increments available for exposure compensation, see Custom Setting b2 (**EV steps for exposure cntrl.**,  211). For information on making adjustments to exposure compensation without pressing the  button, see Custom Setting b3 (**Easy exposure compensation**,  212). For information on automatically varying exposure, flash level, white balance, or Active D-Lighting, see page 109.



Bracketing

(P, S, A, and M Modes Only)

Bracketing automatically varies exposure, flash level, Active D-Lighting (ADL), or white balance slightly with each shot, “bracketing” the current value. Choose in situations in which it is difficult to set exposure, flash level, white balance, or Active D-Lighting and there is not time to check results and adjust settings with each shot, or to experiment with different settings for the same subject.

■ Exposure and Flash Bracketing

To vary exposure and/or flash level over a series of photographs:

1 Select exposure or flash bracketing.

To display the menus, press the MENU button. Select Custom Setting e5 (Auto bracketing set) in the Custom Settings menu, highlight an option, and press OK. Choose **AE & flash** to vary both exposure and flash level, **AE only** to vary only exposure, or **Flash only** to vary only flash level.

MENU button

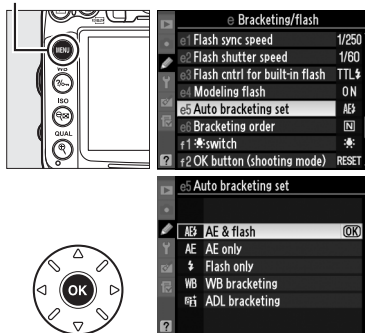

2 Choose the number of shots.

Pressing the BKT button, rotate the main command dial to choose the number of shots in the bracketing sequence and the order in which they will be taken.

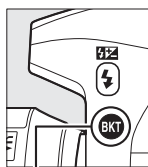

BKT button

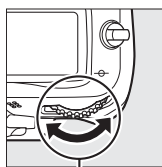

Main command dial

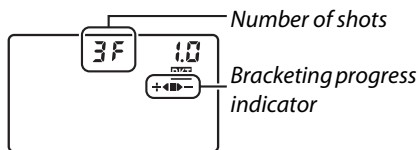

Control panel

No. of shots	Bracketing progress indicator	Bracketing order
3F	➕◀▶➖	Normal exposure, underexposure, overexposure
+2F	➕◀■	Normal exposure, overexposure
--2F	■▶➖	Normal exposure, underexposure

BKT will be displayed in the viewfinder (see right); the control panel will show BKT.



3 Select the bracketing increment.

Pressing the **BKT** button, rotate the sub-command dial to choose from values between 0.3 EV and 2 EV.

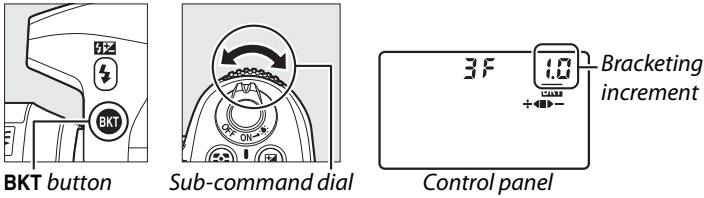

See Also

For information on choosing the size of the increment, see Custom Setting b2 (**EV steps for exposure cntl.**, □ 211). For information on choosing the order in which bracketing is performed, see Custom Setting e6 (**Bracketing order**, □ 229).

4 Frame a photograph, focus, and shoot.

The camera will vary exposure and/or flash level shot-by-shot according to the bracketing program selected.

Modifications to exposure are added to those made with exposure compensation (□ 107), making it possible to achieve exposure compensation values of more than 5 EV.



While bracketing is in effect, a bracketing progress indicator will be displayed in the control panel. A segment will disappear from the indicator after each shot: the ■ segment when the unmodified shot is taken, the ►- segment when the shot with the negative increment is taken, and the +◄ segment when the shot with the positive increment is taken.

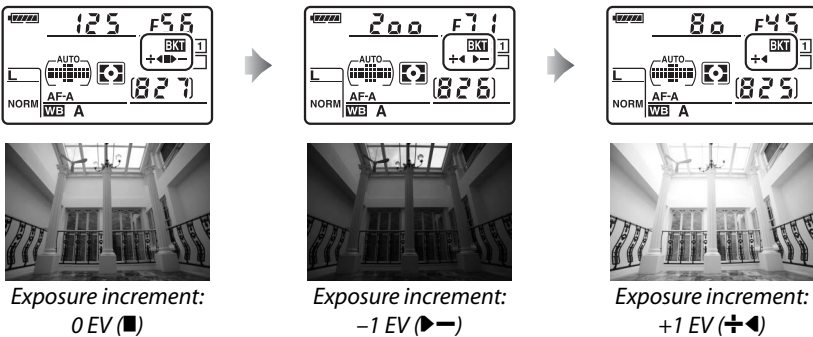

To cancel bracketing, press the **BKT** button and rotate the main command dial until the bracketing progress indicator and **BKT** icon are no longer displayed.

Exposure and Flash Bracketing

In continuous low speed and continuous high speed release modes (☐ 78), shooting will pause after the number of shots specified in the bracketing program have been taken. Shooting will resume the next time the shutter-release button is pressed. In self-timer mode, the camera will take the number of shots selected in Step 2 on page 109 each time the shutter-release button is pressed, regardless of the option selected for Custom Setting c3 (**Self-timer**) > **Number of shots** (☐ 214). In other release modes, one shot will be taken each time the shutter-release button is pressed.

If the memory card fills before all shots in the sequence have been taken, shooting can be resumed from the next shot in the sequence after the memory card has been replaced or shots have been deleted to make room on the memory card. If the camera is turned off before all shots in the sequence have been taken, bracketing will resume from the next shot in the sequence when the camera is turned on.

Exposure Bracketing

The camera modifies exposure by varying shutter speed and aperture (mode **P**), aperture (mode **S**), or shutter speed (modes **A** and **M**). If auto ISO sensitivity control is enabled in modes **P**, **S**, and **A**, the camera will automatically vary ISO sensitivity for optimum exposure when the limits of the camera exposure system are exceeded; in mode **M**, the camera will first use auto ISO sensitivity control to bring exposure as close as possible to the optimum and then bracket this exposure by varying shutter speed.



■ White Balance Bracketing

The camera creates multiple copies of each photograph, each with a different white balance. For more information on white balance, see page 117.

1 Select white balance bracketing.

Choose **WB bracketing** for Custom Setting e5 **Auto bracketing set**.

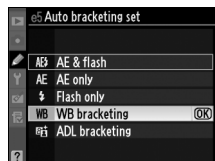

2 Choose the number of shots.

Pressing the **BKT** button, rotate the main command dial to choose the number of shots in the bracketing sequence and the order in which they will be taken.

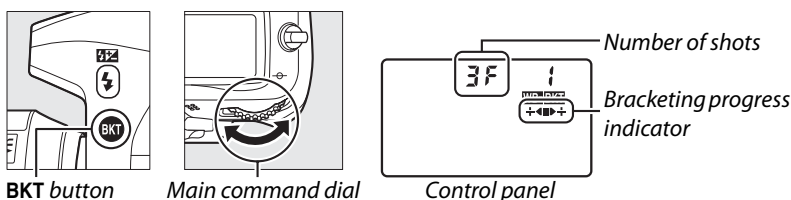

BKT will be displayed in the viewfinder (see right); the control panel will show **WB|BKT**.



3 Select a white balance increment.

Pressing the **BKT** button, rotate the sub-command dial to choose from increments of 1 (5 mired; □ 121), 2 (10 mired), or 3 (15 mired). The **B** value indicates the amount of blue, the **A** value the amount of amber (□ 119).

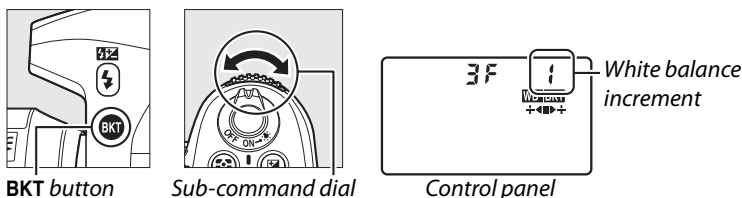

The bracketing programs with an increment of 1 are listed below.

Control panel	Bracketing progress indicator	No. of shots	Increment	Bracketing order
b2F 1	+◀	2	1B	0 / 1 B
A2F 1	▶+	2	1A	0 / 1 A
3F 1	+◀▶+	3	1A, 1B	0 / 1 A / 1 B

4 Frame a photograph, focus, and shoot.

Each shot will be processed to create the number of copies specified in the bracketing program, and each copy will have a different white balance. Modifications to white balance are added to the white balance adjustment made with white balance fine-tuning.



If the number of shots in the bracketing program is greater than the number of exposures remaining, the exposure count displays in the control panel and viewfinder will flash and the shutter release will be disabled. Shooting can begin when a new memory card is inserted.

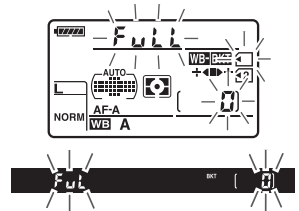

To cancel bracketing, press the **BKT** button and rotate the main command dial until the bracketing progress indicator and **WB: BKT** icon are no longer displayed.

White Balance Bracketing

White balance bracketing is not available at an image quality of NEF (RAW). Selecting **NEF (RAW)**, **NEF (RAW)+JPEG fine**, **NEF (RAW)+JPEG normal**, or **NEF (RAW)+JPEG basic** cancels white balance bracketing.

White balance bracketing affects only color temperature (the amber-blue axis in the white balance fine-tuning display, [□ 119](#)). No adjustments are made on the green-magenta axis.

In self-timer mode ([□ 80](#)), the number of copies specified in the white-balance program will be created each time the shutter is released, regardless of the option selected for Custom Setting c3 (**Self-timer**) > **Number of shots** ([□ 214](#)).

If the camera is turned off while the memory card access lamp is lit, the camera will power off only after all photographs in the sequence have been recorded.



■ ■ ADL Bracketing

The camera varies Active D-Lighting over a series of exposures. For more information on Active D-Lighting, see page 139.

1 Select ADL bracketing.

Choose **ADL bracketing** for Custom Setting e5 **Auto bracketing set**.

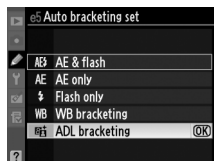

2 Choose the number of shots.

Pressing the **BKT** button, rotate the main command dial to choose the number of shots in the bracketing sequence. Choose two shots to take one photograph with Active D-Lighting off and another at the value currently selected for Active D-Lighting in the shooting menu (if Active D-Lighting is off, the second shot will be taken with Active D-Lighting set to **Auto**). Choose three shots to take a series of photographs with Active D-Lighting set to **Off, Normal, and High**.

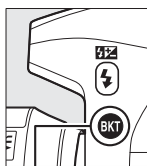

BKT button

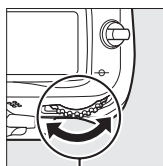

Main command dial

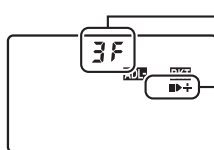

Control panel

BKT will be displayed in the viewfinder (see right); the control panel will show **ADL-BKT**.



3 Frame a photograph, focus, and shoot.

The camera will vary Active D-Lighting shot-by-shot according to the bracketing program selected. While bracketing is in effect, a bracketing progress indicator will be displayed in the control panel. A segment will disappear from the indicator after each shot: the ■ segment when the first shot is taken, the ► segment when the second shot is taken, and the + segment when the third shot (if applicable) is taken.

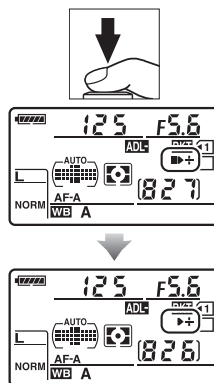

To cancel bracketing, press the **BKT** button and rotate the main command dial until the bracketing progress indicator and **ADL-BKT** icon are no longer displayed.

ADL Bracketing

In continuous low speed and continuous high speed release modes (□ 78), shooting will pause after the number of shots specified in the bracketing program have been taken. Shooting will resume the next time the shutter-release button is pressed. In self-timer mode, the camera will take the number of shots selected in Step 2 on page 114 each time the shutter-release button is pressed, regardless of the option selected for Custom Setting c3 (**Self-timer**) > **Number of shots** (□ 214). In other release modes, one shot will be taken each time the shutter-release button is pressed.

If the memory card fills before all shots in the sequence have been taken, shooting can be resumed from the next shot in the sequence after the memory card has been replaced or shots have been deleted to make room on the memory card. If the camera is turned off before all shots in the sequence have been taken, bracketing will resume from the next shot in the sequence when the camera is turned on.







White Balance

(P, S, A, and M Modes Only)

White balance ensures that colors are unaffected by the color of the light source. Auto white balance is recommended for most light sources; in **P**, **S**, **A**, and **M** modes, other values can be selected if necessary according to the type of source:

Option	Colortemp.*	Description
AUTO Auto	3,500–8,000 K	White balance is adjusted automatically. For best results, use type G or D lens. If built-in or optional flash fires, results are adjusted for flash.
Normal		
Keep warm lighting colors		
Incandescent	3,000 K	Use under incandescent lighting.
Fluorescent		Use with:
Sodium-vapor lamps	2,700 K	• Sodium-vapor lighting (found in sports venues).
Warm-white fluorescent	3,000 K	• Warm-white fluorescent lights.
White fluorescent	3,700 K	• White fluorescent lights.
Cool-white fluorescent	4,200 K	• Cool-white fluorescent lights.
Day white fluorescent	5,000 K	• Daylight white fluorescent lights.
Daylight fluorescent	6,500 K	• Daylight fluorescent lights.
High temp. mercury-vapor	7,200 K	• High color temperature light sources (e.g. mercury-vapor lamps).
Direct sunlight	5,200 K	Use with subjects lit by direct sunlight.
Flash	5,400 K	Use with built-in or optional flash.
Cloudy	6,000 K	Use in daylight under overcast skies.
Shade	8,000 K	Use in daylight with subjects in the shade.
Choose color temp.	2,500–10,000 K	Choose color temperature from list of values (☞ 122).
PRE Preset manual	—	Use subject, light source, or existing photograph as reference for white balance (☞ 123).

* All values are approximate. Fine-tuning set to 0.

White balance is set by pressing the **WB** button and rotating the main command dial until the desired setting is displayed in the control panel.

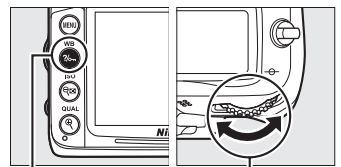

WB button Main command dial

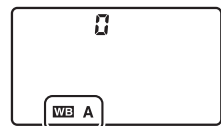

Control panel



The Shooting Menu

White balance can also be adjusted using the **White balance** option in the shooting menu (☐ 202), which also can be used to fine-tune white balance (☐ 119) or measure a value for preset white balance (☐ 123). The **Auto** option in the **White balance** menu offers a choice of **Normal** and **Keep warm lighting colors**, which preserves the warm colors produced by incandescent lighting, while the  **Fluorescent** option can be used to select the light source from the bulb types.

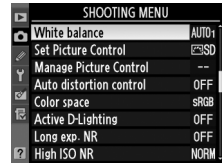













Studio Flash Lighting

Auto white balance may not produce the desired results with large studio flash units. Use preset white balance or set white balance to **Flash** and use fine tuning to adjust white balance.

Color Temperature

The perceived color of a light source varies with the viewer and other conditions. Color temperature is an objective measure of the color of a light source, defined with reference to the temperature to which an object would have to be heated to radiate light in the same wavelengths. While light sources with a color temperature in the neighborhood of 5,000–5,500 K appear white, light sources with a lower color temperature, such as incandescent light bulbs, appear slightly yellow or red. Light sources with a higher color temperature appear tinged with blue. The camera white balance options are adapted to the following color temperatures:

-  (sodium-vapor lamps): **2,700 K**
-  (incandescent)/
•  (warm-white fluorescent.): **3,000 K**
-  (white fluorescent): **3,700 K**
-  (cool-white fluorescent): **4,200 K**
-  (day white fluorescent): **5,000 K**
-  (direct sunlight): **5,200 K**
-  (flash): **5,400 K**
-  (cloudy): **6,000 K**
-  (daylight fluorescent): **6,500 K**
-  (high temp. mercury-vapor): **7,200 K**
-  (shade): **8,000 K**

See Also

When **WB bracketing** is selected for Custom Setting e5 (**Auto bracketing set**, ☐ 229), the camera will create several images each time the shutter is released. White balance will be varied with each image, “bracketing” the value currently selected for white balance (☐ 112).

Fine-Tuning White Balance

White balance can be “fine tuned” to compensate for variations in the color of the light source or to introduce a deliberate color cast into an image. White balance is fine tuned using the **White balance** option in the shooting menu or by pressing the **WB** button and rotating the sub-command dial.

■ The White Balance Menu

1 Select a white balance option.

To display the menus, press the **MENU** button. Select **White balance** in the shooting menu, then highlight a white balance option and press **▶**. If an option other than **Auto**, **Fluorescent**, **Choose color temp.**, or **Preset manual** is selected, proceed to Step 2. If **Auto**, **Fluorescent**, or **Choose color temp.** is selected, highlight the desired setting and press **▶**. If **Preset manual** is selected, choose a preset as described on page 128 before proceeding.

MENU button

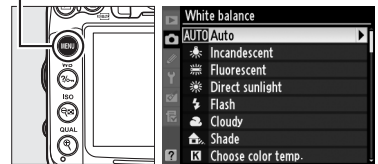

2 Fine tune white balance.

Use the multi selector to fine-tune white balance. White balance can be fine tuned on the amber (A)–blue (B) axis and the green (G)–magenta (M) axis. The horizontal (amber–blue) axis corresponds to color temperature, with each increment equivalent to about 5 mired. The vertical (green–magenta) axis has the similar effects to the corresponding color compensation (CC) filters.

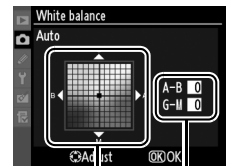

Adjustment

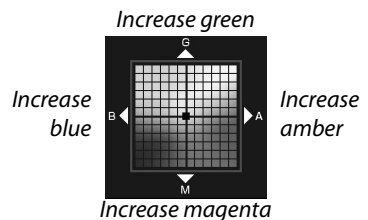

3 Press **OK**.

Press **OK** to save settings and return to the shooting menu. An asterisk ("*") is displayed in the control panel when fine-tuning is in effect.

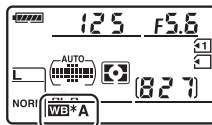

■ ■ The **WB** Button

At settings other than **☑ (Choose color temp.)** and **PRE (Preset manual)**, the **WB** button can be used to fine-tune white balance on the amber (A)–blue (B) axis (☐ 119; to fine-tune white balance when **☑** or **PRE** is selected, use the shooting menu as described on page 119). Six settings in both directions are available; each increment is equivalent to about 5 mired (☐ 121). Press the **WB** button and rotate the sub-command dial until the desired value is displayed in the control panel. Rotating the sub-command dial to the left increases the amount of amber (A). Rotating the sub-command dial to the right increases the amount of blue (B). An asterisk ("*") appears in the control panel at settings other than 0.

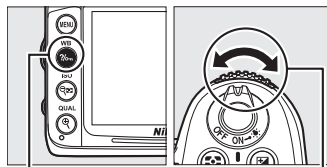

WB button Sub-command dial

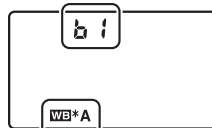

Control panel

White Balance Fine Tuning

The colors on the fine-tuning axes are relative, not absolute. For example, moving the cursor to **B** (blue) when a “warm” setting such as  (incandescent) is selected for white balance will make photographs slightly “colder” but will not actually make them blue.

Color Temperature Fine-Tuning

When **Choose color temp.** is selected, you can view the color temperature while fine-tuning white balance.

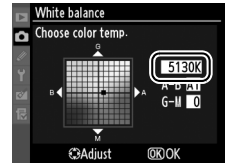

“Mired”

Any given change in color temperature produces a greater difference in color at low color temperatures than it would at higher color temperatures. For example, a change of 1000 K produces a much greater change in color at 3000 K than at 6000 K. Mired, calculated by multiplying the inverse of the color temperature by 10^6 , is a measure of color temperature that takes such variation into account, and as such is the unit used in color-temperature compensation filters. E.g.:

- 4000 K–3000 K (a difference of 1000 K)=83 mired
- 7000 K–6000 K (a difference of 1000 K)=24 mired

Choosing a Color Temperature

When **[K]** (**Choose color temp.**) is selected for white balance, color temperature can be selected by pressing the **WB** button and rotating the sub-command dial. The color temperature is displayed in the control panel.

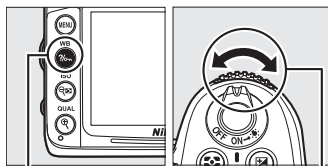

WB button

Sub-command dial



Control panel

Choose Color Temperature

Note that the desired results will not be obtained with flash or fluorescent lighting. Choose **[Flash]** or **[Fluorescent]** for these sources. With other light sources, take a test shot to determine if the selected value is appropriate.

The White Balance Menu

Color temperature can also be selected in the white balance menu. Note that the color temperature with the **WB** button and the sub-command dial replaces the value selected in the white balance menu.

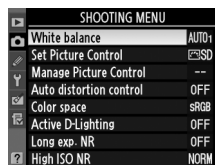

Preset Manual

Preset manual is used to record and recall custom white balance settings for shooting under mixed lighting or to compensate for light sources with a strong color cast. Two methods are available for setting preset white balance:

Method	Description
Measure	Neutral gray or white object is placed under lighting that will be used in final photo and white balance measured by camera (☞ 124).
Use photo	White balance is copied from photo on memory card (☞ 126).

The camera can store up to five values for preset white balance in presets d-0 through d-4. A descriptive comment can be added to any white balance preset (☞ 129).

d-0

Stores last value measured for white balance (☞ 124). This preset is overwritten when a new value is measured.

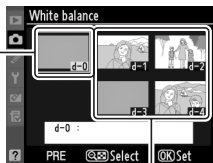

d-1-d-4

Store values copied from d-0 (☞ 126).

Store values copied from images on memory card (☞ 126).

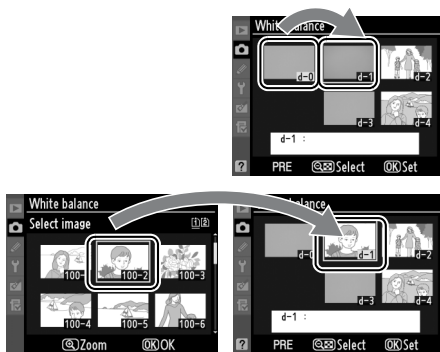

■ ■ Measuring a Value for Preset White Balance

1 Light a reference object.

Place a neutral gray or white object under the lighting that will be used in the final photograph. In studio settings, a standard gray panel can be used as a reference object. Note that exposure is automatically increased by 1 EV when measuring white balance; in mode **M**, adjust exposure so that the exposure indicator shows ± 0 (☐ 72).

2 Set white balance to PRE (Preset manual).

Press the **WB** button and rotate the main command dial until **PRE** is displayed in the control panel.

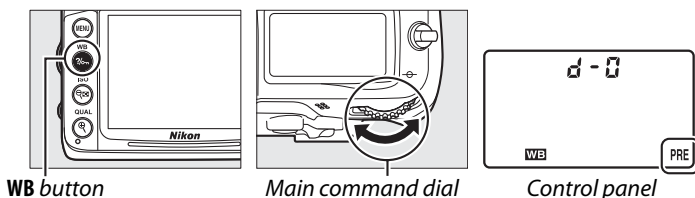

3 Select direct measurement mode.

Release the **WB** button briefly and then press the button until the **PRE** icon in the control panel starts to flash. A flashing **PrE** will also appear in the control panel and viewfinder. The displays will flash for about six seconds.

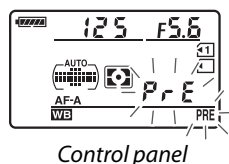

Control panel



Viewfinder

4 Measure white balance.

Before the indicators stop flashing, frame the reference object so that it fills the viewfinder and press the shutter-release button all the way down. The camera will measure a value for white balance and store it in preset d-0. No photograph will be recorded; white balance can be measured accurately even when the camera is not in focus.



5 Check the results.

If the camera was able to measure a value for white balance, **Good** will flash in the control panel for about six seconds, while the viewfinder will show a flashing **Good**.

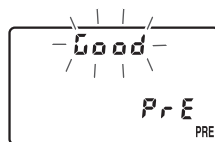

Control panel



Viewfinder

If lighting is too dark or too bright, the camera may be unable to measure white balance. A flashing **no Good** will appear in the control panel and viewfinder for about six seconds. Press the shutter-release button halfway to return to Step 4 and measure white balance again.

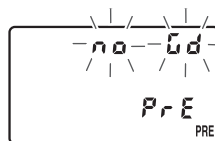

Control panel



Viewfinder

6 Select preset d-0.

If the new value for preset white balance will be used immediately, select preset d-0 by pressing the **WB** button and rotating the sub-command dial until d-0 is displayed in the control panel.

Direct Measurement Mode

If no operations are performed while the displays are flashing, direct measurement mode will end in the time selected for Custom Setting c2 (**Auto meter-off delay**, □ 214).

Preset d-0

The new value for white balance will be stored in preset d-0, automatically replacing the previous value for this preset (no confirmation dialog will be displayed). A thumbnail will be displayed in the preset white balance list (□ 126).



To use the new value for white balance, select preset d-0 (if no value has been measured for white balance before d-0 is selected, white balance will be set to a color temperature of 5,200 K, the same as **Direct sunlight**). The new white balance value will remain in preset d-0 until white balance is measured again. By copying preset d-0 to one of the other presets before measuring a new value for white balance, up to five white balance values can be stored (□ 126).



■ Copying White Balance from d-0 to Presets d-1–d-4

Follow the steps below to copy a measured value for white balance from d-0 to any of the other presets (d-1–d-4).

1 Select PRE (Preset manual).

Press the MENU button and select **White balance** in the shooting menu. Highlight **Preset manual** and press ►.

MENU button

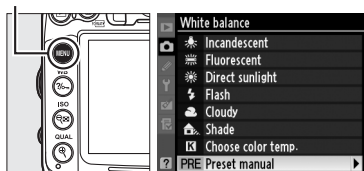

2 Select a destination.

Highlight the destination preset (d-1 to d-4) and press .

button

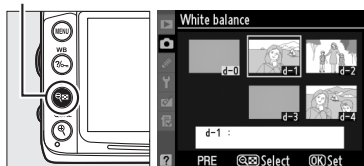

3 Copy d-0 to the selected preset.

Highlight **Copy d-0** and press . If comment has been created for d-0 (129), the comment will be copied to the comment for the selected preset.

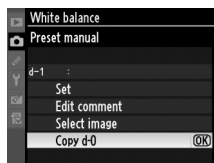

■ Copying White Balance from a Photograph (d-1–d-4 Only)

Copy a value for white balance from an existing image to a selected preset. Note that existing values can not be copied to preset d-0.

WB

1 Select PRE (Preset manual).

Highlight **Preset manual** in the white balance menu and press ►.

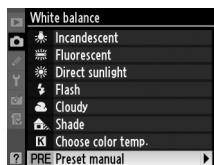

2 Select a destination.

Highlight the destination preset (d-1 to d-4) and press .

button

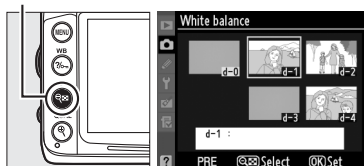

3 Choose Select image.

Highlight **Select image** and press ►.

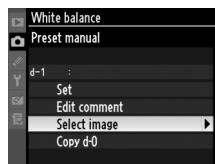

4 Highlight a source image.

Highlight the source image.

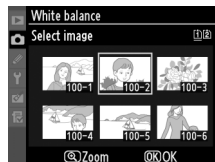

To view the highlighted image full frame, press and hold the **Q** button.

Q button

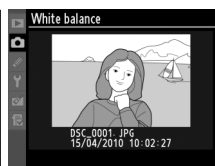
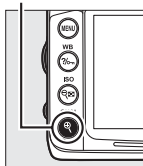

To view images in other locations, hold **BKT** and press ▲. The dialog shown at right will be displayed; select the desired card and folder (□ 164).

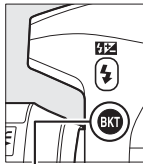

BKT button



5 Copy white balance.

Press **OK** to copy the white balance value for the highlighted photograph to the selected preset. If the highlighted photograph has a comment (□ 238), the comment will be copied to the comment for the selected preset.



Choosing a White Balance Preset

Press ▲ to highlight the current white balance preset (d-0–d-4) and press ► to select another preset.

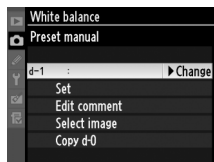

■ Selecting a White Balance Preset



To set white balance to a preset value:

1 Select PRE (Preset manual).

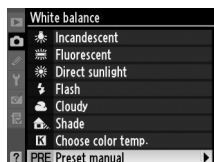
Highlight **Preset manual** in the white balance menu and press ►.

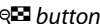

2 Select a preset.

Highlight the desired preset and press . To select the highlighted preset and display fine tuning menu ( 119) without completing the next step, press  instead.

 button

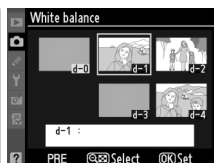
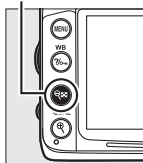

3 Select Set.

Highlight **Set** and press ►. Fine tuning menu for the selected white balance preset is displayed ( 119).

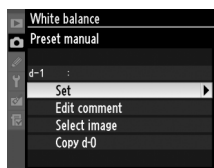

Selecting a White Balance Preset: the WB Button

At a setting of **PRE (Preset manual)**, presets can also be selected by pressing the **WB** button and rotating the sub-command dial. The current preset is displayed in the control panel while the **WB** button is pressed.

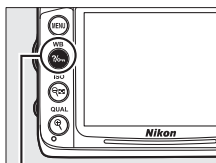

WB button

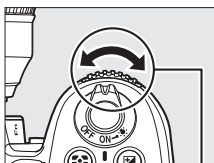

Sub-command dial

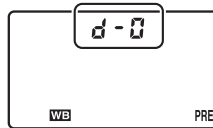

Control panel

■ Entering a Comment

Follow the steps below to enter a descriptive comment of up to thirty-six characters for a selected white balance preset.

1 Select PRE (Preset manual).

Highlight **Preset manual** in the white balance menu and press ►.

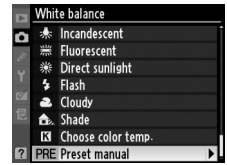

2 Select a preset.

Highlight the desired preset and press .

 button

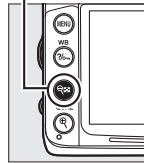

3 Select Edit comment.

Highlight **Edit comment** and press ►.

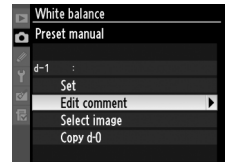

4 Edit the comment.

Edit the comment as described on page 137.







Image Enhancement

Picture Controls

(P, S, A, and M Modes Only)

Nikon's unique Picture Control system makes it possible to share image processing settings, including sharpening, contrast, brightness, saturation, and hue, among compatible devices and software.

Selecting a Picture Control

The camera offers a choice of preset Picture Controls. In **P**, **S**, **A**, and **M** modes, you can choose a Picture Control according to the subject or type of scene (in other modes, the camera selects a Picture Control automatically).

Option	Description
Standard	Standard processing for balanced results. Recommended for most situations.
Neutral	Minimal processing for natural results. Choose for photographs that will later be extensively processed or retouched.
Vivid	Pictures are enhanced for a vivid, photoprint effect. Choose for photographs that emphasize primary colors.
Monochrome	Take monochrome photographs.
Portrait	Process portraits for skin with natural texture and a rounded feel.
Landscape	Produces vibrant landscapes and cityscapes.

1 Display Picture Controls.

To display the menus, press the **MENU** button. Highlight **Set Picture Control** in the shooting menu and press **▶** to display a list of Picture Controls.

MENU button

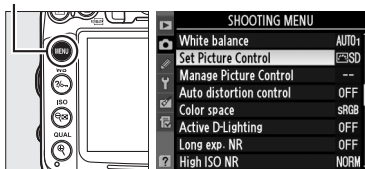

2 Choose a Picture Control.

Highlight an option and press **OK**.

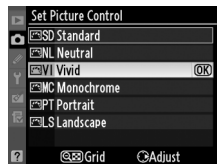

Preset Picture Controls Versus Custom Picture Controls

The Picture Controls supplied with the camera are referred to as *preset Picture Controls*. *Custom Picture Controls* are created through modifications to existing Picture Controls using the **Manage Picture Control** option in the shooting menu (☰ 136). Custom Picture Controls can be saved to a memory card for sharing among other cameras of the same model and compatible software (☰ 138).

Optional Picture Controls

Additional optional Picture Controls may be available for download from Nikon websites.

The Picture Control Indicator

The current Picture Control is shown in the information display when the  button is pressed.

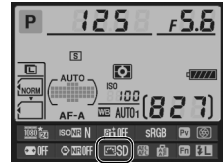

*Picture Control
indicator*

Modifying Picture Controls

Existing preset or custom Picture Controls (📖 136) can be modified to suit the scene or the user's creative intent. Choose a balanced combination of settings using **Quick adjust**, or make manual adjustments to individual settings.

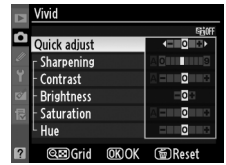

1 Select a Picture Control.

Highlight the desired Picture Control in the **Set Picture Control** menu (📖 131) and press ►.



2 Adjust settings.

Press ▲ or ▼ to highlight the desired setting and press ◀ or ▶ to choose a value (📖 134). Repeat this step until all settings have been adjusted, or select **Quick adjust** to choose a preset combination of settings. Default settings can be restored by pressing the 🔄 button.



3 Save changes and exit.

Press OK.

Modifications to Original Picture Controls

Picture Controls that have been modified from default settings are indicated by an asterisk ("*").



Picture Control Settings

Option	Description
Quick adjust	Choose from options between -2 and +2 to reduce or exaggerate the effect of the selected Picture Control (note that this resets all manual adjustments). For example, choosing positive values for Vivid makes pictures more vivid. Not available with Neutral or Monochrome Picture Controls.
Manual adjustments (all Picture Controls)	Sharpening Control the sharpness of outlines. Select A to adjust sharpening automatically according to the type of scene, or choose from values between 0 (no sharpening) and 9 (the higher the value, the greater the sharpening).
	Contrast Select A to adjust contrast automatically according to the type of scene, or choose from values between -3 and +3 (choose lower values to prevent highlights in portrait subjects from being “washed out” in direct sunlight, higher values to preserve detail in misty landscapes and other low-contrast subjects).
	Brightness Choose -1 for reduced brightness, +1 for enhanced brightness. Does not affect exposure.
Manual adjustments (non-monochrome only)	Saturation Control the vividness of colors. Select A to adjust saturation automatically according to the type of scene, or choose from values between -3 and +3 (lower values reduce saturation and higher values increase it).
	Hue Choose negative values (to a minimum of -3) to make reds more purple, blues more green, and greens more yellow, positive values (up to +3) to make reds more orange, greens more blue, and blues more purple.
Manual adjustments (monochrome only)	Filter effects Simulate the effect of color filters on monochrome photographs. Choose from Off , yellow, orange, red, and green (☐ 135).
	Toning Choose the tint used in monochrome photographs from B&W (black-and-white), Sepia , Cyanotype (blue-tinted monochrome), Red , Yellow , Green , Blue Green , Blue , Purple Blue , Red Purple (☐ 135).



“A” (Auto)

Results for auto sharpening, contrast, and saturation vary with exposure and the position of the subject in the frame. Use a type G or D lens for best results.

Custom Picture Controls

The options available with custom Picture Controls are the same as those on which the custom Picture Control was based.

The Picture Control Grid

Pressing the  button in Step 2 (📖 133) displays a Picture Control grid showing the contrast and saturation for the selected Picture Control in relation to the other Picture Controls (only contrast is displayed when **Monochrome** is selected). Release the  button to return to the Picture Control menu.



The icons for Picture Controls that use auto contrast and saturation are displayed in green in the Picture Control grid, and lines appear parallel to the axes of the grid.

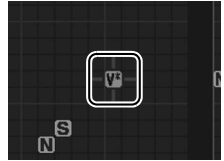

Previous Settings

The line under the value display in the Picture Control setting menu indicates the previous value for the setting. Use this as a reference when adjusting settings.

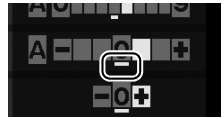



Filter Effects (Monochrome Only)

The options in this menu simulate the effect of color filters on monochrome photographs. The following filter effects are available:

Option		Description
Y	Yellow	Enhances contrast. Can be used to tone down the brightness of the sky in
O	Orange	landscape photographs. Orange produces more contrast than yellow, red
R	Red	more contrast than orange.
G	Green	Softens skin tones. Can be used for portraits.

Note that the effects achieved with **Filter effects** are more pronounced than those produced by physical glass filters.

Toning (Monochrome Only)

Pressing  when **Toning** is selected displays saturation options. Press  or  to adjust saturation. Saturation control is not available when **B&W** (black-and-white) is selected.

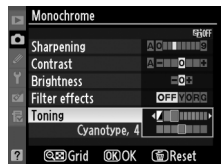

Creating Custom Picture Controls

The Picture Controls supplied with the camera can be modified and saved as custom Picture Controls.

1 Select Manage Picture Control.

To display the menus, press the MENU button. Highlight **Manage Picture Control** in the shooting menu and press ►.

MENU button

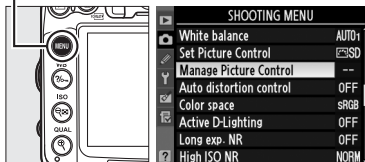

2 Select Save/edit.

Highlight **Save/edit** and press ►.



3 Select a Picture Control.

Highlight an existing Picture Control and press ►, or press **OK** to proceed to step 5 to save a copy of the highlighted Picture Control without further modification.

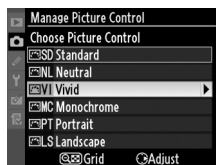

4 Edit the selected Picture Control.

See page 134 for more information. To abandon any changes and start over from default settings, press the **Reset** button. Press **OK** when settings are complete.



5 Select a destination.

Highlight a destination for the custom Picture Control (C-1 through C-9) and press ►.

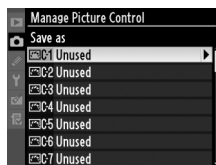

6 Name the Picture Control.

The text-entry dialog shown at right will be displayed. By default, new Picture Controls are named by adding a two-digit number (assigned automatically) to the name of the existing Picture Control. To move the cursor in the name area, hold the **Cursor** button and press **Left** or **Right**. To enter a new letter at the current cursor position, use the multi selector to highlight the desired character in the keyboard area and press **OK**. To delete the character at the current cursor position, press the **Delete** button. To return to the shooting menu without saving the Picture Control, press the **MENU** button.

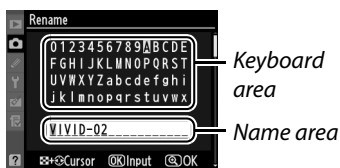

Custom Picture Control names can be up to nineteen characters long. Any characters after the nineteenth will be deleted.

7 Save changes and exit.

After editing the name, press **OK** to save changes and exit. The new Picture Control will appear in the Picture Control list.

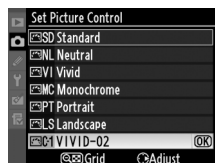

Manage Picture Control > Rename

Custom Picture Controls can be renamed at any time using the **Rename** option in the **Manage Picture Control** menu.

Manage Picture Control > Delete

The **Delete** option in the **Manage Picture Control** menu can be used to delete selected custom Picture Controls when they are no longer needed.

The Original Picture Control Icon

The original preset Picture Control on which the custom Picture Control is based is indicated by an icon in the top right corner of the edit display.

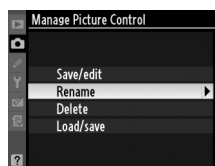

Original Picture Control icon



Sharing Custom Picture Controls

Custom Picture Controls created using the Picture Control Utility available with ViewNX 2 or optional software such as Capture NX 2 can be copied to a memory card and loaded into the camera, or custom Picture Controls created with the camera can be copied to the memory card to be used in compatible cameras and software and then deleted when no longer needed.

To copy custom Picture Controls to or from the memory card, or to delete custom Picture Controls from the memory card, highlight **Load/save** in the **Manage Picture Control** menu and press ►. The following options will be displayed:

- **Copy to camera:** Copy custom Picture Controls from the memory card to custom Picture Controls C-1 through C-9 on the camera and name them as desired.
- **Delete from card:** Delete selected custom Picture Controls from the memory card. The confirmation dialog shown at right will be displayed before a Picture Control is deleted; to delete the selected Picture Control, highlight **Yes** and press **OK**.
- **Copy to card:** Copy a custom Picture Control (C-1 through C-9) from the camera to a selected destination (1 through 99) on the memory card.

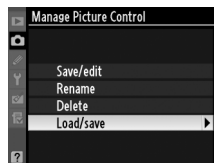

Saving Custom Picture Controls

Up to 99 custom Picture Controls can be stored on the memory card at any one time. The memory card can only be used to store user-created custom Picture Controls. The preset Picture Controls supplied with the camera can not be copied to the memory card, renamed, or deleted.

The options in the **Manage Picture Control** menu apply only to the memory card in Slot 1. Custom Picture Controls can not be deleted from or copied to or from the card in Slot 2.

Active D-Lighting

(P, S, A, and M Modes Only)

Active D-Lighting preserves details in highlights and shadows, creating photographs with natural contrast. Use for high contrast scenes, for example when photographing brightly lit outdoor scenery through a door or window or taking pictures of shaded subjects on a sunny day. It is most effective when used with matrix metering (☒).

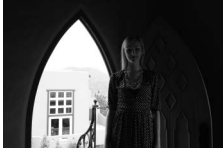

Active D-Lighting off



Active D-Lighting:
暗A Auto



Active D-Lighting off



Active D-Lighting:
暗H High

To use Active D-Lighting:

1 Select Active D-Lighting.

To display the menus, press the **MENU** button. Highlight **Active D-Lighting** in the shooting menu and press ►.

MENU button

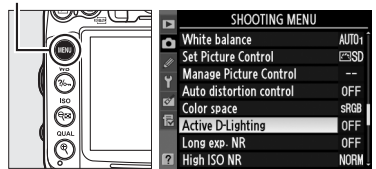

2 Choose an option.

Highlight an option and press **OK**. If **暗A Auto** is selected, the camera will automatically adjust Active D-Lighting according to shooting conditions (in mode **M**, however, **暗A Auto** is equivalent to **暗N Normal**).



✓ **Active D-Lighting**

Noise (randomly-spaced bright pixels, fog, or lines) may appear in photographs taken with Active D-Lighting. Uneven shading may be visible with some subjects. Active D-Lighting can not be used at ISO sensitivities of Hi 0.3 or above.

✓ **“Active D-Lighting” Versus “D-Lighting”**

The **Active D-Lighting** option in the shooting menu adjusts exposure before shooting to optimize the dynamic range, while the **D-Lighting** option in the retouch menu (☐ 251) optimizes dynamic range in images after shooting.

✍ **See Also**

When **ADL bracketing** is selected for Custom Setting e5 (**Auto bracketing set**, ☐ 229), the camera varies Active D-Lighting over a series of shots. See page 114 for more information.



Color Space

The color space determines the gamut of colors available for color reproduction. Choose a color space according to how photographs will be processed on leaving the camera.

Option	Description
sRGB sRGB	Choose for photographs that will be printed or used “as is,” with no further modification.
Adobe Adobe RGB	This color space is capable of expressing a wider gamut of colors than sRGB, making it the preferred choice for images that will be extensively processed or retouched.

1 Select Color space.

To display the menus, press the MENU button. Highlight **Color space** in the shooting menu and press ►.

MENU button

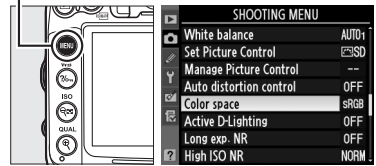

2 Select a color space.

Highlight the desired option and press OK.

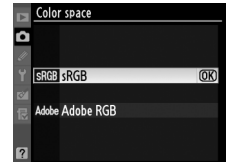

Color Space

Color spaces define the correspondence between colors and the numeric values that represent them in a digital image file. The sRGB color space is widely used, while the Adobe RGB color space is typically used in publishing and commercial printing. sRGB is recommended when taking photographs that will be printed without modification or viewed in applications that do not support color management, or when taking photographs that will be printed with ExifPrint, the direct printing option on some household printers, or kiosk printing or other commercial print services. Adobe RGB photographs can also be printed using these options, but colors will not be as vivid.

JPEG photographs taken in the Adobe RGB color space are Exif 2.3 and DCF 2.0 compliant; applications and printers that support Exif 2.3 and DCF 2.0 will select the correct color space automatically. If the application or device does not support Exif 2.3 and DCF 2.0, select the appropriate color space manually. For more information, see the documentation provided with the application or device.

Nikon Software

ViewNX 2 (supplied) and Capture NX 2 (available separately) automatically select the correct color space when opening photographs created with the camera.



Flash Photography

Using the Built-in Flash

The built-in flash has a Guide Number (GN) 12/39 (m/ft., ISO 100, 20 °C/68 °F) and provides coverage for the angle of view of a 16 mm lens. It can be used not only when natural lighting is inadequate but to fill in shadows and backlit subjects or to add a catch light to the subject's eyes.

■ Using the Built-in Flash: , , , , , and Modes

1 Choose a flash mode ( 144).

2 Take pictures.

The flash will pop up as required when the shutter-release button is pressed halfway, and fire when a photograph is taken. *If the flash does not pop up automatically, DO NOT attempt to raise it by hand. Failure to observe this precaution could damage the flash.*

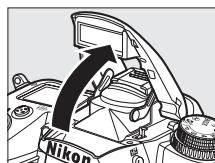

■ Using the Built-in Flash: P, S, A, M, and Modes

1 Raise the flash.

Press the  button to raise the flash.

2 Choose a flash mode ( 144).

3 Take pictures.

The flash will fire whenever a picture is taken.

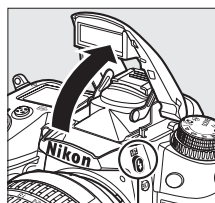

 button

Lowering the Built-in Flash

To save power when the flash is not in use, press it gently downward until the latch clicks into place.

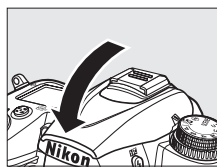

Flash Mode

The flash modes available vary with shooting mode:

AUTO, , , , , ,			
AUTO Auto	AUTO SLOW Auto + slow sync + red-eye reduction		Fill flash
AUTO Auto + red-eye reduction	AUTO SLOW Auto + slow sync		
Off	Off		
P, A		S, M	
	Fill flash		Fill flash
	Red-eye reduction		Red-eye reduction
SLOW	Slow sync + red-eye reduction	REAR	Rear-curtain sync
SLOW	Slow sync		
REAR	Rear curtain + slow sync*		

* **SLOW** is displayed when setting is complete.

To choose a flash mode, press the button and rotate the main command dial until the desired setting is displayed in the control panel.

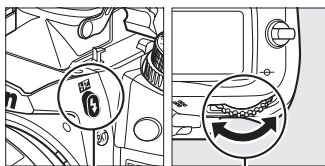

button Main command dial

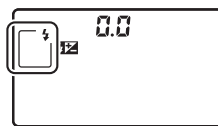

Control panel

The Built-in Flash

Use with lenses with focal lengths of 16–300 mm (□ 271). Remove lens hoods to prevent shadows. The flash has a minimum range of 0.6 m (2 ft.) and can not be used in the macro range of macro zoom lenses. i-TTL flash control can be used at ISO sensitivities between 100 and 6400. At values over 6400, the desired results may not be achieved at some ranges or aperture settings.

If the flash fires in continuous release mode (□ 78), only one picture will be taken each time the shutter-release button is pressed.

The shutter release may be briefly disabled to protect the flash after it has been used for several consecutive shots. The flash can be used again after a short pause.

Flash Modes

The flash modes listed on the previous page may combine one or more of the following settings, as shown by the flash mode icon:

- **AUTO (auto flash):** When lighting is poor or subject is back lit, flash pops up automatically when shutter-release button is pressed halfway and fires as required.
- **👁️ (red-eye reduction):** Use for portraits. Red-eye reduction lamp lights before flash fires, reducing “red-eye.”
- **🔇 (off):** Flash does not fire even when lighting is poor or subject is back-lit.
- **SLOW (slow sync):** Shutter speed slows automatically to capture background lighting at night or under low light. Use to include background lighting in portraits.
- **REAR (rear-curtain sync):** Flash fires just before shutter closes, creating a stream of light behind moving light sources (below at right). If this icon is not displayed, flash will fire as the shutter opens (front-curtain sync; the effect this produces with moving light sources is shown below at left).



Front-curtain sync



Rear-curtain sync

Shutter Speeds Available with the Built-in Flash

The following shutter speeds are available with the built-in flash.

Mode	Shutter speed	Mode	Shutter speed
AUTO, P*, A*, , , , ,	$1/250$ – $1/60$ s	S	$1/250$ –30 s
,	$1/250$ – $1/125$ s	M	$1/250$ –30 s,
	$1/250$ –1 s		

* Speeds as fast as $1/8,000$ s are available with optional SB-900, SB-800, SB-700, and SB-600 flash units in modes P and A if **1/320 s (Auto FP)** or **1/250 s (Auto FP)** is selected for Custom Setting e1 (**Flash sync speed**, □ 222).

See Also

See page 149 for information on locking flash value (FV) for a metered subject before recomposing a photograph. For information on auto FP high-speed sync and choosing a flash sync speed, see Custom Setting e1 (**Flash sync speed**, □ 222). For information on choosing the slowest shutter speed available when using the flash, see Custom Setting e2 (**Flash shutter speed**, □ 223). For information on flash control and using the built-in flash in commander mode, see Custom Setting e3 (**Flash cntrl for built-in flash**, □ 223). See page 275 for information on using optional flash units.







Flash Control Mode

The camera supports the following i-TTL flash control modes:

- **i-TTL balanced fill-flash for digital SLR:** Flash emits series of nearly invisible preflashes (monitor preflashes) immediately before main flash. Preflashes reflected from objects in all areas of frame are picked up by 2,016-pixel RGB sensor and are analyzed in combination with range information from matrix metering system to adjust flash output for natural balance between main subject and ambient background lighting. If type G or D lens is used, distance information is included when calculating flash output. Precision of calculation can be increased for non-CPU lenses by providing lens data (focal length and maximum aperture; see [□ 159](#)). Not available when spot metering is used.
- **Standard i-TTL flash for digital SLR:** Flash output adjusted to bring lighting in frame to standard level; brightness of background is not taken into account. Recommended for shots in which main subject is emphasized at expense of background details, or when exposure compensation is used. Standard i-TTL flash for digital SLR is activated automatically when spot metering is selected.

The flash control mode for the built-in flash can be selected using Custom Setting e3 (**Flash cntrl for built-in flash**, [□ 223](#)). The information display shows the flash control mode for the built-in flash as follows:

	Flash sync	Auto FP (□ 222)
i-TTL		—
Manual		—
Repeating flash		—
Commander mode		



Aperture, Sensitivity, and Flash Range

Flash range varies with sensitivity (ISO equivalency) and aperture.

Aperture at ISO equivalent of							Range	
100	200	400	800	1600	3200	6400	m	ft.
1.4	2	2.8	4	5.6	8	11	0.7–8.5	2ft. 4in.–27ft. 11in.
2	2.8	4	5.6	8	11	16	0.6–6.0	2ft.–19ft. 8in.
2.8	4	5.6	8	11	16	22	0.6–4.2	2ft.–13ft. 9in.
4	5.6	8	11	16	22	32	0.6–3.0	2ft.–9ft. 10in.
5.6	8	11	16	22	32	—	0.6–2.1	2ft.–6ft. 11in.
8	11	16	22	32	—	—	0.6–1.5	2ft.–4ft. 11in.
11	16	22	32	—	—	—	0.6–1.1	2ft.–3ft. 7in.
16	22	32	—	—	—	—	0.6–0.8	2ft.–2ft. 7in.

The built-in flash has a minimum range of 0.6 m (2 ft.).

In mode **P**, the maximum aperture (minimum f-number) is limited according to ISO sensitivity, as shown below:

Maximum aperture at ISO equivalent of:						
100	200	400	800	1600	3200	6400
2.8	3.5	4	5	5.6	7.1	8

If the maximum aperture of the lens is smaller than given above, the maximum value for aperture will be the maximum aperture of the lens.





Flash Compensation

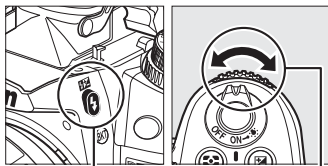

(P, S, A, and M Modes Only)

Flash compensation is used to alter flash output by from -3 EV to $+1$ EV in increments of $1/3$ EV, changing the brightness of the main subject relative to the background. Flash output can be increased to make the main subject appear brighter, or reduced to prevent unwanted highlights or reflections.

Press the  button and rotate the sub-command dial until the desired value is displayed in the control panel. In general, choose positive values to make the main subject brighter, negative values to make it darker.



 button Sub-command dial

At values other than ± 0.0 , a  icon will be displayed in the control panel and viewfinder after you release the  button. The current value for flash compensation can be confirmed by pressing the  button.

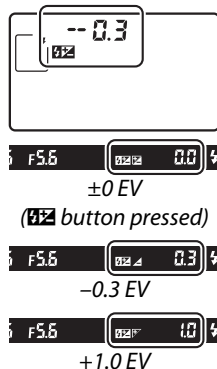

Normal flash output can be restored by setting flash compensation to ± 0.0 . Flash compensation is not reset when the camera is turned off.



Optional Flash Units

Flash compensation is also available with optional SB-900, SB-800, SB-700, SB-600, SB-400, and SB-R200 flash units. The SB-900, SB-800, SB-700, and SB-600 also allow flash compensation to be set using the controls on the flash unit; the value selected with the flash unit is added to the value selected with the camera.

See Also

For information on choosing the size of the increments available for flash compensation, see Custom Setting b2 (**EV steps for exposure cntrl.**,  211). For information on automatically varying flash level over a series of shots, see page  109.

FV Lock

This feature is used to lock flash output, allowing photographs to be recomposed without changing the flash level and ensuring that flash output is appropriate to the subject even when the subject is not positioned in the center of the frame. Flash output is adjusted automatically for any changes in ISO sensitivity and aperture.





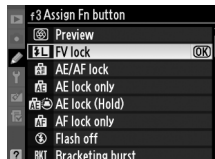

To use FV lock:

1 Assign FV lock to the Fn button.

Select **FV lock** for Custom Setting f3 (**Assign Fn button**,  230).



2 Raise the flash.

In **P**, **S**, **A**, **M**, and **Hi** modes, the flash can be raised by pressing the  button. In , , , , , and  modes, the flash will pop up automatically when required.

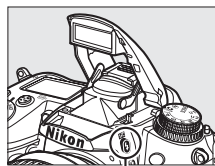



3 Focus.

Position the subject in the center of the frame and press the shutter-release button halfway to focus.



4 Lock flash level.

After confirming that the flash ready indicator () is displayed in the viewfinder, press the **Fn** button. The flash will emit a monitor preflash to determine the appropriate flash level. Flash output will be locked at this level and FV lock icons () will appear in the viewfinder.

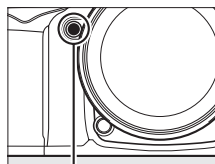

5 Recompose the photograph.

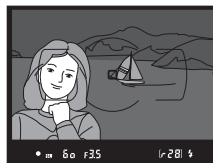

6 Take the photograph.

Press the shutter-release button the rest of the way down to shoot. If desired, additional pictures can be taken without releasing FV lock.

7 Release FV lock.

Press the **Fn** button to release FV lock. Confirm that the FV lock icon (🔒) is no longer displayed in the viewfinder.

✔ Using FV Lock with the Built-in Flash

FV lock is only available with the built-in flash when **TTL** is selected for Custom Setting e3 (**Flash cntrl for built-in flash**, ☐ 223).

✍ Using FV Lock with Optional Flash Units

FV lock is also available with SB-900, SB-800, SB-700, SB-600, SB-400, and SB-R200 flash units (available separately). Set the optional flash to **TTL** mode (the SB-900 and SB-800 can also be used in **AA** mode; see the flash manual for details). While FV lock is in effect, flash output will automatically be adjusted for changes in flash zoom head position.

When Commander mode is selected for Custom Setting e3 (**Flash cntrl for built-in flash**, ☐ 223), FV lock can be used with remote SB-900, SB-800, SB-700, SB-600, or SB-R200 flash units if (a) any of the built-in flash, flash group A, or flash group B is in **TTL** mode, or (b) a flash group is composed entirely of SB-900 and SB-800 flash units in **TTL** or **AA** mode.

✍ Metering

The metering areas for FV lock when using optional flash unit are as follows:

Flash unit	Flash mode	Metered area
Stand-alone flash unit	i-TTL	4-mm circle in center of frame
	AA	Area metered by flash exposure meter
Used with other flash units (Advanced Wireless Lighting)	i-TTL	Entire frame
	AA	Area metered by flash exposure meter
	A (master flash)	

✍ See Also

For information on using the depth-of-field preview or **AE-L/AF-L** button for FV lock, see Custom Setting f4 (**Assign preview button**, ☐ 232) or Custom Setting f5 (**Assign AE-L/AF-L button**, ☐ 232).









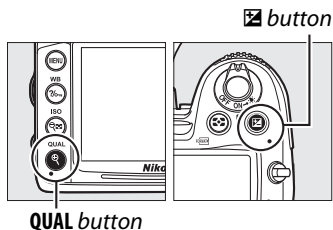

Other Shooting Options

Restoring Default Settings

The camera settings listed below can be restored to default values by holding the **QUAL** and  buttons down together for more than two seconds (these buttons are marked by a green dot). The control panel turns off briefly while settings are reset.



Option	Default	
Image quality	NORMAL	85
Image size	L	88
White balance	Auto > Normal	117
Fine tuning	0	119
ISO sensitivity		
Auto and scene modes	AUTO	101
P, S, A, M	100	
Autofocus (viewfinder)		
Autofocus mode	AF-A	91
AF-area mode		
 Single-point AF	39-point dynamic-area AF	94
 Other shooting modes		
Autofocus (live view/movie)		
Autofocus mode	AF-S	50
AF-area mode		
 Wide-area AF	Normal-area AF	50
 Other shooting modes		

Option	Default		
Focus point ¹	Center	96	
Metering	Matrix	105	
AE lock hold	Off	97, 106	
Active D-Lighting	Off	139	
Bracketing	Off	109	
Picture Control settings ²	Unmodified	131	
Flash compensation	Off	148	
Exposure compensation	Off	107	
Flash mode			
 Auto front-curtain sync	Auto+red-eye reduction	144	
			Auto slow sync
 P, S, A, M			Front-curtain sync
FV lock	Off	149	
Multiple Exposure	Off	152	
Flexible program	Off	68	

- 1 Focus point not displayed if auto-area AF is selected for AF-area mode.
- 2 Current Picture Control only.



Multiple Exposure

(P, S, A, and M Modes Only)

Follow the steps below to record a series of two or three exposures in a single photograph. Multiple exposures can be recorded at any image quality setting, and make use of RAW data from the camera image sensor to produce colors noticeably superior to those in software-generated photographic overlays.

■ Creating a Multiple Exposure

Multiple exposures can not be recorded in live view. Exit live view before proceeding. Note that at default settings, shooting will end and a multiple exposure will be recorded automatically if no operations are performed for 30 s.

✍ Extended Recording Times

For an interval between exposures of more than 30 s, select **On** for the **Image review** (☐ 200) option in the playback menu and extend the monitor-off delay for image review using Custom Setting c4 (**Monitor off delay**, ☐ 215). The maximum interval between exposures is 30 s longer than the option selected for Custom Setting c4. If no operations are performed for 30 s after the monitor has turned off during playback or menu operations, shooting will end and a multiple exposure will be created from the exposures that have been recorded to that point.

1 Select Multiple exposure.

Press the **MENU** button to display the menus. Highlight **Multiple exposure** in the shooting menu and press ►.

MENU button

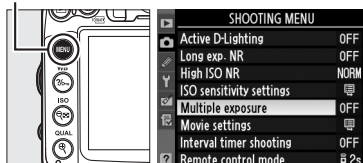

2 Choose the number of shots.

Highlight **Number of shots** and press ►.

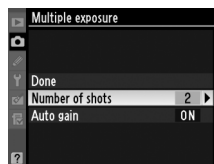

The dialog shown at right will be displayed. Press ▲ or ▼ to choose the number of exposures that will be combined to form a single photograph and press **OK**.

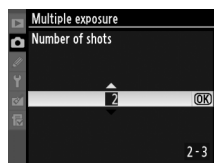

3 Choose the amount of gain.

Highlight **Auto gain** and press ►.

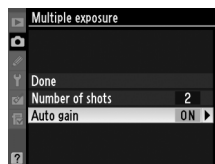

The following options will be displayed.
Highlight an option and press OK.

- **On:** Gain is adjusted according to number of exposures actually recorded (gain for each exposure is set to $1/2$ for 2 exposures, $1/3$ for 3 exposures, etc.).
- **Off:** Gain is not adjusted when recording multiple exposure. Recommended if background is dark.

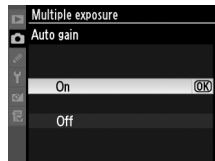

4 Select Done.

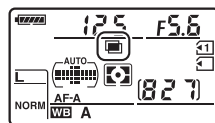
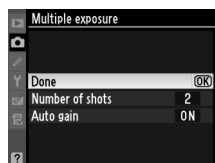

Highlight **Done** and press OK. A  icon will be displayed in the control panel and the **Done** option in the multiple exposure menu will be replaced by **Reset**. To continue shooting without taking a multiple exposure, return to the shooting menu and select **Multiple exposure** > **Reset**.



5 Frame a photograph, focus, and shoot.

In continuous high-speed and continuous low-speed release modes (□ 78), the camera records all exposures in a single burst. In self-timer mode, the camera will automatically record the number of exposures selected in Step 2 on page 152, regardless of the option selected for Custom Setting c3 (**Self-timer**) > **Number of shots** (□ 214). In other release modes, one photograph will be taken each time the shutter-release button is pressed; continue shooting until all exposures have been recorded (for information on interrupting a multiple exposure before all photographs are recorded, see page 154).



The  icon will blink until shooting ends. When shooting ends, multiple exposure mode will end and the  icon will no longer be displayed.

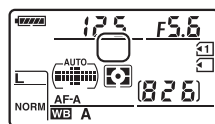

■ Interrupting Multiple Exposures

Selecting **Multiple exposure** in the shooting menu while a multiple exposure is being recorded displays the options shown at right. To interrupt a multiple exposure before the specified number of exposures have been taken, highlight **Cancel** and press **OK**.

If shooting ends before the specified number of exposures have been taken, a multiple exposure will be created from the exposures that have been recorded to that point. If **Auto gain** is on, gain will be adjusted to reflect the number of exposures actually recorded. Note that shooting will end automatically if:

- A two-button reset is performed (151)
- The camera is turned off
- The battery is exhausted
- Pictures are deleted



Multiple Exposures

Do not remove or replace the memory card while recording a multiple exposure.

The information listed in the playback photo information display (including metering, exposure, shooting mode, focal length, date of recording and camera orientation) is for the first shot in the multiple exposure.

Interval Timer Photography

If interval timer photography is activated before the first exposure is taken, the camera will record exposures at the selected interval until the number of exposures specified in the multiple exposure menu have been taken (the number of shots listed in the interval timer shooting menu is ignored). These exposures will then be recorded as a single photograph and multiple exposure mode and interval timer shooting will end. Cancelling multiple exposure cancels interval timer shooting.

Other Settings

While multiple exposure mode is in effect, memory cards can not be formatted and some menu options will not be available.



Interval Timer Photography

The camera is equipped to take photographs automatically at preset intervals.

✔ Before Shooting

Do not select self-timer (☺) or remote (☑) release mode when using the interval timer. Before beginning interval timer photography, take a test shot at current settings and view the results in the monitor.

Before choosing a starting time, select **Time zone and date** in the setup menu and make sure that the camera clock is set to the correct time and date (☑ 237).

Use of a tripod is recommended. Mount the camera on a tripod before shooting begins. To ensure that shooting is not interrupted, be sure the battery is fully charged.

1 Select Interval timer shooting.

Press the MENU button to display the menus. Highlight **Interval timer shooting** in the shooting menu and press ►.

MENU button

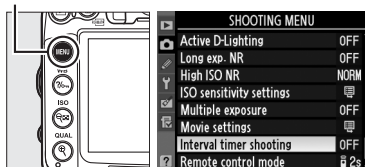

2 Choose a starting time.

Choose from the following starting triggers.

- **To start shooting immediately**, highlight **Now** and press ►. Shooting begins about 3 s after settings are completed; proceed to Step 3.
- **To choose a starting time**, highlight **Start time** and press ► to display the start time options shown at right. Press ◀ or ► to highlight hours or minutes and press ▲ or ▼ to change. Press ► to continue.

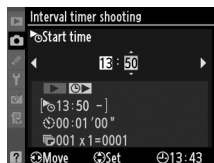
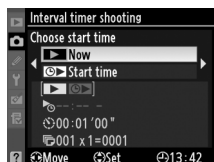

3 Choose the interval.

Press ◀ or ► to highlight hours or minutes and press ▲ or ▼ to choose an interval longer than the slowest anticipated shutter speed. Press ► to continue.

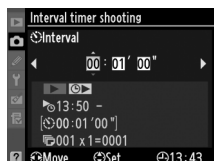

4 Choose the number of intervals and number of shots per interval.

Press ◀ or ▶ to highlight number of intervals or number of shots; press ▲ or ▼ to change. Press ▶ to continue.

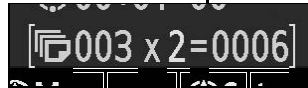
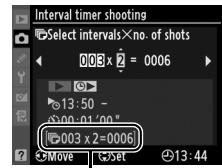

Number of intervals Number of shots/interval Total number of shots

5 Start shooting.

Highlight **On** and press \odot (to return to the shooting menu without starting the interval timer, highlight **Off** and press \odot). The first series of shots will be taken at the specified starting time, or after about 3 s if **Now** was selected for **Choose start time** in Step 2. Shooting will continue at the selected interval until all shots have been taken. Note that because shutter speed and the time needed to record the image to the memory card may vary from shot to shot, the interval between a shot being recorded and the start of the next shot may vary. If shooting can not proceed at current settings (for example, if a shutter speed of $\frac{1}{4}$ is currently selected in manual exposure mode or the start time is in less than a minute), a warning will be displayed in the monitor.

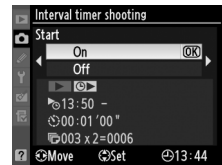

✓ Out of Memory

If the memory card is full, the interval timer will remain active but no pictures will be taken. Resume shooting (☐ 158) after deleting some pictures or turning the camera off and inserting another memory card.

✎ Cover the Viewfinder

To prevent light entering via the viewfinder interfering with exposure, remove the rubber eyecup and cover the viewfinder with the supplied DK-5 eyepiece cap (☐ 81).

✎ Release Mode

Regardless of the release mode selected, the camera will take the specified number of shots at each interval. In **C** (continuous high speed) mode, photographs will be taken at a rate of up to 6 shots per second. In **S** (single frame) and **L** (continuous low-speed) modes, photographs will be taken at the rate chosen for Custom Setting d6 (**CL mode shooting speed**, ☐ 217); in mode **Q**, camera noise will be reduced.

✎ Bracketing

Adjust bracketing settings before starting interval timer photography. If exposure, flash, or ADL bracketing is active while interval timer photography is in effect, the camera will take the number of shots in the bracketing program at each interval, regardless of the number of shots specified in the interval timer menu. If white balance bracketing is active while interval timer photography is in effect, the camera will take one shot at each interval and process it to create the number of copies specified in the bracketing program.

✎ During Shooting

During interval timer photography, the **INTVL** icon in the control panel will blink. Immediately before the next shooting interval begins, the shutter speed display will show the number of intervals remaining, and the aperture display will show the number of shots remaining in the current interval. At other times, the number of intervals remaining and the number of shots in each interval can be viewed by pressing the shutter-release button halfway (once the button is released, the shutter speed and aperture will be displayed until the exposure meters turn off).

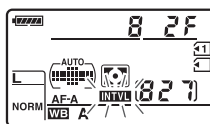

To view current interval timer settings, select **Interval timer shooting** between shots. While interval timer photography is in progress, the interval timer menu will show the starting time, the shooting interval, and the number of intervals and shots remaining. None of these items can be changed while interval timer photography is in progress.

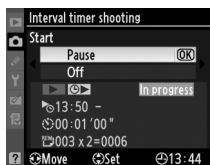

Pictures can be played back and shooting and menu settings can be adjusted freely while interval timer photography is in progress. The monitor will turn off automatically about four seconds before each interval.



■ Pausing Interval Timer Photography

Interval timer photography can be paused by:

- Highlighting **Start** > **Pause** in the interval timer menu and pressing **OK**
- Turning the camera off and then on again (if desired, the memory card can be replaced while the camera is off)
- Rotating the release-mode dial or live view switch

To resume shooting:

1 Choose a new starting time.

Choose a new starting time as described on page 155.

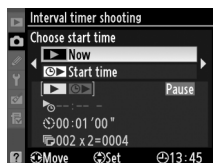

2 Resume shooting.

Highlight **Restart** and press **OK**. Note that if interval timer photography was paused during shooting, any shots remaining in the current interval will be canceled.

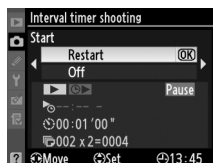

■ Interrupting Interval Timer Photography

Interval timer shooting will end automatically if the battery is exhausted. Interval timer photography can also be ended by:

- Selecting **Start** > **Off** in the interval timer menu
- Performing a two button reset (□ 151)
- Selecting **Reset shooting menu** in the shooting menu (□ 202)
- Changing bracketing settings (□ 109)
- Terminating multiple exposure shooting (□ 154)

Normal shooting will resume when interval timer photography ends.

■ No Photograph

The camera will skip the current interval if any of the following situations persist for eight seconds or more after the interval was due to start: the photograph or photographs for the previous interval have yet to be taken, the memory buffer is full, or the camera is unable to focus in **AF-S** or when single-servo AF is selected in **AF-A** (note that the camera focuses again before each shot). Shooting will resume with the next interval.

Non-CPU Lenses

By specifying lens data (lens focal length and maximum aperture), the user can gain access to a variety of CPU lens functions when using a non-CPU lens (☐ 270). *If the focal length of the lens is known:*

- Power zoom can be used with SB-900, SB-800, SB-700, and SB-600 flash units (available separately)
- Lens focal length is listed (with an asterisk) in the playback photo info display

If the maximum aperture of the lens is known:

- The aperture value is displayed in the control panel and viewfinder
- Flash level is adjusted for changes in aperture
- Aperture is listed (with an asterisk) in the playback photo info display

Specifying both the focal length and maximum aperture of the lens:

- Enables color matrix metering (note that it may be necessary to use center-weighted or spot metering to achieve accurate results with some lenses, including Reflex-NIKKOR lenses)
- Improves the precision of center-weighted and spot metering and i-TTL balanced fill-flash for digital SLR

The camera can store data for up to nine non-CPU lenses. To enter or edit data for a non-CPU lens:

1 Select Non-CPU lens data.

Press the **MENU** button to display the menus. Highlight **Non-CPU lens data** in the setup menu and press ►.

MENU button

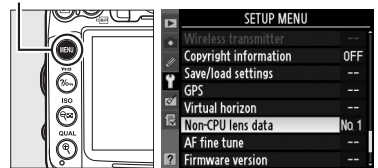

2 Choose a lens number.

Highlight **Lens number** and press ◀ or ▶ to choose a lens number between 1 and 9.

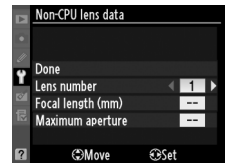

3 Enter the focal length and aperture.

Highlight **Focal length (mm)** or **Maximum aperture** and press ◀ or ▶ to edit the highlighted item. Focal length can be selected from values between 6 and 4,000 mm, maximum aperture from values between f/1.2 and f/22.

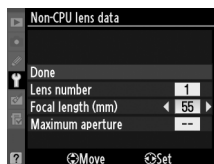

Focal Length Not Listed

If the correct focal length is not listed, choose the closest value greater than the actual focal length of the lens.

Teleconverters and Zoom Lenses

The maximum aperture for teleconverters is the combined maximum aperture of the teleconverter and the lens. Note that lens data are not adjusted when non-CPU lenses are zoomed in or out. The data for different focal lengths can be entered as separate lens numbers, or the data for the lens can be edited to reflect the new values for lens focal length and maximum aperture each time zoom is adjusted.

4 Select Done.

Highlight **Done** and press **OK**. The specified focal length and aperture will be stored under the chosen lens number.

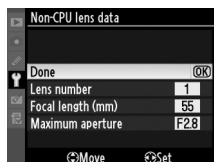

To recall lens data when using a non-CPU lens:

1 Assign non-CPU lens number selection to a camera control.

Select **Choose non-CPU lens number** for Custom Setting f3 (**Assign Fn button**, [☐ 230](#)) or Custom Setting f4 (**Assign preview button**, [☐ 232](#)).

2 Use the selected control to choose the lens number.

Press the selected button and rotate the main command dial until the desired lens number is displayed in the control panel.

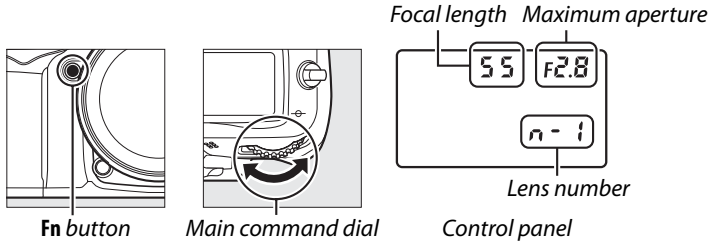

The GP-1 GPS Unit

The GP-1 GPS unit (available separately) can be connected to the camera's accessory terminal (□ 281) using the cable supplied with the GP-1, allowing information on the camera's current position to be recorded when photographs are taken. Turn the camera off before connecting the GP-1; for more information, see the GP-1 manual.

■ Setup Menu Options

The **GPS** item in the setup menu contains the options listed below.

- **Auto meter-off:** Choose whether the exposure meters turn off automatically when the GP-1 is attached.

Option	Description
Enable	Exposure meters turn off automatically if no operations are performed for the time selected for Custom Setting c2 (Auto meter-off delay , □ 214; to allow the camera time to acquire GPS data, the delay is extended by up to one minute after the exposure meters are activated or the camera is turned on). This reduces the drain on the battery.
Disable	Exposure meters do not turn off while the GP-1 is connected.

- **Position:** This item is only available if the GP-1 is connected, when it displays the current latitude, longitude, altitude, and Coordinated Universal Time (UTC) as reported by the GP-1.

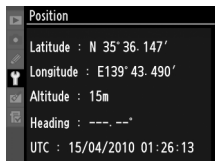

- **Use GPS to set camera clock:** Select **Yes** to synchronize the camera clock with the time reported by the GPS device.

📌 Coordinated Universal Time (UTC)

UTC data is provided by the GPS device and is independent of the camera clock.

📌 The GPS Icon

Connection status is shown by the GPS icon:

- **GPS (static):** Camera has established communication with GP-1. Photo information for pictures taken while this icon is displayed include an additional page of GPS data (□ 169).
- **GPS (flashing):** The GP-1 is searching for a signal. Pictures taken while the icon is flashing do not include GPS data.
- **No icon:** No new GPS data have been received from the GP-1 for at least two seconds. Pictures taken when the GPS icon is not displayed do not include GPS data.

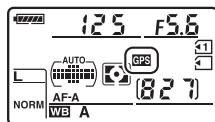



More on Playback

Full-Frame Playback

To play photographs back, press the button. The most recent photograph will be displayed in the monitor.

button

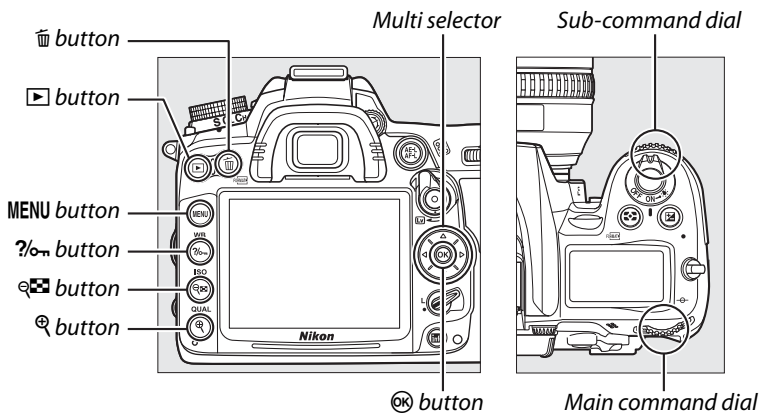
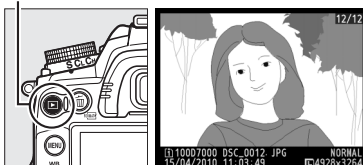









Rotate Tall

To display “tall” (portrait-orientation) photographs in tall orientation, select **On** for the **Rotate tall** option in the playback menu (200).

Image Review

When **On** is selected for **Image review** in the playback menu (200), photographs are automatically displayed in the monitor for about 4 s after shooting (because the camera is already in the correct orientation, images are not rotated automatically during image review). In continuous release mode, display begins when shooting ends, with the first photograph in the current series displayed.



To	Use	Description
View additional photographs		Press ► to view photographs in order recorded, ◀ to view photographs in reverse order.
View photo information		Press ▲ or ▼ to view information about current photograph (□ 165).
View thumbnails		See page 171 for more information.
Zoom in on photograph		See page 173 for more information.
Delete images		Confirmation dialog will be displayed. Press ◻ again to delete photo.
Change protect status		To protect image, or to remove protection from protected image, press ?/m (□ 174).
Return to shooting mode		Monitor will turn off. Photographs can be taken immediately.
Display menus	MENU	See page 195 for more information.
Retouch photo or play movie		Create retouched copy of current photograph (□ 248). If current picture is marked with 📺 icon to show that it is a movie, pressing ⓧ starts movie playback (□ 62).

Choosing a Memory Card Slot

If two memory cards are inserted, you can select a card for playback by holding the **BKT** button and pressing ▲ during full-frame or thumbnail playback. The dialog shown at right will be displayed; highlight the desired slot and press ► to list the folders on the selected card, then highlight a folder and press ⓧ to view the pictures in the highlighted folder. The same procedure can be used when selecting pictures for operations in the playback (□ 195) and retouch (□ 248) menus or when copying white balance from an existing photograph (□ 127).

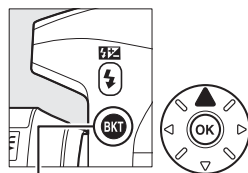

BKT button



See Also

For information on choosing how long the monitor will remain on when no operations are performed, see Custom Setting c4 (**Monitor off delay**, □ 215).

Photo Information

Photo information is superimposed on images displayed in full-frame playback. Press ▲ or ▼ to cycle through photo information as shown below. Note that shooting data, RGB histograms, and highlights are only displayed if corresponding option is selected for **Display mode > Detailed photo info** (☐ 197; shooting data page 4 is only displayed if copyright information was recorded with the photographs as described on page 243). GPS data are only displayed if a GPS device was used when the photo was taken.

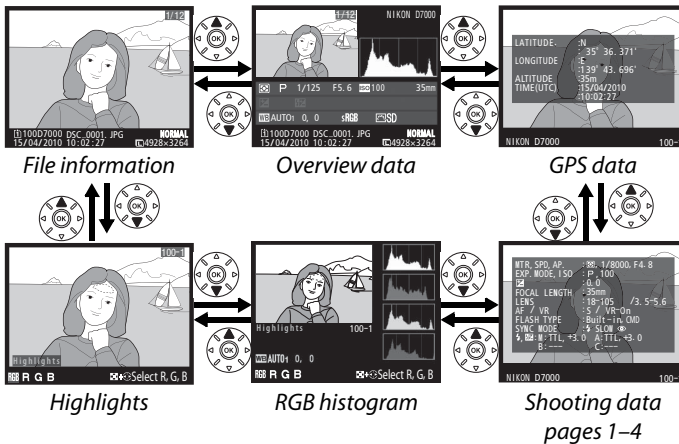

File Information

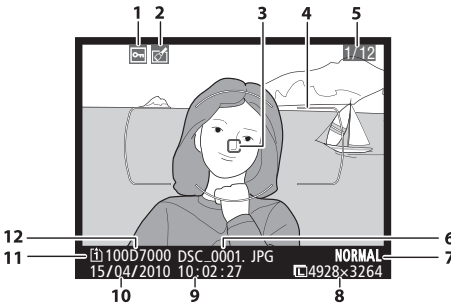

1	Protect status	174
2	Retouch indicator	248
3	Focus point ^{1,2}	96
4	AF area brackets ¹	
5	Frame number/total number of frames	
6	File name	204
7	Image quality	85
8	Image size	88
9	Time of recording	27, 237
10	Date of recording	27, 237
11	Current card slot	46, 164
12	Folder name	203

- 1 Displayed only if **Focus point** is selected for **Display mode** (☐ 197).
- 2 If photograph was taken using **AF-S** or with single-servo autofocus selected during **AF-A**, display shows focus point where focus first locked. If photograph was taken using **AF-C** or with continuous-servo autofocus selected during **AF-A**, focus point is only displayed if option other than auto-area AF was selected for AF-area mode and camera was able to focus.

■ Highlights¹

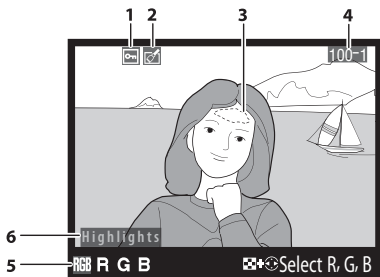

1	Protect status.....	174
2	Retouch indicator	248
3	Image highlights ²	
4	Folder number—frame number	218
5	Current channel ²	
6	Highlight display indicator	

1 Displayed only if **Highlights** is selected for **Display mode** (□ 197).

2 Blinking areas indicate highlights for the current channel. Hold button button and press ◀ or ▶ to cycle through channels as follows:

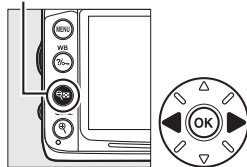
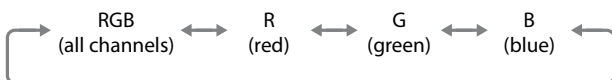

■ RGB Histogram¹

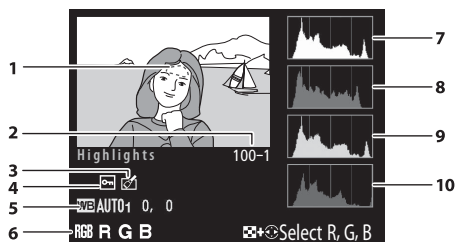

4	Retouch indicator	248
5	White balance	117
	Color temperature.....	122
	White balance fine-tuning	119
	Preset manual	123
6	Current channel ²	
7	Histogram (RGB channel). In all histograms, horizontal axis gives pixel brightness, vertical axis number of pixels.	
8	Histogram (red channel)	
9	Histogram (green channel)	
10	Histogram (blue channel)	

1 Image highlights²

2 Folder number—frame number 218



3 Protect status 174

1 Displayed only if **RGB histogram** is selected for **Display mode** (□ 197).

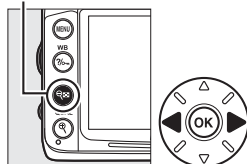
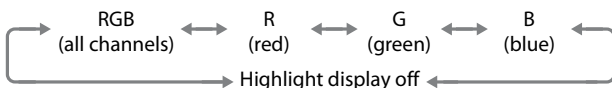
2 Blinking areas indicate highlights for the current channel. Hold button button and press ◀ or ▶ to cycle through channels as follows:



Playback Zoom

To zoom in on the photograph when the histogram is displayed, press . Use the  and  buttons to zoom in and out and scroll the image with the multi selector. The histogram will be updated to show only the data for the portion of the image visible in the monitor.



Histograms

Camera histograms are intended as a guide only and may differ from those displayed in imaging applications. Some sample histograms are shown below:

If the image contains objects with a wide range of brightnesses, the distribution of tones will be relatively even.

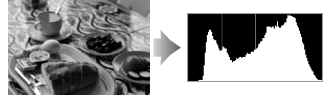

If the image is dark, tone distribution will be shifted to the left.

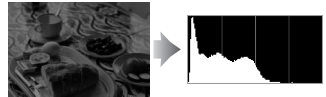

If the image is bright, tone distribution will be shifted to the right.



Increasing exposure compensation shifts the distribution of tones to the right, while decreasing exposure compensation shifts the distribution to the left. Histograms can provide a rough idea of overall exposure when bright ambient lighting makes it difficult to see photographs in the monitor.

Shooting Data Page 1¹

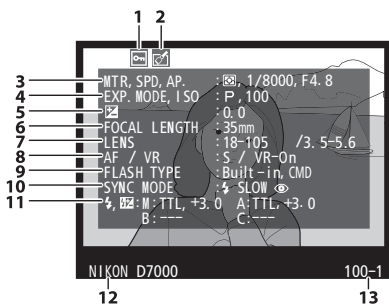

1	Protect status	174
2	Retouch indicator	248
3	Metering	105
	Shutter speed.....	67
	Aperture.....	67

- 1 Displayed only if **Data** is selected for **Display mode** (□ 197).
- 2 Displayed in red if photo was taken with auto ISO sensitivity control on.
- 3 Displayed if Custom Setting b5 (**Fine tune optimal exposure**, □ 213) has been set to a value other than zero for any metering method.
- 4 Displayed only if VR lens is attached.

Shooting Data Page 2¹

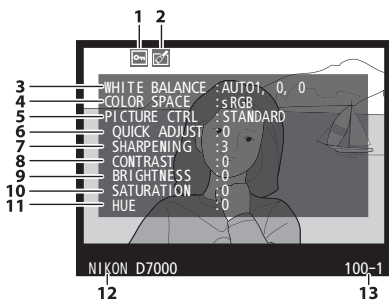

1	Protect status	174
2	Retouch indicator	248
3	White balance	117
	Color temperature	122
	White balance fine-tuning.....	119
	Preset manual.....	123

- 1 Displayed only if **Data** is selected for **Display mode** (□ 197).
- 2 **Standard, Vivid, Portrait, and Landscape** Picture Controls only.
- 3 **Neutral, Monochrome**, and custom Picture Controls.
- 4 Not displayed with monochrome Picture Controls.
- 5 Monochrome Picture Controls only.

4	Shooting mode.....	6
	ISO sensitivity ²	101
5	Exposure compensation.....	107
	Optical exposure tuning ³	213
6	Focal length	159, 274
7	Lens data	
8	Focus mode.....	91, 99
	Lens VR (vibration reduction) ⁴	26
9	Flash type.....	143, 275
	Commander mode.....	225
10	Flash mode.....	144
11	Flash control	223
	Flash compensation.....	148
12	Camera name	
13	Folder number—frame number	218

4	Color space.....	141
5	Picture Control.....	131
6	Quick adjust ²	134
	Original Picture Control ³	137
7	Sharpening.....	134
8	Contrast.....	134
9	Brightness.....	134
10	Saturation ⁴	134
	Filter effects ⁵	134
11	Hue ⁴	134
	Toning ⁵	134, 135
12	Camera name	
13	Folder number—frame number	218

Shooting Data Page 3*

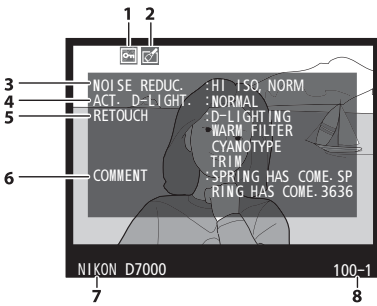

* Displayed only if **Data** is selected for **Display mode** (□ 197).

1	Protect status	174
2	Retouch indicator	248
3	High ISO noise reduction	205
	Long exposure noise reduction	205
4	Active D-Lighting	139
5	Retouch history	248
6	Image comment	238
7	Camera name	
8	Folder number—frame number	218

Shooting Data Page 4*

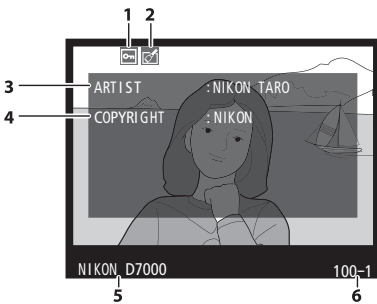

* Displayed only if **Data** is selected for **Display mode** (□ 197) and copyright information is appended to photograph (□ 243).

1	Protect status	174
2	Retouch indicator	248
3	Name of photographer	243
4	Copyright holder	243
5	Camera name	
6	Folder number—frame number	218

GPS Data*

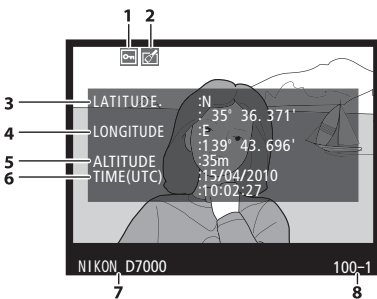

* Displayed only if GPS device was used when photo was taken (□ 162); data for movies are for start of recording.

1	Protect status	174
2	Retouch indicator	248
3	Latitude	
4	Longitude	
5	Altitude	
6	Coordinated Universal Time (UTC)	
7	Camera name	
8	Folder number—frame number	218



Overview Data

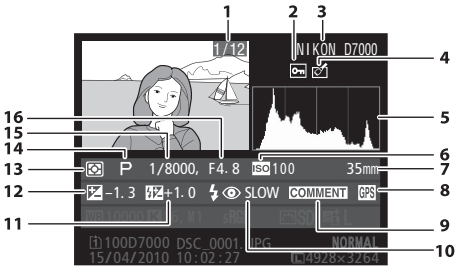

- 1** Frame number/total number of images
- 2** Protect status 174
- 3** Camera name
- 4** Retouch indicator 248

* Displayed in red if photo was taken with auto ISO sensitivity control on.

- 5** Histogram showing the distribution of tones in the image (□ 167).
- 6** ISO sensitivity * 101
- 7** Focal length 159, 274
- 8** GPS data indicator 162
- 9** Image comment indicator 238
- 10** Flash mode 144
- 11** Flash compensation 148
- 12** Commander mode 225
- 13** Exposure compensation 107
- 14** Metering 105
- 15** Shooting mode 6
- 16** Aperture 67

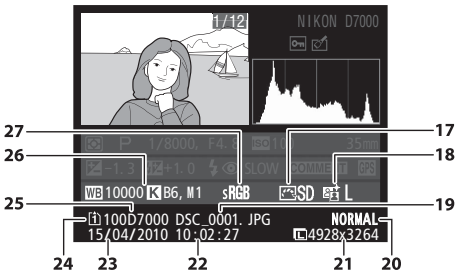

- 17** Picture Control 131
- 18** Active D-Lighting 139

- 19** File name 204
- 20** Image quality 85
- 21** Image size 88
- 22** Time of recording 27, 237
- 23** Date of recording 27, 237
- 24** Current card slot 46, 164
- 25** Folder name 203
- 26** White balance 117
 - Color temperature 122
 - White balance fine-tuning 119
 - Preset manual 123
- 27** Color space 141

Thumbnail Playback

To display images in “contact sheets” of four, nine, or 72 images, press the button.

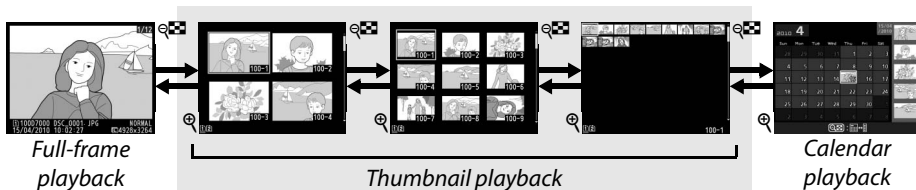



To	Use	Description
Display more images		Press to increase the number of images displayed.
Display fewer images		Press to reduce the number of images displayed. When four images are displayed, press to view highlighted image full frame.
Highlight images		Use multi selector to highlight images for full-frame playback, playback zoom (173), deletion (175), or protection (174).
View highlighted image		Press to display the highlighted image full frame.
Delete highlighted image		See page 175 for more information.
Change protect status of highlighted image		See page 174 for more information.
Return to shooting mode	/	Monitor will turn off. Photographs can be taken immediately.
Display menus	MENU	See page 195 for more information.



Calendar Playback

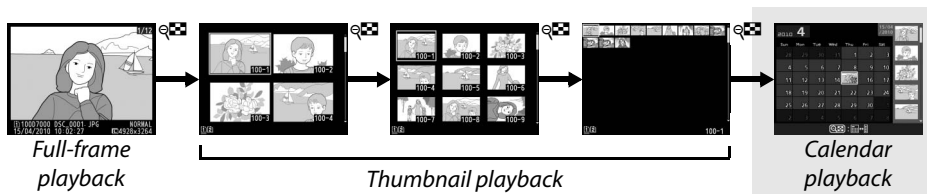





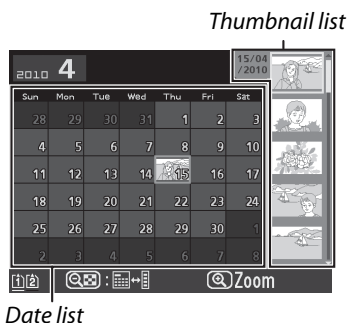



To view images taken on a selected date, press the  button when 72 images are displayed.



Press the  button to toggle between the date list and the list of thumbnails for the selected date. Use the multi selector to highlight dates in the date list or to highlight pictures in the thumbnail list.













The operations can be performed depend on whether the cursor is in the date list or the thumbnail list:

To	Use	Description
Toggle between date list and thumbnail list		Press  button in date list to place cursor in thumbnail list. Press again to return to date list.
Exit to thumbnail playback/Zoom in on highlighted photo		<ul style="list-style-type: none"> Date list: Exit to 72-frame playback. Thumbnail list: Press and hold  button to zoom in on highlighted picture.
Highlight dates/Highlight images		<ul style="list-style-type: none"> Date list: Highlight date. Thumbnail list: Highlight picture.
Toggle full frame playback		<ul style="list-style-type: none"> Date list: View first picture taken on selected date. Thumbnail list: View highlighted picture.
Delete highlighted photo(s)		<ul style="list-style-type: none"> Date list: Delete all pictures taken on selected date. Thumbnail list: Delete highlighted picture ( 175).
Change protect status of highlighted photo		See page 174 for more information.
Return to shooting mode		Monitor will turn off. Photographs can be taken immediately.
Display menus	MENU	See page 195 for more information.

Taking a Closer Look: Playback Zoom

Press the  button to zoom in on the image displayed in full-frame playback or on the image currently highlighted in thumbnail or calendar playback. The following operations can be performed while zoom is in effect:

To	Use	Description
Zoom in or out	 / 	Press  to zoom in to maximum of approximately 31 × (large images), 23 × (medium images) or 15 × (small images). Press  to zoom out. While photo is zoomed in, use multi selector to view areas of image not visible in monitor. Keep multi selector pressed to scroll rapidly to other areas of frame. Navigation window is displayed when zoom ratio is altered; area currently visible in monitor is indicated by yellow border. 
Select faces		Faces (up to 35) detected during zoom are indicated by white borders in navigation window. Rotate sub-command dial to view other faces. 
View other images		Rotate main command dial to view same location in other images at current zoom ratio.
Change protect status		See page 174 for more information.
Return to shooting mode	 / 	Monitor will turn off. Photographs can be taken immediately.
Display menus	MENU	See page 195 for more information.



Protecting Photographs from Deletion

In full-frame, zoom, thumbnail, and calendar playback, the **Protect** button can be used to protect photographs from accidental deletion. Protected files can not be deleted using the **Delete** button or the **Delete** option in the playback menu. Note that protected images *will* be deleted when the memory card is formatted (see 32).

To protect a photograph:

1 Select an image.

Display the image in full-frame playback or playback zoom or highlight it in the thumbnail list in thumbnail or calendar playback.



Full-frame playback



Thumbnail playback



Calendar playback

2 Press the **Protect** button.

The photograph will be marked with a lock icon. To remove protection from the photograph so that it can be deleted, display the photograph or highlight it in the thumbnail list and then press the **Protect** button.

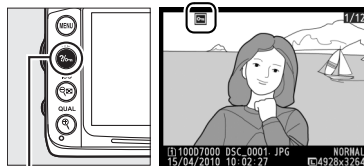

Protect button

Removing Protection from All Images

To remove protection from all images in the folder or folders currently selected in the **Playback folder** menu, press the **Protect** and **Delete** buttons together for about two seconds during playback.



Deleting Photographs

To delete the photograph displayed in full-frame playback or the photograph highlighted in the thumbnail list, press the  button. To delete multiple selected photographs, all photographs taken on a selected date, or all photographs in the current playback folder, use the **Delete** option in the playback menu. Once deleted, photographs can not be recovered.

Full-Frame, Thumbnail, and Calendar Playback

Press the  button to delete the current photograph.

1 Select an image.

Display the image or highlight it in the thumbnail list in thumbnail or calendar playback.

2 Press the button.

A confirmation dialog will be displayed.

 button

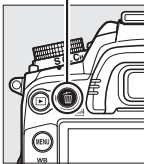

Full-frame playback



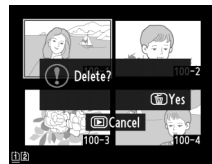

Thumbnail playback



Calendar playback
(thumbnail list)



3 Press the button again.

To delete the photograph, press the  button again. To exit without deleting the photograph, press the  button.

 button

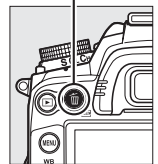

Calendar Playback

During calendar playback, you can delete all photographs taken on a selected date by highlighting the date in the date list and pressing the  button (□ 172).





See Also

The **After delete** option in the playback menu determines whether the next or previous image is displayed after an image is deleted (□ 200).



The Playback Menu

The **Delete** option in the playback menu contains the following options. Note that depending on the number of images, some time may be required for deletion.

Option	Description
 Selected	Delete selected pictures.
 Select date	Delete all pictures taken on a selected date ( 177).
ALL All	Delete all pictures in the folder currently selected for playback ( 195). If two cards are inserted, you can select the card from which pictures will be deleted.



■ Selected: Deleting Selected Photographs



1 Choose Selected.

Press the **MENU** button and select **Delete** in the playback menu. Highlight **Selected** and press .

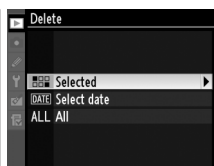
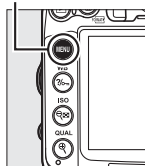
MENU button





2 Highlight a picture.

Use the multi selector to highlight a picture (to view the highlighted picture full screen, press and hold the  button; to view images in other locations, hold the **BKT** button, press , and select the desired card and folder as described on page 164).



3 Select the highlighted picture.

Press the  button to select the highlighted picture. Selected pictures are marked by a  icon. Repeat steps 2 and 3 to select additional pictures; to deselect a picture, highlight it and press .

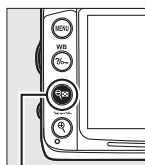

 button

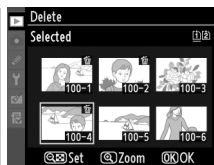

4 Press **OK** to complete the operation.

A confirmation dialog will be displayed; highlight **Yes** and press **OK**.



■ Select Date: Deleting Photographs Taken on a Selected Date

1 Choose **Select date**.

In the delete menu, highlight **Select date** and press **▶**.

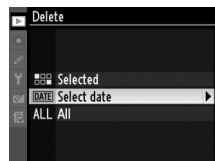

2 Highlight a date.

Use the multi selector to highlight a date.

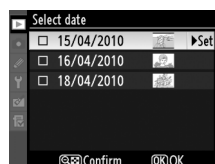

To view the pictures taken on the highlighted date, press **Q**. Use the multi selector to scroll through the pictures, or press and hold **Q** to view the current picture full screen. Press **Q** to return to the date list.



Q button



3 Select the highlighted date.

Press **▶** to select all pictures taken on the highlighted date. Selected dates are marked with a **☑** icon. Repeat steps 2 and 3 to select additional dates; to deselect a date, highlight it and press **▶**.

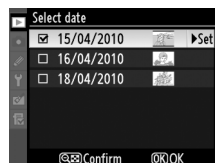

4 Press **OK** to complete the operation.

A confirmation dialog will be displayed; highlight **Yes** and press **OK**.

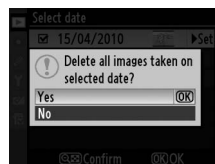



Connections

Connecting to a Computer

This section describes how to use the supplied UC-E4 USB cable to connect the camera to a computer.

Before Connecting the Camera

Before connecting the camera, install the software on the supplied ViewNX 2 CD. To ensure that data transfer is not interrupted, be sure the camera EN-EL15 battery is fully charged. If in doubt, charge the battery before use or use an EH-5a AC adapter and EP-5B power connector (available separately).

■ Supplied Software

ViewNX 2 includes a “Nikon Transfer 2” function for copying pictures from the camera to the computer, where ViewNX 2 can be used to view and print selected images or to edit photographs and movies. For more information, see ViewNX 2 online help.

■ Supported Operating Systems

The supplied software can be used with computers running the following operating systems:

- **Windows:** Windows 7 (Home Basic/Home Premium/Professional/Enterprise/Ultimate), Windows Vista Service Pack 2 (Home Basic/Home Premium/Business/Enterprise/Ultimate) and Windows XP Service Pack 3 (Home Edition/Professional). ViewNX 2 runs as 32-bit applications in 64-bit editions of Windows 7 and Windows Vista.
- **Macintosh:** Mac OS X (version 10.4.11, 10.5.8, 10.6.4)

See the websites listed on page xvii for the latest information on supported operating systems.

Connecting Cables

Be sure the camera is off when connecting or disconnecting interface cables. Do not use force or attempt to insert the connectors at an angle. Close the camera connector cover when the connector is not in use.

During Transfer

Do not turn the camera off or disconnect the USB cable while transfer is in progress.

Windows

To visit the Nikon website after installing ViewNX 2, select **All Programs > Link to Nikon** from the Windows start menu (Internet connection required).

Connecting the Camera

Connect the camera using the supplied UC-E4 USB cable.

1 Turn the camera off.

2 Turn the computer on.

Turn the computer on and wait for it to start up.

3 Connect the USB cable.

Connect the USB cable as shown. Do not use force or attempt to insert the connectors at an angle.

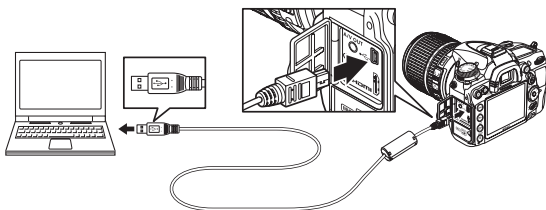

USB Hubs

Connect the camera directly to the computer; do not connect the cable via a USB hub or keyboard.

4 Turn the camera on.

5 Transfer photographs.

After following the on-screen instructions to start Nikon Transfer 2, click **Start Transfer** to transfer photographs (for more information on using Nikon Transfer 2, start ViewNX 2 or Nikon Transfer 2 and select **ViewNX 2 Help** from the **Help** menu).

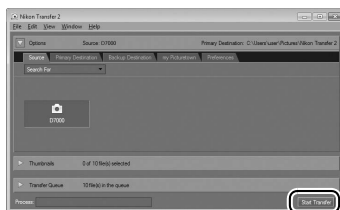

Start Transfer

6 Turn the camera off and disconnect the USB cable when transfer ends.

Nikon Transfer 2 will close automatically when transfer is complete.

Wireless and Ethernet Networks

If the optional WT-4 wireless transmitter (☐ 280) is attached, photographs can be transferred or printed over wireless or Ethernet networks and the camera can also be controlled from network computers running Camera Control Pro 2 (available separately). The WT-4 can be used in any of the following modes:

Mode	Function
Transfer mode	Upload new or existing photographs to computer or ftp server.
Thumbnail select mode	Preview photographs on computer monitor before upload.
PC mode	Control camera from computer using Camera Control Pro 2 (available separately).
Print mode	Print JPEG photographs on printer connected to network computer.

For more information, see the WT-4 user's manual. Be sure to update to the latest versions of the WT-4 firmware and supplied software.

Transfer Mode

When the WT-4 is connected to the camera in transfer mode, the picture currently displayed in full-frame playback can be uploaded to the computer by pressing the **BKT** and  buttons.

Movies

The WT-4 can be used to upload movies in transfer mode if **Auto send** or **Send folder** is not selected for **Transfer settings**. Movies can not be uploaded in thumbnail selector mode.



Recording and Viewing Movies During Transfer

Movies can not be recorded or played back in image transfer mode when a WT-4 is connected to the camera ("image transfer mode" applies when images are being transferred and when images remain to be sent).

Thumbnail Select Mode

Camera settings can not be changed from the computer in thumbnail select mode.

Camera Control Pro 2

Camera Control Pro 2 software (available separately) can be used to control the camera from a computer. When Camera Control Pro 2 is used to capture photographs directly to the computer, the PC connection indicator ( ) will appear in the control panel.



Printing Photographs

To print selected JPEG pictures on a PictBridge printer via a direct USB connection, follow the steps below.

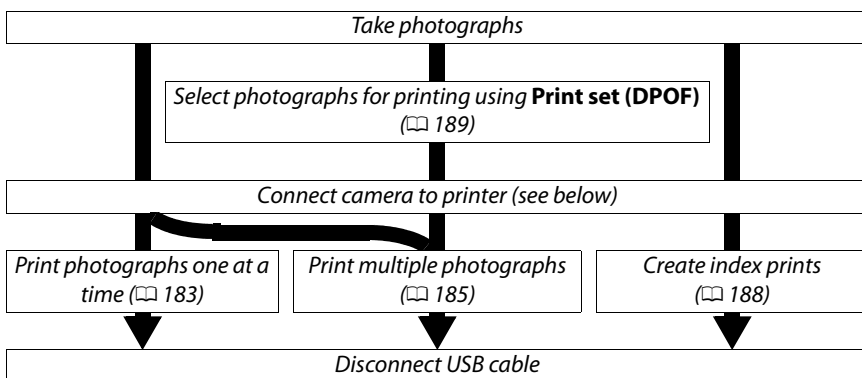

Printing Via Direct USB Connection

Be sure the EN-EL15 battery is fully charged or use an optional EH-5a AC adapter and EP-5B power connector. When taking photographs to be printed via direct USB connection, set **Color space** to **sRGB** (141).

Connecting the Printer

Connect the camera using the supplied UC-E4 USB cable.

1 Turn the camera off.

2 Connect the USB cable.

Turn the printer on and connect the USB cable as shown. Do not use force or attempt to insert the connectors at an angle.

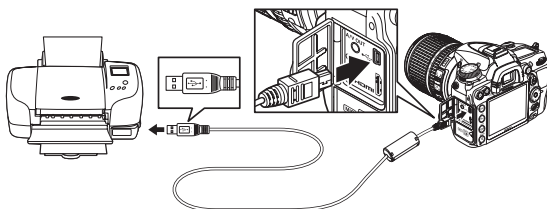

USB Hubs

Connect the camera directly to the printer; do not connect the cable via a USB hub.





3 Turn the camera on.

A welcome screen will be displayed in the monitor, followed by a PictBridge playback display.



Printing Pictures One at a Time

1 Select a picture.

Press ◀ or ▶ to view additional pictures, or press ▲ or ▼ to view photo information (165). Press the  button to zoom in on the current frame (173; press  to exit zoom). To view six pictures at a time, press the  button. Use the multi selector to highlight pictures, or press  to display the highlighted picture full frame; to view images in other locations, hold the **BKT** button, press ▲, and select the desired card and folder as described on page 164.

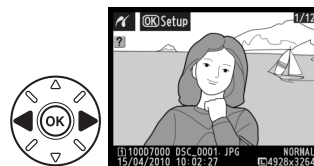

2 Display printing options.

Press  to display PictBridge printing options.

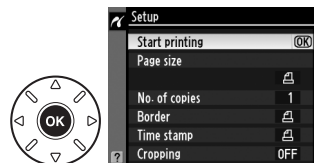

3 Adjust printing options.

Press ▲ or ▼ to highlight an option and press ► to select.

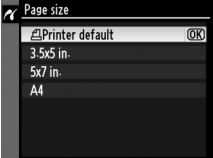
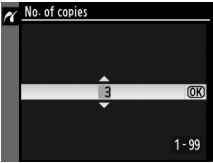
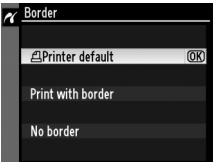
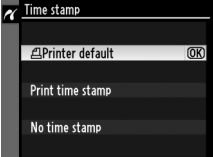
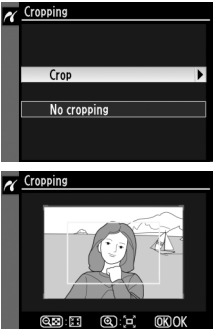
Option	Description	
<p>Page size</p>	<p>Menu of page sizes will be displayed (options not supported by current printer are not listed). Press ▲ or ▼ to choose page size (to print at default page size for current printer, select Printer default), then press OK to select and return to previous menu.</p>	
<p>No. of copies</p>	<p>Menu shown at right will be displayed. Press ▲ or ▼ to choose number of copies (maximum 99), then press OK to select and return to previous menu.</p>	
<p>Border</p>	<p>This option is available only if supported by current printer. Menu shown at right will be displayed. Press ▲ or ▼ to choose print style from Printer default (print using current printer settings), Print with border (print photo with white border), or No border, then press OK to select and return to previous menu. Only options supported by current printer will be displayed.</p>	
<p>Time stamp</p>	<p>Menu shown at right will be displayed. Press ▲ or ▼ to choose Printer default (print using current printer settings), Print time stamp (print time and date of recording on photo), or No time stamp, then press OK to select and return to previous menu.</p>	
<p>Cropping</p>	<p>This option is available only with printers that support cropping. Menu shown at right will be displayed. To exit without cropping picture, highlight No cropping and press OK. To crop picture, highlight Crop and press ►.</p> <p>If Crop is selected, dialog shown at right will be displayed. Press ↻ to increase size of crop, ↻ to decrease. Choose position of crop using multi selector and press OK. Note that print quality may drop if small crops are printed at large sizes.</p>	

4 Start printing.

Select **Start printing** and press **OK** to start printing. To cancel before all copies have been printed, press **OK**.



NEF (RAW)

NEF (RAW) photographs (□ 85) can not be printed by direct USB connection. JPEG copies of NEF (RAW) images can be created using the **NEF (RAW) processing** option in the retouch menu (□ 258).

Connecting Cables

Be sure the camera is off when connecting or disconnecting interface cables. Do not use force or attempt to insert the connectors at an angle. Close the camera connector cover when the connector is not in use.

Printing Multiple Pictures

1 Display the PictBridge menu.

Press the **MENU** button in the PictBridge playback display (see Step 3 on page 183).



MENU button

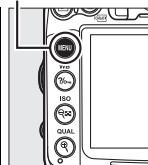

2 Choose an option.

Highlight one of the following options and press **▶**.

- **Print select:** Select pictures for printing.
- **Select date:** Print one copy of all the pictures taken on a selected date.
- **Print (DPOF):** Print an existing print order created with the **Print set (DPOF)** option in the playback menu (□ 189). The current print order will be displayed in Step 3.

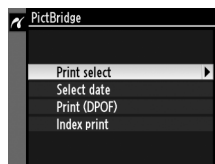



To create an index print of all JPEG pictures on the memory card, select **Index print**. See page 188 for more information.



3 Select pictures or choose a date.

If you chose **Print select** or **Print (DPOF)** in **Step 2**, use the multi selector to scroll through the pictures on the memory card; to view images in other locations, hold the **BKT** button, press **▲**, and select the desired card and folder as described on page 164. To display the current picture full screen, press and hold the **Q** button. To select the current picture for printing, hold the **Q** button and press **▲**. The picture will be marked with a  icon and the number of prints will be set to 1. Keeping the **Q** button pressed, press **▲** or **▼** to specify the number of prints (up to 99; to deselect the picture, press **▼** when the number of prints is 1). Continue until all the desired pictures have been selected.

Selecting Photographs for Printing

NEF (RAW) photographs () 85) can not be selected for printing. JPEG copies of NEF (RAW) images can be created using the **NEF (RAW) processing** option in the retouch menu () 258).

If you chose **Select date** in **Step 2**, press **▲** or **▼** to highlight a date and press **▶** to toggle the highlighted date on or off. To view the pictures taken on the selected date, press **Q**. Use the multi selector to scroll through the pictures, or press and hold **Q** to view the current picture full screen. Press **Q** again to return to the date selection dialog.

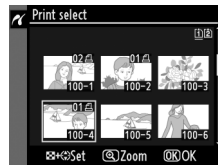

Q + **▲** / **▼**: Choose number of copies

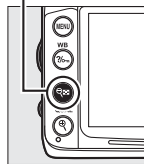

Q button: View photo full screen

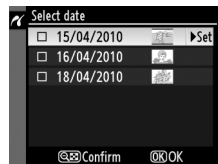
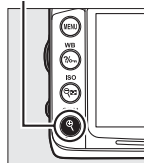

Q button: View photos for selected date

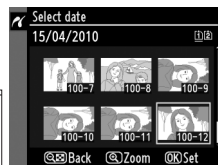
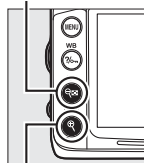

Q button: View highlighted photo full screen



4 Display printing options.

Press **OK** to display PictBridge printing options.

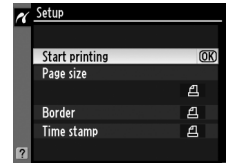

5 Adjust printing options.

Press **▲** or **▼** to highlight an option and press **▶** to select.

Option	Description
Page size	Menu of page sizes will be displayed (□ 184; options not supported by current printer are not listed). Press ▲ or ▼ to choose page size (to print at default page size for current printer, select Printer default), then press OK to select and return to previous menu.
Border	Menu of border options will be displayed (□ 184; options not supported by current printer are not listed). Press ▲ or ▼ to choose print style from Printer default (print at current printer settings), Print with border (print photo with white border), or No border , then press OK to select and return to previous menu.
Time stamp	Menu of time stamp options will be displayed (□ 184). Press ▲ or ▼ to choose Printer default (print at current printer settings), Print time stamp (print time and date of recording on photo), or No time stamp , then press OK to select and return to previous menu.

6 Start printing.

Select **Start printing** and press **OK** to start printing. To cancel before all copies have been printed, press **OK**.



Errors

See page 308 for information on what to do if an error occurs during printing.



Creating Index Prints

To create an index print of all JPEG pictures on the memory card, select **Index print** in Step 2 of "Printing Multiple Pictures" (☰ 185). Note that if the memory card contains more than 256 pictures, only the first 256 images will be printed.

1 Select Index print.

Selecting **Index print** in the PictBridge menu (☰ 185) displays the images on the memory card as shown at right.

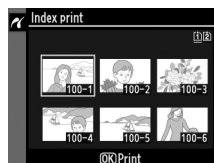

2 Display printing options.

Press **OK** to display PictBridge printing options.

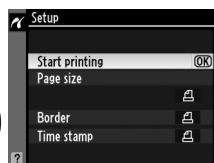

3 Adjust printing options.

Choose page size, border, and time stamp options as described on page 187 (a warning will be displayed if the selected page size is too small).

4 Start printing.

Select **Start printing** and press **OK** to start printing. To cancel before printing is complete, press **OK**.



Creating a DPOF Print Order: Print Set

The **Print set (DPOF)** option in the playback menu is used to create digital “print orders” for PictBridge-compatible printers and devices that support DPOF.

1 Choose Select/set for the Print set (DPOF) item in the playback menu.

Press the **MENU** button and select **Print set (DPOF)** in the playback menu. Highlight **Select/set** and press **▶** (to remove all photographs from the print order, select **Deselect all?**).

MENU button

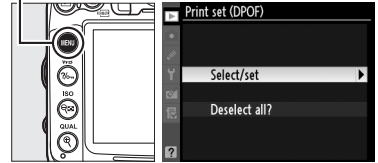

2 Select pictures.

Use the multi selector to scroll through the pictures on the memory card (to view images in other locations, hold the **BKT** button and press **▲**). To display the current picture in full screen, press and hold the **Q** button. To select the current picture for printing, hold the **Q** button and press **▲**. The picture will be marked with a **📄** icon and the number of prints will be set to 1. Keeping the **Q** button pressed, press **▲** or **▼** to specify the number of prints (up to 99; to deselect the picture, press **▼** when the number of prints is 1). Continue until all the desired pictures have been selected.

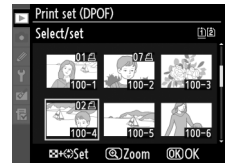

Q + **▲** / **▼**: Choose number of copies

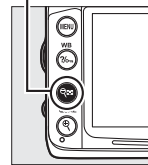

Q button: View photo full screen

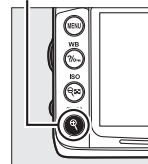

3 Display imprint options.

Press **OK** to display data imprint options.

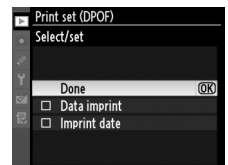

4 Select imprint options.

Highlight the following options and press ► to toggle the highlighted option on or off (to complete the print order without including this information, proceed to Step 5).

- **Data imprint:** Print shutter speed and aperture on all pictures in print order.
- **Imprint date:** Print date of recording on all pictures in print order.

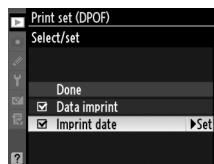

5 Complete the print order.

Highlight **Done** and press OK to complete the print order.

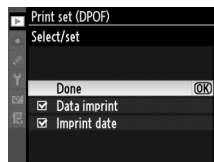

✓ Print Set (DPOF)

To print the current print order when the camera is connected to a PictBridge printer, select **Print (DPOF)** in the PictBridge menu and follow the steps in "Printing Multiple Pictures" to modify and print the current order (□ 185). DPOF date and data imprint options are not supported when printing via direct USB connection; to print the date of recording on photographs in the current print order, use the PictBridge **Time stamp** option.

The **Print set (DPOF)** option can not be used if there is not enough space on the memory card to store the print order.

NEF (RAW) photographs (□ 85) can not be selected using this option. JPEG copies of NEF (RAW) images can be created using the **NEF (RAW) processing** option in the retouch menu (□ 258).

Print orders may not print correctly if images are deleted using a computer or other device after the print order is created.

Viewing Photographs on TV

The supplied EG-D2 audio video (A/V) cable can be used to connect the camera to a television or video recorder for playback or recording. A type C mini-pin High-Definition Multimedia Interface (HDMI) cable (available separately from third-party suppliers) can be used to connect the camera to high-definition video devices.

Standard Definition Devices

Before connecting the camera to a standard television, confirm that the camera video standard (☐ 237) matches that used in the TV.

1 Turn the camera off.

Always turn the camera off before connecting or disconnecting the A/V cable.

2 Connect the A/V cable as shown.

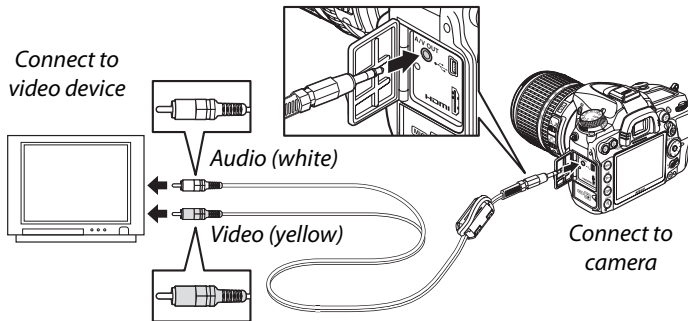

3 Tune the television to the video channel.

4 Turn the camera on and press the button.

During playback, image will be displayed both in the camera monitor and on the television screen. Note that the edges of images may not be displayed.



Video Mode

If no image is displayed, check that camera is correctly connected and that the option selected for **Video mode** (📖 237) matches the video standard used in the TV.

Television Playback

Use of an EH-5a AC adapter and EP-5B power connector (available separately) is recommended for extended playback.

Slide Shows

The **Slide show** option in the playback menu can be used for automated playback (📖 201).

Audio

When a movie with sound recorded in stereo using an external microphone is viewed on a television connected to the camera via an A/V cable, the audio output is monaural. HDMI connections support stereo output. Volume can be adjusted using television controls; the camera controls can not be used.

Close the Connector Cover

Close the camera connector cover when the connectors are not in use. Foreign matter in the connectors can interfere with data transfer.



High-Definition Devices

The camera can be connected to HDMI devices using a type C mini-pin HDMI cable (available separately from third-party suppliers).

1 Turn the camera off.

Always turn the camera off before connecting or disconnecting an HDMI cable.

2 Connect the HDMI cable as shown.

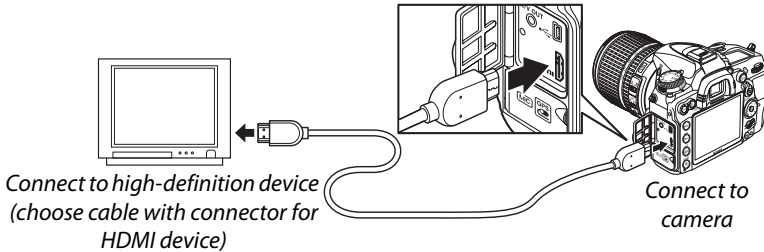

3 Tune the device to the HDMI channel.

4 Turn the camera on and press the button.

During playback, images will be displayed on the high-definition television or monitor screen; the camera monitor will remain off.

Close the Connector Cover

Close the camera connector cover when the connectors are not in use. Foreign matter in the connectors can interfere with data transfer.



■ ■ HDMI Options

The **HDMI** option in the setup menu controls output resolution and can be used to enable the camera for remote control from devices that support HDMI-CEC (High-Definition Multimedia Interface–Consumer Electronics Control, a standard that allows HDMI devices to be used to control peripherals to which they are connected).

Output Resolution

Choose the format for images output to the HDMI device. If **Auto** is selected, the camera will automatically select the appropriate format.

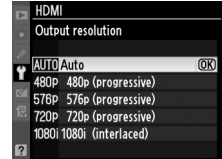

Device Control

If **On** is selected for **HDMI > Device control** in the setup menu when the camera is connected to a television that supports HDMI-CEC and both the camera and television are on, the display shown at right will appear on the television and the television remote can be used in place of the camera multi selector and **OK** button during full-frame playback and slide shows. If **Off** is selected, the television remote can not be used to control the camera.



HDMI-CEC Devices

When the camera is connected to an HDMI-CEC device, **Ⓛ Ⓛ Ⓛ** will appear in the control panel in place of the number of exposures remaining.

Device Control

See the television manual for details.



Menu Guide

▶ The Playback Menu: *Managing Images*

To display the playback menu, press MENU and select the ▶ (playback menu) tab.

MENU button

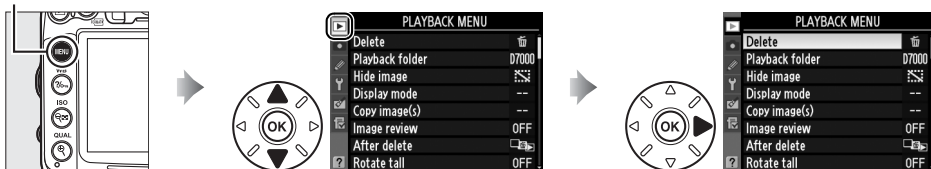

The playback menu contains the following options:

Option	📖	Option	📖
Delete	176	Image review	200
Playback folder	195	After delete	200
Hide image	196	Rotate tall	200
Display mode	197	Slide show	201
Copy image(s)	197	Print set (DPOF)	189

Playback Folder

MENU button → ▶ playback menu

Choose a folder for playback (📖 163):

Option	Description
D7000	Pictures in all folders created with the D7000 will be visible during playback.
All	Pictures in all folders will be visible during playback.
Current	Only pictures in the current folder will be visible during playback.

Hide Image

MENU button → playback menu

Hide or reveal pictures. Hidden pictures are visible only in the **Hide image** menu and can only be deleted by formatting the memory card.

Option	Description
Select/set	Hide or reveal selected pictures.
Select date	Selecting this option displays a list of dates. To hide all pictures taken on a date, highlight the date and press ►. Selected dates are marked by a ✓; to reveal all pictures taken on a selected date, highlight it and press ►. Press OK to complete the operation.
Deselect all?	Reveal all pictures.



Protected and Hidden Images

Revealing a protected image will also remove protection from the image.

Follow the steps below to hide or reveal selected pictures.

1 Choose Select/set.

Highlight **Select/set** and press ►.



2 Select pictures.

Use the multi selector to scroll through the pictures on the memory card (to view the highlighted picture full screen, press and hold the button; to view images in other locations as described on page 164, hold **BKT** and press **▲**) and press to select the current picture. Selected pictures are marked by a icon; to deselect a picture, highlight it and press again. Continue until all the desired pictures have been selected.

button

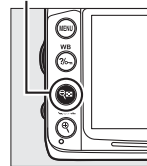

3 Press OK.

Press **OK** to complete the operation.

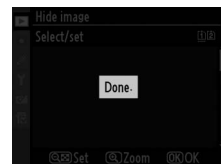

Display Mode

MENU button → playback menu

Choose the information available in the playback photo information display (165). Press ▲ or ▼ to highlight an option, then press ► to select the option for the photo information display. A ✓ appears next to selected items; to deselect, highlight and press ►. To return to the playback menu, highlight **Done** and press .

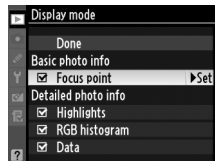

Copy Image(s)

MENU button → playback menu

Copy images between memory cards. This option is only available when two memory cards are inserted in the camera.

Option	Description
Select source	Select the card from which pictures will be copied.
Select image(s)	Select the pictures to be copied.
Select destination folder	Select the folder to which pictures will be copied.
Copy image(s)?	Copy the images.

To copy images:

1 Choose Select source.

Highlight **Select source** and press ►.

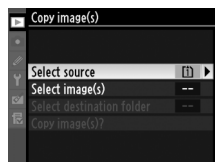

2 Select the source card.

Highlight the slot containing the card from which images will be copied and press .

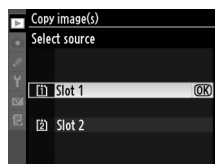

3 Choose Select image(s).

Highlight **Select image(s)** and press ►.

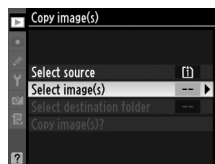

4 Select the source folder.

Highlight the folder containing the images to be copied and press ►.

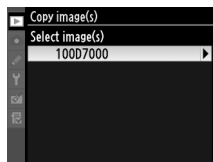



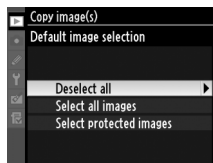

5 Make the initial selection.

Before going on select or deselect individual images, you can mark all or all protected images in the folder for copying by choosing **Select all images** or **Select protected images**. To mark only individually selected images for copying, choose **Deselect all** before proceeding.



6 Select additional images.

Highlight pictures and press  to select or deselect (to view the highlighted picture full screen, press and hold the  button). Selected images are marked with a ✓. Press  to proceed to Step 7 when your selection is complete.

 button



7 Choose Select destination folder.

Highlight **Select destination folder** and press ►.

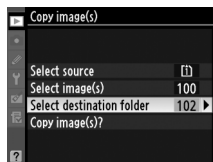

8 Select a destination folder.

To enter a folder number, choose **Select folder by number**, enter the number (□ 203), and press **OK**. If the folder with the selected number does not already exist, a new folder will be created.

To choose from a list of existing folders, choose **Select folder from list**, highlight a folder, and press **OK**.

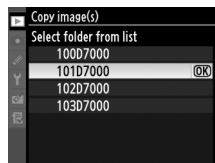

9 Copy the images.

Highlight **Copy image(s)?** and press **OK**.

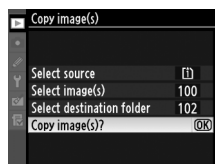

A confirmation dialog will be displayed; highlight **Yes** and press **OK**. Press **OK** again to exit when copying is complete.



✓ Copying Images

Images will not be copied if there is insufficient space on the destination card. Be sure the battery is fully charged before copying movies.

If the destination folder contains an image with the same name as one of the images to be copied, a confirmation dialog will be displayed. Select **Replace existing image** to replace the image with the image to be copied, or select **Replace all** to replace all existing images with the same names without further prompting. To continue without replacing the image, select **Skip**, or select **Cancel** to exit without copying any further images.



Protect status is copied with the images but print marking (□ 189) is not. Hidden images can not be copied.



Image Review

MENU button →  playback menu

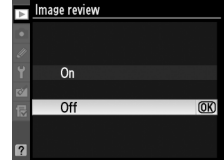

Choose whether pictures are automatically displayed in the monitor immediately after shooting. If **Off** is selected, pictures can only be displayed by pressing the  button.



After Delete

MENU button →  playback menu

Choose the picture displayed after an image is deleted.

Option	Description
 Show next	Display following picture. If deleted picture was last frame, previous picture will be displayed.
 Show previous	Display previous picture. If deleted picture was first frame, following picture will be displayed.
 Continue as before	If user was scrolling through pictures in order recorded, following picture will be displayed as described for Show next . If user was scrolling through pictures in reverse order, previous picture will be displayed as described for Show previous .

Rotate Tall

MENU button →  playback menu

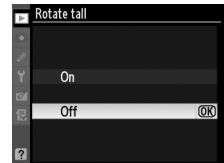

Choose whether to rotate “tall” (portrait-orientation) pictures for display during playback. Note that because the camera itself is already in the appropriate orientation during shooting, images are not rotated automatically during image review.



Option	Description
On	“Tall” (portrait-orientation) pictures are automatically rotated for display in the camera monitor. Pictures taken with Off selected for Auto image rotation (📷 239) will be displayed in “wide” (landscape) orientation.
Off	“Tall” (portrait-orientation) pictures are displayed in “wide” (landscape) orientation.











Slide Show

MENU button →  playback menu

Create a slide show of the pictures in the current playback folder ( 195). Hidden images ( 196) are not displayed.

Option	Description
Start	Start slide show.
Frame interval	Choose how long each picture will be displayed.

To start the slide show, highlight **Start** and press . The following operations can be performed while the slide show is in progress:

To	Press	Description
Skip back/skip ahead		Press  to return to previous frame,  to skip to next frame.
View additional photo info		Change photo info displayed ( 165).
Pause/resume		Pause or resume slide show.
Exit to playback menu	MENU	End slide show and return to playback menu.
Exit to playback mode		End slide show and exit to full-frame ( 163) or thumbnail playback ( 171).
Exit to shooting mode		Press shutter-release button halfway to return to shooting mode.

The dialog shown at right is displayed when the show ends. Select **Restart** to restart or **Exit** to return to the playback menu.





The Shooting Menu: *Shooting Options*

To display the shooting menu, press **MENU** and select the  (shooting menu) tab.

MENU button



The shooting menu contains the following options:

Option		Option	
Reset shooting menu	202	Auto distortion control	205
Storage folder	203	Color space	141
File naming	204	Active D-Lighting	139
Role played by card in Slot 2	89	Long exp. NR	205
Image quality	85	High ISO NR	205
Image size	88	ISO sensitivity settings	101
JPEG compression	87	Multiple exposure	152
NEF (RAW) recording	87	Movie settings	60
White balance	117	Interval timer shooting	155
Set Picture Control	131	Remote control mode	80
Manage Picture Control	136		

Note: Depending on camera settings, some items may be grayed out and unavailable. For information on the options available in each shooting mode, see page 292.

Reset Shooting Menu

MENU button →  **shooting menu**

Select **Yes** to restore shooting menu options to their default values ( 295).

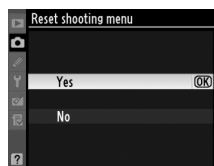

Select the folder in which subsequent images will be stored.



■ Selecting Folders by Folder Number



1 Choose Select folder by number.

Highlight **Select folder by number** and press **▶**.
The dialog shown at right will be displayed.



2 Choose a folder number.

Press **◀** or **▶** to highlight a digit, press **▲** or **▼** to change. If a folder with the selected number already exists, a , , or  icon will be displayed to the left of the folder number:

-  : Folder is empty.
-  : Folder is partially full.
-  : Folder contains 999 pictures or a picture numbered 9999. No further pictures can be stored in this folder.

The card on which the folder is stored is shown by the card slot icon in the top right corner of the Select folder by number dialog. The card used for new folders depends on the option currently selected for **Role played by card in slot 2** ( 89).

3 Save changes and exit.

Press **OK** to complete the operation and return to the shooting menu (to exit without choosing a folder, press the **MENU** button). If a folder with the specified number does not already exist, a new folder will be created. Subsequent photographs will be stored in the selected folder unless it is already full.

Folder and File Numbers

If the current folder is numbered 999 and contains 999 pictures or a picture numbered 9999, the shutter-release will be disabled and no further photographs can be taken. To continue shooting, create a folder with a number less than 999, or select an existing folder with a number less than 999 and less than 999 images.

Startup Time

Additional time may be required for camera startup if the memory card contains a very large number of files or folders.

■ ■ Selecting Folders from a List

1 Choose **Select folder from list**.

Highlight **Select folder from list** and press ►.

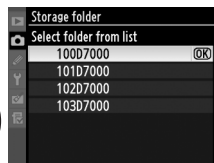

2 Highlight a folder.

Press ▲ or ▼ to highlight a folder.

3 Select the highlighted folder.

Press **OK** to select the highlighted folder and return to the shooting menu (to exit without changing the active folder, press the **MENU** button). Subsequent photographs will be stored in the selected folder.

File Naming

MENU button → shooting menu

Photographs are saved using file names consisting of "DSC_" or, in the case of images that use the Adobe RGB color space, "_DSC", followed by a four-digit number and a three-letter extension (e.g., "DSC_0001.JPG"). The **File naming** option is used to select three letters to replace the "DSC" portion of the file name. For information on editing file names, see page 137. Note that the portion of the name that can be edited is a maximum of three characters long.

Extensions

The following extensions are used: ".NEF" for NEF (RAW) images, ".JPG" for JPEG images, ".MOV" for movies, and ".NDF" for dust off reference data. In each pair of photographs recorded at image-quality settings of NEF (RAW)+JPEG, the NEF and JPEG images have the same file names but different extensions.

Auto Distortion Control

MENU button →  shooting menu

Select **On** to reduce barrel distortion when shooting with wide-angle lenses and to reduce pin-cushion distortion when shooting with long lenses (note that the edges of the area visible in the viewfinder may be cropped out of the final photograph, and that the time needed to process photographs before recording begins may increase). This option is recommended only with type G and D lenses (PC, fisheye, and certain other lenses excluded); results are not guaranteed with other lenses.

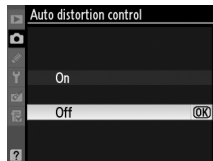

Retouch: Distortion Control

For information on creating copies of existing photographs with reduced barrel and pin-cushion distortion, see page 261.

Long Exp. NR (Long Exposure Noise Reduction) MENU button → shooting menu

If **On** is selected, photographs taken at shutter speeds slower than 1 s will be processed to reduce noise (randomly-spaced bright pixels or fog), increasing the time required to record images by roughly 1.5 to 2 times. During processing, “**Job nr**” will blink in the shutter speed/aperture displays and pictures can not be taken (if the camera is turned off before processing is complete, the picture will be saved but noise reduction will not be performed). In continuous release mode, frame rates will slow and while photographs are being processed, the capacity of the memory buffer will drop.

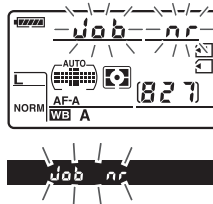

High ISO NR

MENU button →  shooting menu

Photographs taken at high ISO sensitivities can be processed to reduce “noise.”

Option	Description
HIGH High	Reduce noise (randomly-spaced bright pixels, lines, or fog), particularly in photographs taken at high ISO sensitivities. Choose the amount of noise reduction performed from High , Normal , and Low .
NORM Normal	
LOW Low	
Off	Noise reduction is only performed at ISO sensitivities of ISO 1600 and higher. The amount of noise reduction is less than the amount performed when Low is selected for High ISO NR .



Custom Settings: Fine-Tuning Camera Settings

To display the Custom Settings menu, press **MENU** and select the  (Custom Settings menu) tab.

MENU button

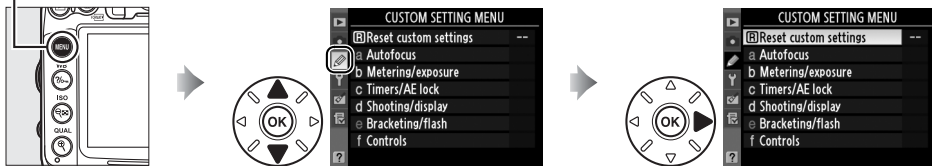

Custom Settings are used to customize camera settings to suit individual preferences.

Custom Setting groups

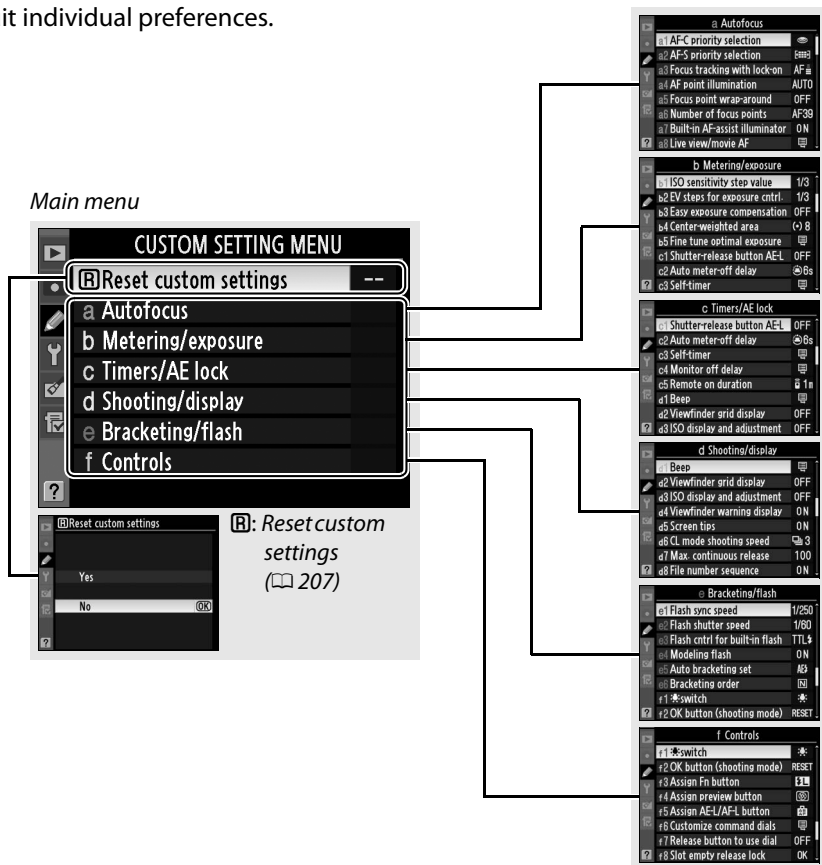

The following Custom Settings are available:

Custom Setting			Custom Setting		
R	Reset custom settings	207	d	Shooting/display	
a	Autofocus		d6	CL mode shooting speed	217
a1	AF-C priority selection	208	d7	Max. continuous release	217
a2	AF-S priority selection	208	d8	File number sequence	218
a3	Focus tracking with lock-on	209	d9	Information display	219
a4	AF point illumination	209	d10	LCD illumination	219
a5	Focus point wrap-around	209	d11	Exposure delay mode	219
a6	Number of focus points	210	d12	Flash warning	219
a7	Built-in AF-assist illuminator	210	d13	MB-D11 battery type	220
a8	Live view/movie AF	211	d14	Battery order	221
b	Metering/exposure		e	Bracketing/flash	
b1	ISO sensitivity step value	211	e1	Flash sync speed	222
b2	EV steps for exposure cntrl.	211	e2	Flash shutter speed	223
b3	Easy exposure compensation	212	e3	Flash cntrl for built-in flash	223
b4	Center-weighted area	213	e4	Modeling flash	228
b5	Fine tune optimal exposure	213	e5	Auto bracketing set	229
c	Timers/AE lock		e6	Bracketing order	229
c1	Shutter-release button AE-L	213	f	Controls	
c2	Auto meter-off delay	214	f1	⚡ switch	229
c3	Self-timer	214	f2	OK button (shooting mode)	229
c4	Monitor off delay	215	f3	Assign Fn button	230
c5	Remote on duration	215	f4	Assign preview button	232
d	Shooting/display		f5	Assign AE-L/AF-L button	232
d1	Beep	215	f6	Customize command dials	233
d2	Viewfinder grid display	216	f7	Release button to use dial	234
d3	ISO display and adjustment	216	f8	Slot empty release lock	234
d4	Viewfinder warning display	216	f9	Reverse indicators	234
d5	Screen tips	216	f10	Assign MB-D11  button	235

Note: Depending on camera settings, some items may be grayed out and unavailable. For information on the options available in each shooting mode, see page 292.

R: Reset Custom Settings

MENU button →  Custom Settings menu

Select **Yes** to restore Custom Settings to their default values ( 296).



a: Autofocus

a1: AF-C Priority Selection

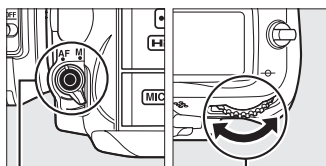

MENU button →  Custom Settings menu

When **AF-C** is selected for viewfinder photography ( 91), this option controls whether photographs can be taken whenever the shutter-release button is pressed (*release priority*) or only when the camera is in focus (*focus priority*).



AF-mode
button

Main command dial
button

Option	Description
 Release	Photos can be taken whenever the shutter-release button is pressed.
 Focus	Photos can only be taken when the in-focus indicator (●) is displayed.

Regardless of the option selected, focus will not lock when **AF-C** is selected for AF mode. The camera will continue to adjust focus until the shutter is released.

a2: AF-S Priority Selection

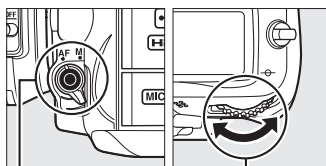

MENU button →  Custom Settings menu

When **AF-S** is selected for viewfinder photography ( 91), this option controls whether photographs can be taken only when the camera is in focus (*focus priority*) or whenever the shutter-release button is pressed (*release priority*).



AF-mode
button

Main command dial
button





Option	Description
 Release	Photos can be taken whenever the shutter-release button is pressed.
 Focus	Photos can only be taken when the in-focus indicator (●) is displayed.

Regardless of the option selected, if the in-focus indicator (●) is displayed when **AF-S** is selected for AF mode, focus will lock while the shutter-release button is pressed halfway. Focus lock continues until the shutter is released.

a3: Focus Tracking with Lock-On

MENU button →  Custom Settings menu

This option controls how autofocus adjusts to sudden large changes in the distance to the subject when **AF-C** is selected or continuous-servo autofocus is selected when the camera is in **AF-A** mode for viewfinder photography ( 91).

Option	Description
AF  5 (Long)	When the distance to the subject changes abruptly, the camera waits for the specified period before adjusting the distance to the subject. This prevents the camera from refocusing when the subject is briefly obscured by objects passing through the frame.
AF  4	
AF  3 (Normal)	
AF  2	
AF  1 (Short)	
Off	The camera immediately adjusts focus when the distance to the subject changes. Use when photographing a series of subjects at varying distances in quick succession.

a4: AF Point Illumination

MENU button →  Custom Settings menu



Choose whether the active focus point is highlighted in red in the viewfinder.

Option	Description
AUTO Auto	The selected focus point is automatically highlighted as needed to establish contrast with the background.
On	The selected focus point is always highlighted, regardless of the brightness of the background. Depending on the brightness of the background, the selected focus point may be difficult to see.
Off	The selected focus point is not highlighted.

a5: Focus Point Wrap-Around

MENU button →  Custom Settings menu

Choose whether focus-point selection “wraps around” from one edge of the display to another.

Option	Description
Wrap	Focus-point selection “wraps around” from top to bottom, bottom to top, right to left, and left to right, so that, for example, pressing  when a focus point at the right edge of the display is highlighted (①) selects the corresponding focus point at the left edge of the display (②). 
No wrap	The focus-area display is bounded by the outermost focus points so that, for example, pressing  when a focus point at the right edge of the display is selected has no effect.

a6: Number of Focus Points

MENU button →  Custom Settings menu

Choose the number of focus points available for manual focus-point selection.

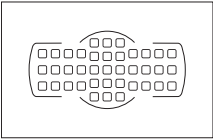
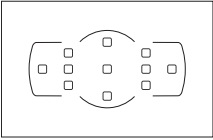



Option	Description	
AF39 39 points	Choose from the 39 focus points shown at right.	
AF11 11 points	Choose from the 11 focus points shown at right. Use for quick focus-point selection.	

a7: Built-in AF-assist Illuminator

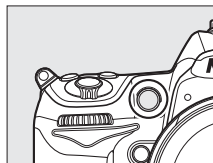
MENU button →  Custom Settings menu

Choose whether the built-in AF-assist illuminator lights to assist the focus operation when lighting is poor.



Option	Description
On	The AF-assist illuminator lights when lighting is poor (viewfinder photography only). AF-assist illumination is only available when both of the following conditions are met: <ol style="list-style-type: none">1. AF-S is selected for autofocus mode () 91) or single-servo autofocus is selected when the camera is in AF-A mode.2.  (auto-area AF) is chosen for AF-area mode () 94), or an option other than  is chosen and the center focus point is selected.
Off	The AF-assist illuminator does not light to assist the focus operation. The camera may not be able to focus using autofocus when lighting is poor.

The AF-Assist Illuminator

The AF-assist illuminator has a range of about 0.5–3.0 m (1 ft. 8 in.–9 ft. 10 in.); when using the illuminator, use a lens with a focal length of 24–200 mm and remove the lens hood.

See Also

For information on the shooting modes in which AF-assist is available, see page 292. See page 273 for restrictions on the lenses that can be used with AF assist.

a8: Live View/Movie AF

MENU button →  Custom Settings menu

Choose how the camera focuses when autofocus is selected in live view or during movie recording.

- **Autofocus mode:** Select the focus mode used for autofocus in live view and movie recording (☰ 50). Choose from **Single-servo AF** and **Full-time-servo AF**.
- **AF-area mode:** Choose how the focus point for autofocus is selected during live view and movie recording (☰ 50). Choose from **Face-priority AF**, **Wide-area AF**, **Normal-area AF**, and **Subject-tracking AF**.

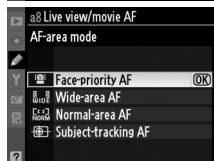
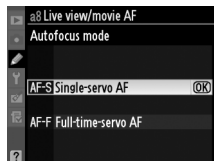

b: Metering/Exposure

b1: ISO Sensitivity Step Value

MENU button →  Custom Settings menu

Select the increments used when making adjustments to ISO sensitivity. If possible, the current ISO sensitivity setting is maintained when the step value is changed. If the current setting is not available at the new step value, ISO sensitivity will be rounded to the nearest available setting.

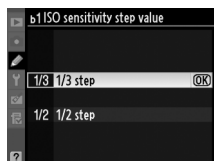

b2: EV Steps for Exposure Cntrl.

MENU button →  Custom Settings menu

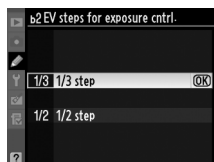

Select the increments used when making adjustments to shutter speed, aperture, exposure and flash compensation, and bracketing.



b3: Easy Exposure Compensation

MENU button →  Custom Settings menu

This option controls whether the  button is needed to set exposure compensation (□ 107). If **On (Auto reset)** or **On** is selected, the 0 at the center of the exposure display will blink even when exposure compensation is set to ± 0 .

Option	Description
RESET On (Auto reset)	Exposure compensation is set by rotating one of the command dials (see note below). The setting selected using the command dial is reset when the camera or exposure meters turn off (exposure compensation settings selected using the  button are not reset).
On	As above, except that the exposure compensation value selected using the command dial is not reset when the camera or exposure meters turn off.
Off	Exposure compensation is set by pressing the  button and rotating the main command dial.

Change Main/Sub

The dial used to set exposure compensation when **On (Auto reset)** or **On** is selected for Custom Setting b3 (**Easy exposure compensation**) depends on the option selected for Custom Setting f6 (**Customize command dials**) > **Change main/sub** (□ 233).

Customize command dials > Change main/sub			
	Off	On	
Mode	P	Sub-command dial	Sub-command dial
	S	Sub-command dial	Main command dial
	A	Main command dial	Sub-command dial
	M	N/A	

Show ISO/Easy ISO

Custom Setting b3 (**Easy exposure compensation**) can not be used with Custom Setting d3 (**Show ISO/Easy ISO**). Adjustments to either of these items reset the remaining item; a message is displayed when the item is reset.

b4: Center-Weighted Area

MENU button →  Custom Settings menu

When calculating exposure, center-weighted metering assigns the greatest weight to a circle in the center of the frame. The diameter (ϕ) of this circle can be set to 6, 8, 10, or 13 mm or to the average of the entire frame.

Note that the diameter is fixed at 8 mm when a non-CPU lens is used.

Option
(←) 6 ϕ 6 mm
(←) 8 ϕ 8 mm
(←) 10 ϕ 10 mm
(←) 13 ϕ 13 mm
(←) Avg Average



b5: Fine Tune Optimal Exposure

MENU button →  Custom Settings menu

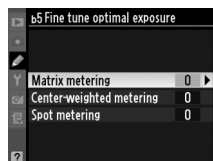
Use this option to fine-tune the exposure value selected by the camera. Exposure can be fine tuned separately for each metering method by from +1 to -1 EV in steps of $1/6$ EV.



Fine-Tuning Exposure

Exposure fine tuning is not affected by two-button resets. Note that as the exposure compensation () icon is not displayed, the only way to determine how much exposure has been altered is to view the amount in the fine-tuning menu. Exposure compensation ( 107) is preferred in most situations.

c: Timers/AE Lock

c1: Shutter-Release Button AE-L

MENU button →  Custom Settings menu

At the default setting of **Off**, exposure only locks when the **AE-L/AF-L** button is pressed. If **On** is selected, exposure will also lock when the shutter-release button is pressed halfway.

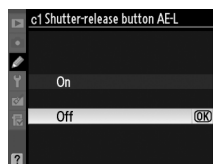

c2: Auto Meter-off Delay

MENU button →  Custom Settings menu

Choose how long the camera continues to meter exposure when no operations are performed. The shutter-speed and aperture displays in the control panel and viewfinder turn off automatically when the exposure meters turn off.

Choose a shorter meter-off delay for longer battery life.

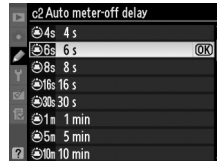

c3: Self-Timer

MENU button →  Custom Settings menu

Choose the length of the shutter release delay, the number of shots taken, and the interval between shots in self-timer mode.

- **Self-timer delay:** Choose the length of the shutter-release delay.
- **Number of shots:** Press ▲ and ▼ to choose the number of shots taken each time the shutter-release button is pressed.
- **Interval between shots:** Choose the interval between shots when the **Number of shots** is more than 1.

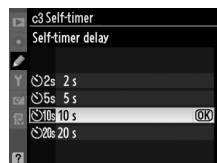
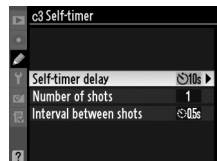

c4: Monitor off Delay

MENU button → Custom Settings menu

Choose how long the monitor remains on when no operations are performed during playback (**Playback**; defaults to 10 s) and image review (**Image review**; defaults to 4 s), when menus (**Menus**; defaults to 20 s) or information (**Information display**; defaults to 10 s) are displayed, or during live view and movie recording (**Live view**; defaults to 10 minutes). Choose a shorter monitor-off delay for longer battery life.

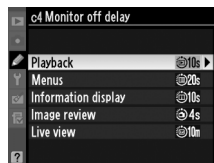

c5: Remote on Duration

MENU button → Custom Settings menu

Choose how long the camera will remain on stand-by in remote release mode (□ 80). If no operations are performed for the selected period, remote shooting will end and the exposure meters will turn off. Choose shorter times for longer battery life. To reactivate remote mode after the timer has expired, press the camera shutter-release button halfway.



d: Shooting/Display

d1: Beep

MENU button → Custom Settings menu

Choose the pitch and volume of the beep that sounds when the camera focuses using single-servo AF (**AF-S** or when single-servo AF is selected for **AF-A**; □ 50, 91), when focus locks in live view, while the release timer is counting down in self-timer and delayed remote release modes (□ 80), when a photograph is taken in quick-response remote or remote mirror-up mode (□ 80), or if you attempt to take a photograph when the memory card is locked (□ 33). Note that a beep will not sound in quiet-shutter release mode (mode **Q**; □ 77), regardless of the option selected.

- **Volume:** Choose **3** (high), **2** (medium), **1** (low) or **Off** (mute). When an option other than **Off** is selected, appears in the control panel and information display.
- **Pitch:** Choose **High** or **Low**.

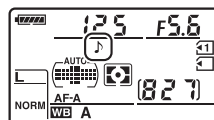

d2: Viewfinder Grid Display

MENU button →  Custom Settings menu

Choose **On** to display on-demand grid lines in the viewfinder for reference when composing photographs (📖 9).

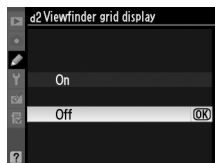

d3: ISO Display and Adjustment



MENU button →  Custom Settings menu

If **Show ISO sensitivity** or **Show ISO/Easy ISO** is selected, the viewfinder and control panel will show ISO sensitivity in place of the number of exposures remaining. If **Show ISO/Easy ISO** is selected, ISO sensitivity can be set in modes **P** and **S** by rotating the sub-command dial or in mode **A** by rotating the main command dial. Select **Show frame count** to display the number of exposures remaining in the viewfinder and control panel.

d4: Viewfinder Warning Display

MENU button →  Custom Settings menu

Selecting **On** enables the following viewfinder warnings:

- **B/W**: Displayed when a monochrome Picture Control is selected
- : Displayed when the battery is low
- : Displayed if no memory card is inserted in the camera

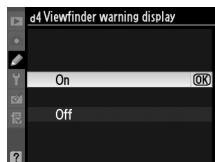

d5: Screen Tips

MENU button →  Custom Settings menu

Choose **On** to display tool tips for items selected in the information display.

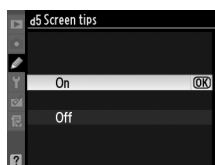

d6: CL Mode Shooting Speed

MENU button →  Custom Settings menu

Choose the maximum frame advance rate in **CL** (continuous low speed) mode (during interval timer photography, this setting also determines the frame advance rate for single-frame). Note that the frame advance rate may drop below the selected value at slow shutter speeds.

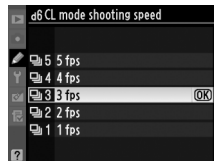

d7: Max. Continuous Release

MENU button →  Custom Settings menu

The maximum number of shots that can be taken in a single burst in continuous mode can be set to any value between 1 and 100.

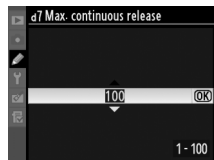

The Memory Buffer

Regardless of the option selected for Custom Setting d7, shooting will slow when the memory buffer fills. See page 320 for more information on the capacity of the memory buffer.

d8: File Number Sequence

MENU button →  Custom Settings menu

When a photograph is taken, the camera names the file by adding one to the last file number used. This option controls whether file numbering continues from the last number used when a new folder is created, the memory card is formatted, or a new memory card is inserted in the camera.

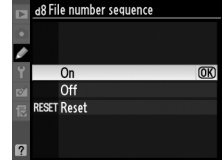

Option	Description
On	When a new folder is created, the memory card formatted, or a new memory card inserted in the camera, file numbering continues from the last number used or from the largest file number in the current folder, whichever is higher. If a photograph is taken when the current folder contains a photograph numbered 9999, a new folder will be created automatically and file numbering will begin again from 0001.
Off	File numbering is reset to 0001 when a new folder is created, the memory card is formatted, or a new memory card is inserted in the camera. Note that a new folder is created automatically if a photograph is taken when the current folder contains 999 photographs.
RESET Reset	As for On , except that the next photograph taken is assigned a file number by adding one to the largest file number in the current folder. If the folder is empty, file numbering is reset to 0001.

File Number Sequence

If the current folder is numbered 999 and contains either 999 photographs or a photograph numbered 9999, the shutter-release button will be disabled and no further photographs can be taken. Choose **Reset** for Custom Setting d8 (**File number sequence**) and then either format the current memory card or insert a new memory card.

d9: Information Display

MENU button →  Custom Settings menu

At the default setting of **Auto (AUTO)**, the color of the lettering in the information display (☐ 10) will automatically change from black to white or white to black to maintain contrast with the background. To always use the same color lettering, select **Manual** and choose **Dark on light (B; black lettering)** or **Light on dark (W; white lettering)**. Monitor brightness will automatically be adjusted for maximum contrast with the selected text color.

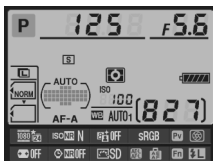

Dark on light



Light on dark

d10: LCD Illumination

MENU button →  Custom Settings menu

At the default setting of **Off**, the control panel backlight (LCD illuminator) will only light while the power switch is rotated toward **☼**. If **On** is selected, the control panel will be illuminated whenever the exposure meters are active (☐ 39). Select **Off** for increased battery life.

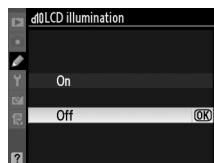

d11: Exposure Delay Mode

MENU button →  Custom Settings menu

In situations where the slightest camera movement can blur pictures, select **On** to delay shutter release until about 1 s after the shutter-release button is pressed and the mirror is raised.

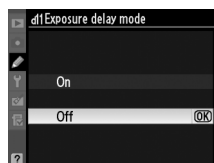

d12: Flash Warning



MENU button →  Custom Settings menu

If **On** is selected, the flash-ready indicator (⚡) will blink in the viewfinder if the flash is required to ensure optimal exposure.

d13: MB-D11 Battery Type





MENU button →  Custom Settings menu

To ensure that the camera functions as expected when the optional MB-D11 battery pack is used with AA batteries, match the option selected in this menu to the type of batteries inserted in the battery pack. There is no need to adjust this option when using EN-EL15 batteries.

Option	Description
 LR6 (AA alkaline)	Select when using LR6 alkaline AA batteries.
 HR6 (AA Ni-MH)	Select when using HR6 Ni-MH AA batteries.
 FR6 (AA lithium)	Select when using FR6 lithium AA batteries.

Using AA Batteries

The MB-D11 takes one EN-EL15 rechargeable Li-ion battery or six AA alkaline, Ni-MH, or lithium batteries (an EN-EL15 is supplied with the camera; AA batteries are available separately). Fewer pictures can be taken with AA batteries (☐ 321). The capacity of AA batteries drops sharply at temperatures below 20 °C (68 °F) and varies with make and storage conditions; in some cases, batteries may cease to function before their expiry date. Some AA batteries can not be used; due to their performance characteristics and limited capacity, alkaline batteries should only be used if no alternative is available and then only at warmer temperatures. The camera shows the level of AA batteries as follows:



Control panel	Viewfinder	Description
	—	Batteries fully charged.
		Low battery. Ready fresh batteries.
 (blinks)	 (blinks)	Shutter release disabled. Change batteries.

d14: Battery Order

MENU button →  Custom Settings menu

Choose whether the battery in the camera or the batteries in the battery pack are used first when an optional MB-D11 battery pack is attached. Note that if the MB-D11 is powered by an optional EH-5a AC adapter and EP-5B power connector, the AC adapter will be used regardless of the option selected.

A  icon is displayed in the camera control panel when the batteries in the MB-D11 are in use. The information display shows the type of battery inserted in the MB-D11 as follows:

Icon	Battery type
	EN-EL15 rechargeable Li-ion battery
	AA batteries

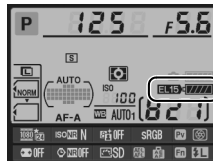
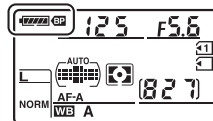
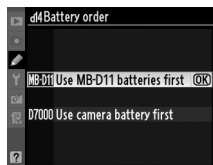

e: Bracketing/Flash

e1: Flash Sync Speed

MENU button →  Custom Settings menu

This option controls flash sync speed.

Option	Description
1/320 s (Auto FP)	Use auto FP high-speed sync with SB-900, SB-800, SB-700, SB-600, and SB-R200 flash units. If other flash units are used, shutter speed is set to $1/320$ s. When the camera shows a shutter speed of $1/320$ s in mode P or A , auto FP high-speed sync will be activated if the actual shutter speed is faster than $1/320$ s.
1/250 s (Auto FP)	Use auto FP high-speed sync with SB-900, SB-800, SB-700, SB-600, and SB-R200 flash units. If other flash units are used, shutter speed is set to $1/250$ s. When the camera shows a shutter speed of $1/250$ s in mode P or A , auto FP high-speed sync will be activated if the actual shutter speed is faster than $1/250$ s.
1/250 s–1/60 s	Flash sync speed set to selected value.

Fixing Shutter Speed at the Flash Sync Speed Limit

To fix shutter speed at the sync speed limit in mode **S** or **M**, select the next shutter speed after the slowest possible shutter speed (30 s or bulb). An X (flash sync indicator) will be displayed in the control panel and viewfinder.

Auto FP High-Speed Sync

Allows the flash to be used at the highest shutter speed supported by the camera, making it possible to choose the maximum aperture for reduced depth of field even when the subject is backlit in bright sunlight. The information display flash mode indicator shows “FP” when auto FP high-speed sync is active (☞ 278).

Flash Control at 1/320 s (Auto FP)

When **1/320 s (Auto FP)** is selected for Custom Setting e1 (**Flash sync speed**, □ 222), the built-in flash can be used at shutter speeds as fast as 1/320 s, while optional SB-900, SB-800, SB-700, SB-600, and SB-R200 flash units can be used at any shutter speed (Auto FP High-Speed Sync).

Flash sync speed	1/320 s (Auto FP)		1/250 s (Auto FP)		1/250 s	
	Built-in flash	Optional flash unit	Built-in flash	Optional flash unit	Built-in flash	Optional flash unit
1/8,000–1/320 s	—	Auto FP	—	Auto FP	—	—
1/320–1/250 s	Flash sync*		—	Auto FP	—	—
1/250–30 s	Flash sync					

* Flash range drops as shutter speed increases. Flash range will nevertheless be greater than that obtained at the same speeds with Auto FP.

The Flash-Ready Indicator

When the flash fires at full power, the flash-indicator in the camera viewfinder will blink to warn that the resulting photograph may be underexposed. Note that the flash-ready indicators on optional flash units will not display this warning when **1/320 s (Auto FP)** is selected.

e2: Flash Shutter Speed

MENU button → Custom Settings menu

This option determines the slowest shutter speed available when front- or rear-curtain sync or red-eye reduction is used in mode **P** or **A** (regardless of the setting chosen, shutter speeds can be as slow as 30 s in **S** and **M** modes or at flash settings of slow sync, slow rear-curtain sync, or red-eye reduction with slow sync). Options range from 1/60 s (**1/60 s**) to 30 s (**30 s**).



e3: Flash Cntrl for Built-in Flash

MENU button → Custom Settings menu

Choose the flash mode for the built-in flash.

Option	Description
TTL TTL	Flash output is adjusted automatically in response to shooting conditions.
M Manual	Choose the flash level (□ 224). The camera does not emit monitor pre-flashes.
RPT Repeating flash	The flash fires repeatedly while the shutter is open, producing a strobe-light effect (□ 224).
CMD Commander mode	Use the built-in flash as a master flash controlling one or more remote optional flash units (□ 225).



Manual

Choose a flash level between **Full** and **1/128** ($1/128$ of full power). At full power, the built-in flash has a Guide Number of 12/39 (m/ft., ISO 100, 20°C/68°F).

Repeating Flash

The flash fires repeatedly while the shutter is open, producing a strobe-light effect. Press ◀ or ▶ to highlight the following options, ▲ or ▼ to change.

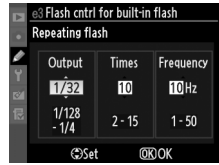

Option	Description
Output	Choose flash output (expressed as a fraction of full power).
Times	Choose the number of times the flash fires at the selected output. Note that depending on shutter speed and the option selected for Frequency , the actual number of flashes may be less than selected.
Frequency	Choose how often the flash fires per second.

Flash Control Mode

The flash control mode for the built-in flash is shown in the information display.

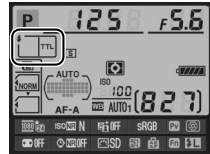

“Manual” and “Repeating Flash”

☑ icons blink in the control panel and viewfinder when these options are selected.

The SB-400

When an optional SB-400 flash unit is attached and turned on, Custom Setting e3 changes to **Optional flash**, allowing the flash control mode for the SB-400 to be selected from **TTL** and **Manual** (**Repeating flash** and **Commander mode** options are not available).

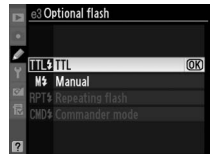

“Times”

The options available for **Repeating Flash** > **Times** are determined by flash output.

Output	Options available for “Times”	Output	Options available for “Times”
1/4	2	1/32	2-10, 15
1/8	2-5	1/64	2-10, 15, 20, 25
1/16	2-10	1/128	2-10, 15, 20, 25, 30, 35

■ Commander Mode

Use the built-in flash as a master flash controlling one or more remote optional SB-900, SB-800, SB-700, SB-600, or SB-R200 flash units in up to two groups (A and B) using advanced wireless lighting.

Selecting this option displays the menu shown at right. Press ◀ or ▶ to highlight the following options, ▲ or ▼ to change.

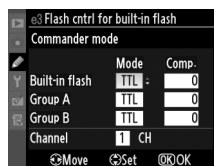

Option	Description
Built-in flash	Choose a flash mode for the built-in flash (commander flash).
TTL	i-TTL mode. Choose flash compensation from values between +3.0 and -3.0 EV in increments of 1/3 EV.
M	Choose the flash level from values between 1/1 and 1/128 (1/128 of full power).
--	The built-in flash does not fire, although remote flash units do. The built-in flash must be raised so that it can emit monitor pre-flashes.
Group A	Choose a flash mode for all flash units in group A.
TTL	i-TTL mode. Choose flash compensation from values between +3.0 and -3.0 EV in increments of 1/3 EV.
AA	Auto aperture (available only with SB-900 and SB-800 flash units). Choose flash compensation from values between +3.0 and -3.0 EV in increments of 1/3 EV.
M	Choose the flash level from values between 1/1 and 1/128 (1/128 of full power).
--	The flash units in this group do not fire.
Group B	Choose a flash mode for all flash units in group B. The options available are the same as those listed for Group A , above.
Channel	Choose from channels 1-4. All flash units in both groups must be set to the same channel.



Follow the steps below to take photographs in commander mode.

1 Adjust settings for the built-in flash.

Choose the flash control mode and output level for the built-in flash. Note that output level can not be adjusted in -- mode.

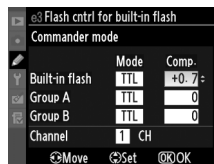

2 Adjust settings for group A.

Choose the flash control mode and output level for the flash units in group A.

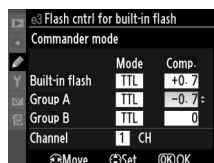

3 Adjust settings for group B.

Choose the flash control mode and output level for the flash units in group B.

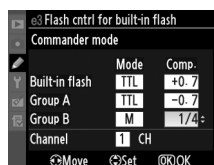

4 Select the channel.

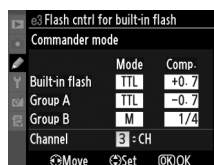

5 Press OK.

6 Compose the shot.

Compose the shot and arrange the flash units as shown below. Note that the maximum distance at which the remote flash units can be placed may vary with shooting conditions.

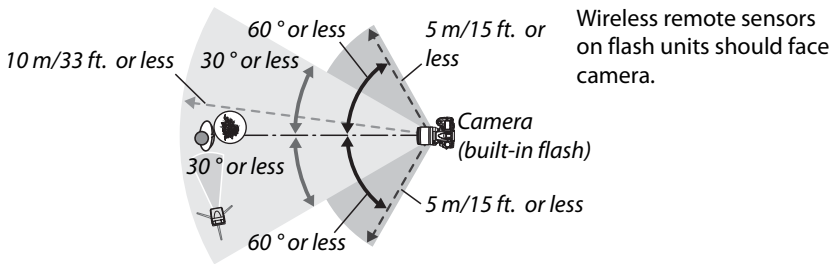

7 Set the remote flash units to the selected channel.

Turn all the remote flash units on and set them to the channel selected in Step 4. See the flash unit instruction manuals for details.

8 Raise the built-in flash.

Press the **⚡** button to raise the built-in flash. Note that even if **--** is selected for **Built-in flash > Mode**, the built-in flash must be raised so that monitor preflashes will be emitted.



9 Frame the photograph, focus, and shoot.

After confirming that the camera flash-ready light and the flash-ready lights for all other flash units are lit, frame the photograph, focus, and shoot. FV lock (□ 149) can be used if desired.

The Flash Sync Mode Display

 does not appear in the control panel flash sync mode display when -- is selected for **Built-in flash > Mode**.

Flash Compensation

The flash compensation value selected with the  (⚡) button and sub-command dial is added to the flash compensation values selected for the built-in flash, group A, and group B in the **Commander mode** menu. A  icon is displayed in the control panel and viewfinder when a flash compensation value other than ± 0 is selected for **Built-in flash > TTL**. The  icon flashes when the built-in flash is in mode **M**.

Commander Mode

Position the sensor windows on the remote flash units to pick up the monitor preflashes from the built-in flash (particular care is required if the camera is not mounted a tripod). Be sure that direct light or strong reflections from the remote flash units do not enter the camera lens (in TTL mode) or the photocells on the remote flash units (AA mode), as this may interfere with exposure. To prevent timing flashes emitted by the built-in flash from appearing in photographs taken at short range, choose low ISO sensitivities or small apertures (large f-numbers) or use an optional SG-3IR infrared panel for the built-in flash. An SG-3IR is required for best results with rear-curtain sync, which produces brighter timing flashes. After positioning the remote flash units, take a test shot and view the results in the camera monitor.

Although there is no limit on the number of remote flash units that may be used, the practical maximum is three. With more than this number, the light emitted by the remote flash units will interfere with performance.

e4: Modeling Flash

MENU button →  Custom Settings menu

If **On** is selected when the camera is being used with the built-in flash or an optional SB-900, SB-800, SB-700, SB-600, or SB-R200 flash unit, a modeling flash will be emitted when the camera depth-of-field preview button is pressed ( 72). No modeling flash is emitted if **Off** is selected.

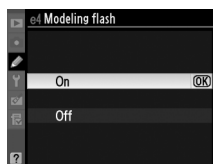

e5: Auto Bracketing Set

MENU button →  Custom Settings menu

Choose the setting or settings affected by bracketing (☐ 109). Choose **AE & flash** (AE) to perform both exposure and flash-level bracketing, **AE only** (AE) to bracket only exposure, **Flash only** (⚡) to perform only flash-level bracketing, **WB bracketing** (WB) to perform white-balance bracketing (☐ 112), or **ADL bracketing** (☑) to perform Active D-Lighting bracketing (☐ 114). Note that white balance bracketing is not available at image quality settings of NEF (RAW) or NEF (RAW) + JPEG.

e6: Bracketing Order

MENU button →  Custom Settings menu





At the default setting of **MTR > under > over** (☑), exposure, flash, and white balance bracketing are performed in the order described on pages 109 and 112. If **Under > MTR > over** (→→+) is selected, shooting will proceed in order from the lowest to the highest value. This setting has no effect on ADL bracketing.

f: Controls

f1: Switch



MENU button →  Custom Settings menu

Choose what happens when the power switch is rotated to .

Option	Description
 LCD backlight ()	Control panel backlight illuminates for 6 s.
  and information display	Control panel backlight illuminates and shooting information is displayed in monitor.

f2: OK Button (Shooting Mode)

MENU button →  Custom Settings menu









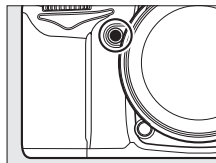





Choose the role played by the  button during shooting: selecting the center focus point (RESET **Select center focus point**), highlighting the active focus point ( **Highlight active focus point**), or none (**Not used**).









f3: Assign Fn Button

MENU button →  Custom Settings menu

Choose the role played by the **Fn** button.







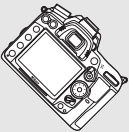

Option	Description
 Preview	Press the Fn button to preview depth of field ( 72).
 FV lock	Press the Fn button to lock flash value (built-in flash and SB-900, SB-800, SB-700, SB-600, SB-400, and SB-R200 flash units only,  149). Press again to cancel FV lock.
 AE/AF lock	Focus and exposure lock while the Fn button is pressed.
 AE lock only	Exposure locks while the Fn button is pressed.
 AE lock (Hold)	Exposure locks when the Fn button is pressed, and remains locked until the button is pressed a second time or the exposure meters turn off.
 AF lock only	Focus locks while the Fn button is pressed.
 Flash off	The flash will not fire in photos taken while the Fn button is pressed.
BKT Bracketing burst	If the Fn button is pressed while exposure, flash, or ADL bracketing is active in single frame or quiet shutter-release mode, all shots in the current bracketing program will be taken each time the shutter-release button is pressed. If white balance bracketing is active or continuous release mode (mode CH or CL) is selected, the camera will repeat the bracketing burst while the shutter-release button is held down (in single frame release mode, photographs will be taken at about 6 fps).
 Active D-Lighting	Press the Fn button and rotate the main command dial to choose Active D-Lighting ( 139).
 +NEF (RAW)	If image quality is set to JPEG fine , JPEG normal , or JPEG basic , “RAW” will be displayed in the control panel and an NEF (RAW) copy will be recorded with the next picture taken after the Fn button is pressed (to record NEF/RAW copies with a series of photographs, keep the shutter-release button pressed halfway between shots). To exit without recording an NEF (RAW) copy, press the Fn button again.
 Matrix metering	Matrix metering is activated while the Fn button is pressed.
 Center-weighted metering	Center-weighted metering is activated while the Fn button is pressed.

Option	Description
 Spot metering	Spot metering is activated while the Fn button is pressed.
 Framing grid	Press the Fn button and rotate the main command dial to turn the framing grid display in the viewfinder on or off (□ 9).
 Viewfinder virtual horizon	Press the Fn button to view or hide a virtual horizon display in the viewfinder (□ 231).
 Access top item in MY MENU	Press the Fn button to jump to the top item in “MY MENU.” Select this option for quick access to a frequently-used menu item.
 1 step spd/aperture	If the Fn button is pressed when the command dials are rotated, changes to shutter speed (modes S and M) and aperture (modes A and M) are made in increments of 1 EV, regardless of the option selected for Custom Setting b2 (EV steps for exposure cntl. , □ 211).
Non-CPU Choose non-CPU lens number	Press the Fn button and rotate a command dial to choose a lens number specified using the Non-CPU lens data option (□ 159).
 Playback	Fn button performs same function as  button. Select when using a telephoto lens or in other circumstances in which it is difficult to operate the  button with your left hand.
•REC Start movie recording	Press the Fn button in live view to start movie recording (□ 57).

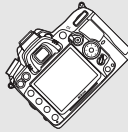
Viewfinder Virtual Horizon

When **Viewfinder virtual horizon** is selected for Custom Setting f3 (**Assign Fn button**), the exposure indicator in the viewfinder can be used as a tilt meter. Press the **Fn** button to toggle between exposure and tilt meter displays.

	Camera tilted right	Camera level	Camera tilted left
			
Viewfinder			

Note that the display may not be accurate when the camera is tilted at a sharp angle forward or back.



f4: Assign Preview Button

MENU button →  Custom Settings menu



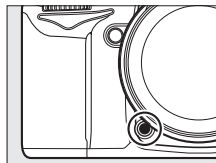



Choose the role played by the depth-of-field preview button. The options available are the same as for **Assign Fn button** (□ 230); the default setting is **Preview**.



f5: Assign AE-L/AF-L Button

MENU button →  Custom Settings menu

Choose the role played by the **AE-L/AF-L** button.

Option	Description
 AE/AF lock	Focus and exposure lock while the AE-L/AF-L button is pressed.
 AE lock only	Exposure locks while the AE-L/AF-L button is pressed.
 AF lock only	Focus locks while the AE-L/AF-L button is pressed.
 AE lock (Hold)	Exposure locks when the AE-L/AF-L button is pressed, and remains locked until the button is pressed a second time or the exposure meters turn off.
 AF-ON	The AE-L/AF-L button initiates autofocus. The shutter-release button can not be used to focus.
 FV lock	Press the AE-L/AF-L button to lock flash value (built-in flash and SB-900, SB-800, SB-700, SB-600, SB-400, and SB-R200 flash units only, □ 149). Press again to cancel FV lock.

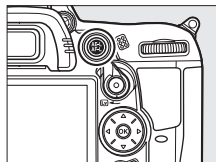



This option controls the operation of the main and sub-command dials.

- **Reverse rotation:** Controls the direction of the command dials. Choose **No** for normal command dial operation, **Yes** to reverse the rotation of the command dials. This setting also applies to the command dials for the MB-D11.
- **Change main/sub:** If **Off** is selected, the main command dial controls shutter speed and the sub-command dial controls aperture. Select **On (Mode A)** to use the main command dial to select aperture in shooting mode **A**, **On** to use the main command dial to select aperture in modes **A** and **M** and the sub-command dial to select shutter speed in modes **S** and **M**. This setting also applies to the command dials for the MB-D11.
- **Aperture setting:** If **Sub-command dial** is selected, aperture can only be adjusted with the sub-command dial (or with the main command dial if **On** is selected for **Change main/sub**). Note that except in the case of PC-E NIKKOR lenses, the sub-command dial can not be used to adjust aperture during live view; adjust aperture before starting live view. If **Aperture ring** is selected, aperture can only be adjusted with the lens aperture ring and the camera aperture display will show aperture in increments of 1 EV (aperture for type G lenses is still set using the sub-command dial). Note that regardless of the setting chosen, the aperture ring must be used to adjust aperture when a non-CPU lens is attached.
- **Menus and playback:** If **Off** is selected, the multi selector is used to choose the picture displayed during full-frame playback, highlight thumbnails, and navigate menus. If **On** or **On (image review excluded)** is selected, the main command dial can be used to choose the picture displayed during full-frame playback, move the cursor left or right during thumbnail playback, and move the menu highlight bar up or down, while the sub-command dial is used to display additional photo information in full-frame playback and to move the cursor up or down during thumbnail playback. Select **On (image review excluded)** to prevent the command dials from being used for playback during image review. While menus are displayed, rotating the sub-command dial right displays the sub-menu for the selected option, while rotating it left displays the previous menu. To make a selection, press **▶** or **OK**.

f7: Release Button to Use Dial

MENU button →  Custom Settings menu

Selecting **Yes** allows adjustments that are normally made by holding the , , **ISO**, **QUAL**, **WB**, AF-mode, , or **BKT** button and rotating a command dial to be made by rotating the command dial after the button is released (this also applies to the **Fn** and depth-of-field preview buttons if they have been assigned Active D-Lighting using Custom Setting f3, **Assign Fn button**, or Custom Setting f4, **Assign preview button**). Setting ends when any of the affected buttons is pressed again or the shutter-release button is pressed halfway. Except when **No limit** is selected for Custom Setting c2 **Auto meter-off delay**, setting will also end when the exposure meters turn off.



f8: Slot Empty Release Lock

MENU button →  Custom Settings menu

Selecting **Enable release** allows the shutter to be released when no memory card is inserted, although no pictures will be recorded (they will however be displayed in the monitor in demo mode). If **Release locked** is selected, the shutter-release button is only enabled when a memory card is inserted in the camera.

f9: Reverse Indicators

MENU button →  Custom Settings menu







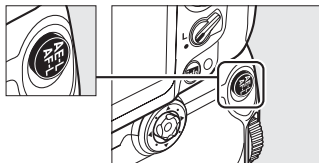

At the default setting of  (+0-), the exposure indicators in the viewfinder and information display are displayed with positive values on the left and negative values on the right. Select  (-0+) to display negative values on the left and positive values on the right.

f10: Assign MB-D11 Button

MENU button →  Custom Settings menu

Choose the function assigned to the **AE-L/AF-L** button on the optional MB-D11 battery pack.



Option	Description
 AE/AF lock	Focus and exposure lock while the MB-D11 AE-L/AF-L button is pressed.
 AE lock only	Exposure locks while the MB-D11 AE-L/AF-L button is pressed.
 AF lock only	Focus locks while the MB-D11 AE-L/AF-L button is pressed.
 AE lock (Hold)	Exposure locks when the MB-D11 AE-L/AF-L button is pressed, and remains locked until the button is pressed a second time or the exposure meters turn off.
 AF-ON	Pressing the MB-D11 AE-L/AF-L button initiates autofocus. The shutter-release button can not be used to focus.
 FV lock	Press the MB-D11 AE-L/AF-L button to lock flash value (built-in flash and SB-900, SB-800, SB-700, SB-600, SB-400, and SB-R200 flash units only,  149). Press again to cancel FV lock.
 Same as Fn button	The MB-D11 AE-L/AF-L button performs the function selected for Custom Setting f3 ( 230).

VR Lenses

Vibration reduction can not be initiated by pressing the **AE-L/AF-L** button.

Y The Setup Menu: *Camera Setup*

To display the setup menu, press **MENU** and select the **Y** (setup menu) tab.

MENU button

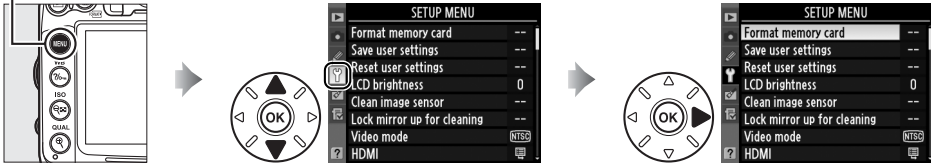

The setup menu contains the following options:

Option		Option	
Format memory card	236	Auto image rotation	239
Save user settings	75	Image Dust Off ref photo	240
Reset user settings	76	Battery info	242
LCD brightness	237	Wireless transmitter	181
Clean image sensor	284	Copyright information	243
Lock mirror up for cleaning¹	286	Save/load settings	244
Video mode	237	GPS	162
HDMI	194	Virtual horizon	245
Flicker reduction	237	Non-CPU lens data	159
Time zone and date	237	AF fine tune	246
Language	238	Eye-Fi upload²	247
Image comment	238	Firmware version	247

1 Not available when battery is low.

2 Only displayed when compatible Eye-Fi memory card is inserted (☞ 247).

Format Memory Card

MENU button → **Y Setup menu**

To begin formatting, choose a memory card slot and select **Yes**. *Note that formatting permanently deletes all pictures and other data on the card in the selected slot.* Before formatting, be sure to make backup copies as required.

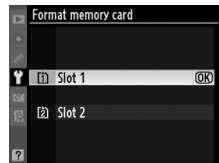

During Formatting

Do not turn the camera off or remove memory cards during formatting.

Two-Button Format

Memory cards can also be formatted by pressing the **FORMAT** (🗑️ and 🔄) buttons for more than two seconds (☞ 32).

LCD Brightness

MENU button → Setup menu

Press ▲ or ▼ to choose monitor brightness. Choose higher values for increased brightness, lower values for reduced brightness.

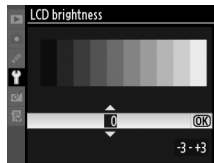

Live View

See page 49 for information on adjusting monitor brightness in live view or during movie recording.

Video Mode

MENU button → Setup menu

When connecting the camera to a television or VCR via the video connector, be sure the camera video mode matches the device video standard (NTSC or PAL).

Flicker Reduction

MENU button → Setup menu

Reduce flicker and banding when shooting under fluorescent or mercury-vapor lighting during live view or movie recording. Choose a frequency which matches that of the local AC power supply.

Flicker Reduction

If you are unsure as to the frequency of the local power supply, test both options and choose the one that produces the best results. Flicker reduction may not produce the desired results if the subject is very bright, in which case you should select mode **A** or **M** and choose a smaller aperture (larger f-number) before starting live view. Note that flicker reduction is not available when **On** is selected for **Movie settings > Manual movie settings** (□ 60) in mode **M**.

Time Zone and Date

MENU button → Setup menu

Change time zones, set the camera clock, choose the date display order, and turn daylight saving time on or off.

Option	Description
Time zone	Choose a time zone. The camera clock is automatically set to the time in the new time zone.
Date and time	Set the camera clock (□ 27). If the clock is not set, a blinking clock icon will appear in the control panel.
Date format	Choose the order in which the day, month, and year are displayed.
Daylight saving time	Turn daylight saving time on or off. The camera clock will automatically be advanced or set back one hour. The default setting is Off .



Language

MENU button → Y Setup menu

Choose a language for camera menus and messages. The following options are available.

Option	Description	Option	Description	Option	Description
Čeština	Czech	Nederlands	Dutch	عربي	Arabic
Dansk	Danish	Norsk	Norwegian	中文(繁體)	Traditional Chinese
Deutsch	German	Polski	Polish	中文(简体)	Simplified Chinese
English	English	Português	Portuguese	日本語	Japanese
Español	Spanish	Русский	Russian	한국	Korean
Français	French	Suomi	Finnish	ภาษาไทย	Thai
Indonesia	Indonesian	Svenska	Swedish		
Italiano	Italian	Türkçe	Turkish		

Image Comment

MENU button → Y Setup menu

Add a comment to new photographs as they are taken. Comments can be viewed as metadata in ViewNX 2 (supplied) or Capture NX 2 (available separately; □ 281). The comment is also visible on the third shooting data page in the photo information display (□ 169).

- **Done:** Save changes and return to the setup menu.
- **Input comment:** Input a comment as described on page 137. Comments can be up to 36 characters long.
- **Attach comment:** Select this option to attach the comment to all subsequent photographs. **Attach comment** can be turned on and off by highlighting it and pressing ►.



Photographs taken while **On** is selected contain information on camera orientation, allowing them to be rotated automatically during playback (□ 163) or when viewed in ViewNX 2 (supplied) or in Capture NX 2 (available separately; □ 281). The following orientations are recorded:



*Landscape (wide)
orientation*



*Camera rotated 90°
clockwise*



*Camera rotated 90°
counter-clockwise*

Camera orientation is not recorded when **Off** is selected. Choose this option when panning or taking photographs with the lens pointing up or down.

Rotate Tall

To automatically rotate “tall” (portrait-orientation) photographs for display during playback, select **On** for the **Rotate tall** option in the playback menu (□ 200). Note that because the camera itself is already in the appropriate orientation during shooting, images are not rotated automatically during image review (□ 163).

Acquire reference data for the Image Dust Off option in Capture NX 2 (available separately; for more information, see the Capture NX 2 manual).

Image Dust Off ref photo is available only when a CPU lens is mounted on the camera. A lens with a focal length of at least 50 mm is recommended. When using a zoom lens, zoom all the way in.

1 Choose a start option.

Highlight one of the following options and press **OK**. To exit without acquiring image dust off data, press **MENU**.



- **Start:** The message shown at right will be displayed and “rEF” will appear in the viewfinder and control panel displays.
- **Clean sensor and then start:** Select this option to clean the image sensor before starting. The message shown at right will be displayed and “rEF” will appear in the viewfinder and control panel displays when cleaning is complete.

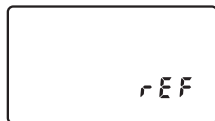
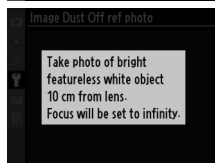
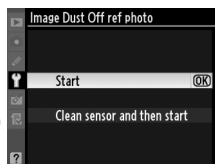

Image Sensor Cleaning

Dust off reference data recorded before image sensor cleaning is performed can not be used with photographs taken after image sensor cleaning is performed. Select **Clean sensor and then start** only if the dust off reference data will not be used with existing photographs.

2 Frame a featureless white object in the viewfinder.

With the lens about ten centimeters (four inches) from a well-lit, featureless white object, frame the object so that it fills the viewfinder and then press the shutter-release button halfway.

In autofocus mode, focus will automatically be set to infinity; in manual focus mode, set focus to infinity manually.

3 Acquire dust off reference data.

Press the shutter-release button the rest of the way down to acquire Image Dust Off reference data. The monitor turns off when the shutter-release button is pressed. Note that noise reduction will be performed if the subject is poorly lit, increasing recording times.

If the reference object is too bright or too dark, the camera may be unable to acquire Image Dust Off reference data and the message shown at right will be displayed. Choose another reference object and repeat the process from step 1.



Image Dust Off Reference Data

The same reference data can be used for photographs taken with different lenses or at different apertures. Reference images can not be viewed using computer imaging software. A grid pattern is displayed when reference images are viewed on the camera.

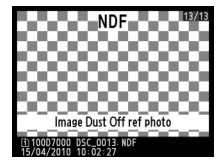

Battery Info

MENU button → Setup menu

View information on the battery currently inserted in the camera.

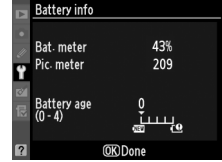

Item	Description
Bat. meter	The current battery level expressed as a percentage.
Pic. meter	The number of times the shutter has been released with the current battery since the battery was last charged. Note that the camera may sometimes release the shutter without recording a photograph, for example when measuring preset white balance.
Battery age	A five-level display showing battery age. 0 (NEW) indicates that battery performance is unimpaired, 4 (REPL) that the battery has reached the end of its charging life and should be replaced. Note that batteries charged at temperatures under about 5 °C (41 °F) may show a temporary drop in charging life; the battery age display will however return to normal once the battery has been recharged at a temperature of about 20 °C (68 °F) or higher.

The MB-D11 Battery Pack

The display for the MB-D11 battery pack is shown at right. If AA batteries are used, the battery level will be shown by a battery level icon; other items will not be displayed.

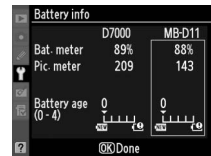

Add copyright information to new photographs as they are taken. Copyright information is visible on the fourth shooting data page in the photo information display (□ 169) and can be viewed as metadata in ViewNX 2 (supplied) or in Capture NX 2 (available separately; □ 281).

- **Done:** Save changes and return to the setup menu.
- **Artist:** Enter a photographer name as described on page 137. Photographer names can be up to 36 characters long.
- **Copyright:** Enter the name of the copyright holder as described on page 137. Copyright holder names can be up to 54 characters long.
- **Attach copyright information:** Select this option to attach copyright information to all subsequent photographs. **Attach copyright information** can be turned on and off by highlighting it and pressing ►.



☑ Copyright Information

To prevent unauthorized use of the artist or copyright holder names, make sure that **Attach copyright information** is not selected and that the **Artist** and **Copyright** fields are blank before lending or transferring the camera to another person. Nikon does not accept liability for any damages or disputes arising from the use of the **Copyright information** option.

Save/Load Settings

MENU button → Y Setup menu

Select **Save settings** to save the following settings to the memory card in Slot 1 (if the memory card is full, an error will be displayed; □ 306).

Menu	Option	Menu	Option	
Playback	Display mode	Custom settings	All Custom Settings except Reset custom settings	
	Image review		Clean image sensor	
	After delete		Video mode	
	Rotate tall		HDMI	
Shooting	File naming	Setup	Flicker reduction	
	Role played by card in Slot 2		Time zone and date (excepting date and time)	
	Image quality		Language	
	Image size		Image comment	
	JPEG compression		Auto image rotation	
	NEF (RAW) recording		Copyright information	
	White balance (with fine tuning and presets d-0–d-4)		GPS	
	Set Picture Control		Non-CPU lens data	
	Auto distortion control		My Menu/ Recent Settings	All My Menu items
	Color space			All recent settings
	Active D-Lighting	Choose tab		
	Long exp. NR			
	High ISO NR			
	ISO sensitivity settings			
	Movie settings			
	Remote control mode			

Settings saved using this model of camera can be restored by selecting **Load settings**. Note that **Save/load settings** is only available when a memory card is inserted in the camera, and that the **Load settings** option is only available if the card contains saved settings.

Saved Settings

Settings are saved in a file named NCSETUP7. The camera will not be able to load settings if the file name is changed.

Display a virtual horizon based on information from the camera tilt sensor. The reference line is displayed in green when the camera is level.

✔ Tilting the Camera

The virtual horizon display is not accurate when the camera is tilted at a sharp angle forward or back. If the camera is unable to measure tilt, the amount of tilt will not be displayed.

✎ Viewfinder Virtual Horizon

If **Viewfinder virtual horizon** is assigned to the **Fn** or depth-of-field preview button using Custom Setting f3 (**Assign Fn button**) or f4 (**Assign preview button**), a tilt meter can be displayed in the viewfinder by pressing the selected button (☞ 231).

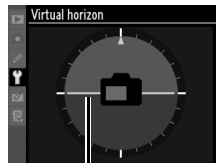

✎ See Also

A virtual horizon can also be displayed during live view (☞ 53).



Reference line

Fine-tune focus for up to 12 lens types. AF tuning is not recommended in most situations and may interfere with normal focus; use only when required.

Option	Description
AF fine tune (On/Off)	<ul style="list-style-type: none"> • On: Turn AF tuning on. • Off: Turn AF tuning off.
Saved value	<p>Tune AF for the current lens (CPU lenses only). Press ▲ or ▼ to choose a value between +20 and -20. Values for up to 12 lens types can be stored. Only one value can be stored for each type of lens.</p>
Default	<p>Choose the AF tuning value used when no previously saved value exists for the current lens (CPU lenses only).</p>
List saved values	<p>List previously saved AF tuning values. If a value exists for the current lens, it will be shown with a ■ icon. To delete a lens from the list, highlight the desired lens and press . To change a lens identifier (for example, to choose an identifier that is the same as the last two digits of the lens serial number to distinguish it from other lenses of the same type in light of the fact that Saved value can be used with only one lens of each type), highlight the desired lens and press ►.</p> <p>The menu shown at right will be displayed; press ▲ or ▼ to choose an identifier and press  to save changes and exit.</p>

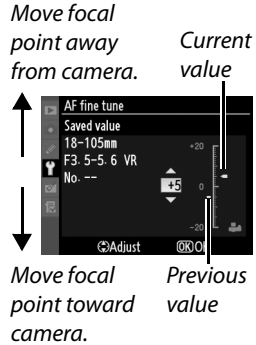

AF Tuning

The camera may be unable to focus at minimum range or at infinity when AF tuning is applied.

Live View

Tuning is not applied to autofocus during in live view ( 49).

Saved Value

Only one value can be stored for each type of lens. If a teleconverter is used, separate values can be stored for each combination of lens and teleconverter.





Eye-Fi Upload

MENU button → Setup menu

This option is displayed only when an Eye-Fi memory card (available separately from third-party suppliers) is inserted in the camera. Choose **Enable** to upload photographs to a preselected destination. Note that pictures will not be uploaded if signal strength is insufficient.

Observe all local laws concerning wireless devices and choose **Disable** where wireless devices are prohibited.

When an Eye-Fi card is inserted, its status is indicated by an icon in the information display:

- : Eye-Fi upload disabled.
- : Eye-Fi upload enabled but no pictures available for upload.
-  (static): Eye-Fi upload enabled; waiting to begin upload.
-  (animated): Eye-Fi upload enabled; uploading data.
- : Error — camera can not control Eye-Fi card. If a blinking **Err** appears in the control panel or viewfinder, refer to page 307; if this indicator is not displayed, pictures can be taken normally but you may be unable to change Eye-Fi settings.

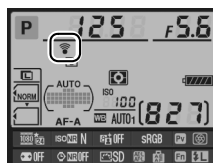

Eye-Fi Cards

Eye-Fi cards may emit wireless signals when **Disable** is selected. If a warning is displayed in the monitor (307), turn the camera off and remove the card.

See the manual provided with the Eye-Fi card, and direct any inquiries to the manufacturer. The camera can be used to turn Eye-Fi cards on and off, but may not support other Eye-Fi functions.

Supported Eye-Fi Cards

As of June 2010, the following Eye-Fi cards can be used: 2 GB SD cards in the Share, Home, and Explore product categories, 4 GB SDHC cards in the Anniversary, Share Video, Explore Video, and Connect X2 product categories, and 8 GB SDHC cards in the Pro X2 and Explore X2 product categories. Eye-Fi cards are for use only in the country of purchase. Be sure the Eye-Fi card firmware has been updated to the latest version.

Firmware Version

MENU button → Setup menu

View the current camera firmware version.









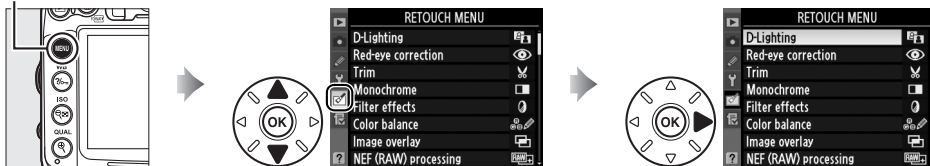













The Retouch Menu: Creating Retouched Copies

To display the retouch menu, press **MENU** and select the  (retouch menu) tab.

MENU button



The options in the retouch menu are used to create trimmed or retouched copies of existing pictures. The retouch menu is only displayed when a memory card containing photographs is inserted in the camera.

Option		Option	
 D-Lighting	251	 Straighten	261
 Red-eye correction	251	 Distortion control	261
 Trim	252	 Fisheye	261
 Monochrome	253	 Color outline	262
 Filter effects	254	 Color sketch	262
 Color balance	255	 Perspective control	263
 Image overlay ¹	256	 Miniature effect	263
 NEF (RAW) processing	258	 Edit movie	63
 Resize	259	 Side-by-side comparison ²	264
 Quick retouch	260		

1 Can only be selected by pressing **MENU** and selecting  tab.

2 Only available if  is pressed in full-frame playback when a retouched image or original is displayed.

Retouching Copies

With the exceptions of **Image overlay** and **Edit movie > Choose start point/Choose end point**, each effect can be applied only once (note that multiple edits may result in loss of detail). Options that can not be applied to the current image are grayed out and unavailable.

Image Quality

Except in the case of copies created with **Trim**, **Image overlay**, **NEF (RAW) processing**, and **Resize**, copies created from JPEG images are the same size and quality as the original, while copies created from NEF (RAW) photos are saved as large fine-quality JPEG images. Size-priority compression is used when copies are saved in JPEG format.

Creating Retouched Copies

To create a retouched copy:

1 Display retouch options.

Highlight the desired item in the retouch menu and press ►.

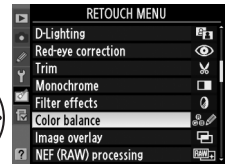

2 Select a picture.

Highlight a picture and press **OK** (to view the highlighted picture full screen, press and hold the **Q** button; to view images in other locations as described on page 164, hold **BKT** and press **▲**).

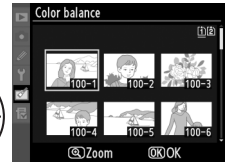

Retouch

The camera may not be able to display or retouch images created with other devices.

3 Select retouch options.

For more information, see the section for the selected item. To exit without creating a retouched copy, press **MENU**.

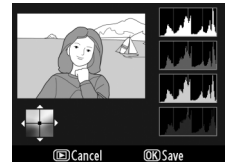

Monitor off Delay

The monitor will turn off and the operation will be cancelled if no actions are performed for 20 s; this can be adjusted using Custom Setting c4 (**Monitor off delay**; **215**).

4 Create a retouched copy.

Press **OK** to create a retouched copy. Retouched copies are indicated by a  icon.



Creating Retouched Copies During Playback

Retouched copies can also be created during playback.



*Display picture full frame and press **OK**.*

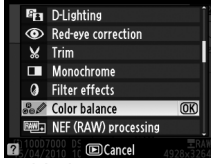

*Highlight an option and press **OK**.*



Create retouched copy.

D-Lighting

MENU button → retouch menu

D-lighting brightens shadows, making it ideal for dark or backlit photographs.



Before

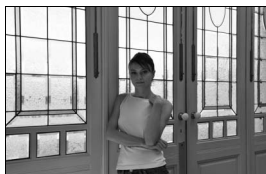

After

Press ▲ or ▼ to choose the amount of correction performed. The effect can be previewed in the edit display. Press to copy the photograph.

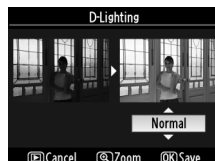

Red-Eye Correction

MENU button → retouch menu

This option is used to correct “red-eye” caused by the flash, and is available only with photographs taken using the flash. The photograph selected for red-eye correction is previewed as shown at right. Confirm the effects of red-eye correction and create a copy as described in the following table. Note that red-eye correction may not always produce the expected results and may in very rare circumstances be applied to portions of the image that are not affected by red-eye; check the preview thoroughly before proceeding.



To	Use	Description
Zoom in		Press button to zoom in, button to zoom out. While photo is zoomed in, use multi selector to view areas of image not visible in monitor. Keep multi selector pressed to scroll rapidly to other areas of frame. Navigation window is displayed when zoom buttons or multi selector is pressed; area currently visible in monitor is indicated by yellow border.
Zoom out		
View other areas of image		
Cancel zoom		
Create copy		If the camera detects red-eye in the selected photograph, a copy will be created that has been processed to reduce its effects. No copy will be created if the camera is unable to detect red-eye.









Trim

MENU button →  retouch menu

Create a cropped copy of the selected photograph. The selected photograph is displayed with the selected crop shown in yellow; create a cropped copy as described in the following table.



To	Use	Description
Reduce size of crop		Press the  button to reduce the size of the crop.
Increase size of crop		Press the  button to increase the size of the crop.
Change crop aspect ratio		Rotate the main command dial to switch between aspect ratios of 3 : 2, 4 : 3, 5 : 4, 1 : 1, and 16 : 9.
Move crop		Use multi selector to move the crop to another area of the image.
Create copy		Save the current crop as a separate file.

Trim: Image Quality and Size

Copies created from NEF (RAW) or NEF (RAW) + JPEG photos have an image quality ( 85) of JPEG fine; cropped copies created from JPEG photos have the same image quality as the original. The size of the copy varies with crop size and aspect ratio and appears at upper left in the crop display.



Viewing Cropped Copies

Playback zoom may not be available when cropped copies are displayed.

Monochrome

MENU button →  retouch menu

Copy photographs in **Black-and-white**, **Sepia**, or **Cyanotype** (blue and white monochrome).

Selecting **Sepia** or **Cyanotype** displays a preview of the selected image; press ▲ to increase color saturation, ▼ to decrease. Press OK to create a monochrome copy.

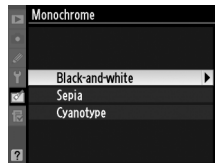

Increase saturation



Decrease saturation

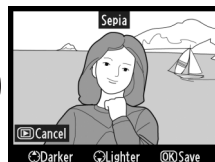

Filter Effects

MENU button → retouch menu

Choose from the following filter effects. After adjusting filter effects as described below, press to copy the photograph.

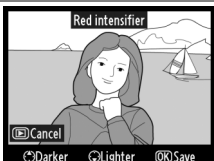
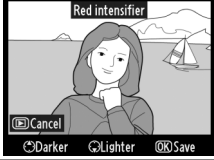
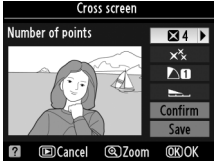
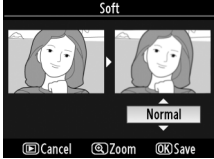
Option	Description	
Skylight	Creates the effect of a skylight filter, making the picture less blue. The effect can be previewed in the monitor as shown at right.	
Warm filter	Creates a copy with warm tone filter effects, giving the copy a “warm” red cast. The effect can be previewed in the monitor.	
Red intensifier Green intensifier Blue intensifier	Intensify reds (Red intensifier), greens (Green intensifier), or blues (Blue intensifier). Press ▲ to increase the effect, ▼ to decrease.	
Cross screen	<p>Add starburst effects to light sources.</p> <ul style="list-style-type: none"> • Number of points: Choose from four, six, or eight. • Filter amount: Choose the brightness of the light sources affected. • Filter angle: Choose the angle of the points. • Length of points: Choose the length of points. • Confirm: Preview the effects of the filter as shown at right. Press to preview the copy full frame. • Save: Create a retouched copy. 	
Soft	Add a soft filter effect. Press ▲ or ▼ to choose the filter strength.	

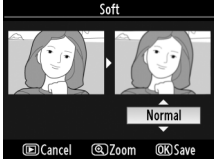
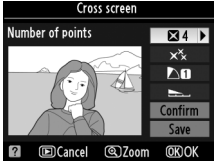
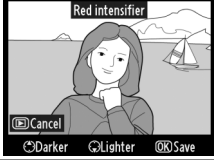

Color Balance

MENU button → retouch menu

Use the multi selector to create a copy with modified color balance as shown below. The effect is displayed in the monitor together with red, green, and blue histograms (📖 167) giving the distribution of tones in the copy.

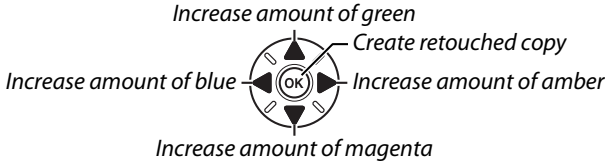

Zoom

To zoom in on the image displayed in the monitor, press the button. The histogram will be updated to show data only for the portion of the image displayed in the monitor. While the image is zoomed in, press the button to toggle back and forth between color balance and zoom. When zoom is selected, you can zoom in and out with the and buttons and scroll the image with the multi selector.



Image overlay combines two existing NEF (RAW) photographs to create a single picture that is saved separately from the originals; the results, which make use of RAW data from the camera image sensor, are noticeably better than overlays created in an imaging application. The new picture is saved at current image quality and size settings; before creating an overlay, set image quality and size (☐ 85, 88; all options are available). To create a NEF (RAW) copy, choose an image quality of **NEF (RAW)**.

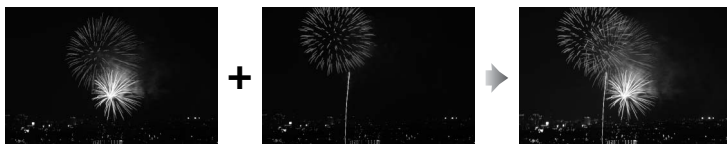

1 Select Image overlay.

Highlight **Image overlay** in the retouch menu and press ►. The dialog shown at right will be displayed, with **Image 1** highlighted; press **OK** to display a list of the NEF pictures created with this camera.



2 Select the first image.

Use the multi selector to highlight a photo. To view the highlighted image full frame, press and hold the **Q** button (to view images in other locations as described on page 164, hold **BKT** and press ▲). Press **OK** to select the highlighted photograph and return to the preview display.



3 Select the second image.

The selected image will appear as **Image 1**. Highlight **Image 2** and press **OK**, then select the second photo as described in Step 2. Choose an image with the same bit-depth as the photo selected for **Image 1**.

4 Adjust gain.

Highlight **Image 1** or **Image 2** and optimize exposure for the overlay by pressing ▲ or ▼ to select gain from values between 0.1 and 2.0. Repeat for the second image. The default value is 1.0; select 0.5 to halve gain or 2.0 to double it. The effects are visible in the **Preview** column.



5 Preview the overlay.

Press ◀ or ▶ to place the cursor in the **Preview** column and press ▲ or ▼ to highlight **Overlay**. Press OK to preview the overlay as shown at right (to save the overlay without displaying a preview, select **Save**). To return to Step 4 and select new photos or adjust gain, press .



6 Save the overlay.

Press OK while the preview is displayed to save the overlay. After an overlay is created, the resulting image will be displayed full-frame in the monitor.



Image Overlay

The overlay has the same photo info (including date of recording, metering, shutter speed, aperture, shooting mode, exposure compensation, focal length, and image orientation), white balance, and Picture Control as **Image 1**. The current image comment is appended to the overlay; copyright information, however, is not copied. NEF (RAW) overlays use the compression selected for **Type** in the **NEF (RAW) recording** menu and have the same bit depth as the original images; JPEG overlays are saved using size-priority compression.

Create JPEG copies of NEF (RAW) photographs.

1 Select NEF (RAW) processing.

Highlight **NEF (RAW) processing** in the retouch menu and press to display a picture selection dialog listing only NEF (RAW) images created with this camera.

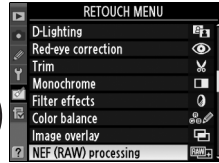

2 Select a photograph.

Highlight a photograph (to view the highlighted photograph full frame, press and hold the button; to view images in other locations as described on page 164, hold **BKT** and press). Press to select the highlighted photograph.

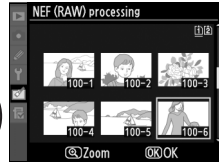

3 Choose settings for the JPEG copy.

Adjust image quality (85), image size (88), white balance (117; if **Auto** is selected, white balance will be set to whichever of **Normal** and **Keep warm lighting colors** was in effect when the picture was taken), exposure compensation (107), Picture Control (131; note that the Picture Control grid can not be displayed), high ISO noise reduction (205), color space (141), and D-Lighting (251). Note that white balance is not available with multiple exposures or pictures created with image overlay and that exposure compensation can only be set to values between -2 and +2 EV.

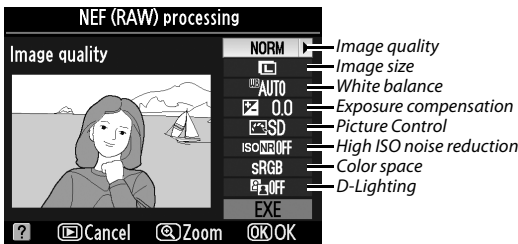

4 Copy the photograph.

Highlight **EXE** and press to create a JPEG copy of the selected photograph (to exit without copying the photograph, press the MENU button).



Create small copies of selected photographs.

1 Select Resize.

To resize selected images, press MENU to display the menus and select **Resize** in the retouch menu.



2 Choose a destination.

If two memory cards are inserted, you can choose a destination for the resized copies by highlighting **Choose destination** and pressing (if only one card is inserted, proceed to Step 3).

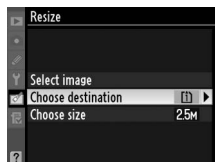

The menu shown at right will be displayed; highlight a card slot and press .

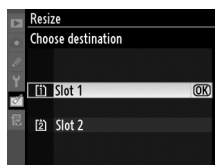

3 Choose a size.

Highlight **Choose size** and press .

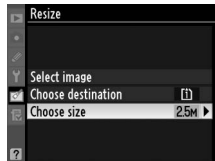

The following options will be displayed; highlight an option and press .

Option	Size (pixels)	Option	Size (pixels)
2.5M	1920 × 1280	0.3M	640 × 424
1.1M	1280 × 856	0.1M	320 × 216
0.6M	960 × 640		

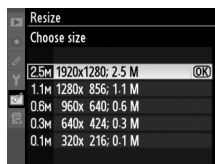

4 Choose pictures.

Highlight **Select image** and press **▶**.

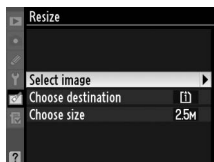

The dialog shown at right will be displayed; highlight pictures using the multi selector and press the **☒** button to select or deselect (to view the highlighted picture full screen, press and hold the **Ⓚ** button; to view images in other locations as described on page 164, hold **BKT** and press **▲**). Selected pictures are marked by a **☒** icon. Press **Ⓚ** when the selection is complete.



5 Save the resized copies.

A confirmation dialog will be displayed. Highlight **Yes** and press **Ⓚ** to save the resized copies.

Viewing Resized Copies

Playback zoom may not be available when resized copies are displayed.

Image Quality

Copies created from NEF (RAW) or NEF (RAW) + JPEG photos have an image quality (☒ 85) of JPEG fine; copies created from JPEG photos have the same image quality as the original.

Quick Retouch

MENU button →  retouch menu

Create copies with enhanced saturation and contrast. D-Lighting is applied as required to brighten dark or backlit subjects.

Press **▲** or **▼** to choose the amount of enhancement. The effect can be previewed in the edit display. Press **Ⓚ** to copy the photograph.

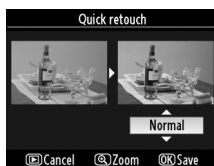

Straighten

MENU button →  retouch menu

Create a straightened copy of the selected image. Press **▶** to rotate the image clockwise by up to five degrees in increments of approximately 0.25 degrees, **◀** to rotate it counterclockwise (note that edges of the image will be trimmed to create a square copy). Press **Ⓚ** to copy the photograph, or press **▶** to exit to playback without creating a copy.

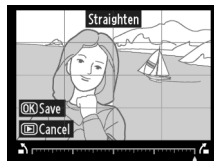

Distortion Control

MENU button →  retouch menu

Create copies with reduced peripheral distortion. Select **Auto** to let the camera correct distortion automatically and then make fine adjustments using the multi selector, or select **Manual** to reduce distortion manually (note that **Auto** is not available with photos taken using auto distortion control; see page 205). Press **▶** to reduce barrel distortion, **◀** to reduce pin-cushion distortion (note that greater amounts of distortion control result in more of the edges being cropped out). Press **Ⓚ** to copy the photograph, or press **▶** to exit to playback without creating a copy.

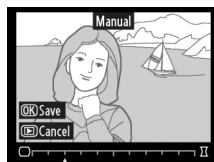

Auto

Auto is for use only with pictures taken with type G and D lenses (PC, fisheye, and certain other lenses excluded). Results are not guaranteed with other lenses.

Fisheye

MENU button →  retouch menu

Create copies that appear to have been taken with a fisheye lens. Press **▶** to increase the effect (this also increases the amount of that will be cropped out at the edges of the image), **◀** to reduce it. Press **Ⓚ** to copy the photograph, or press **▶** to exit to playback without creating a copy.

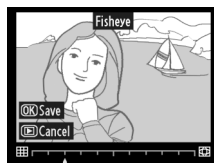

Color Outline

MENU button → retouch menu

Create an outline copy of a photograph to use as a base for painting. The effect can be previewed in the edit display. Press **OK** to copy the photograph.

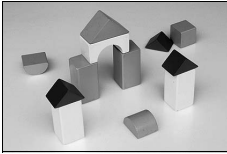

Before

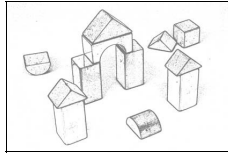

After



Color Sketch

MENU button → retouch menu

Create a copy of a photograph that resembles a sketch made with colored pencils. Press **▲** or **▼** to highlight **Vividness** or **Outlines** and press **◀** or **▶** to change. Vividness can be increased to make colors more saturated, or decreased for a washed-out, monochromatic effect, while outlines can be made thicker or thinner. The results can be previewed in the edit display. Press **OK** to copy the photograph, or press **▶** to exit to playback without creating a copy.

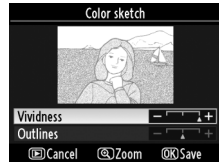

Perspective Control

MENU button → retouch menu

Create copies that reduce the effects of perspective taken from the base of a tall object. Use the multi selector to adjust perspective (note that greater amounts of perspective control result in more of the edges being cropped out). The results can be previewed in the edit display. Press **OK** to copy the photograph, or press **▶** to exit to playback without creating a copy.



Before



After

Miniature Effect

MENU button → retouch menu

Create a copy that appears to be a photo of a diorama. Works best with photos taken from a high vantage point.

To	Press	Description
Choose area in focus		If photo is displayed in wide orientation, press ▲ or ▼ to position frame showing area of copy that will be in focus.
		If photo is displayed in tall orientation (239), press ◀ or ▶ to position frame showing area of copy that will be in focus.
Preview copy		Preview copy.
Cancel	▶	Exit to full-frame playback without creating copy.
Create copy	OK	Create copy.

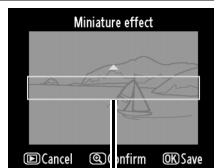

Area in focus

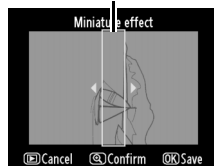

Side-by-side Comparison

MENU button → retouch menu

Compare retouched copies to the original photographs. This option is only available if the button is pressed to display the retouch menu when a copy or original is played back full frame.

1 Select a picture.

In full-frame playback, select a retouched copy (shown by a icon) or a photograph that has been retouched and press .



2 Select Side-by-side comparison.

Highlight **Side-by-side comparison** and press .

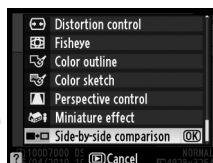

3 Compare the copy with the original.

The source image is displayed on the left, the retouched copy on the right, with the options used to create the copy listed at the top of the display. Press or to switch between the source image and the retouched copy. To view the highlighted picture full frame, press and hold the button. If the copy was created from two source images using **Image overlay**, or if the source has been copied multiple times, press or to view the other source images or copies. To exit to playback mode, press the button. To exit to playback mode with the highlighted image displayed, press .

Options used to create copy

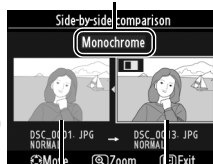

Source image Retouched copy

Side-by-side Comparisons

The source image will not be displayed if the copy was created from a photograph that was protected (174), is on a locked memory card, has since been deleted or hidden (196), or is on a card in a different slot from that used when the image was created.

My Menu / Recent Settings

“My Menu” is a customized menu that gives you quick access to up to 20 options selected from the playback, shooting, Custom Settings, setup, and retouch menus. To display My Menu, press **MENU** and select the  (My Menu) tab.

MENU button

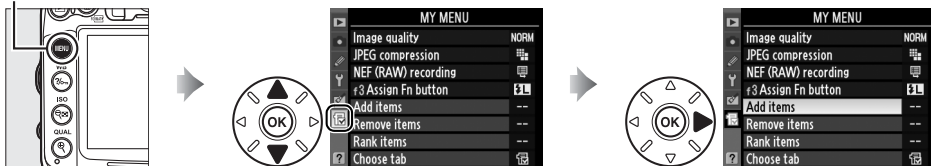

Options can be added, deleted, and reordered as described below. If desired, recent settings can be displayed in place of My Menu ( 268).

■ Adding Options to My Menu

1 Select Add items.

In My Menu () , highlight **Add items** and press **▶**.



2 Select a menu.

Highlight the name of the menu containing the option you wish to add and press **▶**.

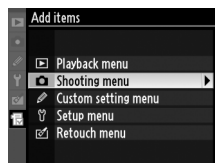

3 Select an item.

Highlight the desired menu item and press **⊙**.

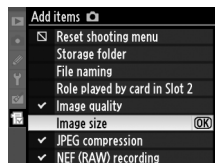

4 Position the new item.

Press **▲** or **▼** to move the new item up or down in My Menu. Press **⊙** to add the new item.



5 Add more items.

The items currently displayed in My Menu are indicated by a check mark. Items indicated by a icon can not be selected. Repeat steps 1–4 to select additional items.



Deleting Options from My Menu

1 Select Remove items.

In My Menu (M), highlight **Remove items** and press ►.

2 Select items.

Highlight items and press ► to select or deselect. Selected items are indicated by a check mark.

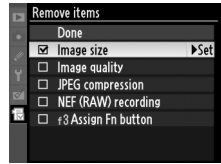

3 Select Done.

Highlight **Done** and press OK. A confirmation dialog will be displayed.

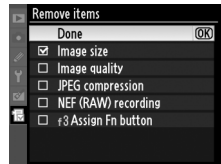

4 Delete the selected items.

Press OK to delete the selected items.



Deleting Items in My Menu

To delete the item currently highlighted in My Menu, press the button. A confirmation dialog will be displayed; press again to remove the selected item from My Menu.

■ Reordering Options in My Menu

1 Select Rank items.

In My Menu (MENU), highlight **Rank items** and press ►.

2 Select an item.

Highlight the item you wish to move and press OK.

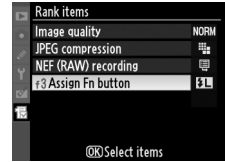

3 Position the item.

Press ▲ or ▼ to move the item up or down in My Menu and press OK. Repeat Steps 2–3 to reposition additional items.





4 Exit to My Menu.

Press the MENU button to return to My Menu.

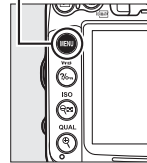

MENU button



Recent Settings



To display the twenty most recently used settings, select  **Recent settings** for  **My Menu** > **Choose tab**.

1 Select **Choose tab**.



In My Menu () , highlight **Choose tab** and press  .





2 Select **Recent settings**.

Highlight  **Recent settings** and press  .
The name of the menu will change from “MY MENU” to “RECENT SETTINGS.”



Menu items are added to the top of the recent settings menu as they are used. To view My Menu again, select  **My Menu** for  **Recent settings** > **Choose tab**.

Removing Items from the Recent Settings Menu

To remove an item from the recent settings menu, highlight it and press the  button. A confirmation dialog will be displayed; press  again to delete the selected item.

Technical Notes

Read this chapter for information on compatible accessories, cleaning and storing the camera, and what to do if an error message is displayed or you encounter problems using the camera.

Compatible Lenses

CPU lenses (particularly types G and D) are recommended, but note that IX-NIKKOR lenses can not be used. CPU lenses can be identified by the presence of CPU contacts, type G and D lenses by a letter on the lens barrel. Type G lenses are not equipped with a lens aperture ring. The maximum aperture of the lens is given by the f-number in the lens name.

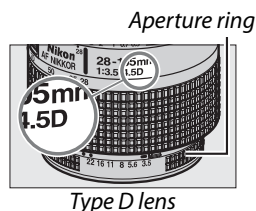
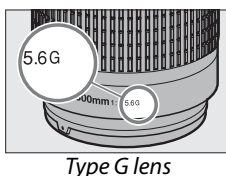
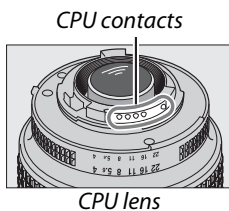

Compatible CPU Lenses

Camera setting Lens/accessory ¹	Focus		Mode		Metering		
	AF	M (with electronic rangefinder)	M	Auto and scene modes; P, S, A	M	3D	Color
Type G or D AF NIKKOR/AF-S, AF-I NIKKOR	✓	✓	✓	✓	✓	✓	✓ ²
PC-E NIKKOR series	—	✓ ³	✓	✓ ³	✓ ³	✓ ³	✓ ^{2,3}
PC Micro 85mm f/2.8D ⁴	—	✓ ³	✓	—	✓	✓	✓ ^{2,3}
AF-S/AF-I teleconverter ⁵	✓ ⁶	✓ ⁶	✓	✓	✓	✓	✓ ²
Other AF NIKKOR (except lenses for F3AF)	✓ ⁷	✓ ⁷	✓	✓	✓	—	✓ ²
AI-P NIKKOR	—	✓ ⁸	✓	✓	✓	—	✓ ²

1 Vibration Reduction (VR) supported with VR lenses.

2 Spot metering meters selected focus point (□ 105).

3 Can not be used with shifting or tilting.

4 The camera's exposure metering and flash control systems may not function as expected when the lens is shifted and/or tilted or aperture is set to a value other than maximum.

5 AF-S or AF-I lens required.

6 With maximum effective aperture of f/5.6 or faster.

7 When AF 80–200mm f/2.8, AF 35–70mm f/2.8, AF 28–85mm f/3.5–4.5 (New), or AF 28–85mm f/3.5–4.5 lenses are zoomed all the way in at the minimum focus distance, the in-focus indicator may be displayed when the image on the matte screen in the viewfinder is not in focus. Focus manually until image in viewfinder is in focus.

8 With maximum aperture of f/5.6 or faster.

Compatible Non-CPU Lenses

When using the following non-CPU lenses and accessories, rotate the camera mode dial to **A** and **M** and set aperture using the lens aperture ring. In other modes, the shutter-release is disabled. **Non-CPU lens data** (□ 159) can be used to enable many of the features available with CPU lenses, including color matrix metering; if no data are provided, center-weighted metering will be used in place of color matrix metering, while if the maximum aperture is not provided, the camera aperture display will show the number of stops from maximum aperture and the actual aperture value must be read off the lens aperture ring. For a list of non-CPU lenses and accessories that can not be used with this camera, see page 271.

Lens/accessory	Camera setting		Focus		Mode		Metering		
	AF	M (with electronic rangefinder)	M	Auto and scene modes; P, S	A, M	☑		☑	
						3D	Color	☑	
AI-, AI-modified, NIKKOR or Nikon Series E ¹	—	✓ ²	✓	—	✓ ³	—	✓ ⁴	✓ ⁵	
Medical-NIKKOR 120mm f/4	—	✓	✓	—	✓ ⁶	—	—	—	
Reflex-NIKKOR	—	—	✓	—	✓ ³	—	—	✓ ⁵	
PC-NIKKOR	—	✓ ⁷	✓	—	✓ ⁸	—	—	✓	
AI-type Teleconverter ⁹	—	✓ ¹⁰	✓	—	✓ ³	—	✓ ⁴	✓ ⁵	
PB-6 Bellows Focusing Attachment ¹¹	—	✓ ¹⁰	✓	—	✓ ¹²	—	—	✓	
Auto extension rings (PK-series 11A, 12, or 13; PN-11)	—	✓ ¹⁰	✓	—	✓ ³	—	—	✓	

1 Range of rotation for AI 80–200mm f/2.8 ED tripod mount is limited by camera body. Filters can not be exchanged while AI 200–400mm f/4 ED is mounted on camera.

2 With maximum aperture of f/5.6 or faster.

3 If maximum aperture is specified using **Non-CPU lens data** (□ 159), aperture value will be displayed in viewfinder and control panel.

4 Can be used only if lens focal length and maximum aperture are specified using **Non-CPU lens data** (□ 159). Use spot or center-weighted metering if desired results are not achieved.

5 For improved precision, specify lens focal length and maximum aperture using **Non-CPU lens data** (□ 159).

6 Can be used in mode **M** at shutter speeds slower than flash sync speed by one step or more.

7 Electronic rangefinder can not be used with shifting or tilting.

8 Exposure determined by presetting lens aperture. In mode **A**, preset aperture using lens aperture ring before performing AE lock and shifting lens. In mode **M**, preset aperture using lens aperture ring and determine exposure before shifting lens.

9 Exposure compensation required when used with AI 28–85mm f/3.5–4.5, AI 35–105mm f/3.5–4.5, AI 35–135mm f/3.5–4.5, or AF-S 80–200mm f/2.8D. See teleconverter manual for details.

10 With maximum effective aperture of f/5.6 or faster.

11 Requires PK-12 or PK-13 auto extension ring. PB-6D may be required depending on camera orientation.

12 Use preset aperture. In mode **A**, set aperture using focusing attachment before determining exposure and taking photograph.

• PF-4 Reprocopy Outfit requires PA-4 Camera Holder.



Incompatible Accessories and Non-CPU Lenses

The following accessories and non-CPU lenses can NOT be used with the D7000:

- TC-16AS AF teleconverter
- Non-AI lenses
- Lenses that require the AU-1 focusing unit (400mm f/4.5, 600mm f/5.6, 800mm f/8, 1200mm f/11)
- Fisheye (6mm f/5.6, 7.5mm f/5.6, 8mm f/8, OP 10mm f/5.6)
- 2.1cm f/4
- Extension Ring K2
- 180–600mm f/8 ED (serial numbers 174041–174180)
- 360–1200mm f/11 ED (serial numbers 174031–174127)
- 200–600mm f/9.5 (serial numbers 280001–300490)
- AF lenses for the F3AF (AF 80mm f/2.8, AF 200mm f/3.5 ED, AF Teleconverter TC-16)
- PC 28mm f/4 (serial number 180900 or earlier)
- PC 35mm f/2.8 (serial numbers 851001–906200)
- PC 35mm f/3.5 (old type)
- Reflex 1000mm f/6.3 (old type)
- Reflex 1000mm f/11 (serial numbers 142361–143000)
- Reflex 2000mm f/11 (serial numbers 200111–200310)

The Built-in Flash

The built-in flash can be used with lenses with focal lengths of 16–300 mm, although in some cases the flash may be unable to entirely light the subject at some ranges or focal lengths due to shadows cast by the lens, while lenses that block the subject's view of the red-eye reduction lamp may interfere with red-eye reduction. Remove lens hoods to prevent shadows. The flash has a minimum range of 0.6 m (2 ft.) and can not be used in the macro range of macro zoom lenses. The flash may be unable to light the entire subject with the following lenses at ranges less than those given below:

Lens	Zoom position	Minimum distance without vignetting
AF-S DX NIKKOR 10–24mm f/3.5–4.5G ED	18 mm	1.0 m/3 ft. 3 in.
	20–24 mm	No vignetting
AF-S DX Zoom-Nikkor 12–24mm f/4G IF-ED	18 mm	1.0 m/3 ft. 3 in.
	20–24 mm	No vignetting
AF-S NIKKOR 16–35mm f/4G ED VR	24 mm	2.0 m/6 ft. 7 in.
	28 mm	1.0 m/3 ft. 3 in.
	35 mm	No vignetting
AF-S Zoom-Nikkor 17–35mm f/2.8D IF-ED	20 mm	2.0 m/6 ft. 7 in.
	24–35 mm	No vignetting
AF-S DX Zoom-Nikkor 17–55 mm f/2.8G IF-ED	24 mm	1.0 m/3 ft. 3 in.
	28–55 mm	No vignetting
AF Zoom-Nikkor 18–35mm f/3.5– 4.5D IF-ED	18 mm	1.0 m/3 ft. 3 in.
	24–35 mm	No vignetting



Lens	Zoom position	Minimum distance without vignetting
AF-S DX VR Zoom-Nikkor 18–200mm f/3.5–5.6G IF-ED	18 mm	1.0 m/3 ft. 3 in.
AF-S DX NIKKOR 18–200mm f/3.5–5.6G ED VR II	24–200 mm	No vignetting
AF-S NIKKOR 24–70mm f/2.8G ED	28 mm	1.5 m/4 ft. 11 in.
	35–70 mm	No vignetting
AF-S Zoom-Nikkor 28–70mm f/2.8D IF-ED	28 mm	1.0 m/3 ft. 3 in.
	35–70 mm	No vignetting
PC-E NIKKOR 24mm f/3.5 ED *	24 mm	No vignetting

* When not shifted or tilted.

When used with the AF-S NIKKOR 14–24mm f/2.8G ED, the flash will be unable to light the entire subject at all ranges.

The built-in flash can also be used with AI-S, AI-, AI-modified NIKKOR, Nikon Series E and non-CPU lenses with a focal length of 16–300mm. AI 50–300mm f/4.5, modified AI 50–300mm f/4.5, and AI-S 50–300mm f/4.5 ED lenses must be used at a zoom position of 135mm or above, and AI 50–300mm f/4.5 ED lenses at a zoom position of 105mm or above.

The AF-S/AF-I Teleconverter

The AF-S/AF-I teleconverter can be used with the following AF-S and AF-I lenses:

- AF-S VR 70–200mm f/2.8G ED
- AF-S NIKKOR 70–200mm f/2.8G ED VR II
- AF-S 80–200mm f/2.8D ED
- AF-S VR Micro 105mm f/2.8G ED¹
- AF-S VR 200mm f/2G ED
- AF-S VR 200–400mm f/4G ED²
- AF-S NIKKOR 200–400mm f/4G ED VR II²
- AF-S VR 300mm f/2.8G ED
- AF-S 300mm f/2.8D ED
- AF-S 300mm f/2.8D ED II
- AF-I 300mm f/2.8D ED
- AF-S 300mm f/4D ED²
- AF-S NIKKOR 400mm f/2.8G ED VR
- AF-S 400mm f/2.8D ED
- AF-S 400mm f/2.8D ED II
- AF-I 400mm f/2.8D ED
- AF-S NIKKOR 500mm f/4G ED VR²
- AF-S 500mm f/4D ED²
- AF-S 500mm f/4D ED II²
- AF-I 500mm f/4D ED²
- AF-S NIKKOR 600mm f/4G ED VR²
- AF-S 600mm f/4D ED²
- AF-S 600mm f/4D ED II²
- AF-I 600mm f/4D ED²

¹ Autofocus not supported.

² Autofocus not supported when used with AF-S Teleconverter TC-17E II/TC-20E II/TC-20E III.

AF-Assist Illumination

AF-assist illumination is available with lenses with focal lengths of 24–200 mm. It can not however be used to assist the focus operation with the following lenses:

- AF-S NIKKOR 14–24mm f/2.8G ED
- AF-S VR Zoom-Nikkor 70–200mm f/2.8G IF-ED
- AF-S NIKKOR 70–200mm f/2.8G ED VR II
- Ai AF Zoom-Nikkor 80–200mm f/2.8D ED
- AF-S Zoom-Nikkor 80–200mm f/2.8D IF-ED
- Ai AF VR Zoom-Nikkor 80–400mm f/4.5–5.6D ED
- AF-S VR Nikkor 200mm f/2G IF-ED
- AF-S VR Zoom-Nikkor 200–400mm f/4G IF-ED
- AF-S NIKKOR 200–400mm f/4G ED VR II

At ranges under 1 m (3 ft. 3 in.), the following lenses may block the AF-assist illuminator and interfere with autofocus when lighting is poor:

- AF-S Zoom-Nikkor 17–35mm f/2.8D IF-ED
- AF-S DX Zoom-Nikkor 17–55mm f/2.8G IF-ED
- AF-S DX VR Zoom-Nikkor 18–200mm f/3.5–5.6G IF-ED
- AF-S DX NIKKOR 18–200mm f/3.5–5.6G ED VR II
- AF-S NIKKOR 24–70mm f/2.8G ED
- Ai AF Zoom Nikkor 24–120mm F3.5–5.6D (IF)
- AF-S VR Zoom-Nikkor 24–120mm f/3.5–5.6G IF-ED
- AF-S Zoom-Nikkor 28–70mm f/2.8D IF-ED
- AF-S NIKKOR 28–300mm f/3.5–5.6G ED VR
- AF Zoom-Micro Nikkor 70–180mm f/4.5–5.6D ED
- Ai AF Micro-Nikkor 200mm f/4D IF-ED



Calculating Angle of View

The size of the area exposed by a 35 mm camera is 36×24 mm. The size of the area exposed by the D7000, in contrast, is 23.6×15.6 mm, meaning that the angle of view of a 35mm camera is approximately 1.5 times that of the D7000. The approximate focal length of lenses for the D7000 in 35 mm format can be calculated by multiplying the focal length of the lens by about 1.5.

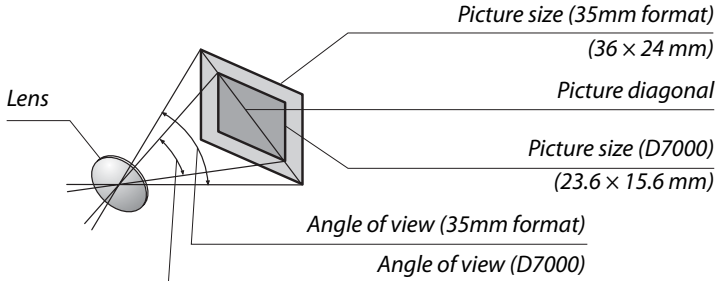

Optional Flash Units (Speedlights)

The camera supports the Nikon Creative Lighting System (CLS) and can be used with CLS-compatible flash units. Optional flash units can be attached directly to the camera accessory shoe as described below. The accessory shoe is equipped with a safety lock for flash units with a locking pin, such as the SB-900, SB-800, SB-700, SB-600, and SB-400.

1 Remove the accessory shoe cover.

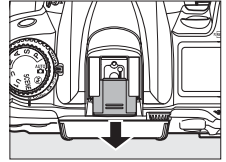

2 Mount the flash unit on the accessory shoe.

See the manual provided with the flash unit for details. The built-in flash will not fire when an optional flash unit is attached.

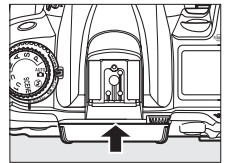

The AS-15 Sync Terminal Adapter

When the AS-15 sync terminal adapter (available separately) is mounted on the camera accessory shoe, flash accessories can be connected via a sync terminal.

Use Only Nikon Flash Accessories

Use only Nikon flash units. Negative voltages or voltages over 250 V applied to the accessory shoe could not only prevent normal operation, but damage the sync circuitry of the camera or flash. Before using a Nikon flash unit not listed in this section, contact a Nikon-authorized service representative for more information.



The Nikon Creative Lighting System (CLS)

Nikon's advanced Creative Lighting System (CLS) offers improved communication between the camera and compatible flash units for improved flash photography.

■ ■ CLS-Compatible Flash Units

The camera can be used with the following CLS-compatible flash units:

- **The SB-900, SB-800, SB-700, SB-600, SB-400, and SB-R200:**

Flash unit		Feature					
		SB-900 ¹	SB-800	SB-700	SB-600	SB-400	SB-R200 ²
Guide No.	ISO 100	34/111	38/125	28/92	30/98	21/69	10/33
No. ³	ISO 200	48/157	53/174	39/128	42/138	30/98	14/46

- 1 If a color filter is attached to the SB-900 when **AUTO** or  (flash) is selected for white balance, the camera will automatically detect the filter and adjust white balance appropriately.
- 2 Controlled remotely with built-in flash in commander mode or using optional SB-900, SB-800, or SB-700 flash unit or SU-800 wireless Speedlight commander.
- 3 m/ft., 20 °C (68 °F), SB-900, SB-800, SB-700, and SB-600 at 35 mm zoom head position; SB-900 and SB-700 with standard illumination.

- **The SU-800 wireless speedlight commander:** When mounted on a CLS-compatible camera, the SU-800 can be used as a commander for remote SB-900, SB-800, SB-700, SB-600, or SB-R200 flash units in up to three groups. The SU-800 itself is not equipped with a flash.

Guide Number

To calculate the range of the flash at full power, divide the Guide Number by the aperture. For example, at ISO 100 the SB-800 has a Guide Number of 38 m or 125 ft. (35 mm zoom head position); its range at an aperture of f/5.6 is $38 \div 5.6$ or about 6.8 meters (or in feet, $125 \div 5.6 =$ approximately 23 ft. 7 in.). For each twofold increase in ISO sensitivity, multiply the Guide Number by the square root of two (approximately 1.4).

The following features are available with CLS-compatible flash units:

Flash mode/feature		Flash unit				Advanced Wireless Lighting						
		SB-900	SB-800	SB-700	SB-600	SB-400	Commander			Remote		
							SB-900	SB-700	SU-800 ¹	SB-900	SB-700	SB-R200
i-TTL	i-TTL balanced fill-flash for digital SLR	✓ ²	✓ ³	✓ ²	✓ ³	✓	✓	✓	✓	✓	✓	
AA	Auto aperture	✓ ⁴	—	—	—	✓ ⁵	—	✓ ⁵	✓ ⁵	—	—	
A	Non-TTL auto	✓ ⁴	—	—	—	✓ ⁵	—	—	✓ ⁵	—	—	
GN	Distance-priority manual	✓	✓	—	—	—	—	—	—	—	—	
M	Manual	✓	✓	✓	✓ ⁶	✓	✓	✓	✓	✓	✓	
RPT	Repeating flash	✓	—	—	—	✓	—	✓	✓	✓	—	
Auto FP	High-Speed Sync ⁷	✓	✓	✓	—	✓	✓	✓	✓	✓	✓	
FV	lock	✓	✓	✓	✓	✓	✓	✓	✓	✓	✓	
AF-assist	for multi-area AF ⁸	✓	✓	✓	—	✓	✓	✓	—	—	—	
Flash Color	Information Communication	✓	✓	✓	✓	✓	✓	—	—	—	—	
REAR	Rear-curtain sync	✓	✓	✓	✓	✓	✓	✓	✓	✓	✓	
	Red-eye reduction	✓	✓	✓	✓	✓	✓	—	—	—	—	
Power	zoom	✓	✓	✓	—	✓	✓	—	—	—	—	

1 Only available when SU-800 is used to control other flash units.

2 Standard i-TTL flash for digital SLR is used with spot metering or when selected with flash unit.

3 Standard i-TTL flash for digital SLR is used with spot metering.

4 Selected with flash unit.

5 Auto aperture (AA) is used regardless of mode selected with flash unit.

6 Can be selected with camera.

7 Select **1/320 s (Auto FP)** or **1/250 s (Auto FP)** for Custom Setting e1 (**Flash sync speed**, □ 222).

8 CPU lens required.

Auto Aperture/Non-TTL Auto

Unless the focal length and maximum aperture are specified using the **Non-CPU lens data** option in the setup menu, choosing auto aperture (AA) when a non-CPU lens is attached automatically selects non-TTL auto (A).



■ Other Flash Units

The following flash units can be used in non-TTL auto and manual modes. If they are set to TTL, the camera shutter-release button will lock and no photographs can be taken.

Flash unit	SB-80DX, SB-28DX, SB-28, SB-26, SB-25, SB-24	SB-50DX ¹	SB-30, SB-27 ² , SB-22S, SB-22, SB-20, SB-16B, SB-15	SB-23, SB-29 ³ , SB-21B ³ , SB-29S ³
A Non-TTL auto	✓	—	✓	—
M Manual	✓	✓	✓	✓
 Repeating flash	✓	—	—	—
REAR Rear-curtain sync ⁴	✓	✓	✓	✓

1 Select mode P, S, A, or M, lower built-in flash, and use optional flash unit only.













2 Flash mode is automatically set to TTL and shutter-release is disabled. Set flash unit to A (non-TTL auto flash).

3 Autofocus is available with AF-S VR Micro-Nikkor 105mm f/2.8G IF-ED and AF-S Micro NIKKOR 60mm f/2.8G ED lenses only.

4 Available when camera is used to select flash mode.

Flash Control Mode

The information display shows the flash control mode for optional flash units attached to the camera accessory shoe as follows:

	Flash sync	Auto FP (FP 222)
i-TTL		
Auto aperture (AA) *		
Non-TTL auto flash (A)		
Distance-priority manual (GN)		
Manual		
Repeating flash		—
Advanced wireless lighting		

* Available with SB-900, and SB-800 only.

Notes on Optional Flash Units

Refer to the Speedlight manual for detailed instructions. If the flash unit supports CLS, refer to the section on CLS-compatible digital SLR cameras. The D7000 is not included in the “digital SLR” category in the SB-80DX, SB-28DX, and SB-50DX manuals.

If an optional flash unit is attached in shooting modes other than $\text{\textcircled{A}}$, the flash will fire with every shot, even in modes in which the built-in flash can not be used.

i-TTL flash control can be used at ISO sensitivities between 100 and 6400. At values over 6400, the desired results may not be achieved at some ranges or aperture settings. If the flash-ready indicator blinks for about three seconds after a photograph is taken, the flash has fired at full power and the photograph may be underexposed.

When an SC-series 17, 28, or 29 sync cable is used for off-camera flash photography, correct exposure may not be achieved in i-TTL mode. We recommend that you choose spot metering to select standard i-TTL flash control. Take a test shot and view the results in the monitor.

In i-TTL, use the flash panel or bounce adapter provided with the flash unit. Do not use other panels such as diffusion panels, as this may produce incorrect exposure.

The SB-900, SB-800, SB-700, SB-600, and SB-400 provide red-eye reduction, while the SB-900, SB-800, SB-700, SB-600, and SU-800 provide AF-assist illumination with the following restrictions:

- **SB-900:** AF-assist illumination is available for all focus points; with 17–135 mm AF lenses, however, autofocus is available only with the focus points shown at right (if other focus points are selected, the AF-assist illuminator may not provide sufficient illumination for autofocus).
- **SB-800, SB-600, and SU-800:** With 24–105 mm AF lenses, AF-assist illumination is available only with the focus points shown at right.
- **SB-700:** AF-assist illumination is available for all focus points; with 24–135 mm AF lenses, however, autofocus is available only with the focus points shown at right (if other focus points are selected, the AF-assist illuminator may not provide sufficient illumination for autofocus).

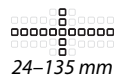
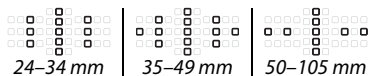
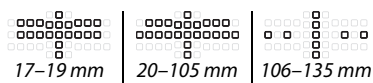

Other Accessories

At the time of writing, the following accessories were available for the D7000.

Power sources	<ul style="list-style-type: none">• Rechargeable Li-ion Battery EN-EL15 (☞ 21–24): Additional EN-EL15 batteries are available from local retailers and Nikon-authorized service representatives.• Battery Charger MH-25 (☞ 21): Recharge EN-EL15 batteries.• Multi-Power Battery Pack MB-D11: The MB-D11 is equipped with a shutter-release button, AE/AF lock button, multi selector, and main- and sub-command dials for improved operation when taking photographs in portrait (tall) orientation. When attaching the MB-D11, remove the camera MB-D11 contact cover.• Power Connector EP-5B, AC Adapter EH-5a: These accessories can be used to power the camera for extended periods (EH-5 AC adapters can also be used). The EP-5B is required to connect the camera to the EH-5a; see page 282 for details. Note that when the camera is used with an MB-D11, the EP-5B must be inserted into the MB-D11, not the camera. Do not attempt to use the camera with power connectors inserted into both the camera and MB-D11.
Wireless LAN adapters	<ul style="list-style-type: none">• Wireless Transmitter WT-4: Connects the camera to wireless and Ethernet networks. The photographs on the camera memory card can be viewed by computers on the same network or copied to a computer for long-term storage (be sure to always use the latest version of the software supplied with the WT-4). The camera can also be controlled from any computer on the network using Camera Control Pro 2 (available separately). Note that the WT-4 requires an independent power source; an EH-6 AC adapter or EN-EL3e battery is recommended. See the WT-4 manual for details.
Filters	<ul style="list-style-type: none">• Filters intended for special-effects photography may interfere with autofocus or the electronic rangefinder.• The D7000 can not be used with linear polarizing filters. Use C-PL or C-PL II circular polarizing filters instead.• NC filters are recommended for protecting the lens.• To prevent ghosting, use of a filter is not recommended when the subject is framed against a bright light, or when a bright light source is in the frame.• Center-weighted metering is recommended with filters with exposure factors (filter factors) over $1 \times$ (Y44, Y48, Y52, O56, R60, X0, X1, C-PL, ND2S, ND4, ND4S, ND8, ND8S, ND400, A2, A12, B2, B8, B12). See the filter manual for details.

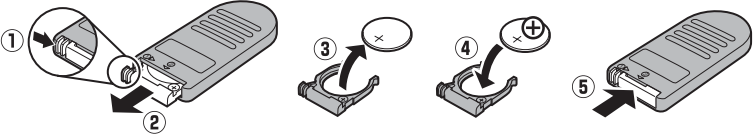
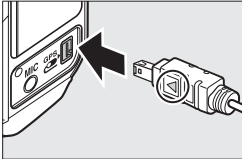

Viewfinder eyepiece accessories	<ul style="list-style-type: none"> • DK-20C Eyepiece Correction Lenses: Lenses are available with diopters of -5, -4, -3, -2, 0, $+0.5$, $+1$, $+2$, and $+3$ m^{-1} when the camera diopter adjustment control is in the neutral position (-1 m^{-1}). Use eyepiece correction lenses only if the desired focus can not be achieved with the built in diopter adjustment control (-3 to $+1$ m^{-1}). Test eyepiece correction lenses before purchase to ensure that the desired focus can be achieved. The rubber eyecup can not be used with eyepiece correction lenses. • Magnifying Eyepiece DK-21M: The DK-21M magnifies the view through the viewfinder by approximately $1.17 \times$ (50 mm f/1.4 lens at infinity; -1.0 m^{-1}) for greater precision when framing. • Magnifier DG-2: The DG-2 magnifies the scene displayed in the center of the viewfinder for greater precision during focusing. Eyepiece adapter required (available separately). • Eyepiece Adapter DK-22: The DK-22 is used when attaching the DG-2 magnifier. • Right-Angle Viewing Attachment DR-6: The DR-6 attaches at a right angle to the viewfinder eyepiece, allowing the image in the viewfinder to be viewed at right angles to the lens (for example, from directly above when the camera is horizontal).
Software	<ul style="list-style-type: none"> • Capture NX 2: A complete photo editing package offering such features as white balance adjustment and color control points. • Camera Control Pro 2: Control the camera remotely from a computer to record movies and photographs and save photographs directly to the computer hard disk. <p>Note: Use the latest versions of Nikon software. Most Nikon software offers an auto update feature when the computer is connected to the Internet. See the websites listed on page xvii for the latest information on supported operating systems.</p>
Body cap	<p>BF-1B and BF-1A Body Caps: The body cap keeps the mirror, viewfinder screen, and low-pass filter free of dust when a lens is not in place.</p>
Remote controls	<p>ML-L3 wireless remote control: Use as a remote shutter release for self-portraits or to prevent blur caused by camera shake. The ML-L3 uses a 3 V CR2025 battery.</p>  <p>Pressing the battery-chamber latch to the right (1), insert a fingernail into the gap and open the battery chamber (2). Ensure that the battery is inserted in the correct orientation (4).</p>
Accessory terminal accessories	<p>The D7000 is equipped with an accessory terminal for MC-DC2 remote cords (□ 73) and GP-1 GPS units (□ 162), which connect with the ◀ mark on the connector aligned with the ▶ next to the accessory terminal (close the camera connector cover when the terminal is not in use).</p> 



Attaching a Power Connector and AC Adapter

Turn the camera off before attaching an optional power connector and AC adapter.

1 Ready the camera.

Open the battery-chamber (1) and power connector (2) covers.

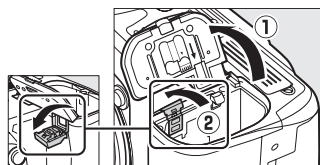

2 Insert the EP-5B power connector.

Be sure to insert the connector in the orientation shown, using the connector to keep the orange battery latch pressed to one side. The latch locks the connector in place when the connector is fully inserted.

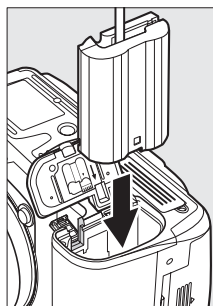

3 Close the battery-chamber cover.

Position the power connector cable so that it passes through the power connector slot and close the battery-chamber cover.

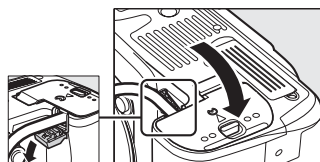

4 Connect the AC adapter.

Connect the AC adapter power cable to the AC socket on AC adapter (3) and the EP-5B power cable to the DC socket (4). A  icon is displayed in the monitor when the camera is powered by the AC adapter and power connector.

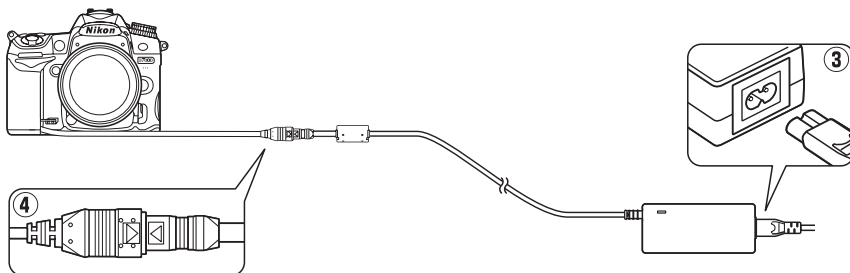

Caring for the Camera

Storage

When the camera will not be used for an extended period, replace the monitor cover, remove the battery, and store the battery in a cool, dry area with the terminal cover in place. To prevent mold or mildew, store the camera in a dry, well-ventilated area. Do not store your camera with naphtha or camphor moth balls or in locations that:

- are poorly ventilated or subject to humidities of over 60%
- are next to equipment that produces strong electromagnetic fields, such as televisions or radios
- are exposed to temperatures above 50 °C (122 °F) or below –10 °C (14 °F)

Cleaning

Camera body	Use a blower to remove dust and lint, then wipe gently with a soft, dry cloth. After using the camera at the beach or seaside, wipe off sand or salt with a cloth lightly dampened in distilled water and dry thoroughly. Important: <i>Dust or other foreign matter inside the camera may cause damage not covered under warranty.</i>
Lens, mirror, and viewfinder	These glass elements are easily damaged. Remove dust and lint with a blower. If using an aerosol blower, keep the can vertical to prevent the discharge of liquid. To remove fingerprints and other stains, apply a small amount of lens cleaner to a soft cloth and clean with care.
Monitor	Remove dust and lint with a blower. When removing fingerprints and other stains, wipe the surface lightly with a soft cloth or chamois leather. Do not apply pressure, as this could result in damage or malfunction.

Do not use alcohol, thinner, or other volatile chemicals.

Servicing the Camera and Accessories

The camera is a precision device and requires regular servicing. Nikon recommends that the camera be inspected by the original retailer or Nikon-authorized service representative once every one to two years, and that it be serviced once every three to five years (note that fees apply to these services). Frequent inspection and servicing are particularly recommended if the camera is used professionally. Any accessories regularly used with the camera, such as lenses or optional Speedlights, should be included when the camera is inspected or serviced.



The Low-Pass Filter

The image sensor that acts as the camera's picture element is fitted with a low-pass filter to prevent moiré. If you suspect that dirt or dust on the filter is appearing in photographs, you can clean the filter using the **Clean image sensor** option in the setup menu. The filter can be cleaned at any time using the **Clean now** option, or cleaning can be performed automatically when the camera is turned on or off.

■ ■ "Clean Now"

1 Place the camera base down.

Image sensor cleaning is most effective when the camera is placed base down as shown at right.

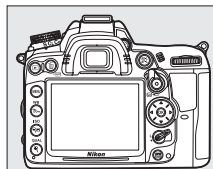

2 Display the Clean image sensor menu.

Press the MENU button to display the menus. Highlight **Clean image sensor** in the setup menu and press ►.

MENU button

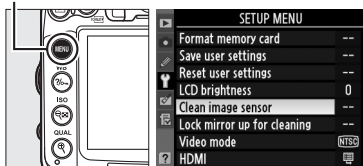

3 Select Clean now.

Highlight **Clean now** and press OK.



The message shown at right will be displayed while cleaning is in progress.

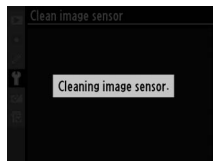



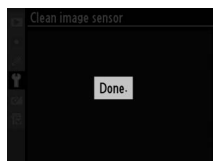

The message shown at right will be displayed when cleaning is in complete.



■ “Clean at Startup/Shutdown”

Choose from the following options:

Option	Description
 Clean at startup	The image sensor is automatically cleaned each time the camera is turned on.
 Clean at shutdown	The image sensor is automatically cleaned during shutdown each time the camera is turned off.
 Clean at startup & shutdown	The image sensor is cleaned automatically at startup and at shutdown.
 Cleaning off	Automatic image sensor cleaning off.

1 Select Clean at startup/shutdown.

Display the **Clean image sensor** menu as described in Step 2 on the previous page. Highlight **Clean at startup/shutdown** and press .

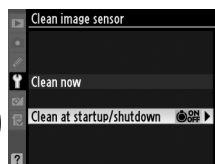

2 Select an option.

Highlight an option and press .

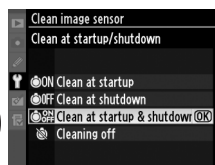



Image Sensor Cleaning

Using camera controls interrupts image sensor cleaning. Image sensor cleaning may not be performed at startup if the flash is charging.

Cleaning is performed by vibrating the low-pass filter. If dust can not be fully removed using the options in the **Clean image sensor** menu, clean the image sensor manually ( 286) or consult a Nikon-authorized service representative.

If image sensor cleaning is performed several times in succession, image sensor cleaning may be temporarily disabled to protect the camera's internal circuitry. Cleaning can be performed again after a short wait.



■ ■ “Manual Cleaning”

If foreign matter can not be removed from the low-pass filter using the **Clean image sensor** option in the setup menu (☐ 284), the filter can be cleaned manually as described below. Note, however, that the filter is extremely delicate and easily damaged. Nikon recommends that the filter be cleaned only by Nikon-authorized service personnel.

1 Charge the battery or connect an AC adapter.

A reliable power source is required when inspecting or cleaning the low-pass filter. Turn the camera off and insert a fully-charged EN-EL15 battery or connect an optional EP-5B power connector and EH-5a AC adapter.

2 Remove the lens.

Turn the camera off and remove the lens.

3 Select **Lock mirror up for cleaning**.

Turn the camera on and press the MENU button to display the menus. Highlight **Lock mirror up for cleaning** in the setup menu and press ► (note that this option is not available at battery levels of  or below).

MENU button

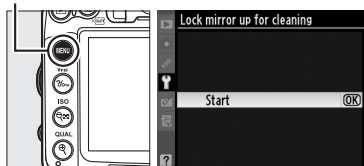

4 Press .

The message shown at right will be displayed in the monitor and a row of dashes will appear in the control panel and viewfinder. To restore normal operation without inspecting the low-pass filter, turn the camera off.

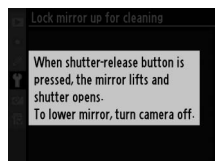

5 Raise the mirror.

Press the shutter-release button all the way down. The mirror will be raised and the shutter curtain will open, revealing the low-pass filter.



6 Examine the low-pass filter.

Holding the camera so that light falls on the low-pass filter, examine the filter for dust or lint. If no foreign objects are present, proceed to Step 8.

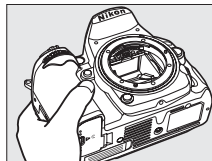

7 Clean the filter.

Remove any dust and lint from the filter with a blower. Do not use a blower-brush, as the bristles could damage the filter. Dirt that can not be removed with a blower can only be removed by Nikon-authorized service personnel. Under no circumstances should you touch or wipe the filter.

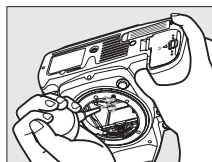

8 Turn the camera off.

The mirror will return to the down position and the shutter curtain will close. Replace the lens or body cap.



Use a Reliable Power Source

The shutter curtain is delicate and easily damaged. If the camera powers off while the mirror is raised, the curtain will close automatically. To prevent damage to the curtain, observe the following precautions:

- Do not turn the camera off or remove or disconnect the power source while the mirror is raised.
- If the battery runs low while the mirror is raised, a beep will sound and the self-timer lamp will blink to warn that the shutter curtain will close and the mirror will be lowered after about two minutes. End cleaning or inspection immediately.

Foreign Matter on the Low-Pass Filter

Nikon takes every possible precaution to prevent foreign matter from coming into contact with the low-pass filter during production and shipping. The D7000, however, is designed to be used with interchangeable lenses, and foreign matter may enter the camera when lenses are removed or exchanged. Once inside the camera, this foreign matter may adhere to the low-pass filter, where it may appear in photographs taken under certain conditions. To protect the camera when no lens is in place, be sure to replace the body cap provided with the camera, being careful to first remove all dust and other foreign matter that may be adhering to the body cap. Avoid exchanging lenses in dusty environments.

Should foreign matter find its way onto the low-pass filter, clean the filter as described above, or have the filter cleaned by authorized Nikon service personnel. Photographs affected by the presence of foreign matter on the filter can be retouched using Capture NX 2 (available separately; □ 281) or the clean image options available in some third-party imaging applications.

Caring for the Camera and Battery: Cautions

Do not drop: The product may malfunction if subjected to strong shocks or vibration.

Keep dry: This product is not waterproof, and may malfunction if immersed in water or exposed to high levels of humidity. Rusting of the internal mechanism can cause irreparable damage.

Avoid sudden changes in temperature: Sudden changes in temperature, such as those that occur when entering or leaving a heated building on a cold day, can cause condensation inside the device. To prevent condensation, place the device in a carrying case or plastic bag before exposing it to sudden changes in temperature.

Keep away from strong magnetic fields: Do not use or store this device in the vicinity of equipment that generates strong electromagnetic radiation or magnetic fields. Strong static charges or the magnetic fields produced by equipment such as radio transmitters could interfere with the monitor, damage data stored on the memory card, or affect the product's internal circuitry.

Do not leave the lens pointed at the sun: Do not leave the lens pointed at the sun or other strong light source for an extended period. Intense light may cause the image sensor to deteriorate or produce a white blur effect in photographs.

Turn the product off before removing or disconnecting the power source: Do not unplug the product or remove the battery while the product is on or while images are being recorded or deleted. Forcibly cutting power in these circumstances could result in loss of data or in damage to product memory or internal circuitry. To prevent an accidental interruption of power, avoid carrying the product from one location to another while the AC adapter is connected.

Cleaning: Keep the lens contacts clean. When cleaning the camera body, use a blower to gently remove dust and lint, then wipe gently with a soft, dry cloth. After using the camera at the beach or seaside, wipe off any sand or salt using a cloth lightly dampened in pure water and then dry the camera thoroughly. In rare instances, static electricity may cause LCDs to light up or go dark. This does not indicate a malfunction, and the display will soon return to normal.

The lens and mirror are easily damaged. Dust and lint should be gently removed with a blower. When using an aerosol blower, keep the can vertical to prevent discharge of liquid. To remove fingerprints and other stains from the lens, apply a small amount of lens cleaner to a soft cloth and wipe the lens carefully.

See "The Low-Pass Filter" (□ 284, 286) for information on cleaning the low-pass filter.

Do not touch the shutter curtain: The shutter curtain is extremely thin and easily damaged. Under no circumstances should you exert pressure on the curtain, poke it with cleaning tools, or subject it to powerful air currents from a blower. These actions could scratch, deform, or tear the curtain.



Storage: To prevent mold or mildew, store the camera in a dry, well-ventilated area. If you are using an AC adapter, unplug the adapter to prevent fire. If the product will not be used for an extended period, remove the battery to prevent leakage and store the camera in a plastic bag containing a desiccant. Do not, however, store the camera case in a plastic bag, as this may cause the material to deteriorate. Note that desiccant gradually loses its capacity to absorb moisture and should be replaced at regular intervals.

To prevent mold or mildew, take the camera out of storage at least once a month. Turn the camera on and release the shutter a few times before putting it away.

Store the battery in a cool, dry place. Replace the terminal cover before putting the battery away.

Notes on the monitor: The monitor may contain a few pixels that are always lit or that do not light. This is common to all TFT LCD monitors and does not indicate a malfunction. Images recorded with the product are unaffected.

Images in the monitor may be difficult to see in a bright light.

Do not apply pressure to the monitor, as this could cause damage or malfunction. Dust or lint on the monitor can be removed with a blower. Stains can be removed by wiping lightly with a soft cloth or chamois leather. Should the monitor break, care should be taken to avoid injury from broken glass and to prevent liquid crystal from the monitor touching the skin or entering the eyes and mouth.

Replace the monitor cover when transporting the camera or leaving it unattended.

Batteries: Batteries may leak or explode if improperly handled. Observe the following precautions when handling batteries:

- Use only batteries approved for use in this equipment.
- Do not expose the battery to flame or excessive heat.
- Keep the battery terminals clean.
- Turn the product off before replacing the battery.
- Remove the battery from the camera or charger when not in use and replace the terminal cover. These devices draw minute amounts of charge even when off and could draw the battery down to the point that it will no longer function. If the battery will not be used for some time, insert it in the camera and run it flat before removing it and storing it in a location with an ambient temperature of 15 to 25 °C (59 to 77 °F; avoid hot or extremely cold locations). Repeat this process at least once every six months.
- The internal temperature of the battery may rise while the battery is in use. Attempting to charge the battery while the internal temperature is elevated will impair battery performance, and the battery may not charge or charge only partially. Wait for the battery to cool before charging.
- Continuing to charge the battery after it is fully charged can impair battery performance.
- A marked drop in the time a fully charged battery retains its charge when used at room temperature indicates that it requires replacement. Purchase a new EN-EL15 battery.



- Charge the battery before use. When taking photographs on important occasions, ready a spare EN-EL15 battery and keep it fully charged. Depending on your location, it may be difficult to purchase replacement batteries on short notice. Note that on cold days, the capacity of batteries tends to decrease. Be sure the battery is fully charged before taking photographs outside in cold weather. Keep a spare battery in a warm place and exchange the two as necessary. Once warmed, a cold battery may recover some of its charge.
- Used batteries are a valuable resource; recycle in accord with local regulations.



Available Settings

The following table lists the settings that can be adjusted in each mode.

										
Storage folder	✓	✓	✓	✓	✓	✓	✓	✓	✓	✓
File naming	✓	✓	✓	✓	✓	✓	✓	✓	✓	✓
Role played by card in Slot 2	✓	✓	✓	✓	✓	✓	✓	✓	✓	✓
Image quality ²	✓	✓	✓	✓	✓	✓	✓	✓	✓	✓
Image size ²	✓	✓	✓	✓	✓	✓	✓	✓	✓	✓
JPEG compression	✓	✓	✓	✓	✓	✓	✓	✓	✓	✓
NEF (RAW) recording	✓	✓	✓	✓	✓	✓	✓	✓	✓	✓
White balance ²	—	—	✓	✓	—	—	—	—	—	—
Set Picture Control	—	—	✓	✓	—	—	—	—	—	—
Auto distortion control	✓	✓	✓	✓	✓	✓	✓	✓	✓	✓
Color space	✓	✓	✓	✓	✓	✓	✓	✓	✓	✓
Active D-Lighting	— ³	— ³	✓ ²	✓ ²	— ³	— ³	— ³	— ³	— ³	—
Long exp. NR	✓	✓	✓	✓	✓	✓	✓	✓	✓	✓
High ISO NR	✓	✓	✓	✓	✓	✓	✓	✓	✓	✓
ISO sensitivity settings ²	✓	✓	✓	✓	✓	✓	✓	✓	✓	✓
Multiple exposure ²	—	—	✓	✓	—	—	—	—	—	—
Movie settings	✓	✓	✓	✓	✓	✓	✓	✓	✓	✓
Interval timer shooting	✓	✓	✓	✓	✓	✓	✓	✓	✓	✓
Remote control mode	✓	✓	✓	✓	✓	✓	✓	✓	✓	✓
AF mode (viewfinder)	✓ ⁴	✓ ⁴	✓	✓	✓ ⁴	✓ ⁴	✓ ⁴	✓ ⁴	✓ ⁴	✓ ⁴
AF-area mode (viewfinder)	✓ ⁴	✓ ⁴	✓	✓	✓ ⁴	✓ ⁴	✓ ⁴	✓ ⁴	✓ ⁴	✓ ⁴
AF mode (Live view/movie)	✓ ⁴	✓ ⁴	✓	✓	✓ ⁴	✓ ⁴	✓ ⁴	✓ ⁴	✓ ⁴	✓ ⁴
AF-area mode (Live view/movie)	✓ ⁴	✓ ⁴	✓	✓	✓ ⁴	✓ ⁴	✓ ⁴	✓ ⁴	✓ ⁴	✓ ⁴
AE lock hold	✓	✓	✓	✓	✓	✓	✓	✓	✓	✓
Flexible program	—	—	✓	—	—	—	—	—	—	—
Metering	—	—	✓	✓	—	—	—	—	—	—
Exposure compensation	—	—	✓	✓	—	—	—	—	—	—
Bracketing	—	—	✓	✓	—	—	—	—	—	—
Flash mode	✓ ⁴	—	✓	✓	✓ ⁴	—	✓ ⁴	—	—	—
Flash compensation	—	—	✓	✓	—	—	—	—	—	—
FV lock	✓	—	✓	✓	✓	—	✓	—	—	—

Shooting menu¹

Other settings²

a1: AF-C priority selection	✓	✓	✓	✓	✓	✓	✓	✓	✓	✓
a2: AF-S priority selection	✓	✓	✓	✓	✓	✓	✓	✓	✓	✓
a3: Focus tracking with lock-on	✓	✓	✓	✓	✓	✓	✓	✓	✓	✓
a4: AF point illumination	✓	✓	✓	✓	✓	✓	✓	✓	✓	✓
a5: Focus point wrap-around	✓	✓	✓	✓	✓	✓	✓	✓	✓	✓
a6: Number of focus points	✓	✓	✓	✓	✓	✓	✓	✓	✓	✓
a7: Built-in AF-assist illuminator	✓	✓	✓	✓	✓	—	—	✓	✓	✓
a8: Live view/movie AF ²	✓ ⁴	✓ ⁴	✓	✓	✓ ⁴	✓ ⁴	✓ ⁴	✓ ⁴	✓ ⁴	✓ ⁴
b1: ISO sensitivity step value	✓	✓	✓	✓	✓	✓	✓	✓	✓	✓
b2: EV steps for exposure cntrl.	✓	✓	✓	✓	✓	✓	✓	✓	✓	✓
b3: Easy exposure compensation	—	—	✓	✓	—	—	—	—	—	—
b4: Center-weighted area	—	—	✓	✓	—	—	—	—	—	—
b5: Fine tune optimal exposure	✓	✓	✓	✓	✓	✓	✓	✓	✓	✓
c1: Shutter-release button AE-L	✓	✓	✓	✓	✓	✓	✓	✓	✓	✓
c2: Auto meter-off delay	✓	✓	✓	✓	✓	✓	✓	✓	✓	✓
c3: Self-timer	✓	✓	✓	✓	✓	✓	✓	✓	✓	✓
c4: Monitor off delay	✓	✓	✓	✓	✓	✓	✓	✓	✓	✓
c5: Remote on duration	✓	✓	✓	✓	✓	✓	✓	✓	✓	✓
d1: Beep	✓	✓	✓	✓	✓	✓	✓	✓	✓	✓
d2: Viewfinder grid display	✓	✓	✓	✓	✓	✓	✓	✓	✓	✓
d3: ISO display and adjustment	✓	✓	✓	✓	✓	✓	✓	✓	✓	✓
d4: Viewfinder warning display	✓	✓	✓	✓	✓	✓	✓	✓	✓	✓
d5: Screen tips	✓	✓	✓	✓	✓	✓	✓	✓	✓	✓
d6: CL mode shooting speed	✓	✓	✓	✓	✓	✓	✓	✓	✓	✓
d7: Max. continuous release	✓	✓	✓	✓	✓	✓	✓	✓	✓	✓
d8: File number sequence	✓	✓	✓	✓	✓	✓	✓	✓	✓	✓
d9: Information display	✓	✓	✓	✓	✓	✓	✓	✓	✓	✓
d10: LCD illumination	✓	✓	✓	✓	✓	✓	✓	✓	✓	✓
d11: Exposure delay mode	✓	✓	✓	✓	✓	✓	✓	✓	✓	✓
d12: Flash warning	—	—	✓	✓	—	—	—	—	—	—
d13: MB-D11 battery type	✓	✓	✓	✓	✓	✓	✓	✓	✓	✓
d14: Battery order	✓	✓	✓	✓	✓	✓	✓	✓	✓	✓

Custom Settings⁵



			P	S, A, M						
e1: Flash sync speed	✓	✓	✓	✓	✓	✓	✓	✓	✓	✓
e2: Flash shutter speed	—	—	✓	✓	—	—	—	—	—	—
e3: Flash cntrl for built-in flash	—	—	✓	✓	—	—	—	—	—	—
e4: Modeling flash	—	—	✓	✓	—	—	—	—	—	—
e5: Auto bracketing set	—	—	✓	✓	—	—	—	—	—	—
e6: Bracketing order	—	—	✓	✓	—	—	—	—	—	—
f1: switch	✓	✓	✓	✓	✓	✓	✓	✓	✓	✓
f2: OK button (shooting mode)	✓	✓	✓	✓	✓	✓	✓	✓	✓	✓
f3: Assign Fn button	✓	✓	✓	✓	✓	✓	✓	✓	✓	✓
f4: Assign preview button	✓	✓	✓	✓	✓	✓	✓	✓	✓	✓
f5: Assign AE-L/AF-L button	✓	✓	✓	✓	✓	✓	✓	✓	✓	✓
f6: Customize command dials	✓	✓	✓	✓	✓	✓	✓	✓	✓	✓
f7: Release button to use dial	✓	✓	✓	✓	✓	✓	✓	✓	✓	✓
f8: Slot empty release lock	✓	✓	✓	✓	✓	✓	✓	✓	✓	✓
f9: Reverse indicators	✓	✓	✓	✓	✓	✓	✓	✓	✓	✓
f10: Assign MB-D11 button	✓	✓	✓	✓	✓	✓	✓	✓	✓	✓

Custom Settings⁵

- 1 Reset with **Reset shooting menu** (□ 202).
- 2 Reset with two-button reset (□ 151).
- 3 Fixed at **Auto**.
- 4 Reset when mode dial is rotated to new setting.
- 5 Reset with **Reset custom settings** (□ 207).

Defaults

The default settings for the options in the camera menus are listed below. For information on two-button resets, see page 151.

■ Playback Menu Defaults

Option	Default	☰
Playback folder	D7000	195
Image review	Off	200
After delete	Show next	200

Option	Default	☰
Rotate tall	Off	200
Slide show		
Frame interval	2 s	201

■ Shooting Menu Defaults ¹

Option	Default	☰
File naming	DSC	204
Role played by card in Slot 2	Overflow	89
Image quality	JPEG normal	85
Image size	Large	88
JPEG compression	Size priority	87
NEF (RAW) recording		
Type	Lossless compressed	87
NEF (RAW) bit depth	14-bit	
White balance	Auto > Normal	117
Fine tuning	Off	119
Choose color temp.	5000 K	122
Set Picture Control	Standard	131
Auto distortion control	Off	205
Color space	sRGB	141
Active D-Lighting	Off	139
Long exp. NR	Off	205

Option	Default	☰
High ISO NR	Normal	205
ISO sensitivity settings		
ISO sensitivity		
P, S, A, M	100	101
Other modes	Auto	
Auto ISO sensitivity control	Off	103
Multiple exposure	Reset ²	152
Movie settings		
Movie quality	1920×1080; 24 fps; high quality	60
Microphone	Auto sensitivity (A)	
Destination	Slot 1	
Manual movie settings	Off	
Interval timer shooting	Reset ³	155
Remote control mode	Delayed remote	80









1 Default settings restored with **Reset shooting menu** (☰ 202).





2 **Reset shooting menu** can not be selected while shooting is in progress.

3 Shooting ends when reset is performed.



■ Custom Settings Menu Defaults *

Option	Default	📖
a1 AF-C priority selection	Release	208
a2 AF-S priority selection	Focus	208
a3 Focus tracking with lock-on	3 (Normal)	209
a4 AF point illumination	Auto	209
a5 Focus point wrap-around	No wrap	209
a6 Number of focus points	39 points	210
a7 Built-in AF-assist illuminator	On	210
a8 Live view/movie AF		
Autofocus mode	Single-servo AF	211
AF-area mode		
     	Wide-area AF	211
 	Normal-area AF	
Other shooting modes	Face-priority AF	
b1 ISO sensitivity step value	1/3 step	211
b2 EV steps for exposure cntrl.	1/3 step	211
b3 Easy exposure compensation	Off	212
b4 Center-weighted area	ø 8 mm	213
b5 Fine tune optimal exposure		
Matrix metering	0	213
Center-weighted metering	0	
Spot metering	0	
c1 Shutter-release button AE-L	Off	213
c2 Auto meter-off delay	6 s	214
c3 Self-timer		
Self-timer delay	10 s	214
Number of shots	0	
Interval between shots	0.5 s	
c4 Monitor off delay		
Playback	10 s	215
Menus	20 s	
Information display	10 s	
Image review	4 s	
Live view	10 min	
c5 Remote on duration	1 min	215

Option	Default	📖
d1 Beep		
Volume	Off	215
Pitch	High	
d2 Viewfinder grid display	Off	216
d3 ISO display and adjustment	Show frame count	216
d4 Viewfinder warning display	On	216
d5 Screen tips	On	216
d6 CL mode shooting speed	3 fps	217
d7 Max. continuous release	100	217
d8 File number sequence	On	218
d9 Information display	Auto	219
d10 LCD illumination	Off	219
d11 Exposure delay mode	Off	219
d12 Flash warning	On	219
d13 MB-D11 battery type	LR6 (AA alkaline)	220
d14 Battery order	Use MB-D11 batteries first	221
e1 Flash sync speed	1/250 s	222
e2 Flash shutter speed	1/60 s	223
e3 Flash cntrl for built-in flash/Optional flash	TTL	223
e4 Modeling flash	On	228
e5 Auto bracketing set	AE & flash	229
e6 Bracketing order	MTR > under > over	229
f1  switch	LCD backlight ()	229
f2 OK button (shooting mode)	Select center focus point	229
f3 Assign Fn button	FV lock	230
f4 Assign preview button	Preview	232
f5 Assign AE-L/AF-L button	AE/AF lock	232
f6 Customize command dials		
Reverse rotation	No	233
Change main/sub	Off	
Aperture setting	Sub-command dial	
Menus and playback	Off	
f7 Release button to use dial	No	234
f8 Slot empty release lock	Enable release	234
f9 Reverse indicators		234
f10 Assign MB-D11  button	AE/AF lock	235

* Default settings restored with **Reset custom settings** (📖 207).

■ ■ Setup Menu Defaults

Option	Default	
Save user settings		
U1	Shooting mode defaults to P	75
U2		
LCD brightness	0	237
Clean image sensor		
Clean at startup/shutdown	Clean at startup & shutdown	284
HDMI		
Output resolution	Auto	194
Device control	On	

Option	Default	
Time zone and date		
Daylight saving time	Off	237
Auto image rotation	On	239
GPS		
Auto meter-off	Enable	162
Use GPS to set camera clock	Yes	
Eye-Fi upload	Enable	247



Exposure Program (Mode P)

The exposure program for mode **P** is shown in the following graph:

— ISO 100; lens with maximum aperture of f/1.4 and minimum aperture of f/16 (e.g., AF-S NIKKOR 50mm f/1.4G)

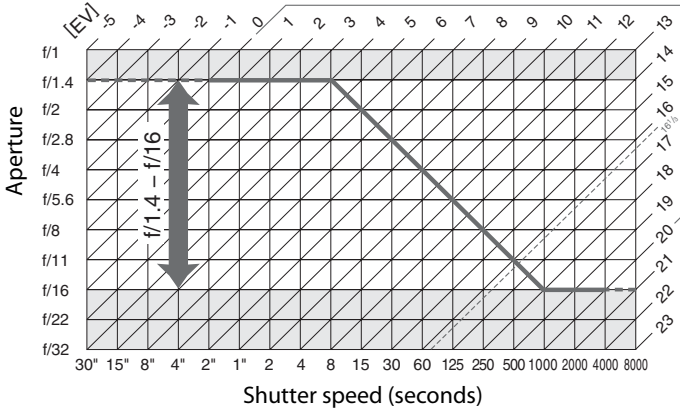

The maximum and minimum values for EV vary with ISO sensitivity; the above graph assumes an ISO sensitivity of ISO 100 equivalent. When matrix metering is used, values over $16^{1/3}$ EV are reduced to $16^{1/3}$ EV.



Troubleshooting

If the camera fails to function as expected, check the list of common problems below before consulting your retailer or Nikon representative.

Display

Viewfinder is out of focus: Adjust viewfinder focus or use optional eyepiece correction lenses (☞ 34, 281).

Viewfinder is dark: Insert a fully-charged battery (☞ 21, 35).

Displays turn off without warning: Choose longer delays for Custom Setting c2 (**Auto meter-off delay**) or c4 (**Monitor off delay**) (☞ 214, 215).

Camera does not respond to controls: See “A Note on Electronically-Controlled Cameras,” below.

Control panel and viewfinder displays are unresponsive and dim: The response times and brightness of these displays vary with temperature.

Fine lines are visible around active focus point or display turns red when focus point is highlighted: These phenomena are normal for this type of viewfinder and do not indicate a malfunction.

A Note on Electronically-Controlled Cameras

In extremely rare instances, unusual characters may appear in the control panel and the camera may stop functioning. In most cases, this phenomenon is caused by a strong external static charge. Turn the camera off, remove and replace the battery, taking care to avoid burns, and turn the camera on again, or, if you are using an AC adapter (available separately), disconnect and reconnect the adapter and turn the camera on again. If the problem persists, contact your retailer or Nikon-authorized service representative.



Shooting (All Modes)

Camera takes time to turn on: Delete files or folders.

Shutter-release disabled:

- Memory card is locked, full, or not inserted (☞ 29, 32).
 - Built-in flash is charging (☞ 39).
 - Camera is not in focus (☞ 38).
 - CPU lens with aperture ring attached but aperture not locked at highest f-number. If **fE E** is displayed in control panel, select **Aperture ring** for Custom Setting f6 (**Customize command dials**) > **Aperture setting** to use lens aperture ring to adjust aperture (☞ 233).
 - Non-CPU lens is attached but camera is not in mode **A** or **M** (☞ 270).
-

No photo taken when remote control shutter-release button is pressed:



- Replace battery in remote control (☞ 281).
 - Choose remote control release mode (☞ 80).
 - Flash is charging (☞ 82).
 - Time selected for Custom Setting c5 (**Remote on duration**, ☞ 215) has elapsed: press camera shutter-release button halfway.
 - Bright light is interfering with remote.
-

Photos are out of focus:

- Rotate focus-mode selector to **AF** (☞ 91).
 - Camera unable to focus using autofocus: use manual focus or focus lock (☞ 97, 99).
-

Focus does not lock when shutter-release button is pressed halfway: Use **AE-L/AF-L** button to lock focus when **AF-C** is selected for focus mode or when photographing moving subjects in **AF-A** mode.

Can not select focus point:

- Unlock focus selector lock (☞ 96).
 -  (auto-area AF) or  (face-priority AF) selected for AF-area mode: choose another mode.
 - Camera is in playback mode (☞ 163) or menus are in use (☞ 195).
 - Press shutter-release button halfway to turn monitor off or activate exposure meters (☞ 39).
-

Subject-tracking AF not available: Select a non-monochrome Picture Control (☞ 131).

Can not select AF-area mode: Manual focus selected (☞ 55, 99).

Only one shot taken each time shutter-release button is pressed in continuous release mode: Lower built-in flash (☞ 143).

Image size can not be changed: **Image quality** set to **NEF (RAW)** (☞ 85).

Camera is slow to record photos: Turn long exposure noise reduction off (☞ 205).

Noise (randomly-spaced bright pixels, fog, or lines) appear in photos:

- Choose lower ISO sensitivity or use high ISO noise reduction (☞ 101, 205).
 - Shutter speed is slower than 1 s: use long exposure noise reduction (☞ 205).
-



AF-assist illuminator does not light:

- AF-assist lamp does not light if **AF-C** is selected for autofocus mode (□ 91) or if continuous-servo autofocus is selected when the camera is in **AF-A** mode. Choose **AF-S**. If an option other than (□) (auto-area AF) is selected for AF-area mode, select center focus point (□ 94, 96).
- The camera is currently in live view or a movie is being recorded.
- **Off** selected for Custom Setting a7 (**Built-in AF-assist illuminator**) (□ 210).
- Illuminator has turned off automatically. Illuminator may become hot with continued use; wait for lamp to cool down.

Beep does not sound:

- **Off** is selected for Custom Setting d1 (**Beep**; □ 215) > **Volume**.
- Camera is in quiet shutter-release mode (□ 77) or movie is being recorded (□ 57).
- Focus-mode selector is set to **M** (□ 99) or **AF-C** is selected for autofocus mode (□ 91).
- **Release** is selected for Custom Setting a2 (**AF-S priority selection**; □ 208).

Smudges appear in photographs: Clean front and rear lens elements. If problem persists, perform image sensor cleaning (□ 284).

Sound is not recorded with movies: **Microphone off** is selected for **Movie settings** > **Microphone**.

The brightness of the image in the monitor differs from the exposure of photographs taken in live view:

- Center-weighted or spot metering is selected (□ 105).
- The camera is in mode **M**.
- The subject is too bright or too dark.
- Active D-Lighting is in effect (□ 139).
- The photograph is a long time-exposure (□ 73).
- The flash is used (□ 143).

Flicker or banding appears during live view or movie recording: Choose an option for **Flicker reduction** that matches the frequency of the local AC power supply (□ 237).

Bright bands appear during live view or movie recording: A flash or other light source with brief duration was used during live view or movie recording.

Menu item can not be selected: Some options are not available in all modes.



Shooting (P, S, A, M)

Shutter-release disabled:

- Non-CPU lens is attached: rotate camera mode dial to **A** or **M** (☐ 270).
- Mode dial rotated to **S** after shutter speed of **bu** **↓** **b** selected in mode **M**: choose new shutter speed (☐ 69).

Camera is slow to respond to shutter-release button: Select **Off** for Custom Setting d11 (**Exposure delay mode**; ☐ 219).

Full range of shutter speeds not available:

- Flash in use. Flash sync speed can be selected using Custom Setting e1 (**Flash sync speed**); when using optional SB-900, SB-800, SB-700, SB-600, or SB-R200 flash unit, choose **1/320 s (Auto FP)** or **1/250 s (Auto FP)** for full range of shutter speeds (☐ 222).
- When **On** is selected for **Movie options > Manual movie settings** in the shooting menu, shutter speed can be set to values between $1/8000$ s and $1/30$ s (☐ 60).

Colors are unnatural:

- Adjust white balance to match light source (☐ 117).
- Adjust **Set Picture Control** settings (☐ 131).

Can not measure white balance: Subject is too dark or too bright (☐ 125).

Image can not be selected as source for preset white balance: Image was not created with D7000 (☐ 126).

White balance bracketing unavailable:

- NEF (RAW) or NEF+JPEG image quality option selected for image quality (☐ 85).
- Multiple exposure mode is in effect (☐ 154).

Effects of Picture Control differ from image to image: **A** (auto) is selected for sharpening, contrast, or saturation. For consistent results over a series of photos, choose another setting (☐ 134).

Metering can not be changed: Autoexposure lock is in effect (☐ 106).

Exposure compensation can not be used: Choose mode **P**, **S**, or **A** (☐ 68, 69, 70).

Noise (reddish areas or other artifacts) appears in long time-exposures: Enable long exposure noise reduction (☐ 205).



Playback

Flashing areas, shooting data, or graphs appear on images: Press ▲ or ▼ to choose photo information displayed, or change settings for **Display mode** (☐ 165, 197).

NEF (RAW) image is not played back: Photo was taken at image quality of NEF + JPEG (☐ 85).

Can not view pictures recorded with other cameras: Pictures recorded with other makes of camera may not be displayed correctly.

Message is displayed stating that no images are available for playback: Select **All** for **Playback folder** (☐ 195).

“Tall” (portrait) orientation photos are displayed in “wide” (landscape) orientation:

- Select **On** for **Rotate tall** (☐ 200).
 - Photo was taken with **Off** selected for **Auto image rotation** (☐ 239).
 - Camera was pointed up or down when photo was taken (☐ 239).
 - Photo is displayed in image review (☐ 200).
-

Can not delete picture:

- Picture is protected: remove protection (☐ 174).
 - Memory card is locked (☐ 33).
-

Can not retouch picture: Photo can not be further edited with this camera (☐ 249).

Can not change print order:

- Memory card is full: delete pictures (☐ 36, 175).
 - Memory card is locked (☐ 33).
-

Can not select photo for printing: Photo is in NEF (RAW) format. Create JPEG copy using **NEF (RAW) processing** or transfer to computer and print using ViewNX 2 (supplied) or Capture NX 2 (available separately).

Picture is not displayed on TV:

- Choose correct video mode (☐ 237) or output resolution (☐ 194).
 - A/V (☐ 191) or HDMI (☐ 193) cable is not correctly connected.
-

Camera does not respond to remote control for HDMI-CEC television:

- Select **On** for **HDMI > Device control** in the setup menu (☐ 194).
 - Adjust HDMI-CEC settings for the television as described in documentation provided with the device.
-

Can not transfer photos to computer: OS not compatible with camera or transfer software. Use card reader to copy photos to computer (☐ 179).

NEF (RAW) photos not displayed in Capture NX 2: Update to latest version (☐ 281).



Image Dust Off option in Capture NX 2 does not have desired effect: Image sensor cleaning changes the position of dust on the low-pass filter. Dust off reference data recorded before image sensor cleaning is performed can not be used with photographs taken after image sensor cleaning is performed. Dust off reference data recorded after image sensor cleaning is performed can not be used with photographs taken before image sensor cleaning is performed (☞ 240).

Computer displays NEF (RAW) images differently from camera: Third-party software does not display effects of Picture Controls or Active D-Lighting. Use ViewNX 2 (supplied) or optional Nikon software such as Capture NX 2 (available separately).

Miscellaneous

Date of recording is not correct: Set camera clock (☞ 27, 237).

Menu item can not be selected: Some options are not available at certain combinations of settings or when no memory card is inserted. Note that **Battery info** option is not available when camera is powered by an optional EP-5B power connector and EH-5a AC adapter (☞ 242).





Error Messages

This section lists the indicators and error messages that appear in the viewfinder, control panel, and monitor.

Indicator		Problem	Solution	📖
Control panel	Viewfinder			
FE E (blinks)		Lens aperture ring is not set to minimum aperture.	Set ring to minimum aperture (largest f-number).	26
		Low battery.	Ready a fully-charged spare battery.	21
 (blinks)	 (blinks)	<ul style="list-style-type: none"> Battery exhausted. Battery can not be used. An extremely exhausted rechargeable Li-ion battery or a third-party battery is inserted either in the camera or in the optional MB-D11 battery pack. 	<ul style="list-style-type: none"> Recharge or replace battery. Contact Nikon-authorized service representative. Replace the battery, or recharge the battery if the rechargeable Li-ion battery is exhausted. 	xvii, 21, 24
 (blinks)	—	Camera clock is not set.	Set camera clock.	27, 237
ΔF		No lens attached, or non-CPU lens attached without specifying maximum aperture. Aperture shown in stops from maximum aperture.	Aperture value will be displayed if maximum aperture is specified.	159
—	● (blinks)	Camera unable to focus using autofocus.	Change composition or focus manually.	93, 99
F - - (blinks)		<ul style="list-style-type: none"> No lens attached. Non-CPU lens attached. 	<ul style="list-style-type: none"> Attach non-IX Nikkor lens. If a CPU lens is attached, remove and reattach the lens. Select mode A or M. 	25, 269 270
Hi		Subject too bright; photo will be overexposed.	<ul style="list-style-type: none"> Use a lower ISO sensitivity In shooting mode: <ul style="list-style-type: none"> P Use optional ND filter S Increase shutter speed A Choose a smaller aperture (larger f-number) 	101 280 69 70



Indicator		Problem	Solution	📖
Control panel	Viewfinder			
	⚡	Subject too dark; photo will be underexposed.	<ul style="list-style-type: none"> Use a higher ISO sensitivity In shooting mode: <ul style="list-style-type: none"> P Use flash S Lower shutter speed A Choose a larger aperture (smaller f-number) 	101 143 69 70
	bulb (blinks)	bulb selected in mode S .	Change shutter speed or select mode M .	69, 71
	-- (blinks)	-- selected in mode S .	Change shutter speed or select mode M .	69, 71
 (blinks)	 (blinks)	Optional flash unit that does not support i-TTL flash control attached and set to TTL.	Change flash mode setting on optional flash unit.	278
—	 (blinks)	If indicator blinks for 3s after flash fires, photo may be underexposed.	Check photo in monitor; if underexposed, adjust settings and try again.	163
FuLL (blinks)	FuL (blinks)	Memory insufficient to record further photos at current settings, or camera has run out of file or folder numbers.	<ul style="list-style-type: none"> Reduce quality or size. Delete photographs. Insert new memory card. 	85, 88 175 29
	Err (blinks)	Camera malfunction.	Release shutter. If error persists or appears frequently, consult Nikon-authorized service representative.	—



Indicator		Problem	Solution	📖
Monitor	Control panel			
No memory card.	(- E -)	Camera cannot detect memory card.	Turn camera off and confirm that card is correctly inserted.	29
This memory card cannot be used. Card may be damaged. Insert another card.	[R r d, E r r] (blinks)	<ul style="list-style-type: none"> • Error accessing memory card. • Unable to create new folder. 	<ul style="list-style-type: none"> • Use Nikon-approved card. • Check that contacts are clean. If card is damaged, contact retailer or Nikon representative. • Delete files or insert new memory card. 	319 — 29, 175
	[R r d, E r r] (blinks)	Camera can not control Eye-Fi card.	<ul style="list-style-type: none"> • Check that Eye-Fi card firmware is up to date. • Copy files on Eye-Fi card to a computer or other device and format card, or insert new card. 	247 29, 32, 179
Memory card is locked. Slide lock to “write” position.	[R r d, - - -] (blinks)	Memory card is locked (write protected).	Slide card write-protect switch to “write” position.	33
Not available if Eye-Fi card is locked.	[R r d, E r r] (blinks)	Eye-Fi card is locked (write protected).		
This card is not formatted. Format the card.	[F o r] (blinks)	Memory card has not been formatted for use in camera.	Format memory card or insert new memory card.	29, 32
Failed to update flash unit firmware. Flash cannot be used. Contact a Nikon-authorized service representative.	—	Firmware for flash unit mounted on camera was not updated correctly.	Contact a Nikon-authorized service representative.	—



Indicator		Problem	Solution	📖
Monitor	Control panel			
Folder contains no images.	—	No images on memory card or in folder(s) selected for playback.	Select folder containing images from Playback folder menu or insert different memory card.	29, 195
All images are hidden.	—	All photos in current folder are hidden.	No images can be played back until another folder has been selected or Hide image used to allow at least one image to be displayed.	196
Cannot display this file.	—	File has been created or modified using a computer or different make of camera, or file is corrupt.	File can not be played back on camera.	—
Cannot select this file.	—	Selected image can not be retouched.	Images created with other devices can not be retouched.	249
This movie cannot be edited.	—	The selected movie can not be edited.	<ul style="list-style-type: none"> • Movies created with other devices can not be edited. • Movies must be at least two seconds long. 	— 65
Check printer.	—	Printer error.	Check printer. To resume, select Continue (if available).	182 *
Check paper.	—	Paper in printer is not of selected size.	Insert paper of correct size and select Continue .	182 *
Paper jam.	—	Paper is jammed in printer.	Clear jam and select Continue .	182 *
Out of paper.	—	Printer is out of paper.	Insert paper of selected size and select Continue .	182 *
Check ink supply.	—	Ink error.	Check ink. To resume, select Continue .	182 *
Out of ink.	—	Printer is out of ink.	Replace ink and select Continue .	182 *

* See printer manual for more information.



Specifications

■ Nikon D7000 Digital Camera

Type	
Type	Single-lens reflex digital camera
Lens mount	Nikon F mount (with AF coupling and AF contacts)
Effective angle of view	Approx. $1.5 \times$ lens focal length (Nikon DX format)
Effective pixels	
Effective pixels	16.2 million
Image sensor	
Image sensor	23.6 \times 15.6 mm CMOS sensor
Total pixels	16.9 million
Dust-reduction System	Image sensor cleaning, Image Dust Off reference data (optional Capture NX 2 software required)
Storage	
Image size (pixels)	<ul style="list-style-type: none"> • 4,928 \times 3,264 (L) • 2,464 \times 1,632 (S) • 3,696 \times 2,448 (M)
File format	<ul style="list-style-type: none"> • NEF (RAW): 12 or 14 bit, lossless compressed or compressed • JPEG: JPEG-Baseline compliant with fine (approx. 1 : 4), normal (approx. 1 : 8), or basic (approx. 1 : 16) compression (Size priority); Optimal quality compression available • NEF (RAW)+JPEG: Single photograph recorded in both NEF (RAW) and JPEG formats
Picture Control System	Standard, Neutral, Vivid, Monochrome, Portrait, Landscape; selected Picture Control can be modified; storage for custom Picture Controls
Media	SD (Secure Digital), SDHC, and SDXC memory cards
Double slot	Slot 2 can be used for overflow or backup storage or for separate storage of copies created using NEF+JPEG; pictures can be copied between cards.
File system	DCF (Design Rule for Camera File System) 2.0, DPOF (Digital Print Order Format), Exif 2.3 (Exchangeable Image File Format for Digital Still Cameras), PictBridge
Viewfinder	
Viewfinder	Eye-level pentaprism single-lens reflex viewfinder
Frame coverage	Approx. 100% horizontal and 100% vertical
Magnification	Approx. $0.94 \times$ (50 mm f/1.4 lens at infinity, -1.0 m^{-1})
Eye point	19.5 mm (-1.0 m^{-1})
Diopter adjustment	-3 – $+1 \text{ m}^{-1}$
Focusing screen	Type B BriteView Clear Matte Mark II screen with AF area brackets (framing grid can be displayed)
Reflex mirror	Quick return
Depth-of-field preview	Pressing depth-of-field preview button stops lens aperture down to value selected by user (A and M modes) or by camera (other modes)
Lens aperture	Instant return, electronically controlled























Lens	
Compatible lenses	<ul style="list-style-type: none"> • DX AF NIKKOR: All functions supported • Type G or D AF NIKKOR: All functions supported (PC Micro-NIKKOR does not support some functions). IX NIKKOR lenses not supported. • Other AF NIKKOR: All functions supported except 3D color matrix metering II. Lenses for F3AF not supported. • AI-P NIKKOR: All functions supported except 3D color matrix metering II • Non-CPU: Can be used in modes A and M; color matrix metering and aperture value display supported if user provides lens data (AI lenses only) <p>Electronic rangefinder can be used if maximum aperture is f/5.6 or faster.</p>
Shutter	
Type	Electronically-controlled vertical-travel focal-plane shutter
Speed	$1/8000$ – 30 s in steps of $1/3$ or $1/2$ EV, bulb, time (requires optional ML-L3 remote control), X250
Flash sync speed	$X = 1/250$ s; synchronizes with shutter at $1/320$ s or slower (flash range drops at speeds between $1/250$ and $1/320$ s)
Release	
Release mode	S (single frame), CL (continuous low speed), CH (continuous high speed), Q (quiet shutter-release), \odot (self-timer), \blacksquare (remote control), MUP (mirror up)
Frame advance rate (CIPA guidelines)	1–5 fps (CL) or 6 fps (CH)
Self-timer	2 s, 5 s, 10 s, 20 s; 1–9 exposures at intervals of 0.5, 1, 2, or 3 s
Remote release modes	Delayed remote, quick-response remote, remote mirror-up
Exposure	
Metering	TTL exposure metering using 2,016-pixel RGB sensor
Metering method	<ul style="list-style-type: none"> • Matrix: 3D color matrix metering II (type G and D lenses); color matrix metering II (other CPU lenses); color matrix metering available with non-CPU lenses if user provides lens data • Center-weighted: Weight of 75% given to 8 mm circle in center of frame. Diameter of circle can be changed to 6, 10, or 13 mm, or weighting can be based on average of entire frame (fixed at 8 mm when non-CPU lens is used) • Spot: Meters 3.5 mm circle (about 2.5% of frame) centered on selected focus point (on center focus point when non-CPU lens is used)
Range (ISO 100, f/1.4 lens, 20 °C/68 °F)	<ul style="list-style-type: none"> • Matrix or center-weighted metering: 0–20 EV • Spot metering: 2–20 EV
Exposure meter coupling	Combined CPU and AI



Exposure	
Mode	Auto (AUTO auto; auto (flash off)); scene (portrait; landscape; child; sports; close up; night portrait; night landscape; party/indoor; beach/snow; sunset; dusk/dawn; pet portrait; candlelight; blossom; autumn colors; food; silhouette; high key; low key); programmed auto with flexible program (P); shutter-priority auto (S); aperture-priority auto (A); manual (M); U1 (user settings 1); U2 (user settings 2)
Exposure compensation	-5 – +5 EV in increments of 1/3 or 1/2 EV
Exposure bracketing	2–3 frames in steps of 1/3, 1/2, 2/3, 1, or 2 EV
Flash bracketing	2–3 frames in steps of 1/3, 1/2, 2/3, 1, or 2 EV
White balance bracketing	2–3 frames in steps of 1, 2, or 3
ADL bracketing	2 frames using selected value for one frame or 3 frames using preset values for all frames
Exposure lock	Luminosity locked at detected value with AE-L/AF-L button
ISO sensitivity (Recommended Exposure Index)	ISO 100 – 6400 in steps of 1/3 or 1/2 EV. Can also be set to approx. 0.3, 0.5, 0.7, 1, or 2 EV (ISO 25600 equivalent) above ISO 6400; auto ISO sensitivity control available
Active D-Lighting	Auto, Extra high, High, Normal, Low, Off
Focus	
Autofocus	Nikon Multi-CAM 4800DX autofocus sensor module with TTL phase detection, fine-tuning, 39 focus points (including 9 cross-type sensors), and AF-assist illuminator (range approx. 0.5–3 m/1 ft. 8 in.–9 ft. 10 in.)
Detection range	-1 – +19 EV (ISO 100, 20 °C/68 °F)
Lens servo	<ul style="list-style-type: none"> • Autofocus (AF): Single-servo AF (AF-S); continuous-servo AF (AF-C); auto AF-S/AF-C selection (AF-A); predictive focus tracking activated automatically according to subject status • Manual focus (M): Electronic rangefinder can be used
Focus point	Can be selected from 39 or 11 focus points
AF-area mode	Single-point AF; 9-, 21-, or 39-point dynamic-area AF, 3D-tracking, auto-area AF
Focus lock	Focus can be locked by pressing shutter-release button halfway (single-servo AF) or by pressing AE-L/AF-L button



Flash	
Built-in flash	       : Auto flash with auto pop-up P, S, A, M, 11 : Manual pop-up with button release
Guide Number	Approx. 12/39, 12/39 with manual flash (m/ft, ISO 100, 20 °C/68 °F)
Flash control	<ul style="list-style-type: none"> • TTL: i-TTL balanced fill-flash and standard i-TTL flash for digital SLR using 2,016-pixel RGB sensor are available with built-in flash and SB-900, SB-800, SB-700, SB-600, or SB-400 (i-TTL balanced fill-flash is available when matrix or center-weighted metering is selected) • Auto aperture: Available with SB-900/SB-800 and CPU lens • Non-TTL auto: Supported flash units include SB-900, SB-800, SB-28, SB-27, and SB-22S • Distance-priority manual: Available with SB-900, SB-800, SB-700
Flash mode	<ul style="list-style-type: none"> •      : Auto, auto with red-eye reduction, off; fill-flash and red-eye reduction available with optional flash units • : Auto slow sync, auto slow sync with red-eye reduction, off; slow sync and slow sync with red-eye reduction available with optional flash units •      : Fill-flash and red-eye reduction available with optional flash units • 11: Fill-flash • P, A: Fill-flash, rear-curtain with slow sync, slow sync, slow sync with red-eye reduction, red-eye reduction • S, M: Fill-flash, rear-curtain sync, red-eye reduction
Flash compensation	-3 – +1 EV in increments of $\frac{1}{3}$ or $\frac{1}{2}$ EV
Flash-ready indicator	Lights when built-in flash or optional flash unit such as SB-900, SB-800, SB-700, SB-600, or SB-400 is fully charged; blinks for 3 s after flash is fired at full output
Accessory shoe	ISO 518 hot-shoe with sync and data contacts and safety lock
Nikon Creative Lighting System (CLS)	Advanced Wireless Lighting supported with built-in flash, SB-900, SB-800, SB-700, or SU-800 as commander and SB-900, SB-800, SB-700, SB-600, or SB-R200 as remotes; Auto FP high-speed sync and modeling illumination supported with all CLS-compatible flash units except SB-400; Flash Color Information Communication and FV lock supported with all CLS-compatible flash units
Sync terminal	AS-15 sync terminal adapter (available separately)
White balance	
White balance	Auto (2 types), incandescent, fluorescent (7 types), direct sunlight, flash, cloudy, shade, preset manual (up to 5 values can be stored), choose color temperature (2500 K–10000 K), all with fine tuning

Live view		
Lens servo	<ul style="list-style-type: none"> • Autofocus (AF): Single-servo AF (AF-S); full-time servo AF (AF-F) • Manual focus (M) 	
AF-area mode	Face-priority AF, wide-area AF, normal-area AF, subject-tracking AF	
Autofocus	Contrast-detect AF anywhere in frame (camera selects focus point automatically when face-priority AF or subject-tracking AF is selected)	
Movie		
Metering	TTL exposure metering using main image sensor	
Metering method	Matrix	
Frame size (pixels) and frame rate	NTSC	<ul style="list-style-type: none"> • 1,920 × 1,080 (24p); 24 (23.976) fps • 1,280 × 720 (24p); 24 (23.976) fps • 1,280 × 720 (30p); 30 (29.97) fps • 640 × 424 (30p); 30 (29.97) fps
	PAL	<ul style="list-style-type: none"> • 1,920 × 1,080 (24p); 24 (23.976) fps • 1,280 × 720 (25p); 25 fps • 1,280 × 720 (24p); 24 (23.976) fps • 640 × 424 (25p); 25 fps
Choice of normal and high quality available.		
Maximum length	Approx. 20 minutes	
File format	MOV	
Video compression	H.264/MPEG-4 Advanced Video Coding	
Audio recording format	Linear PCM	
Audio recording device	Built-in monaural or external stereo microphone; sensitivity adjustable	
Monitor		
Monitor	7.5-cm/3-in., 921k-dot (VGA), low-temperature polysilicon TFT LCD with 170 ° viewing angle, 100% frame coverage, and brightness adjustment	
Playback		
Playback	Full-frame and thumbnail (4, 9, or 72 images or calendar) playback with playback zoom, movie playback, slide show, highlights, histogram display, auto image rotation, and image comment (up to 36 characters)	
Interface		
USB	Hi-Speed USB	
Video output	NTSC, PAL; images can be displayed on external device while camera monitor is on	
HDMI output	Type C mini-pin HDMI connector; camera monitor turns off when HDMI cable is connected	
Accessory terminal	Remote cord: MC-DC2 (available separately) GPS unit: GP-1 (available separately)	
Audio input	Stereo mini-pin jack (3.5 mm diameter)	
Supported languages		
Supported languages	Arabic, Chinese (Simplified and Traditional), Czech, Danish, Dutch, English, Finnish, French, German, Indonesian, Italian, Japanese, Korean, Norwegian, Polish, Portuguese, Russian, Spanish, Swedish, Thai, Turkish	



Power source	
Battery	One rechargeable Li-ion EN-EL15 battery
Battery pack	Optional MB-D11 multi-power battery pack with one rechargeable Nikon EN-EL15 Li-ion battery or six AA alkaline, NiMH, or lithium batteries
AC adapter	EH-5a AC adapter; requires EP-5B power connector (available separately)
Tripod socket	
Tripod socket	1/4 in. (ISO 1222)
Dimensions/weight	
Dimensions (W × H × D)	Approx. 132 × 105 × 77 mm (5.2 × 4.1 × 3 in.)
Weight	Approx. 780 g (1 lb. 11.5 oz.) with battery and memory card but without body cap; approx. 690 g (1 lb. 8.3 oz.; camera body only)
Operating environment	
Temperature	0–40 °C (+32–104 °F)
Humidity	Less than 85% (no condensation)

- Unless otherwise stated, all figures are for a camera with a fully-charged battery operating at an ambient temperature of 20 °C (68 °F).
- Nikon reserves the right to change the specifications of the hardware and software described in this manual at any time and without prior notice. Nikon will not be held liable for damages that may result from any mistakes that this manual may contain.



MH-25 battery charger	
Rated input (in North America)	AC 120 V, 60 Hz, 0.2 A
Rated input (in other regions)	AC 100–240 V, 50/60 Hz, 0.23–0.12 A
Rated output	DC 8.4 V/1.2 A
Supported batteries	Nikon rechargeable Li-ion battery EN-EL15
Charging time	Approx. 2 hours 35 minutes at an ambient temperature of 25 °C (77 °F) when no charge remains
Operating temperature	0–40 °C (+32–104 °F)
Dimensions (W × H × D)	Approx. 91.5 × 33.5 × 71 mm (3.6 × 1.3 × 2.8 in.), excluding projections
Length of power cable	Approx. 1.8 m (6 ft.)
Weight	Approx. 110 g (3.9 oz.), excluding power cable and AC wall adapter
EN-EL15 rechargeable Li-ion battery	
Type	Rechargeable lithium-ion battery
Rated capacity	7.0 V/1900 mAh
Dimensions (W × H × D)	Approx. 40 × 56 × 20.5 mm (1.6 × 2.2 × 0.8 in.)
Weight	Approx. 88 g (3.1 oz.), excluding terminal cover
AF-S DX NIKKOR 18–105 mm f/3.5–5.6G ED VR lens	
Type	Type G AF-S DX NIKKOR zoom lens with built-in CPU and F mount for use exclusively with Nikon DX-format digital SLR cameras
Focal length	18–105 mm
Maximum aperture	f/3.5–5.6
Lens construction	15 elements in 11 groups (including 1 aspherical element and 1 ED glass element)
Angle of view	76°–15° 20′
Focal length scale	Graduated in millimeters (18, 24, 35, 50, 70, 105)
Distance information	Output to camera
Zoom	Manual zoom using independent zoom ring
Focusing	Nikon Internal Focusing (IF) system with autofocus controlled by Silent Wave Motor; manual focus supported when A-M switch is set to A or M . Focus can be adjusted by rotating lens focus ring while focus is locked in single-servo autofocus. Do not use focus ring while camera is focusing.
Vibration reduction	Lens-shift method using voice coil motors (VCMs)
Minimum focus distance	0.45 m (1.5 ft.) from focal plane mark (□ 100) at all zoom positions
Diaphragm blades	7 (rounded diaphragm opening)
Diaphragm	Fully automatic
Aperture range	<ul style="list-style-type: none"> • 18 mm focal length: f/3.5–22 <li style="margin-left: 100px;">• 105 mm focal length: f/5.6–38
Metering	Full aperture
Filter-attachment size	67 mm (P=0.75 mm)
Dimensions	Approx. 76 mm diameter × 89 mm/3.0 × 3.5 in. (distance from camera lens-mount flange)
Weight	Approx. 420 g (14.8 oz.)

Nikon reserves the right to change the specifications of the hardware and software described in this manual at any time and without prior notice. Nikon will not be held liable for damages that may result from any mistakes that this manual may contain.



■ The AF-S DX NIKKOR 18–105 mm f/3.5–5.6G ED VR

The AF-S DX NIKKOR 18–105 mm f/3.5–5.6G ED VR is for use exclusively with Nikon DX format digital cameras. Superior optical performance and image rendering are ensured by the use of aspherical lens elements and elements made using extra-low dispersion (ED) glass to correct chromatic aberration. A rounded aperture produces soft, esthetically-pleasing blurring of point light sources in out-of-focus areas of the image (*bokeh*). If the camera is equipped with an AF-ON button, vibration reduction will not be activated when the AF-ON button is pressed.

Using the Built-in Flash

When using the built-in flash, be sure the subject is at a range of at least 0.6 m (2 ft.) and remove lens hoods to prevent vignetting (shadows created where the end of the lens obscures the built-in flash).

Camera	Zoom position	Minimum distance without vignetting
D5000, D3100, D3000	18 mm	2.5 m/ 8 ft. 2 in.
	24 mm	1.0 m/ 3 ft. 3 in.
D700, D7000, D300 series, D200, D100, D80	All	No vignetting at any focus distance
D90, D70 series	18 mm	1.5 m/ 4 ft. 11 in.
	24 mm	No vignetting at any focus distance
D50	18 mm	1.0 m/ 3 ft. 3 in.
	24 mm	No vignetting at any focus distance
D60, D40 series	18 mm	2.5 m/ 8 ft. 2 in.
	24 mm	1.0 m/ 3 ft. 3 in.
	35 mm	No vignetting at any focus distance

Because the built-in flash units for the D100 and D70 can only cover the angle of view of a lens with a focal of 20 mm or more; vignetting will occur at a focal length of 18 mm.

Lens Care

- Keep the CPU contacts clean.
- Use a blower to remove dust and lint from the lens surfaces. To remove smudges and fingerprints, apply a small amount of ethanol or lens cleaner to a soft, clean cotton cloth or lens-cleaning tissue and clean from the center outwards using a circular motion, taking care not to leave smears or touch the glass with your fingers.
- Never use organic solvents such as paint thinner or benzene to clean the lens.
- The lens hood or NC filters can be used to protect the front lens element.
- Attach the front and rear caps before placing the lens in its flexible pouch.
- When a lens hood is attached, do not pick up or hold the lens or camera using only the hood.
- If the lens will not be used for an extended period, store it in a cool, dry location to prevent mold and rust. Do not store in direct sunlight or with naphtha or camphor moth balls.
- Keep the lens dry. Rusting of the internal mechanism can cause irreparable damage.
- Leaving the lens in extremely hot locations could damage or warp parts made from reinforced plastic.

Supplied Accessories

- 67 mm Snap-on Front Lens Cap LC-67
- Rear Lens Cap
- Flexible Lens Pouch CL-1018
- Bayonet Hood HB-32 (attaches as shown at right)

Optional Accessories

- 67 mm screw-on filters
- Rear Lens Cap LF-1 or Rear Lens Cap LF-4

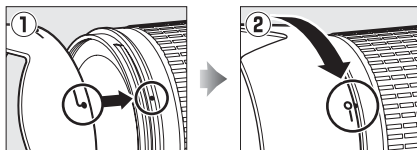
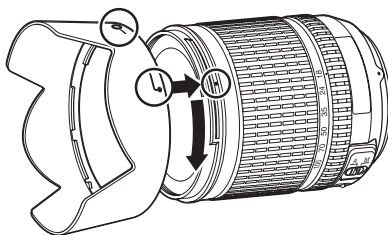

A Note on Wide-Angle Lenses

Autofocus may not provide the desired results with wide- and super-wide-angle lenses in the following situations:

1 The subject does not fill the focus point.

If the subject does not fill the focus point, the camera may focus on the background and the subject may be out of focus.

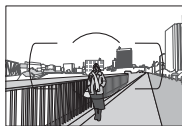

Example: A far-off portrait subject at some distance from the background

2 The subject contains many fine details.

The camera may have difficulty focusing on subjects that contain many fine details or that are lacking in contrast.

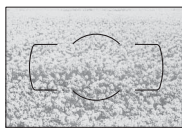

Example: A field of flowers

In these cases, use manual focus, or use focus lock to focus on another subject at the same distance and then recompose the photograph. For more information, see “Getting Good Results with Autofocus” (📖 93).



■ ■ **Supported Standards**

- **DCF Version 2.0:** The Design Rule for Camera File Systems (DCF) is a standard widely used in the digital camera industry to ensure compatibility among different makes of camera.
- **DPOF:** Digital Print Order Format (DPOF) is an industry-wide standard that allows pictures to be printed from print orders stored on the memory card.
- **Exif version 2.3:** The D7000 supports Exif (Exchangeable Image File Format for Digital Still Cameras) version 2.3, a standard in which information stored with photographs is used for optimal color reproduction when the images are output on Exif-compliant printers.
- **PictBridge:** A standard developed through cooperation with the digital camera and printer industries, allowing photographs to be output directly to a printer without first transferring them to a computer.
- **HDMI: High-Definition Multimedia Interface** is a standard for multimedia interfaces used in consumer electronics and AV devices capable of transmitting audiovisual data and control signals to HDMI-compliant devices via a single cable connection.

Trademark Information

Macintosh, Mac OS, and QuickTime are registered trademarks of Apple Inc. in the United States and/or other countries. Microsoft, Windows, and Windows Vista are either registered trademarks, or trademarks of Microsoft Corporation in the United States and/or other countries. PictBridge is a trademark. The SD, SDHC, and SDXC logos are trademarks of the SD-3C, LLC. HDMI, the HDMI logo and High-Definition Multimedia Interface are trademarks or registered trademarks of HDMI Licensing LLC.

HDMI

All other trade names mentioned in this manual or the other documentation provided with your Nikon product are trademarks or registered trademarks of their respective holders.



Approved Memory Cards

The following SD memory cards have been tested and approved for use in the D7000. Cards with class 6 or faster write speeds are recommended for movie recording. Recording may end unexpectedly when cards with slower write speeds are used.

	SD memory cards	SDHC memory cards ²	SDXC memory cards ³
SanDisk	1 GB, 2 GB ¹	4 GB, 8 GB, 16 GB, 32 GB	64 GB
Toshiba		4 GB, 8 GB, 16 GB, 32 GB	
Panasonic		4 GB, 6 GB, 8 GB, 12 GB, 16 GB, 32 GB	48 GB, 64 GB
Lexar Media		4 GB, 8 GB	—
Platinum II		4 GB, 8 GB, 16 GB, 32 GB	
Professional		4 GB, 8 GB, 16 GB, 32 GB	

1 Check that any card readers or other devices with which the card will be used support 2 GB cards.

2 Check that any card readers or other devices with which the card will be used are SDHC-compliant. The camera supports UHS-I.

3 Check that any card readers or other devices with which the card will be used are SDXC-compliant. The camera supports UHS-I.



Other cards have not been tested. For more details on the above cards, please contact the manufacturer.



Memory Card Capacity

The following table shows the approximate number of pictures that can be stored on a 8 GB SanDisk Extreme SDHC card at different image quality and size settings.

Image quality	Image size	File size ¹	No. of images ¹	Buffer capacity ²
NEF (RAW), Lossless compressed, 12-bit	—	15.5 MB	291	11
NEF (RAW), Lossless compressed, 14-bit	—	19.4 MB	223	10
NEF (RAW), Compressed, 12-bit	—	13.6 MB	398	15
NEF (RAW), Compressed, 14-bit	—	16.7 MB	330	12
JPEG fine ³	L	7.8 MB	813	31
	M	4.4 MB	1400	100
	S	2.0 MB	3100	100
JPEG normal ³	L	3.9 MB	1600	100
	M	2.2 MB	2800	100
	S	1.0 MB	6000	100
JPEG basic ³	L	2.0 MB	3100	100
	M	1.1 MB	5500	100
	S	0.5 MB	11000	100

1 All figures are approximate. File size varies with scene recorded.

2 Maximum number of exposures that can be stored in memory buffer at ISO 100. Drops if **Optimal quality** is selected for **JPEG compression** or long exposure noise reduction or auto distortion control is on.

3 Figures assume **JPEG compression** is set to **Size priority**. Selecting **Optimal quality** increases the file size of JPEG images; number of images and buffer capacity drop accordingly.

d7—Max. Continuous Release (📖 217)

The maximum number of photographs that can be taken in a single burst can be set to any amount between 1 and 100.



Battery Life

The number of shots that can be taken with fully-charged batteries varies with the condition of the battery, temperature, and how the camera is used. In the case of AA batteries, capacity also varies with make and storage conditions; some batteries can not be used. Sample figures for the camera and optional MB-D11 multi-power battery pack are given below.

- **CIPA standard**¹

One EN-EL15 battery (camera): Approximately 1050 shots

One EN-EL15 battery (MB-D11): Approximately 1050 shots

Six AA batteries (MB-D11): Approximately 650 shots

Two EN-EL15 batteries (one in camera and one in MB-D11): Approximately 2100 shots

- **Nikon standard**²

One EN-EL15 battery (camera): Approximately 4500 shots

One EN-EL15 battery (MB-D11): Approximately 4500 shots

Six AA batteries (MB-D11): Approximately 1700 shots

Two EN-EL15 batteries (one in camera and one in MB-D11): Approximately 9000 shots

1 Measured at 23 °C/73.4 °F (±2 °C/3.6 °F) with an AF-S DX NIKKOR 18–105 mm f/3.5–5.6G ED VR lens under the following test conditions: lens cycled from infinity to minimum range and one photograph taken at default settings once every 30 s; flash fired once every other shot. Live view not used.

2 Measured at 20 °C/68 °F with an AF-S NIKKOR 70–200mm f/2.8G ED VR II lens under the following test conditions: image quality set to JPEG basic, image size set to **M** (medium), shutter speed $1/250$ s, shutter-release button pressed halfway for three seconds and focus cycled from infinity to minimum range three times; six shots are then taken in succession and monitor turned on for five seconds and then turned off; cycle repeated once exposure meters have turned off.

The following can reduce battery life:

- Using the monitor
- Keeping the shutter-release button pressed halfway
- Repeated autofocus operations
- Taking NEF (RAW) photographs
- Slow shutter speeds
- Using the optional WT-4 wireless transmitter
- Using a GP-1 GPS unit
- Using VR (vibration reduction) mode with VR lenses

To ensure that you get the most from rechargeable Nikon EN-EL15 batteries:

- Keep the battery contacts clean. Soiled contacts can reduce battery performance.
- Use batteries immediately after charging. Batteries will lose their charge if left unused.



Index

Symbols

S (Single frame)	7, 77
CL (Continuous low speed)	7, 77, 78, 217
CH (Continuous high speed).....	7, 77, 78
Q (Quiet shutter-release).....	7, 77
⌚ (Self-timer).....	7, 77, 80
📡 (Remote control).....	7, 77, 80
MUP (Mirror up).....	7, 77, 83
📷 (Auto mode).....	35, 36
📷 (Auto (flash off) mode)	35, 36
SCENE (Scene).....	40
👤 (Portrait)	41
🏞️ (Landscape).....	41
👶 (Child).....	41
🏊 (Sports).....	41
👉 (Close up)	42
🌃 (Night Portrait).....	42
🌃 (Night Landscape)	42
🎉 (Party/Indoor)	42
🏖️ (Beach/Snow)	43
🌅 (Sunset).....	43
🌄 (Dusk/Dawn).....	43
🐾 (Pet Portrait).....	43
🕯️ (Candlelight).....	44
🌸 (Blossom).....	44
🍂 (Autumn Colors)	44
🍽️ (Food).....	44
👤 (Silhouette).....	45
🔑 (High Key)	45
🔒 (Low Key).....	45
P (Programmed auto).....	68
S (Shutter-priority auto)	69
A (Aperture-priority auto).....	70
M (Manual)	71
U1/U2.....	75
👤 (Face-priority AF)	50
📷 (Wide-area AF)	50
📷 (Normal-area AF).....	50
👤 (Subject-tracking AF)	50
📷 (Matrix).....	105
👤 (Center-weighted)	105, 213
👤 (Spot).....	105
📷 (Exposure compensation)	107
📷 (Flexible program)	68
📷 (Live view)	49, 57
📷 (Info) button.....	10, 12
WB (White balance)	117
PRE (Preset manual)	117, 123
BKT (bracketing)	109, 164
🔍 (Help).....	18
● (Focus indicator).....	38, 97, 100

⌚ (Memory buffer).....	38, 79
📷 (Flash-ready indicator)	39
📷 Switch.....	229

Numerics

12-bit	87
14-bit	87
2,016-pixel RGB sensor.....	310
3D-tracking	94, 95

A

AC adapter.....	280, 282	
Accessories	280	
Accessory terminal	281	
Active D-Lighting	114, 139	
Add items (My Menu)	265	
ADL bracketing	114, 229	
Adobe RGB	141	
AE & flash (Auto bracketing set) ...	109, 229	
AE lock.....	106	
AE only (Auto bracketing set) 109,	229	
AE-L	106	
AE-L/AF-L button.....	97, 106, 232	
AF	50, 91–98	
AF area brackets	9, 34	
AF fine tune	246	
AF point illumination.....	209	
AF-A.....	91	
AF-area mode	50, 94	
AF-area mode (Live view/movie	AF).....	50
AF-assist.....	273, 279	
AF-C.....	91, 208	
AF-C priority selection.....	208	
AF-F	50	
AF-S	50, 91, 208	
AF-S priority selection	208	
After delete	200	
A-M switch.....	25	
Amber.....	119, 255	
Aperture	67, 70, 71	
Aperture-priority auto.....	70	
Aspect ratio	252	
Assign AE-L/AF-L button	232	
Assign Fn button	230	
Assign MB-D11 📷 button.....	235	
Assign preview button.....	232	
Attaching the lens.....	25	
Audio video (A/V) cable.....	191	
Auto (White balance).....	117	
Auto bracketing	109, 229	
Auto bracketing set.....	229	

Auto distortion control	205	
Auto flash	145	
Auto FP high-speed sync. 222, 223		
Auto image rotation.....	239	
Auto ISO sensitivity control	103	
Auto meter-off	39, 214	
Auto meter-off delay.....	214	
Auto-area AF	95	
Autofocus.....	50, 91–98	
Autofocus mode (Live view/movie	AF).....	50, 211
Auto-servo AF.....	91	
Available settings.....	292	

B

Backlight.....	219	
Backup (Role played by card in	Slot 2).....	89
Battery.....	21, 24, 35, 242, 315	
Battery info	242	
Battery order	221	
Battery pack	220, 221, 235, 242, 280	
Beep.....	215, 216	
Black-and-white (Monochrome)....	253	
Blue	119, 255	
Blue intensifier (Filter effects) ..	254	
Body cap.....	4, 25, 281	
Border (PictBridge)	184, 187	
Bracketing.....	109, 229	
Bracketing order.....	229	
Built-in AF-assist illuminator	210	
Bulb.....	71, 73	
Burst.....	153, 217, 230	

C

Calendar playback.....	172	
Camera Control Pro 2.....	281	
Capture NX 2.....	240, 281	
CEC	194	
Center-weighted area.....	213	
Charging a battery.....	21	
Choose color temp. (White	balance)	117, 122
Choose end point	63	
Choose start point.....	63	
CL mode shooting speed	217	
Clean image sensor	284	
Clock	27, 237	
Clock battery.....	28	
Cloudy (White balance)	117	
CLS	276	
Color balance.....	255	

Color outline 262
 Color sketch 262
 Color space 141
 Color temperature 117, 118, 122
 Commander mode 225
 Compatible lens 269
 Compressed (Type) 87
 Computer 179
 Connector for external
 microphone 3
 Continuous high speed 7, 77, 78
 Continuous low speed 7, 77, 78,
 217
 Continuous release mode 7, 77, 78
 Continuous-servo AF 91, 208
 Control panel 8
 Copy image(s) 197
 Copyright 169, 243
 Copyright information 243
 CPU lens 26, 269
 Creative Lighting System 276
 Cross screen (Filter effects) 254
 Custom Settings 206
 Customize command dials 233
 Cyanotype (Monochrome) 253

D

Date and time 27, 237
 Date format 27, 237
 Daylight saving time 27, 237
 DCF version 2.0 142, 318
 Default settings 151, 202, 207, 295
 Delayed remote (Remote control
 mode) 80
 Delete 47, 175
 Delete all images 176
 Delete current image 47, 175
 Delete selected images 176
 Depth-of-field 72
 Depth-of-field preview button .72,
 228, 232
 Destination (Movie settings) 60
 Device control (HDMI) 194
 Digital Print Order Format 182,
 185, 189, 318
 Diopter adjustment control 34,
 281
 Direct sunlight (White balance)
 117
 Display mode 197
 Distortion control 261
 D-Lighting 251
 DPOF 182, 185, 189, 318
 Dynamic-area AF 94, 95

E

Easy exposure compensation .. 212
 Edit movie 64, 66
 Ethernet 181, 280
 EV steps for exposure cntrl. 211
 Exif version 2.3 142, 318
 Exposure 67, 106, 107
 Exposure bracketing 109, 229
 Exposure compensation 107
 Exposure delay mode 219
 Exposure indicator 72
 Exposure lock 106
 Exposure meters 39, 214
 Exposure program 298
 External microphone 57, 60
 Eye-Fi upload 247

F

File naming 204
 File number sequence 218
 Filter effects 134, 254
 Fine tune optimal exposure 213
 Fine-tuning white balance 119
 Firmware version 247
 Fisheye 261
 Flash 39, 143, 144, 148, 149, 275
 Flash (White balance) 117
 Flash bracketing 109, 228
 Flash cntrl for built-in flash 223
 Flash compensation 148
 Flash mode 144
 Flash only (Auto bracketing set)
 109, 229
 Flash range 147
 Flash ready indicator .. 39, 149, 279
 Flash shutter speed 145, 223
 Flash sync speed 222, 223, 310
 Flash warning 219
 Flexible program 68
 Flicker reduction 53, 59, 237
 Fluorescent (White balance) 117
 Fn button 149, 161, 230
 f-number 70
 Focal length 160, 274
 Focal length scale 25
 Focal plane mark 100
 Focus indicator 38, 97, 100
 Focus lock 97
 Focus mode 50
 Focus point 38, 50, 94, 96, 100, 209,
 210
 Focus point wrap-around 209
 Focus tracking 93, 209
 Focus tracking with lock-on 209
 Focusing screen 309

Focus-mode switch 25, 99
 Format 32, 236
 Format memory card 32, 236
 Frame interval (Slide show) 201
 Front-curtain sync 145
 Full-frame playback 163
 FV lock 149

G

GP-1 162, 281
 GPS 162, 169
 GPS data 169
 Green 119, 255
 Green intensifier (Filter effects)
 254

H

H.264 313
 HDMI 193, 318
 HDMI mini-pin connector 3, 193
 HDMI-CEC 194
 Help 18
 Hi (Sensitivity) 102
 Hide image 196
 High definition 193, 318
 High ISO NR 205
 Highlights 166, 197
 Histogram 166, 167, 197

I

Image comment 238
 Image Dust Off ref photo 240
 Image overlay 256
 Image quality 85
 Image review 163, 200
 Image size 88
 Incandescent (White balance) 117
 Index print 188
 In-focus indicator 38, 97, 100
 Information 10, 165
 Information display 10, 219
 Interval timer shooting 155
 ISO display and adjustment 216
 ISO sensitivity 101, 103
 ISO sensitivity settings 102, 103
 ISO sensitivity step value 211
 i-TTL 146, 225

J

JPEG 85
 JPEG basic 85
 JPEG compression 87
 JPEG fine 85
 JPEG normal 85

L	
LAN.....	280
Landscape (Set Picture Control)	131
Language.....	27, 238
Large (Image size).....	88
LCD.....	237
LCD brightness.....	237
LCD illumination.....	219
Lens.....	25, 26, 159, 246, 269
Lens cap.....	25
Lens distance information.....	146
Lens focus ring.....	25, 55, 99
Lens mount.....	4, 25, 100
Lens VR switch.....	25, 26
Live view.....	49, 57
Live view switch.....	49, 57
Live view/movie AF.....	50, 211
Local area network.....	280
Lock mirror up for cleaning.....	286
Long exp. NR.....	205
Lossless compressed (Type).....	87

M	
Magenta.....	119, 255
Main command dial.....	13
Manage Picture Control.....	136
Manual.....	71, 99
Manual (Flash cntl for built-in flash).....	224
Manual focus.....	55, 99
Manual movie settings (Movie settings).....	60
Max. continuous release.....	217
Maximum aperture.....	100
MB-D11.....	220, 221, 235, 242, 280
MB-D11 battery type.....	220
Medium (Image size).....	88
Memory buffer.....	38, 79
Memory card 29, 32, 236, 319, 320	
Memory card capacity.....	320
Metering.....	105
Microphone.....	4, 57, 60
Microphone (Movie settings)	60
Miniature effect.....	263
Minimum aperture.....	26, 67
Mired.....	121
Mirror.....	80, 83, 286
Mirror up.....	7, 77, 83
Mode dial.....	6
Modeling flash.....	228
Monitor.....	46, 49, 163, 237
Monitor cover.....	17
Monitor off delay.....	215
Monitor pre-flash.....	146, 149

Monochrome.....	253
Monochrome (Set Picture Control)	131
Mounting mark.....	25
Movie quality (Movie settings) ..	60
Movie settings.....	60
Movie-record button.....	58
Movies.....	57
Multiple exposure.....	152
My Menu.....	265

N	
NEF.....	85, 87, 204
NEF (RAW).....	85, 87, 258
NEF (RAW) bit depth.....	87
NEF (RAW) processing.....	258
NEF (RAW) recording.....	87
Neutral (Set Picture Control)	131
Nikon Transfer 2.....	179, 180
Non-CPU lens.....	159, 270
Non-CPU lens data.....	159
Number of focus points.....	210
Number of shots.....	321

O	
OK button (shooting mode).....	229
Optimal quality (JPEG compression).....	87
Optional flash.....	224, 275
Output resolution (HDMI).....	194
Overflow (Role played by card in Slot 2).....	89
Overview data.....	170

P	
Page size (PictBridge).....	184, 187
Perspective control.....	263
Photo info.....	165, 197
PictBridge.....	182, 318
Picture Controls.....	131, 133
Playback.....	46, 163
Playback folder.....	195
Playback information.....	165, 197
Playback menu.....	195
Playback slot and folder.....	164
Playback zoom.....	173
Portrait (Set Picture Control)....	131
Power connector.....	280, 282
Power switch.....	2
Predictive focus tracking.....	93
Preset manual (White balance).....	117, 123
Press the shutter-release button all the way down.....	38, 39
Press the shutter-release button halfway.....	38, 39

Print (DPOF).....	185
Print select.....	185
Print set (DPOF).....	189
Printing.....	182
Programmed auto.....	68
Protecting photographs.....	174

Q	
Quick retouch.....	260
Quick-response remote (Remote control mode).....	80

R	
Rank items (My Menu).....	267
RAW Slot 1 - JPEG Slot 2 (Role played by card in Slot 2).....	89
Rear lens cap.....	25
Rear-curtain sync.....	145
Recent settings.....	268
Red intensifier (Filter effects) ...	254
Red-eye correction.....	251
Red-eye reduction.....	145
Release button to use dial.....	234
Release mode.....	7, 77
Release mode dial.....	7, 77
Release mode dial lock release ..	7, 77
Remote Control.....	7, 77, 80, 281
Remote control mode.....	80
Remote cord.....	73, 83, 281
Remote mirror-up (Remote control mode).....	80
Remove items (My Menu).....	266
Repeating flash.....	76, 151, 224
Reset.....	151, 202, 207
Reset custom settings.....	207
Reset shooting menu.....	202
Reset user settings.....	76
Resize.....	259
Restoring default settings.....	151, 202, 207, 295
Retouch menu.....	248
Reverse indicators.....	234
RGB.....	141
Role played by card in Slot 2.....	89
Rotate tall.....	200

S	
Save selected frame.....	63, 66
Save user settings.....	75
Save/load settings.....	244
Saving camera settings.....	244
Scene mode.....	40
Screen tips.....	216
SD memory card.....	29, 32, 89, 319, 320

Select date 177, 185, 196
 Self-timer7, 77, 80, 214
 Sensitivity101, 103
 Sepia (Monochrome)253
 Set Picture Control..... 131
 Setup menu236
 Shade (White balance) 117
 Shooting data..... 168
 Shooting menu202
 Shutter-priority auto.....69
 Shutter-release button...38, 39, 97,
 106, 213
 Shutter-release button AE-L213
 Side-by-side comparison264
 Single frame.....7, 77
 Single-point AF94, 95
 Single-servo AF 91, 208
 Size88
 Size priority (JPEG compression)...
 87
 Skylight (Filter effects).....254
 Slide show201
 Slot30, 89, 164
 Slot empty release lock.....234
 Slow sync 145
 Small (Image size)88
 Soft (Filter effects).....254
 Speaker 4, 5
 Speedlight275
 sRGB..... 141
 Standard (Set Picture Control).131
 Standard i-TTL flash for digital SLR
 146
 Start printing (PictBridge) 185, 187
 Storage folder.....203
 Straighten261
 Sub-command dial.....13

T

Television191, 237
 Thumbnail playback 171
 Time237
 Time stamp (PictBridge) ... 184, 187
 Time zone27, 237
 Time zone and date.....27, 237
 Timer.....80, 155
 Toning134, 135
 Trim252

U

USB180, 182
 USB cable180, 182
 User settings75
 UTC27, 162, 169

V

Vibration Reduction 26
 Video mode.....237
 Viewfinder9, 34, 281, 309
 Viewfinder eyepiece 81
 Viewfinder eyepiece cap 81
 Viewfinder focus.....34, 281
 Viewfinder grid display216
 Viewfinder warning display216
 ViewNX 2142, 179
 Virtual horizon245
 Vivid (Set Picture Control) 131

W

Warm filter (Filter effects).....254
 WB112, 117
 WB bracketing (Auto bracketing
 set)..... 112, 114, 229
 White balance112, 117
 White balance bracketing..... 112
 Wireless.....181, 280
 Wireless network.....181, 280
 Wireless transmitter181, 280
 WT-4.....181, 280



A series of 20 horizontal lines spanning the width of the page, providing a template for handwriting practice.

Nikon

No reproduction in any form of this manual, in whole or in part (except for brief quotation in critical articles or reviews), may be made without written authorization from NIKON CORPORATION.



NIKON CORPORATION

AMA13818 Printed in Europe

© 2010 Nikon Corporation

SB2K06(11)
6MB10111-06