

# ***Nikon***

DIGITAL CAMERA

# D5600



## Reference Manual

- Read this manual thoroughly before using the camera.
- To ensure proper use of the camera, be sure to read "For Your Safety" (page xiii).
- After reading this manual, keep it in a readily accessible place for future reference.

En



# SnapBridge

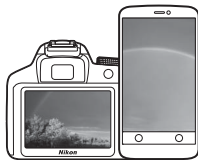

## Your images. The world. Connected

Welcome to SnapBridge — Nikon's new family of services to enrich your image experience. SnapBridge eliminates the barrier between your camera and compatible smart device, through a combination of *Bluetooth*® low energy (BLE) technology and a dedicated app. The stories you capture with your Nikon camera and lenses are automatically transferred to the device as they are taken. They can even be uploaded effortlessly to cloud storage services, inviting access across all your devices. You can share your excitement, when and where you want.

### Download the SnapBridge app to get started!

Take advantage of the wide-ranging convenience by downloading the SnapBridge app onto your smart device now. Through a few simple steps, this app connects your Nikon cameras with a compatible iPhone®, iPad® and/or iPod touch® or smart devices running on the Android™ operating system. SnapBridge is available free of charge from the Apple App Store®, on Google Play™, and from the following website:

<http://snapbridge.nikon.com>

For the latest information on SnapBridge, visit the Nikon website for your area (☎ xxi).



Download on the  
**App Store**



GET IT ON  
**Google Play**

## The exciting image experience that SnapBridge offers...



Automatic picture transfer from camera to smart device thanks to the constant connection between the two devices — making online photo sharing easier than ever

### NIKON IMAGE SPACE



Upload of photos and thumbnail images to the NIKON IMAGE SPACE cloud service

## A range of services that enriches your imaging life, including:

- Camera remote control
- Imprinting up to two pieces of credit information (e.g. copyright, comments, text and logos) on pictures
- Automatic update of camera's date and time info and location info
- Receive camera's firmware updates

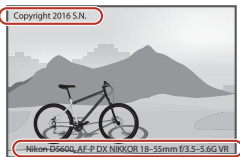

To get the most from your camera, please be sure to read all instructions thoroughly and keep them where they will be read by all who use the product.

### Symbols and Conventions

To make it easier to find the information you need, the following symbols and conventions are used:



This icon marks cautions; information that should be read before use to prevent damage to the camera.



This icon marks notes; information that should be read before using the camera.



This icon marks references to other pages in this manual.

Menu items, options, and messages displayed in the camera monitor are shown in **bold**.

### Camera Settings

The explanations in this manual assume that default settings are used.

#### Nikon Manual Viewer 2



Install the Nikon Manual Viewer 2 app on your smartphone or tablet to view Nikon digital camera manuals, anytime, anywhere. Nikon Manual Viewer 2 can be downloaded free of charge from the App Store and on Google Play. Download of the app and any product manuals requires an Internet connection, for which fees may be levied by your phone or Internet service provider.

















#### For Your Safety

Before using the camera for the first time, read the safety instructions in "For Your Safety" (📖 xiii–xvi).











# Table of Contents

For Your Safety.....	xiii
Notices.....	xvii
Bluetooth and Wi-Fi (Wireless LAN).....	xxii
<b>Introduction</b>	<b>1</b>
<hr/>	
<b>Getting to Know the Camera</b> .....	<b>1</b>
The Camera Body .....	1
The Mode Dial .....	4
The Viewfinder .....	5
The <b>Info</b> (Info) Button.....	6
The <b>i</b> Button .....	12
<b>The Monitor</b> .....	<b>13</b>
Using the Touch Screen .....	15
Touch-Screen Photography .....	17
Viewing Pictures .....	23
Using the Menus.....	25
<b>First Steps</b>	<b>26</b>
<hr/>	
Attach the Camera Strap .....	26
Charge the Battery.....	26
Insert the Battery and a Memory Card.....	27
Open the Monitor .....	29
Attach a Lens .....	30
Camera Setup.....	33
Focus the Viewfinder .....	41
<b>Tutorial</b>	<b>42</b>
<hr/>	
<b>Camera Menus: An Overview</b> .....	<b>42</b>
<b>The Battery Level and Number of Exposures Remaining ...</b>	<b>46</b>

<b>Basic Photography and Playback</b>	<b>47</b>
<hr/>	
“Point-and-Shoot” Modes (AUTO and  ).....	47
Basic Playback.....	56
Deleting Unwanted Photographs.....	57
<b>Matching Settings to the Subject or Situation (Scene Mode)</b>	<b>58</b>
<hr/>	
 Portrait.....	59
 Landscape.....	59
 Child.....	59
 Sports.....	60
 Close up.....	60
 Night Portrait.....	60
 Night Landscape.....	61
 Party/Indoor.....	61
 Beach/Snow.....	61
 Sunset.....	62
 Dusk/Dawn.....	62
 Pet Portrait.....	62
 Candlelight.....	63
 Blossom.....	63
 Autumn Colors.....	63
 Food.....	64

## Special Effects

65

 Night Vision .....	65
<b>VI</b> Super Vivid .....	66
<b>POP</b> Pop .....	66
 Photo Illustration.....	66
 Toy Camera Effect .....	67
 Miniature Effect .....	67
 Selective Color .....	67
 Silhouette .....	68
 High Key .....	68
 Low Key.....	68
Options Available in Live View .....	70

## More on Photography

75

<b>Choosing a Release Mode.....</b>	<b>75</b>
<b>Continuous Shooting (Burst Mode).....</b>	<b>76</b>
<b>Quiet Shutter Release.....</b>	<b>78</b>
<b>Self-Timer Mode .....</b>	<b>79</b>
<b>Focus.....</b>	<b>82</b>
Focus Mode .....	82
AF-Area Mode .....	87
Focus Lock.....	93
Manual Focus .....	95
<b>Image Quality and Size .....</b>	<b>98</b>
Image Quality.....	98
Image Size .....	100
<b>Using the Built-in Flash .....</b>	<b>101</b>
Auto Pop-up Modes.....	101
Manual Pop-up Modes .....	103
<b>ISO Sensitivity .....</b>	<b>107</b>
<b>Interval Timer Photography.....</b>	<b>109</b>
<b>Restoring Default Settings .....</b>	<b>115</b>

---

<b>Shutter Speed and Aperture</b> .....	118
Mode <b>P</b> (Programmed Auto) .....	119
Mode <b>S</b> (Shutter-Priority Auto) .....	121
Mode <b>A</b> (Aperture-Priority Auto) .....	122
Mode <b>M</b> (Manual) .....	123
Long Time-Exposures ( <b>M</b> Mode Only) .....	125
<b>Exposure</b> .....	128
Metering .....	128
Autoexposure Lock.....	130
Exposure Compensation .....	132
Flash Compensation .....	134
<b>Preserving Detail in Highlights and Shadows</b> .....	136
Active D-Lighting .....	136
High Dynamic Range (HDR) .....	138
<b>White Balance</b> .....	140
Fine-Tuning White Balance .....	143
Preset Manual .....	145
<b>Bracketing</b> .....	151
<b>Picture Controls</b> .....	155
Selecting a Picture Control .....	155
Modifying Picture Controls.....	157
Creating Custom Picture Controls .....	161





<b>Recording and Viewing Movies</b>	<b>164</b>
<b>Recording Movies</b>	<b>164</b>
The <b>i</b> Button	166
Movie Settings	168
<b>Time-Lapse Movies</b>	<b>171</b>
<b>Viewing Movies</b>	<b>176</b>
<b>Editing Movies</b>	<b>178</b>
Trimming Movies	178
Saving Selected Frames	182
<b>Playback and Deletion</b>	<b>184</b>
<b>Full-Frame Playback</b>	<b>184</b>
Thumbnail Playback	185
Calendar Playback	186
The <b>i</b> Button	187
<b>Photo Information</b>	<b>188</b>
<b>Taking a Closer Look: Playback Zoom</b>	<b>196</b>
<b>Protecting Photographs from Deletion</b>	<b>200</b>
<b>Rating Pictures</b>	<b>201</b>
Rating Individual Pictures	201
Rating Multiple Pictures	202
<b>Selecting Photos for Upload</b>	<b>203</b>
Selecting Individual Photos	203
Selecting Multiple Photos	204
<b>Deleting Photographs</b>	<b>205</b>
During Playback	205
The Playback Menu	206
<b>Slide Shows</b>	<b>208</b>
Slide Show Options	209

<b>Connections</b>	<b>210</b>
Installing ViewNX-i.....	210
Copying Pictures to the Computer .....	211
Printing Photographs .....	214
Connecting the Printer.....	214
Printing Pictures One at a Time.....	215
Printing Multiple Pictures.....	216
Viewing Pictures on TV .....	218
<b>Camera Menus</b>	<b>220</b>
▶ <b>The Playback Menu: <i>Managing Images</i></b> .....	<b>220</b>
Playback Menu Options.....	220
Playback Folder .....	221
Playback Display Options .....	221
Image Review .....	221
Auto Image Rotation .....	222
Rotate Tall.....	222
📷 <b>The Shooting Menu: <i>Shooting Options</i></b> .....	<b>223</b>
Shooting Menu Options .....	223
Reset Shooting Menu.....	225
Storage Folder .....	225
File Naming .....	227
NEF (RAW) Recording .....	227
ISO Sensitivity Settings .....	228
Color Space .....	230
Long Exposure NR .....	230
High ISO NR.....	231
Vignette Control.....	231
Auto Distortion Control.....	232
Optical VR .....	232

 <b>Custom Settings: <i>Fine-Tuning Camera Settings</i></b> .....	233
Custom Settings .....	234
Reset Custom Settings .....	235
a: Autofocus .....	235
a1: AF-C Priority Selection .....	235
a2: Number of Focus Points .....	236
a3: Built-in AF-assist Illuminator .....	237
a4: Rangefinder .....	237
a5: Manual Focus Ring in AF Mode .....	238
b: Exposure .....	239
b1: EV Steps for Exposure Cntrl .....	239
b2: ISO Display .....	239
c: Timers/AE Lock .....	239
c1: Shutter-Release Button AE-L .....	239
c2: Auto off Timers .....	240
c3: Self-Timer .....	241
d: Shooting/Display .....	241
d1: Exposure Delay Mode .....	241
d2: File Number Sequence .....	242
d3: Viewfinder Grid Display .....	243
d4: Date Stamp .....	243
d5: Reverse Indicators .....	245
e: Bracketing/Flash .....	246
e1: Flash Cntrl for Built-in Flash/Optional Flash .....	246
e2: Auto Bracketing Set .....	251
f: Controls .....	252
f1: Assign Fn Button .....	252
f2: Assign AE-L/AF-L Button .....	254
f3: Assign Touch Fn .....	255
f4: Reverse Dial Rotation .....	256

<b>Y The Setup Menu: <i>Camera Setup</i> .....</b>	<b>257</b>
Setup Menu Options .....	257
Format Memory Card .....	259
Image Comment .....	260
Copyright Information .....	261
Time Zone and Date .....	262
Language .....	262
Beep Options .....	263
Touch Controls .....	263
Monitor Brightness .....	263
Info Display Format .....	264
Auto Info Display .....	265
Info Display Auto Off .....	265
Image Dust Off Ref Photo .....	266
Flicker Reduction .....	268
Slot Empty Release Lock .....	268
Location Data .....	269
Remote Control .....	270
Airplane Mode .....	271
Connect to Smart Device .....	271
Send to Smart Device (Auto) .....	272
Wi-Fi .....	272
Bluetooth .....	273
Eye-Fi Upload .....	274
Conformity Marking .....	276
Firmware Version .....	276



 <b>The Retouch Menu: <i>Creating Retouched Copies</i>.....</b>	<b>277</b>
Retouch Menu Options .....	277
Creating Retouched Copies .....	278
NEF (RAW) Processing .....	280
Trim .....	282
Resize .....	283
D-Lighting.....	285
Quick Retouch .....	286
Red-Eye Correction .....	286
Straighten .....	287
Distortion Control .....	287
Perspective Control .....	288
Fisheye .....	288
Filter Effects .....	289
Monochrome .....	290
Image Overlay .....	291
Color Outline.....	293
Photo Illustration.....	294
Color Sketch .....	294
Miniature Effect.....	295
Selective Color.....	296
Painting.....	298
Side-by-side Comparison .....	298
 <b>Recent Settings/ My Menu .....</b>	<b>300</b>
Choosing a Menu.....	300
 Recent Settings .....	301
 My Menu .....	301

<b>Compatible Lenses</b> .....	<b>305</b>
Compatible CPU Lenses.....	305
Compatible Non-CPU Lenses.....	308
<b>The Nikon Creative Lighting System (CLS)</b> .....	<b>315</b>
<b>Other Accessories</b> .....	<b>321</b>
Attaching a Power Connector and AC Adapter .....	325
<b>Caring for the Camera</b> .....	<b>327</b>
Storage.....	327
Cleaning.....	327
Image Sensor Cleaning .....	328
<b>Caring for the Camera and Battery: Cautions</b> .....	<b>333</b>
<b>Available Settings</b> .....	<b>338</b>
<b>Troubleshooting</b> .....	<b>340</b>
Battery/Display.....	340
Shooting (All Modes) .....	341
Shooting (P, S, A, M).....	345
Playback.....	346
Bluetooth and Wi-Fi (Wireless Networks).....	348
Miscellaneous .....	348
<b>Error Messages</b> .....	<b>349</b>
<b>Specifications</b> .....	<b>356</b>
<b>AF-P DX NIKKOR 18–55mm f/3.5–5.6G VR Lenses</b> .....	<b>369</b>
<b>AF-P DX NIKKOR 70–300mm f/4.5–6.3G ED VR and</b> <b>AF-P DX NIKKOR 70–300mm f/4.5–6.3G ED Lenses</b> .....	<b>375</b>
<b>AF-S DX NIKKOR 18–140mm f/3.5–5.6G ED VR Lenses</b> ....	<b>380</b>
<b>Memory Card Capacity</b> .....	<b>387</b>
<b>Battery Life</b> .....	<b>388</b>
<b>Index</b> .....	<b>390</b>

## For Your Safety

To prevent damage to property or injury to yourself or to others, read “For Your Safety” in its entirety before using this product.

Keep these safety instructions where all those who use this product will read them.

**⚠ DANGER:** Failure to observe the precautions marked with this icon carries a high risk of death or severe injury.

**⚠ WARNING:** Failure to observe the precautions marked with this icon could result in death or severe injury.

**⚠ CAUTION:** Failure to observe the precautions marked with this icon could result in injury or property damage.



### WARNING

- **Do not use while walking or operating a motor vehicle.**

Failure to observe this precaution could result in accidents or other injury.

- **Do not disassemble or modify this product. Do not touch internal parts that become exposed as the result of a fall or other accident.**

Failure to observe these precautions could result in electric shock or other injury.

- **Should you notice any abnormalities such as the product producing smoke, heat, or unusual odors, immediately disconnect the battery or power source.**

Continued operation could result in fire, burns or other injury.

- **Keep dry. Do not handle with wet hands. Do not handle the plug with wet hands.**

Failure to observe these precautions could result in fire or electric shock.

- **Do not let your skin remain in prolonged contact with this product while it is on or plugged in.**

Failure to observe this precaution could result in low-temperature burns.

- **Do not use this product in the presence of flammable dust or gas such as propane, gasoline or aerosols.**

Failure to observe this precaution could result in explosion or fire.

- **Do not directly view the sun or other bright light source through the lens or camera.**

Failure to observe this precaution could result in visual impairment.

---

- **Do not aim the flash or AF-assist illuminator at the operator of a motor vehicle.**

Failure to observe this precaution could result in accidents.

---

- **Keep this product out of reach of children.**

Failure to observe this precaution could result in injury or product malfunction. In addition, note that small parts constitute a choking hazard. Should a child swallow any part of this product, seek immediate medical attention.

---

- **Do not entangle, wrap or twist the straps around your neck.**

Failure to observe this precaution could result in accidents.

---

- **Do not use batteries, chargers, or AC adapters not specifically designated for use with this product. When using batteries, chargers, and AC adapters designated for use with this product, do not:**

- **Damage, modify, forcibly tug or bend the cords or cables, place them under heavy objects, or expose them to heat or flame.**
- **Use travel converters or adapters designed to convert from one voltage to another or with DC-to-AC inverters.**

Failure to observe these precautions could result in fire or electric shock.

---

- **Do not handle the plug when charging the product or using the AC adapter during thunderstorms.**

Failure to observe this precaution could result in electric shock.

---

- **Do not handle with bare hands in locations exposed to extremely high or low temperatures.**

Failure to observe this precaution could result in burns, or frostbite.

---



## CAUTION

- **Do not leave the lens pointed at the sun or other strong light sources.**

Light focused by the lens could cause fire or damage to product's internal parts. When shooting backlit subjects, keep the sun well out of the frame. Sunlight focused into the camera when the sun is close to the frame could cause fire.

---

- **Turn this product off when its use is prohibited. Disable wireless features when the use of wireless equipment is prohibited.**

The radio-frequency emissions produced by this product could interfere with equipment onboard aircraft or in hospitals or other medical facilities.

- **Remove the battery and disconnect the AC adapter if this product will not be used for an extended period.**

Failure to observe this precaution could result in fire or product malfunction.

- **Do not touch moving parts of the lens or other moving parts.**

Failure to observe this precaution could result in injury.

- **Do not fire the flash in contact with or in close proximity to the skin or objects.**

Failure to observe this precaution could result in burns or fire.

- **Do not leave the product where it will be exposed to extremely high temperatures, for an extended period such as in an enclosed automobile or in direct sunlight.**

Failure to observe this precaution could result in fire or product malfunction.



## **DANGER (Batteries)**

- **Do not mishandle batteries.**

Failure to observe the following precautions could result in the batteries leaking, overheating, rupturing, or catching fire:

- Use only rechargeable batteries approved for use in this product.
- Do not expose batteries to flame or excessive heat.
- Do not disassemble.
- Do not short-circuit the terminals by touching them to necklaces, hairpins, or other metal objects.
- Do not expose batteries or the products in which they are inserted to powerful physical shocks.

- **Do not attempt to recharge EN-EL14a rechargeable batteries using chargers not specifically designated for this purpose.**

Failure to observe this precaution could result in the batteries leaking, overheating, rupturing, or catching fire.

- **If battery liquid comes into contact with the eyes, rinse with plenty of clean water and seek immediate medical attention.**

Delaying action could result in eye injuries.



## WARNING (Batteries)

- **Keep batteries out of reach of children.**

Should a child swallow a battery, seek immediate medical attention.

---

- **Do not immerse batteries in water or expose to rain.**

Failure to observe this precaution could result in fire or product malfunction. Immediately dry the product with a towel or similar object should it become wet.

---

- **Discontinue use immediately should you notice any changes in the batteries, such as discoloration or deformation. Cease charging EN-EL14a rechargeable batteries if they do not charge in the specified period of time.**

Failure to observe these precautions could result in the batteries leaking, overheating, rupturing, or catching fire.

---

- **Prior to disposal, insulate battery terminals with tape.**

Overheating, rupture, or fire may result should metal objects come into contact with the terminals. Recycle or dispose of batteries in accord with local regulations.

---

- **If battery liquid comes into contact with a person's skin or clothing, immediately rinse the affected area with plenty of clean water.**

Failure to observe this precaution could result in skin irritation.

---

## Notices

- No part of the manuals included with this product may be reproduced, transmitted, transcribed, stored in a retrieval system, or translated into any language in any form, by any means, without Nikon's prior written permission.
- Nikon reserves the right to change the appearance and specifications of the hardware and software described in these manuals at any time and without prior notice.
- Nikon will not be held liable for any damages resulting from the use of this product.
- While every effort has been made to ensure that the information in these manuals is accurate and complete, we would appreciate it were you to bring any errors or omissions to the attention of the Nikon representative in your area (address provided separately).

### **Notice for Customers in Canada**

CAN ICES-3 B / NMB-3 B

### **Notices for Customers in Europe**

**CAUTION: RISK OF EXPLOSION IF BATTERY IS REPLACED BY AN INCORRECT TYPE. DISPOSE OF USED BATTERIES ACCORDING TO THE INSTRUCTIONS.**

This symbol indicates that electrical and electronic equipment is to be collected separately.



This symbol on the battery indicates that the battery is to be collected separately.



The following apply only to users in European countries:

- This product is designated for separate collection at an appropriate collection point. Do not dispose of as household waste.
- Separate collection and recycling helps conserve natural resources and prevent negative consequences for human health and the environment that might result from incorrect disposal.
- For more information, contact the retailer or the local authorities in charge of waste management.

The following apply only to users in European countries:

- All batteries, whether marked with this symbol or not, are designated for separate collection at an appropriate collection point. Do not dispose of as household waste.
- For more information, contact the retailer or the local authorities in charge of waste management.

## **Notices for Customers in the U.S.A.**

### **The Battery Charger**

# **IMPORTANT SAFETY INSTRUCTIONS—SAVE THESE INSTRUCTIONS**

## **DANGER—TO REDUCE THE RISK OF FIRE OR ELECTRIC SHOCK, CAREFULLY FOLLOW THESE INSTRUCTIONS**

For connection to a supply not in the U.S.A., use an attachment plug adapter of the proper configuration for the power outlet if needed. This power unit is intended to be correctly oriented in a vertical or floor mount position.

### **Federal Communications Commission (FCC) Radio Frequency Interference Statement**

This equipment has been tested and found to comply with the limits for a Class B digital device, pursuant to Part 15 of the FCC rules. These limits are designed to provide reasonable protection against harmful interference in a residential installation. This equipment generates, uses, and can radiate radio frequency energy and, if not installed and used in accordance with the instructions, may cause harmful interference to radio communications. However, there is no guarantee that interference will not occur in a particular installation. If this equipment does cause harmful interference to radio or television reception, which can be determined by turning the equipment off and on, the user is encouraged to try to correct the interference by one or more of the following measures:

- Reorient or relocate the receiving antenna.
- Increase the separation between the equipment and receiver.
- Connect the equipment into an outlet on a circuit different from that to which the receiver is connected.
- Consult the dealer or an experienced radio/television technician for help.



**Nikon**  
D5600

#### **CAUTIONS**

##### *Modifications*

The FCC requires the user to be notified that any changes or modifications made to this device that are not expressly approved by Nikon Corporation may void the user's authority to operate the equipment.

##### *Interface Cables*

Use the interface cables sold or provided by Nikon for your equipment. Using other interface cables may exceed the limits of Class B Part 15 of the FCC rules.

Nikon Inc., 1300 Walt Whitman Road,  
Melville, New York 11747-3064, U.S.A.  
Tel.: 631-547-4200



## **Notice Concerning Prohibition of Copying or Reproduction**

Note that simply being in possession of material that has been digitally copied or reproduced by means of a scanner, digital camera, or other device may be punishable by law.

- **Items prohibited by law from being copied or reproduced**

Do not copy or reproduce paper money, coins, securities, government bonds, or local government bonds, even if such copies or reproductions are stamped "Sample."

The copying or reproduction of paper money, coins, or securities which are circulated in a foreign country is prohibited.

Unless the prior permission of the government has been obtained, the copying or reproduction of unused postage stamps or post cards issued by the government is prohibited.

The copying or reproduction of stamps issued by the government and of certified documents stipulated by law is prohibited.

- **Cautions on certain copies and reproductions**

The government has issued cautions on copies or reproductions of securities issued by private companies (shares, bills, checks, gift certificates, etc.), commuter passes, or coupon tickets, except when a minimum of necessary copies are to be provided for business use by a company. Also, do not copy or reproduce passports issued by the government, licenses issued by public agencies and private groups, ID cards, and tickets, such as passes and meal coupons.

- **Comply with copyright notices**

Under copyright law, photographs or recordings of copyrighted works made with the camera can not be used without the permission of the copyright holder. Exceptions apply to personal use, but note that even personal use may be restricted in the case of photographs or recordings of exhibits or live performances.

## **Disposing of Data Storage Devices**

Please note that deleting images or formatting memory cards or other data storage devices does not completely erase the original image data. Deleted files can sometimes be recovered from discarded storage devices using commercially available software, potentially resulting in the malicious use of personal image data. Ensuring the privacy of such data is the user's responsibility.

Before discarding a data storage device or transferring ownership to another person, erase all data using commercial deletion software, or format the device and then completely refill it with images containing no private information (for example, pictures of empty sky). Be sure to also replace any pictures selected for preset manual (□ 149). Before discarding the camera or transferring ownership to another person, you should also use the **Wi-Fi > Reset connection settings** (□ 272) option in the camera setup menu to delete any personal network information. Care should be taken to avoid injury when physically destroying data storage devices.

## **AVC Patent Portfolio License**

THIS PRODUCT IS LICENSED UNDER THE AVC PATENT PORTFOLIO LICENSE FOR THE PERSONAL AND NON-COMMERCIAL USE OF A CONSUMER TO (i) ENCODE VIDEO IN COMPLIANCE WITH THE AVC STANDARD ("AVC VIDEO") AND/OR (ii) DECODE AVC VIDEO THAT WAS ENCODED BY A CONSUMER ENGAGED IN A PERSONAL AND NON-COMMERCIAL ACTIVITY AND/OR WAS OBTAINED FROM A VIDEO PROVIDER LICENSED TO PROVIDE AVC VIDEO. NO LICENSE IS GRANTED OR SHALL BE IMPLIED FOR ANY OTHER USE. ADDITIONAL INFORMATION MAY BE OBTAINED FROM MPEG LA, L.L.C. SEE <http://www.mpegla.com>

## **Use Only Nikon Brand Electronic Accessories**

Nikon cameras are designed to the highest standards and include complex electronic circuitry. Only Nikon brand electronic accessories (including chargers, batteries, AC adapters, and flash accessories) certified by Nikon specifically for use with this Nikon digital camera are engineered and proven to operate within the operational and safety requirements of this electronic circuitry.

The use of non-Nikon electronic accessories could damage the camera and may void your Nikon warranty. The use of third-party rechargeable Li-ion batteries not bearing the Nikon holographic seal shown at right could interfere with normal operation of the camera or result in the batteries overheating, igniting, rupturing, or leaking.

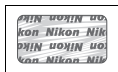

For more information about Nikon brand accessories, contact a local authorized Nikon dealer.

### ✔ Use Only Nikon Brand Accessories

Only Nikon brand accessories certified by Nikon specifically for use with your Nikon digital camera are engineered and proven to operate within its operational and safety requirements. THE USE OF NON-NIKON ACCESSORIES COULD DAMAGE YOUR CAMERA AND MAY VOID YOUR NIKON WARRANTY.

### ✔ Before Taking Important Pictures

Before taking pictures on important occasions (such as at weddings or before taking the camera on a trip), take a test shot to ensure that the camera is functioning normally. Nikon will not be held liable for damages or lost profits that may result from product malfunction.

### ✔ Life-Long Learning

As part of Nikon's "Life-Long Learning" commitment to ongoing product support and education, continually-updated information is available online at the following sites:

- **For users in the U.S.A.:** <http://www.nikonusa.com/>
- **For users in Europe and Africa:** <http://www.europe-nikon.com/support/>
- **For users in Asia, Oceania, and the Middle East:** <http://www.nikon-asia.com/>

Visit these sites to keep up-to-date with the latest product information, tips, answers to frequently-asked questions (FAQs), and general advice on digital imaging and photography. Additional information may be available from the Nikon representative in your area. See the following URL for contact information: <http://imaging.nikon.com/>

## Bluetooth and Wi-Fi (Wireless LAN)

This product is controlled by the United States Export Administration Regulations (EAR). The permission of the United States government is not required for export to countries other than the following, which as of this writing are subject to embargo or special controls: Cuba, Iran, North Korea, Sudan, and Syria (list subject to change).

The use of wireless devices may be prohibited in some countries or regions. Contact a Nikon-authorized service representative before using the wireless features of this product outside the country of purchase.

### **Notice for Customers in the U.S.A. and Canada**

This device complies with Part 15 of FCC Rules and Industry Canada licence-exempt RSS standard(s). Operation is subject to the following two conditions: (1) this device may not cause interference, and (2) this device must accept any interference, including interference that may cause undesired operation of the device.

### **FCC WARNING**

The FCC requires the user to be notified that any changes or modifications made to this device that are not expressly approved by Nikon Corporation may void the user's authority to operate the equipment.

### **FCC Radio Frequency Interference Statement**

Note: This equipment has been tested and found to comply with the limits for a Class B digital device, pursuant to part 15 of the FCC Rules. These limits are designed to provide reasonable protection against harmful interference in a residential installation. This equipment generates, uses and can radiate radio frequency energy and, if not installed and used in accordance with the instructions, may cause harmful interference to radio communications. However, there is no guarantee that interference will not occur in a particular installation. If this equipment does cause harmful interference to radio or television reception, which can be determined by turning the equipment off and on, the user is encouraged to try to correct the interference by one or more of the following measures:

- Reorient or relocate the receiving antenna.
- Increase the separation between the equipment and receiver.
- Connect the equipment into an outlet on a circuit different from that to which the receiver is connected.
- Consult the dealer or an experienced radio/TV technician for help.

### **Co-location**

This transmitter must not be co-located or operated in conjunction with any other antenna or transmitter.

Nikon Inc., 1300 Walt Whitman Road, Melville, New York 11747-3064, U.S.A.  
Tel.: 631-547-4200

### **FCC/IC RF Exposure Statement**

The available scientific evidence does not show that any health problems are associated with using low power wireless devices. There is no proof, however, that these low power wireless devices are absolutely safe. Low power wireless devices emit low levels of radio frequency energy (RF) in the microwave range while being used. Whereas high levels of RF can produce health effects (by heating tissue), exposure of low-level RF that does not produce heating effects causes no known adverse health effects. Many studies of low-level RF exposures have not found any biological effects. Some studies have suggested that some biological effects might occur, but such findings have not been confirmed by additional research. The D5600, which is equipped with a LBEE5UW1FS (FCC ID:VPYLB1FS / IC ID:772C-LB1FS) Wireless LAN Module, has been tested and found to comply with FCC/IC radiation exposure limits set forth for an uncontrolled environment and meets the FCC radio frequency (RF) Exposure Guidelines in Supplement C to OET65 and RSS-102 of the IC radio frequency (RF) Exposure rules. Please refer to the SAR test report that was uploaded to FCC website.

### **Notices for Customers in Europe**

Hereby, Nikon Corporation declares that the radio equipment type D5600 is in compliance with Directive 2014/53/EU. The full text of the EU declaration of conformity is available at the following internet address:

[http://imaging.nikon.com/support/pdf/DoC\\_D5600.pdf](http://imaging.nikon.com/support/pdf/DoC_D5600.pdf).

### **Notice for Customers in Singapore**

Trade Name: <b>Nikon</b> Model: D5600
--

This device complies with radio-frequency regulations. The content of certification labels not affixed to the device is given below.

Complies with IMDA Standards DA103423
---



## **Security**

Although one of the benefits of this product is that it allows others to freely connect for the wireless exchange of data anywhere within its range, the following may occur if security is not enabled:

- **Data theft:** Malicious third-parties may intercept wireless transmissions to steal user IDs, passwords, and other personal information.
- **Unauthorized access:** Unauthorized users may gain access to the network and alter data or perform other malicious actions. Note that due to the design of wireless networks, specialized attacks may allow unauthorized access even when security is enabled.
- **Unsecured networks:** Connecting to open networks may result in unauthorized access. Use secure networks only.

# Introduction

## Getting to Know the Camera

Take a few moments to familiarize yourself with camera controls and displays. You may find it helpful to bookmark this section and refer to it as you read through the rest of the manual.

### The Camera Body

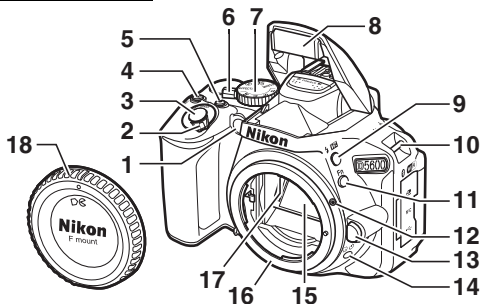

1	AF-assist illuminator .....	85, 237	10	Eyelets for camera strap.....	26
	Self-timer lamp.....	80	11	Fn button .....	252
	Red-eye reduction lamp ..	102, 104	12	Mounting mark .....	30
2	Power switch.....	34, 39	13	Lens release button.....	31
3	Shutter-release button .....	52	14	☐/☺ button.....	75, 76, 78, 79
4	☑/Ⓞ button.....	124, 132, 134	15	Mirror .....	330
5	Movie-record button .....	165	16	Lens mount .....	30, 96
6	Live view switch .....	47, 164	17	CPU contacts	
7	Mode dial.....	4	18	Body cap .....	30, 323
8	Built-in flash .....	101			
9	⚡/☑ button.....	101, 103, 134			

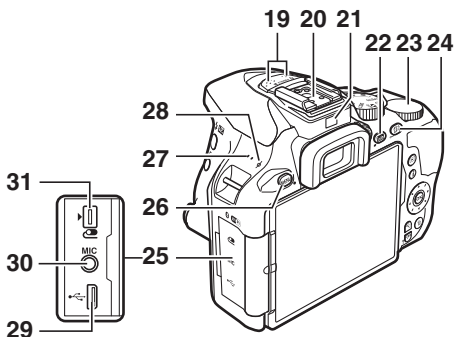

<b>19</b> Stereo microphone .....	169	<b>26</b> MENU button .....	42, 115, 220
<b>20</b> Accessory shoe (for optional flash units) .....	315	<b>27</b> Speaker	
<b>21</b> Eye sensor .....	8, 265	<b>28</b> Focal plane mark (☉) .....	96
<b>22</b> info (information) button .....	6, 9, 115	<b>29</b> USB connector .....	211, 214
<b>23</b> Command dial		<b>30</b> Connector for external microphone .....	170
<b>24</b> AE-L/AF-L button .....	94, 130, 200, 254	<b>31</b> Accessory terminal .....	324
<b>25</b> Connector cover			

#### ✔ Close the Connector Cover

Close the connector cover when the connectors are not in use. Foreign matter in the connectors can interfere with data transfer.

#### ✔ The Speaker

Do not place the speaker in close proximity to magnetic devices. Failure to observe this precaution could affect the data recorded on the magnetic devices.



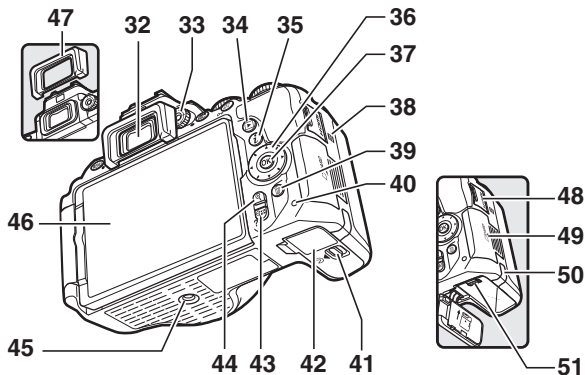

<b>32</b> Viewfinder eyepiece.....	5, 41, 80	<b>43</b> Q/? button.....	43, 185, 196
<b>33</b> Diopter adjustment control .....	41	<b>44</b> Q button.....	185, 196
<b>34</b> [▶] button.....	56, 184	<b>45</b> Tripod socket	
<b>35</b> [i] button.....	12, 166, 187	<b>46</b> Vari-angle monitor	
<b>36</b> Multi selector .....	34, 39, 43	.....	13, 15, 47, 56, 184, 255
<b>37</b> [OK] button.....	34, 39, 43	<b>47</b> Rubber eyecup .....	80
<b>38</b> N-Mark (NFC antenna).....	35	<b>48</b> HDMI connector cover .....	218
<b>39</b> [M] button .....	57, 205	<b>49</b> Memory card slot cover .....	27, 28
<b>40</b> Memory card access lamp .....	51	<b>50</b> Power connector cover for	
<b>41</b> Battery-chamber cover		optional power connector .....	325
latch .....	27, 28, 325	<b>51</b> Battery latch.....	27, 28, 325
<b>42</b> Battery-chamber cover			
.....	27, 28, 325		

## The Mode Dial

The camera offers a choice of the following shooting modes.

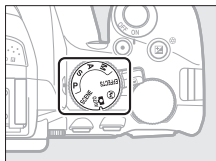

### P, S, A, and M Modes:

- **P**— Programmed auto (□ 119)
- **S**— Shutter-priority auto (□ 121)
- **A**— Aperture-priority auto (□ 122)
- **M**— Manual (□ 123)

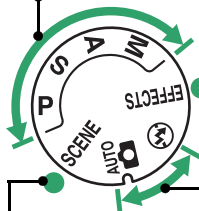

**Special Effects Modes** (□ 65)

### Auto Modes:

-  **Auto** (□ 47)
-  **Auto (flash off)** (□ 47)

**Scene Modes** (□ 58)

## The Viewfinder

**Note:** Display shown with all indicators lit for illustrative purposes.

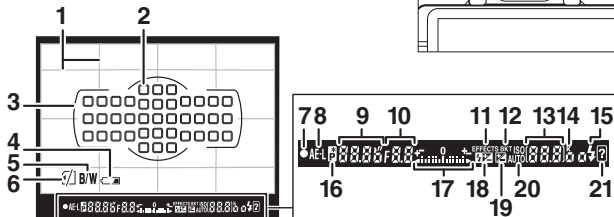
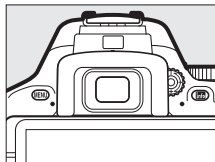

- |  |   |
|--|---|
| <p><b>1</b> Framing grid (displayed when <b>On</b> is selected for Custom Setting d3, <b>Viewfinder grid display</b>) ... 243</p> <p><b>2</b> Focus points ..... 50, 90, 236</p> <p><b>3</b> AF area brackets ..... 41, 49</p> <p><b>4</b> Low battery warning ..... 46</p> <p><b>5</b> Monochrome indicator (displayed in  mode or when the <b>Monochrome</b> Picture Control or a Picture Control based on <b>Monochrome</b> is selected) ..... 65, 155</p> <p><b>6</b> "No memory card" indicator ..... 27</p> <p><b>7</b> Focus indicator ..... 50, 96</p> <p><b>8</b> Autoexposure (AE) lock indicator ..... 130</p> <p><b>9</b> Shutter speed ..... 118</p> <p><b>10</b> Aperture (f-number) ..... 118</p> <p><b>11</b> Special effects mode indicator ..... 65</p> <p><b>12</b> Bracketing indicator ..... 151</p> | <p><b>13</b> Number of exposures remaining ..... 46</p> <p>Number of shots remaining before memory buffer fills ..... 77</p> <p>White balance recording indicator ..... 146</p> <p>Exposure compensation value ..... 132</p> <p>Flash compensation value ..... 134</p> <p>ISO sensitivity ..... 107, 239</p> <p>Capture mode indicator</p> <p><b>14</b> "k" (appears when memory remains for over 1000 exposures) ..... 46</p> <p><b>15</b> Flash-ready indicator ..... 54</p> <p><b>16</b> Flexible program indicator ..... 120</p> <p><b>17</b> Exposure indicator ..... 124</p> <p>Exposure compensation display ..... 132</p> <p>Electronic rangefinder ..... 237</p> <p><b>18</b> Flash compensation indicator... 134</p> <p><b>19</b> Exposure compensation indicator ..... 132</p> <p><b>20</b> Auto ISO sensitivity indicator .. 228</p> <p><b>21</b> Warning indicator ..... 349</p> |
|--|---|

## The **info** (Info) Button

Press the **info** button to view the information display or cycle through display options.

### ■ **Viewfinder Photography**

To view shutter speed, aperture, the number of exposures remaining, AF-area mode, and other shooting information in the monitor, press the **info** button.

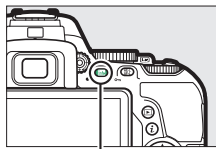

**info** button

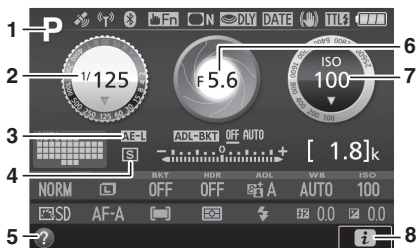

<b>1</b> Shooting mode AUTO auto/ Ⓜ auto (flash off).....47 Scene modes .....58 Special effects mode .....65 <b>P, S, A, and M</b> modes..... 118	<b>4</b> Release mode.....75
<b>2</b> Shutter speed ..... 118 Shutter-speed display ..... 121, 124	<b>5</b> Help icon ..... 349
<b>3</b> Autoexposure (AE) lock indicator ..... 130	<b>6</b> Aperture (f-number)..... 118 Aperture display ..... 122, 124
	<b>7</b> ISO sensitivity ..... 107 ISO sensitivity display..... 107, 229 Auto ISO sensitivity indicator ..... 229
	<b>8</b> <b>i</b> icon.....22

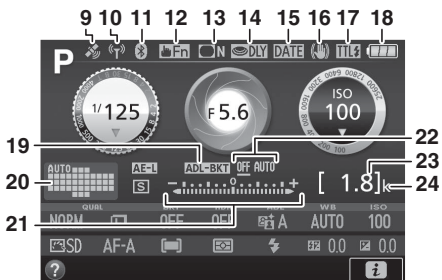

<p>9 Satellite signal indicator..... 269</p> <p>10 Wi-Fi connection indicator ..... 272</p> <p>    Eye-Fi connection indicator ..... 274</p> <p>11 Bluetooth connection indicator ..... 273</p> <p>    Airplane mode..... 271</p> <p>12 Touch Fn assignment..... 255</p> <p>13 Vignette control indicator ..... 231</p> <p>14 Exposure delay mode ..... 241</p> <p>15 Date stamp indicator ..... 243</p> <p>16 Vibration reduction indicator ..... 32, 232</p> <p>17 Flash control indicator ..... 246</p> <p>    Flash compensation indicator for     optional flash units ..... 318</p> <p>18 Battery indicator ..... 46</p> <p>19 Bracketing indicator..... 151</p>	<p>20 AF-area mode indicator ..... 87</p> <p>    Focus point..... 90, 236</p> <p>21 Exposure indicator ..... 124</p> <p>    Exposure compensation     indicator ..... 132</p> <p>    Bracketing progress     indicator ..... 154</p> <p>22 ADL bracketing amount..... 152</p> <p>23 Number of exposures     remaining..... 46</p> <p>    White balance recording     indicator ..... 146</p> <p>    Capture mode indicator</p> <p>24 "k" (appears when memory     remains for over 1000     exposures)..... 46</p>
--	--

**Note:** Display shown with all indicators lit for illustrative purposes.

### **Turning the Monitor Off**

To clear shooting information from the monitor, press the  button or press the shutter-release button halfway. The monitor will turn off automatically if no operations are performed for about 8 seconds (for information on choosing how long the monitor stays on, see **Auto off timers** on page 240). The monitor will also turn off if you cover the eye sensor or look through the viewfinder.

### **Info Display Auto Off**

The eye sensor will automatically turn the information display off if you put your eye to the viewfinder while the standby timer is active. The display will turn on again when you remove your eye from the viewfinder. If desired, you can prevent the information display turning off using the **Info display auto off** option ( 265) in the setup menu. Note, however, that regardless of the option selected the information display will turn off when the standby timer expires.

## Live View and Movie Mode

To start live view, rotate the live view switch during viewfinder photography ( 47). You can then press the **info** button to cycle through display options as shown below.

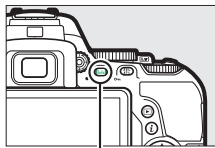

**info** button



**Show detailed photo indicators**



**Show movie indicators**  
( 164) \*



**Show basic photo indicators** \*

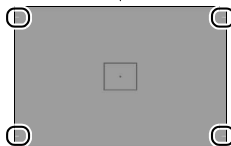

**Hide indicators** \*

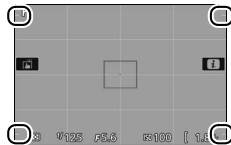

**Framing grid** \*

\* A crop showing the area recorded is displayed during movie recording; circled areas indicate the edges of the movie frame crop (the area outside the movie frame crop is grayed out when movie indicators are displayed).

## The Live View Display

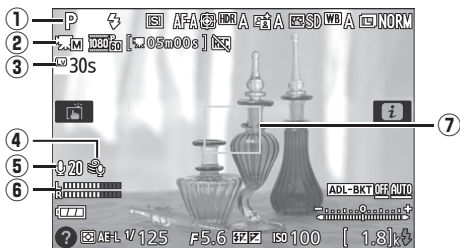

Item	Description	
① <b>Shooting mode</b>	The mode currently selected with the mode dial.	47, 58, 65, 118
② <b>Manual movie settings indicator</b>	Displayed when <b>On</b> is selected for <b>Manual movie settings</b> in mode <b>M</b> .	169
③ <b>Time remaining</b>	The amount of time remaining before live view ends automatically. Displayed if shooting will end in 30 s or less.	11
④ <b>Wind noise reduction</b>	Displayed when <b>On</b> is selected for <b>Movie settings &gt; Wind noise reduction</b> in the shooting menu.	169
⑤ <b>Microphone sensitivity</b>	Microphone sensitivity for movie recording.	169
⑥ <b>Sound level</b>	Sound level for audio recording. Displayed in red if level is too high; adjust microphone sensitivity accordingly.	169
⑦ <b>Focus point</b>	The current focus point. The display varies with the option selected for AF-area mode ( 89).	49



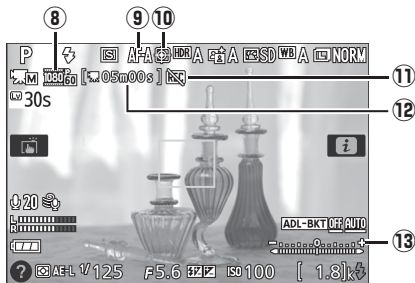

Item	Description	
8 <b>Movie frame size</b>	The frame size of movies recorded in movie mode.	168
9 <b>Focus mode</b>	The current focus mode.	83
10 <b>AF-area mode</b>	The current AF-area mode.	89
11 <b>"No movie" icon</b>	Indicates that movies can not be recorded.	—
12 <b>Time remaining (movie mode)</b>	The recording time remaining in movie mode.	165
13 <b>Exposure indicator</b>	Indicates whether the photograph would be under- or over-exposed at current settings (mode M only).	124

### ✓ The Count Down Display

A count down will be displayed 30 s before live view ends automatically (□ 10); the timer turns red 5 s before the auto off timer expires (□ 240) or if live view is about to end to protect the internal circuits. Depending on shooting conditions, the timer may appear immediately when live view is selected. Movie recording will end automatically when the timer expires, regardless of the amount of recording time available.

## The *i* Button

To change the settings at the bottom of the information display, press the *i* button, then highlight items using the multi selector and press **OK** to view options for the highlighted item. You can also change settings by pressing the *i* button during live view.

- Image quality (📖 98)
- Image size (📖 100)
- Auto bracketing (📖 151)
- HDR (high dynamic range) (📖 138)
- Active D-Lighting (📖 136)
- White balance (📖 140)
- ISO sensitivity (📖 107)
- Picture Control (📖 155)
- Focus mode (📖 82)
- AF-area mode (📖 87)
- Metering (📖 128)
- Flash mode (📖 102, 104)
- Flash compensation (📖 134)
- Exposure compensation (📖 132)

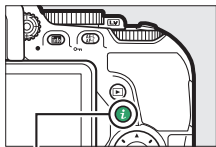

*i* button



*Viewfinder photography*

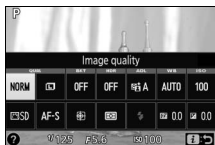

*Live view*

## The Monitor

The monitor can be angled and rotated as shown below.

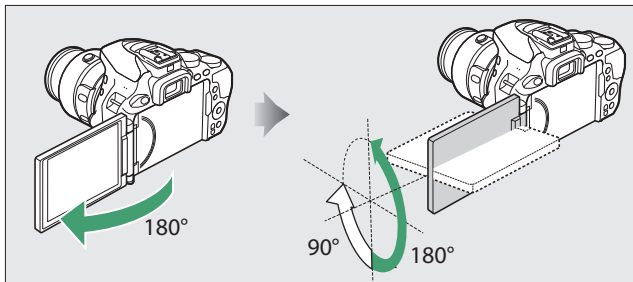

**Normal use:** Fold the monitor against the camera face out. The monitor is normally used in this position.

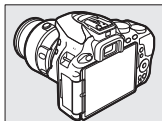

**Low-angle shots:** Tilt the monitor up to take shots in live view with the camera held low.

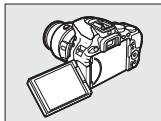

**High-angle shots:** Tilt the monitor down to take shots in live view with the camera held high.

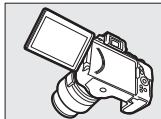

**Self-portraits:** Use for self-portraits in live view. The monitor shows a mirror image of what will appear in the final picture.

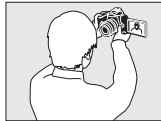
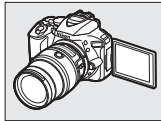

 **Using the Monitor**

Rotate the monitor gently within the limits shown. *Do not use force.* Failure to observe these precautions could damage the camera or monitor. To protect the monitor when the camera is not in use, fold it back face down against the camera body.

Do not lift or carry the camera by the monitor. Failure to observe this precaution could damage the camera.

## **Using the Touch Screen**

The touch-sensitive monitor supports the following operations:

---

### **Flick**

Flick a finger a short distance left or right across the monitor.

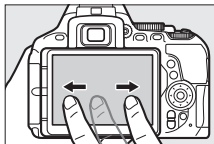

### **Slide**

Slide a finger over the monitor.

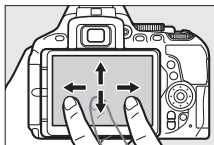

### **Stretch/Pinch**

Place two fingers on the monitor and move them apart or pinch them together.

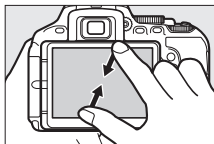
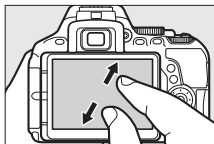

### ✔ The Touch Screen

The touch screen responds to static electricity and may not respond when covered with third-party protective films or when touched with fingernails or gloved hands. Do not use excessive force or touch the screen with sharp objects.

### ✔ Using the Touch Screen

The touch screen may not respond as expected if you attempt to operate it while leaving your palm or another finger resting on it in second location. It may not recognize other gestures if your touch is too soft, your fingers are moved too quickly or too short a distance or do not remain in contact with the screen, or if the movement of the two fingers in a pinch or stretch is not correctly coordinated.

### ✔ Enabling or Disabling Touch Controls

Touch controls can be enabled or disabled using the **Touch controls** option in the setup menu (📖 263). Select **Enable** to enable touch controls for shooting, playback, and menu navigation or **Playback only** to enable touch controls for playback only.

## Touch-Screen Photography

Tap icons in the shooting display to adjust camera settings (note that not all icons will respond to touch-screen operations). During live view, you can also take photographs by tapping the monitor.

### ■ **Viewfinder Photography**

Use the touch screen to adjust settings in the information display (□ 6).

#### **Scene/Effect Selection**

In scene and special effects modes (□ 58, 65), you can tap the shooting mode icon to choose a scene or effect. Tap ◀ or ▶ to view the different options and tap an icon to select and return to the previous display.



#### **Shutter Speed and Aperture**

In modes **S**, **A**, and **M**, you can tap the ◀▶ icon next to the shutter speed or aperture displays to view ◀ and ▶ controls, which you can tap to choose a new value. Tap ↵ to exit when the operation is complete.

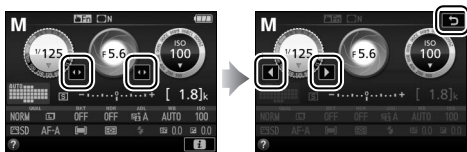

## Shooting Options

To change camera settings (📖 12), tap the **i** icon at the bottom right corner of the display and then tap icons to display options for the corresponding setting. Tap the desired option to select it and return to the previous display.

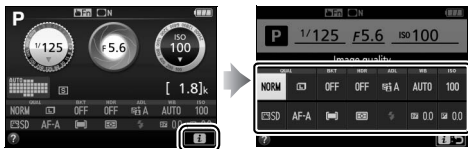

If prompted to choose a value as shown at right, edit the value by tapping ▲ or ▼ and then tap the number or tap **OK** to select it and return to the previous display.



To exit without changing settings, tap **i** ↶.





## ■ ■ Live View Photography

Use the touch screen to take photographs and adjust settings.

### Taking Photographs (Touch Shutter)

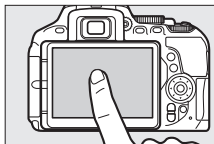
Touch your subject in the monitor to focus. Focus locks until you lift your finger from the monitor to take the photograph (note that the touch shutter can not be used to focus when **MF**—manual focus—is selected for focus mode). For more information on touch focus, see page 83.



To disable the touch shutter, tap the icon at right. The icon will change to , indicating that the shutter will no longer be released when you lift your finger from the monitor.



The touch shutter remains off () during movie recording, but you can refocus at any time by touching your subject in the monitor.

### ✓ Taking Pictures Using Touch Shooting Options

The shutter-release button can be used to focus and take pictures even when the  icon is displayed to show that touch shooting options are active. Use the shutter-release button to take photographs in continuous shooting mode (☞ 76) and during movie recording. Touch shooting options can be used only to take pictures one at a time in continuous shooting mode and can not be used to take photographs during movie recording.

In self-timer mode (☞ 79), focus locks on the selected subject when you touch the monitor and the timer starts when you lift your finger from the screen. At default settings, the shutter is released about 10 s after the timer starts; the delay and number of shots can be changed using Custom Setting c3 (**Self-timer**, ☞ 241). If the option selected for **Number of shots** is greater than 1, the camera will automatically take pictures one after the other until the selected number of shots is recorded.

## Scene/Effect Selection

In scene and special effects modes (☰ 58, 65), you can tap the shooting mode icon to choose a scene or effect. Tap ◀ or ▶ to view the different options and tap an icon to select and return to the previous display.

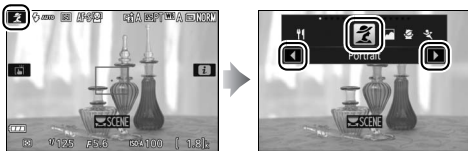

## Shutter Speed and Aperture

In modes **S**, **A**, and **M**, tapping the shutter speed or aperture displays ◀ and ▶ controls, which you can tap to choose a new value. Tap ↻ to exit when the operation is complete.

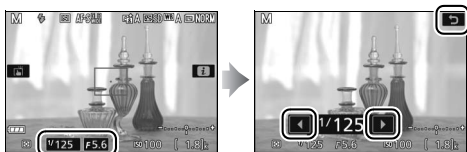

## Shooting Options

In live view, pressing the **i** button or tapping the **i** icon in the monitor activates the information display (12, 166). Tap a setting to view options and then tap the desired option to select it and return to live view.

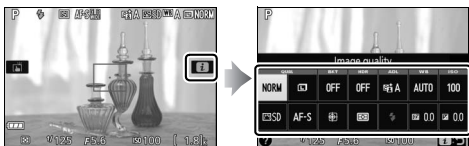

If prompted to choose a value as shown at right, edit the value by tapping **▲** or **▼** and then tap the number or tap **OK** to select it and return to the previous display.

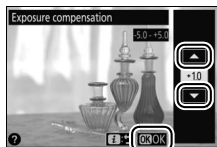

To exit without changing settings, tap **i** or **⏪**.

## Viewing Pictures

The touch screen can be used for the following playback operations (☞ 56, 184).

**View other images**

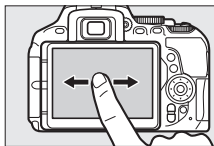

Flick left or right to view other images.

**Scroll rapidly to other images**

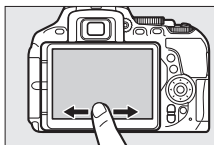

*Frame advance bar*

In full frame view, you can touch the bottom of the display to display a frame advance bar, then slide your finger left or right to scroll rapidly to other images.

**Zoom in (photos only)**

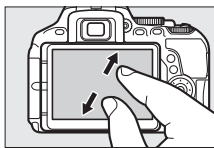

Use stretch and pinch gestures to zoom in and out and slide to scroll (☞ 196).

## View thumbnails

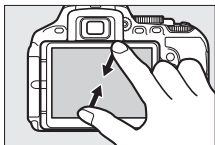

To “zoom out” to a thumbnail view (📖 185), use a pinch gesture in full-frame playback. Use pinch and stretch to choose the number of images displayed from 4, 12, or 80 frames.

## View movies



### Guide



Tap the on-screen guide to start movie playback (movies are indicated by a 🎬 icon). Tap the display to pause or resume, or tap ⏪ to exit to full-frame playback (note that some of the icons in the movie playback display do not respond to touch-screen operations).

## Using the Menus

The touch screen can be used for the following menu operations.

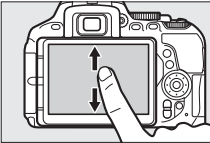
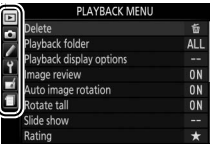
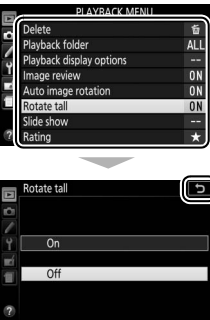
<b>Scroll</b>		Slide up or down to scroll.																								
<b>Choose a menu</b>	 <table border="1"><thead><tr><th colspan="2">PLAYBACK MENU</th></tr></thead><tbody><tr><td>Delete</td><td>🗑️</td></tr><tr><td>Playback folder</td><td>ALL</td></tr><tr><td>Playback display options</td><td>--</td></tr><tr><td>Image review</td><td>ON</td></tr><tr><td>Auto image rotation</td><td>ON</td></tr><tr><td>Rotate tall</td><td>ON</td></tr><tr><td>Slide show</td><td>--</td></tr><tr><td>Rating</td><td>★</td></tr></tbody></table>	PLAYBACK MENU		Delete	🗑️	Playback folder	ALL	Playback display options	--	Image review	ON	Auto image rotation	ON	Rotate tall	ON	Slide show	--	Rating	★	Tap a menu icon to choose a menu.						
PLAYBACK MENU																										
Delete	🗑️																									
Playback folder	ALL																									
Playback display options	--																									
Image review	ON																									
Auto image rotation	ON																									
Rotate tall	ON																									
Slide show	--																									
Rating	★																									
<b>Select options/adjust settings</b>	 <table border="1"><thead><tr><th colspan="2">PLAYBACK MENU</th></tr></thead><tbody><tr><td>Delete</td><td>🗑️</td></tr><tr><td>Playback folder</td><td>ALL</td></tr><tr><td>Playback display options</td><td>--</td></tr><tr><td>Image review</td><td>ON</td></tr><tr><td>Auto image rotation</td><td>ON</td></tr><tr><td>Rotate tall</td><td>ON</td></tr><tr><td>Slide show</td><td>--</td></tr><tr><td>Rating</td><td>★</td></tr></tbody></table> <table border="1"><thead><tr><th colspan="2">Rotate tall</th></tr></thead><tbody><tr><td>On</td><td>☑️</td></tr><tr><td>Off</td><td></td></tr></tbody></table>	PLAYBACK MENU		Delete	🗑️	Playback folder	ALL	Playback display options	--	Image review	ON	Auto image rotation	ON	Rotate tall	ON	Slide show	--	Rating	★	Rotate tall		On	☑️	Off		Tap menu items to display options and tap icons or sliders to change. To exit without changing settings, tap ↩.
PLAYBACK MENU																										
Delete	🗑️																									
Playback folder	ALL																									
Playback display options	--																									
Image review	ON																									
Auto image rotation	ON																									
Rotate tall	ON																									
Slide show	--																									
Rating	★																									
Rotate tall																										
On	☑️																									
Off																										

# First Steps

## Attach the Camera Strap

Attach the strap securely to the two camera eyelets.

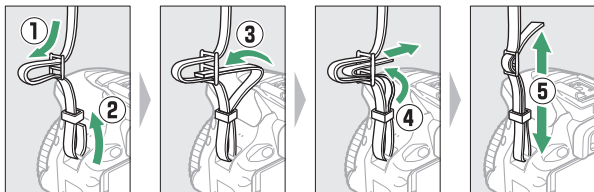

## Charge the Battery

If a plug adapter is supplied, raise the wall plug and connect the plug adapter as shown below at left, making sure the plug is fully inserted. Insert the battery and plug the charger in. An exhausted battery will fully charge in about an hour and 50 minutes.

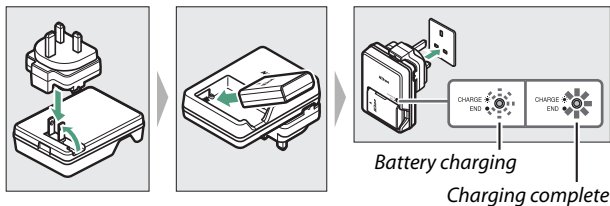

### **✓ The Battery and Charger**

Read and follow the warnings and cautions on pages xiii–xvi and 333–337 of this manual.



## **Insert the Battery and a Memory Card**

Before inserting or removing the battery or memory cards, confirm that power switch is in the **OFF** position. Insert the battery as shown, using the battery to keep the orange battery latch pressed to one side. The latch locks the battery in place when the battery is fully inserted.

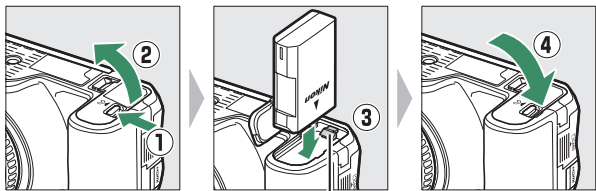

*Battery latch*

Holding the memory card in the orientation shown, slide it in until it clicks into place.

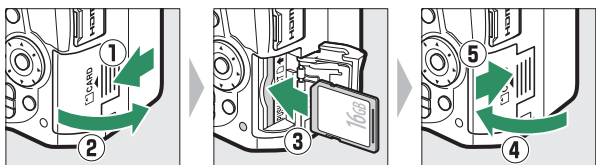

### **The Clock Battery**

The camera clock is powered by an independent, rechargeable power source, which is charged as necessary when the main battery is installed. Three days of charging will power the clock for about a month. If a message warning that the clock is not set is displayed when the camera is turned on, the clock battery is exhausted and the clock has been reset. Set the clock to the correct time and date.

## ■ Removing the Battery and Memory Cards

### Removing the Battery

To remove the battery, turn the camera off and open the battery-chamber cover. Press the battery latch in the direction shown by the arrow to release the battery and then remove the battery by hand.

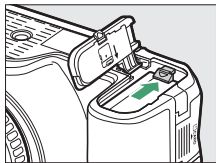

### Removing Memory Cards

After confirming that the memory card access lamp is off, turn the camera off, open the memory card slot cover, and press the card in to eject it (①). The card can then be removed by hand (②).

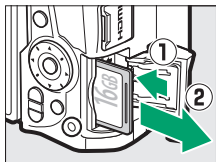

### ✓ Memory Cards

- Memory cards may be hot after use. Observe due caution when removing memory cards from the camera.
- Do not remove memory cards from the camera, turn the camera off, or remove or disconnect the power source during formatting or while data are being recorded, deleted, or copied to a computer. Failure to observe these precautions could result in loss of data or in damage to the camera or card.
- Do not touch the card terminals with your fingers or metal objects.
- Do not bend, drop, or subject to strong physical shocks.
- Do not apply force to the card casing. Failure to observe this precaution could damage the card.
- Do not expose to water, heat, high levels of humidity, or direct sunlight.
- Do not format memory cards in a computer.

## **Open the Monitor**

Open the monitor as shown. *Do not use force.*

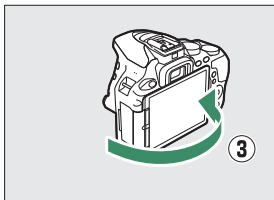
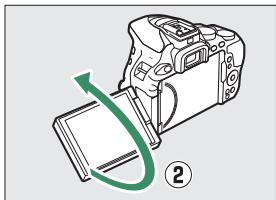
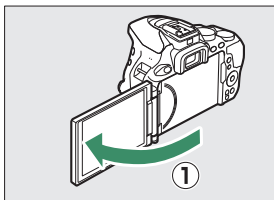
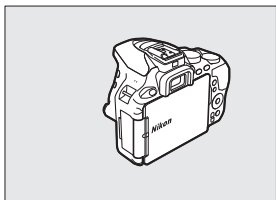

## **Attach a Lens**

Be careful to prevent dust from entering the camera when the lens or body cap is removed. The lens generally used in this manual for illustrative purposes is an AF-P DX NIKKOR 18–55mm f/3.5–5.6G VR.

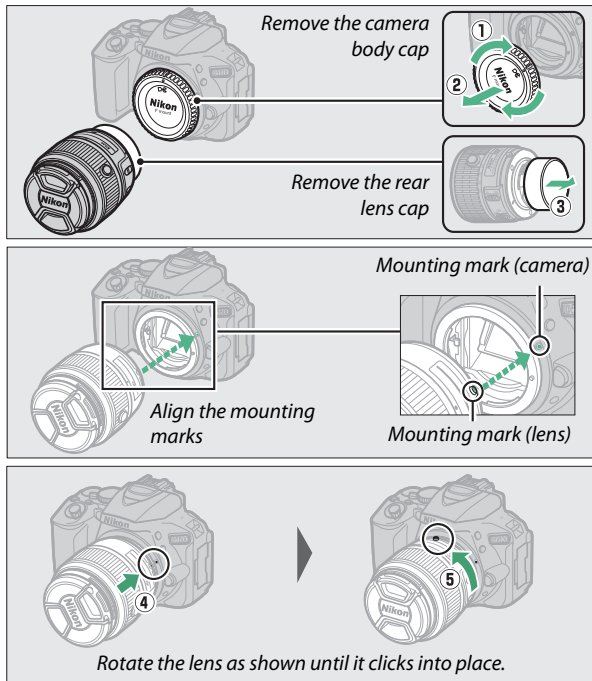

Be sure to remove the lens cap before taking pictures.

### ✔ Lenses with Retractable Lens Barrel Buttons

Before using the camera, unlock and extend the lens. Keeping the retractable lens barrel button pressed (①), rotate the zoom ring as shown (②).

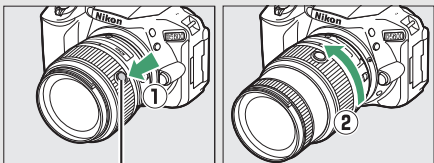

*Retractable lens barrel button*

Pictures can not be taken when the lens is retracted; if an error message is displayed as a result of the camera having been turned on with the lens retracted, rotate the zoom ring until the message is no longer displayed.



### ✔ Detaching the Lens

Be sure the camera is off when removing or exchanging lenses. To remove the lens, press and hold the lens release button (①) while turning the lens clockwise (②). After removing the lens, replace the lens caps and camera body cap.

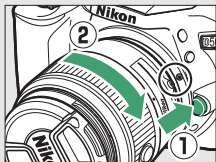

### ✔ A-M, M/A-M, and A/M-M Switches

When using autofocus with a lens equipped with an **A-M** mode switch, slide the switch to **A** (if the lens has an **M/A-M** or **A/M-M** switch, select **M/A** or **A/M**). For information on other lenses that can be used with this camera, see page 305.



### **Vibration Reduction (VR)**

Vibration reduction can be enabled by selecting **On** for **Optical VR** in the shooting menu (☰ 232), if the lens supports this option, or by sliding the lens vibration reduction switch to **ON**, if the lens is equipped with a vibration reduction switch. A vibration reduction indicator appears in the information display when vibration reduction is on.



### **Retracting Lenses with Retractable Lens Barrel Buttons**

To retract the lens when the camera is not in use, press and hold the retractable lens barrel button (①) and rotate the zoom ring to the "L" (lock) position as shown (②). Retract the lens before removing it from the camera, and be careful not to press the retractable lens barrel button when attaching or removing the lens.

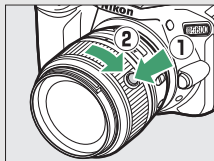

## **Camera Setup**

### **■ ■ Setup Using a Smartphone or Tablet**

Before proceeding, check the camera to ensure that the battery is fully charged and the memory card has space available. On your smartphone or tablet (below “smart device”), install the SnapBridge app as described inside the front cover and enable Bluetooth and Wi-Fi. Note that the actual connection to the camera will be made using the SnapBridge app; do not use Bluetooth settings in the settings app on your smart device. The instructions that follow refer to version 2.0 of the SnapBridge app; for information on the latest version, see the *SnapBridge Connection Guide* (pdf), available for download from the following website:



<http://downloadcenter.nikonimglib.com>

The actual camera and smart device displays may differ from those shown below.

- 1 Camera:** Turn the camera on. A language-selection dialog will be displayed.

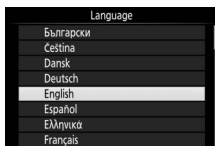

Use the multi selector and **OK** button to navigate the menus.

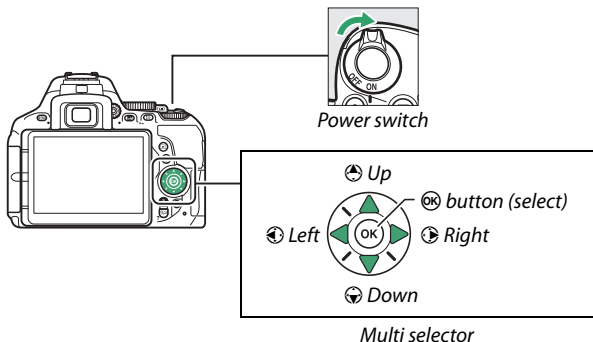

Press **Up** and **Down** to highlight a language and press **OK** to select. The language can be changed at any time using the **Language** option in the setup menu.



- 2 Camera:** When the dialog at right is displayed, press **OK**. If the dialog at right is not displayed or if you wish to configure the camera again, highlight **Connect to smart device** in the setup menu and press **OK**. If you do not wish to use a smart device to configure the camera, set the clock manually (☞ 40).

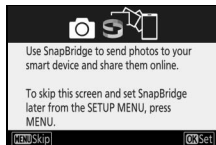

- 3 Camera/smart device:** Start pairing.

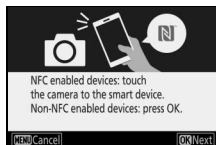

- **Android devices with NFC support:** After checking that NFC is enabled on the smart device, touch the camera **N** (N-Mark) to the NFC antenna on the smart device to launch the SnapBridge app, and then follow the on-screen instructions before proceeding to Step 7. If the SnapBridge download site is displayed, download and install the app before repeating the above steps.
- **iOS devices and Android devices without NFC support:** Press the camera **OK** button to ready the camera for pairing.

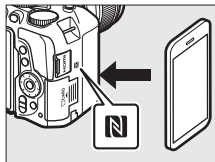

- 
- 4 Camera:** Confirm that the camera displays the message shown at right and ready the smart device.

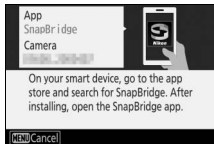

- 
- 5 Smart device:** Launch the SnapBridge app and tap **Pair with camera**. If prompted to choose a camera, tap the camera name.



- 
- 6 Smart device:** Tap the camera name in the “Pair with camera” dialog. Users who are pairing a camera with an iOS device for the first time will first be presented with pairing instructions; after reading the instructions, scroll to the bottom of the display and tap **Understood**. If you are then prompted to choose an accessory, tap the camera name again (there may be some delay before the camera name is displayed).



- 
- 7** Camera/smart device: Confirm that the camera and smart device display the same six-digit number. Some versions of iOS may not display a number; if no number displayed, proceed to Step 8.



- 
- 8** Camera/smart device: Press **OK** on the camera and tap **PAIR** on the smart device (the display varies with the device and operating system).

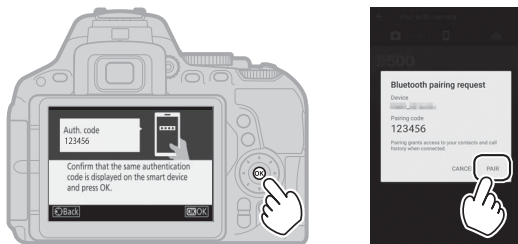

---

## 9 Camera/smart device: Complete pairing.

- **Camera:** Press **OK** when the message at right is displayed.



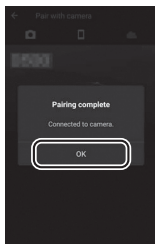

- **Smart device:** Tap **OK** when the message at right is displayed.



---

## 10 Camera: Follow the on-screen instructions to complete setup.

- **To allow the camera to add location data to photos**, select **Yes** in response to "Download location data from smart device?" and then enable location services on the smart device and enable **Auto link options > Synchronize location data** in the SnapBridge app  tab.
- **To synchronize the camera clock with the time provided by the smart device**, select **Yes** in response to "Sync clock with smart device?" and then enable **Auto link options > Synchronize clocks** in the SnapBridge app  tab.

*The smart device and camera are now connected. Any pictures you take with the camera will automatically be uploaded to the smart device.*

## ■ ■ Setup from the Camera Menus

The camera clock can be set manually.

### 1 Turn the camera on.

A language-selection dialog will be displayed.



Use the multi selector and **OK** button to navigate the menus.

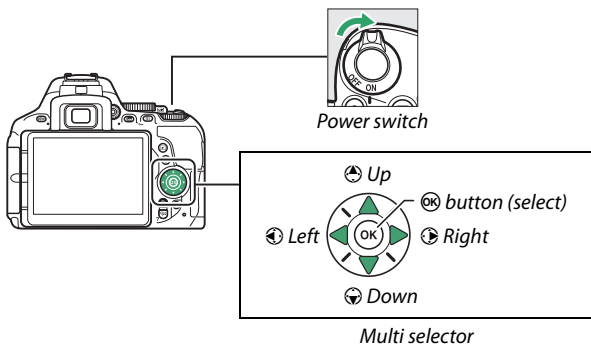

Press **Up** and **Down** to highlight a language and press **OK** to select. The language can be changed at any time using the **Language** option in the setup menu.

- 2** Press MENU when the dialog at right is displayed.

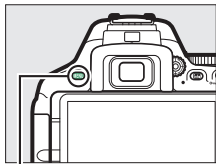

**MENU** button

- 3** Set the camera clock.

Use the multi selector and **OK** button to set the camera clock.

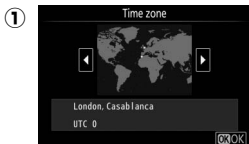

Select time zone

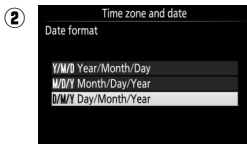

Select date format

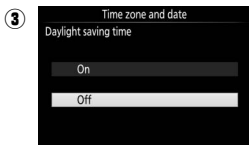

Select daylight saving time option

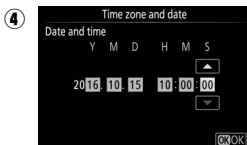

Set time and date (note that the camera uses a 24-hour clock)

The clock can be adjusted at any time using the **Time zone and date** > **Date and time** option in the setup menu.

## **Focus the Viewfinder**

After removing the lens cap, rotate the diopter adjustment control until the AF area brackets are in sharp focus. When operating the control with your eye to the viewfinder, be careful not to put your fingers or fingernails in your eye.

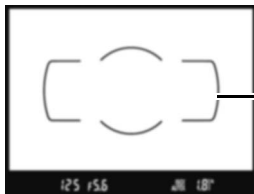
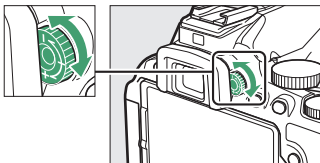

*Viewfinder not in focus*

*AF area  
brackets*

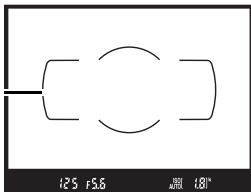

*Viewfinder in focus*

The camera is now ready for use. Proceed to page 47 for information on taking photographs.

# Tutorial

## Camera Menus: An Overview

Most shooting, playback, and setup options can be accessed from the camera menus. To view the menus, press the **MENU** button.

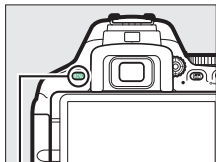

MENU button

### Tabs

Choose from the following menus:

- : Playback (📖 220)
- : Shooting (📖 223)
- : Custom Settings (📖 233)
- : Setup (📖 257)
- : Retouch (📖 277)
- : Recent settings or My Menu (defaults to **Recent settings**; 📖 300)

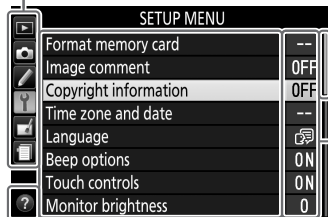

Slider shows position in current menu.

Current settings are shown by icons.

### Menu options

Options in current menu.

Help icon (📖 43)





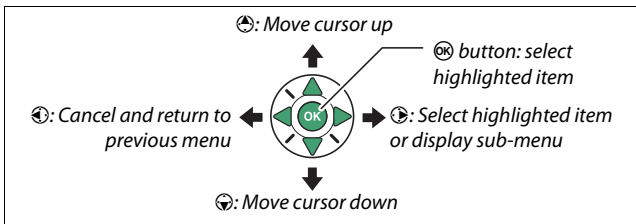

## Using Camera Menus

### Menu Controls

The multi selector and  button are used to navigate the camera menus.



### The (Help) Icon

If a  icon is displayed at the bottom left corner of the monitor, a description of the currently selected option or menu can be displayed by pressing the  (?). Press  or  to scroll through the display. Press  (?) again to return to the menus.

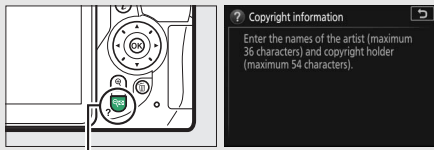

 (?) button

## ■ Navigating the Menus

Follow the steps below to navigate the menus.

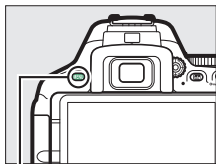

- 1 Display the menus.**  
Press the **MENU** button to display the menus.





MENU button

- 2 Highlight the icon for the current menu.**  
Press  to highlight the icon for the current menu.

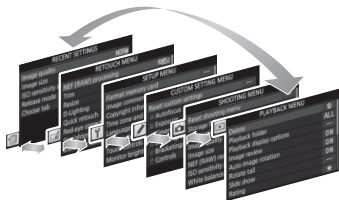

- 3 Select a menu.**  
Press  or  to select the desired menu.



- 4 Position the cursor in the selected menu.**  
Press  to position the cursor in the selected menu.

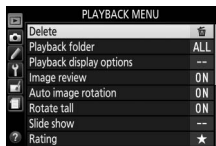

## 5 Highlight a menu item.

Press or to highlight a menu item.



## 6 Display options.

Press to display options for the selected menu item.

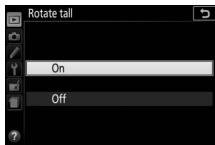

## 7 Highlight an option.

Press or to highlight an option.

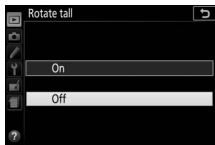

## 8 Select the highlighted item.

Press to select the highlighted item. To exit without making a selection, press the MENU button.



Note the following:

- Menu items that are displayed in gray are not currently available.
- While pressing generally has the same effect as pressing , there are some cases in which selection can only be made by pressing .
- To exit the menus and return to shooting mode, press the shutter-release button halfway ( 52).

## The Battery Level and Number of Exposures Remaining

Press the **info** button and check the battery level and number of exposures remaining in the information display.

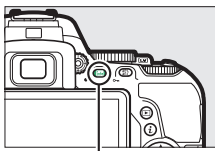

**info** button



Number of exposures remaining

### Battery Level

If the battery is low, a warning will also be displayed in the viewfinder. If the information display does not appear when the **info** button is pressed, the battery is exhausted and needs to be recharged.





Information display	Viewfinder	Description
	—	Battery fully charged.
	—	Battery partially discharged.
		Low battery. Ready fully-charged spare battery or prepare to charge battery.
 (flashes)	 (flashes)	Battery exhausted. Charge battery.

### Number of Exposures Remaining



Values over 1000 are shown in thousands, indicated by the letter "k".

# Basic Photography and Playback

## “Point-and-Shoot” Modes (AUTO and )

This section describes how to take photographs in  and  modes.  and  are automatic “point-and-shoot” modes in which the majority of settings are controlled by the camera in response to shooting conditions; the only difference between the two is that the flash will not fire in  mode.



- 1 Rotate the mode dial to  or .

Mode dial

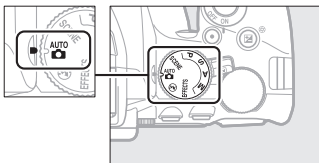

Photographs can be framed in the viewfinder or in the monitor (live view). To start live view, rotate the live view switch.

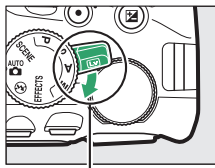

Live view switch



Framing pictures in the viewfinder



Framing pictures in the monitor (live view)

## 2 Ready the camera.

**Viewfinder photography:** When framing photographs in the viewfinder, hold the handgrip in your right hand and cradle the camera body or lens with your left. Bring your elbows in against the sides of your chest.



**Live view:** When framing photographs in the monitor, hold the handgrip in your right hand and cradle the lens with your left.

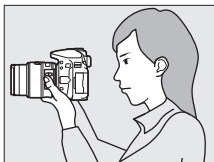

### Framing Photographs in Portrait (Tall) Orientation

When framing photographs in portrait (tall) orientation, hold the camera as shown below.



*Framing photographs in the viewfinder*



*Framing photographs in the monitor*

### 3 Frame the photograph.

**Viewfinder photography:** Frame a photograph in the viewfinder with the main subject in the AF area brackets.

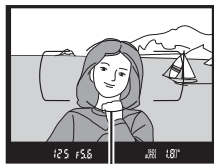

*AF area brackets*

**Live view:** At default settings, the camera automatically detects faces and selects the focus point. If no face is detected, the camera will focus on subjects near the center of the frame.

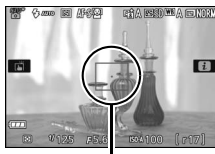

*Focus point*

#### Using a Zoom Lens

Before focusing, rotate the zoom ring to adjust the focal length and frame the photograph. Use the zoom ring to zoom in on the subject so that it fills a larger area of the frame, or zoom out to increase the area visible in the final photograph (select longer focal lengths on the lens focal length scale to zoom in, shorter focal lengths to zoom out).

*Zoom in*

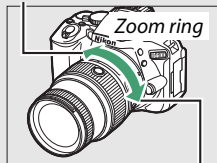

*Zoom out*

## 4 Press the shutter-release button halfway.

**Viewfinder photography:** Press the shutter-release button halfway to focus (if the subject is poorly lit, the flash may pop up and the AF-assist illuminator may light). When the focus operation is complete, a beep will sound (a beep may not sound if the subject is moving) and the active focus point and in-focus indicator (●) will appear in the viewfinder.

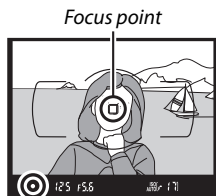

*In-focus indicator*

In-focus indicator	Description
●	Subject in focus.
● (flashes)	Camera unable to focus using autofocus. See page 86.

**Live view:** The focus point flashes green while the camera focuses. If the camera is able to focus, the focus point will be displayed in green; otherwise, the focus point will flash red.





## 5 Shoot.

Smoothly press the shutter-release button the rest of the way down to take the photograph. The memory card access lamp will light and the photograph will be displayed in the monitor for a few seconds. *Do not eject the memory card or remove or disconnect the power source until the lamp has gone out and recording is complete.*

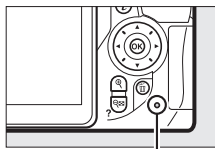

Memory card access lamp



Rotate the live view switch to exit live view.

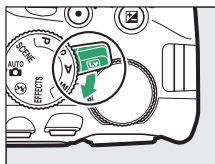

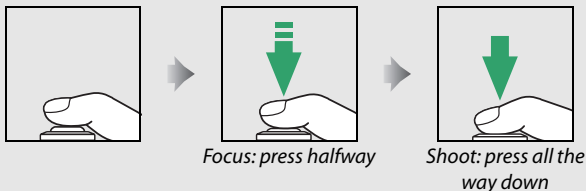

## The Shutter-Release Button

The camera has a two-stage shutter-release button. The camera focuses when the shutter-release button is pressed halfway. To take the photograph, press the shutter-release button the rest of the way down.











Pressing the shutter-release button halfway also ends playback and readies the camera for immediate use.

## Automatic Scene Selection (Scene Auto Selector)

If live view is selected in  or  mode, the camera will automatically analyze the subject and select the appropriate shooting mode when the shutter-release button is pressed halfway to focus using autofocus. The selected mode is shown in the monitor.



	<b>Portrait</b>	Human portrait subjects
	<b>Landscape</b>	Landscapes and cityscapes
	<b>Close up</b>	Subjects close to the camera
	<b>Night portrait</b>	Portrait subjects framed against a dark background
	<b>Auto</b>	Subjects suited to  or  mode or that do not fall into the categories listed above
	<b>Auto (flash off)</b>	

### ✔ The Standby Timer (Viewfinder Photography)

The viewfinder display will turn off if no operations are performed for about eight seconds, reducing the drain on the battery. Press the shutter-release button halfway to reactivate the display. The length of time before the standby timer expires automatically can be selected using Custom Setting c2 (**Auto off timers**;  240).

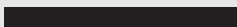

*Exposure meters off*

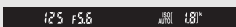



*Exposure meters on*

### ✔ The Standby Timer (Live View)

The monitor will turn off if no operations are performed for about ten minutes. The length of time before the monitor turns off automatically can be selected using Custom Setting c2 (**Auto off timers**;  240).

### ✔ Live View Zoom Preview

To magnify the view in the monitor up to about 8.3× for precise focus, press the  button. While the view through the lens is zoomed in, a navigation window will appear in a gray frame at the bottom right corner of the display. Use the multi selector to scroll to areas of the frame not visible in the monitor, or press  (?) to zoom out.

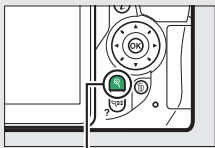

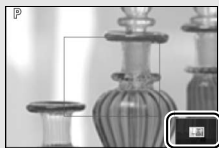

 button



*Navigation window*

### The Built-in Flash

If additional lighting is required for correct exposure in  mode, the built-in flash will pop up automatically when the shutter-release button is pressed halfway ( 101). If the flash is raised, photographs can only be taken when the flash-ready indicator () is displayed. If the flash-ready indicator is not displayed, the flash is charging; remove your finger briefly from the shutter-release button and try again.

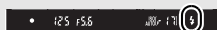
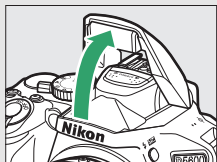

When the flash is not in use, return it to its closed position by pressing it gently downward till the latch clicks into place.

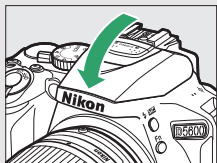

### Exposure

Depending on the scene, exposure may differ from that which would be obtained when live view is not used.

### ✓ Shooting in Live View Mode

Although they will not appear in the final picture, jagged edges, color fringing, moiré, and bright spots may appear in the monitor, while bright regions or bands may appear in some areas with flashing signs and other intermittent light sources or if the subject is briefly illuminated by a strobe or other bright, momentary light source. In addition, distortion may occur with moving subjects, particularly if the camera is panned horizontally or an object moves horizontally at high speed through the frame. Flicker and banding visible in the monitor under fluorescent, mercury vapor, or sodium lamps can be reduced using **Flicker reduction** (☐ 268), although they may still be visible in the final photograph at some shutter speeds. Avoid pointing the camera at the sun or other strong light sources. Failure to observe this precaution could result in damage to the camera's internal circuitry.

Live view ends automatically when the monitor is closed (closing the monitor does not end live view on televisions or other external displays).

To prevent light entering via the viewfinder from appearing in the photograph or interfering with exposure, we recommend that you cover the viewfinder with your hand or other objects such as an optional eyepiece cap before taking pictures without your eye to the viewfinder (☐ 80).

### ✓ HDMI

When the camera is attached to an HDMI video device, the video device will display the view through the lens. If the device supports HDMI-CEC, select **Off** for the **HDMI > Device control** option in the setup menu (☐ 219) before shooting in live view.

## Basic Playback

### 1 Press the button.

A photograph will be displayed in the monitor.

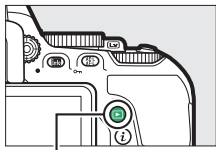

 button

### 2 View additional pictures.

Additional pictures can be displayed by pressing  or



To end playback and return to shooting mode, press the shutter-release button halfway.

## Deleting Unwanted Photographs

To delete the photograph currently displayed in the monitor, press the  button. *Note that photographs can not be recovered once deleted.*

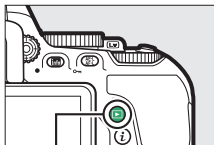

### 1 Display the photograph.

Display the photograph you wish to delete.



 button

### 2 Delete the photograph.

Press the  button. A confirmation dialog will be displayed; press the  button again to delete the image and return to playback.

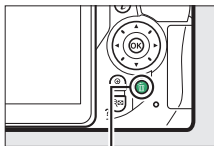

 button



#### Delete

The **Delete** option in the playback menu can be used to delete multiple images ( 206).

# Matching Settings to the Subject or Situation (Scene Mode)

The camera offers a choice of “scene” modes. Choosing a scene mode automatically optimizes settings to suit the selected scene, making creative photography as simple as selecting a mode, framing a picture, and shooting as described on page 47.

The following scenes can be selected by rotating the mode dial to **SCENE** and rotating the command dial until the desired scene appears in the monitor.

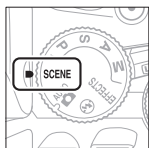

Mode dial

+

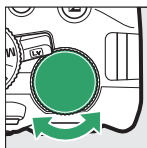

Command dial



Monitor

---

 Portrait

---

 Landscape

---

 Child

---

 Sports

---

 Close up

---

 Night Portrait

---

 Night Landscape

---

 Party/Indoor

---

 Beach/Snow

---

 Sunset

---

 Dusk/Dawn

---

 Pet Portrait

---

 Candlelight

---

 Blossom

---

 Autumn Colors

---

 Food

---



## **Portrait**



Use for portraits with soft, natural-looking skin tones. If the subject is far from the background or a telephoto lens is used, background details will be softened to lend the composition a sense of depth.

## **Landscape**

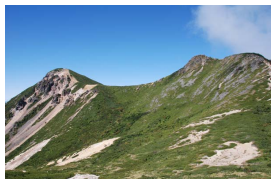

Use for vivid landscape shots in daylight.

### **Note**

The built-in flash and AF-assist illuminator turn off.

## **Child**



Use for snapshots of children. Clothing and background details are vividly rendered, while skin tones remain soft and natural.



Fast shutter speeds freeze motion for dynamic sports shots in which the main subject stands out clearly.

 **Note**

The built-in flash and AF-assist illuminator turn off.

 **Close up**

---



Use for close-up shots of flowers, insects, and other small objects (a macro lens can be used to focus at very close ranges).

 **Night Portrait**

---

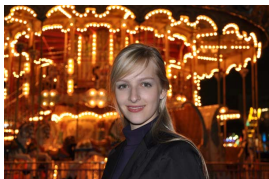

Use for a natural balance between the main subject and the background in portraits taken under low light.

## **Night Landscape**

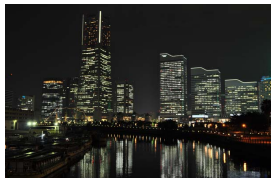

Reduce noise and unnatural colors when photographing night landscapes, including street lighting and neon signs.

### **Note**

The built-in flash and AF-assist illuminator turn off.

## **Party/Indoor**



Capture the effects of indoor background lighting. Use for parties and other indoor scenes.

## **Beach/Snow**



Capture the brightness of sunlit expanses of water, snow, or sand.

### **Note**

The built-in flash and AF-assist illuminator turn off.

## **Sunset**

---

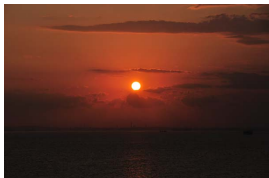

Preserves the deep hues seen in sunsets and sunrises.

### **Note**

The built-in flash and AF-assist illuminator turn off.

## **Dusk/Dawn**

---



Preserves the colors seen in the weak natural light before dawn or after sunset.

### **Note**

The built-in flash and AF-assist illuminator turn off.

## **Pet Portrait**

---



Use for portraits of active pets.

### **Note**

The AF-assist illuminator turns off.

## **Candlelight**

---



For photographs taken by candlelight.

### **Note**

The built-in flash turns off.

## **Blossom**

---



Use for fields of flowers, orchards in bloom, and other landscapes featuring expanses of blossoms.

### **Note**

The built-in flash turns off.

## **Autumn Colors**

---



Captures the brilliant reds and yellows in autumn leaves.



### **Note**

The built-in flash turns off.



Use for vivid photographs of food.

 **Note**

For flash photography, press the  () button to raise the flash ( 103).

 **Preventing Blur**

Use a tripod to prevent blur caused by camera shake at slow shutter speeds.

# Special Effects

Special effects can be used when taking photographs and shooting movies.

The following effects can be selected by rotating the mode dial to **EFFECTS** and rotating the command dial until the desired option appears in the monitor.

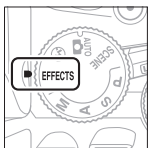

Mode dial

+

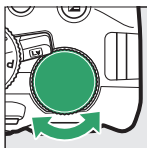

Command dial



Monitor

---

 Night Vision

---

 Miniature Effect

---

 Super Vivid

---

 Selective Color

---

 Pop

---

 Silhouette

---

 Photo Illustration

---

 High Key

---

 Toy Camera Effect

---

 Low Key

---

## **Night Vision**

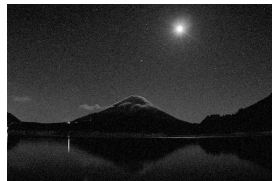

Use under conditions of darkness to record monochrome images at high ISO sensitivities.

### **Note**

Autofocus is available in live view only; manual focus can be used if the camera is unable to focus. The built-in flash and AF-assist illuminator turn off.

## **VI** *Super Vivid*

---



Overall saturation and contrast are increased for a more vibrant image.

## **POP** *Pop*

---



Overall saturation is increased for a more lively image.

## **Photo Illustration**

---



Sharpen outlines and simplify coloring for a poster effect that can be adjusted in live view (📖 70).

### **Note**

Movies shot in this mode play back like a slide show made up of a series of stills.



## **Toy Camera Effect**

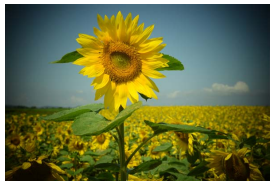

Create photos and movies that appear to have been shot with a toy camera. The effect can be adjusted in live view ( 71).

## **Miniature Effect**



Create photos that appear to be pictures of dioramas. Works best when shooting from a high vantage point. Miniature effect movies play back at high speed, compressing about 45 minutes of footage shot at 1920 × 1080/30p into a movie that plays back in about three minutes. The effect can be adjusted in live view ( 72).

### **Note**

Sound is not recorded with movies. The built-in flash and AF-assist illuminator turn off.

## **Selective Color**



All colors other than the selected colors are recorded in black and white. The effect can be adjusted in live view ( 73).

### **Note**

The built-in flash turns off.

## Silhouette

---



Silhouette subjects against bright backgrounds.

### Note

The built-in flash turns off.

## High Key

---



Use with bright scenes to create bright images that seem filled with light.

### Note

The built-in flash turns off.

## Low Key

---







Use with dark scenes to create dark, low-key images with prominent highlights.

### Note

The built-in flash turns off.

### NEF (RAW)

NEF (RAW) recording is not available in , **VI**, **POP**, , , , and  modes. Pictures taken when an NEF (RAW) or NEF (RAW)+JPEG option is selected in these modes will be recorded as JPEG images. JPEG images created at settings of NEF (RAW)+JPEG will be recorded at the selected JPEG quality, while images recorded at a setting of NEF (RAW) will be recorded as fine-quality images.

### and Modes

Autofocus is not available during movie recording. The live view refresh rate will drop, together with the frame rate for continuous release modes; using autofocus during live view photography will disrupt the preview.

### Preventing Blur

Use a tripod to prevent blur caused by camera shake at slow shutter speeds.

## Options Available in Live View

Settings for the selected effect are adjusted in the live view display.

### ■ ■ *Photo Illustration*

#### 1 Select live view.

Rotate the live view switch. The view through the lens will be displayed in the monitor.

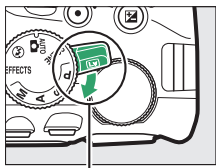

*Live view switch*

#### 2 Adjust outline thickness.

Press **OK** to display the options shown at right. Press **←** or **→** to make outlines thicker or thinner.



#### 3 Press **OK**.

Press **OK** to exit when settings are complete. To exit live view, rotate the live view switch.

**1 Select live view.**

Rotate the live view switch. The view through the lens will be displayed in the monitor.

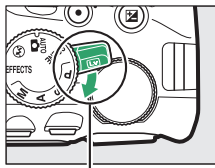

*Live view switch*

**2 Adjust options.**

Press **OK** to display the options shown at right. Press **▲** or **▼** to highlight **Vividness** or **Vignetting** and press **◀** or **▶** to change. Adjust vividness to make colors more or less saturated, vignetting to control the amount of vignetting.

**3 Press **OK**.**

Press **OK** to exit when settings are complete. To exit live view, rotate the live view switch.

**1 Select live view.**

Rotate the live view switch. The view through the lens will be displayed in the monitor.

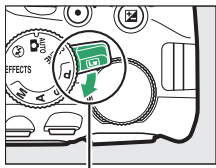
*Live view switch***2 Position the focus point.**

Use the multi selector to position the focus point in the area that will be in focus and then press the shutter-release button halfway to focus. To temporarily clear miniature effect options from the display and enlarge the view in the monitor for precise focus, press  $\odot$ . Press  $\odot$  (?) to restore the miniature effect display.

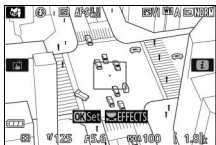
**3 Display options.**

Press  $\odot$  to display miniature effect options.

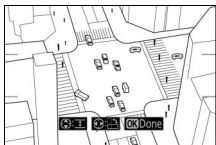
**4 Adjust options.**

Press  $\odot$  or  $\odot$  to choose the orientation of the area that will be in focus and press  $\odot$  or  $\odot$  to adjust its width.

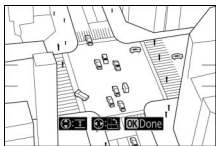

---

## 5 Press .

Press  to exit when settings are complete. To exit live view, rotate the live view switch.

### **Selective Color**

---

#### 1 Select live view.

Rotate the live view switch. The view through the lens will be displayed in the monitor.

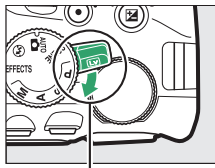

*Live view switch*

---

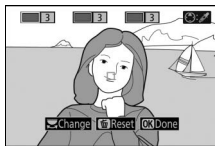

#### 2 Display options.

Press  to display selective color options.



---

#### 3 Select a color.



Frame an object in the white square in the center of the display and press  to choose the color of the object as one that will remain in the final image (the camera may have difficulty detecting unsaturated colors; choose a saturated color). To zoom in on the center of the display for more precise color selection, press . Press  (?) to zoom out.

*Selected color*



---

## 4 Choose the color range.



Press  or  to increase or decrease the range of similar hues that will be included in the final image. Choose from values between 1 and 7; note that higher values may include hues from other colors.

Color range



---

## 5 Select additional colors.

To select additional colors, rotate the command dial to highlight another of the three color boxes at the top of the display and repeat Steps 3 and 4 to select another color. Repeat for a third color if desired. To deselect the highlighted color, press  (To remove all colors, press and hold ). A confirmation dialog will be displayed; select **Yes**).



---



## 6 Press .

Press  to exit when settings are complete. During shooting, only objects of the selected hues will be recorded in color; all others will be recorded in black-and-white. To exit live view, rotate the live view switch.



# More on Photography



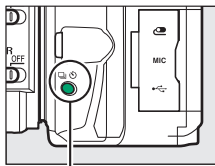

## Choosing a Release Mode

To choose how the shutter is released (release mode), press the  (☺) button, then highlight the desired option and press .

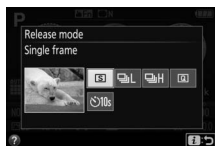



 (☺) button



Mode	Description
	<b>Single frame:</b> Camera takes one photograph each time shutter-release button is pressed.
	<b>Continuous L:</b> The camera takes photographs at a slow rate while the shutter-release button is pressed (☞ 76).
	<b>Continuous H:</b> The camera takes photographs at a fast rate while the shutter-release button is pressed (☞ 76).
	<b>Quiet shutter release:</b> As for single-frame, except that camera noise is reduced (☞ 78).
	<b>Self-timer:</b> Take pictures with the self-timer (☞ 79).

### Choosing a Release Mode with the Command Dial

The release mode can also be selected by keeping the  (☺) button pressed while rotating the command dial. Release the  (☺) button to select the highlighted option and return to the information display.

## Continuous Shooting (Burst Mode)

In **L** (**Continuous L**) and **H** (**Continuous H**) modes, the camera takes photographs continuously while the shutter-release button is pressed all the way down.

- 1 Press the **L** (☺) button.

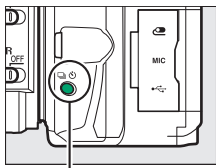

**L** (☺) button

- 2 Choose a continuous release mode.  
Highlight **L** (**Continuous L**) or **H** (**Continuous H**) and press **OK**.

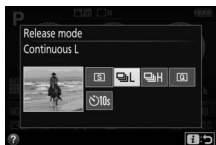

- 3 Focus.  
Frame the shot and focus.



- 4 Take photographs.  
The camera will take photographs while the shutter-release button is pressed all the way down.



### **The Memory Buffer**

The camera is equipped with a memory buffer for temporary storage, allowing shooting to continue while photographs are being saved to the memory card. Up to 100 photographs can be taken in succession (an exception is if a shutter speed of 4 seconds or slower is selected in mode **S** or **M**, when there is no limit on the number of shots that can be taken in a single burst). If the battery is exhausted while images remain in the buffer, the shutter release will be disabled and the images transferred to the memory card.

### **Frame Rate**

For information on the number of photographs can be taken in continuous release modes, see page 357. Frame rates may drop when the memory buffer is full or the battery is low.

### **The Built-in Flash**

Continuous release modes can not be used with the built-in flash; rotate the mode dial to  (📖 47) or turn the flash off (📖 102).

### **Buffer Size**

The approximate number of images that can be stored in the memory buffer at current settings is shown in the viewfinder exposure-count display while the shutter-release button is pressed.





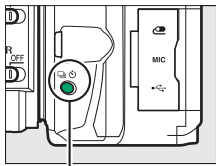

## Quiet Shutter Release

Choose this mode to keep camera noise to a minimum. A beep does not sound when the camera focuses.

- 1 Press the  (🔇) button.



 button

- 2 Select  (Quiet shutter release).  
Highlight  (Quiet shutter release) and press .

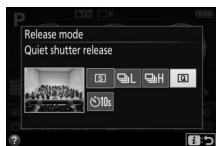

- 3 Take pictures.  
Press the shutter-release button all the way down to shoot.



## Self-Timer Mode

The self-timer can be used for self-portraits or group shots that include the photographer. Before proceeding, mount the camera on a tripod or place it on a stable, level surface.

- 1 Press the  button.

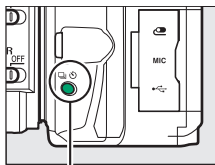

 button

- 2 Select  (Self-timer) mode.  
Highlight  (Self-timer) and press .



- 3 Frame the photograph.

#### 4 Take the photograph.

Press the shutter-release button halfway to focus, and then press the button the rest of the way down. The self-timer lamp will start to flash and a beep will begin to sound. Two seconds before the photo is taken, the lamp will stop flashing and the beeping will become more rapid. The shutter will be released ten seconds after the timer starts.

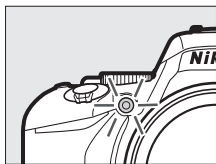

Note that the timer may not start or a photograph may not be taken if the camera is unable to focus or in other situations in which the shutter can not be released. To stop the timer without taking a photograph, turn the camera off.

#### Cover the Viewfinder

To prevent light entering via the viewfinder from appearing in the photograph or interfering with exposure, we recommend that you cover the viewfinder with your hand or other objects such as an optional eyepiece cap (□ 322) when taking pictures without your eye to the viewfinder. To attach the cap, remove the rubber eyecup (①) and insert the cap as shown (②). Hold the camera firmly when removing the rubber eyecup.



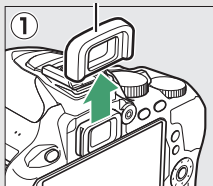

*Rubber eyecup*

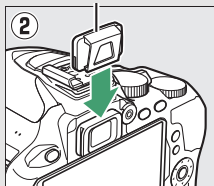

*Eyepiece cap*



### **Using the Built-in Flash**

Before taking a photograph with the flash in modes that require the flash to be raised manually, press the  ( 42) button to raise the flash and wait for the  indicator to be displayed in the viewfinder ( 54). Shooting will be interrupted if the flash is raised after the self-timer has started.

### **Custom Setting c3 (Self-Timer)**

For information on choosing the duration of the self-timer and the number of shots taken, see Custom Setting c3 (**Self-timer**;  241).

## Focus

Focus can be adjusted automatically (see below) or manually (☞ 95). The user can also select the focus point for automatic or manual focus (☞ 90) or use focus lock to focus to recompose photographs after focusing (☞ 93).

### Focus Mode

The following focus modes can be selected during viewfinder photography:

Option	Description
<b>AF-A Auto-servo AF</b>	Camera automatically selects single-servo autofocus if subject is stationary, continuous-servo autofocus if subject is moving. Shutter can only be released if camera is able to focus.
<b>AF-S Single-servo AF</b>	For stationary subjects. Focus locks when shutter-release button is pressed halfway. Shutter can only be released if camera is able to focus.
<b>AF-C Continuous-servo AF</b>	For moving subjects. Camera focuses continuously while shutter-release button is pressed halfway. At default settings, shutter can only be released if camera is able to focus, but Custom Setting a1 ( <b>AF-C priority selection</b> , ☞ 235) can be changed to allow the shutter to be released at any time.
<b>MF Manual focus</b>	Focus manually (☞ 95).

Note that **AF-S** and **AF-C** are available only in modes **P**, **S**, **A**, and **M**.



The following focus modes are available in live view:

Option	Description
<b>AF-S Single-servo AF</b>	For stationary subjects. Focus locks when shutter-release button is pressed halfway. You can also focus by touching your subject in the monitor, in which case focus locks until you lift your finger from the display to take the photograph.
<b>AF-F Full-time-servo AF</b>	For moving subjects. Camera focuses continuously until shutter-release button is pressed. Focus locks when shutter-release button is pressed halfway. You can also focus by touching your subject in the monitor, in which case focus locks until you lift your finger from the display to take the photograph.
<b>MF Manual focus</b>	Focus manually (📖 95).

Note that full-time-servo AF is not available in 📷, 📹, and 📺 modes.

## ■ Choosing the Focus Mode

Follow the steps below to choose the focus mode.

### 1 Display focus mode options.

Press the **i** button, then highlight the current focus mode in the information display and press **OK**.

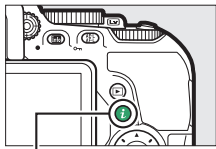

**i** button



*Viewfinder photography*

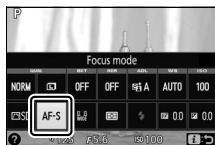

*Live view*

### 2 Choose a focus mode.

Highlight a focus mode and press **OK**.



*Viewfinder photography*



*Live view*

### **Predictive Focus Tracking**

In **AF-C** mode or when continuous-servo autofocus is selected in **AF-A** mode during viewfinder photography, the camera will initiate predictive focus tracking if the subject moves toward the camera while the shutter-release button is pressed halfway. This allows the camera to track focus while attempting to predict where the subject will be when the shutter is released.

### **Continuous-Servo Autofocus**

When **Focus** is selected for Custom Setting a1 (**AF-C priority selection**;  235) and the camera is in **AF-C** mode or continuous-servo autofocus is selected in **AF-A** mode, the camera gives higher priority to focus response (has a wider focus range) than in **AF-S** mode, and the shutter may be released before the in-focus indicator (●) is displayed.

### **The AF-Assist Illuminator**

If the subject is poorly lit, the AF-assist illuminator will light automatically to assist the autofocus operation when the shutter-release button is pressed halfway (some restrictions apply;  342). Note that the illuminator may become hot when used multiple times in quick succession and will turn off automatically to protect the lamp after a period of continuous use. Normal function will resume after a brief pause.

*AF-assist illuminator*

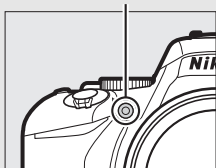

## Getting Good Results with Autofocus

Autofocus does not perform well under the conditions listed below. The shutter release may be disabled if the camera is unable to focus under these conditions, or the in-focus indicator (●) may be displayed and the camera may sound a beep, allowing the shutter to be released even when the subject is not in focus. In these cases, focus manually (□ 95) or use focus lock (□ 93) to focus on another subject at the same distance and then recompose the photograph.



*There is little or no contrast between the subject and the background.*

**Example:** Subject is the same color as the background.



*The focus point contains objects at different distances from the camera.*

**Example:** Subject is inside a cage.



*The subject is dominated by regular geometric patterns.*

**Example:** Blinds or a row of windows in a skyscraper.

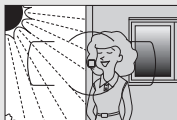

*The focus point contains areas of sharply contrasting brightness.*

**Example:** Subject is half in the shade.



*Background objects appear larger than the subject.*

**Example:** A building is in the frame behind the subject.

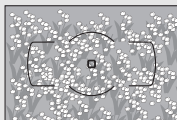

*The subject contains many fine details.*

**Example:** A field of flowers or other subjects that are small or lack variation in brightness.

## **AF-Area Mode**

Choose how the focus point for autofocus is selected. The following options are available during viewfinder photography:



Option	Description
[•] <b>Single-point AF</b>	For stationary subjects. Focus point is selected manually; camera focuses on subject in selected focus point only.
[•]9 <b>Dynamic-area AF (9 points)</b>	For non-stationary subjects. <b>In AF-A and AF-C focus modes</b> , user selects focus point using multi selector (□ 90), but camera will focus based on information from surrounding focus points if subject briefly leaves selected point. Number of focus points varies with mode selected:
[•]21 <b>Dynamic-area AF (21 points)</b>	<b>9-point dynamic-area AF:</b> Choose when there is time to compose photograph or when photographing subjects that are moving predictably (e.g., runners or race cars on a track).
[•]39 <b>Dynamic-area AF (39 points)</b>	<b>21-point dynamic-area AF:</b> Choose when photographing subjects that are moving unpredictably (e.g., players at a football game). <b>39-point dynamic-area AF:</b> Choose when photographing subjects that are moving quickly and are hard to keep in frame (e.g., birds).







Option	Description
<b>[3D] 3D-tracking</b>	<p>In <b>AF-A</b> and <b>AF-C</b> focus modes, user selects focus point using multi selector (☐ 90). If subject moves after camera has focused, camera uses 3D-tracking to select new focus point and keep focus locked on original subject while shutter-release button is pressed halfway.</p> 
<b>[AF] Auto-area AF</b>	<p>Camera automatically detects subject and selects focus point.</p>

Note that [AF] (dynamic-area) and [3D] (3D-tracking) AF-area modes are not available when **AF-S** is selected for focus mode.

### 3D-Tracking





If subject leaves the viewfinder, remove your finger from the shutter-release button and recompose the photograph with the subject in the selected focus point. Note that when the shutter-release button is pressed halfway, the colors in the area surrounding the focus point are stored in the camera. Consequently 3D-tracking may not produce the desired results with subjects that are similar in color to the background or that occupy a very small area of the frame.

In modes other than , , and , the following AF-area modes can be selected in live view:

Option	Description
 <b>Face-priority AF</b>	<p>Use for portraits. The camera automatically detects and focuses on portrait subjects; the selected subject is indicated by a double yellow border (if multiple faces are detected, the camera will focus on the closest subject; to choose a different subject, use the multi selector). If the camera can no longer detect the subject (because, for example, the subject has turned to face away from the camera), the border will no longer be displayed.</p> 
 <b>Wide-area AF</b>	<p>Use for hand-held shots of landscapes and other non-portrait subjects.</p> 
 <b>Normal-area AF</b>	<p>Use for pin-point focus on a selected spot in the frame. A tripod is recommended.</p> 

Option	Description
 <b>Subject-tracking AF</b>	<p>Use the multi selector to position the focus point over your subject and press <b>OK</b> to start tracking. The focus point will track the selected subject as it moves through the frame.</p> <p>To end tracking, press <b>OK</b> again. Note that the camera may be unable to track subjects if they move quickly, leave the frame or are obscured by other objects, change visibly in size, color, or brightness, or are too small, too large, too bright, too dark, or similar in color or brightness to the background.</p>



Note that subject-tracking AF is not available in , , , and  modes.

### Manual Focus-Point Selection

The multi selector can be used to select the focus point. Except in subject-tracking AF, pressing **OK** during focus-point selection selects the center focus point. In subject-tracking AF, pressing **OK** starts subject tracking instead. Manual focus-point selection is not available in auto-area AF.



## ■ Choosing the AF-Area Mode

Follow the steps below to choose the AF-area mode.

### 1 Display AF-area mode options.

Press the **i** button, then highlight the current AF-area mode in the information display and press **OK**.

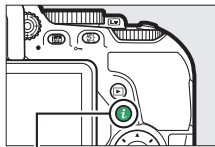

**i** button



*Viewfinder photography*



*Live view*

### 2 Choose an AF-area mode.

Highlight an option and press **OK**.

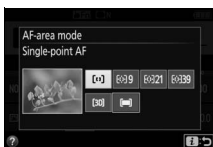

*Viewfinder photography*



*Live view*

#### AF-Area Mode

AF-area mode selections made in shooting modes other than **P**, **S**, **A**, or **M** are reset when another shooting mode is selected.

### ✔ Using Autofocus in Live View

The desired results may not be achieved with teleconverters (☞ 305). Note that in live view, autofocus is slower and the monitor may brighten or darken while the camera focuses. The focus point may sometimes be displayed in green when the camera is unable to focus. The camera may be unable to focus in the following situations:

- The subject contains lines parallel to the long edge of the frame
- The subject lacks contrast
- The subject in the focus point contains areas of sharply contrasting brightness, or includes spot lighting or a neon sign or other light source that changes in brightness
- Flicker or banding appears under fluorescent, mercury-vapor, sodium-vapor, or similar lighting
- A cross (star) filter or other special filter is used
- The subject appears smaller than the focus point
- The subject is dominated by regular geometric patterns (e.g., blinds or a row of windows in a skyscraper)
- The subject is moving

## Focus Lock

Focus lock can be used to change the composition after focusing in **AF-A**, **AF-S**, and **AF-C** focus modes (☞ 82), making it possible to focus on a subject that will not be in a focus point in the final composition. If the camera is unable to focus using autofocus (☞ 86), focus lock can also be used to recompose the photograph after focusing on another object at the same distance as your original subject. Focus lock is most effective when an option other than **[ ] (Auto-area AF)** is selected for AF-area mode (☞ 87).

### 1 Focus.

Position the subject in the selected focus point and press the shutter-release button halfway to initiate focus. Check that the in-focus indicator (●) appears in the viewfinder (viewfinder photography) or that the focus point has turned green (live view).



*Viewfinder photography*



*Live view*

### Autoexposure Lock

Pressing the **AE-L/AF-L (O)** button in Step 2 also locks exposure (☞ 130).

## 2 Lock focus.

**AF-A and AF-C focus modes (viewfinder photography):** With the shutter-release button pressed halfway (①), press the  $\text{AE-L/AF-L}$  (O) button (②) to lock focus. Focus will remain locked while the  $\text{AE-L/AF-L}$  (O) button is pressed, even if you later remove your finger from the shutter-release button.

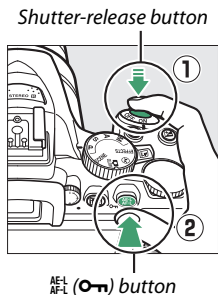

**AF-S (viewfinder photography) and live view:** Focus locks automatically and remain locked until you remove your finger from the shutter-release button. Focus can also be locked by pressing the  $\text{AE-L/AF-L}$  (O) button (see above).

## 3 Recompose the photograph and shoot.

Focus will remain locked between shots if you keep the shutter-release button pressed halfway or keep the  $\text{AE-L/AF-L}$  (O) button pressed, allowing several photographs in succession to be taken at the same focus setting.



Do not change the distance between the camera and the subject while focus lock is in effect. If the subject moves, focus again at the new distance.

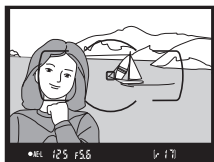

*Viewfinder photography*



*Live view*

## Manual Focus

Manual focus can be used when autofocus is not available or does not produce the desired results (☞ 86).

### 1 Select manual focus.

If the lens is equipped with an A-M, M/A-M, or A/M-M mode switch, slide the switch to **M**.

*A-M mode switch*



*M/A-M mode switch*



If the lens is not equipped a focus-mode switch, select **MF** (manual focus) for **Focus mode** (☞ 82).

### 2 Focus.

To focus manually, adjust the lens focus ring until the image displayed on the clear matte field in the viewfinder is in focus. Photographs can be taken at any time, even when the image is not in focus.

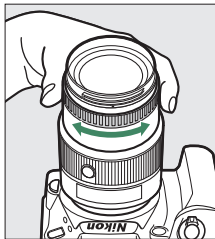

#### AF-P Lenses

When an AF-P lens (☞ 305) is used in manual focus mode, the in-focus indicator (●) will flash in the viewfinder (or in live view, the focus point will flash in the monitor) to warn that continuing to rotate the focus ring in the current direction will not bring the subject into focus.

## ■ The Electronic Rangefinder (Viewfinder Photography)

The viewfinder focus indicator can be used to confirm whether the subject in the selected focus point is in focus (the focus point can be selected from any of the 39 focus points). After positioning the subject in the selected focus point, press the shutter-release button halfway and rotate the lens focus ring until the in-focus indicator (●) is displayed. Note that with the subjects listed on page 86, the in-focus indicator may sometimes be displayed when the subject is not in focus; confirm focus in the viewfinder before shooting.

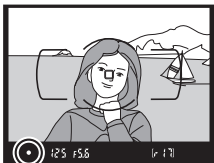

### ✔ Selecting Manual Focus with the Camera

If the lens supports M/A (autofocus with manual override) or A/M (autofocus with manual override/AF priority), manual focus can also be selected by setting the camera focus mode to **MF** (manual focus; 82). Focus can then be adjusted manually, regardless of the mode selected with the lens.

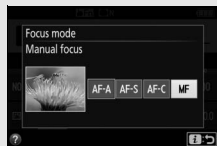

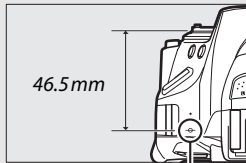

### ✔ Focal Plane Position

To determine the distance between your subject and the camera, measure from the focal plane mark (∞) on the camera body. The distance between the lens mounting flange and the focal plane is 46.5 mm (1.83 in.).



Focal plane mark

### **Live View**

Press the  button to zoom in for precise focus in live view ( 53).

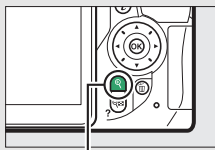

 button

## Image Quality and Size

Together, image quality and size determine how much space each photograph occupies on the memory card. Larger, higher quality images can be printed at larger sizes but also require more memory, meaning that fewer such images can be stored on the memory card (□ 387).

### Image Quality

Choose a file format and compression ratio (image quality).

Option	File type	Description
NEF (RAW) + JPEG fine	NEF/ JPEG	Two images are recorded: one NEF (RAW) image and one fine-quality JPEG image.
NEF (RAW) + JPEG normal		Two images are recorded: one NEF (RAW) image and one normal-quality JPEG image.
NEF (RAW) + JPEG basic		Two images are recorded: one NEF (RAW) image and one basic-quality JPEG image.
NEF (RAW)	NEF	Raw data from the image sensor are saved without additional processing. Settings such as white balance and contrast can be adjusted after shooting.
JPEG fine	JPEG	Record JPEG images at a compression ratio of roughly 1 : 4 (fine quality).
JPEG normal		Record JPEG images at a compression ratio of roughly 1 : 8 (normal quality).
JPEG basic		Record JPEG images at a compression ratio of roughly 1 : 16 (basic quality).

#### NEF (RAW) + JPEG

When photographs taken at NEF (RAW) + JPEG are viewed on the camera, only the JPEG image will be displayed. When photographs taken at these settings are deleted, both NEF and JPEG images will be deleted.



- 
- 1 Display image quality options.**  
Press the **i** button, then highlight the current image quality in the information display and press **OK**.

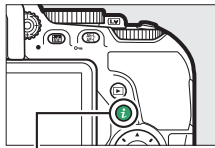

**i** button



*Information display*

- 
- 2 Choose a file type.**  
Highlight an option and press **OK**.



**NEF (RAW) Images**

Selecting **NEF (RAW)** for **Image quality** fixes **Image size** at **Large** (☞ 100). White balance bracketing (☞ 151), high dynamic range (HDR, ☞ 138), and **Date stamp** (☞ 243) are not available at image quality settings of NEF (RAW) or NEF (RAW)+JPEG.

**Converting NEF (RAW) Images to Other Formats**

JPEG copies of NEF (RAW) images can be created using the **NEF (RAW) processing** option in the retouch menu (☞ 280) or software such as Capture NX-D (☞ 210).

## Image Size

Image size is measured in pixels. Choose from **L** Large, **M** Medium, or **S** Small:

Image size	Size (pixels)	Print size (cm/in.)*
<b>L</b> Large	6000 × 4000	50.8 × 33.9/20 × 13.3
<b>M</b> Medium	4496 × 3000	38.1 × 25.4/15.0 × 10
<b>S</b> Small	2992 × 2000	25.3 × 16.9/10 × 6.7

\* Approximate size when printed at 300 dpi. Print size in inches equals image size in pixels divided by printer resolution in dots per inch (dpi); 1 inch = approximately 2.54 cm.

### 1 Display image size options.

Press the **i** button, then highlight the current image size in the information display and press **OK**.

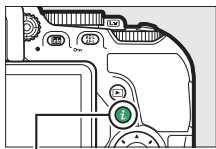

**i** button



Information display

### 2 Choose an image size.









Highlight an option and press **OK**.



## Using the Built-in Flash

The camera supports a variety of flash modes for photographing poorly lit or backlit subjects.

### Auto Pop-up Modes

In , , , , , , , VI, POP, , and  modes, the built-in flash automatically pops up and fires as required.

#### 1 Choose a flash mode.

Keeping the  button pressed, rotate the command dial until the desired flash mode appears in the information display.

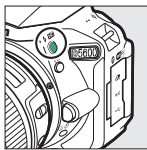

 button

+



Command dial

→



Information display

#### 2 Take pictures.



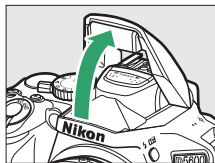

The flash will pop up as required when the shutter-release button is pressed halfway, and fire when a photograph is taken. *If the flash does not pop up*



*automatically, DO NOT attempt to raise it by hand. Failure to observe this precaution could damage the flash.*

## Flash Modes

The following flash modes are available:

- **⚡ AUTO** (auto): When lighting is poor or the subject is backlit, the flash pops up automatically when the shutter-release button is pressed halfway and fires as required. Not available in  mode.
- **⚡👁️ AUTO** (auto + red-eye reduction): Use for portraits. The flash pops up and fires as required, but before it fires the red-eye reduction lamp lights to help reduce “red-eye.” Not available in  mode.
- **⚡👁️ AUTO SLOW** (auto slow sync + red-eye): As for auto with red-eye reduction, except that slow shutter speeds are used to capture background lighting. Use for portraits taken at night or under low light. Available in  mode.
- **⚡ AUTO SLOW** (auto slow sync): Slow shutter speeds are used to capture background lighting in shots taken at night or under low light. Available in  mode.
-  (flash off): The flash does not fire.

### The Information Display

Flash mode can also be selected in the information display ( 6).

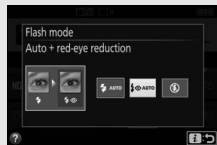



## **Manual Pop-up Modes**

In P, S, A, M, and  $\uparrow$  modes, the flash must be raised manually. The flash will not fire if it is not raised.

### **1 Raise the flash.**

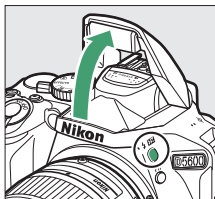
Press the  button to raise the flash.



 button

### **2 Choose a flash mode (P, S, A, and M modes only).**

Keeping the  button pressed, rotate the command dial until the desired flash mode appears in the information display.

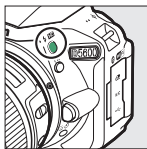

 button

+



Command dial



Information display

### **3 Take pictures.**

The flash will fire whenever a picture is taken.

## ■ Flash Modes

The following flash modes are available:

- **⚡** (fill flash): The flash fires with every shot.
- **⚡👁** (red-eye reduction): Use for portraits. The flash fires with every shot, but before it fires, the red-eye reduction lamp lights to help reduce “red-eye.” Not available in **⌚** mode.
- **⚡👁SLOW** (slow sync + red-eye): As for “red-eye reduction”, above, except that shutter speed slows automatically to capture background lighting at night or under low light. Use when you want to include background lighting in portraits. Not available in modes **S**, **M**, and **⌚**.
- **⚡SLOW** (slow sync): As for “fill flash”, above, except that shutter speed slows automatically to capture background lighting at night or under low light. Use when you want to capture both subject and background. Not available in modes **S**, **M**, and **⌚**.
- **⚡SLOW REAR** (rear-curtain + slow sync): As for “rear-curtain sync”, below, except that shutter speed slows automatically to capture background lighting at night or under low light. Use when you want to capture both subject and background. Not available in modes **S**, **M**, and **⌚**.
- **⚡REAR** (rear-curtain sync): The flash fires just before the shutter closes, creating a stream of light behind moving light sources as shown below at right. Not available in modes **P**, **A**, and **⌚**.



*Front-curtain sync*



*Rear-curtain sync*

### Lowering the Built-in Flash

To save power when the flash is not in use, press it gently downward until the latch clicks into place.

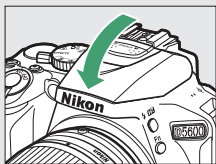

### The Built-in Flash

For information on the lenses that can be used with the built-in flash, see page 312. Remove lens hoods to prevent shadows. The flash has a minimum range of about 0.6 m (2 ft) and can not be used in the macro range of zoom lenses with a macro function.

The shutter release may be briefly disabled to protect the flash after it has been used for several consecutive shots. The flash can be used again after a short pause.

### ✓ Shutter Speeds Available with the Built-in Flash

Shutter speed is restricted to the following ranges when the built-in flash is used:

Mode	Shutter speed
AUTO,  ,	$1/200$ – $1/60$ s
	$1/200$ – $1/30$ s
	$1/200$ –1 s
P, S, A	$1/200$ –30 s
M	$1/200$ –30 s, Bulb, Time

### ✓ Aperture, Sensitivity, and Flash Range



Flash range varies with sensitivity (ISO equivalency) and aperture.

Aperture at ISO equivalent of								Approximate range	
100	200	400	800	1600	3200	6400	12800	m	ft
1.4	2	2.8	4	5.6	8	11	16	1.0–8.5	3 ft 4 in.–27 ft 10 in.
2	2.8	4	5.6	8	11	16	22	0.7–6.0	2 ft 4 in.–19 ft 8 in.
2.8	4	5.6	8	11	16	22	32	0.6–4.2	2 ft–13 ft 9 in.
4	5.6	8	11	16	22	32	—	0.6–3.0	2 ft–9 ft 10 in.
5.6	8	11	16	22	32	—	—	0.6–2.1	2 ft–6 ft 10 in.
8	11	16	22	32	—	—	—	0.6–1.5	2 ft–4 ft 11 in.
11	16	22	32	—	—	—	—	0.6–1.1	2 ft–3 ft 7 in.
16	22	32	—	—	—	—	—	0.6–0.7	2 ft–2 ft 4 in.



## ISO Sensitivity

The camera's sensitivity to light can be adjusted according to the amount of light available. The higher the ISO sensitivity, the less light needed to make an exposure, allowing higher shutter speeds or smaller apertures. Choosing **Auto** allows the camera to set ISO sensitivity automatically in response to lighting conditions; to use auto in **P**, **S**, **A**, and **M** modes, select **Auto ISO sensitivity control** for the **ISO sensitivity settings** item in the shooting menu (☞ 228).

Mode	ISO sensitivity
AUTO,  , 	Auto
<b>P</b> , <b>S</b> , <b>A</b> , <b>M</b>	100–25600 in steps of $\frac{1}{3}$ EV
Other shooting modes	Auto; 100–25600 in steps of $\frac{1}{3}$ EV

- 1 Display ISO sensitivity options.**  
Press the **i** button, then highlight the current ISO sensitivity in the information display and press **OK**.

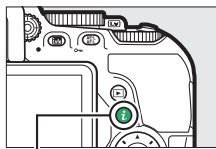

*i* button



*Information display*

- 
- 2 Choose an ISO sensitivity.**  
Highlight an option and press **OK**.

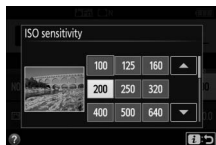

## Interval Timer Photography

The camera is equipped to take photographs automatically at preset intervals.

### ✔ Before Shooting

Before beginning interval timer photography, take a test shot at current settings and view the results in the monitor. To ensure that shooting starts at the desired time, check that the camera clock is set correctly (☐ 262).

Use of a tripod is recommended. Mount the camera on a tripod before shooting begins. To ensure that shooting is not interrupted, be sure the battery is fully charged.

- Select Interval timer shooting.**  
Highlight **Interval timer shooting** in the shooting menu and press **▶** to display interval timer settings.

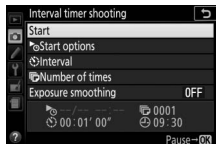
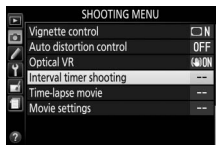

## 2 Adjust interval timer settings.

Choose a start option, interval, number of shots, and exposure smoothing option.

- To choose a start option:

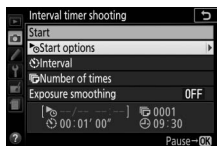

Highlight **Start options** and press **OK**.

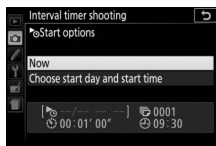

Highlight an option and press **OK**.

To start shooting immediately, select **Now**. To start shooting at a chosen date and time, select **Choose start day and start time**, then choose the date and time and press **OK**.

- To choose the interval between shots:

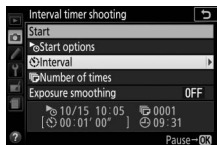

Highlight **Interval** and press **OK**.

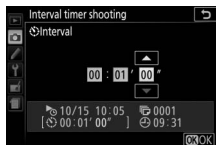

Choose an interval (hours, minutes, and seconds) and press **OK**.

- To choose the number of intervals:

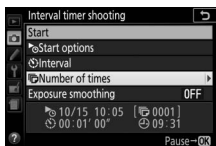

Highlight **Number of times** and press  $\odot$ .

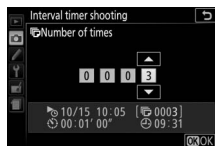

Choose the number of intervals and press  $\odot$ .

- To enable or disable exposure smoothing:

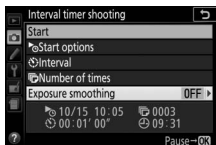

Highlight **Exposure smoothing** and press  $\odot$ .

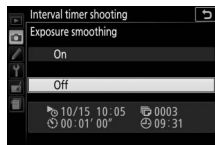

Highlight an option and press  $\odot$ .

Selecting **On** allows the camera to adjust exposure to match previous shot in modes other than **M** (note that exposure smoothing only takes effect in mode **M** if auto ISO sensitivity control is on).

### 3 Start shooting.

Highlight **Start** and press  $\odot$ . The first shot will be taken at the specified starting time, or after about 3 s if **Now** was selected for **Start options** in Step 2. Shooting will continue at the

selected interval until all shots have been taken; while shooting is in progress, the memory card access lamp will flash at regular intervals. Note that because shutter speed and the time needed to record the image to the memory card may vary from shot to shot, intervals may be skipped if the camera is still in the process of recording the previous interval; choose an interval longer than the slowest anticipated shutter speed. If shooting can not proceed at current settings (for example, if a shutter speed of “Bulb” or “Time” is currently selected in shooting mode **M**, the interval is zero, or the start time is in less than a minute), a warning will be displayed in the monitor.

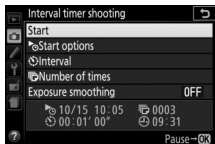

## ■ Pausing Interval Timer Photography

Interval timer photography can be paused between intervals by pressing **OK**. To resume shooting:

### Starting Now

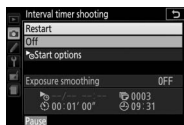

Highlight **Restart** and press **OK**.

### Starting at a Specified Time

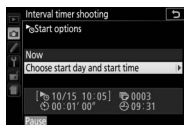

For **Start options**, highlight **Choose start day and start time** and press **OK**.

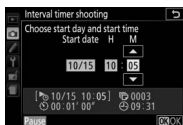

Choose a starting date and time and press **OK**.

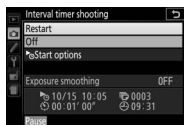

Highlight **Restart** and press **OK**.

## ■ Ending Interval Timer Shooting

To end interval timer photography and resume normal shooting before all the photos are taken, pause shooting and select **Off** in the interval timer menu.

## ■ ■ **No Photograph**

The camera will skip the current interval if any of the following situations persist for eight seconds or more after the interval was due to start: the photograph for the previous interval has yet to be taken, the memory card is full, or the camera is unable to focus (**AF-S**, **AF-A** with single-servo AF selected, or **AF-C** with **Focus** selected for Custom Setting a1 **AF-C priority selection**; note that the camera focuses again before each shot). Shooting will resume with the next interval.

### ✓ **Out of Memory**

If the memory card is full, the interval timer will remain active but no pictures will be taken. Resume shooting (□ 113) after deleting some pictures or turning the camera off and inserting another memory card.

### ✓ **Cover the Viewfinder**

To prevent light entering via the viewfinder from appearing in the photograph or interfering with exposure, we recommend that you cover the viewfinder with your hand or other objects such as an optional eyepiece cap (□ 322) before taking pictures without your eye to the viewfinder (□ 80).

### ✓ **Other Settings**

Settings can not be adjusted during interval timer photography. Regardless of the release mode selected, the camera takes one photograph at each interval; in mode , camera noise will be reduced. Bracketing (□ 151) and high dynamic range (HDR; □ 138) can not be used.

### ✓ **Interrupting Interval Timer Photography**

To interrupt interval timer shooting, turn the camera off or rotate the mode dial to a new setting. Returning the monitor to the storage position does not interrupt interval timer shooting.



## Restoring Default Settings

The camera settings listed below and on page 117 can be restored to default values by holding the **MENU** and **Info** buttons down together for more than two seconds (these buttons are marked by a green dot). The information display turns off briefly while settings are reset.

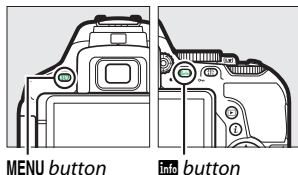

### Settings Accessible from the Information Display









Option	Default	
Image quality	JPEG normal	98
Image size	Large	100
Auto bracketing		
<b>P, S, A, M</b>	Off	151
HDR (high dynamic range)		
<b>P, S, A, M</b>	Off	138
Active D-Lighting		
<b>P, S, A, M</b>	Auto	136
White balance		
<b>P, S, A, M</b>	Auto <sup>1</sup>	140
ISO sensitivity		
<b>P, S, A, M</b>	100	107
Other shooting modes	Auto	
Picture Control settings		
<b>P, S, A, M</b>	Unmodified <sup>2</sup>	158

1 Fine-tuning is also reset.

2 Current Picture Control only.

Option	Default	
Focus mode		
Viewfinder		
Shooting modes other than 	AF-A	82
Live view/movie	AF-S	83
AF-area mode		
Viewfinder		
	Single-point AF	87
	Dynamic-area AF (39 points)	
AUTO,  ,  ,  ,  ,  ,  ,  ,  ,  ,  ,  ,  ,  , VI, POP,  ,  , P, S, A, M	Auto-area AF	
Live view/movie		
	Face-priority AF	89
 A, M	Wide-area AF	
	Normal-area AF	
Metering		
P, S, A, M	Matrix metering	128
Flash mode		
AUTO,  ,  ,  ,  , VI, POP, 	Auto	102, 104
	Auto slow sync	
	Auto+red-eye reduction	
	Flash off	
P, S, A, M	Fill flash	
Flash compensation		
SCENE, P, S, A, M	Off	134
Exposure compensation		
SCENE,  , P, S, A, M	Off	132

## ■ ■ Other Settings

Option	Default	
NEF (RAW) recording	14-bit	227
Exposure delay mode	Off	241
Release mode		
	Continuous H	75
Other shooting modes	Single frame	
Focus point	Center	90
AE/AF lock hold		
Shooting modes other than  and 	Off	254
Flexible program		
<b>P</b>	Off	120
Special effects mode		
		
Outlines		70
		
Vividness	0	71
Vignetting	0	
		
Orientation	Landscape	72
Width	Normal	
		
Color	Off	73
Color range	3	

# P, S, A, and M Modes

## Shutter Speed and Aperture

P, S, A, and M modes offer different degrees of control over shutter speed and aperture:



Mode		Description
P	Programmed auto (☞ 119)	Recommended for snapshots and in other situations in which there is little time to adjust camera settings. Camera sets shutter speed and aperture for optimal exposure.
S	Shutter-priority auto (☞ 121)	Use to freeze or blur motion. User chooses shutter speed; camera selects aperture for best results.
A	Aperture-priority auto (☞ 122)	Use to blur background or bring both foreground and background into focus. User chooses aperture; camera selects shutter speed for best results.
M	Manual (☞ 123)	User controls both shutter speed and aperture. Set shutter speed to "Bulb" or "Time" for long time-exposures.

## Mode P (Programmed Auto)

This mode is recommended for snapshots or whenever you want to leave the camera in charge of shutter speed and aperture. The camera automatically adjusts shutter speed and aperture for optimal exposure in most situations.

*Mode dial*

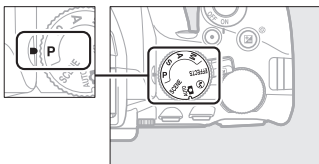

To take pictures in programmed auto mode, rotate the mode dial to **P**.

## Flexible Program

In mode **P**, different combinations of shutter speed and aperture can be selected by rotating the command dial (“flexible program”). Rotate the dial right for large apertures (low f-numbers) and fast shutter speeds, left for small apertures (high f-numbers) and slow shutter speeds. All combinations produce the same exposure.

Rotate right to blur background details or freeze motion.

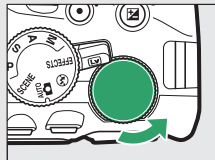

*Command dial*

Rotate left to increase depth of field or blur motion.

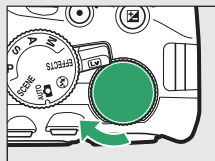

While flexible program is in effect, a **P** (**P<sub>i</sub>**) indicator appears in the viewfinder and information display. To restore default shutter speed and aperture settings, rotate the command dial until the indicator is no longer displayed, choose another mode, or turn the camera off.



## **Mode S (Shutter-Priority Auto)**

This mode lets you control shutter speed: choose fast shutter speeds to “freeze” motion, slow shutter speeds to suggest motion by blurring moving objects. The camera automatically adjusts aperture for optimal exposure.



*Fast shutter speeds (e.g., 1/1600 s) freeze motion.*

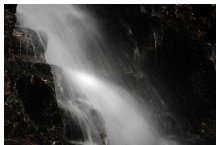

*Slow shutter speeds (e.g., 1 s) blur motion.*

To choose a shutter speed:

### **1 Rotate the mode dial to S.**

*Mode dial*

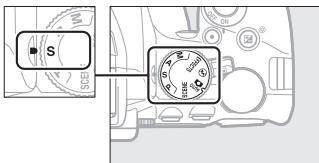

### **2 Choose a shutter speed.**

Rotate the command dial to choose the desired shutter speed: rotate right for faster speeds, left for slower speeds.



*Command dial*



## Mode A (Aperture-Priority Auto)

In this mode, you can adjust aperture to control depth of field (the distance in front of and behind the main subject that appears to be in focus). The camera automatically adjusts shutter speed for optimal exposure.



*Large apertures (low f-numbers, e.g. f/5.6) blur details in front of and behind the main subject.*



*Small apertures (high f-numbers, e.g. f/22) bring the foreground and background into focus.*

To choose an aperture:

### **1** Rotate the mode dial to A.

Mode dial

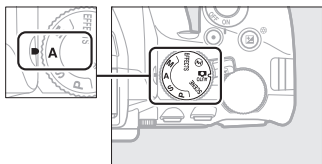

### **2** Choose an aperture.

Rotate the command dial left for larger apertures (lower f-numbers), right for smaller apertures (higher f-numbers).

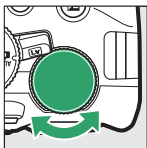

Command dial





## **Mode M (Manual)**

In manual mode, you control both shutter speed and aperture. Shutter speeds of “Bulb” and “Time” are available for long time-exposures of moving lights, the stars, night scenery, or fireworks (📖 125).

---

- 1** Rotate the mode dial to M.

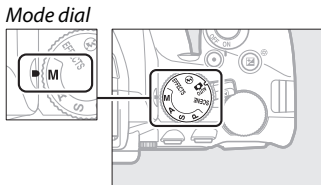

## 2 Choose aperture and shutter speed.

Checking the exposure indicator (see below), adjust shutter speed and aperture. Shutter speed is selected by rotating the command dial (right for faster speeds, left for slower). To adjust aperture, keep the  button pressed while rotating the command dial (left for larger apertures/lower f-numbers and right for smaller apertures/higher f-numbers).

*Shutter speed*



*Command dial*

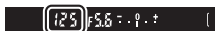

*Aperture*

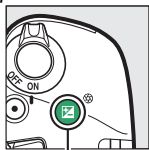

 button

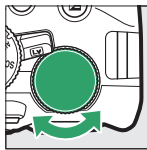

*Command dial*



### The Exposure Indicator

If a CPU lens is attached () 305) and a shutter speed other than “Bulb” or “Time” is selected, the exposure indicator in the viewfinder and information display shows whether the photograph would be under- or over-exposed at current settings.

Optimal exposure	Underexposed by $\frac{1}{3}$ EV	Overexposed by over 2 EV
- . 0   . +	- . 0   . +	- . 0 + ■■■■■▶

## Long Time-Exposures (M Mode Only)

Select the following shutter speeds for long time-exposures of moving lights, the stars, night scenery, or fireworks.

- **Bulb** (b u l b): The shutter remains open while the shutter-release button is pressed all the way down. To prevent blur, use a tripod or an optional wireless remote controller (☞ 323) or remote cord (☞ 324).
- **Time** (- -): Start the exposure using the shutter-release button on the camera or on a remote cord or wireless remote controller. The shutter remains open until the button is pressed a second time.



*Shutter speed: b u l b (35-second exposure; ☞ 126)  
Aperture: f/25*

Before proceeding, mount the camera on a tripod or place it on a stable, level surface. To prevent light entering via the viewfinder from appearing in the photograph or interfering with exposure, we recommend that you cover the viewfinder with your hand or other objects such as an optional eyepiece cap (☞ 322) before taking pictures without your eye to the viewfinder (☞ 80). To prevent loss of power before the exposure is complete, use a fully charged battery. Note that noise (bright spots, randomly-spaced bright pixels, or fog) may be present in long exposures. Bright spots and fog can be reduced by choosing **On** for **Long exposure NR** in the shooting menu (☞ 230).

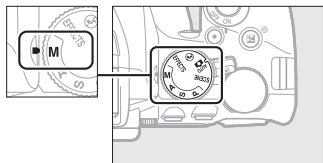
**1** Rotate the mode dial to M.*Mode dial***2** Choose the shutter speed.  
Rotate the command dial to choose a shutter speed of Bulb (b u l b).*Command dial***3** Take the photograph.  
After focusing, press the shutter-release button on the camera, optional wireless remote controller or remote cord all the way down. Take your finger from the shutter-release button when the exposure is complete.

---

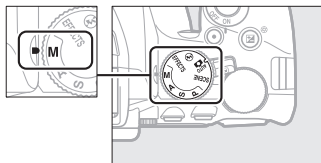
**1 Rotate the mode dial to M.** *Mode dial*

---

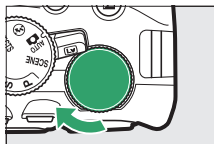
**2 Choose the shutter speed.**  
Rotate the command dial left to choose a shutter speed of “Time” (- -).*Command dial*

---

**3 Open the shutter.**

After focusing, press the shutter-release button on the camera or a remote cord or wireless remote controller all the way down.

---



**4 Close the shutter.**

Repeat the operation performed in Step 3.

# Exposure

## Metering

Choose how the camera sets exposure.

Method	Description
 <b>Matrix metering</b>	Produces natural results in most situations. The camera meters a wide area of the frame and sets exposure according to tone distribution, color, composition, and distance.
 <b>Center-weighted metering</b>	Classic meter for portraits. Camera meters entire frame but assigns greatest weight to center area. Recommended when using filters with an exposure factor (filter factor) over 1x.
 <b>Spot metering</b>	Choose this mode to ensure that subject will be correctly exposed, even when background is much brighter or darker. Camera meters current focus point; use to meter off-center subjects.

### 1 Display metering options.

Press the **i** button, then highlight the current metering method in the information display and press **OK**.

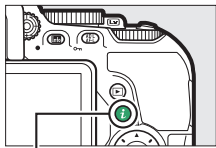

*i* button

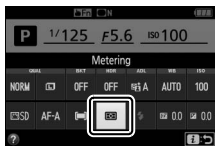

*Information display*



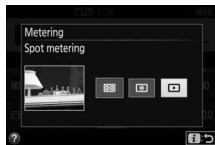

- 
- 2 Choose a metering method.**  
Highlight an option and press **OK**.



**✔ Spot Metering**

If **[M]** (**Auto-area AF**) is selected for **AF-area mode** during viewfinder photography (☞ 87), the camera will meter the center focus point.

## Autoexposure Lock

Use autoexposure lock to recompose photographs after using  (**Center-weighted metering**) and  (**Spot metering**) to meter exposure; note that autoexposure lock is not available in  or  mode.

### 1 Lock exposure.

Position the subject in the selected focus point and press the shutter-release button halfway. With the shutter-release button pressed halfway and the subject positioned in the focus point, press the  (**AE-L**) button to lock exposure.

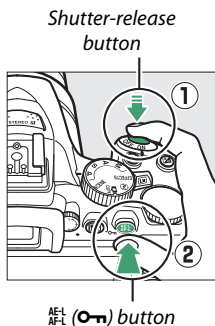

While exposure lock is in effect, an **AE-L** indicator will appear in the viewfinder and the monitor.



### 2 Recompose the photograph.

Keeping the  button pressed, recompose the photograph and shoot.

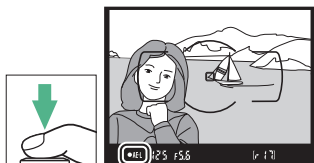





### **Adjusting Shutter Speed and Aperture**

While exposure lock is in effect, the following settings can be adjusted without altering the metered value for exposure:

<b>Mode</b>	<b>Setting</b>
Programmed auto	Shutter speed and aperture (flexible program;  120)
Shutter-priority auto	Shutter speed
Aperture-priority auto	Aperture

The metering method itself can not be changed while exposure lock is in effect.

## Exposure Compensation

Exposure compensation is used to alter exposure from the value suggested by the camera, making pictures brighter or darker (📖 358). In general, positive values make the subject brighter while negative values make it darker. It is most effective when used with  (**Center-weighted metering**) or  (**Spot metering**) (📖 128).





-1 EV





No exposure  
compensation

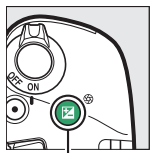

+1 EV

To choose a value for exposure compensation, keep the  () button pressed and rotate the command dial until the desired value is selected in the viewfinder or information display.



 () button

+

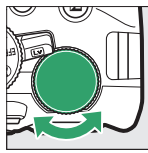

Command dial





Information display



-0.3 EV



+2 EV

Normal exposure can be restored by setting exposure compensation to  $\pm 0$ . Except in **SCENE** and  modes, exposure compensation is not reset when the camera is turned off (in **SCENE** and  modes, exposure compensation will be reset when another mode is selected or the camera is turned off).

### **The Information Display**

Exposure compensation options can also be accessed from the information display ( 12).



### **Mode M**

In mode **M**, exposure compensation affects only the exposure indicator.

### **Using a Flash**

When a flash is used, exposure compensation affects both background exposure and flash level.

### **Bracketing**

For information on automatically varying exposure over a series of shots, see page 151.

## Flash Compensation

Flash compensation is used to alter flash output from the level suggested by the camera, changing the brightness of the main subject relative to the background. Flash output can be increased to make the main subject appear brighter, or reduced to prevent unwanted highlights or reflections (📖 360).

Keep the ⚡ (📷) and 📷 (📷) buttons pressed and rotate the command dial until the desired value is selected in the viewfinder or information display. In general, positive values make the main subject seem brighter while negative values make it seem darker. Normal flash output can be restored by setting flash compensation to  $\pm 0$ . Except in **SCENE** mode, flash compensation is not reset when the camera is turned off (in **SCENE** mode, flash compensation will be reset when another mode is selected or the camera is turned off).

⚡ (📷) button

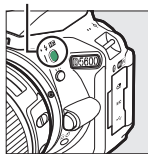

+



Command dial



Information display

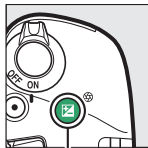

📷 (📷) button



-0.3 EV



+1 EV

### **The Information Display**

Flash compensation options can also be accessed from the information display (📖 12).

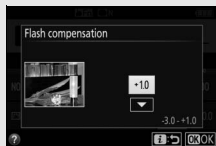



### **Optional Flash Units**

Flash compensation is also available with optional flash units that support the Nikon Creative Lighting System (CLS; see page 315). The flash compensation selected with the optional flash unit is added to the flash compensation selected with the camera.

## Preserving Detail in Highlights and Shadows

### Active D-Lighting



Active D-Lighting preserves details in highlights and shadows, creating photographs with natural contrast. Use for high contrast scenes, for example when photographing brightly lit outdoor scenery through a door or window or taking pictures of shaded subjects on a sunny day. Active D-Lighting is not recommended in mode **M**; in other modes, it is most effective when used with  (**Matrix metering**;  128).



Active D-Lighting: OFF **Off**



Active D-Lighting:  **A Auto**

- 1 Display Active D-Lighting options.** Press the  button, then highlight Active D-Lighting in the information display and press .

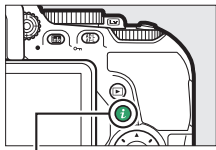

**i** button



Information display

- 2 Choose an option.**  
Highlight an option and press **OK**  
( 359).



 **Active D-Lighting**

With some subjects, you may notice uneven shading, shadows around bright objects, or halos around dark objects. Active D-Lighting is not available with movies.

 **“Active D-Lighting” Versus “D-Lighting”**

**Active D-Lighting** adjusts exposure before shooting to optimize the dynamic range, while the **D-Lighting** option in the retouch menu ( 285) brightens shadows in images after shooting.

 **Bracketing**

For information on automatically varying Active D-Lighting over a series of shots, see page 151.

## High Dynamic Range (HDR)

High Dynamic Range (HDR) combines two exposures to form a single image that captures a wide range of tones from shadows to highlights, even with high-contrast subjects. HDR is most effective when used with  (**Matrix metering**) (📖 128). It can not be used to record NEF (RAW) images. While HDR is in effect, the flash can not be used and continuous shooting is not available.

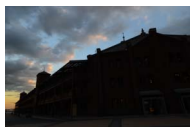

*First exposure (darker)*

+



*Second exposure (brighter)*

➔



*Combined HDR image*

### **1** Display HDR (high dynamic range) options.

Press the **i** button, then highlight HDR (high dynamic range) in the information display and press **OK**.

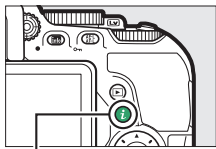

**i** button



*Information display*



## 2 Choose an option.

Highlight **AUTO Auto**, **HIGH Extra high**, **HIGH High**, **NORM Normal**, **LOW Low**, or **OFF Off** and press **OK**.

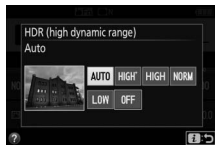

When an option other than **OFF Off** is selected, **Hdr** will be displayed in the viewfinder.



## 3 Frame a photograph, focus, and shoot.

The camera takes two exposures when the shutter-release button is pressed all the way down. "**Job Hdr**" will flash in the viewfinder while the images are combined; no photographs can be taken until recording is complete. HDR turns off automatically after the photograph is taken; to turn off HDR before shooting, rotate the mode dial to a setting other than **P**, **S**, **A**, or **M**.









### ✓ Framing HDR Photographs

The edges of the image may be cropped out. The desired results may not be achieved if the camera or subject moves during shooting. Use of a tripod is recommended. Depending on the scene, the effect may not be visible, shadows may appear around bright objects, or halos may appear around dark objects. Uneven shading may be visible with some subjects.

## White Balance

White balance ensures that colors are unaffected by the color of the light source. Auto white balance is recommended for most light sources; other values can be selected if necessary according to the type of source:

Option	Description
AUTO <b>Auto</b>	Automatic white balance adjustment. Recommended in most situations.
 <b>Incandescent</b>	Use under incandescent lighting.
 <b>Fluorescent</b>	Use with the light sources listed on page 141.
 <b>Direct sunlight</b>	Use with subjects lit by direct sunlight.
 <b>Flash</b>	Use with the flash.
 <b>Cloudy</b>	Use in daylight under overcast skies.
 <b>Shade</b>	Use in daylight with subjects in the shade.
PRE <b>Preset manual</b>	Measure white balance or copy white balance from existing photo (☞ 145).

- 1 Display white balance options.**  
Press the **i** button, then highlight the current white balance setting in the information display and press **OK**.

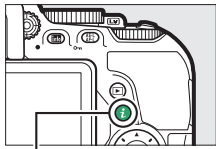

**i** button



Information display

- 2 Choose a white balance option.  
Highlight an option and press **OK**.

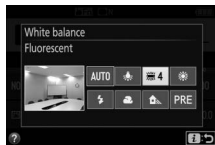

### The Shooting Menu

White balance can be selected using the **White balance** option in the shooting menu (📖 223), which also can be used to fine-tune white balance (📖 143) or measure a value for preset white balance (📖 145).

The  **Fluorescent** option in the **White balance** menu can be used to select the light source from the bulb types shown at right.

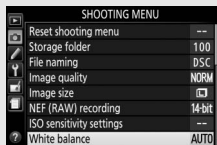

### Touch Menu Navigation



Tap an option in the white balance menu once to highlight it and again to select it and either display a menu of bulb types ( **Fluorescent**) or return to the shooting menu.

## Color Temperature

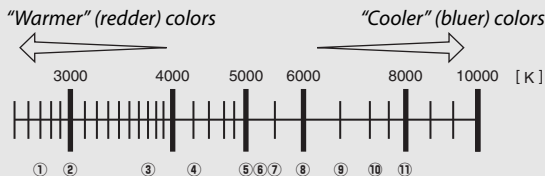
The perceived color of a light source varies with the viewer and other conditions. Color temperature is an objective measure of the color of a light source, defined with reference to the temperature to which an object would have to be heated to radiate light in the same wavelengths. While light sources with a color temperature in the neighborhood of 5000–5500 K appear white, light sources with a lower color temperature, such as incandescent light bulbs, appear slightly yellow or red. Light sources with a higher color temperature appear tinged with blue.





①  (sodium-vapor lamps): 2700 K

②  (incandescent)/ (warm-white fluorescent.): 3000 K

③  (white fluorescent): 3700 K

④  (cool-white fluorescent): 4200 K

⑤  (day white fluorescent): 5000 K

⑥  (direct sunlight): 5200 K

⑦  (flash): 5400 K

⑧  (cloudy): 6000 K

⑨  (daylight fluorescent): 6500 K

⑩  (high temp. mercury-vapor): 7200 K

⑪  (shade): 8000 K

**Note:** All figures are approximate.

## Bracketing

For information on automatically varying white balance settings over a series of shots, see page 151.

## Fine-Tuning White Balance

White balance can be “fine-tuned” to compensate for variations in the color of the light source or to introduce a deliberate color cast into an image. White balance is fine-tuned using the **White balance** option in the shooting menu.

### 1 Display fine-tuning options.

Highlight a white balance option and press  $\odot$  (if **Fluorescent** is selected, highlight the desired lighting type and press  $\odot$ ); note that fine-tuning is not available with **Preset manual**).

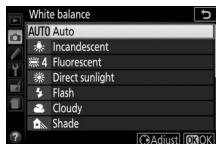

### 2 Fine-tune white balance.

Use the multi selector to fine-tune white balance. White balance can be fine-tuned on the amber (A)–blue (B) axis in steps of 0.5 and the green (G)–magenta (M) axis in steps of 0.25. The horizontal (amber–blue) axis corresponds to color temperature, while the vertical (green–magenta) axis has the similar effects to the corresponding color compensation (CC) filters. The horizontal axis is ruled in increments equivalent to about 5 mired, the vertical axis in increments of about 0.05 diffuse density units.

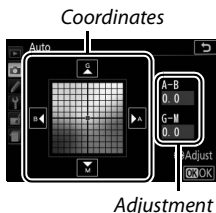







### 3 Save changes and exit.

Press  $\odot$ .

### White Balance Fine-Tuning

The colors on the fine-tuning axes are relative, not absolute. For example, moving the cursor to **B** (blue) when a “warm” setting such as  (incandescent) is selected will make photographs slightly “colder” but will not actually make them blue.

### Touch Fine-Tuning

To fine-tune an option in the white balance menu using the touch screen, tap the option once to highlight it and then tap the  **Adjust** button to view the fine-tuning display. To choose a value, tap the coordinate display or the , , , or  icons. Tap  **OK** to return to the shooting menu once white balance has been adjusted to your satisfaction.

### “Mired”

Any given change in color temperature produces a greater difference in color at low color temperatures than it would at higher color temperatures. For example, a change of 1000 K produces a much greater change in color at 3000 K than at 6000 K. Mired, calculated by multiplying the inverse of the color temperature by  $10^6$ , is a measure of color temperature that takes such variation into account, and as such is the unit used in color-temperature compensation filters. E.g.:

- 4000 K–3000 K (a difference of 1000 K)=83 mired
- 7000 K–6000 K (a difference of 1000 K)=24 mired

## Preset Manual

Preset manual is used to record and recall custom white balance settings for shooting under mixed lighting or to compensate for light sources with a strong color cast. Two methods are available for setting preset white balance:

Method	Description
Measure	Neutral gray or white object is placed under lighting that will be used in final photo and white balance measured by camera (see below).
Use photo	White balance is copied from photo on memory card (☐ 149).

### ■ ■ Measuring a Value for Preset White Balance

#### 1 Light a reference object.

Place a neutral gray or white object under the lighting that will be used in the final photograph.

#### 2 Display white balance options.

Highlight **White balance** in the shooting menu and press  $\blacktriangleright$  to display white balance options. Highlight **Preset manual** and press  $\blacktriangleleft$ .

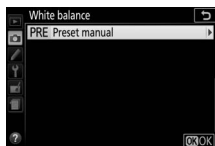

#### 3 Select Measure.

Highlight **Measure** and press  $\blacktriangleleft$ .

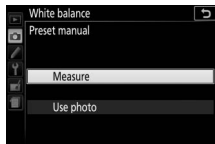

## 4 Select Yes.

The menu shown at right will be displayed; highlight **Yes** and press **OK**.

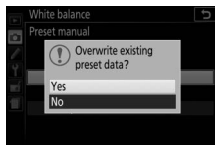

The camera will enter preset measurement mode.

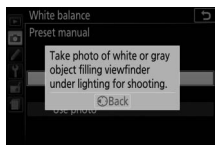

When the camera is ready to measure white balance, a flashing **P r E** (PRE) will appear in the viewfinder and information display.



## 5 Measure white balance.

Before the indicators stop flashing, frame the reference object so that it fills the viewfinder and press the shutter-release button all the way down. No photograph will be recorded; white balance can be measured accurately even when the camera is not in focus.





## 6 Check the results.

If the camera was able to measure a value for white balance, the message shown at right will be displayed and **ūd** will flash in the viewfinder and the camera will return to shooting mode. To return to shooting mode immediately, press the shutter-release button halfway.

If lighting is too dark or too bright, the camera may be unable to measure white balance. A message will appear in the information display and a flashing **no ūd** will appear in the viewfinder. Return to Step 5 and measure white balance again.



### ✔ Measuring Preset White Balance



If no operations are performed while the displays are flashing, direct measurement mode will end in the time selected for Custom Setting c2 (**Auto off timers**;  240).

### ✔ Preset White Balance

The camera can store only one value for preset white balance at a time; the existing value will be replaced when a new value is measured.

Note that exposure is automatically increased by 1 EV when measuring white balance; when shooting in mode **M**, adjust exposure so that the exposure indicator shows  $\pm 0$  ( 124).

### ✔ Other Methods for Measuring Preset White Balance

To enter preset measurement mode (see above) after selecting preset white balance in the information display ( 140), press  for a few seconds. If white balance has been assigned to the **Fn** button ( 252), white balance preset measurement mode can be activated by keeping the **Fn** button pressed for a few seconds after selecting preset white balance with the **Fn** button and command dial.

### ✔ Gray Panels

For more precise results, measure white balance using a standard gray panel.

## ■ ■ Copying White Balance from a Photograph

Follow the steps below to copy a value for white balance from a photograph on the memory card.

### 1 Select Preset manual.

Highlight **White balance** in the shooting menu and press  $\blacktriangleright$  to display white balance options. Highlight **Preset manual** and press  $\blacktriangleright$ .

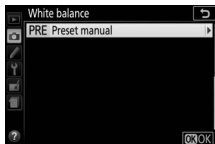

### 2 Select Use photo.

Highlight **Use photo** and press  $\blacktriangleright$ .

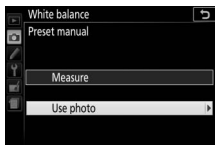

### 3 Choose Select image.

Highlight **Select image** and press  $\blacktriangleright$  (to skip the remaining steps and use the image last selected for preset white balance, select **This image**).



### 4 Choose a folder.

Highlight the folder containing the source image and press  $\blacktriangleright$ .

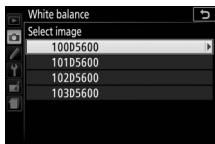

---

## 5 Highlight the source image.

To view the highlighted image full frame, press and hold the  $\text{Q}$  button.



---

## 6 Copy white balance.

Press  $\text{OK}$  to set preset white balance to the white balance value for the highlighted photograph.

## Bracketing

Bracketing automatically varies exposure, white balance, or Active D-Lighting (ADL) settings slightly with each shot, “bracketing” the current value. Choose in situations in which it is difficult to set exposure or white balance and there is not time to check results and adjust settings with each shot, or to experiment with different settings for the same subject.

Option	Description
AE AE bracketing	<p>Vary exposure over a series of three photographs.</p>  <p><i>Shot 1: unmodified</i>      <i>Shot 2: exposure reduced</i>      <i>Shot 3: exposure increased</i></p>
WB WB bracketing	<p>Each time the shutter is released, the camera creates three images, each with a different white balance. Not available with image qualities of NEF (RAW).</p>
ADL ADL bracketing	<p>Take one photo with Active D-Lighting off, and another at the current Active D-Lighting setting.</p>

### 1 Choose a bracketing option.

Highlight e2 (**Auto bracketing set**) in the Custom Settings menu and press .

Highlight the desired bracketing type and press .

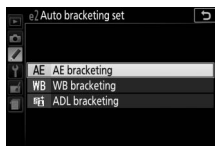

---

## 2 Display bracketing options.

Press the **i** button, then highlight the current bracketing setting and press

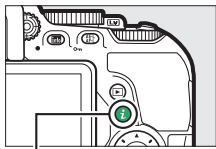

*i* button



*Information display*

---

## 3 Select a bracketing increment.

Highlight a bracketing increment and press **OK**. Choose from values between 0.3 and 2 EV (AE bracketing) or 1 to 3 (WB bracketing), or select **ADL** (ADL bracketing).

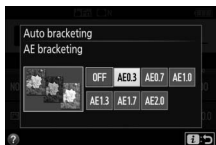

---

## 4 Frame a photograph, focus, and shoot.



**AE bracketing:** The camera will vary exposure with each shot. The first shot will be taken at the value currently selected for exposure compensation. The bracketing increment will be subtracted from the current value in the second shot and added in the third shot, “bracketing” the current value. The modified values are reflected in the values shown for shutter speed and aperture.

**WB bracketing:** Each shot is processed to create three copies, one at the current white balance setting, one with increased amber, and one with increased blue.

**ADL bracketing:** The first shot after bracketing is activated is taken with Active D-Lighting off, the second at the current Active D-Lighting setting (☞ 136; if Active D-Lighting is off, the second shot will be taken with Active D-Lighting set to **Auto**).

In continuous high-speed and continuous low-speed release modes, shooting will pause after each bracketing cycle. If the camera is turned off before all shots in the bracketing sequence have been taken, bracketing will resume from the next shot in the sequence when the camera is turned on.

### The Bracketing Progress Indicator

During AE bracketing, a bar is removed from the bracketing progress indicator with each shot (-1, 0, + > -1, 0, + > - 0, +).

During ADL bracketing, the setting that will be used for the next shot is underlined in the information display.

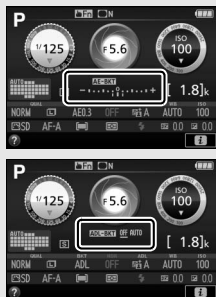

### Disabling Bracketing

To disable bracketing and resume normal shooting, select **OFF** in Step 3 (□ 152). Bracketing can also be cancelled by performing a two-button reset (□ 115). To cancel bracketing before all frames have been recorded, rotate the mode dial to a setting other than **P**, **S**, **A**, or **M**.

### Exposure Bracketing

The camera modifies exposure by varying shutter speed and aperture (mode **P**), aperture (mode **S**), or shutter speed (modes **A** and **M**). If **On** is selected for **ISO sensitivity settings > Auto ISO sensitivity control** (□ 228) in modes **P**, **S**, and **A**, the camera will automatically vary ISO sensitivity for optimum exposure when the limits of the camera exposure system are exceeded; in mode **M**, the camera will first use auto ISO sensitivity control to bring exposure as close as possible to the optimum and then bracket this exposure by varying shutter speed.









## Picture Controls

Picture Controls are preset combinations of image processing settings that include sharpening, clarity, contrast, brightness, saturation, and hue. You can select a Picture Control to match the scene or customize settings to suit your creative intent.

### Selecting a Picture Control

Choose a Picture Control according to the subject or type of scene.

Option	Description
 <b>Standard</b>	Recommended for most situations, this option uses standard processing for balanced results.
 <b>Neutral</b>	A good choice for photographs that will later be processed or retouched, this option uses minimal processing for natural results.
 <b>Vivid</b>	Choose this option for photographs that emphasize primary colors. Pictures are enhanced for a vivid, photoprint effect.
 <b>Monochrome</b>	Take monochrome photographs.
 <b>Portrait</b>	Process portraits for skin with natural texture and a rounded feel.
 <b>Landscape</b>	Produces vibrant landscapes and cityscapes.
 <b>Flat</b>	Choose for photographs that will later be extensively processed or retouched. Details are preserved over a wide tone range, from highlights to shadows.

- 1 Display Picture Control options.**  
Press the **i** button, then highlight the current Picture Control and press **OK**.

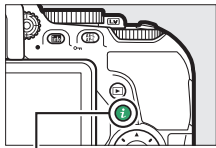

**i** button



Information display

- 2 Select a Picture Control.**  
Highlight a Picture Control and press **OK**.



### Touch Menu Navigation

Picture Controls can also be selected in the shooting menu (☞ 223). When choosing an option from the **Set Picture Control** menu using the touch screen (☞ 25), tap the option once to highlight it and again to select it.

## Modifying Picture Controls

Existing preset or custom Picture Controls (📖 161) can be modified to suit the scene or the user's creative intent. Choose a balanced combination of settings using **Quick adjust**, or make manual adjustments to individual settings.

### 1 Select a Picture Control.

Highlight **Set Picture Control** in the shooting menu and press  $\odot$ . Highlight the desired Picture Control and press  $\odot$ .

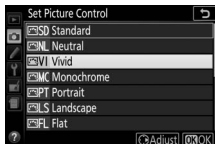

### 2 Adjust settings.

Press  $\odot$  or  $\odot$  to highlight the desired setting and press  $\odot$  or  $\odot$  to choose a value in increments of 1, or rotate the command dial to choose a value in increments of 0.25 (📖 158). Repeat this step until all settings have been adjusted, or select a preset combination of settings by using the multi selector to choose **Quick adjust**. Default settings can be restored by pressing the  $\text{🗑}$  button.



### 3 Save changes and exit.

Press  $\text{OK}$ .

Picture Controls that have been modified from default settings are indicated by an asterisk (\*).



## Picture Control Settings

Option	Description	
Quick adjust	Mute or heighten the effect of the selected Picture Control (note that this resets all manual adjustments). Not available with <b>Neutral</b> , <b>Monochrome</b> , <b>Flat</b> , or custom Picture Controls (☐ 161).	
Manual adjustments (all Picture Controls)	<b>Sharpening</b>	Control the sharpness of outlines. Select <b>A</b> to adjust sharpening automatically according to the type of scene.
	<b>Clarity</b>	Adjust clarity manually or select <b>A</b> to let the camera adjust clarity automatically. Depending on the scene, shadows may appear around bright objects or halos may appear around dark objects at some settings. Clarity is not applied to movies.
	<b>Contrast</b>	Adjust contrast manually or select <b>A</b> to let the camera adjust contrast automatically.
	<b>Brightness</b>	Raise or lower brightness without loss of detail in highlights or shadows.
Manual adjustments (non-monochrome only)	<b>Saturation</b>	Control the vividness of colors. Select <b>A</b> to adjust saturation automatically according to the type of scene.
	<b>Hue</b>	Adjust hue.
Manual adjustments (monochrome only)	<b>Filter effects</b>	Simulate the effect of color filters on monochrome photographs (☐ 160).
	<b>Toning</b>	Choose the tint used in monochrome photographs (☐ 160).

## ✔ "A" (Auto)



Results for auto sharpening, clarity, contrast, and saturation vary with exposure and the position of the subject in the frame.

## ✔ Switching Between Manual and Auto

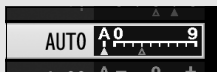
Press the  button to switch back and forth between manual and auto (A) settings for sharpening, clarity, contrast, and saturation.



## ✔ Custom Picture Controls

*Custom Picture Controls* are created through modifications to existing Picture Controls using the **Manage Picture Control** option in the shooting menu ( 161) and can be saved to a memory card for sharing among other cameras of the same model and compatible software ( 163).

## ✔ Previous Settings

The  indicator under the value display in the Picture Control setting menu indicates the previous value for the setting. Use this as a reference when adjusting settings.



## ✔ Custom Picture Control Options

The options available with custom Picture Controls are the same as those on which the custom Picture Control was based.

## ✔ Using the Touch Screen

To use the touch screen to modify a Picture Control in the **Set Picture Control** menu, tap the Picture Control once to highlight it and then tap the  **Adjust** button to view the menu shown in Step 2 on page 157. Tap a parameter once to highlight it and again to display options, then use the on-screen controls to choose a value (the multi selector can not be used). Note that the touch screen can only be used for this purpose if **Enable** is selected for **Touch controls**.





### Filter Effects (Monochrome Only)

The options in this menu simulate the effect of color filters on monochrome photographs. The following filter effects are available:



Option	Description
<b>Y</b> Yellow	Enhances contrast. Can be used to tone down the brightness of the sky in landscape photographs. Orange produces more contrast than yellow, red more contrast than orange.
<b>O</b> Orange	
<b>R</b> Red	
<b>G</b> Green	Softens skin tones. Can be used for portraits.

### Toning (Monochrome Only)

Pressing  when **Toning** is selected displays saturation options. Press  or  to adjust saturation in increments of 1, or rotate the command dial to choose a value in increments of 0.25. Saturation control is not available when **B&W** (black-and-white) is selected.



### Touch-Screen Character Entry

To type, tap the letters in the keyboard area (you can select letters by sliding a finger over the screen: the letters are highlighted as you touch them and are not entered in the text area until you lift your finger). To position the cursor, tap directly in the text area or tap the  or  buttons.

## Creating Custom Picture Controls

The Picture Controls supplied with the camera can be modified and saved as custom Picture Controls.

### 1 Select Manage Picture Control.

Highlight **Manage Picture Control** in the shooting menu and press **OK**.

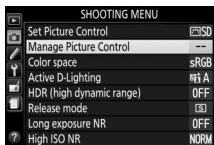

### 2 Select Save/edit.

Highlight **Save/edit** and press **OK**.

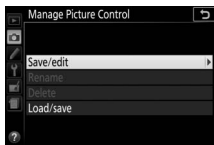

### 3 Select a Picture Control.

Highlight an existing Picture Control and press **OK**, or press **OK** to proceed to Step 5 to save a copy of the highlighted Picture Control without further modification.

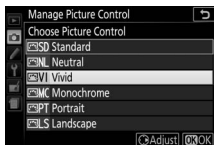

### 4 Edit the selected Picture Control.

See page 158 for more information. To abandon any changes and start over from default settings, press the **Reset** button. Press **OK** when settings are complete.



---



## 5 Select a destination.

Highlight a destination for the custom Picture Control (C-1 through C-9) and press .



---

## 6 Name the Picture Control.

By default, new Picture Controls are named by adding a two-digit number (assigned automatically) to the name of the existing Picture Control; to use the default name, proceed to Step 7. To move the cursor in the name area, rotate the command dial. To enter a new letter at the current cursor position, use the multi selector to highlight the desired character in the keyboard area and press . To delete the character at the current cursor position, press the  button.

*Name area*



*Keyboard area*

Custom Picture Control names can be up to nineteen characters long. Any characters after the nineteenth will be deleted.

---

## 7 Press .

Press  to save changes and exit. The new Picture Control will appear in the Picture Control list.





### ✔ **Manage Picture Control > Rename**

Custom Picture Controls can be renamed at any time using the **Rename** option in the **Manage Picture Control** menu.

### ✔ **Manage Picture Control > Delete**

The **Delete** option in the **Manage Picture Control** menu can be used to delete selected custom Picture Controls when they are no longer needed.

### ✔ **The Original Picture Control Icon**

The original preset Picture Control on which the custom Picture Control is based is indicated by an icon in the top right corner of the edit display.

*Original  
Picture Control icon*



### ✔ **Sharing Custom Picture Controls**

The **Load/save** item in the **Manage Picture Control** menu offers the options listed below. Use these options to copy custom Picture Controls to and from memory cards. Once copied to memory cards, Picture Controls can be used with other cameras or compatible software.

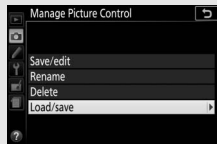

- **Copy to camera:** Copy custom Picture Controls from the memory card to custom Picture Controls C-1 through C-9 on the camera and name them as desired.
- **Delete from card:** Delete selected custom Picture Controls from the memory card.
- **Copy to card:** Copy a custom Picture Control (C-1 through C-9) from the camera to a selected destination (1 through 99) on the memory card.

# Recording and Viewing Movies

## Recording Movies

Movies can be recorded in live view mode.

### 1 Rotate the live view switch.

The view through the lens will be displayed in the monitor.

#### ✓ The Icon

A  icon (□ 11) indicates that movies can not be recorded.

#### ✓ Before Recording

If you are using a type E or PC-E NIKKOR lens (□ 305, 307), you can choose the aperture for modes **A** and **M** during live view (□ 122, 123).

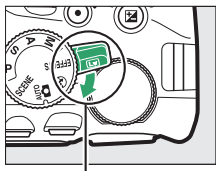

*Live view switch*

### 2 Focus.

Frame the opening shot and focus.

Note that the number of subjects that can be detected in face-priority AF drops during movie recording.



---

### 3 Start recording.

Press the movie-record button to start recording. A recording indicator and the time available are displayed in the monitor. Sound is recorded via the built-in microphone (📖 2); be careful not to obstruct the microphone during recording. Except in **AUTO** and **☺** modes, exposure can be locked by pressing the **AE-L/AF-L** (🔒) button (📖 130) or (in **SCENE**, **P**, **S**, **A**, and **📷** modes) altered by up to  $\pm 3$  EV in steps of  $\frac{1}{3}$  EV by pressing the **📷** (⊕) button and rotating the command dial (📖 132; note that depending on the brightness of the subject, changes to exposure may have no visible effect).

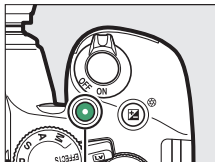

*Movie-record button*

#### *Time remaining*



*Recording indicator*

---

### 4 End recording.

Press the movie-record button again to end recording. Recording will end automatically when the maximum length is reached, the memory card is full, another mode is selected, or the monitor is closed (closing the monitor does not end recording on televisions or other external displays).

---

### 5 End live view.

Rotate the live view switch to end live view.

## The *i* Button

When movie indicators are displayed by pressing the **Info** button in live view mode, the following settings can be accessed by pressing the *i* button:

- Movie frame size/quality (📖 168)
- Microphone (📖 169)
- White balance (📖 140)
- Exposure compensation (📖 132) \*
- Picture Control (📖 155)
- Wind noise reduction (📖 169)
- Focus mode (📖 82)
- AF-area mode (📖 87)

\* ISO sensitivity will be displayed in place of exposure compensation if **On** is selected for **Movie settings > Manual movie settings** (📖 169) in mode **M**.

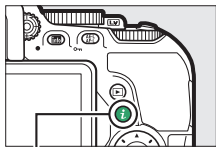

*i* button



### Taking Photographs During Movie Recording

To end movie recording, take a photograph, and exit to live view, press the shutter-release button all the way down and hold it in this position until the shutter is released. The touch shutter (📖 19) can not be used to take photos during movie recording.

### Maximum Length

The maximum length for individual movie files is 4 GB (for maximum recording times, see page 168); note that depending on memory card write speed, shooting may end before this length is reached (📖 324).

### ✓ Recording Movies

Flicker, banding, or distortion may be visible in the monitor and in the final movie under fluorescent, mercury vapor, or sodium lamps or with subjects that are in motion, particularly if the camera is panned horizontally or an object moves horizontally at high speed through frame (for information on reducing flicker and banding, see **Flicker reduction**;  268). Jagged edges, color fringing, moire, and bright spots may also appear. Bright regions or bands may appear in some areas of the frame with flashing signs and other intermittent light sources or if the subject is briefly illuminated by a strobe or other bright, momentary light source. Avoid pointing the camera at the sun or other strong light sources. Failure to observe this precaution could result in damage to the camera's internal circuitry.

The camera can record both video and sound; do not cover the microphone during recording. Note that the built-in microphone may record lens noise during autofocus and vibration reduction.

Flash lighting can not be used during movie recording.

Matrix metering is used regardless of the metering method selected. Shutter speed and ISO sensitivity are adjusted automatically unless **On** is selected for **Manual movie settings** ( 169) and the camera is in mode **M**.

## Movie Settings

Use the **Movie settings** option in the shooting menu (☰ 170) to adjust the following settings.

- **Frame size/frame rate and Movie quality:** The maximum length varies with the options selected.

Movie quality	Frame size/frame rate <sup>1</sup>	Maximum length <sup>2</sup>
High quality	 <b>1920×1080; 60p</b>	10 min.
	 <b>1920×1080; 50p</b>	
	 <b>1920×1080; 30p</b>	
	 <b>1920×1080; 25p</b>	20 min.
	 <b>1920×1080; 24p</b>	
	 <b>1280× 720; 60p</b>	
	 <b>1280× 720; 50p</b>	
Normal	 <b>1920×1080; 60p</b>	20 min.
	 <b>1920×1080; 50p</b>	
	 <b>1920×1080; 30p</b>	
	 <b>1920×1080; 25p</b>	29 min. 59 s
	 <b>1920×1080; 24p</b>	
	 <b>1280× 720; 60p</b>	
	 <b>1280× 720; 50p</b>	



1 Listed value. Actual frame rates for 60p, 50p, 30p, 25p, and 24p are 59.94, 50, 29.97, 25, and 23.976 fps respectively.

2 Movies recorded in miniature effect mode are up to three minutes long when played back.

- **Microphone:** Turn the built-in or optional stereo microphones (☞ 170, 323) on or off or adjust microphone sensitivity. Choose **Auto sensitivity** to adjust sensitivity automatically, **Microphone off** to turn sound recording off; to select microphone sensitivity manually, select **Manual sensitivity** and choose a sensitivity.
- **Wind noise reduction:** Select **On** to enable the low-cut filter for the built-in microphone (optional stereo microphones are unaffected; ☞ 170, 323), reducing noise produced by wind blowing over the microphone (note that other sounds may also be affected). Wind-noise reduction for optional stereo microphones can be enabled or disabled using microphone controls.
- **Manual movie settings:** Choose **On** to allow manual adjustments to shutter speed and ISO sensitivity when the camera is in mode **M**. Shutter speed can be set to values as fast as  $1/4000$  s; the slowest speed available varies with the frame rate:  $1/30$  s for frame rates of 24p, 25p, and 30p,  $1/50$  s for 50p, and  $1/60$  s for 60p. If shutter speed is not in this range when live view starts, it will automatically be set to a supported value, and remain at this value when live view ends. Note that ISO sensitivity is fixed at the value selected; the camera does not adjust ISO sensitivity automatically when **On** is selected for **ISO sensitivity settings > Auto ISO sensitivity control** in the shooting menu (☞ 228).

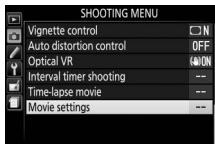
- 1 Select Movie settings.**  
Highlight **Movie settings** in the shooting menu and press .



- 2 Choose movie options.**  
Highlight the desired item and press , then highlight an option and press .

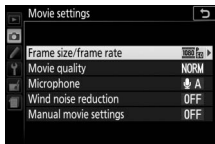

### Using an External Microphone

Optional stereo microphones can be used to reduce noise caused by lens vibration being recorded during autofocus.

### HDMI

When the camera is attached to an HDMI video device, the video device will display the view through the lens. If the device supports HDMI-CEC, select **Off** for the **HDMI > Device control** option in the setup menu ( 219) before shooting in live view.



## Time-Lapse Movies

The camera automatically takes photos at selected intervals to create a silent time-lapse movie using the options currently selected for **Frame size/frame rate** and **Movie quality** under **Movie settings** in the shooting menu (📖 168).

### 📌 Before Shooting

Time-lapse movies are shot using the movie crop; before shooting a time-lapse movie, take a test shot at current settings and view the results in the monitor. For consistent coloration, choose a white balance setting other than auto (📖 140).

Use of a tripod is recommended. Mount the camera on a tripod before shooting begins. To ensure that shooting is not interrupted, use an optional AC adapter and power connector or a fully-charged battery. To prevent light entering via the viewfinder interfering with photographs and exposure, cover the viewfinder with your hand or other object or attach the optional viewfinder eyepiece cap (📖 80).

## 1 Select Time-lapse movie.

Highlight **Time-lapse movie** in the shooting menu and press **▶** to display time-lapse movie settings.

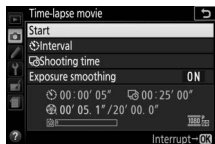
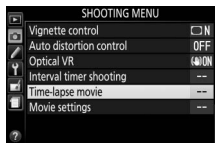

## 2 Adjust time-lapse movie settings.

Choose an interval, total shooting time, and exposure smoothing option.

- To choose the interval between frames:

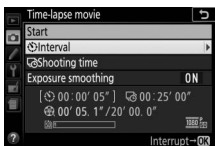

Highlight **Interval** and press .

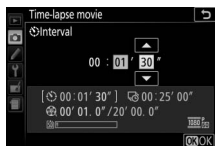

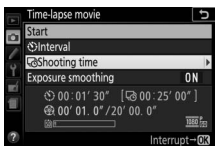

Choose an interval longer than the slowest anticipated shutter speed (minutes and seconds) and press .

- To choose the total shooting time:

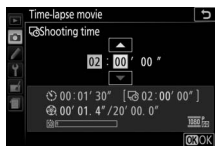

Highlight **Shooting time** and press .



Choose shooting time (up to 7 hours 59 minutes) and press .

• To enable or disable exposure smoothing:

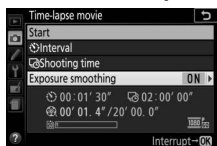

Highlight **Exposure smoothing** and press  $\odot$ .

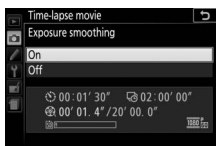

Highlight an option and press  $\odot$ .

Selecting **On** smooths abrupt changes in exposure in modes other than **M** (note that exposure smoothing only takes effect in mode **M** if auto ISO sensitivity control is enabled in the shooting menu).

### 3 Start shooting.

Highlight **Start** and press  $\odot$ .

Shooting starts after about 3 s. The camera takes photographs at the selected interval for the selected shooting time. When complete, time-lapse movies are recorded to the memory card.

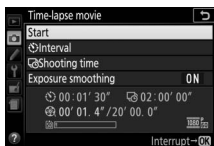

#### Calculating the Length of the Final Movie

The total number of frames in the final movie can be calculated by dividing the shooting time by the interval and rounding up. The length of the final movie can then be calculated by dividing the number of shots by the frame rate selected for **Frame size/frame rate** in the shooting menu (168). A 48 frame movie recorded at **1920 x 1080; 24p**, for example, will be about two seconds long. The maximum length for time-lapse movies is 20 minutes.

*Length recorded/  
maximum length*

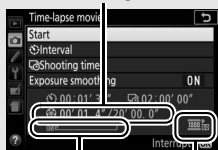

*Memory card  
indicator*

*Frame size/frame rate*













## ■ ■ *Ending Shooting*

To end shooting before all the photos are taken, press  between frames or immediately after a frame is recorded. A movie will be created from the frames shot to the point where shooting ended. Note that if the power source is removed or disconnected or the destination memory card is ejected, no movie will be recorded and shooting will end without a beep being sounded.

## ■ ■ *No Photograph*

The camera will skip the current frame if it is unable to focus for eight seconds or more in **AF-S** or when single-servo AF is selected in **AF-A** or **Focus** is selected for Custom Setting a1 (**AF-C priority selection**) in **AF-C** (note that the camera focuses again before each shot). Shooting will resume with the next frame.

## *Time-Lapse Movies*

Time-lapse is not available in special effects mode ( 65), during live view ( 9, 47) or movie recording ( 164), at a shutter speed of     or - - ( 125), or when the self-timer ( 79), bracketing ( 151), High Dynamic Range (HDR,  138), or interval timer photography ( 109) is active. Note that because shutter speed and the time needed to record the image to the memory card may vary from shot to shot, the interval between a shot being recorded and the start of the next shot may vary. Shooting will not begin if a time-lapse movie can not be recorded at current settings (for example, if the memory card is full, the interval or shooting time is zero, or the interval is longer than the shooting time).

Shooting may end if camera controls are used or settings are changed or HDMI cable is connected. A movie will be created from the frames shot to the point where shooting ended.

### During Shooting

The memory card access lamp lights while shooting is in progress. A message will appear in the information display if the  button is pressed between shots. The standby timer does not turn off, regardless of the option selected for Custom Setting c2 (**Auto off timers**) > **Standby timer**.



### Image Review

The  button can not be used to view pictures while shooting is in progress.



### Release Mode

Regardless of the release mode selected, the camera will take one shot at each interval.

### Opening and Closing the Monitor





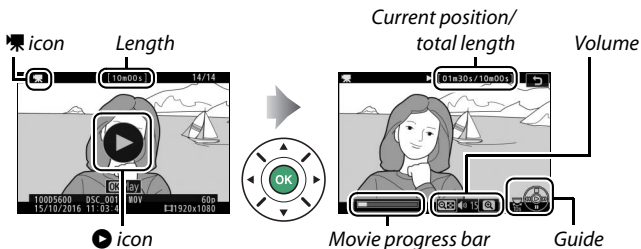

Returning the monitor to the storage position does not interrupt time-lapse movie recording.





## Viewing Movies

Movies are indicated by a  icon in full-frame playback ([184](#)). Tap the  icon in the monitor or press  to start playback; your current position is indicated by the movie progress bar.



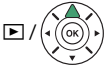

The following operations can be performed:

To	Use	Description
Pause		Pause playback.
Play		Resume playback when movie is paused or during rewind/advance.
Advance/ rewind		Speed increases with each press, from 2x to 4x to 8x to 16x; keep pressed to skip to beginning or end of movie (first frame is indicated by  in top right corner of monitor, last frame by  ). If playback is paused, movie rewinds or advances one frame at a time; hold for continuous rewind or advance.
Skip 10 s		Rotate the command dial one stop to skip ahead or back 10 s.

To	Use	Description
Adjust volume		Press  to increase volume,  (?) to decrease.
Return to full-frame playback		Press  or  to exit to full-frame playback.

## Editing Movies

Trim footage to create edited copies of movies or save selected frames as JPEG stills.

Option	Description
 <b>Choose start/end point</b>	Create a copy from which unwanted footage has been removed.
 <b>Save selected frame</b>	Save a selected frame as a JPEG still.





## Trimming Movies



To create trimmed copies of movies:

**1** Display a movie full frame.

**2** Pause the movie on the new opening frame.

Play the movie back as described on page 176, pressing  to start and resume playback and  to pause and pressing  or  or rotating the command dial to locate the desired frame. Your approximate position in the movie can be ascertained from the movie progress bar. Pause playback when you reach the new opening frame.



*Movie progress bar*



### 3 Select **Choose start/end point**.

Press the **i** button, then highlight **Choose start/end point** and press **OK**.

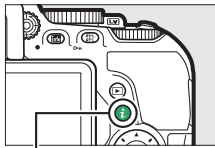

*i* button



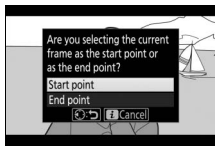

### 4 Select **Start point**.

To create a copy that begins from the current frame, highlight **Start point** and press **OK**. The frames before the current frame will be removed when you save the copy in Step 9.





*Start point*

## 5 Confirm the new start point.

If the desired frame is not currently displayed, press  or  to advance or rewind (to skip to 10 s ahead or back, rotate the command dial one stop).



## 6 Choose the end point.

Press  $\text{AE-L}$  () to switch from the start point () to the end point () selection tool and then select the closing frame as described in Step 5. The frames after the selected frame will be removed when you save the copy in Step 9.

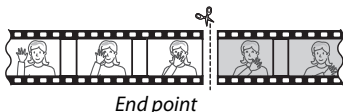

## 7 Create the copy.

Once the desired frame is displayed, press .

## 8 Preview the movie.

To preview the copy, highlight **Preview** and press  $\text{OK}$  (to interrupt the preview and return to the save options menu, press ). To abandon the current copy and select a new start point or end point as described on the foregoing pages, highlight **Cancel** and press  $\text{OK}$ ; to save the copy, proceed to Step 9.



## 9 Save the copy.

Highlight **Save as new file** and press **OK** to save the copy to a new file. To replace the original movie file with the edited copy, highlight **Overwrite existing file** and press **OK**.

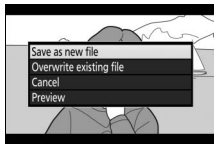

### ✓ Trimming Movies

Movies must be at least two seconds long. The copy will not be saved if there is insufficient space available on the memory card.

Copies have the same time and date of creation as the original.

### ✍ Removing Opening or Closing Footage

To remove only the opening footage from the movie, proceed to Step 7 without pressing the **AE-1** (**⏪**) button in Step 6. To remove only the closing footage, select **End point** in Step 4, select the closing frame, and proceed to Step 7 without pressing the **AE-1** (**⏪**) button in Step 6.

## Saving Selected Frames

To save a copy of a selected frame as a JPEG still:

- 1 Pause the movie on the desired frame.**

Play the movie back as described on page 176, pressing **OK** to start and resume playback and **STOP** to pause. Pause the movie at the frame you intend to copy.



- 2 Choose Save selected frame.**  
Press the **i** button, then highlight **Save selected frame** and press **OK**.

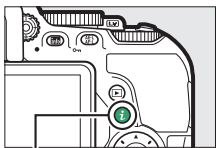

**i** button



- 3 Create a still copy.**  
Press **OK** to create a still copy of the current frame.



## 4 Save the copy.

Highlight **Yes** and press **OK** to create a fine-quality (📖 98) JPEG copy of the selected frame.

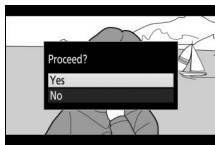

### Save Selected Frame

JPEG movie stills created with the **Save selected frame** option can not be retouched. JPEG movie stills lack some categories of photo information (📖 188).







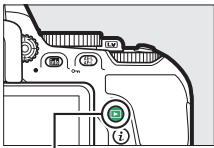



# Playback and Deletion

## Full-Frame Playback

To play photographs back, press the  button. The most recent photograph will be displayed in the monitor.







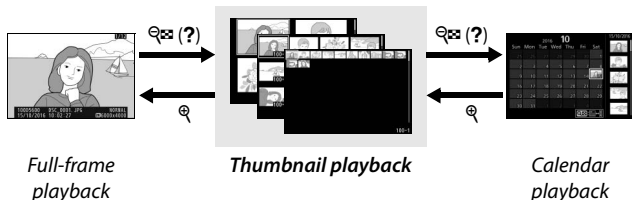

 button

To	Use	Description
View additional photographs		Press  to view photographs in order recorded,  to view photographs in reverse order.
View additional photo info		Change photo info displayed (  188).
Return to shooting mode		Press the  button or press the shutter-release button halfway to exit to shooting mode.
Play movie		If current picture is marked with  icon to show that it is a movie, pressing  starts movie playback (  176).

## Thumbnail Playback

To display images in “contact sheets” of 4, 12, or 80 images, press the  (?) button.



To	Use	Description
Highlight images		Use multi selector or command dial to highlight pictures.
View highlighted image		Press  to display the highlighted image full frame.
Return to shooting mode		Press the  button or press the shutter-release button halfway to exit to shooting mode.

## Calendar Playback

To view images taken on a selected date, press the (?) button when 80 images are displayed.

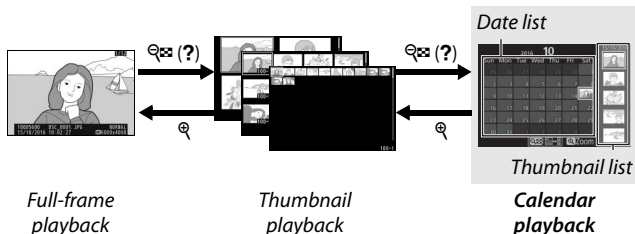

The operations that can be performed depend on whether the cursor is in the date list or the thumbnail list:

To	Use	Description
Toggle between date list and thumbnail list	(?)	Press  (?) or  button in date list to place cursor in thumbnail list. Press  (?) again to return to date list.
Exit to thumbnail playback/Zoom in on highlighted photo		<ul style="list-style-type: none"> <li>• <b>Date list:</b> Exit to 80-frame playback.</li> <li>• <b>Thumbnail list:</b> Press and hold  button to zoom in on highlighted picture.</li> </ul>
Highlight dates/Highlight images		<ul style="list-style-type: none"> <li>• <b>Date list:</b> Highlight date.</li> <li>• <b>Thumbnail list:</b> Highlight picture.</li> </ul>
Toggle full frame playback		<ul style="list-style-type: none"> <li>• <b>Thumbnail list:</b> View highlighted picture.</li> </ul>
Return to shooting mode	/	Press the  button or press the shutter-release button halfway to exit to shooting mode.



## The *i* Button

Pressing the *i* button in full-frame, thumbnail, or calendar playback displays the options listed below. Highlight items and press  $\odot$  to view options.

- **Rating:** Rate the current picture (📖 201).
- **Retouch (photographs only):** Use the options in the retouch menu (📖 277) to create a retouched copy of the current photograph.
- **Edit movie (movies only):** Edit movies using the options in the edit movie menu (📖 178). Movies can also be edited by pressing the *i* button when movie playback is paused.
- **Select to send to smart device/deselect (photographs only):** Select photos for upload to a smart device.

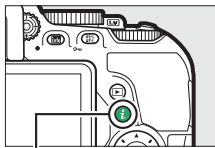

To exit the *i*-button menu and return to playback, press the *i* button again.



*i* button



## Photo Information

Photo information is superimposed on images displayed in full-frame playback. Press  or  to cycle through photo information as shown below. Note that “image only”, shooting data, RGB histograms, highlights, and overview data are only displayed if corresponding option is selected for **Playback display options** (📖 221). Location data are only displayed if embedded in the picture (📖 269).

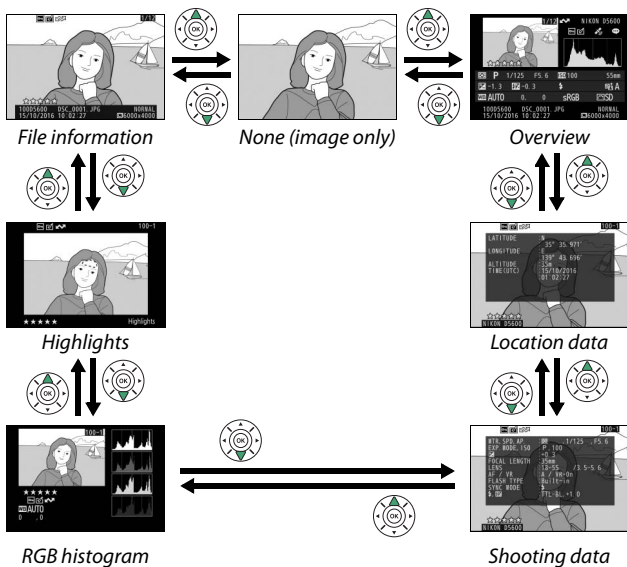

## File Information

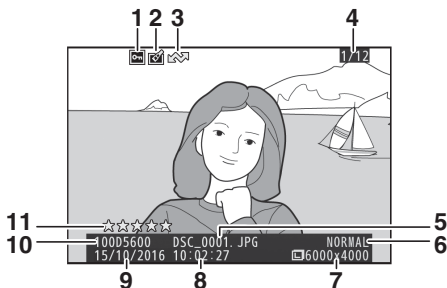

<b>1</b> Protect status.....	200	<b>7</b> Image size .....	100
<b>2</b> Retouch indicator .....	279	<b>8</b> Time of recording.....	40, 262
<b>3</b> Upload marking.....	203	<b>9</b> Date of recording .....	40, 262
<b>4</b> Frame number/total number of images		<b>10</b> Folder name .....	225
<b>5</b> File name.....	227	<b>11</b> Rating .....	201
<b>6</b> Image quality .....	98		

## Highlights\*

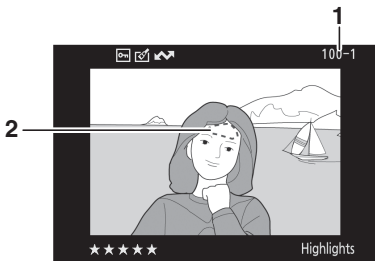

<b>1</b> Folder number—frame number.....	225	<b>2</b> Image highlights
--	-----	---------------------------

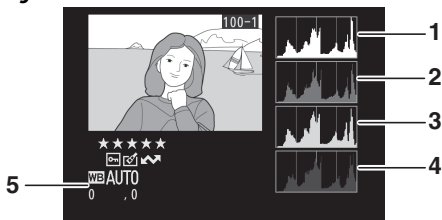

\* Flashing areas indicate highlights (areas that may be overexposed).

## ■ RGB Histogram



- |   |   |
|---|---|
| <p><b>1</b> Histogram (RGB channel). In all histograms, horizontal axis gives pixel brightness, vertical axis number of pixels.</p> <p><b>2</b> Histogram (red channel)</p> | <p><b>3</b> Histogram (green channel)</p> <p><b>4</b> Histogram (blue channel)</p> <p><b>5</b> White balance ..... 140<br/>White balance<br/>fine-tuning..... 143<br/>Preset manual ..... 145</p> |
|---|---|

### Playback Zoom

To zoom in on the photograph when the histogram is displayed, press . Use the  and  buttons to zoom in and out and scroll the image with the multi selector. The histogram will be updated to show only the data for the portion of the image visible in the monitor.



## Histograms

Camera histograms are intended as a guide only and may differ from those displayed in imaging applications. Some sample histograms are shown below:

If the image contains objects with a wide range of brightnesses, the distribution of tones will be relatively even.



If the image is dark, tone distribution will be shifted to the left.



If the image is bright, tone distribution will be shifted to the right.



Increasing exposure compensation shifts the distribution of tones to the right, while decreasing exposure compensation shifts the distribution to the left. Histograms can provide a rough idea of overall exposure when bright ambient lighting makes it difficult to see photographs in the monitor.

## ■ Shooting Data

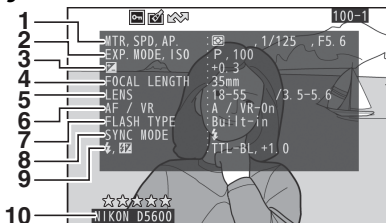

<p><b>1</b> Metering ..... 128</p> <p>Shutter speed ..... 118</p> <p>Aperture ..... 118</p> <p><b>2</b> Shooting mode ..... 47, 58, 65, 118</p> <p>ISO sensitivity<sup>1</sup> ..... 107</p> <p><b>3</b> Exposure compensation .... 132</p> <p><b>4</b> Focal length ..... 314</p> <p><b>5</b> Lens data</p>	<p><b>6</b> Focus mode ..... 82</p> <p>Lens VR (vibration reduction)<sup>2</sup> ..... 32, 232</p> <p><b>7</b> Flash type ..... 246, 315</p> <p>Commander mode<sup>2</sup> ..... 246</p> <p><b>8</b> Flash mode ..... 102, 104</p> <p><b>9</b> Flash control ..... 246</p> <p>Flash compensation ..... 134</p> <p><b>10</b> Camera name</p>
--	---

1 Displayed in red if photo was taken with auto ISO sensitivity control on.

2 Displayed only in photos taken with accessories that support this function.

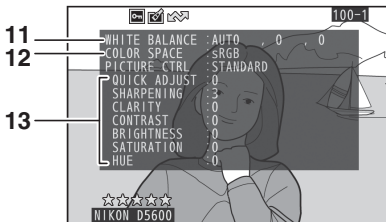

<p><b>11</b> White balance ..... 140</p> <p>White balance fine-tuning ..... 143</p> <p>Preset manual ..... 145</p>	<p><b>12</b> Color space ..... 230</p> <p><b>13</b> Picture Control * ..... 155</p>
--	---

\* Items displayed vary with Picture Control selected.

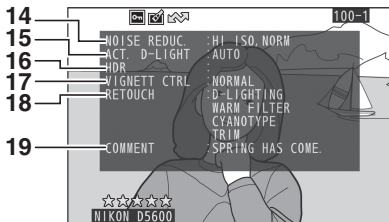

<p><b>14</b> High ISO noise reduction ... 231</p> <p>Long exposure noise reduction ..... 230</p> <p><b>15</b> Active D-Lighting ..... 136</p> <p><b>16</b> HDR (high dynamic range)..... 138</p>	<p><b>17</b> Vignette control.....231</p> <p><b>18</b> Retouch history.....277</p> <p><b>19</b> Image comment .....260</p>
--	--

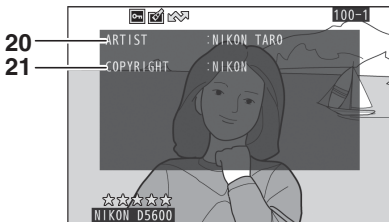

<p><b>20</b> Name of photographer * ..... 261</p>	<p><b>21</b> Copyright holder * .....261</p>
---	--

\* Copyright information is only displayed if recorded with the photograph using the **Copyright information** option in the setup menu.

## Overview Data

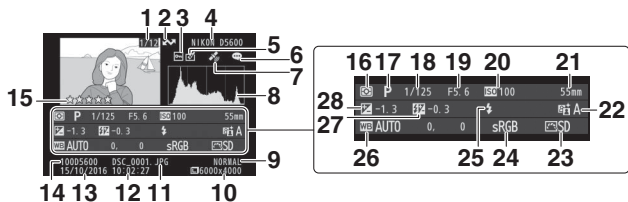

<b>1</b>	Frame number/total number of images	<b>16</b>	Metering..... 128
<b>2</b>	Upload marking ..... 203	<b>17</b>	Shooting mode..... 47, 58, 65, 118
<b>3</b>	Protect status ..... 200	<b>18</b>	Shutter speed..... 118
<b>4</b>	Camera name	<b>19</b>	Aperture ..... 118
<b>5</b>	Retouch indicator ..... 279	<b>20</b>	ISO sensitivity <sup>1</sup> ..... 107
<b>6</b>	Image comment indicator ..... 260	<b>21</b>	Focal length ..... 314
<b>7</b>	Location data indicator ..... 269	<b>22</b>	Active D-Lighting..... 136
<b>8</b>	Histogram showing the distribution of tones in the image (191).	<b>23</b>	Picture Control..... 155
<b>9</b>	Image quality ..... 98	<b>24</b>	Color space..... 230
<b>10</b>	Image size..... 100	<b>25</b>	Flash mode..... 102, 104
<b>11</b>	File name ..... 227	<b>26</b>	White balance ..... 140
<b>12</b>	Time of recording ..... 40, 262		White balance fine-tuning ..... 143
<b>13</b>	Date of recording..... 40, 262		Preset manual ..... 145
<b>14</b>	Folder name..... 225	<b>27</b>	Flash compensation..... 134
<b>15</b>	Rating..... 201		Commander mode <sup>2</sup> ..... 246
		<b>28</b>	Exposure compensation..... 132

1 Displayed in red if photo was taken with ISO sensitivity auto control on.

2 Displayed only in photos taken with accessories that support this function.















## ■■ *Location Data*

The latitude, longitude, and other location data are supplied by and vary with the GPS or smart device (📖 269). In the case of movies, the data give the location at the start of recording.

## Taking a Closer Look: Playback Zoom

Press the  button to zoom in on the image displayed in full-frame playback. The following operations can be performed while zoom is in effect:

To	Use	Description
Zoom in or out	 (?)	Press  to zoom in to maximum of approximately 33× (large images), 25× (medium images) or 13× (small images). Press  (?) to zoom out. While photo is zoomed in, use multi selector to view areas of image not visible in monitor. Keep multi selector pressed to scroll rapidly to other areas of frame. Navigation window is briefly displayed when zoom ratio is altered; area currently visible in monitor is indicated by yellow border. Zoom ratio is shown by bar at bottom of navigation window; when zoom ratio is 100%, bar is displayed green.
View other areas of image		
Crop image		To crop image to area currently visible in monitor, press  and select <b>Trim</b> (  198).

To	Use	Description
Zoom in on faces	<b>z</b>	To zoom in on faces detected by camera, press <b>z</b> and select <b>Face zoom</b> (☞ 199). This option is available only if faces are detected. If faces are detected when the RGB histogram (☞ 190) display is zoomed in, <b>Face zoom</b> will be available in the <b>z</b> -button menu ( <b>Trim</b> , however, will not be available).
View other images		Rotate command dial to view same location in other images at current zoom ratio. Playback zoom is cancelled when a movie is displayed.
Cancel zoom		Cancel zoom and return to full-frame playback.
Return to shooting mode		Press the  button or press the shutter-release button halfway to exit to shooting mode.

## ■ Cropping Photos

Follow the steps below to crop photos displayed during playback zoom to the area currently visible in the monitor.

### 1 Press **i**.

After adjusting zoom and scrolling the photo until only the area you wish to keep is visible in the monitor, press the **i** button.

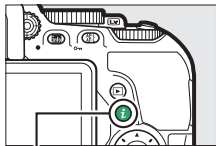

**i** button

### 2 Select **Trim**.

Highlight **Trim** and press **⏪**.



### 3 Select **Done**.

Highlight **Done** and press **OK** to create a cropped copy containing only the portion of the image displayed in the monitor.

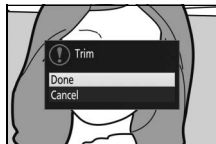

## ■ ■ Face Zoom

To zoom in on a face detected by the camera, press the **i** button in the zoom display and then highlight **Face zoom** and press **OK**.

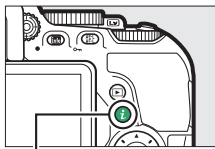



*i* button

The current subject is indicated by a white frame in the navigation window. Press **Q** or **Q** (?) to zoom in or out, or use the multi selector to view other faces.



## Protecting Photographs from Deletion

Press the  $\text{AE-L/AF-L}$  (O-n) button to protect the current picture from accidental deletion. Protected files are marked with a  icon and can not be deleted using the  button or the **Delete** option in the playback menu. Note that protected images will be deleted when the memory card is formatted (📖 259). To remove protection from a picture so that it can be deleted, display or highlight it and press the  $\text{AE-L/AF-L}$  (O-n) button.

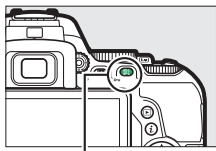

$\text{AE-L/AF-L}$  (O-n) button



### Removing Protection from All Images

To remove protection from all images in the folder or folders currently selected in the **Playback folder** menu (📖 221), press the  $\text{AE-L/AF-L}$  (O-n) and  buttons together for about two seconds during playback.

## Rating Pictures

Rate pictures or mark them as candidates for later deletion. Ratings can also be viewed in ViewNX-i and Capture NX-D. Rating is not available with protected images.

### Rating Individual Pictures

- 1 Select an image.**  
Display or highlight the image.

- 2 Display playback options.**  
Press the **i** button to display playback options.

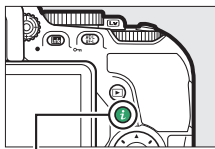

*i* button

- 3 Select Rating.**  
Highlight **Rating** and press **OK**.

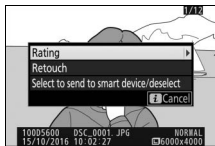

- 4 Choose a rating.**  
Press **▲** or **▼** to choose a rating of from zero to five stars, or select **🗑️** to mark the picture as a candidate for later deletion. Press **OK** to complete the operation.



## Rating Multiple Pictures

Use the **Rating** option in the playback menu to rate multiple pictures.

### 1 Select Rating.

Highlight **Rating** in the playback menu and press  $\odot$ .

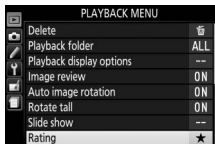

### 2 Rate pictures.

Press  $\odot$  or  $\odot$  to highlight pictures (to view the currently highlighted picture full frame, press and hold the  $\mathcal{Q}$  button) and press  $\odot$  or  $\odot$  to choose a rating of from zero to five stars, or select  $\mathcal{X}$  to mark the picture as a candidate for later deletion. Press  $\odot$  to complete the operation.





## Selecting Photos for Upload

Follow the steps below to select photos for upload to the smart device before connecting. Movies can not be selected for upload.

### Selecting Individual Photos

#### 1 Select a photo.

Display the photo or highlight it in the thumbnail list in thumbnail playback.

#### 2 Display playback options.

Press the **i** button to display playback options.

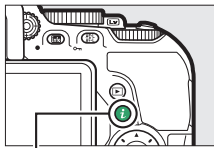

*i* button

#### 3 Choose **Select to send to smart device/deselect**.

Highlight **Select to send to smart device/deselect** and press **OK**.

Pictures selected for upload are indicated by a  icon; to deselect, display or highlight the image and repeat Steps 2 and 3.

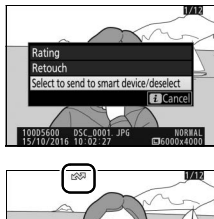

## Selecting Multiple Photos

Follow the steps below to change the upload status of multiple photos.

### 1 Choose **Select image(s)**.

In the playback menu, select **Select to send to smart device**, then highlight **Select image(s)** and press **OK**.

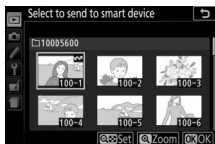

### 2 Select photos.

Use the multi selector to highlight photos and press the **Multi-selector (?)** button to select or deselect (to view the highlighted picture full screen, press and hold the **Multi-selector (?)** button). Selected photos are marked by a **checkmark** icon.

### 3 Press **OK**.

Press **OK** to complete the operation.

#### **✓ Deselecting All Photos**

To deselect all photos, select **Select to send to smart device** in the playback menu, highlight **Deselect all**, and press **OK**. A confirmation dialog will be displayed; highlight **Yes** and press **OK** to remove upload marking from all photos on the memory card.

## Deleting Photographs

To delete the current photograph, press the  button. To delete multiple selected photographs, all photographs taken on a selected date, or all photographs in the current playback folder, use the **Delete** option in the playback menu. Once deleted, photographs can not be recovered. Note that pictures that are protected can not be deleted.

### During Playback

Press the  button to delete the current photograph.

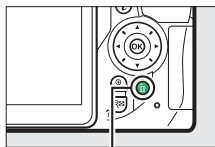

#### 1 Press the button.

A confirmation dialog will be displayed.



 button

#### 2 Press the button again.

To delete the photograph, press the  button again. To exit without deleting the photograph, press the  button.

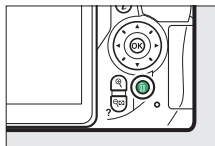



#### Calendar Playback

During calendar playback, you can delete all photographs taken on a selected date by highlighting the date in the date list and pressing the  button ([186](#)).



## The Playback Menu

The **Delete** option in the playback menu contains the following options. Note that depending on the number of images, some time may be required for deletion.

Option	Description
 <b>Selected</b>	Delete selected pictures.
 <b>Select date</b>	Delete all pictures taken on a selected date (□□ 207).
<b>ALL All</b>	Delete all pictures in the folder currently selected for playback (□□ 221).

### ■ Selected: Deleting Selected Photographs

#### 1 Select pictures.

Use the multi selector to highlight a picture and press the  (?) button to select or deselect (to view the highlighted picture full screen, press and hold the  button). Selected pictures are marked by a  icon. Repeat as desired to select additional pictures.

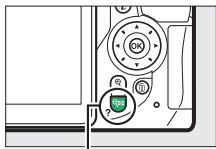

 (?) button





#### 2 Press to complete the operation.

A confirmation dialog will be displayed; highlight **Yes** and press .



## ■ ■ Select Date: Deleting Photographs Taken on a Selected Date

### 1 Select dates.

Highlight a date and press  to select all pictures taken on the highlighted date. Selected dates are indicated by check marks. Repeat as desired to select additional dates; to deselect a date, highlight it and press .

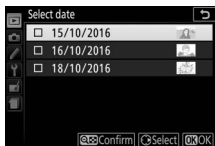

### 2 Press to complete the operation.

A confirmation dialog will be displayed; highlight **Yes** and press .



## Slide Shows

The **Slide show** option in the playback menu is used to display a slide show of the pictures in the current playback folder (📖 221).

### 1 Select Slide show.

Highlight **Slide show** in the playback menu and press .

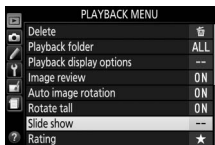





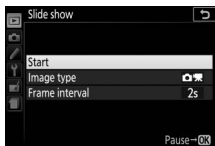





### 2 Start the slide show.

Highlight **Start** in the slide show menu and press .



The following operations can be performed while the slide show is in progress:

To	Use	Description
Skip back/skip ahead		Press  to return to previous frame,  to skip to next frame.
View additional photo info		Change photo info displayed (📖 188).
Pause		Pause slide show. Select <b>Restart</b> to resume.
Raise/lower volume	 /  (?)	Press  during movie playback to increase volume,  (?) to decrease.
Exit to playback mode		End show and return to playback mode.

The dialog shown at right is displayed when the show ends. Select **Restart** to restart or **Exit** to return to the playback menu.



## Slide Show Options

Before starting a slide show, you can use the options in the slide show menu to select the images displayed by type or rating and choose how long each image is displayed.

- **Image type:** Choose from **Still images and movies**, **Still images only**, **Movies only**, and **By rating**. To include only pictures with selected ratings, highlight **By rating** and press **Enter**. A list of ratings will be displayed; highlight ratings and press **Enter** to select or deselect pictures with the highlighted rating for inclusion in the slide show. Selected ratings are indicated by a check mark. Press **OK** to exit when the desired ratings are selected.
- **Frame interval:** Choose how long still images are displayed.

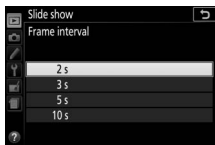
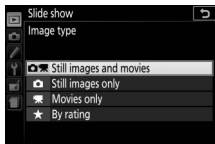

# Connections

## Installing ViewNX-i

To fine-tune photos and upload and view pictures, download the latest version of the ViewNX-i installer from the following website and follow the on-screen instructions to complete installation. An Internet connection is required. For system requirements and other information, see the Nikon website for your region.

*<http://downloadcenter.nikonimglib.com/>*

### Capture NX-D

Use Nikon's Capture NX-D software to fine-tune photos or to change settings for NEF (RAW) pictures and save them in other formats.

Capture NX-D is available for download from:

*<http://downloadcenter.nikonimglib.com/>*



## Copying Pictures to the Computer

Before proceeding, be sure you have installed ViewNX-i (📖 210).

### 1 Connect the USB cable.

After turning the camera off and ensuring that a memory card is inserted, connect a USB cable (available separately) as shown and then turn the camera on.

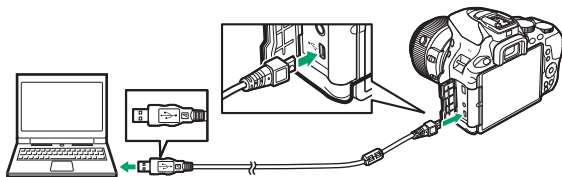

#### ✔ USB Hubs

Connect the camera directly to the computer; do not connect the cable via a USB hub or keyboard.

#### ✔ Use a Reliable Power Source

To ensure that data transfer is not interrupted, be sure the camera battery is fully charged.

#### ✔ Connecting Cables

Be sure the camera is off when connecting or disconnecting interface cables. Do not use force or attempt to insert the connectors at an angle.

## 2 Start Nikon Transfer 2 component of ViewNX-i.

If a message is displayed prompting you to choose a program, select Nikon Transfer 2.

### ✓ During Transfer

Do not turn the camera off or disconnect the USB cable while transfer is in progress.

### ✍ Windows 7

If the following dialog is displayed, select Nikon Transfer 2 as described below.

- 1 Under **Import pictures and videos**, click **Change program**. A program selection dialog will be displayed; select Nikon Transfer 2 and click **OK**.



- 2 Double-click .

### ✍ Windows 10 and Windows 8.1

Windows 10 and Windows 8.1 may display an AutoPlay prompt when the camera is connected. Tap or click the dialog and then tap or click **Nikon Transfer 2** to select Nikon Transfer 2.

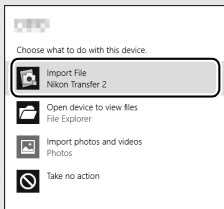
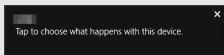

### ✍ OSX

If Nikon Transfer 2 does not start automatically, confirm that the camera is connected and then launch Image Capture (an application that comes with OS X) and select Nikon Transfer 2 as the application that opens when the camera is detected.

---

### 3 Click **Start Transfer**.

Pictures on the memory card will be copied to the computer.



**Start Transfer**

---

### 4 Terminate the connection.

When transfer is complete, turn the camera off and disconnect the USB cable.

 **For More Information**

Consult online help for more information on using ViewNX-i.

## Printing Photographs

Selected JPEG images can be printed on a PictBridge printer (📖 365) connected directly to the camera.

### Connecting the Printer

Connect the camera using a USB cable (available separately). Do not use force or attempt to insert the connectors at an angle.

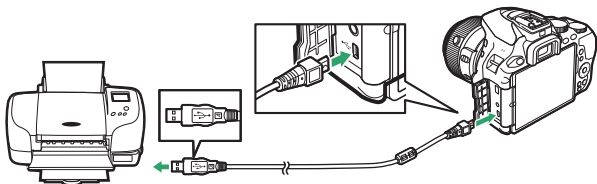

When the camera and printer are turned on, a welcome screen will be displayed in the monitor, followed by a PictBridge playback display.

#### ✔ **Selecting Photographs for Printing**

NEF (RAW) photographs (📖 98) can not be selected for printing. JPEG copies of NEF (RAW) images can be created using the **NEF (RAW) processing** option in the retouch menu (📖 280).

#### ✔ **Date Imprint**

If you select **On** for **Print date** in the PictBridge menu when printing photographs containing date information recorded using Custom Setting d4 (**Date stamp**; 📖 243), the date will appear twice. The imprinted date may however be cropped out if the photographs are cropped or printed without a border.

## Printing Pictures One at a Time

---

### 1 Display the desired picture.

Press or to view additional pictures. Press the button to zoom in on the current frame ( 196; press to exit zoom). To view eight pictures at a time, press the (?) button. Use the multi selector to highlight pictures, or press to display the highlighted picture full frame.

---



### 2 Adjust printing options.

Press to display the following items, then press or to highlight an item and press to view options (only options supported by the current printer are listed; to use the default option, select **Printer default**). After selecting an option, press to return to the printer settings menu.

Option	Description
Page size	Choose a page size.
No. of copies	This option is listed only when pictures are printed one at a time. Press  or  to choose number of copies (maximum 99).
Border	Choose whether to frame photos in white borders.
Print date	Choose whether to print the times and dates of recordings on photos.
Cropping	This option is listed only when pictures are printed one at a time. To exit without cropping, highlight <b>No cropping</b> and press . To crop the current picture, highlight <b>Crop</b> and press . A crop selection dialog will be displayed; press  to increase the size of the crop,  (?) to decrease, and use the multi selector to position the crop. Note that print quality may drop if small crops are printed at large sizes.

---

### 3 Start printing.

Select **Start printing** and press  to start printing. To cancel before all copies have been printed, press .

---

## Printing Multiple Pictures

---











### 1 Display the PictBridge menu.

Press the **MENU** button in the PictBridge playback display.

---

### 2 Choose an option.

Highlight one of the following options and press .

- **Print select:** Select pictures for printing. Press  or  to scroll through pictures (to view the highlighted picture full screen, press and hold the  button) and press  or  to choose the number of prints. To deselect a picture, set the number of prints to zero.
- **Select date:** Print one copy of all the pictures taken on a selected date. Press  or  to highlight a date and press  to select or deselect. To view the pictures taken on the selected date, press  (?). Use the multi selector to scroll through the pictures, or press and hold  to view the current picture full screen. Press  (?) again to return to the date selection dialog.
- **Index print:** To create an index print of all JPEG pictures on the memory card, proceed to Step 3. Note that if the memory card contains more than 256 pictures, only the first 256 images will be printed. A warning will be displayed if the page size selected in Step 3 is too small for an index print.



---

### 3 Adjust printer settings.

Adjust printer settings as described in Step 2 on page 215.

---

### 4 Start printing.

Select **Start printing** and press  to start printing. To cancel before all copies have been printed, press .

## Viewing Pictures on TV

The optional High-Definition Multimedia Interface (HDMI) cable (📖 324) can be used to connect the camera to high-definition video devices. Always turn the camera off before connecting or disconnecting an HDMI cable.

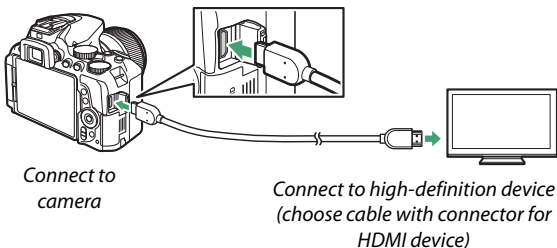

Tune the device to the HDMI channel, then turn the camera on and press the  button. During playback, images will be displayed on the television screen. Note that the edges of images may not be displayed.

### Playback Volume

Volume can be adjusted using television controls; the camera controls can not be used.

### Television Playback

Use of an AC adapter (available separately) is recommended for extended playback.



## ■ ■ Choosing an Output Resolution

To choose the format for images output to the HDMI device, select **HDMI** >

**Output resolution** in the camera setup menu (📖 258). If **Auto** is selected, the camera will automatically select the appropriate format.

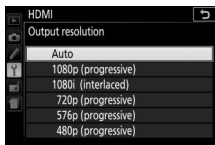

## ■ ■ Controlling the Camera with the TV Remote

If **On** is selected for **HDMI** > **Device control** in the setup menu (📖 258) when the camera is connected to a television that supports HDMI-CEC and both the camera and television are on, the television remote can be used in place of the camera multi selector and  button during full-frame playback and slide shows. If **Off** is selected, the television remote can not be used to control the camera, but the camera can be used to shoot photographs and movies in live view.

### ✔ HDMI-CEC Devices

HDMI-CEC (High-Definition Multimedia Interface–Consumer Electronics Control) is a standard that allows HDMI devices to be used to control peripherals to which they are connected. When the camera is connected to an HDMI-CEC device,  will appear in the viewfinder in place of the number of exposures remaining.

### ✔ 1920 × 1080 60p/50p

Selecting **1920 × 1080; 60p** or **1920 × 1080; 50p** for **Movie settings** > **Frame size/frame rate** may cause variations in the resolution and frame rate of the data output to HDMI devices during recording.

### ✔ HDMI > Output Resolution

Movies can not be output at resolutions of **1920 × 1080; 60p** or **1920 × 1080; 50p**. Some devices may not support an **Output resolution** setting of **Auto**.

# Camera Menu

## ▶ The Playback Menu: *Managing Images*

To display the playback menu, press **MENU** and select the ▶ (playback menu) tab.

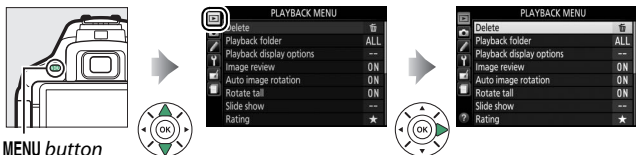

## Playback Menu Options

The playback menu contains the following options:

Option	Default	
<b>Delete</b>	—	206
<b>Playback folder</b>	All	221
<b>Playback display options</b>	—	221
<b>Image review</b>	On	221
<b>Auto image rotation</b>	On	222
<b>Rotate tall</b>	On	222
<b>Slide show</b>		
<b>Image type</b>	Still images and movies	208
<b>Frame interval</b>	2 s	
<b>Rating</b>	—	202
<b>Select to send to smart device</b>	—	204

## Playback Folder





MENU button →  playback menu

Choose a folder for playback:

Option	Description
<b>D5600</b>	Pictures in all folders created with the D5600 will be visible during playback.
<b>All</b>	Pictures in all folders will be visible during playback.
<b>Current</b>	Only photos in the folder currently selected for <b>Storage folder</b> in the shooting menu (  225) are displayed during playback.

## Playback Display Options

MENU button →  playback menu

Choose the information available in the playback photo information display ( 188). Press  or  to highlight and press  to select or deselect. Selected items are indicated by check marks. To return to the playback menu, press .

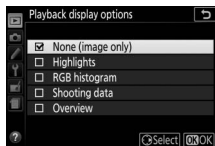

## Image Review

MENU button →  playback menu

Choose whether pictures are automatically displayed in the monitor immediately after shooting. If **Off** is selected, pictures can only be displayed by pressing the  button.

## Auto Image Rotation

MENU button →  playback menu

Photographs taken while **On** is selected contain information on camera orientation, allowing them to be rotated automatically during playback or when viewed in ViewNX-i or in Capture NX-D (p 210). The following orientations are recorded:



*Landscape (wide)  
orientation*



*Camera rotated 90°  
clockwise*



*Camera rotated 90°  
counterclockwise*

Camera orientation is not recorded when **Off** is selected. Choose this option when panning or taking photographs with the lens pointing up or down.

## Rotate Tall

MENU button →  playback menu

If **On** is selected, “tall” (portrait-orientation) pictures will be automatically rotated for display in the monitor (pictures taken with **Off** selected for **Auto image rotation** will still be displayed in landscape orientation). Note that because the camera itself is already in the appropriate orientation during shooting, images are not rotated automatically during image review.

## The Shooting Menu: *Shooting Options*

To display the shooting menu, press **MENU** and select the  (shooting menu) tab.

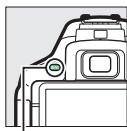

MENU button

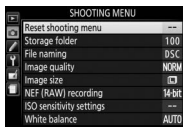

### Shooting Menu Options

The shooting menu contains the following options:

Option	Default	
<b>Reset shooting menu</b>	—	225
<b>Storage folder</b>	—	225
<b>File naming</b>	DSC	227
<b>Image quality</b>	JPEG normal	98
<b>Image size</b>	Large	100
<b>NEF (RAW) recording</b>	14-bit	227
<b>ISO sensitivity settings</b>		
<b>ISO sensitivity</b>	P, S, A, M	100
	Other modes	Auto
<b>Auto ISO sensitivity control</b>	Off	228
<b>White balance</b>	Auto	140
<b>Fluorescent</b>	Cool-white fluorescent	141
<b>Set Picture Control</b>	Standard	155
<b>Manage Picture Control</b>	—	161
<b>Color space</b>	sRGB	230
<b>Active D-Lighting</b>	Auto	136
<b>HDR (high dynamic range)</b>	Off	138

Option	Default	📖
<b>Release mode</b>		
	Continuous H	75
Other modes	Single frame	
<b>Long exposure NR</b>	Off	230
<b>High ISO NR</b>	Normal	231
<b>Vignette control</b>	Normal	231
<b>Auto distortion control</b>	Off	232
<b>Optical VR*</b>	On	232
<b>Interval timer shooting</b>		
<b>Start options</b>	Now	110
<b>Interval</b>	1 min.	110
<b>Number of times</b>	1	111
<b>Exposure smoothing</b>	Off	111
<b>Time-lapse movie</b>		
<b>Interval</b>	5 sec.	172
<b>Shooting time</b>	25 sec.	172
<b>Exposure smoothing</b>	On	173
<b>Movie settings</b>		
<b>Frame size/frame rate</b>	1920 × 1080; 60p	168
<b>Movie quality</b>	Normal	
<b>Microphone</b>	Auto sensitivity	
<b>Wind noise reduction</b>	Off	
<b>Manual movie settings</b>	Off	

\* Available only with lenses that support this item.

**Note:** Depending on camera settings, some items may be grayed out and unavailable.

## Reset Shooting Menu

MENU button →  shooting menu

Select **Yes** to reset shooting menu settings.

## Storage Folder

MENU button →  shooting menu

Select the folder in which subsequent images will be stored.

### ■ ■ *Selecting Folders by Folder Number*







---



#### 1 Choose **Select folder by number**.

Highlight **Select folder by number** and press .

---

#### 2 Choose a folder number.

Press  or  to highlight a digit, press  or  to change. If a folder with the selected number already exists, a , , or  icon will be displayed to the left of the folder number:

-  : Folder is empty.
-  : Folder is partially full.
-  : Folder contains 999 pictures or a picture numbered 9999. No further pictures can be stored in this folder.

---

#### 3 Save changes and exit.

Press  to complete the operation and return to the main menu (to exit without choosing the storage folder, press the MENU button). If a folder with the specified number does not already exist, a new folder will be created. Subsequent photographs will be stored in the selected folder unless it is already full.



## ■ Selecting Folders from a List

### 1 Choose **Select folder from list**.

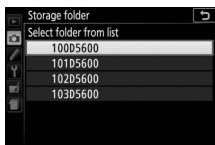
Highlight **Select folder from list** and press .



### 2 Highlight a folder.

Press  or  to highlight a folder.

### 3 Select the highlighted folder.

Press  to select the highlighted folder and return to the main menu. Subsequent photographs will be stored in the selected folder.

#### **Folder and File Numbers**

If the current folder is numbered 999 and contains 999 pictures or a picture numbered 9999, the shutter-release will be disabled and no further photographs can be taken. To continue shooting, create a folder with a number less than 999, or select an existing folder with a number less than 999 and less than 999 images.

#### **Startup Time**

Additional time may be required for camera startup if the memory card contains a very large number of files or folders.



## File Naming

MENU button →  shooting menu

Photographs are saved using file names consisting of “DSC\_” or, in the case of images that use the Adobe RGB color space (📖 230), “\_DSC”, followed by a four-digit number and a three-letter extension (e.g., “DSC\_0001.JPG”). The **File naming** option is used to select three letters to replace the “DSC” portion of the file name. For information on editing file names, see page 162.

### Extensions

The following extensions are used: “.NEF” for NEF (RAW) images, “.JPG” for JPEG images, “.MOV” for movies, and “.NDF” for dust off reference data. In each pair of photographs recorded at image-quality settings of NEF (RAW)+JPEG, the NEF and JPEG images have the same file names but different extensions.

## NEF (RAW) Recording

MENU button →  shooting menu

Choose the bit depth for NEF (RAW) images.

Option	Description
12-bit <b>12-bit</b>	NEF (RAW) images are recorded at a bit depth of 12 bits.
14-bit <b>14-bit</b>	NEF (RAW) images are recorded at a bit depth of 14 bits, producing files larger than those with a bit depth of 12 bits but increasing the color data recorded.

## ISO Sensitivity Settings

MENU button →  shooting menu

Adjust ISO sensitivity (📖 107).

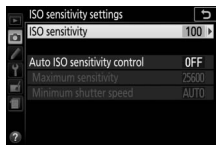

### ■ Auto ISO Sensitivity control

If **Off** is chosen for **Auto ISO sensitivity control** in **P**, **S**, **A**, and **M** modes, ISO sensitivity will remain fixed at the value selected by the user (📖 107). When **On** is chosen, ISO sensitivity will automatically be adjusted if optimal exposure can not be achieved at the value selected by the user. The maximum value for auto ISO sensitivity can be selected using the **Maximum sensitivity** option in the **Auto ISO sensitivity control** menu (choose lower values to prevent noise (randomly-spaced bright pixels, fog, or lines), but note that if the ISO sensitivity selected by the user is higher than that chosen for **Maximum sensitivity**, the value selected by the user will be used instead; the minimum value for auto ISO sensitivity is automatically set to ISO 100). In modes **P** and **A**, sensitivity will only be adjusted if underexposure would result at the shutter speed selected for **Minimum shutter speed** ( $1/2000$ –30 s, or **Auto**; in modes **S** and **M**, sensitivity will be adjusted for optimal exposure at the shutter speed selected by the user). If **Auto** (available only with CPU lenses) is selected, the camera will choose the minimum shutter speed based on the focal length of the lens (auto shutter-speed selection can be fine-tuned by highlighting **Auto** and pressing ). Slower shutter speeds will be used only if optimal exposure can not be achieved at the ISO sensitivity value selected for **Maximum sensitivity**.

When **On** is selected, the viewfinder shows **ISO AUTO** and the information display **ISO-A**. These indicators flash when sensitivity is altered from the value selected by the user.



### **Maximum Sensitivity/Minimum Shutter Speed**

When auto ISO sensitivity control is enabled, the ISO sensitivity and shutter speed graphics in the information display show the maximum sensitivity and minimum shutter speed.

*Minimum shutter speed*



*Maximum sensitivity*

### **Auto ISO Sensitivity Control**

Note that ISO sensitivity may be raised automatically when auto ISO sensitivity control is used in combination with slow sync flash modes (available with the built-in flash and the optional flash units listed on page 315), possibly preventing the camera from selecting slow shutter speeds.

## Color Space

MENU button →  shooting menu

The color space determines the gamut of colors available for color reproduction. **sRGB** is recommended for general-purpose printing and display; **Adobe RGB**, with its broader gamut of colors, for professional publication and commercial printing. Regardless of the option selected, movies are recorded in sRGB.

### Adobe RGB

For accurate color reproduction, Adobe RGB images require applications, displays, and printers that support color management.

### Color Space

ViewNX-i and Capture NX-D automatically select the correct color space when opening photographs created with this camera. Results can not be guaranteed with third-party software.

## Long Exposure NR

MENU button →  shooting menu

If **On** is selected, photographs taken at shutter speeds slower than 1 s will be processed to reduce noise (bright spots or fog). The time required for processing roughly doubles; during processing, “” will flash in the shutter speed/aperture displays and pictures can not be taken (if the camera is turned off before processing is complete, the picture will be saved but noise reduction will not be performed). In continuous release mode, frame rates will slow and while photographs are being processed, the capacity of the memory buffer will drop.



## High ISO NR

MENU button →  shooting menu

Photographs taken at high ISO sensitivities can be processed to reduce “noise.”

Option	Description
<b>High</b>	Reduce noise (randomly-spaced bright pixels), particularly in photographs taken at high ISO sensitivities. Choose the amount of noise reduction performed from <b>High</b> , <b>Normal</b> , and <b>Low</b> .
<b>Normal</b>	
<b>Low</b>	
<b>Off</b>	Noise reduction is performed only as required and never at an amount as high as when <b>Low</b> is selected.

## Vignette Control

MENU button →  shooting menu

“Vignetting” is a drop in brightness at the edges of a photograph. **Vignette control** reduces vignetting for type G, E, and D lenses (PC lenses excluded). Its effects vary from lens to lens and are most noticeable at maximum aperture. Choose from **High**, **Normal**, **Low**, and **Off**.

### Vignette Control

Depending on the scene, shooting conditions, and type of lens, JPEG images may exhibit noise (fog) or variations in peripheral brightness, while custom Picture Controls and preset Picture Controls that have been modified from default settings may not produce the desired effect. Take test shots and view the results in the monitor. Vignette control does not apply to movies (📖 164) or to pictures taken with lenses that support FX format.

## Auto Distortion Control

MENU button →  shooting menu

Select **On** to reduce barrel distortion when shooting with wide-angle lenses and to reduce pin-cushion distortion when shooting with long lenses (note that the edges of the area visible in the viewfinder may be cropped out of the final photograph, and that the time needed to process photographs before recording begins may increase). This option does not apply to movies and is available only with type G, E, and D lenses (PC, fisheye, and certain other lenses excluded); results are not guaranteed with other lenses.

### Retouch: Distortion Control

For information on creating copies of existing photographs with reduced barrel and pin-cushion distortion, see page 287.

## Optical VR

MENU button →  shooting menu

This item is displayed only with lenses that support it. Selecting **On** enables vibration reduction, which takes effect whenever the shutter-release button is pressed halfway ( 372). Select **Off** to disable vibration reduction.

### The Vibration Reduction Indicator

A vibration reduction indicator appears in the information display when **On** is selected for **Optical VR**.



## Custom Settings: Fine-Tuning Camera Settings

To display the Custom Settings menu, press **MENU** and select the  (Custom Settings menu) tab.

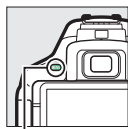

**MENU** button

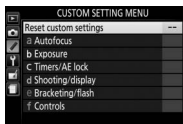
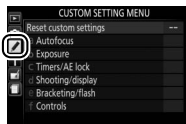

Custom Settings are used to customize camera settings to suit individual preferences.

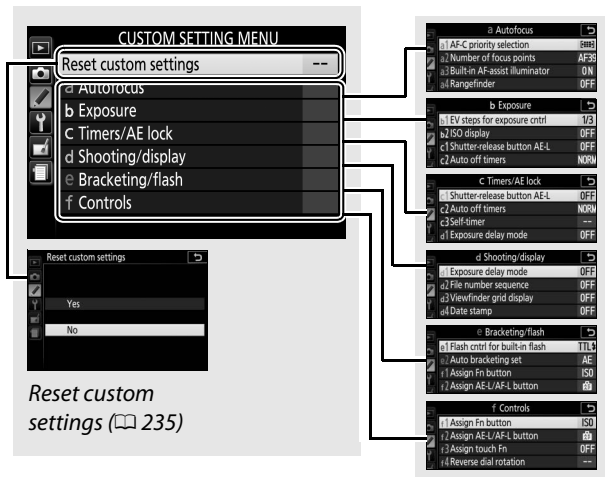

*Main menu*

*Custom Setting groups*



## Custom Settings

The following Custom Settings are available:

Custom Setting		Default	
<b>Reset custom settings</b>			235
<b>a Autofocus</b>			
a1	AF-C priority selection	Focus	235
a2	Number of focus points	39 points	236
a3	Built-in AF-assist illuminator	On	237
a4	Rangefinder	Off	237
a5	Manual focus ring in AF mode *	Enable	238
<b>b Exposure</b>			
b1	EV steps for exposure cntrl	1/3 step	239
b2	ISO display	Off	239
<b>c Timers/AE lock</b>			
c1	Shutter-release button AE-L	Off	239
c2	Auto off timers	Normal	240
c3	Self-timer	Self-timer delay: 10 s; Number of shots: 1	241
<b>d Shooting/display</b>			
d1	Exposure delay mode	Off	241
d2	File number sequence	Off	242
d3	Viewfinder grid display	Off	243
d4	Date stamp	Off	243
d5	Reverse indicators		245
<b>e Bracketing/flash</b>			
e1	Flash cntrl for built-in flash/ Optional flash	TTL	246
e2	Auto bracketing set	AE bracketing	251



	Custom Setting	Default	
<b>f</b>	<b>Controls</b>		
f1	Assign Fn button	ISO sensitivity	252
f2	Assign AE-L/AF-L button	AE/AF lock	254
f3	Assign touch Fn	Viewfinder grid display	255
f4	Reverse dial rotation	Exposure compensation: <input type="checkbox"/> Shutter speed/aperture: <input type="checkbox"/>	256

\* Available only with lenses that support this item.

**Note:** Depending on camera settings, some items may be grayed out and unavailable.

## Reset Custom Settings

MENU button → Custom Settings menu

Select **Yes** to restore Custom Settings to their default values.

## a: Autofocus

### a1: AF-C Priority Selection

MENU button → Custom Settings menu

When **AF-C** is selected for viewfinder photography ( 82), this option controls whether photographs can be taken whenever the shutter-release button is pressed (*release priority*) or only when the camera is in focus (*focus priority*).

Option	Description
<b>Release</b>	Photos can be taken whenever the shutter-release button is pressed.
<b>Focus</b>	Photos can only be taken once the camera has focused.

## a2: Number of Focus Points

MENU button →  Custom Settings menu

Choose the number of focus points available for manual focus-point selection.

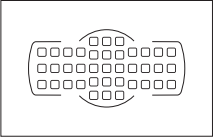
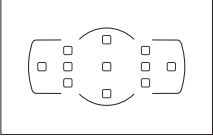
Option	Description
AF39 <b>39 points</b>	Choose from the 39 focus points shown at right. 
AF11 <b>11 points</b>	Choose from the 11 focus points shown at right. Use for quick focus-point selection. 

### a3: Built-in AF-assist Illuminator

MENU button →  Custom Settings menu

Choose whether the built-in AF-assist illuminator lights to assist the focus operation when lighting is poor.

AF-assist illuminator

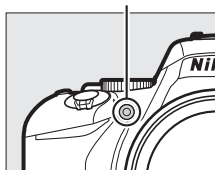







Option	Description
<b>On</b>	The AF-assist illuminator lights when lighting is poor (for more information, see page 342).
<b>Off</b>	The AF-assist illuminator does not light to assist the focus operation. The camera may not be able to focus using autofocus when lighting is poor.

### a4: Rangefinder

MENU button →  Custom Settings menu

Choose **On** to use the exposure indicator to determine whether the camera is correctly focused in manual focus mode (📖 95; note that this function is not available in shooting mode **M**, when the exposure indicator instead shows whether the subject is correctly exposed).

Indicator	Description
	Subject in focus.
	Focus point is slightly in front of subject.

Indicator	Description
	Focus point is well in front of subject.
	Focus point is slightly behind subject.
	Focus point is well behind subject.
	Camera can not determine correct focus.

### Using the Electronic Rangefinder

The electronic rangefinder requires a lens with a maximum aperture of  $f/5.6$  or faster. The desired results may not be achieved in situations in which the camera would be unable to focus using autofocus (□ 86). The electronic rangefinder is not available during live view.

## a5: Manual Focus Ring in AF Mode

MENU button →  Custom Settings menu

This item is displayed only with lenses that support it. Selecting **Enable** allows the lens focus ring to be used for manual focus when the camera is in autofocus mode; this is known as “autofocus with manual override” (M/A). After pressing the shutter-release button halfway to focus, keep the button pressed halfway and adjust focus using the focus ring. To refocus using autofocus, lift your finger from the shutter-release button and then press it halfway again. To prevent the lens focus ring being used for manual focus when the camera is in autofocus mode, select **Disable**.

## **b: Exposure**

### **b1: EV Steps for Exposure Cntrl**

MENU button →  Custom Settings menu

Select the increments used when making adjustments to shutter speed, aperture, exposure and flash compensation, and bracketing.

### **b2: ISO Display**

MENU button →  Custom Settings menu

Select **On** to display ISO sensitivity in the viewfinder in place of the number of exposures remaining.

## **c: Timers/AE Lock**

### **c1: Shutter-Release Button AE-L**



MENU button →  Custom Settings menu

If **On** is selected, exposure will lock when the shutter-release button is pressed halfway.

## c2: Auto off Timers

MENU button →  Custom Settings menu

This option determines how long the monitor remains on if no operations are performed during menu display and playback (**Playback/menus**), while photographs are displayed in the monitor after shooting (**Image review**), and during live view (**Live view**), and how long the standby timer, viewfinder, and information display remain on when no operations are performed (**Standby timer**). Choose shorter auto-off delays to reduce the drain on the battery.

Option	Description (all times are approximate)				
SHORT <b>Short</b> NORM <b>Normal</b> LONG <b>Long</b>	Auto off timers are set to the following values:				
		Playback/ menus	Image review	Live view	Standby timer
	Short	20 s	4 s	5 min.	4 s
	Normal	5 min.	4 s	10 min.	8 s
Long	10 min.	20 s	20 min.	1 min.	
 <b>Custom</b>	Choose separate delays for <b>Playback/menus</b> , <b>Image review</b> , <b>Live view</b> , and <b>Standby timer</b> . When settings are complete, press  .				



### Auto off Timers

The monitor and viewfinder will not turn off automatically when the camera is connected to a computer or printer via USB.

### c3: Self-Timer

MENU button →  Custom Settings menu

Choose the length of the shutter release delay and the number of shots taken.

- **Self-timer delay:** Choose the length of the shutter-release delay.
- **Number of shots:** Press  and  to choose the number of shots taken each time the shutter-release button is pressed (from 1 to 9; if a value other than 1 is selected, shots will be taken at intervals of about 4 seconds).

## d: Shooting/Display

### d1: Exposure Delay Mode

MENU button →  Custom Settings menu

In situations where the slightest camera movement can blur pictures, select **On** to delay shutter release until about 1 s after the shutter-release button is pressed and the mirror is raised.

## d2: File Number Sequence

MENU button →  Custom Settings menu

When a photograph is taken, the camera names the file by adding one to the last file number used. This option controls whether file numbering continues from the last number used when a new folder is created, the memory card is formatted, or a new memory card is inserted in the camera.

Option	Description
<b>On</b>	When a new folder is created, the memory card formatted, or a new memory card inserted in the camera, file numbering continues from the last number used or from the largest file number in the current folder, whichever is higher. If a photograph is taken when the current folder contains a photograph numbered 9999, a new folder will be created automatically and file numbering will begin again from 0001.
<b>Off</b>	File numbering is reset to 0001 when a new folder is created, the memory card formatted, or a new memory card inserted in the camera. Note that a new folder is created automatically if a photograph is taken when the current folder contains 999 photographs.
<b>Reset</b>	As for <b>On</b> , except that the next photograph taken is assigned a file number by adding one to the largest file number in the current folder. If the folder is empty, file numbering is reset to 0001.

### File Number Sequence

If the current folder is numbered 999 and contains either 999 photographs or a photograph numbered 9999, the shutter-release button will be disabled and no further photographs can be taken. Choose **Reset** for Custom Setting d2 (**File number sequence**) and then either format the current memory card or insert a new memory card.



### d3: Viewfinder Grid Display



MENU button →  Custom Settings menu

Choose **On** to display on-demand grid lines in the viewfinder for reference when composing photographs (📖 5).

### d4: Date Stamp

MENU button →  Custom Settings menu

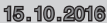
Choose the date information imprinted on photographs as they are taken. Date stamps can not be added to or removed from existing photos.

Option	Description
<b>Off</b>	The time and date do not appear on photographs.
DATE <b>Date</b>	The date or date and time are imprinted on 
DATE🕒 <b>Date and time</b>	photographs taken while this option is in effect. 
 <b>Date counter</b>	New photos are imprinted with a time stamp showing the number of days between the date of shooting and a selected date (see below).

At settings other than **Off**, the selected option is indicated by a **DATE** icon in the information display.



#### Date Stamp

The date is recorded in the order selected for **Time zone and date** (📖 262). The imprinted data may be cropped out or rendered illegible in copies created when images are retouched (📖 277). The date does not appear on NEF (RAW) or NEF (RAW)+JPEG images.

## ■ ■ Date Counter

Pictures taken while this option is in effect are imprinted with the number of days remaining until a future date or the number of days elapsed since a past date. Use it to track the growth of a child or count down the days until a birthday or wedding.

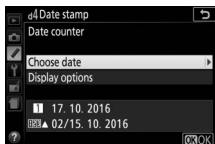

*Future date (two days remaining)*



*Past date (two days elapsed)*

The camera offers three slots for storing dates.

### 1 Enter the first date.

The first time you select **Date counter**, you will be prompted to enter a date for the first slot. Enter a date using the multi selector and press **OK** to exit to the date list.



### 2 Enter additional dates or edit existing dates.

To change a date or enter additional dates, highlight a slot, press **OK**, and enter a date as described above.

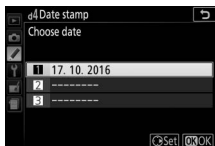



### 3 Choose a date.

Highlight a slot in the date list and press **OK**.

---

#### 4 Choose a date counter format.

Highlight **Display options** and press , then highlight a date format and press .





---

#### 5 Exit the date counter menu.

Press  to exit the date counter menu.

### d5: Reverse Indicators

MENU button →  Custom Settings menu





If  (+<sup>0</sup>-) is selected, the exposure indicators in the viewfinder and information display are displayed with positive values on the left and negative values on the right. Select  (-<sup>0</sup>+) to display negative values on the left and positive values on the right.

## e: Bracketing/Flash



### e1: Flash Cntrl for Built-in Flash/Optional Flash

MENU button →  Custom Settings menu

Choose the flash mode for the built-in flash in **P**, **S**, **A**, and **M** modes. When an optional SB-500, SB-400, or SB-300 flash unit is attached and turned on, this option changes to **Optional flash** and is used to choose the flash mode for the optional flash unit.

Option	Description
TTL  TTL	Flash output is adjusted automatically in response to shooting conditions.
M  Manual	Choose a flash level. At full power, the built-in flash has a Guide Number of 12/39 (m/ft., ISO 100, 20 °C/68 °F).
CMD  Commander mode	This option is available when an optional SB-500 flash unit is mounted on the camera accessory shoe. In commander mode, the SB-500 functions as a master flash for wireless remote control of groups of optional off-camera flash units (  247).

#### Manual

A  icon flashes in the viewfinder and **M**  appears in the information display when **Manual** is selected and the flash is on or raised.



## TTL Flash Control





The following types of flash control are supported when a CPU lens is used in combination with the built-in flash (☐ 101) or optional flash units (☐ 315).

- **i-TTL Balanced Fill-Flash for Digital SLR:** Information from the 2016-pixel RGB sensor is used to adjust flash output for a natural balance between the main subject and the background.
- **Standard i-TTL Fill-Flash for Digital SLR:** Flash output is adjusted for the main subject; the brightness of the background is not taken into account.

Standard i-TTL flash control is used with spot metering or when selected with the optional flash unit. i-TTL balanced fill-flash for digital SLR is used in all other cases.

## Commander Mode

When an optional SB-500 flash unit is mounted on the accessory shoe, select **Commander mode** to use the SB-500 as a master flash controlling one or more remote optional flash units in up to two groups (A and B) using advanced wireless lighting (☐ 315).

Selecting this option displays the menu shown at right. Press  or  to highlight the following options,  or  to change.

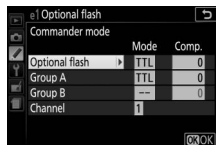

Option	Description
<b>Optional flash</b>	Choose a flash mode for the master (commander) flash.
<b>TTL</b>	i-TTL mode. Choose flash compensation from values between +3.0 and -3.0 EV in increments of 1/3 EV.
<b>M</b>	Choose the flash level.
<b>--</b>	Only the remote flash units fire; the master flash does not, although it does emit monitor pre-flashes.
<b>Group A</b>	Choose a flash mode for all flash units in group A.
<b>TTL</b>	i-TTL mode. Choose flash compensation from values between +3.0 and -3.0 EV in increments of 1/3 EV.
<b>⊗A</b>	Auto aperture (available only with compatible flash units; □ 315). Choose flash compensation from values between +3.0 and -3.0 EV in increments of 1/3 EV.
<b>M</b>	Choose the flash level.
<b>--</b>	The flash units in this group do not fire.
<b>Group B</b>	Choose a flash mode for all flash units in group B. The options available are the same as those listed for <b>Group A</b> , above.
<b>Channel</b>	Choose from channels 1–4. All flash units in both groups must be set to the same channel.

Follow the steps below to take photographs in commander mode.

## 1 Adjust settings for the master flash.

Choose the flash control mode and output level for the master flash. Note that output level can not be adjusted in -- mode.

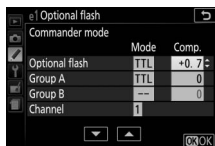

## 2 Adjust settings for group A.

Choose the flash control mode and output level for the flash units in group A.

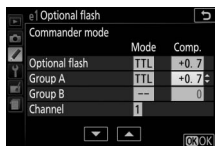

## 3 Adjust settings for group B.

Choose the flash control mode and output level for the flash units in group B.

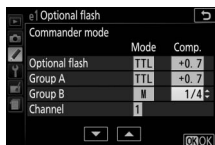

## 4 Select the channel.

If the remote flash units include an SB-500, select channel 3.

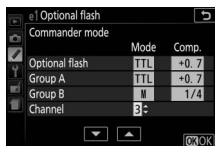

## 5 Press **OK**.

---

## 6 Compose the shot.

Compose the shot and arrange the flash units as shown below. Note that the maximum distance at which the remote flash units can be placed may vary with shooting conditions.

Group A: 10 m/32 ft or less

Group B: 7 m/22 ft or less

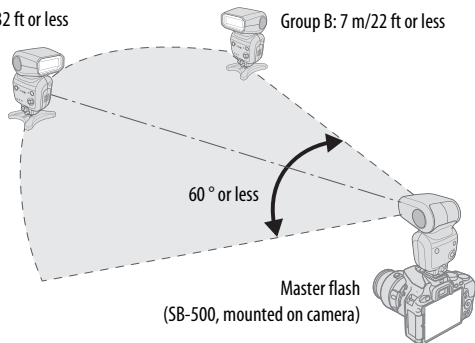

*Wireless remote sensors on flash units should face camera.*

---

## 7 Configure the remote flash units.

Turn all the remote flash units on, adjust group settings as desired, and set them to the channel selected in Step 4. See the flash unit instruction manuals for details.

---

## 8 Frame the photograph, focus, and shoot.







After confirming that the camera flash-ready light and the flash-ready lights for all flash units are lit, frame the photograph, focus, and shoot.

### The Flash Sync Mode Display

 does not appear in the information display when -- is selected for **Optional flash > Mode**.



### Flash Compensation

The flash compensation value selected with the  () and  () buttons and command dial is added to the flash compensation values selected for the master flash, group A, and group B in the **Commander mode** menu. A  icon is displayed in the viewfinder when a flash compensation value other than  $\pm 0$  is selected for the master or remote flash units in TTL or  A mode.

### Commander Mode

Position the sensor windows on the remote flash units to pick up the light from the master flash (particular care is required if the camera is not mounted on a tripod). The remote flash units should normally be placed closer to the subject than to the camera. Be sure that direct light or strong reflections from the remote flash units do not enter the camera lens (in TTL mode) or the photocells on the remote flash units ( A mode), as this may interfere with exposure. To prevent timing flashes emitted by the master flash from appearing in photographs taken at short range, choose low ISO sensitivities or small apertures (high f-numbers) or rotate the flash head on the master flash to point upwards. After positioning the remote flash units, take a test shot and view the results in the camera monitor.

Although there is no limit on the number of remote flash units that may be used, the practical maximum is three. With more than this number, the light emitted by the remote flash units will interfere with performance.

## e2: Auto Bracketing Set

MENU button →  Custom Settings menu

Choose the setting (exposure, white balance, or Active D-Lighting) varied when bracketing is in effect ( 151).

## f: Controls





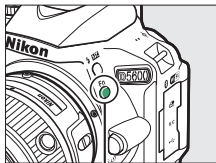

### f1: Assign Fn Button



MENU button →  Custom Settings menu

Choose the role played by the **Fn** button.

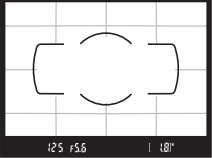

**Fn** button

Option	Description
QUAL <b>Image quality/size</b>	Keeping the <b>Fn</b> button pressed, rotate the command dial to select image quality and size (□ 98).
ISO <b>ISO sensitivity</b>	Keeping the <b>Fn</b> button pressed, rotate the command dial to select ISO sensitivity (□ 107).
WB <b>White balance</b>	Keeping the <b>Fn</b> button pressed, rotate the command dial to select white balance ( <b>P</b> , <b>S</b> , <b>A</b> , and <b>M</b> modes only; □ 140).
 <b>Active D-Lighting</b>	Keeping the <b>Fn</b> button pressed, rotate the command dial to select Active D-Lighting ( <b>P</b> , <b>S</b> , <b>A</b> , and <b>M</b> modes only; □ 136).
HDR <b>HDR</b>	Keeping the <b>Fn</b> button pressed, rotate the command dial to adjust HDR ( <b>P</b> , <b>S</b> , <b>A</b> , and <b>M</b> modes only; □ 138).
+  <b>+NEF (RAW)</b>	If image quality is set to <b>JPEG fine</b> , <b>JPEG normal</b> , or <b>JPEG basic</b> , an NEF (RAW) copy will be recorded with the next picture taken after the <b>Fn</b> button is pressed. To exit without recording an NEF (RAW) copy, press the <b>Fn</b> button again. This option has no effect in the following special effects modes:  , <b>VI</b> , <b>POP</b> ,  ,  ,  , and  .

Option	Description
BKT <b>Auto bracketing</b>	Keeping the <b>Fn</b> button pressed, rotate the command dial to choose the bracketing increment (exposure and white balance bracketing) or to turn ADL bracketing on or off ( <b>P</b> , <b>S</b> , <b>A</b> , and <b>M</b> modes only; <a href="#">☞ 151</a> ).
[↔] <b>AF-area mode</b>	Keeping the <b>Fn</b> button pressed, rotate the command dial to choose an AF-area mode ( <a href="#">☞ 87</a> ).
 <b>Viewfinder grid display</b>	Press the <b>Fn</b> button to display or hide the viewfinder framing grid. 
 <b>Wi-Fi</b>	Press the <b>Fn</b> button to display the Wi-Fi menu ( <a href="#">☞ 272</a> ).







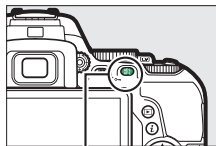



## f2: Assign AE-L/AF-L Button

MENU button →  Custom Settings menu

Choose the role played by the  $\overset{\text{AE-L}}{\text{AF-L}}$  () button.



$\overset{\text{AE-L}}{\text{AF-L}}$  () button





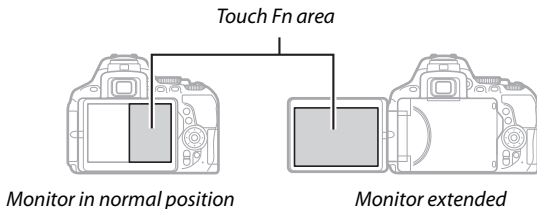

Option	Description
 <b>AE/AF lock</b>	Focus and exposure lock while the $\overset{\text{AE-L}}{\text{AF-L}}$ (  ) button is pressed.
 <b>AE lock only</b>	Exposure locks while the $\overset{\text{AE-L}}{\text{AF-L}}$ (  ) button is pressed.
 <b>AE lock (Hold)</b>	Exposure locks when the $\overset{\text{AE-L}}{\text{AF-L}}$ (  ) button is pressed, and remains locked until the button is pressed a second time or the standby timer expires.
 <b>AF lock only</b>	Focus locks while the $\overset{\text{AE-L}}{\text{AF-L}}$ (  ) button is pressed.
 <b>AF-ON</b>	The $\overset{\text{AE-L}}{\text{AF-L}}$ (  ) button initiates autofocus. The shutter-release button can not be used to focus.

### f3: Assign Touch Fn

MENU button →  Custom Settings menu

A touch-sensitive area of the monitor can be used to control the camera after the monitor has turned off automatically. The position of this “touch Fn” area varies with the position of the monitor; the role it plays can be chosen from the options in the table below. Slide your finger left or right across the area indicated in the illustration to adjust the chosen option (note that touch Fn is not available when the monitor is facing forward). If you find that your face contacts the touch Fn area when you look through the viewfinder, use the monitor in the extended position.

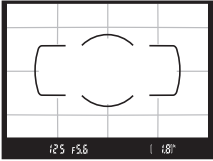

Option	Description
[1] <b>Focus-point selection</b>	When an option other than  ( <b>Auto-area AF</b> ) is selected for AF-area mode, you can slide a finger over the touch Fn area to position the focus point (  90).
ISO <b>ISO sensitivity</b>	Slide a finger left or right over the touch Fn area to adjust ISO sensitivity (  107), up or down to turn auto ISO sensitivity control (  228) on or off ( <b>P</b> , <b>S</b> , <b>A</b> , and <b>M</b> modes only).
 <b>Active D-Lighting</b>	Slide a finger over the touch Fn area to adjust Active D-Lighting ( <b>P</b> , <b>S</b> , <b>A</b> , and <b>M</b> modes only;  136).

Option	Description
HDR <b>HDR</b>	Slide a finger over the touch Fn area to adjust HDR ( <b>P</b> , <b>S</b> , <b>A</b> , and <b>M</b> modes only;  138).
BKT <b>Auto bracketing</b>	Slide a finger over the touch Fn area to choose the bracketing increment (exposure and white balance bracketing) or to turn ADL bracketing on or off ( <b>P</b> , <b>S</b> , <b>A</b> , and <b>M</b> modes only;  151).
<b>AF-area mode</b>	Slide a finger over the touch Fn area to choose an AF-area mode ( 87).
<b>Viewfinder grid display</b>	Tap the touch Fn area to display or hide the viewfinder framing grid. 
<b>Aperture</b>	Slide a finger over the touch Fn area to adjust aperture ( <b>A</b> and <b>M</b> modes only;  122, 123).
<b>None</b>	Disable touch Fn.

#### Touch Fn

Touch Fn is available only if **Enable** is selected for **Touch controls** ( 263) and **Info display auto off** ( 265) is on.

## f4: Reverse Dial Rotation

MENU button → Custom Settings menu

Reverse the direction of rotation of the command dial when it is used to make adjustments to exposure or flash compensation (**Exposure compensation**) and/or shutter speed and aperture (**Shutter speed/aperture**).

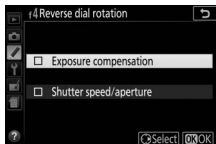

Highlight options and press to select or deselect, then press .

## Y The Setup Menu: Camera Setup

To display the setup menu, press **MENU** and select the **Y** (setup menu) tab.

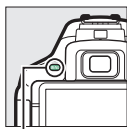

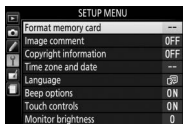
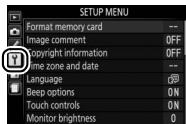

MENU button



## Setup Menu Options

The setup menu contains the following options:

Option	Default	
<b>Format memory card</b>	—	259
<b>Image comment</b>	—	260
<b>Copyright information</b>	—	261
<b>Time zone and date</b> <sup>1</sup>		
<b>Sync with smart device</b>	Off	262
<b>Daylight saving time</b>	Off	
<b>Language</b> <sup>1</sup>	—	262
<b>Beep options</b>		
<b>Beep on/off</b>	On	263
<b>Pitch</b>	Low	263
<b>Touch controls</b>	Enable	263
<b>Monitor brightness</b>	0	263
<b>Info display format</b>		
<b>AUTO/SCENE/EFFECTS</b>	Graphic	264
<b>P/S/A/M</b>	Graphic	
<b>Auto info display</b>	On	265
<b>Info display auto off</b>	On	265
<b>Clean image sensor</b>		
<b>Clean at startup/shutdown</b>	Clean at startup & shutdown	328

Option	Default	
Lock mirror up for cleaning <sup>2</sup>	—	330
Image Dust Off ref photo	—	266
Flicker reduction	Auto	268
Slot empty release lock	Release locked	268
<b>HDMI</b>		
Output resolution	Auto	219
Device control	On	
<b>Location data</b>		
Download from smart device	No	269
Position	—	
External GPS device options		
Standby timer	Enable	
Set clock from satellite	Yes	
<b>Remote control</b>		
Remote shutter release	Take photos	270
Assign Fn button	Same as camera  button	270
Airplane mode	Disable	271
Connect to smart device	—	271
Send to smart device (auto)	Off	272
<b>Wi-Fi</b>		
Network settings	—	272
Current settings	—	
Reset connection settings	—	
<b>Bluetooth</b>		
Network connection	Disable	273
Paired devices	—	
Send while off	On	
Eye-Fi upload <sup>3</sup>	Enable	274



Option	Default	
<b>Conformity marking</b>	—	276
<b>Firmware version</b>	—	276

- 1 Default varies with country of purchase.
- 2 Not available when battery is low.
- 3 Only available when compatible Eye-Fi memory card is inserted.

**Note:** Depending on camera settings, some items may be grayed out and unavailable.

## Format Memory Card

MENU button → setup menu

Memory cards must be formatted before first use or after being formatted in other devices. Format the card as described below.

### Formatting Memory Cards

Formatting memory cards permanently deletes any data they may contain. Be sure to copy any photographs and other data you wish to keep to a computer before proceeding ( 211).

## 1 Highlight Yes.

To exit without formatting the memory card, highlight **No** and press .



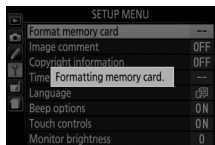

## 2 Press .

A message will be displayed while the card is formatted. *Do not remove the memory card or remove or disconnect the power source until formatting is complete.*



Add a comment to new photographs as they are taken. Comments can be viewed as metadata in ViewNX-i or Capture NX-D. The comment is also visible on the shooting data page in the photo information display ( 193). The following options are available:

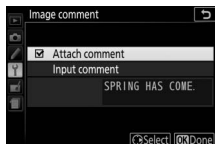

- **Input comment:** Input a comment as described on page 162. Comments can be up to 36 characters long.
- **Attach comment:** Select this option to attach the comment to all subsequent photographs. **Attach comment** can be turned on and off by highlighting it and pressing . After choosing the desired setting, press  to exit.



## Copyright Information

MENU button →  setup menu

Add copyright information to new photographs as they are taken. Copyright information is included in the shooting data shown in the photo information display and can be viewed as metadata in ViewNX-i or in Capture NX-D. The following options are available:

- **Artist:** Enter a photographer name as described on page 162. Photographer names can be up to 36 characters long.
- **Copyright:** Enter the name of the copyright holder as described on page 162. Copyright holder names can be up to 54 characters long.
- **Attach copyright information:** Select this option to attach copyright information to all subsequent photographs. **Attach copyright information** can be turned on and off by highlighting it and pressing . After choosing the desired setting, press  to exit.



### Copyright Information

To prevent unauthorized use of the artist or copyright holder names, make sure that **Attach copyright information** is not selected and that the **Artist** and **Copyright** fields are blank before lending or transferring the camera to another person. Nikon does not accept liability for any damages or disputes arising from the use of the **Copyright information** option.

## Time Zone and Date

MENU button →  setup menu

Change time zones, synchronize the clock with the clock on a smart device, set the camera clock, choose the date display order, and turn daylight saving time on or off.

Option	Description
<b>Time zone</b>	Choose a time zone. The camera clock is automatically set to the time in the new time zone.
<b>Date and time</b>	Set the camera clock (□□ 40).
<b>Sync with smart device</b>	Choose whether the camera clock is updated to the time (Coordinated Universal Time, or UTC), time zone, and standard or daylight saving time supplied by the smart device.
<b>Date format</b>	Choose the order in which the day, month, and year are displayed.
<b>Daylight saving time</b>	Turn daylight saving time on or off. The camera clock will automatically be advanced or set back one hour.

## Language

MENU button →  setup menu

Choose a language for camera menus and messages.

## Beep Options

MENU button →  setup menu

Beeps sound when the camera focuses, in self-timer mode, and when time-lapse recording ends or touch-screen controls are used.

### ■ ■ Beep On/Off

Select **Off (touch controls only)** to mute the sounds the camera makes in response to touch-screen controls, or choose **Off** to prevent beeps from sounding altogether.

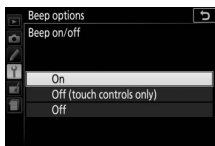

### ■ ■ Pitch

Choose the pitch (**High** or **Low**) of the sounds made when time-lapse recording ends or in response to focus and self-timer operations.



## Touch Controls

MENU button →  setup menu

Select **Disable** to prevent accidental use of touch-screen controls (📖 15), or **Playback only** to enable touch-screen controls in playback mode only.

## Monitor Brightness

MENU button →  setup menu

Press  or  to choose monitor brightness. Choose higher values for increased brightness, lower values for reduced brightness.

## Info Display Format

MENU button →  setup menu

Choose an information display format ( 6). Formats can be chosen separately for auto, scene, and special effects modes and for **P**, **S**, **A**, and **M** modes.



*Classic*



*Graphic*

- 1** Select a shooting mode option.  
Highlight **AUTO/SCENE/EFFECTS** or **P/S/A/M** and press .

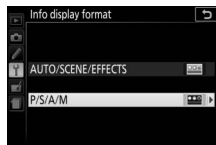

- 2** Select a design.  
Highlight a design and press .



## Auto Info Display

MENU button →  setup menu

If **On** is selected, the information display will appear after the shutter-release button is pressed halfway. If **Off** is selected, the information display can be viewed by pressing the  button.

## Info Display Auto Off

MENU button →  setup menu

If **On** is selected, the eye sensor will turn the information display off when you put your eye to the viewfinder. Selecting **Off** prevents the display turning off when you look through the viewfinder, but also increases the drain on the battery.

## Image Dust Off Ref Photo

MENU button →  setup menu

Acquire reference data for the Image Dust Off option in Capture NX-D (for more information, refer to Capture NX-D online help).

**Image Dust Off ref photo** is available only when a CPU lens is mounted on the camera. A lens with a focal length of at least 50 mm is recommended. When using a zoom lens, zoom all the way in.

### 1 Choose a start option.

Highlight one of the following options and press . To exit without acquiring image dust off data, press MENU.

- **Start:** The message shown at right will be displayed and “rEF” will appear in the viewfinder.
- **Clean sensor and then start:** Select this option to clean the image sensor before starting. The message shown at right will be displayed and “rEF” will appear in the viewfinder when cleaning is complete.

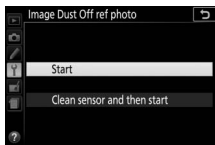

### Image Sensor Cleaning

Dust off reference cleaning data recorded before image sensor cleaning is performed can not be used with photographs taken after image sensor cleaning is performed. Select **Clean sensor and then start** only if the dust off reference data will not be used with existing photographs.



---

## 2 Frame a featureless white object in the viewfinder.

With the lens about ten centimeters (four inches) from a well-lit, featureless white object, frame the object so that it fills the viewfinder and then press the shutter-release button halfway.

In autofocus mode, focus will automatically be set to infinity; in manual focus mode, set focus to infinity manually.

---

## 3 Acquire Image Dust Off reference data.

Press the shutter-release button the rest of the way down to acquire Image Dust Off reference data. The monitor turns off when the shutter-release button is pressed.

If the reference object is too bright or too dark, the camera may be unable to acquire Image Dust Off reference data and the message shown at right will be displayed. Choose another reference object and repeat the process from step 1.



### ✓ Image Dust Off Reference Data

The same reference data can be used for photographs taken with different lenses or at different apertures. Reference images can not be viewed using computer imaging software. A grid pattern is displayed when reference images are viewed on the camera.



## Flicker Reduction

MENU button →  setup menu

Reduce flicker and banding when shooting under fluorescent or mercury-vapor lighting during live view (📖 55) or movie recording (📖 164). Choose **Auto** to allow the camera to automatically choose the correct frequency, or manually match the frequency to that of the local AC power supply.

### Flicker Reduction

If **Auto** fails to produce the desired results and you are unsure as to the frequency of the local power supply, test both the 50 and 60 Hz options and choose the one that produces the best results. Flicker reduction may not produce the desired results if the subject is very bright, in which case you should select mode **A** or **M** and choose a smaller aperture (higher f-number) before starting live view. Note that flicker reduction is not available when **On** is selected for **Movie settings > Manual movie settings** (📖 169) in mode **M**.

## Slot Empty Release Lock

MENU button →  setup menu

If **Release locked** is selected, the shutter-release button is only enabled when a memory card is inserted in the camera. Selecting **Enable release** allows the shutter to be released when no memory card is inserted, although no pictures will be recorded (they will however be displayed in the monitor in demo mode).

## Location Data

MENU button →  setup menu

Adjust location data settings for use when the camera is connected to a GPS or smart device.

Option	Description
<b>Download from smart device</b>	Select <b>Yes</b> to download location data from the smart device and embed them in pictures taken over the next two hours. If the camera is connected to both a smart device and a GPS unit, location data will be downloaded from the GPS unit. Location data can not be acquired if the camera is off or the standby timer has expired.
<b>Position</b>	View the location data supplied by the GPS or smart device (the items displayed vary with the device and in the case of movies are for the start of recording).
<b>External GPS device options</b>	Adjust settings for connection to optional GPS devices. <ul style="list-style-type: none"><li>• <b>Standby timer:</b> Choose whether the standby timer remains active while a GPS device is connected. If <b>Enable</b> is selected, the exposure meters will turn off automatically if no operations are performed for the period specified in Custom Setting c2 (<b>Auto off timers</b>,  240), reducing the drain on the battery. If a GP-1 or GP-1A unit is connected, the unit will remain active for a set period after the timer expires; to allow the camera time to acquire location data, the delay is extended by up to one minute after exposure meters are activated or the camera is turned on. Select <b>Disable</b> to disable the standby timer when a GPS device is connected.</li><li>• <b>Set clock from satellite:</b> Select <b>Yes</b> to synchronize the camera clock with the time reported by the GPS device.</li></ul>



## Remote Control

MENU button →  setup menu

Choose the functions performed using optional remote cords or wireless remote controllers (□ 323, 324).





### ■ Remote Shutter Release

Choose whether the shutter-release button on the optional accessory is used for photography or movie recording.

Option	Description
 <b>Take photos</b>	The shutter-release button on the optional accessory is used to take photographs.
 <b>Record movies</b>	The shutter-release button on the optional accessory is used for movie recording. Press the button halfway to start live view or to focus in <b>AF-S</b> and <b>AF-F</b> modes. Press the button all the way down to start or end recording. Use the camera live view switch to end live view.

### ■ Assign Fn button

Choose the role played by the **Fn** buttons on wireless remote controllers.

Option	Description
 <b>Same as camera button</b>	The <b>Fn</b> button on the wireless remote controller performs the function currently assigned to the camera  (  ) button (□ 254).
 <b>Live view</b>	The <b>Fn</b> button on the wireless remote controller can be used to start and end live view.

## Airplane Mode

MENU button →  setup menu

Select **Enable** to disable the wireless features of Eye-Fi cards and Bluetooth and Wi-Fi connections to smart devices. Connections to other devices using a wireless transmitter can only be disabled by removing the transmitter from the camera.

## Connect to Smart Device

MENU button →  setup menu

Adjust settings for connection to smart devices.

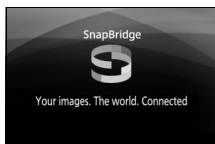

### Security

Although one of the benefits of this product is that it allows others to freely connect for the wireless exchange of data anywhere within its range, the following may occur if security is not enabled:

- **Data theft:** Malicious third-parties may intercept wireless transmissions to steal user IDs, passwords, and other personal information.
- **Unauthorized access:** Unauthorized users may gain access to the network and alter data or perform other malicious actions. Note that due to the design of wireless networks, specialized attacks may allow unauthorized access even when security is enabled.

## Send to Smart Device (Auto)

MENU button →  setup menu

If **On** is selected, new photos will automatically be uploaded to the smart device (if the camera is not currently connected to the smart device, the photos will be marked for upload and uploaded the next time a wireless connection is established). Movies are not uploaded.

### Upload Marking

No more than 1000 photos can be marked for upload at a time.

Before changing the rating of photos that are marked for upload, select **Disable** for **Bluetooth** > **Network connection** or switch wireless off by selecting **Enable** for **Airplane mode**.

## Wi-Fi

MENU button →  setup menu

Adjust Wi-Fi (wireless LAN) settings.

Option	Description
<b>Network settings</b>	Adjust settings for Wi-Fi connections.
<b>Current settings</b>	View current Wi-Fi settings.
<b>Reset connection settings</b>	Restore Wi-Fi settings to their default values.

## Bluetooth

MENU button →  setup menu

List paired devices and adjust settings for connection to smart devices.

Option	Description
<b>Network connection</b>	Enable or disable Bluetooth.
<b>Paired devices</b>	View paired devices.
<b>Send while off</b>	Select <b>Off</b> to suspend wireless transmissions when the camera is turned off or the standby timer expires.

## Eye-Fi Upload

MENU button →  setup menu

This option is displayed only when an Eye-Fi memory card (available separately from third-party suppliers) is inserted in the camera. Choose **Enable** to upload photographs to a preselected destination. Note that pictures will not be uploaded if signal strength is insufficient. Before uploading pictures via Eye-Fi, select **Disable** for **Airplane mode** (☞ 271) and **Bluetooth > Network connection** (☞ 273).

Observe all local laws concerning wireless devices and choose **Disable** where wireless devices are prohibited.

### Eye-Fi Cards

Eye-Fi cards may emit wireless signals when **Disable** is selected. A  icon displayed when **Disable** is selected indicates that the camera is unable to control the Eye-Fi card (☞ 275); turn the camera off and remove the card.

Select longer values for Custom Setting c2 (**Auto off timers**) > **Custom > Standby timer** (☞ 240) when using an Eye-Fi card.







See the manual provided with the Eye-Fi card, and direct any inquiries to the manufacturer. The camera can be used to turn Eye-Fi cards on and off, but may not support other Eye-Fi functions.

### Airplane Mode (☞ 271)

Enabling airplane mode disables Eye-Fi upload. To resume Eye-Fi upload, select **Disable** for **Airplane mode** before selecting **Enable** for **Eye-Fi upload**.



When an Eye-Fi card is inserted, its status is indicated by an icon in the information display:

- : Eye-Fi upload disabled.
- : Eye-Fi upload enabled but no pictures available for upload.
-  (static): Eye-Fi upload enabled; waiting to begin upload.
-  (animated): Eye-Fi upload enabled; uploading data.
- : Error — camera can not control Eye-Fi card. If a flashing  appears in the viewfinder, check that the Eye-Fi card firmware is up-to-date; if the error persists after the card firmware has been updated, insert a different card or format the card in the camera after copying any pictures it contains to a computer or other storage device. If the  indicator is not flashing, pictures can be taken normally but you may be unable to change Eye-Fi settings.



#### Supported Eye-Fi Cards

Some cards may not be available in some countries or regions; consult the manufacturer for more information. Eye-Fi cards are for use only in the country of purchase. Be sure the Eye-Fi card firmware has been updated to the latest version.

## Conformity Marking

MENU button →  setup menu

View a selection of the standards with which the camera complies.

## Firmware Version

MENU button →  setup menu

View the current camera firmware version.

## The Retouch Menu: Creating Retouched Copies

To display the retouch menu, press **MENU** and select the  (retouch menu) tab.

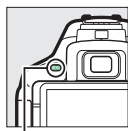



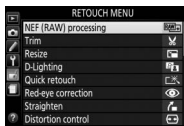
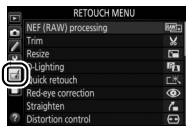



















**MENU** button



### Retouch Menu Options

The options in the retouch menu are used to create trimmed or retouched copies of existing pictures. The retouch menu is only displayed when a memory card containing photographs is inserted in the camera.

Option	
 <b>NEF (RAW) processing</b>	280
 <b>Trim</b>	282
 <b>Resize</b>	283
 <b>D-Lighting</b>	285
 <b>Quick retouch</b>	286
 <b>Red-eye correction</b>	286
 <b>Straighten</b>	287
 <b>Distortion control</b>	287
 <b>Perspective control</b>	288
 <b>Fisheye</b>	288
 <b>Filter effects</b>	289

Option	
 <b>Monochrome</b>	290
 <b>Image overlay</b>	291
 <b>Color outline</b>	293
 <b>Photo illustration</b>	294
 <b>Color sketch</b>	294
 <b>Miniature effect</b>	295
 <b>Selective color</b>	296
 <b>Painting</b>	298
 <b>Edit movie</b>	178
 <b>Side-by-side comparison*</b>	298



\* Available only if retouch menu is displayed by pressing **i** and selecting **Retouch** when a retouched image or original is displayed in full-frame playback.

## Creating Retouched Copies

To create a retouched copy:

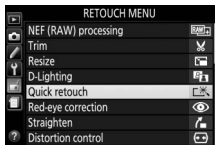
- 1 Display retouch options.**  
Highlight the desired item in the retouch menu and press .



- 2 Select a picture.**  
Highlight a picture and press  (to view the highlighted picture full screen, press and hold the  button).



### Retouch

The camera may not be able to display or retouch images created with other devices. If the image was recorded at image quality settings of NEF (RAW) + JPEG (📄 98), retouch options apply only to the RAW copy.

- 3 Select retouch options.**  
For more information, see the section for the selected item. To exit without creating a retouched copy, press **MENU**.

## 4 Create a retouched copy.

Press **OK** to create a retouched copy. Except in the photo information “image only” page (188), retouched copies are indicated by a  icon.



### **Creating Retouched Copies During Playback**

To create a retouched copy of the picture currently displayed in full-frame playback (184), press **i**, then highlight **Retouch** and press **OK** and select a retouch option (**Image overlay** excluded).

### **Retouching Copies**

Most options can be applied to copies created using other retouch options, although with the exceptions of **Image overlay** and **Edit movie > Choose start/end point**, each option can be applied only once (note that multiple edits may result in loss of detail). Options that can not be applied to the current image are grayed out and unavailable.

### **Image Quality and Size**

Except in the case of copies created with **Trim** and **Resize**, copies created from JPEG images are the same size and quality as the original, while copies created from NEF (RAW) photos are saved as large fine-quality JPEG images.

## NEF (RAW) Processing

MENU button →  retouch menu



Create JPEG copies of NEF (RAW) photographs.

### 1 Select NEF (RAW) processing.

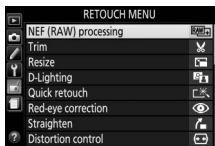
Highlight **NEF (RAW) processing** in the retouch menu and press  to display a picture selection dialog listing only NEF (RAW) images created with this camera.



### 2 Select a photograph.

Use the multi selector to highlight a photograph (to view the highlighted photograph full frame, press and hold the  button). Press  to select the highlighted photograph and proceed to the next step.

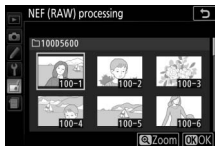

### 3 Choose settings for the JPEG copy.

Adjust the settings listed below. Note that white balance and vignette control are not available with pictures created with image overlay (📖 291), and that the effects of exposure compensation may differ from those that might have been expected when the photograph was taken.

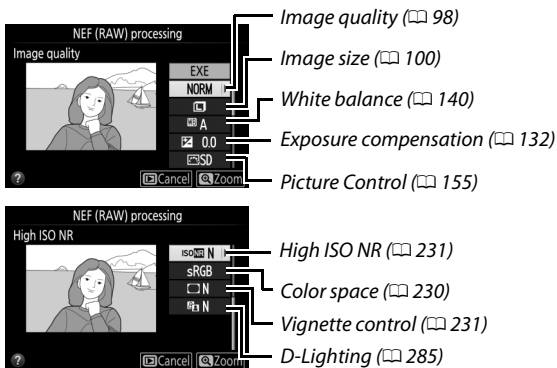

### 4 Copy the photograph.

Highlight **EXE** and press **OK** to create a JPEG copy of the selected photograph. To exit without copying the photograph, press the **MENU** button.









## Trim

MENU button →  retouch menu

Create a cropped copy of the selected photograph. The selected photograph is displayed with the selected crop shown in yellow; create a cropped copy as described in the following table.



To	Use	Description
Increase size of crop		Press the  button to increase the size of the crop.
Reduce size of crop		Press the  button to reduce the size of the crop.
Change crop aspect ratio		Rotate the command dial to choose the aspect ratio.
Move crop		Use multi selector to position the crop. Press and hold to move the crop rapidly to the desired position.
Create copy		Save the current crop as a separate file.

### Image Size

The size of the copy (which varies with crop size and aspect ratio) appears at upper left in the crop display.

### Viewing Cropped Copies

Playback zoom may not be available when cropped copies are displayed.

### See Also

See page 198 for information on cropping pictures during playback zoom.



## Resize

MENU button →  retouch menu

Create small copies of selected photographs.

### 1 Select **Resize**.

To resize selected images, highlight **Resize** in the retouch menu and press .

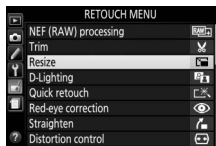

### 2 Choose a size.

Highlight **Choose size** and press .

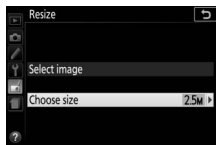





Highlight an option and press .



### 3 Choose pictures.

Highlight **Select image** and press .

Highlight pictures using the multi selector and press the  (?) button to select or deselect (to view the highlighted picture full screen, press and hold the  button). Selected pictures are marked by a  icon. Press  when the selection is complete.

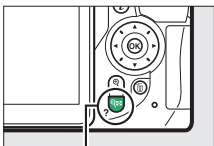
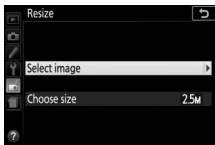

 (?) button



### 4 Save the resized copies.

A confirmation dialog will be displayed. Highlight **Yes** and press  to save the resized copies.

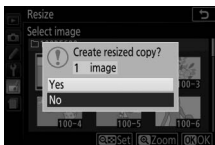

#### Viewing Resized Copies

Playback zoom may not be available when resized copies are displayed.

## D-Lighting

MENU button →  retouch menu

D-Lighting brightens shadows, making it ideal for dark or backlit photographs.





Before



D-Lighting  
( **Portrait disabled**)



D-Lighting  
( **Portrait enabled**)

Press  or  to choose the amount of correction performed; the effect can be previewed in the edit display. Press  to copy the photograph.

### ■ "Portrait"

To enable or disable this option, highlight **Portrait** and press . When **Portrait** is enabled, the camera will apply D-Lighting only to human portrait subjects, brightening up to three such subjects while leaving the background untouched for an effect similar to that achieved with a reflector.





### Portrait Subjects

The camera automatically selects up to three subjects for portrait D-Lighting (note that portrait D-Lighting can not be applied to photos taken with **Off** selected for **Auto image rotation** in the playback menu;  222). Depending on composition and how the subjects are posed, the desired results may not be achieved; if you are not satisfied, remove the check from **Portrait**.

## Quick Retouch

MENU button →  retouch menu

Create copies with enhanced saturation and contrast. D-Lighting is applied as required to brighten dark or backlit subjects.

Press  or  to choose the amount of enhancement. Press  to copy the photograph.

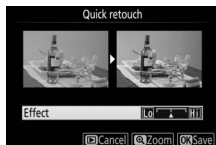



## Red-Eye Correction

MENU button →  retouch menu

This option is used to correct “red-eye” caused by the flash, and is available only with photographs taken using the flash. The photograph selected for red-eye correction can be previewed in the edit display. Confirm the effects of red-eye correction and press  to create a copy. Note that red-eye correction may not always produce the expected results and may in very rare circumstances be applied to portions of the image that are not affected by red-eye; check the preview thoroughly before proceeding.

## Straighten

MENU button →  retouch menu

Create a straightened copy of the selected image. Press  to rotate the image clockwise by up to five degrees in increments of approximately 0.25 degrees,  to rotate it counterclockwise (note that edges of the image will be trimmed to create a rectangular copy). Press  to save the retouched copy.

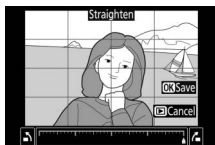



## Distortion Control

MENU button →  retouch menu

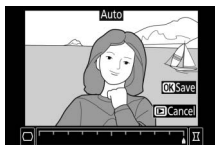
Create copies with reduced peripheral distortion. Select **Auto** to let the camera correct distortion automatically and then make fine adjustments using the multi selector, or select **Manual** to reduce distortion manually (note that **Auto** is not available with photos taken using auto distortion control; see page 232).



Press  to reduce barrel distortion,  to reduce pin-cushion distortion (note that greater amounts of distortion control result in more of the edges being cropped out). Press  to save the retouched copy.

### Auto

**Auto** is for use only with pictures taken with type G, E, and D lenses (PC, fisheye, and certain other lenses excluded); results are not guaranteed with other lenses.

## Perspective Control

MENU button →  retouch menu

Create copies that reduce the effects of perspective taken from the base of a tall object. Use the multi selector to adjust perspective (note that greater amounts of perspective control result in more of the edges being cropped out). Press **OK** to save the retouched copy.



*Before*



*After*

## Fisheye

MENU button →  retouch menu





Create copies that appear to have been taken with a fisheye lens. Press **▶** to increase the effect (this also increases the amount that will be cropped out at the edges of the image), **◀** to reduce it. Press **OK** to save the retouched copy.



## Filter Effects

MENU button →  retouch menu

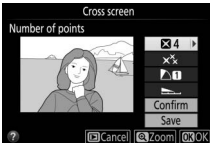
After adjusting filter effects as described below, press  to copy the photograph.

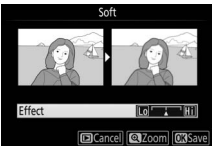

Option	Description
<b>Skylight</b>	Creates the effect of a skylight filter, making the picture less blue. 
<b>Warm filter</b>	Creates a copy with warm tone filter effects, giving the copy a “warm” red cast.
<b>Cross screen</b>	Add starburst effects to light sources. <ul style="list-style-type: none"><li>• <b>Number of points:</b> Choose from four, six, or eight.</li><li>• <b>Filter amount:</b> Choose the brightness of the light sources affected.</li><li>• <b>Filter angle:</b> Choose the angle of the points.</li><li>• <b>Length of points:</b> Choose the length of points.</li><li>• <b>Confirm:</b> Preview the effects of the filter. Press  to preview the copy full frame.</li><li>• <b>Save:</b> Create a retouched copy.</li></ul> 
<b>Soft</b>	Add a soft filter effect. Press  or  to choose the filter strength. 

## Monochrome

MENU button →  retouch menu

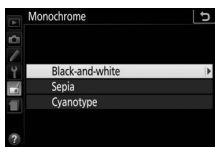
Copy photographs in **Black-and-white**, **Sepia**, or **Cyanotype** (blue and white monochrome).



Selecting **Sepia** or **Cyanotype** displays a preview of the selected image; press  to increase color saturation,  to decrease. Press  to create a monochrome copy.



*Increase saturation*



*Decrease saturation*



## Image Overlay

MENU button →  retouch menu

Image overlay combines two existing NEF (RAW) photographs to create a single picture that is saved separately from the originals; the results, which make use of RAW data from the camera image sensor, are noticeably better than overlays created in an imaging application. The new picture is saved at current image quality and size settings; before creating an overlay, set image quality and size (☐ 98, 100; all options are available). To create an NEF (RAW) copy, choose an image quality of **NEF (RAW)**.

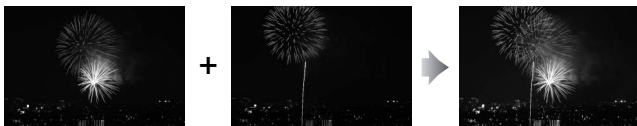

### 1 Select Image overlay.

Highlight **Image overlay** in the retouch menu and press .

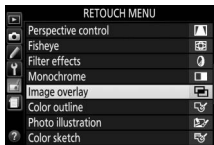

The dialog shown at right will be displayed, with **Image 1** highlighted; press  to display a list of the NEF (RAW) pictures created with this camera.

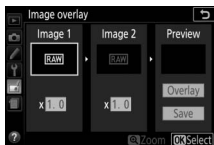

## 2 Select the first image.

Use the multi selector to highlight the first photograph in the overlay. To view the highlighted photograph full frame, press and hold the  $\mathcal{Q}$  button.

Press  $\mathcal{OK}$  to select the highlighted photograph and return to the preview display.



## 3 Select the second image.

The selected image will appear as **Image 1**. Highlight **Image 2** and press  $\mathcal{OK}$ , then select the second photo as described in Step 2.

## 4 Adjust gain.

Highlight **Image 1** or **Image 2** and optimize exposure for the overlay by pressing  $\mathcal{A}$  or  $\mathcal{B}$  to select gain from values between 0.1 and 2.0. Repeat for the second image. The default value is 1.0; select 0.5 to halve gain or 2.0 to double it. The effects of gain are visible in the **Preview** column.

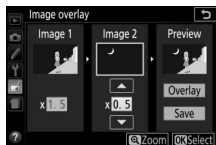

## 5 Preview the overlay.

To preview the composition as shown at right, press  $\mathcal{A}$  or  $\mathcal{B}$  to place the cursor in the **Preview** column, then press  $\mathcal{A}$  or  $\mathcal{B}$  to highlight **Overlay** and press  $\mathcal{OK}$  (note that colors and brightness in the preview may differ from the final image). To save the overlay without displaying a preview, select **Save**. To return to Step 4 and select new photos or adjust gain, press  $\mathcal{Q}$  (?).



## 6 Save the overlay.

Press **OK** while the preview is displayed to save the overlay. After an overlay is created, the resulting image will be displayed full-frame in the monitor.



### ✔ Image Overlay

Only NEF (RAW) photographs with the same bit depth can be combined (☐ 227). The overlay has the same photo info as the photograph selected for **Image 1**. The current image comment is appended to the overlay when it is saved; copyright information, however, is not copied.

## Color Outline

MENU button → retouch menu

Create an outline copy of a photograph to use as a base for painting. Press **OK** to save the retouched copy.

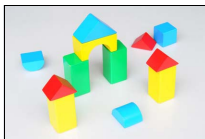

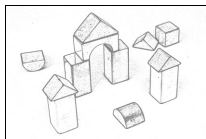

Before



After

## Photo Illustration

MENU button →  retouch menu

Sharpen outlines and simplify coloring for a poster effect. Press  or  to make outlines thicker or thinner. Press  to save the retouched copy.







Before



After

## Color Sketch

MENU button →  retouch menu















Create a copy of a photograph that resembles a sketch made with colored pencils. Press  or  to highlight **Vividness** or **Outlines** and press  or  to change. Vividness can be increased to make colors more saturated, or decreased for a washed-out, monochromatic effect, while outlines can be made thicker or thinner. Thicker outlines make colors more saturated. Press  to save the retouched copy.



## Miniature Effect

MENU button →  retouch menu

Create a copy that appears to be a photo of a diorama. Works best with photos taken from a high vantage point. The area that will be in focus in the copy is indicated by a yellow frame.

To	Press	Description
Choose orientation	 (?)	Press  (?) to choose orientation of area that is in focus.
Choose area in focus		If area of effect is in wide orientation, press  or  to position frame showing area of copy that will be in focus.
		If area of effect is in tall orientation, press  or  to position frame showing area of copy that will be in focus.
Choose size		If area of effect is in wide orientation, press  or  to choose height.
		If area of effect is in tall orientation, press  or  to choose width.
Create copy		Create copy.

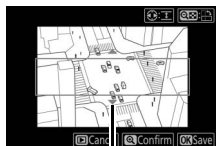

Area in focus

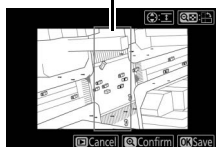



## Selective Color

MENU button →  retouch menu



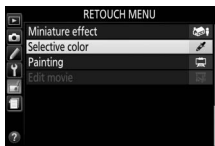

Create a copy in which only selected hues appear in color.

- 1 Select Selective color.**  
Highlight **Selective color** in the retouch menu and press .



- 2 Select a photograph.**  
Highlight a photograph and press  (to view the highlighted photograph full frame, press and hold the  button).



- 3 Select a color.**  
Use the multi selector to position the cursor over an object and press  () to select the color of the object as one that will remain in the final copy (the camera may have difficulty detecting unsaturated colors; choose a saturated color). To zoom in on the picture for precise color selection, press . Press  (?) to zoom out.

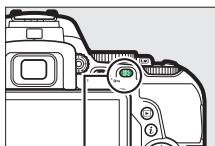

AE-L/AF-L () button

Selected color



#### 4 Highlight the color range.

Rotate the command dial to highlight the color range for the selected color.



Color range



#### 5 Choose the color range.

Press  $\uparrow$  or  $\downarrow$  to increase or decrease the range of similar hues that will be included in the final photograph. Choose from values between 1 and 7; note that higher values may include hues from other colors.



#### 6 Select additional colors.

To select additional colors, rotate the command dial to highlight another of the three color boxes at the top of the display and repeat Steps 3–5 to select another color. Repeat for a third color if desired. To deselect the highlighted color, press  $\square$  (to remove all colors, press and hold  $\square$ . A confirmation dialog will be displayed; select **Yes**).



#### 7 Save the edited copy.

Press  $\text{OK}$  to copy the photograph.



## Painting

MENU button →  retouch menu

Create a copy which emphasizes detail and color for a painterly effect. Press **OK** to save the retouched copy.

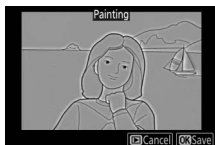

*Before*



*After*

## Side-by-side Comparison

Compare retouched copies to the original photographs. This option is only available if the retouch menu is displayed by pressing the **i** button and selecting **Retouch** when a copy or original is played back full frame.

### 1 Select a picture.

Select a retouched copy (shown by a  icon) or a photograph that has been retouched in full-frame playback. Press **i**, then highlight **Retouch** and press **OK**.

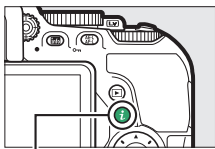

**i** button





- 2 Select Side-by-side comparison.**  
Highlight **Side-by-side comparison** in the retouch menu and press **OK**.

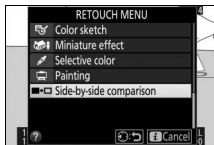

- 3 Compare the copy with the original.**

The source image is displayed on the left, the retouched copy on the right, with the options used to create the copy listed at the top of the display. Press **Left** or **Right** to switch between the source image and the retouched copy. To view the highlighted picture full frame, press and hold the **Q** button. If the copy was created from two images using **Image overlay**, press **Up** or **Down** to view the other source image. If multiple copies exist for the current source image, press **Up** or **Down** to view the other copies. Press **OK** to return to playback with the highlighted image displayed.

*Options used to create copy*

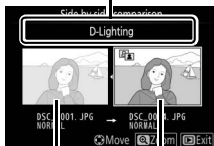



*Source image*

*Retouched copy*

**✓ Side-by-side comparison**

The source image will not be displayed if the copy was created from a photograph that has since been deleted or that was protected when the copy was made (200).

## Recent Settings/ My Menu

Both recent settings, a menu listing the 20 most recently used settings, and My Menu, a custom menu listing up to 20 user-selected options, can be accessed by pressing the **MENU** button highlighting the last tab in the menu list (either  or .

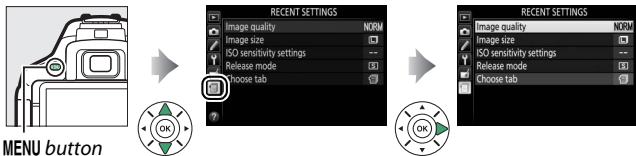

### Choosing a Menu

Use the **Choose tab** option to choose the menu displayed.

#### 1 Select **Choose tab**.

Highlight **Choose tab** and press .

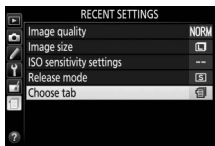



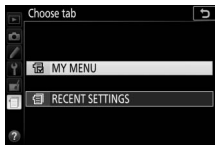

#### 2 Select a menu.

Highlight  **MY MENU** or  **RECENT SETTINGS** and press  to display the selected menu.



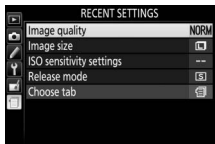

## Recent Settings

When  **RECENT SETTINGS** is selected for **Choose tab**, the menu lists the 20 most recently used settings, with the most recently-used items first. Press  or  to highlight an option and press  to select.



### Removing Items from the Recent Settings Menu

To remove an item from the recent settings menu, highlight it and press the  button. A confirmation dialog will be displayed; press  again to delete the selected item.

## My Menu

Selecting  **MY MENU** for **Choose tab** lets you access a customized menu of up to 20 options selected from the playback, shooting, Custom Settings, setup, and retouch menus. Follow the steps below to add items to, delete items from, and reorder items in My Menu.

### **■** Adding Options to My Menu

#### 1 Select Add items.

Highlight **Add items** and press .

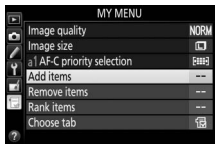

#### 2 Select a menu.

Highlight the name of the menu containing the option you wish to add and press .

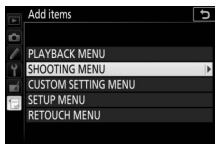

### 3 Select an item.

Highlight the desired menu item and press **OK**.



### 4 Position the new item.

Press **▲** or **▼** to move the new item up or down in My Menu. Press **OK** to add the new item. Repeat steps 1–4 to select additional items.

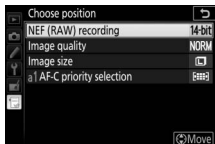

#### Adding Options to My Menu

The items currently displayed in My Menu are indicated by a check mark. Items indicated by a  icon can not be selected.



## ■ ■ Deleting Options from My Menu

---

### 1 Select Remove items.

Highlight **Remove items** and press .



---

### 2 Select items.

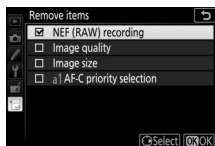
Highlight items and press  to select or deselect. Selected items are indicated by a check mark.



### 3 Delete the selected items.

Press . A confirmation dialog will be displayed; press  again to delete the selected items.

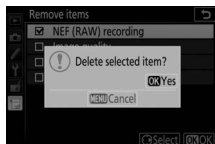

## ■ Reordering Options in My Menu

### 1 Select Rank items.



Highlight **Rank items** and press .

### 2 Select an item.

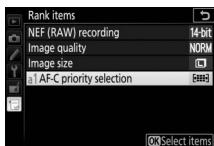
Highlight the item you wish to move and press .



### 3 Position the item.

Press  or  to move the item up or down in My Menu and press .

Repeat Steps 2–3 to reposition additional items.

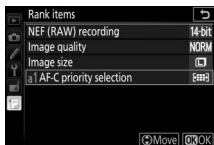

### 4 Exit to My Menu.

Press the **MENU** button to return to My Menu.

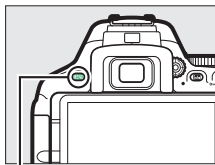

**MENU button**



# Technical Notes

Read this chapter for information on compatible accessories, cleaning and storing the camera, and what to do if an error message is displayed or you encounter problems using the camera.

## Compatible Lenses

### Compatible CPU Lenses

This camera supports autofocus with AF-S, AF-P, and AF-I CPU lenses only. AF-S lenses have names beginning with **AF-S**, AF-P lenses with **AF-P**, and AF-I lenses with **AF-I**. Autofocus is not supported with other autofocus (AF) lenses. The following table lists the features available with compatible lenses in viewfinder photography:

Camera setting  Lens/accessory	Focus mode			Shooting mode		Metering system		
	AF	MF (with electronic rangefinder)	MF	M	Other modes			
						3D	Color	
AF-S, AF-P, AF-I NIKKOR	✓	✓	✓	✓	✓	✓	—	✓ <sup>1</sup>
Other type G or D AF NIKKOR	—	✓	✓	✓	✓	✓	—	✓ <sup>1</sup>
PC-E NIKKOR series <sup>2,3</sup>	—	✓ <sup>4</sup>	✓	✓	✓	✓	—	✓ <sup>1</sup>
PC NIKKOR 19mm f/4E ED <sup>3,5</sup>	—	✓ <sup>4</sup>	✓	✓	✓	✓	—	✓ <sup>1</sup>
PC Micro 85mm f/2.8D <sup>6</sup>	—	✓ <sup>4</sup>	✓	✓	—	✓	—	✓ <sup>1</sup>
AF-S / AF-I teleconverter	✓ <sup>7</sup>	✓ <sup>7</sup>	✓	✓	✓	✓	—	✓ <sup>1</sup>
Other AF NIKKOR (except lenses for F3AF)	—	✓ <sup>8</sup>	✓	✓	✓	—	✓	✓ <sup>1</sup>
AI-P NIKKOR	—	✓ <sup>9</sup>	✓	✓	✓	—	✓	✓ <sup>1</sup>

1 Spot metering meters selected focus point ( 128).

- 2 The shift knob for the PC-E NIKKOR 24mm f/3.5D ED may contact the camera body when the lens is rotated. In addition, some combinations of shift and rotation may not be available due to the lens contacting the camera body.
  - 3 Shifting and/or tilting the lens interferes with exposure.
  - 4 Can not be used with shifting or tilting.
  - 5 Some combinations of shift and rotation may not be available due to the lens contacting the camera body.
  - 6 Optimal exposure will only be achieved if the lens is at maximum aperture and the lens is not shifted or tilted.
  - 7 With maximum effective aperture of f/5.6 or faster.
  - 8 When AF 80–200mm f/2.8, AF 35–70mm f/2.8, AF 28–85mm f/3.5–4.5 (New), or AF 28–85mm f/3.5–4.5 lenses are zoomed all the way in at the minimum focus distance, the in-focus indicator (●) may be displayed when the image on the matte screen in the viewfinder is not in focus. Before shooting, confirm that the image in the viewfinder screen is in focus.
  - 9 With maximum aperture of f/5.6 or faster.
- Noise in the form of lines may appear during autofocus when movies are recorded at high ISO sensitivities. Use manual focus or focus lock.



### ✓ IX NIKKOR Lenses

IX NIKKOR lenses can not be used.

### ✓ Identifying CPU and Type G, E, and D Lenses

CPU lenses can be identified by the presence of CPU contacts, type G, E, and D lenses by a letter on the lens barrel. Type G and E lenses are not equipped with a lens aperture ring.

*CPU contacts*

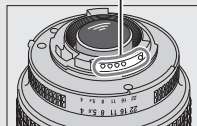

*CPU lens*

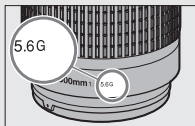

*Type G or E lens*

*Aperture ring*

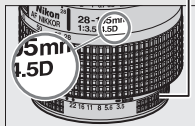

*Type D lens*

When using a CPU lens equipped with an aperture ring, lock the aperture ring at the minimum aperture (highest f-number).

### ✓ Matrix Metering

For matrix metering, the camera uses a 2016-pixel RGB sensor to set exposure according to tone distribution, color, composition, and, with type G, E, or D lenses, distance information (3D color matrix metering II; with other CPU lenses, the camera uses color matrix metering II; which does not include 3D distance information).

## Compatible Non-CPU Lenses

Non-CPU lenses may only be used when the camera is in mode **M**. Selecting another mode disables the shutter release.

Aperture must be adjusted manually via the lens aperture ring and the camera metering system, i-TTL flash control, and other features requiring a CPU lens can not be used. Some non-CPU lenses can not be used; see “Incompatible Accessories and Non-CPU Lenses,” below.

Camera setting  Lens/accessory	Focus mode			Shooting mode	
	AF	MF (with electronic rangefinder)	MF	M	Other modes
AI-, AI-modified NIKKOR or Nikon Series E lenses	—	✓ <sup>1</sup>	✓	✓ <sup>2</sup>	—
Medical NIKKOR 120mm f/4	—	✓	✓	✓ <sup>2,3</sup>	—
Reflex NIKKOR	—	—	✓	✓ <sup>2</sup>	—
PC NIKKOR	—	✓ <sup>4</sup>	✓	✓ <sup>2</sup>	—
AI-type Teleconverter	—	✓ <sup>5</sup>	✓	✓ <sup>2</sup>	—
PB-6 Bellows Focusing Attachment <sup>6</sup>	—	✓ <sup>1</sup>	✓	✓ <sup>2</sup>	—
Auto extension rings (PK-series 11A, 12, or 13; PN-11)	—	✓ <sup>1</sup>	✓	✓ <sup>2</sup>	—

1 With maximum aperture of f/5.6 or faster.

2 Exposure indicator can not be used.

3 Can be used at shutter speeds slower than flash sync speed by one step or more.

4 Can not be used with shifting or tilting.

5 With maximum effective aperture of f/5.6 or faster.

6 Attach in vertical orientation (can be used in horizontal orientation once attached).

### **Incompatible Accessories and Non-CPU Lenses**

The following accessories and non-CPU lenses can NOT be used with the D5600:

- TC-16A AF teleconverter
- Non-AI lenses
- Lenses that require the AU-1 focusing unit (400mm f/4.5, 600mm f/5.6, 800mm f/8, 1200mm f/11)
- Fisheye (6mm f/5.6, 7.5mm f/5.6, 8mm f/8, OP 10mm f/5.6)
- 2.1cm f/4
- Extension Ring K2
- 180–600mm f/8 ED (serial numbers 174041–174180)
- 360–1200mm f/11 ED (serial numbers 174031–174127)
- 200–600mm f/9.5 (serial numbers 280001–300490)
- AF lenses for the F3AF (AF 80mm f/2.8, AF 200mm f/3.5 ED, AF Teleconverter TC-16)
- PC 28mm f/4 (serial number 180900 or earlier)
- PC 35mm f/2.8 (serial numbers 851001–906200)
- PC 35mm f/3.5 (old type)
- Reflex 1000mm f/6.3 (old type)
- Reflex 1000mm f/11 (serial numbers 142361–143000)
- Reflex 2000mm f/11 (serial numbers 200111–200310)

### **AF-Assist Illumination**

The AF-assist illuminator has a range of about 0.5–3.0 m (1 ft 8 in.–9 ft 10 in.); when using the illuminator, use a lens with a focal length of 18–200 mm and remove the lens hood. AF-assist illumination is not available with the following lenses:

- AF-S NIKKOR 14–24mm f/2.8G ED
- AF-S NIKKOR 28–300mm f/3.5–5.6G ED VR
- AF-S DX NIKKOR 55–300mm f/4.5–5.6G ED VR
- AF-S VR Zoom-Nikkor 70–200mm f/2.8G IF-ED
- AF-S NIKKOR 70–200mm f/2.8G ED VR II
- AF-S Zoom-Nikkor 80–200mm f/2.8D IF-ED
- AF-S NIKKOR 80–400mm f/4.5–5.6G ED VR
- AF-S VR Nikkor 200mm f/2G IF-ED
- AF-S NIKKOR 200mm f/2G ED VR II
- AF-S VR Zoom-Nikkor 200–400mm f/4G IF-ED
- AF-S NIKKOR 200–400mm f/4G ED VR II

At ranges under 1 m (3 ft 3 in.), the following lenses may block the AF-assist illuminator and interfere with autofocus when lighting is poor:

- AF-S DX NIKKOR 10–24mm f/3.5–4.5G ED
- AF-S NIKKOR 16–35mm f/4G ED VR
- AF-S Zoom-Nikkor 17–35mm f/2.8D IF-ED
- AF-S DX Zoom-Nikkor 17–55mm f/2.8G IF-ED
- AF-S NIKKOR 18–35mm f/3.5–4.5G ED
- AF-S DX NIKKOR 18–105mm f/3.5–5.6G ED VR
- AF-S DX VR Zoom-Nikkor 18–200mm f/3.5–5.6G IF-ED
- AF-S DX NIKKOR 18–200mm f/3.5–5.6G ED VR II
- AF-S DX NIKKOR 18–300mm f/3.5–5.6G ED VR
- AF-S DX NIKKOR 18–300mm f/3.5–6.3G ED VR
- AF-S NIKKOR 20mm f/1.8G ED
- AF-S NIKKOR 24–70mm f/2.8G ED
- AF-S VR Zoom-Nikkor 24–120mm f/3.5–5.6G IF-ED
- AF-S NIKKOR 24–120mm f/4G ED VR
- AF-S NIKKOR 28mm f/1.8G
- AF-S Zoom-Nikkor 28–70mm f/2.8D IF-ED
- AF-S NIKKOR 35mm f/1.4G
- AF-S NIKKOR 70–200mm f/4G ED VR
- AF-S NIKKOR 85mm f/1.4G
- AF-S NIKKOR 85mm f/1.8G
- AF-S VR Micro-Nikkor 105mm f/2.8G IF-ED

### ✓ The Built-in Flash

The built-in flash can be used with lenses with focal lengths of 18–300 mm, although in some cases the flash may be unable to entirely light the subject at some ranges or focal lengths due to shadows cast by the lens (see the illustration below), while lenses that block the subject's view of the red-eye reduction lamp may interfere with red-eye reduction. Remove lens hoods to prevent shadows.

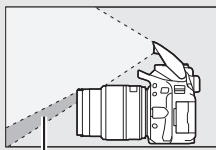

*Shadow*

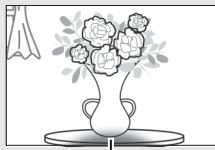

*Vignetting*

The flash has a minimum range of about 0.6 m and can not be used in the macro range of macro zoom lenses. The flash may be unable to light the entire subject with the following lenses at ranges less than those given below:

<b>Lens</b>	<b>Zoom position</b>	<b>Minimum distance without vignetting</b>
AF-S DX NIKKOR 10–24mm f/3.5–4.5G ED	24 mm	1.5 m / 4 ft 12 in.
AF-S DX Zoom-Nikkor 12–24mm f/4G IF-ED	24 mm	1.0 m / 3 ft 4 in.
AF-S NIKKOR 16–35mm f/4G ED VR	35 mm	1.0 m / 3 ft 4 in.
AF-S DX NIKKOR 16–85mm f/3.5–5.6G ED VR	24–85 mm	No vignetting
AF-S Zoom-Nikkor 17–35mm f/2.8D IF-ED	28 mm	1.0 m / 3 ft 4 in.
	35 mm	No vignetting
AF-S DX Zoom-Nikkor 17–55mm f/2.8G IF-ED	28 mm	1.5 m / 4 ft 12 in.
	35 mm	1.0 m / 3 ft 4 in.
	45–55 mm	No vignetting
AF-S NIKKOR 18–35mm f/3.5–4.5G ED	24 mm	1.5 m / 4 ft 12 in.
	28 mm	1.0 m / 3 ft 4 in.
	35 mm	No vignetting
AF Zoom-Nikkor 18–35mm f/3.5–4.5D IF-ED	24 mm	1.0 m / 3 ft 4 in.
	28–35 mm	No vignetting

<b>Lens</b>	<b>Zoom position</b>	<b>Minimum distance without vignetting</b>
AF-P DX NIKKOR 18–55mm f/3.5–5.6G VR, AF-P DX NIKKOR 18–55mm f/3.5–5.6G	18 mm	1.0 m / 3 ft 4 in.
	24–55 mm	No vignetting
AF-S DX Zoom-Nikkor 18–70mm f/3.5–4.5G IF-ED	18 mm	1.0 m / 3 ft 4 in.
	24–70 mm	No vignetting
AF-S DX NIKKOR 18–105mm f/3.5–5.6G ED VR	18 mm	2.5 m / 8 ft 3 in.
	24 mm	1.0 m / 3 ft 4 in.
	35–105 mm	No vignetting
AF-S DX Zoom-Nikkor 18–135mm f/3.5–5.6G IF-ED	18 mm	2.0 m / 6 ft 7 in.
	24–135 mm	No vignetting
AF-S DX NIKKOR 18–140mm f/3.5–5.6G ED VR	24 mm	1.0 m / 3 ft 4 in.
	35–140 mm	No vignetting
AF-S DX VR Zoom-Nikkor 18–200mm f/3.5–5.6G IF-ED, AF-S DX NIKKOR 18–200mm f/3.5–5.6G ED VR II	24 mm	1.0 m / 3 ft 4 in.
	35–200 mm	No vignetting
AF-S DX NIKKOR 18–300mm f/3.5–5.6G ED VR	35–300 mm	1.0 m / 3 ft 4 in.
AF-S DX NIKKOR 18–300mm f/3.5–6.3G ED VR	35–300 mm	No vignetting
AF-S NIKKOR 20mm f/1.8G ED	20 mm	1.5 m / 4 ft 12 in.
	24 mm	2.5 m / 8 ft 3 in.
AF Zoom-Nikkor 20–35mm f/2.8D IF	28 mm	1.0 m / 3 ft 4 in.
	35 mm	No vignetting
AF-S NIKKOR 24mm f/1.4G ED	24 mm	1.0 m / 3 ft 4 in.
AF-S NIKKOR 24–70mm f/2.8G ED	35 mm	1.5 m / 4 ft 12 in.
	50–70 mm	No vignetting
AF-S VR Zoom-Nikkor 24–120mm f/3.5–5.6G IF-ED	24 mm	1.0 m / 3 ft 4 in.
	28–120 mm	No vignetting
AF-S NIKKOR 24–120mm f/4G ED VR	24 mm	1.5 m / 4 ft 12 in.
	28–120 mm	No vignetting
AF-S Zoom-Nikkor 28–70mm f/2.8D IF-ED	35 mm	1.5 m / 4 ft 12 in.
	50–70 mm	No vignetting
AF-S NIKKOR 28–300mm f/3.5–5.6G ED VR	28 mm	1.5 m / 4 ft 12 in.
	35 mm	1.0 m / 3 ft 4 in.
	50–300 mm	No vignetting

Lens	Zoom position	Minimum distance without vignetting
AF-S VR Zoom-Nikkor 200–400mm f/4G IF-ED, AF-S NIKKOR 200–400mm f/4G ED VR II	200 mm	4.0 m/13 ft 2 in.
	250 mm	3.0 m/ 9 ft 11 in.
	300 mm	2.5 m/ 8 ft 3 in.
PC-E NIKKOR 24mm f/3.5D ED *	24 mm	3.0 m/ 9 ft 11 in.

\* When not shifted or tilted.

When used with the AF-S NIKKOR 14–24mm f/2.8G ED, the flash will be unable to light the entire subject at all ranges.

### Calculating Angle of View

The size of the area exposed by a 35 mm camera is  $36 \times 24$  mm. The size of the area exposed by the D5600, in contrast, is  $23.5 \times 15.6$  mm, meaning that the angle of view of a 35mm camera is approximately 1.5 times that of the D5600. The approximate focal length of lenses for the D5600 in 35 mm format can be calculated by multiplying the focal length of the lens by about 1.5.

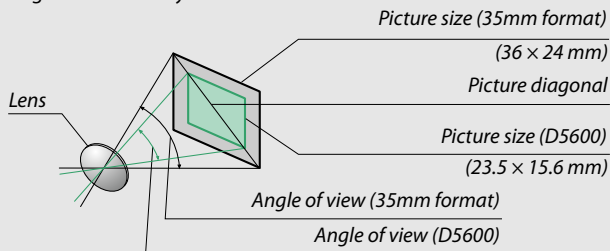



## The Nikon Creative Lighting System (CLS)

Nikon's advanced Creative Lighting System (CLS) offers improved communication between the camera and compatible flash units for improved flash photography. The built-in flash will not fire when an optional flash unit is attached.

### ■ CLS-Compatible Flash Units

The following features are available with CLS-compatible flash units:

			SB-5000	SB-910, SB-900, SB-800	SB-700	SB-600	SB-500	SU-800	SB-R200	SB-400	SB-300	
Single flash	i-TTL	i-TTL balanced fill-flash for digital SLR <sup>1</sup>	✓	✓	✓	✓	✓	—	—	✓	✓	
		Standard i-TTL fill-flash for digital SLR	✓ <sup>2</sup>	✓ <sup>2</sup>	✓	✓ <sup>2</sup>	✓	—	—	✓	✓	
	⊗A	Auto aperture	✓	✓ <sup>3</sup>	—	—	—	—	—	—	—	
	A	Non-TTL auto	— <sup>4</sup>	✓ <sup>3</sup>	—	—	—	—	—	—	—	
	GN	Distance-priority manual	✓	✓	✓	—	—	—	—	—	—	
	M	Manual	✓	✓	✓	✓	✓ <sup>5</sup>	—	—	✓ <sup>5</sup>	✓ <sup>5</sup>	
	RPT	Repeating flash	✓	✓	—	—	—	—	—	—	—	
Optical Advanced Wireless Lighting	Master	Remote flash control	✓	✓	✓	—	✓ <sup>5</sup>	✓	—	—	—	
		i-TTL	✓	✓	✓	—	✓ <sup>5</sup>	—	—	—	—	
		[A:B]	Quick wireless flash control	✓	—	✓	—	—	✓ <sup>6</sup>	—	—	—
		⊗A	Auto aperture	✓	✓ <sup>7</sup>	—	—	—	—	—	—	—
		A	Non-TTL auto	—	✓	—	—	—	—	—	—	—
		M	Manual	✓	✓	✓	—	✓ <sup>5</sup>	—	—	—	—
		RPT	Repeating flash	✓	✓	—	—	—	—	—	—	—

		SB-5000	SB-910, SB-900, SB-800	SB-700	SB-600	SB-500	SU-800	SB-R200	SB-400	SB-300
Optical Advanced Wireless Lighting	Remote	i-TTL	i-TTL	✓	✓	✓	✓	✓	—	—
		[A:B]	Quick wireless flash control	✓	✓	✓	✓	✓	—	—
		⊗A/A	Auto aperture/ Non-TTL auto	✓ <sup>8</sup>	✓ <sup>7</sup>	—	—	—	—	—
		M	Manual	✓	✓	✓	✓	✓	—	—
		RPT	Repeating flash	✓	✓	✓	✓	—	—	—
Radio-controlled Advanced Wireless Lighting		—	—	—	—	—	—	—	—	—
Color Information Communication (flash)		✓	✓	✓	✓	✓	—	—	✓	✓
Color Information Communication (LED light)		—	—	—	—	✓	—	—	—	—
AF-assist for multi-area AF		✓	✓	✓	✓	—	✓ <sup>9</sup>	—	—	—
Red-eye reduction		✓	✓	✓	✓	✓	—	—	✓	—
Camera flash mode selection		—	—	—	—	✓	—	—	✓	✓
Camera flash unit firmware update		✓	✓ <sup>10</sup>	✓	—	✓	—	—	—	✓

1 Not available with spot metering.

2 Can also be selected with flash unit.

3 ⊗A/A mode selection performed on flash unit using custom settings. "A" will be selected when a non-CPU lens is used.

4 "A" will be selected when a non-CPU lens is used.

5 Can only be selected with camera (□ 246).

6 Available only during close-up photography.

7 "A" is used with non-CPU lenses, regardless of mode selected with flash unit.

8 Choice of ⊗A and A depends on the option selected with master flash.

9 Available only in commander mode.

10 Firmware updates for the SB-910 and SB-900 can be performed from the camera.

**The SU-800 wireless speedlight commander:** When mounted on a CLS-compatible camera, the SU-800 can be used as a commander for SB-5000, SB-910, SB-900, SB-800, SB-700, SB-600, SB-500, or SB-R200 flash units in up to three groups. The SU-800 itself is not equipped with a flash.

## ■ Other Flash Units

The following flash units can be used in non-TTL auto and manual modes. Use with the camera in mode **S** or **M** and a shutter speed of  $1/200$  s or slower selected.

Flash mode \ Flash unit	SB-80DX, SB-28DX, SB-28, SB-26, SB-25, SB-24	SB-50DX <sup>1</sup>	SB-30, SB-27 <sup>2</sup> , SB-22S, SB-22, SB-20, SB-16B, SB-15	SB-23, SB-29 <sup>3</sup> , SB-21B <sup>3</sup> , SB-29S <sup>3</sup>
<b>A</b> Non-TTL auto	✓	—	✓	—
<b>M</b> Manual	✓	✓	✓	✓
 Repeating flash	✓	—	—	—
<b>REAR</b> Rear-curtain sync <sup>4</sup>	✓	✓	✓	✓

- 1 Select mode **P**, **S**, **A**, or **M**, lower built-in flash, and use optional flash unit only.
- 2 Flash mode is automatically set to TTL and shutter-release is disabled. Set flash unit to **A** (non-TTL auto flash).
- 3 Autofocus is available with AF-S VR Micro-Nikkor 105mm f/2.8G IF-ED and AF-S Micro NIKKOR 60mm f/2.8G ED lenses only.
- 4 Available when camera is used to select flash mode.

### The AS-15 Sync Terminal Adapter



When the AS-15 sync terminal adapter (available separately) is mounted on the camera accessory shoe, flash accessories can be connected via a sync cable.

### Use Only Nikon Flash Accessories

Use only Nikon flash units. Negative voltages or voltages over 250 V applied to the accessory shoe could not only prevent normal operation, but damage the sync circuitry of the camera or flash. Before using a Nikon flash unit not listed in this section, contact a Nikon-authorized service representative for more information.

### ✔ Notes on Optional Flash Units

Refer to the Speedlight manual for detailed instructions. If the flash unit supports CLS, refer to the section on CLS-compatible digital SLR cameras. The D5600 is not included in the “digital SLR” category in the SB-80DX, SB-28DX, and SB-50DX manuals.

If an optional flash unit is attached in shooting modes other than , , and , the flash will fire with every shot, even in modes in which the built-in flash can not be used.

i-TTL flash control can be used at ISO sensitivities between 100 and 12800. At high ISO sensitivities, noise (lines) may appear in photos taken with some optional flash units; if this occurs, choose a lower value. If the flash-ready indicator flashes for about three seconds after a photograph is taken, the flash has fired at full power and the photograph may be underexposed (CLS-compatible flash units only; for information on the exposure and flash charge indicators on other units, see the manual provided with the flash).

When an SC-series 17, 28, or 29 sync cable is used for off-camera flash photography, correct exposure may not be achieved in i-TTL mode. We recommend that you choose spot metering to select standard i-TTL flash control. Take a test shot and view the results in the monitor.

In i-TTL, use the flash panel or bounce adapter provided with the flash unit. Do not use other panels such as diffusion panels, as this may produce incorrect exposure.

If the controls on the optional SB-5000, SB-910, SB-900, SB-800, SB-700 or SB-600 flash unit or SU-800 wireless Speedlight commander are used to set flash compensation,  will appear in the information display.

The SB-5000, SB-910, SB-900, SB-800, SB-700, SB-600, SB-500, and SB-400 provide red-eye reduction, while the SB-5000, SB-910, SB-900, SB-800, SB-700, SB-600, and SU-800 provide AF-assist illumination with the following restrictions:

- **SB-5000:** AF-assist illumination is available with 24–135 mm AF lenses, however, autofocus is available only with the focus points shown at right.

24–49 mm	
50–69 mm	
70–135 mm	

- **SB-910 and SB-900:** AF-assist illumination is available with 17–135 mm AF lenses, however, autofocus is available only with the focus points shown at right.

17–19 mm	
20–105 mm	
106–135 mm	

- **SB-800, SB-600, and SU-800:** AF-assist illumination is available with 24–105 mm AF lenses, however, autofocus is available only with the focus points shown at right.

24–34 mm	
35–49 mm	
50–105 mm	



## Other Accessories

At the time of writing, the following accessories were available for the D5600.

<b>Power sources</b>	<ul style="list-style-type: none"><li>• <b>EN-EL14a Rechargeable Li-ion Battery</b> (□ 26): Additional EN-EL14a batteries are available from local retailers and Nikon-authorized service representatives. EN-EL14 batteries can also be used.</li><li>• <b>MH-24 Battery Charger</b> (□ 26): Recharge EN-EL14a and EN-EL14 batteries.</li><li>• <b>EP-5A Power Connector, EH-5b/EH-5c AC Adapter</b>: These accessories can be used to power the camera for extended periods (EH-5a and EH-5 AC adapters can also be used). A power connector EP-5A is required to connect the camera to the EH-5c, EH-5b, EH-5a, or EH-5; see page 325 for details.</li></ul>
<b>Accessory shoe covers</b>	<b>BS-1 Accessory Shoe Cover</b> : A cover protecting the accessory shoe. The accessory shoe is used for optional flash units.
<b>Filters</b>	<ul style="list-style-type: none"><li>• Filters intended for special-effects photography may interfere with autofocus or the electronic rangefinder.</li><li>• The D5600 can not be used with linear polarizing filters. Use C-PL or C-PL II circular polarizing filters instead.</li><li>• Neutral Color (NC) filters are recommended for protecting the lens.</li><li>• To prevent ghosting, use of a filter is not recommended when the subject is framed against a bright light, or when a bright light source is in the frame.</li><li>• Center-weighted metering is recommended with filters with exposure factors (filter factors) over 1× (Y44, Y48, Y52, O56, R60, X0, X1, C-PL, ND2S, ND4, ND4S, ND8, ND8S, ND400, A2, A12, B2, B8, B12). See the filter manual for details.</li></ul>

## Viewfinder eyepiece accessories

- **DK-5 Eyepiece Cap** (☐ 80): Prevents light entering via the viewfinder from appearing in the photograph or interfering with exposure.
- **DK-20C Eyepiece Correction Lenses:** Lenses are available with diopters of  $-5$ ,  $-4$ ,  $-3$ ,  $-2$ ,  $0$ ,  $+0.5$ ,  $+1$ ,  $+2$ , and  $+3 \text{ m}^{-1}$  when the camera diopter adjustment control is in the neutral position ( $-1 \text{ m}^{-1}$ ). Use eyepiece correction lenses only if the desired focus can not be achieved with the built in diopter adjustment control ( $-1.7$  to  $+0.5 \text{ m}^{-1}$ ). Test eyepiece correction lenses before purchase to ensure that the desired focus can be achieved. The rubber eyecup can not be used with eyepiece correction lenses.
- **DG-2 Magnifier:** The DG-2 magnifies the scene displayed in the center of the viewfinder for greater precision during focusing. Eyepiece adapter required (available separately). Note that because the DG-2 interferes with the eye sensor, you may find it necessary to select **Off** for the **Info display auto off** item in the setup menu (☐ 265) when this accessory is attached.
- **DK-22 Eyepiece Adapter:** The DK-22 is used when attaching the DG-2 magnifier. The monitor can not be rotated with the adapter in place.
- **DR-6 Right-Angle Viewing Attachment:** The DR-6 attaches at a right angle to the viewfinder eyepiece, allowing the image in the viewfinder to be viewed at right angles to the lens (for example, from directly above when the camera is horizontal). The monitor can not be rotated with the attachment in place. In addition, because the DR-6 interferes with the eye sensor, you may find it necessary to select **Off** for the **Info display auto off** item in the setup menu when this accessory is attached.

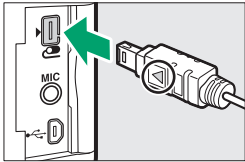

<b>Software</b>	<p><b>Camera Control Pro 2:</b> Control the camera remotely from a computer to record movies and photographs and save photographs directly to the computer hard disk.</p> <p><b>Note:</b> Use the latest versions of Nikon software; see the websites listed on page xxi for the latest information on supported operating systems. At default settings, Nikon Message Center 2 will periodically check for updates to Nikon software and firmware while you are logged in to an account on the computer and the computer is connected to the Internet. A message is automatically displayed when an update is found.</p>
<b>Body caps</b>	<p><b>BF-1B Body Cap/BF-1A Body Cap:</b> The body cap keeps the mirror, viewfinder screen, and image sensor free of dust when a lens is not in place.</p>
<b>Wireless remote controllers</b>	<ul style="list-style-type: none"> <li>• <b>WR-R10 Wireless Remote Controller/WR-T10 Wireless Remote Controller:</b> When a WR-R10 wireless remote controller is attached, the camera can be controlled wirelessly using a WR-T10 wireless remote controller (□ 270).</li> <li>• <b>WR-1 Wireless Remote Controller</b> (□ 270): The WR-1 can function as either a transmitter or a receiver and is used in combination either with another WR-1 or a WR-R10 or WR-T10 wireless remote controller. For example, a WR-1 can be connected to the accessory terminal for use as a receiver, allowing the shutter to be released remotely by another WR-1 acting as a transmitter.</li> </ul>
<b>Microphones</b>	<ul style="list-style-type: none"> <li>• <b>ME-1 Stereo Microphone</b> (□ 170)</li> <li>• <b>ME-W1 Wireless Microphone</b> (□ 170)</li> </ul>

<b>Accessory terminal accessories</b>	<p>The D5600 is equipped with an accessory terminal for <b>WR-1</b> and <b>WR-R10 wireless remote controllers</b>, <b>MC-DC2 remote cords</b> (📖 125), and <b>GP-1/GP-1A GPS units</b> (📖 269), which connect with the ◀ mark on the connector aligned with the ▶ next to the accessory terminal (close the connector when the terminal is not in use).</p>	
<b>USB cables</b>	<b>UC-E20 USB Cable</b> (📖 211, 214)	
<b>HDMI cables</b> (📖 218)	<b>HC-E1 HDMI Cable:</b> An HDMI cable with a type C connector for connection to the camera and a type A connector for connection to HDMI devices.	

### ■ **Approved Memory Cards**

The camera supports SD, SDHC, and SDXC memory cards, including SDHC and SDXC cards compliant with UHS-I. Cards rated SD Speed Class 6 or better are recommended for movie recording; using slower cards may result in recording being interrupted. When choosing cards for use in card readers, be sure they are compatible with the device. Contact the manufacturer for information on features, operation, and limitations on use.



#### **Optional Accessories**

Availability may vary with country or region. See our website or brochures for the latest information.

## **Attaching a Power Connector and AC Adapter**

Turn the camera off before attaching an optional power connector and AC adapter.

### **1 Ready the camera.**

Open the battery-chamber (1) and power connector (2) covers.

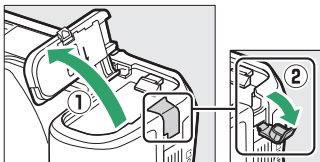

### **2 Insert the EP-5A power connector.**

Be sure to insert the connector in the orientation shown, using the connector to keep the orange battery latch pressed to one side. Be sure the connector is fully inserted.

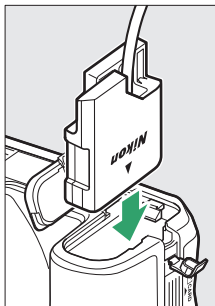

### **3 Close the battery-chamber cover.**

Position the power connector cable so that it passes through the power connector slot and close the battery-chamber cover.

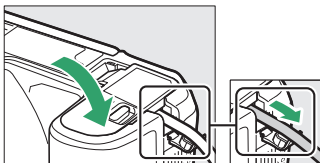

---

## 4 Connect the EH-5b/EH-5c AC adapter.

Connect the AC adapter power cable to the AC socket on AC adapter (3) and the power cable to the DC socket (4). A  icon is displayed in the monitor when the camera is powered by the AC adapter and power connector.

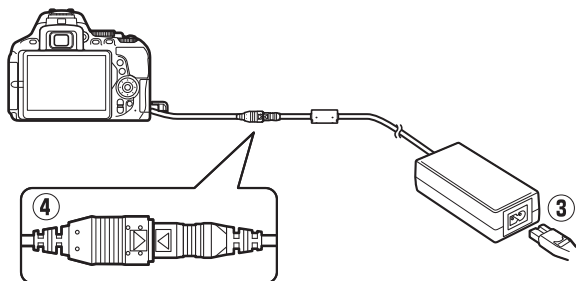

## Caring for the Camera

### Storage

When the camera will not be used for an extended period, remove the battery and store it in a cool, dry area with the terminal cover in place. To prevent mold or mildew, store the camera in a dry, well-ventilated area. Do not store your camera with naphtha or camphor moth balls or in locations that:

- are poorly ventilated or subject to humidities of over 60%
- are next to equipment that produces strong electromagnetic fields, such as televisions or radios
- are exposed to temperatures above 50 °C (122 °F) or below -10 °C (14 °F)

### Cleaning

<b>Camera body</b>	Use a blower to remove dust and lint, then wipe gently with a soft, dry cloth. After using the camera at the beach or seaside, wipe off sand or salt with a cloth lightly dampened in distilled water and dry thoroughly. <b>Important:</b> <i>Dust or other foreign matter inside the camera may cause damage not covered under warranty.</i>
<b>Lens, mirror, and viewfinder</b>	These glass elements are easily damaged. Remove dust and lint with a blower. If using an aerosol blower, keep the can vertical to prevent the discharge of liquid. To remove fingerprints and other stains, apply a small amount of lens cleaner to a soft cloth and clean with care.
<b>Monitor</b>	Remove dust and lint with a blower. When removing fingerprints and other stains, wipe the surface lightly with a soft cloth or chamois leather. Do not apply pressure, as this could result in damage or malfunction.

*Do not use alcohol, thinner, or other volatile chemicals.*

## Image Sensor Cleaning

If you suspect that dirt or dust on the image sensor is appearing in photographs, you can clean the sensor using the **Clean image sensor** option in the setup menu. The sensor can be cleaned at any time using the **Clean now** option, or cleaning can be performed automatically when the camera is turned on or off.

### ■ *“Clean Now”*

Holding the camera base down, select **Clean image sensor** in the setup menu, then highlight **Clean now** and press **OK**. The camera will check the image sensor and then begin cleaning. **b5y** flashes in the viewfinder and other operations can not be performed while cleaning is in progress. Do not remove or disconnect the power source until cleaning ends and the setup menu is displayed.

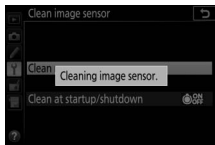
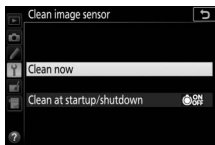
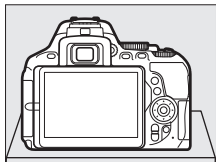

## ■ ■ “Clean at Startup/Shutdown”

### 1 Select Clean at startup/shutdown.

Select **Clean image sensor**, then highlight **Clean at startup/shutdown** and press .

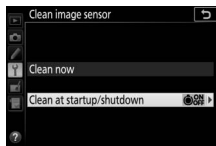

### 2 Select an option.

Highlight an option and press . Choose from **Clean at startup**, **Clean at shutdown**, **Clean at startup & shutdown**, and **Cleaning off**.

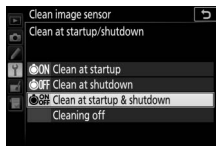

#### Image Sensor Cleaning

Using camera controls during startup interrupts image sensor cleaning.

Cleaning is performed by vibrating the image sensor. If dust can not be fully removed using the options in the **Clean image sensor** menu, clean the image sensor manually (📖 330) or consult a Nikon-authorized service representative.

If image sensor cleaning is performed several times in succession, image sensor cleaning may be temporarily disabled to protect the camera's internal circuitry. Cleaning can be performed again after a short wait.

## Manual Cleaning

If foreign matter can not be removed from the image sensor using the **Clean image sensor** option in the setup menu (☞ 328), the sensor can be cleaned manually as described below. Note, however, that the sensor is extremely delicate and easily damaged. Nikon recommends that the sensor be cleaned only by Nikon-authorized service personnel.

---

### 1 Charge the battery.

A reliable power source is required when inspecting or cleaning the image sensor. Be sure the battery is fully charged before proceeding.

---

### 2 Remove the lens.

Turn the camera off and remove the lens.

---

### 3 Select **Lock mirror up for cleaning**.

Turn the camera on and highlight **Lock mirror up for cleaning** in the setup menu and press  $\blacktriangleright$  (note that this option is not available at battery levels of  $\square$  or below).

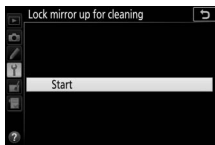

---

### 4 Press $\odot$ .

The message shown at right will be displayed in the monitor.

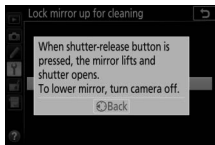

---

### 5 Raise the mirror.

Press the shutter-release button all the way down. The mirror will be raised and the shutter curtain will open, revealing the image sensor.





---

## 6 Examine the image sensor.

Holding the camera so that light falls on the image sensor, examine the interior of the camera for dust or lint. If no foreign objects are present, proceed to Step 8.

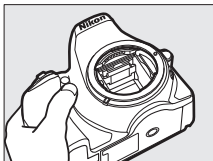

---

## 7 Clean the sensor.

Remove any dust and lint from the sensor with a blower. Do not use a blower-brush, as the bristles could damage the sensor. Dirt that can not be removed with a blower can only be removed by Nikon-authorized service personnel. Under no circumstances should you touch or wipe the sensor.

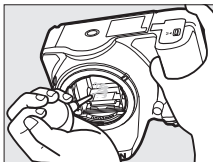

---

## 8 Turn the camera off.

The mirror will return to the down position and the shutter curtain will close. Replace the lens or body cap.

### Use a Reliable Power Source

The shutter curtain is delicate and easily damaged. If the camera powers off while the mirror is raised, the curtain will close automatically. To prevent damage to the curtain, observe the following precautions:

- Do not turn the camera off or remove or disconnect the power source while the mirror is raised.
- If the battery runs low while the mirror is raised, a beep will sound and the self-timer lamp will flash to warn that the shutter curtain will close and the mirror will be lowered after about two minutes. End cleaning or inspection immediately.

### ✔ Foreign Matter on the Image Sensor

Foreign matter entering the camera when lenses or body caps are removed or exchanged (or in rare circumstances lubricant or fine particles from the camera itself) may adhere to the image sensor, where it may appear in photographs taken under certain conditions. To protect the camera when no lens is in place, be sure to replace the body cap provided with the camera, being careful to first remove all dust and other foreign matter that may be adhering to the camera mount, lens mount, and body cap. Avoid attaching the body cap or exchanging lenses in dusty environments.

Should foreign matter find its way onto the image sensor, use the image sensor cleaning option as described on page 328. If the problem persists, clean the sensor manually (□ 330) or have the sensor cleaned by authorized Nikon service personnel. Photographs affected by the presence of foreign matter on the sensor can be retouched using the clean image options available in some imaging applications.

### ✔ Servicing the Camera and Accessories

The camera is a precision device and requires regular servicing. Nikon recommends that the camera be inspected by the original retailer or Nikon-authorized service representative once every one to two years, and that it be serviced once every three to five years (note that fees apply to these services). Frequent inspection and servicing are particularly recommended if the camera is used professionally. Any accessories regularly used with the camera, such as lenses or optional flash units, should be included when the camera is inspected or serviced.

## Caring for the Camera and Battery: Cautions

**Do not drop:** The product may malfunction if subjected to strong shocks or vibration.

**Keep dry:** This product is not waterproof, and may malfunction if immersed in water or exposed to high levels of humidity. Rusting of the internal mechanism can cause irreparable damage.

**Avoid sudden changes in temperature:** Sudden changes in temperature, such as those that occur when entering or leaving a heated building on a cold day, can cause condensation inside the device. To prevent condensation, place the device in a carrying case or plastic bag before exposing it to sudden changes in temperature.

**Keep away from strong magnetic fields:** Do not use or store this device in the vicinity of equipment that generates strong electromagnetic radiation or magnetic fields. Strong static charges or the magnetic fields produced by equipment such as radio transmitters could interfere with the monitor, damage data stored on the memory card, or affect the product's internal circuitry.

**Do not leave the lens pointed at the sun:** Do not leave the lens pointed at the sun or other strong light source for an extended period. Intense light may cause the image sensor to deteriorate or produce a white blur effect in photographs.

**Turn the product off before removing or disconnecting the power source:** Do not unplug the product or remove the battery while the product is on or while images are being recorded or deleted. Forcibly cutting power in these circumstances could result in loss of data or in damage to product memory or internal circuitry. To prevent an accidental interruption of power, avoid carrying the product from one location to another while the AC adapter is connected.

**Cleaning:** When cleaning the camera body, use a blower to gently remove dust and lint, then wipe gently with a soft, dry cloth. After using the camera at the beach or seaside, wipe off any sand or salt using a cloth lightly dampened in pure water and then dry the camera thoroughly.

The lens and mirror are easily damaged. Dust and lint should be gently removed with a blower. When using an aerosol blower, keep the can vertical to prevent discharge of liquid. To remove fingerprints and other stains from the lens, apply a small amount of lens cleaner to a soft cloth and wipe the lens carefully.

See “Image Sensor Cleaning” (☐ 328, 330) for information on cleaning the image sensor.

**Do not touch the shutter curtain:** The shutter curtain is extremely thin and easily damaged. Under no circumstances should you exert pressure on the curtain, poke it with cleaning tools, or subject it to powerful air currents from a blower. These actions could scratch, deform, or tear the curtain.

**Storage:** To prevent mold or mildew, store the camera in a dry, well-ventilated area. If you are using an AC adapter, unplug the adapter to prevent fire. If the product will not be used for an extended period, remove the battery to prevent leakage and store the camera in a plastic bag containing a desiccant. Do not, however, store the camera case in a plastic bag, as this may cause the material to deteriorate. Note that desiccant gradually loses its capacity to absorb moisture and should be replaced at regular intervals.

To prevent mold or mildew, take the camera out of storage at least once a month. Turn the camera on and release the shutter a few times before putting it away.

Store the battery in a cool, dry place. Replace the terminal cover before putting the battery away.

**Notes on the monitor:** The monitor is constructed with extremely high precision; at least 99.99% of pixels are effective, with no more than 0.01% being missing or defective. Hence while these displays may contain pixels that are always lit (white, red, blue, or green) or always off (black), this is not a malfunction and has no effect on images recorded with the device.

Images in the monitor may be difficult to see in a bright light.

Do not apply pressure to the monitor, as this could cause damage or malfunction. Dust or lint on the monitor can be removed with a blower. Stains can be removed by wiping lightly with a soft cloth or chamois leather. Should the monitor break, care should be taken to avoid injury from broken glass and to prevent liquid crystal from the monitor touching the skin or entering the eyes and mouth.

**Moiré:** Moiré is an interference pattern created by the interaction of an image containing a regular, repeating grid, such as the pattern of weave in cloth or windows in a building, with the camera image sensor grid. If you notice moiré in your photographs, try changing the distance to the subject, zooming in and out, or changing the angle between the subject and the camera.

**The battery and charger:** Batteries may leak or explode if improperly handled. Read and follow the warnings and cautions on pages xiii–xvi of this manual. Observe the following precautions when handling batteries and chargers:

- Use only batteries approved for use in this equipment.
- Do not expose the battery to flame or excessive heat.
- Keep the battery terminals clean.
- Turn the product off before replacing the battery.
- Remove the battery from the camera or charger when not in use and replace the terminal cover. These devices draw minute amounts of charge even when off and could draw the battery down to the point that it will no longer function. If the battery will not be used for some time, insert it in the camera and run it flat before removing it and storing it in a location with an ambient temperature of 15 °C to 25 °C (59 °F to 77 °F; avoid hot or extremely cold locations). Repeat this process at least once every six months.

- Turning the camera on and off repeatedly when the battery is fully discharged will shorten battery life. Batteries that have been fully discharged must be charged before use.
- The internal temperature of the battery may rise while the battery is in use. Attempting to charge the battery while the internal temperature is elevated will impair battery performance, and the battery may not charge or charge only partially. Wait for the battery to cool before charging.
- Charge the battery indoors at ambient temperatures of 5 °C–35 °C (41 °F–95 °F). Do not use the battery at ambient temperatures below 0 °C (32 °F) or above 40 °C (104 °F); failure to observe this precaution could damage the battery or impair its performance. Capacity may be reduced and charging times may increase at battery temperatures from 0 °C (32 °F) to 15 °C (59 °F) and from 45 °C (113 °F) to 60 °C (140 °F). The battery will not charge if its temperature is below 0 °C (32 °F) or above 60 °C (140 °F).
- If the **CHARGE** lamp flashes quickly (about eight times a second) during charging, confirm that the temperature is in the correct range and then unplug the charger and remove and reinsert the battery. If the problem persists, cease use immediately and take battery and charger to your retailer or a Nikon-authorized service representative.
- Do not move the charger or touch the battery during charging. Failure to observe this precaution could in very rare instances result in the charger showing that charging is complete when the battery is only partially charged. Remove and reinsert the battery to begin charging again.
- Continuing to charge the battery after it is fully charged can impair battery performance.
- A marked drop in the time a fully charged battery retains its charge when used at room temperature indicates that it requires replacement. Purchase a new EN-EL14a battery.
- Use the charger with compatible batteries only. Unplug when not in use.
- Do not short the charger terminals. Failure to observe this precaution could result in overheating and damage to the charger.

- Charge the battery before use. When taking photographs on important occasions, ready a spare battery and keep it fully charged. Depending on your location, it may be difficult to purchase replacement batteries on short notice. Note that on cold days, the capacity of batteries tends to decrease. Be sure the battery is fully charged before taking photographs outside in cold weather. Keep a spare battery in a warm place and exchange the two as necessary. Once warmed, a cold battery may recover some of its charge.
- Recycle rechargeable batteries in accord with local regulations, being sure to first insulate the terminals with tape.

## Available Settings

The following table lists the settings that can be adjusted in each mode. Note that some settings may be unavailable depending on the options selected.

<b>Shooting menu</b>	ISO sensitivity	—	—	✓ <sup>1</sup>	✓ <sup>1</sup>	✓ <sup>1</sup>	—	✓ <sup>1</sup>	✓ <sup>1</sup>	✓ <sup>1</sup>	✓ <sup>1</sup>	✓ <sup>1</sup>	✓ <sup>1</sup>
	White balance	—	—	✓	—	—	—	—	—	—	—	—	—
	Set Picture Control	—	—	✓	—	—	—	—	—	—	—	—	—
	Active D-Lighting	— <sup>2</sup>	— <sup>2</sup>	✓	— <sup>2</sup>	— <sup>2</sup>	—	—	— <sup>2</sup>	—	—	—	—
	HDR (high dynamic range)	—	—	✓	—	—	—	—	—	—	—	—	—
	Long exposure NR	✓	✓	✓	✓	✓	—	✓	✓	✓	✓	✓	✓
	High ISO NR	✓	✓	✓	✓	✓	—	✓	✓	✓	✓	✓	✓
	Time-lapse movie	✓	✓	✓	✓	✓	—	—	—	—	—	—	—
<b>Other settings</b>	Focus mode (viewfinder)	✓	✓	✓	✓	✓	—	✓	✓	✓	✓	✓	✓
	AF-area mode (viewfinder)	✓	✓	✓	✓	✓	—	✓	✓	✓	—	✓	✓
	Focus mode (live view/movie)	✓	✓	✓	✓	✓	✓	✓	✓	✓	✓	✓	✓
	AF-area mode (live view/movie)	—	—	✓	✓	✓	✓ <sup>3</sup>	✓	✓ <sup>3</sup>	✓ <sup>3</sup>	—	✓ <sup>3</sup>	✓



			P, S, A, M										
<b>Other settings</b>	Metering	—	✓	—	—	—	—	—	—	—	—	—	—
	Bracketing	—	✓	—	—	—	—	—	—	—	—	—	—
	Flash compensation	—	✓	✓	✓	—	—	—	—	—	—	—	—
	Exposure compensation	—	✓	✓	✓	✓	—	—	—	—	—	—	—
	Flash mode	✓	—	✓	✓ <sup>4</sup>	—	—	✓	✓	✓	—	—	—
<b>Custom setting menu</b>	a3: Built-in AF-assist illuminator	✓	✓	✓	✓ <sup>5</sup>	✓ <sup>6</sup>	—	✓	✓	✓	—	✓	✓
	e1: Flash cntrl for built-in flash/Optional flash	—	—	✓	—	—	—	—	—	—	—	—	—
	e2: Auto bracketing set	—	—	✓	—	—	—	—	—	—	—	—	—

1 **Auto ISO sensitivity control** is not available.

2 Fixed at **Auto**.

3 Subject-tracking AF is not available.

4 Not available in mode.

5 Not available in mode.

6 Available only in , , and modes.

## Troubleshooting

If the camera fails to function as expected, check the list of common problems below before consulting your retailer or Nikon-authorized service representative.

### **Battery/Display**

---

**The camera is on but does not respond:** Wait for recording to end. If the problem persists, turn the camera off. If the camera does not turn off, remove and reinsert the battery or, if you are using an AC adapter, disconnect and reconnect the AC adapter. Note that although any data currently being recorded will be lost, data that have already been recorded will not be affected by removing or disconnecting the power source.

---

**Viewfinder is out of focus:** Adjust viewfinder focus (☐ 41). If this does not correct the problem, select single-servo autofocus (**AF-S**; ☐ 82), single-point AF ([\*]; ☐ 87), and the center focus point, and then frame a high-contrast subject in the center focus point and press the shutter-release button halfway to focus the camera. With the camera in focus, use the diopter adjustment control to bring the subject into clear focus in the viewfinder. If necessary, viewfinder focus can be further adjusted using optional corrective lenses (☐ 322).

---

**Viewfinder is dark:** Insert a fully-charged battery (☐ 26, 27).

---

**Displays turn off without warning:** Choose longer delays for Custom Setting c2 (**Auto off timers**; ☐ 240).

---

**Information display does not appear in monitor:** Shutter-release button is pressed halfway or eye sensor has turned display off. If information display does not appear when you remove your finger from shutter-release button or uncover eye sensor, confirm that **On** is selected for **Auto info display** (☐ 265) and that battery is charged (☐ 26).

---

**Viewfinder display is unresponsive and dim:** The response times and brightness of this display vary with temperature.

---

---

**Fine lines are visible around active focus point or display turns red when focus point is highlighted:** These phenomena are normal for this type of viewfinder and do not indicate a malfunction.

---

## **Shooting (All Modes)**

---

**Camera takes time to turn on:** Delete files or folders.

---

### **Shutter-release disabled:**

- Memory card is locked, full, or not inserted (☐ 27, 351).
  - **Release locked** is selected for **Slot empty release lock** (☐ 268) and no memory card is inserted (☐ 27).
  - Built-in flash is charging (☐ 54).
  - Camera is not in focus (☐ 50).
  - CPU lens with aperture ring attached but aperture not locked at highest f-number (☐ 307).
  - Non-CPU lens is attached but camera is not in mode **M** (☐ 308).
- 

**Only one shot taken each time shutter-release button is pressed in continuous shooting mode:** Continuous shooting is not available if built-in flash fires (☐ 77, 101).

---

**Final photo is larger than area shown in viewfinder:** Viewfinder horizontal and vertical frame coverage is approximately 95%.

---

### **Photos are out of focus:**

- AF-S, AF-P, or AF-I lens is not attached: use AF-S, AF-P, or AF-I lens or focus manually.
  - Camera unable to focus using autofocus: use manual focus or focus lock (☐ 86, 93, 95).
  - Camera is in manual focus mode: focus manually (☐ 95).
- 

**Focus does not lock when shutter-release button is pressed halfway:** Use  $\text{AF-L}$  ( $\text{AF-L}$ ) button to lock focus when live view is off and **AF-C** is selected for focus mode or when photographing moving subjects in **AF-A** mode (☐ 93).

---

---

**Can not select focus point:**

- **[ ] (Auto-area AF; [ ] 88)** is selected: choose another AF-area mode.
- Press shutter-release button halfway to start standby timer ([ ] 53).

---

**Can not select AF-area mode:** Manual focus selected ([ ] 82, 95).

---

**AF-assist illuminator does not light:**

- AF-assist illuminator does not light if **AF-C** is selected for autofocus mode ([ ] 82) or if continuous-servo autofocus is selected when the camera is in **AF-A** mode. Choose **AF-S**. If an option other than **[ ] (Auto-area AF)** is selected for AF-area mode, select center focus point ([ ] 87, 90).
- The camera is currently in live view.
- **Off** is selected for Custom Setting a3 (**Built-in AF-assist illuminator**, [ ] 237).
- Illuminator has turned off automatically. Illuminator may become hot with continued use; wait for it to cool down.

---

**Image size can not be changed: Image quality** set to **NEF (RAW)** ([ ] 99).

---

**Camera is slow to record photos:**

- Depending on shooting conditions and memory card performance, memory card access lamp may light for up to about a minute after shooting ends in continuous release modes.
  - Turn long exposure noise reduction off ([ ] 230).
-

---

**Noise (bright spots, randomly-spaced bright pixels, fog, or lines) appear in photos:**

- Bright spots, randomly-spaced bright pixels, fog, and lines can be reduced by lowering ISO sensitivity.
- Use the **Long exposure NR** option in the shooting menu to limit the occurrence of bright spots or fog in photos taken at shutter speeds slower than 1 s (☐ 230).
- Fog and bright spots may indicate that the camera's internal temperature has become elevated due to high ambient temperatures, long exposures, or similar causes: turn the camera off and wait for it to cool before resuming shooting.
- At high ISO sensitivities, lines may appear in photos taken with some optional flash units; if this occurs, choose a lower value.
- At high ISO sensitivities, including high values selected with auto ISO sensitivity control, randomly-spaced bright pixels can be reduced by selecting **High, Normal**, or **Low** for **High ISO NR** in the shooting menu (☐ 231).
- At high ISO sensitivities, bright spots, randomly-spaced bright pixels, fog, or lines may be more noticeable in long exposures, and photos taken at high ambient temperatures or with Active D-Lighting enabled, **Flat** selected for **Set Picture Control** (☐ 155) or extreme values selected for Picture Control parameters (☐ 158).
- In  mode, randomly-spaced bright pixels, fog, or lines may be more noticeable in pictures shot under low light.

---

**Can not choose a release mode:** Release mode selection is not available when the monitor is off (☐ 75). Note that the eye sensor may turn the monitor off automatically when you put your eye to the viewfinder.

---

---

**Beep does not sound:**

- **Off** is selected for **Beep options > Beep on/off** (☐ 263).
- Camera is in quiet shutter-release mode (☐ 78), or movie is being recorded (☐ 164).
- **MF** or **AF-C** is selected as the focus mode or subject moves when **AF-A** is selected (☐ 82).

---

**Smudges appear in photographs:** Clean front and rear lens elements. If problem persists, perform image sensor cleaning (☐ 328).

---

**Date is not imprinted on photos:** An NEF (RAW) option is selected for image quality (☐ 99, 243).

---

**Sound is not recorded with movies:** **Microphone off** is selected for **Movie settings > Microphone** (☐ 169).

---

**Live view ends unexpectedly or does not start:** Live view may end automatically to prevent damage to the camera's internal circuits if:

- The ambient temperature is high
- The camera has been used for extended periods in live view or to record movies
- The camera has been used in continuous release modes for extended periods

If live view does not start when you attempt to start live view, wait for the internal circuits to cool and then try again. Note that the camera may feel warm to the touch, but this does not indicate a malfunction.

---

**Image artifacts appear during live view:** "Noise" (randomly-spaced bright pixels, fog, or lines) and unexpected colors may appear if you zoom in on the view through the lens (☐ 53) during live view; in movies, the amount and distribution of randomly-spaced bright pixels, fog, and bright spots are affected by frame size and rate (☐ 168). Randomly-spaced bright pixels, fog, or bright spots may also arise as a result of increases in the temperature of the camera's internal circuits during live view; exit live view when the camera is not in use.

---

**Flicker or banding appears during live view or movie recording:** Choose an option for **Flicker reduction** that matches the frequency of the local AC power supply (☐ 268).

---

**Bright bands appear during live view or movie recording:** A flashing sign, flash, or other light source with brief duration was used during live view or movie recording.

---

**Menu item can not be selected:** Some options are not available in all modes.

---

## **Shooting (P, S, A, M)**

---

### **Shutter-release disabled:**

- Non-CPU lens is attached: rotate camera mode dial to **M** (☐ 308).
  - Mode dial rotated to **S** after shutter speed of “Bulb” or “Time” selected in mode **M**: choose new shutter speed (☐ 121).
  - If white-balance bracketing is active, shutter release will be disabled and viewfinder exposure-count display will flash if there is insufficient space on memory card to record all images in bracketing sequence. Insert new memory card.
- 

### **Full range of shutter speeds not available:**

- Flash in use (☐ 106).
  - When **On** is selected for **Movie settings > Manual movie settings** in the shooting menu, the range of available shutter speed varies with the frame rate (☐ 169).
- 

**Can not select desired aperture:** Range of available apertures varies with lens used.

---

### **Colors are unnatural:**

- Adjust white balance to match light source (☐ 140).
  - Adjust **Set Picture Control** settings (☐ 155).
- 

**Can not measure white balance:** Subject is too dark or too bright (☐ 147).

---

---

**Image can not be selected as source for preset white balance:** Image was not created with D5600 (☞ 149).

---

**White balance bracketing unavailable:** NEF (RAW) or NEF+JPEG image quality option selected for image quality (☞ 98).

---

**Effects of Picture Control differ from image to image:** **A** (auto) is selected for sharpening, clarity, contrast, or saturation. For consistent results over a series of photos, choose another setting (☞ 159).

---

**Metering can not be changed:** Autoexposure lock is in effect (☞ 130).

---

**Exposure compensation can not be used:** Camera is in mode **M**. Choose another mode (☞ 118, 132).

---

**Noise (reddish areas or other artifacts) appears in long time-exposures:** Enable long exposure noise reduction (☞ 230).

---

## **Playback**

---

**NEF (RAW) image is not played back:** Photo was taken at image quality of NEF (RAW)+JPEG (☞ 98).

---

**Can not view pictures recorded with other cameras:** Pictures recorded with other makes of camera may not be displayed correctly.

---

**Some pictures are not displayed during playback:** Select **All** for **Playback folder** (☞ 221).

---

**“Tall” (portrait) orientation photos are displayed in “wide” (landscape) orientation:**

- Select **On** for **Rotate tall** (☞ 222).
  - Photo was taken with **Off** selected for **Auto image rotation** (☞ 222).
  - Photo is displayed in image review (☞ 221).
  - Camera was pointed up or down when photo was taken (☞ 222).
- 

**Can not delete picture:**

- Picture is protected: remove protection (☞ 200).
  - Memory card is locked (☞ 350).
-



---

**Can not retouch picture:** Photo can not be further edited with this camera (☐ 279).

---

**Can not select photo for printing:** Photo is in NEF (RAW) format. Transfer photos to computer and print using Capture NX-D (☐ 210). NEF (RAW) photos can be saved in JPEG format using **NEF (RAW) processing** (☐ 280).

---

**Picture is not displayed on TV:** HDMI (☐ 218) cable is not correctly connected.

---

**Camera does not respond to remote control for HDMI-CEC television:**

- Select **On** for **HDMI > Device control** in the setup menu (☐ 219).
  - Adjust HDMI-CEC settings for the television as described in documentation provided with the device.
- 

**Can not transfer photos to computer:** OS not compatible with camera or transfer software. Use card reader to copy photos to computer.

---

**Image Dust Off option in Capture NX-D does not have desired effect:** Image sensor cleaning changes the position of dust on the image sensor. Image Dust Off reference data recorded before image sensor cleaning is performed can not be used with photographs taken after image sensor cleaning is performed. Image Dust Off reference data recorded after image sensor cleaning is performed can not be used with photographs taken before image sensor cleaning is performed (☐ 266).

---

**Computer displays NEF (RAW) images differently from camera:** Third-party software does not display effects of Picture Controls, Active D-Lighting, or vignette control. Use Capture NX-D (☐ 210).

---

## **Bluetooth and Wi-Fi (Wireless Networks)**

---

**Smart devices do not display the camera SSID (network name):**

- Confirm that **Disable** is selected for **Airplane mode** in the camera setup menu (☞ 271).
  - Confirm that **Enable** is selected for **Bluetooth > Network connection** in the camera setup menu.
  - Try turning the smart device Wi-Fi off and then on again.
- 

**Can not connect to smart devices using NFC:** Choose another connection method.

---

**Can not connect to wireless printers and other wireless devices:** This camera can connect only to devices to which the SnapBridge app has been installed.

---

## **Miscellaneous**

---

**Date of recording is not correct:** Set camera clock (☞ 40, 262).

---



**Menu item can not be selected:** Some options are not available at certain combinations of settings or when no memory card is inserted (☞ 27, 277, 338).



---





## Error Messages

This section lists the indicators and error messages that appear in the viewfinder and monitor.

### Warning Icons





A flashing  in the monitor or  in the viewfinder indicates that a warning or error message can be displayed in the monitor by pressing the  (?) button.

Indicator		Solution	
Monitor	Viewfinder		
<b>Lock lens aperture ring at minimum aperture (largest f/-number).</b>	<b>F E E</b> (flashes)	Set lens aperture ring to minimum aperture (highest f-number).	307
<b>Lens not attached</b>	<b>F - -/?</b> (flashes)	<ul style="list-style-type: none"><li>• Attach non-IX NIKKOR lens.</li><li>• If non-CPU lens is attached, select mode <b>M</b>.</li></ul>	307 123
<b>Before taking photos, rotate the zoom ring to extend the lens.</b>	<b>F - -</b> (flashes)	A lens with a retractable lens barrel button is attached with the lens barrel retracted. Press the retractable lens barrel button and rotate the zoom ring to extend the lens.	31
<b>Shutter release disabled. Recharge battery.</b>	 /? (flashes)	Turn camera off and recharge or replace battery.	26, 27
<b>This battery cannot be used. It does not communicate properly with this camera. To use the camera safely, choose a battery designated for use in this camera.</b>	 (flashes)	Use Nikon-approved battery.	321

Indicator		Solution	📖
Monitor	Viewfinder		
Initialization error. Turn camera off and then on again.	 (flashes)	Turn camera off, remove and replace battery, and then turn camera on again.	27
Battery level is low. Complete operation and turn camera off immediately.	—	End cleaning and turn camera off and recharge or replace battery.	331
Clock not set	 (flashes)	Set camera clock.	40, 262
No memory card inserted	 (flashes)	Turn camera off and confirm that card is correctly inserted.	27
Memory card is locked. Slide lock to “write” position.	 (flashes)	Memory card is locked (write protected). Slide card write-protect switch to “write” position.	—
Cannot access this memory card. Insert another card.	 (flashes)	<ul style="list-style-type: none"> <li>• Use approved card.</li> <li>• Format card. If problem persists, card may be damaged. Contact Nikon-authorized service representative.</li> <li>• Error creating new folder. Delete files or insert new memory card.</li> <li>• Insert new memory card.</li> <li>• Eye-Fi card is still emitting wireless signal after <b>Disable</b> has been selected for <b>Eye-Fi upload</b>. To terminate wireless transmission, turn the camera off and remove the card.</li> </ul>	324 259  27, 205  27 274

Indicator		Solution	📖
Monitor	Viewfinder		
<b>Not available if Eye-Fi card is locked.</b>	[d]/[Err] (flashes)	Eye-Fi card is locked (write protected). Slide card write-protect switch to “write” position.	—
<b>This card is not formatted. Format the card.</b>	[For] (flashes)	Format card or turn camera off and insert new memory card.	27, 259
<b>Card is full</b>	Full/0/? (flashes)	<ul style="list-style-type: none"> <li>• Reduce quality or size.</li> <li>• Delete photographs.</li> <li>• Insert new memory card.</li> </ul>	98 205 27
—	● (flashes)	Camera can not focus using autofocus. Change composition or focus manually.	50, 86, 95
<b>Subject is too bright</b>	? (flashes)	<ul style="list-style-type: none"> <li>• Use a lower ISO sensitivity.</li> <li>• Use commercial ND filter.</li> <li>• In mode: <ul style="list-style-type: none"> <li><b>S</b> Increase shutter speed</li> <li><b>A</b> Choose a smaller aperture (higher f-number)</li> <li><b>☑</b> Choose another shooting mode</li> </ul> </li> </ul>	107 321 121 122 4, 65
<b>Subject is too dark</b>		<ul style="list-style-type: none"> <li>• Use a higher ISO sensitivity.</li> <li>• Use flash.</li> <li>• In mode: <ul style="list-style-type: none"> <li><b>S</b> Lower shutter speed</li> <li><b>A</b> Choose a larger aperture (lower f-number)</li> </ul> </li> </ul>	107 101 121 122

Indicator		Solution	📖
Monitor	Viewfinder		
No "Bulb" in S mode	bulb/? (flashes)	Change shutter speed or select mode M.	121, 123
No "Time" in S mode	- -/? (flashes)		
No "Bulb" in HDR mode	bulb/? (flashes)	<ul style="list-style-type: none"> <li>• Change shutter speed.</li> <li>• Turn HDR off.</li> </ul>	124, 125 138
No "Time" in HDR mode	- -/? (flashes)		
Interval timer shooting	—	Menus and playback are not available while interval timer photography is in progress. To pause, press  .	109
Time-lapse photography	—	Menus and playback are not available while time-lapse photography is in progress.	175

Indicator		Solution	
Monitor	Viewfinder		
—	 (flashes)	Flash has fired at full power. Check photo in monitor; if underexposed, adjust settings and try again.	—
—	 (flashes)	<ul style="list-style-type: none"> <li>• Use the flash.</li> <li>• Change distance to subject, aperture, flash range, or ISO sensitivity.</li> <li>• Lens focal length is less than 18 mm: use a longer focal length.</li> <li>• Optional SB-400 or SB-300 flash unit attached: flash is in bounce position or focus distance is very short. Continue shooting; if necessary, increase focus distance to prevent shadows from appearing in photograph.</li> </ul>	101 106, 107, 122 — —
<b>Error. Press shutter release button again.</b>	 (flashes)	Release shutter. If error persists or appears frequently, consult Nikon-authorized service representative.	—
<b>Start-up error. Contact a Nikon-authorized service representative.</b>		Consult Nikon-authorized service representative.	—
<b>Metering error</b>			
<b>Unable to start live view. Please wait for camera to cool.</b>	—	Wait for the internal circuits to cool before resuming live view or movie recording.	344

Indicator		Solution	📖
Monitor	Viewfinder		
<b>Folder contains no images.</b>	—	Folder selected for playback contains no images. Select folder containing images from <b>Playback folder</b> menu or insert memory card containing images.	27, 221
<b>Cannot display this file.</b>	—	File can not be played back on camera.	—
<b>Cannot select this file.</b>	—	Images created with other devices can not be retouched.	278
<b>This movie cannot be edited.</b>	—	<ul style="list-style-type: none"> <li>• Movies created with other devices can not be edited.</li> <li>• Movies must be at least two seconds long.</li> </ul>	278
			178
<b>No image for retouching.</b>	—	Memory card does not contain NEF (RAW) images for use with <b>NEF (RAW) processing</b> .	280
<b>Network access not available until camera cools.</b>	—	Turn camera off and try again after waiting for camera to cool.	—









Indicator		Solution	
Monitor	Viewfinder		
Check printer.	—	Check printer. To resume, select <b>Continue</b> (if available).	—*
Check paper.	—	Paper is not selected size. Insert paper of correct size and select <b>Continue</b> .	—*
Paper jam.	—	Clear jam and select <b>Continue</b> .	—*
Out of paper.	—	Insert paper of selected size and select <b>Continue</b> .	—*
Check ink supply.	—	Check ink. To resume, select <b>Continue</b> .	—*
Out of ink.	—	Replace ink and select <b>Continue</b> .	—*

\* See printer manual for more information.

# Specifications

## ■ Nikon D5600 Digital Camera



Type	
Type	Single-lens reflex digital camera
Lens mount	Nikon F mount (with AF contacts)
Effective angle of view	Nikon DX format; focal length equivalent to approx. 1.5× that of lenses with FX format angle of view
Effective pixels	
Effective pixels	24.2 million
Image sensor	
Image sensor	23.5 × 15.6 mm CMOS sensor
Total pixels	24.78 million
Dust-reduction System	Image sensor cleaning, Image Dust Off reference data (Capture NX-D software required)
Storage	
Image size (pixels)	<ul style="list-style-type: none"><li>• 6000 × 4000 (Large)</li><li>• 4496 × 3000 (Medium)</li><li>• 2992 × 2000 (Small)</li></ul>
File format	<ul style="list-style-type: none"><li>• <b>NEF (RAW)</b>: 12- or 14 bit, compressed</li><li>• <b>JPEG</b>: JPEG-Baseline compliant with fine (approx. 1 : 4), normal (approx. 1 : 8), or basic (approx. 1 : 16) compression</li><li>• <b>NEF (RAW)+JPEG</b>: Single photograph recorded in both NEF (RAW) and JPEG formats</li></ul>
Picture Control System	Standard, Neutral, Vivid, Monochrome, Portrait, Landscape, Flat; selected Picture Control can be modified; storage for custom Picture Controls
Media	SD (Secure Digital) and UHS-I compliant SDHC and SDXC memory cards
File system	DCF 2.0, Exif 2.3, PictBridge

Viewfinder	
<b>Viewfinder</b>	Eye-level pentamirror single-lens reflex viewfinder
<b>Frame coverage</b>	Approx. 95% horizontal and 95% vertical
<b>Magnification</b>	Approx. 0.82× (50 mm f/1.4 lens at infinity, $-1.0 \text{ m}^{-1}$ )
<b>Eyepoint</b>	17 mm ( $-1.0 \text{ m}^{-1}$ ; from center surface of viewfinder eyepiece lens)
<b>Diopter adjustment</b>	$-1.7 - +0.5 \text{ m}^{-1}$
<b>Focusing screen</b>	Type B BriteView Clear Matte Mark VII screen
<b>Reflex mirror</b>	Quick return
<b>Lens aperture</b>	Instant return, electronically controlled
Lens	
<b>Autofocus support</b>	Autofocus is available with AF-S, AF-P, and AF-I lenses.
Shutter	
<b>Type</b>	Electronically-controlled vertical-travel focal-plane shutter
<b>Speed</b>	$1/4000 - 30 \text{ s}$ in steps of $1/3$ or $1/2 \text{ EV}$ ; Bulb; Time
<b>Flash sync speed</b>	$X = 1/200 \text{ s}$ ; synchronizes with shutter at $1/200 \text{ s}$ or slower
Release	
<b>Release mode</b>	 (single frame),  L (continuous L),  H (continuous H),  (quiet shutter release),  (self-timer); interval timer photography supported
<b>Frame advance rate</b>	<ul style="list-style-type: none"> <li> L: Up to 3 fps</li> <li> H: Up to 5 fps (JPEG and 12-bit NEF/RAW) or 4 fps (14-bit NEF/RAW)</li> </ul> <p><b>Note:</b> Frame rates assume continuous-servo AF, manual or shutter-priority auto exposure, a shutter speed of <math>1/250 \text{ s}</math> or faster, <b>Release</b> selected for Custom Setting a1 (<b>AF-C priority selection</b>), and other settings at default values.</p>
<b>Self-timer</b>	2 s, 5 s, 10 s, 20 s; 1–9 exposures

Exposure	
<b>Metering mode</b>	TTL exposure metering using 2016-pixel RGB sensor
<b>Metering method</b>	<ul style="list-style-type: none"> <li>• <b>Matrix metering:</b> 3D color matrix metering II (type G, E, and D lenses); color matrix metering II (other CPU lenses)</li> <li>• <b>Center-weighted metering:</b> Weight of 75% given to 8-mm circle in center of frame</li> <li>• <b>Spot metering:</b> Meters 3.5-mm circle (about 2.5% of frame) centered on selected focus point</li> </ul>
<b>Range (ISO 100, f/1.4 lens, 20 °C/68 °F)</b>	<ul style="list-style-type: none"> <li>• <b>Matrix or center-weighted metering:</b> 0–20 EV</li> <li>• <b>Spot metering:</b> 2–20 EV</li> </ul>
<b>Exposure meter coupling</b>	CPU
<b>Mode</b>	Auto modes (📷 <sup>AUTO</sup> auto; 📷 auto, flash off); programmed auto with flexible program (P); shutter-priority auto (S); aperture-priority auto (A); manual (M); scene modes (👤 portrait; 🏞 landscape; 👦 child; 🏃 sports; 🌸 close up; 🌃 night portrait; 🌃 night landscape; 🎉 party/indoor; 🏖 beach/snow; 🌅 sunset; 🌆 dusk/dawn; 🐾 pet portrait; 🕯 candlelight; 🌸 blossom; 🌈 autumn colors; 🍷 food); special effects modes (🌃 night vision; VI super vivid; POP pop; 🎨 photo illustration; 📷 toy camera effect; 🏠 miniature effect; 🖌 selective color; 🖋 silhouette; 🌞 high key; 🌑 low key)
<b>Exposure compensation</b>	Can be adjusted by –5 – +5 EV in increments of 1/3 or 1/2 EV in P, S, A, M, SCENE, and 📷 modes

Exposure	
<b>Exposure lock</b>	Luminosity locked at detected value with $\text{AE-L/AF-L}$ (O) button
<b>ISO sensitivity (Recommended Exposure Index)</b>	ISO 100 – 25600 in steps of $1/3$ EV. Auto ISO sensitivity control available
<b>Active D-Lighting</b>	暗 A Auto, 暗 H* Extra high, 暗 H High, 暗 N Normal, 暗 L Low, OFF Off
Focus	
<b>Autofocus</b>	Nikon Multi-CAM 4800DX autofocus sensor module with TTL phase detection, 39 focus points (including 9 cross-type sensors), and AF-assist illuminator (range approx. 0.5–3 m/1 ft 8 in.–9 ft 10 in.)
<b>Detection range</b>	-1 – +19 EV (ISO 100, 20 °C/68 °F)
<b>Lens servo</b>	<ul style="list-style-type: none"> <li>• <b>Autofocus (AF):</b> Single-servo AF (AF-S); continuous-servo AF (AF-C); auto AF-S/AF-C selection (AF-A); predictive focus tracking activated automatically according to subject status</li> <li>• <b>Manual focus (MF):</b> Electronic rangefinder can be used</li> </ul>
<b>Focus point</b>	Can be selected from 39 or 11 focus points
<b>AF-area mode</b>	Single-point AF, 9-, 21-, or 39- point dynamic-area AF, 3D-tracking, auto-area AF
<b>Focus lock</b>	Focus can be locked by pressing shutter-release button halfway (single-servo AF) or by pressing $\text{AE-L/AF-L}$ (O) button

Flash	
<b>Built-in flash</b>	: Auto flash with auto pop-up <b>P, S, A, M, 11</b> : Manual pop-up with button release
<b>Guide Number</b>	Approx. 12/39, 12/39 with manual flash (m/ft, ISO 100, 20 °C/68 °F)
<b>Flash control</b>	<b>TTL</b> : i-TTL flash control using 2016-pixel RGB sensor is available with built-in flash; i-TTL balanced fill-flash for digital SLR is used with matrix and center-weighted metering, standard i-TTL flash for digital SLR with spot metering
<b>Flash mode</b>	Auto, auto with red-eye reduction, auto slow sync, auto slow sync with red-eye reduction, fill-flash, red-eye reduction, slow sync, slow sync with red-eye reduction, rear-curtain with slow sync, rear-curtain sync, off
<b>Flash compensation</b>	Can be adjusted by -3 – +1 EV in increments of 1/3 or 1/2 EV in <b>P, S, A, M</b> , and <b>SCENE</b> modes
<b>Flash-ready indicator</b>	Lights when built-in flash or optional flash unit is fully charged; blinks after flash is fired at full output
<b>Accessory shoe</b>	ISO 518 hot-shoe with sync and data contacts and safety lock
<b>Nikon Creative Lighting System (CLS)</b>	Nikon CLS supported
<b>Sync terminal</b>	AS-15 sync terminal adapter (available separately)
White balance	
<b>White balance</b>	Auto, incandescent, fluorescent (7 types), direct sunlight, flash, cloudy, shade, preset manual, all except preset manual with fine-tuning.
Bracketing	
<b>Bracketing types</b>	Exposure, white balance, and ADL

Live view	
<b>Lens servo</b>	<ul style="list-style-type: none"> <li>• <b>Autofocus (AF):</b> Single-servo AF (<b>AF-S</b>); full-time-servo AF (<b>AF-F</b>)</li> <li>• <b>Manual focus (MF)</b></li> </ul>
<b>AF-area mode</b>	Face-priority AF, wide-area AF, normal-area AF, subject-tracking AF
<b>Autofocus</b>	Contrast-detect AF anywhere in frame (camera selects focus point automatically when face-priority AF or subject-tracking AF is selected)
<b>Automatic scene selection</b>	Available in  and  modes
Movie	
<b>Metering</b>	TTL exposure metering using main image sensor
<b>Metering method</b>	Matrix
<b>Frame size (pixels) and frame rate</b>	<ul style="list-style-type: none"> <li>• 1920 × 1080; 60p (progressive), 50p, 30p, 25p, 24p</li> <li>• 1280 × 720; 60p, 50p</li> </ul> <p>Actual frame rates for 60p, 50p, 30p, 25p, and 24p are 59.94, 50, 29.97, 25, and 23.976 fps respectively; options support both ★ high and normal image quality</p>
<b>File format</b>	MOV
<b>Video compression</b>	H.264/MPEG-4 Advanced Video Coding
<b>Audio recording format</b>	Linear PCM
<b>Audio recording device</b>	Built-in or external stereo microphone; sensitivity adjustable
<b>ISO sensitivity</b>	ISO 100–25600
<b>Other options</b>	Time-lapse movies
Monitor	
<b>Monitor</b>	8.1 cm/3.2-in. (3 : 2), approx. 1037k-dot (720 × 480 × 3 = 1,036,800 dots), TFT vari-angle LCD touch screen with 170 ° viewing angle, approx. 100% frame coverage, brightness adjustment, and eye-sensor controlled on/off

Playback	
<b>Playback</b>	Full-frame and thumbnail (4, 12, or 80 images or calendar) playback with playback zoom, playback zoom cropping, playback face zoom, movie playback, photo and/or movie slide shows, histogram display, highlights, photo information, location data display, auto image rotation, picture rating, and image comment (up to 36 characters)
Interface	
<b>USB</b>	Hi-Speed USB with Micro-USB connector; connection to built-in USB port is recommended
<b>HDMI output</b>	Type C HDMI connector
<b>Accessory terminal</b>	<ul style="list-style-type: none"> <li>• <b>Wireless remote controllers:</b> WR-1, WR-R10 (available separately)</li> <li>• <b>Remote cords:</b> MC-DC2 (available separately)</li> <li>• <b>GPS units:</b> GP-1/GP-1A (available separately)</li> </ul>
<b>Audio input</b>	Stereo mini-pin jack (3.5 mm diameter); supports optional ME-1 stereo microphones
Wireless/Bluetooth	
<b>Wireless</b>	<ul style="list-style-type: none"> <li>• <b>Standards:</b> IEEE 802.11b, IEEE 802.11g</li> <li>• <b>Operating frequency:</b> 2412–2462 MHz (channels 1–11)</li> <li>• <b>Maximum output power:</b> 6.6 dBm (EIRP)</li> <li>• <b>Authentication:</b> Open system, WPA2-PSK</li> </ul>
<b>Bluetooth</b>	<ul style="list-style-type: none"> <li>• <b>Communication protocols:</b> Bluetooth Specification Version 4.1</li> <li>• <b>Operating frequency</b> Bluetooth: 2402–2480 MHz Bluetooth Low Energy: 2402–2480 MHz</li> <li>• <b>Maximum output power (EIRP)</b> Bluetooth: 4.6 dBm Bluetooth Low Energy: 4.6 dBm</li> </ul>
<b>Range (line of sight)</b>	Approximately 10 m (32 ft) without interference; range may vary with signal strength and presence or absence of obstacles



<b>NFC</b>	
<b>Operation</b>	NFC Forum Type 3 Tag
<b>Operating frequency</b>	13.56 MHz
<b>Supported languages</b>	
<b>Supported languages</b>	Arabic, Bengali, Bulgarian, Chinese (Simplified and Traditional), Czech, Danish, Dutch, English, Finnish, French, German, Greek, Hindi, Hungarian, Indonesian, Italian, Japanese, Korean, Marathi, Norwegian, Persian, Polish, Portuguese (Portugal and Brazil), Romanian, Russian, Serbian, Spanish, Swedish, Tamil, Telugu, Thai, Turkish, Ukrainian, Vietnamese
<b>Power source</b>	
<b>Battery</b>	One EN-EL14a rechargeable Li-ion battery
<b>AC adapter</b>	EH-5b/EH-5c AC adapter; requires EP-5A power connector (available separately)
<b>Tripod socket</b>	
<b>Tripod socket</b>	1/4 in. (ISO 1222)
<b>Dimensions/weight</b>	
<b>Dimensions (W × H × D)</b>	Approx. 124 × 97 × 70 mm (4.9 × 3.9 × 2.8 in.)
<b>Weight</b>	Approx. 465 g (1 lb 0.4 oz) with battery and memory card but without body cap; approx. 415 g/14.7 oz (camera body only)
<b>Operating environment</b>	
<b>Temperature</b>	0 °C–40 °C (+32 °F–104 °F)
<b>Humidity</b>	85% or less (no condensation)

- Unless otherwise stated, all measurements are performed in conformity with Camera and Imaging Products Association (CIPA) standards or guidelines.
- All figures are for a camera with a fully-charged battery.
- The sample images displayed on the camera and the images and illustrations in the manual are for expository purposes only.
- Nikon reserves the right to change the appearance and specifications of the hardware and software described in this manual at any time and without prior notice. Nikon will not be held liable for damages that may result from any mistakes that this manual may contain.

## ■ ■ MH-24 Battery Charger

<b>Rated input</b>	AC 100–240 V, 50/60 Hz, 0.2 A maximum
<b>Rated output</b>	DC 8.4 V/0.9 A
<b>Supported batteries</b>	Nikon EN-EL14a rechargeable Li-ion batteries
<b>Charging time</b>	Approx. 1 hour and 50 minutes at an ambient temperature of 25 °C (77 °F) when no charge remains
<b>Operating temperature</b>	0 °C–40 °C (+32 °F–104 °F)
<b>Dimensions (W × H × D)</b>	Approx. 70 × 26 × 97 mm (2.8 × 1.0 × 3.8 in.), excluding plug adapter
<b>Weight</b>	Approx. 96 g (3.4 oz), excluding plug adapter

The symbols on this product represent the following:

~ AC, --- DC,  Class II equipment (The construction of the product is double-insulated.)

## ■ ■ EN-EL14a Rechargeable Li-ion Battery

<b>Type</b>	Rechargeable lithium-ion battery
<b>Rated capacity</b>	7.2 V/1230 mAh
<b>Operating temperature</b>	0 °C–40 °C (+32 °F–104 °F)
<b>Dimensions (W × H × D)</b>	Approx. 38 × 53 × 14 mm (1.5 × 2.1 × 0.6 in.)
<b>Weight</b>	Approx. 49 g (1.7 oz), excluding terminal cover

Nikon reserves the right to change the appearance and specifications of the hardware and software described in this manual at any time and without prior notice. Nikon will not be held liable for damages that may result from any mistakes that this manual may contain.

## ■ ■ *Supported Standards*

- **DCF Version 2.0:** The Design Rule for Camera File Systems (DCF) is a standard widely used in the digital camera industry to ensure compatibility among different makes of camera.
- **Exif version 2.3:** The camera supports Exif (Exchangeable Image File Format for Digital Still Cameras) version 2.3, a standard in which information stored with photographs is used for optimal color reproduction when the images are output on Exif-compliant printers.
- **PictBridge:** A standard developed through cooperation with the digital camera and printer industries, allowing photographs to be output directly to a printer without first transferring them to a computer.
- **HDMI: High-Definition Multimedia Interface** is a standard for multimedia interfaces used in consumer electronics and AV devices capable of transmitting audiovisual data and control signals to HDMI-compliant devices via a single cable connection.

## Trademark Information

IOS is a trademark or registered trademark of Cisco Systems, Inc., in the United States and/or other countries and is used under license. Windows is either a registered trademark or a trademark of Microsoft Corporation in the United States and/or other countries. Mac, OS X, Apple®, App Store®, the Apple logos, iPhone®, iPad®, and iPod touch® are trademarks of Apple Inc. registered in the U.S. and/or other countries. Android, Google Play and the Google Play logo are trademarks of Google LLC. The Android robot is reproduced or modified from work created and shared by Google and used according to terms described in the Creative Commons 3.0 Attribution License. PictBridge logo is a trademark. The SD, SDHC, and SDXC logos are trademarks of the SD-3C, LLC. HDMI, the HDMI logo and High-Definition Multimedia Interface are trademarks or registered trademarks of HDMI Licensing LLC.

## **HDMI**

Wi-Fi and the Wi-Fi logo are trademarks or registered trademarks of the Wi-Fi Alliance. N-Mark is a trademark or registered trademark of NFC Forum, Inc., in the United States and/or other countries.

The Bluetooth® word mark and logos are registered trademarks owned by Bluetooth SIG, Inc. and any use of such marks by Nikon Corporation is under license.

All other trade names mentioned in this manual or the other documentation provided with your Nikon product are trademarks or registered trademarks of their respective holders.

Use of the Made for Apple badge means that an accessory has been designed to connect specifically to the Apple products identified in the badge, and has been certified by the developer to meet Apple performance standards. Apple is not responsible for the operation of this device or its compliance with safety and regulatory standards. Please note that the use of this accessory with an Apple product may affect wireless performance.

### **Conformity Marking**

The standards with which the camera complies can be viewed using the **Conformity marking** option in the setup menu (📖 276).

### **FreeType License (FreeType2)**

Portions of this software are copyright © 2012 The FreeType Project (<http://www.freetype.org>). All rights reserved.

### **MIT License (HarfBuzz)**

Portions of this software are copyright © 2016 The HarfBuzz Project (<http://www.freedesktop.org/wiki/Software/HarfBuzz>). All rights reserved.

## Certificates

- **México**

**IFETEL: RCPMULB16-0363**

**LBEE5UW1FS**

Módulo WLAN instalado adentro de esta computadora

La operación de este equipo está sujeta a las siguientes dos condiciones:

- (1) es posible que este equipo o dispositivo no cause interferencia perjudicial y
- (2) este equipo o dispositivo debe aceptar cualquier interferencia, incluyendo la que pueda causar su operación no deseada.

- **Paraguay**

**Número del Registro: 2016-01-I-000022**

Este producto contiene un transmisor aprobado por la CONATEL.

• الأردن

**TRC/SS/2016/432**

• الإمارات العربية المتحدة

**TRA**

**REGISTERED No:**

**ER45171/16**

**DEALER No:**

**DA39487/15**

## AF-P DX NIKKOR 18–55mm f/3.5–5.6G VR Lenses

Read this section if you purchased the camera with the AF-P DX NIKKOR 18–55mm f/3.5–5.6G VR lens kit available in some countries or regions. The parts of the lens are listed below.

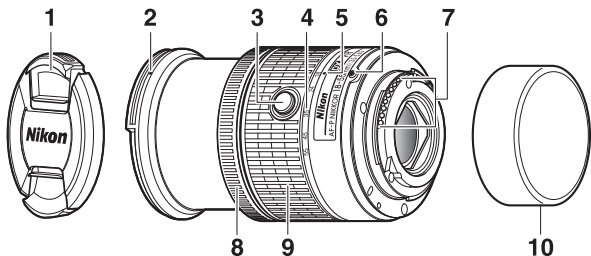

1 Lens cap

2 Lens hood mounting mark

3 Retractable lens barrel button... 31

4 Focal length scale

5 Focal length mark

6 Lens mounting mark..... 30

7 CPU contacts..... 307

8 Focus ring ..... 95

9 Zoom ring ..... 49

10 Rear lens cap

This retractable lens is for use exclusively with DX format Nikon digital SLR cameras; SLR film cameras and D3-series, D2-series, D1-series, D700, D300-series, D200, D100, D90, D80, D70-series, D60, D50, D40-series, D7000, D5100, D5000, D3200, D3100, D3000 digital SLR cameras are not supported. When using it with a D5, D4-series, D810-series, D800-series, Df, D750, D610, D600, D7200, D7100, D5500, D5300, or D3300, be sure the camera firmware has been updated to the latest version.

## ■ ■ Focus

The focus mode can be selected using camera controls (☞ 82).

### **Autofocus**

Focus is adjusted automatically when the camera is in autofocus mode (☞ 82). The focus ring can also be used to focus the camera if the shutter-release button is kept pressed halfway (or if the AF-ON button is kept pressed); this is known as “autofocus with manual override” (M/A). Autofocus will resume when the shutter-release button is pressed halfway (or the AF-ON button is pressed) a second time. Note that touching the focus ring while autofocus is in effect will change the focus position.

### **Manual Focus**

When the camera is in manual focus mode, focus can be adjusted by rotating the lens focus ring (☞ 95). When the camera is off or the standby timer has expired, the focus ring can not be used to focus and rotating the zoom ring will change the focus position; before focusing, turn the camera on or press the shutter-release button to reactivate the standby timer.

Users of D5200 cameras should note that if the standby timer is allowed to expire, the focus position will change when the timer is restarted. Refocus before shooting. Longer standby times are recommended for manual focus and in other situations in which you may not release the shutter immediately after focusing.



## ■ ■ Using the Built-in Flash

When using the built-in flash, be sure the subject is at a range of at least 0.6 m (2 ft) and remove lens hoods to prevent vignetting (shadows created where the end of the lens obscures the built-in flash).

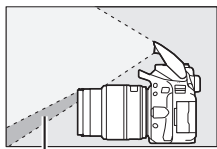

*Shadow*



*Vignetting*

When the lens is mounted on the following cameras, the built-in flash may be unable to light the entire subject at ranges less than those given below:

Camera	Zoom position	Minimum distance without vignetting
D5600/D5500/D5300/D5200/ D3400/D3300	18 mm	1.0 m/3 ft 4 in.
	24, 35, 45, and 55 mm	No vignetting

## ■ **Vibration Reduction (VR)**

When an AF-P DX NIKKOR 18–55mm f/3.5–5.6G VR is mounted on the camera, vibration reduction can be enabled or disabled using the **Optical VR** option in the shooting menu (☞ 232). If **On** is selected, vibration reduction will take effect whenever the shutter-release button is pressed halfway. Vibration reduction reduces blur caused by camera shake, allowing shutter speeds up to 4.0 stops slower than would otherwise be the case, increasing the range of shutter speeds available. The effects of VR on shutter speed are measured according to Camera and Imaging Products Association (CIPA) standards; FX-format lenses are measured using FX-format digital cameras, DX-format lenses using DX-format cameras. Zoom lenses are measured at maximum zoom.

### ✓ **Vibration Reduction**

- When using vibration reduction, press the shutter-release button halfway and wait for the image in the viewfinder to stabilize before pressing the shutter-release button the rest of the way down.
- When vibration reduction is active, the image in the viewfinder may jiggle after the shutter is released. This does not indicate a malfunction.
- When the camera is panned, vibration reduction applies only to motion that is not part of the pan (if the camera is panned horizontally, for example, vibration reduction will be applied only to vertical shake), making it much easier to pan the camera smoothly in a wide arc.
- If the camera is equipped with a built-in flash, vibration reduction will be disabled while the flash charges.
- Vibration reduction is generally recommended when the camera is mounted on a tripod, although you may prefer to turn it off depending on shooting conditions and the type of tripod.
- Vibration reduction is recommended when the camera is mounted on a monopod.

## ■ ■ Supplied Accessories

- LC-55A 55 mm Snap-on Front Lens Cap
- Rear Lens Cap

## ■ ■ Compatible Accessories

- 55 mm screw-on filters
- LF-4 Rear Lens Cap
- CL-0815 Lens Case
- HB-N106 Bayonet Hood

Align the lens hood mounting mark (●) with the lens hood alignment mark (┌) as shown in Figure ① and then rotate the hood (②) until the ● mark is aligned with the lens hood lock mark (—○).

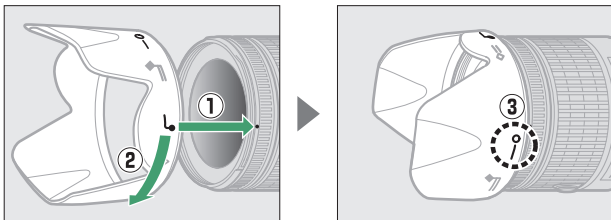

When attaching or removing the hood, hold it near the symbol on its base and avoid gripping it too tightly. Vignetting may occur if the hood is not correctly attached. The hood can be reversed and mounted on the lens when not in use.

## ■ Specifications

Type	Type G AF-P DX lens with built-in CPU and F mount
Focal length	18–55 mm
Maximum aperture	f/3.5–5.6
Lens construction	12 elements in 9 groups (2 aspherical lens elements)
Angle of view	76° – 28° 50'
Focal length scale	Graduated in millimeters (18, 24, 35, 45, 55)
Distance information	Output to camera
Zoom	Manual zoom using independent zoom ring
Focusing	Autofocus controlled by stepping motor; separate focus ring for manual focus
Vibration reduction	Lens shift using voice coil motors (VCMs)
Minimum focus distance	0.25 m (0.9 ft) from focal plane (□ 96) at all zoom positions
Diaphragm blades	7 (rounded diaphragm opening)
Diaphragm	Fully automatic
Aperture range	<ul style="list-style-type: none"><li>• <b>18 mm focal length:</b> f/3.5–22</li><li>• <b>55 mm focal length:</b> f/5.6–38</li></ul> The minimum aperture displayed may vary depending on the size of the exposure increment selected with the camera.
Metering	Full aperture
Filter-attachment size	55 mm (P = 0.75 mm)
Dimensions	Approx. 64.5 mm maximum diameter × 62.5 mm (distance from camera lens mount flange when lens is retracted)
Weight	Approx. 205 g (7.3 oz)

## AF-P DX NIKKOR 70–300mm f/4.5–6.3G ED VR and AF-P DX NIKKOR 70–300mm f/4.5–6.3G ED Lenses

Read this section if you purchased the camera with the AF-P DX NIKKOR 70–300mm f/4.5–6.3G ED VR or AF-P DX NIKKOR 70–300mm f/4.5–6.3G ED lens kit available in some countries or regions. The parts of the lens are listed below.

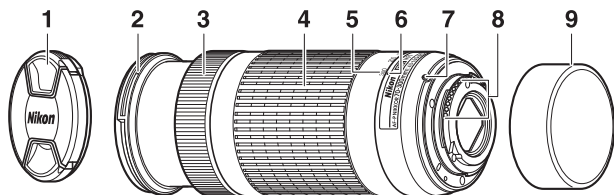

1	Lens cap	6	Focal length mark
2	Lens hood mounting mark	7	Lens mounting mark..... 30
3	Focus ring..... 95	8	CPU contacts..... 307
4	Zoom ring ..... 49	9	Rear lens cap
5	Focal length scale		

These lenses are for use exclusively with DX format Nikon digital SLR cameras; SLR film cameras and D3-series, D2-series, D1-series, D700, D300-series, D200, D100, D90, D80, D70-series, D60, D50, D40-series, D7000, D5100, D5000, D3200, D3100, D3000 digital SLR cameras are not supported. When using these lenses with a D5, D4-series, D810-series, D800-series, Df, D750, D610, D600, D7200, D7100, D5500, D5300, or D3300, be sure the camera firmware has been updated to the latest version.

## ■ Focus

The focus mode can be selected using camera controls (☞ 82). Autofocus and rangefinder features are supported at all focal lengths. When using this lens, ignore any sections of the camera manual listing autofocus and rangefinder restrictions for lenses with a maximum aperture slower than f/5.6.

### Autofocus

Focus is adjusted automatically when the camera is in autofocus mode (☞ 82). The focus ring can also be used to focus the camera if the shutter-release button is kept pressed halfway (or if the AF-ON button is kept pressed); this is known as “autofocus with manual override” (M/A). Autofocus will resume when the shutter-release button is pressed halfway (or the AF-ON button is pressed) a second time. Note that touching the focus ring while autofocus is in effect will change the focus position.

### Manual Focus

When the camera is in manual focus mode, focus can be adjusted by rotating the lens focus ring (☞ 95). When the camera is off or the standby timer has expired, the focus ring can not be used to focus and rotating the zoom ring will change the focus position; before focusing, turn the camera on or press the shutter-release button to reactivate the standby timer.

Users of D5200 cameras should note that if the standby timer is allowed to expire, the focus position will change when the timer is restarted. Refocus before shooting. Longer standby times are recommended for manual focus and in other situations in which you may not release the shutter immediately after focusing.

## ■ ■ **Vibration Reduction (VR, AF-P DX NIKKOR 70–300 mm f/4.5–6.3G ED VR Only)**

When an AF-P DX NIKKOR 70–300 mm f/4.5–6.3G ED VR is mounted on the camera, vibration reduction can be enabled or disabled using the **Optical VR** option in the shooting menu (☞ 232). If **On** is selected, vibration reduction will take effect whenever the shutter-release button is pressed halfway.

Vibration reduction reduces blur caused by camera shake, allowing shutter speeds up to 4.0 stops slower than would otherwise be the case, increasing the range of shutter speeds available. The effects of VR on shutter speed are measured according to Camera and Imaging Products Association (CIPA) standards; FX-format lenses are measured using FX-format digital SLR cameras, DX-format lenses using DX-format cameras. Zoom lenses are measured at maximum zoom.

### ✔ **Vibration Reduction**

- When using vibration reduction, press the shutter-release button halfway and wait for the image in the viewfinder to stabilize before pressing the shutter-release button the rest of the way down.
- When vibration reduction is active, the image in the viewfinder may jiggle after the shutter is released. This does not indicate a malfunction.
- When the camera is panned, vibration reduction applies only to motion that is not part of the pan (if the camera is panned horizontally, for example, vibration reduction will be applied only to vertical shake), making it much easier to pan the camera smoothly in a wide arc.
- If the camera is equipped with a built-in flash, vibration reduction will be disabled while the flash charges.
- Vibration reduction is generally recommended when the camera is mounted on a tripod, although you may prefer to turn it off depending on shooting conditions and the type of tripod.
- Vibration reduction is recommended when the camera is mounted on a monopod.

## ■ Supplied Accessories

- LC-58 58 mm Snap-on Front Lens Cap
- Rear Lens Cap

## ■ Compatible Accessories

- 58 mm screw-on filters
- LF-4 Rear Lens Cap
- CL-1020 Lens Case
- HB-77 Bayonet Hood

Align the lens hood mounting mark (●) with the lens hood alignment mark (☞) as shown in Figure ① and then rotate the hood (②) until the ● mark is aligned with the lens hood lock mark (—○).

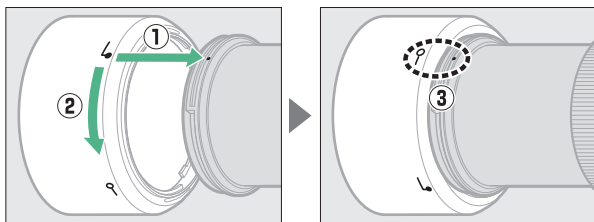

When attaching or removing the hood, hold it near the symbol on its base and avoid gripping it too tightly. Vignetting may occur if the hood is not correctly attached. The hood can be reversed and mounted on the lens when not in use. When the hood is reversed, it can be attached and removed by rotating it while holding it near the lock mark (—○).



## ■ Specifications

Type	Type G AF-P DX lens with built-in CPU and F mount
Focal length	70–300 mm
Maximum aperture	f/4.5–6.3
Lens construction	14 elements in 10 groups (including 1 ED lens element)
Angle of view	22° 50′ – 5° 20′
Focal length scale	Graduated in millimeters (70, 100, 135, 200, 300)
Distance information	Output to camera
Zoom	Manual zoom using independent zoom ring
Focusing	Autofocus controlled by stepping motor; separate focus ring for manual focus
Vibration reduction (AF-P DX NIKKOR 70–300mm f/4.5–6.3G ED VR only)	Lens shift using voice coil motors (VCMs)
Minimum focus distance	1.1 m (3.7 ft) from focal plane (□ 96) at all zoom positions
Diaphragm blades	7 (rounded diaphragm opening)
Diaphragm	Fully automatic
Aperture range	<ul style="list-style-type: none"><li>• <b>70 mm focal length:</b> f/4.5–22</li><li>• <b>300 mm focal length:</b> f/6.3–32</li></ul> The minimum aperture displayed may vary depending on the size of the exposure increment selected with the camera.
Metering	Full aperture
Filter-attachment size	58 mm (P = 0.75 mm)
Dimensions	Approx. 72 mm maximum diameter × 125 mm (distance from camera lens mount flange)
Weight	<ul style="list-style-type: none"><li>• <b>AF-P DX NIKKOR 70–300mm f/4.5–6.3G ED VR:</b> Approx. 415 g (14.7 oz)</li><li>• <b>AF-P DX NIKKOR 70–300mm f/4.5–6.3G ED:</b> Approx. 400 g (14.2 oz)</li></ul>

## AF-S DX NIKKOR 18–140mm f/3.5–5.6G ED VR Lenses

Read this section if you purchased the camera with the AF-S DX NIKKOR 18–140mm f/3.5–5.6G ED VR lens kit available in some countries or regions. The parts of the lens are listed below.

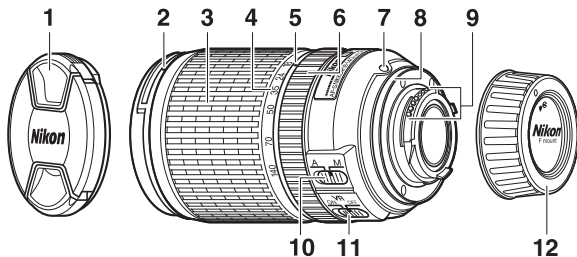

1	Lens cap	8	Rubber lens-mount gasket
2	Lens hood mounting mark	9	CPU contacts.....307
3	Zoom ring .....49	10	A-M mode switch.....31, 95
4	Focal length scale	11	Vibration reduction ON/OFF switch .....382
5	Focal length mark	12	Rear lens cap
6	Focus ring.....95		
7	Lens mounting mark.....30		

This lens is for use exclusively with DX format Nikon digital cameras.

### ■ Focus

Focus mode is determined by the camera focus mode and the position of the lens A-M mode switch (☐ 82, 95).

#### ✔ Focusing with AF-S DX NIKKOR 18–140mm f/3.5–5.6G ED VR Lenses

When single-servo AF (AF-S) is selected as the camera focus mode and the lens A-M switch is set to **A**, focus can be adjusted by keeping the shutter-release button pressed halfway after the autofocus operation is complete and manually rotating the focus ring. To refocus using autofocus, press the shutter-release button halfway again.

## ■ ■ Using the Built-in Flash

When using the built-in flash, be sure the subject is at a range of at least 0.6 m (2 ft) and remove lens hoods to prevent vignetting (shadows created where the end of the lens obscures the built-in flash).

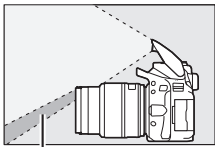

Shadow



Vignetting

When the lens is mounted on the following cameras, the built-in flash may be unable to light the entire subject at ranges less than those given below:

Camera	Zoom position	Minimum distance without vignetting
D7200/D7100/D7000/ D300 series/D200/D100	18 mm	1.0 m/3 ft 3 in.
	24–140 mm	No vignetting
D90/D80/D50	18 mm	2.5 m/8 ft 2 in.
	24 mm	1.0 m/3 ft 3 in.
	35–140 mm	No vignetting
D5600/D5500/D5300/D5200/ D5100/D5000/D3400/D3300/ D3200/D3100/D3000/D70 series/ D60/D40 series	24 mm	1.0 m/3 ft 3 in.
	35–140 mm	No vignetting

## ■ ■ **Vibration Reduction (VR)**

Vibration reduction can be enabled by sliding the vibration reduction switch to **ON** and takes effect whenever the shutter-release button is pressed halfway. Vibration reduction reduces blur caused by camera shake, allowing shutter speeds up to 4.0 stops slower than would otherwise be the case (as measured at 140 mm with a D300s camera according to Camera and Imaging Products Association [CIPA] standards; effects vary with the photographer and shooting conditions). This increases the range of shutter speeds available.



### ✓ **Vibration Reduction**

- When using vibration reduction, press the shutter-release button halfway and wait for the image in the viewfinder to stabilize before pressing the shutter-release button the rest of the way down.
- When vibration reduction is active, the image in the viewfinder may jiggle after the shutter is released. This does not indicate a malfunction.
- When the camera is panned, vibration reduction applies only to motion that is not part of the pan (if the camera is panned horizontally, for example, vibration reduction will be applied only to vertical shake), making it much easier to pan the camera smoothly in a wide arc.
- Do not turn the camera off or remove the lens while vibration reduction is in effect. If power to the lens is cut while vibration reduction is on, the lens may rattle when shaken. This is not a malfunction, and can be corrected by reattaching the lens and turning the camera on.
- If the camera is equipped with a built-in flash, vibration reduction will be disabled while the flash charges.
- Select **OFF** when the camera is mounted on a tripod unless the tripod head is unsecured or the camera is mounted on a monopod, in which case **ON** is recommended.

## ■ ■ Supplied Accessories

- LC-67 67 mm Snap-on Front Lens Cap
- Rear Lens Cap

## ■ ■ Compatible Accessories

- 67 mm screw-on filters
- LF-4 Rear Lens Cap
- CL-1018 Flexible Lens Pouch
- HB-32 Bayonet Hood

Align the lens hood mounting mark (●) with the lens hood alignment mark (┌) as shown in Figure ① and then rotate the hood (②) until the ● mark is aligned with the lens hood lock mark (—○).

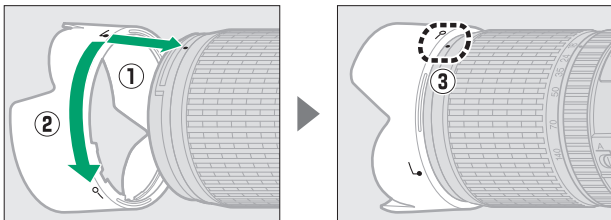

When attaching or removing the hood, hold it near the symbol on its base and avoid gripping it too tightly. Vignetting may occur if the hood is not correctly attached. The hood can be reversed and mounted on the lens when not in use.

## ■ Specifications

Type	Type G AF-S DX lens with built-in CPU and F mount
Focal length	18–140 mm
Maximum aperture	f/3.5–5.6
Lens construction	17 elements in 12 groups (including 1 ED lens element, 1 aspherical lens element)
Angle of view	76° – 11° 30′
Focal length scale	Graduated in millimeters (18, 24, 35, 50, 70, 140)
Distance information	Output to camera
Zoom	Manual zoom using independent zoom ring
Focusing	Nikon Internal Focusing (IF) System with autofocus controlled by Silent Wave Motor and separate focus ring for manual focus
Vibration reduction	Lens shift using voice coil motors (VCMs)
Minimum focus distance	0.45 m (1.48 ft) from focal plane (□ 96) at all zoom positions
Diaphragm blades	7 (rounded diaphragm opening)
Diaphragm	Fully automatic
Aperture range	<ul style="list-style-type: none"><li>• <b>18 mm focal length:</b> f/3.5–22</li><li>• <b>140 mm focal length:</b> f/5.6–38</li></ul> The minimum aperture displayed may vary depending on the size of the exposure increment selected with the camera.
Metering	Full aperture
Filter-attachment size	67 mm (P = 0.75 mm)
Dimensions	Approx. 78 mm maximum diameter × 97 mm (distance from camera lens mount flange)
Weight	Approx. 490 g (17.3 oz)

Nikon reserves the right to change the appearance and specifications of the hardware and software described in this manual at any time and without prior notice. Nikon will not be held liable for damages that may result from any mistakes that this manual may contain.

### ✔ Lens Care

- Keep the CPU contacts clean.
- Should the rubber lens-mount gasket be damaged, cease use immediately and take the lens to a Nikon-authorized service center for repair.
- Use a blower to remove dust and lint from the lens surfaces. To remove smudges and fingerprints, apply a small amount of ethanol or lens cleaner to a soft, clean cotton cloth or lens-cleaning tissue and clean from the center outwards using a circular motion, taking care not to leave smears or touch the glass with your fingers.
- Never use organic solvents such as paint thinner or benzene to clean the lens.
- The lens hood or Neutral Color (NC) filters can be used to protect the front lens element.
- Attach the front and rear caps before placing the lens in its case.
- When a lens hood is attached, do not pick up or hold the lens or camera using only the hood.
- If the lens will not be used for an extended period, store it in a cool, dry location to prevent mold and rust. Do not store in direct sunlight or with naphtha or camphor moth balls.
- Keep the lens dry. Rusting of the internal mechanism can cause irreparable damage.
- Leaving the lens in extremely hot locations could damage or warp parts made from reinforced plastic.

### A Note on Wide- and Super Wide-Angle Lenses

Autofocus may not provide the desired results in situations like those shown below.

#### 1 Objects in the background occupy more of the focus point than the main subject:

If the focus point contains both foreground and background objects, the camera may focus on the background and the subject may be out of focus, particularly with wide- and super wide-angle lenses.

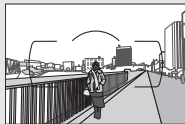

**Example:** *A far-off portrait subject at some distance from the background*

#### 2 The subject contains many fine details.

The camera may have difficulty focusing on subjects that contain many fine details.

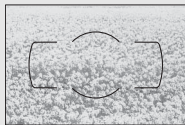

**Example:** *A field of flowers*

In these cases, use manual focus, or use focus lock to focus on another subject at the same distance and then recompose the photograph. For more information, see “Getting Good Results with Autofocus” (□ 86).



## Memory Card Capacity

The following table shows the approximate number of pictures that can be stored on a 16 GB SanDisk Extreme Pro 95 MB/s SDHC UHS-I card at different image quality and size settings.

Image quality	Image size	File size <sup>1</sup>	No. of images <sup>1</sup>	Buffer capacity <sup>2</sup>
NEF (RAW), Compressed, 14-bit	—	26.3 MB	428	11
NEF (RAW), Compressed, 12-bit	—	21.3 MB	511	17
JPEG fine	Large	13.4 MB	929	100
	Medium	8.0 MB	1500	100
	Small	4.1 MB	2900	100
JPEG normal	Large	6.8 MB	1800	100
	Medium	4.1 MB	3000	100
	Small	2.1 MB	5600	100
JPEG basic	Large	2.6 MB	3500	100
	Medium	1.9 MB	5700	100
	Small	1.2 MB	10,300	100

- 1 All figures are approximate. Results will vary with card type, camera settings, and scene recorded.
- 2 Maximum number of exposures that can be stored in memory buffer at ISO 100. Drops when long exposure noise reduction (☐ 230), auto distortion control (☐ 232), or **Date stamp** (☐ 243) is on.

## Battery Life

The movie footage or number of shots that can be recorded with fully-charged batteries varies with the condition of the battery, temperature, the interval between shots, and the length of time menus are displayed. Sample figures for EN-EL14a (1230 mAh) batteries are given below.

- **Photographs, single-frame release mode (CIPA standard <sup>1</sup>):**

Approximately 970 shots

- **Movies:** Approximately 70 minutes at 1080/60p <sup>2</sup>

- 1 Measured at 23°C/73.4°F ( $\pm 2^\circ\text{C}/3.6^\circ\text{F}$ ) with an AF-P DX NIKKOR 18–55mm f/3.5–5.6G VR lens under the following test conditions: lens cycled from infinity to minimum range and one photograph taken at default settings once every 30 s; after photograph is taken, monitor is turned on; tester waits for monitor to turn off; flash fired at full power once every other shot. Live view not used.
- 2 Measured at 23°C/73.4°F ( $\pm 2^\circ\text{C}/3.6^\circ\text{F}$ ) with the camera at default settings and an AF-P DX NIKKOR 18–55mm f/3.5–5.6G VR lens under conditions specified by the Camera and Imaging Products Association (CIPA). Individual movies can be up to 20 minutes in length or 4 GB in size; recording may end before these limits are reached if the camera temperature rises.

The following can reduce battery life:





























- Using the monitor
- Keeping the shutter-release button pressed halfway
- Repeated autofocus operations
- Taking NEF (RAW) photographs
- Slow shutter speeds
- Using camera Wi-Fi (wireless LAN) and Bluetooth features
- Using the camera with optional accessories connected
- Using VR (vibration reduction) mode with VR lenses
- Repeatedly zooming in and out with an AF-P lens.

























To ensure that you get the most from rechargeable Nikon EN-EL14a batteries:

- Keep the battery contacts clean. Soiled contacts can reduce battery performance.
- Use batteries immediately after charging. Batteries will lose their charge if left unused.

# Index

## Symbols

 (Auto mode) .....	4, 47
 (Auto (flash off) mode).....	4, 47
<b>SCENE</b> (Scene).....	4, 58
 (Portrait) .....	59
 (Landscape).....	59
 (Child).....	59
 (Sports).....	60
 (Close up).....	60
 (Night portrait).....	60
 (Night landscape).....	61
 (Party/indoor).....	61
 (Beach/snow).....	61
 (Sunset).....	62
 (Dusk/dawn) .....	62
 (Pet portrait) .....	62
 (Candlelight).....	63
 (Blossom).....	63
 (Autumn colors).....	63
 (Food) .....	64
<b>EFFECTS</b> (Special effects) .....	4, 65
 (Night vision) .....	65
<b>VI</b> (Super vivid) .....	66
<b>POP</b> (Pop) .....	66
 (Photo illustration).....	66, 70
 (Toy camera effect) .....	67, 71
 (Miniature effect) .....	67, 72
 (Selective color).....	67, 73
 (Silhouette).....	68
 (High key).....	68
 (Low key) .....	68
<b>P</b> (Programmed auto) .....	4, 118, 119
<b>S</b> (Shutter-priority auto) ....	4, 118, 121
<b>A</b> (Aperture-priority auto) .	4, 118, 122
<b>M</b> (Manual) .....	4, 118, 123
 (flexible program).....	120
 (Single frame) .....	75

 (Continuous L).....	75, 76
 (Continuous H).....	75, 76
 (Self-timer) .....	75, 79
 (Quiet shutter release) .....	75, 78
 (Single-point AF).....	87
 (Dynamic-area AF).....	87
 (Auto-area AF).....	88
 (3D-tracking) .....	88
 (Face-priority AF).....	89
 (Wide-area AF) .....	89
 (Normal-area AF) .....	89
 (Subject-tracking AF) .....	90
 (Matrix metering) .....	128
 (Center-weighted metering)...	128
 (Spot metering).....	128
<b>AUTO</b> (auto flash).....	102
 (red-eye reduction).....	102, 104
<b>SLOW</b> (slow sync).....	102, 104
<b>REAR</b> (rear-curtain sync) .....	104
 (Flash compensation).....	134
 (Exposure compensation) .....	132
<b>AE-BKT</b> (AE bracketing) .....	151
<b>WB-BKT</b> (WB bracketing) .....	151
<b>ADL-BKT</b> (ADL bracketing) .....	151
 (Help) .....	43
<b>WB</b> (White balance) .....	140
<b>PRE</b> (Preset manual).....	145
 (focus indicator).....	50, 93, 96
 (flash-ready indicator) ....	5, 54, 318
 (live view).....	47, 164
 (memory buffer) .....	77, 387
 button .....	12, 166, 187
 button .....	6, 115

## Numerics

2016-pixel RGB sensor	247, 307, 358, 360
3D color matrix metering .....	307

3D-tracking (AF-area mode).....88

## A

---

AC adapter .....321, 325

Access lamp.....51

Accessories ..... 321

Accessory terminal accessories... 324

Active D-Lighting ..... 136

Add items (My Menu) ..... 301

ADL bracketing (Auto bracketing set)  
151

Adobe RGB..... 230

AE bracketing (Auto bracketing set).  
151

AE lock..... 130

AE-L ..... 130

**AE-L/AF-L** button..... 94, 130, 254

AF .....82–94, 235

AF area brackets ..... 41, 49

AF-A.....82

AF-area mode .....87

AF-assist illuminator..... 85, 237, 310

AF-C..... 82, 235

AF-F .....83

AF-S .....82, 83

Airplane mode.....271

A-M mode switch ..... 95, 380

Angle of view ..... 314

Aperture ..... 118, 122, 124

Aperture-priority auto ..... 122

Assign AE-L/AF-L button ..... 254

Assign Fn button ..... 252

Assign touch Fn ..... 255

Auto (White balance) ..... 140

Auto bracketing..... 151, 251

Auto distortion control ..... 232

Auto flash..... 102

Auto image rotation..... 222

Auto info display ..... 265

Auto ISO sensitivity control ..... 228

Auto off timers ..... 240

Auto-area AF (AF-area mode) ..... 88

Autoexposure lock ..... 130

Autofocus ..... 82–94, 235

Auto-servo AF ..... 82

Available settings ..... 338

## B

---

Battery ..... 26, 27, 321, 364

Beep options ..... 263

Black-and-white ..... 290

Bluetooth..... xxii, 273

Body cap ..... 1, 323

Border (PictBridge)..... 215

Bracketing ..... 151, 251

Built-in AF-assist illuminator. 85, 237,  
310

Built-in flash ..... 101, 312

Bulb ..... 125, 126

Burst..... 76

## C

---

Calendar playback..... 186

Camera Control Pro 2 ..... 323

Capture NX-D ..... 210

CEC ..... 219

Center-weighted metering ..... 128

Charger..... 26, 321, 364

Choose start/end point ..... 178

Clean image sensor ..... 328

Clock..... 40, 262

Clock battery ..... 27

Cloudy (White balance) ..... 140

CLS ..... 315

Color outline..... 293

Color sketch ..... 294

Color space ..... 230

Color temperature..... 142

Commander mode..... 247

Compatible lenses..... 305

Conformity marking ..... 276, 367

Connect to smart device ..... 271

Continuous (Release mode).....	75, 76	Exposure mode .....	118
Continuous-servo AF .....	82, 235	Exposure smoothing .....	111, 173
Copyright .....	193, 261	External microphone.....	170, 323
CPU contacts.....	307	Eye sensor .....	8, 265
CPU lens.....	305	Eye-Fi upload .....	274
Creative Lighting System .....	315	<b>F</b>	
Cropping (PictBridge).....	215	Face-priority AF .....	89
Cross screen (Filter effects).....	289	Face zoom .....	199
Custom Settings .....	233	File information.....	189
Cyanotype .....	290	File naming.....	227
<b>D</b>		File number sequence .....	242
Date and time.....	262	Filter effects .....	158, 160, 289
Date counter .....	243, 244	Filters.....	321
Date format .....	40, 262	Fine-tuning white balance .....	143
Date stamp .....	243	Firmware version .....	276
Daylight saving time.....	40, 262	Fisheye.....	288
DCF version 2.0 .....	365	Flash .....	54, 101, 315
Delete .....	205	Flash (White balance).....	140
Delete all images.....	206	Flash cntrl for built-in flash .....	246
Delete current image.....	205	Flash compensation .....	134
Delete selected images.....	206	Flash control.....	247
Device control (HDMI).....	219	Flash mode .....	102, 104
Diopter adjustment control ..	41, 322	Flash range.....	106
Direct sunlight (White balance)..	140	Flash ready indicator .....	5, 54, 318
Distortion control.....	232, 287	Flash sync speed .....	106, 357
D-Lighting.....	285	Flat (Set Picture Control).....	155
Dynamic-area AF .....	87	Flexible program .....	120
<b>E</b>		Flicker reduction .....	167, 268
Edit movie.....	178, 182	Fluorescent (White balance)140,	141
Electronic rangefinder.....	96, 237	<b>Fn</b> button.....	252
EV steps for exposure cntrl .....	239	f-number.....	122
Exif version 2.3 .....	365	Focal length.....	314
Exposure.....	128, 130, 132	Focal length scale.....	369, 375, 380
Exposure bracketing .....	151	Focal plane mark.....	96
Exposure compensation.....	132	Focus.....	82–97
Exposure delay mode.....	241	Focus indicator .....	50, 93, 96
Exposure indicator.....	11, 124	Focus lock.....	93
Exposure lock .....	130	Focus mode .....	82
Exposure meters.....	53	Focus point .....	50, 87, 90, 93, 96, 236
		Focusing screen .....	357

Focus-mode switch .....	31, 95
Format memory card .....	259
Frame interval (Slide show) .....	209
Frame size/frame rate .....	168
Framing grid .....	9, 243
Front-curtain sync .....	104
Full-frame playback .....	184
Full-time-servo AF .....	83

## G

GPS device .....	269
------------------	-----

## H

H.264 .....	361
HDMI .....	218, 365
HDMI-CEC .....	219
HDR (high dynamic range) .....	138
Help .....	43
High definition .....	218, 365
High Dynamic Range (HDR) .....	138
High ISO NR .....	231
High-angle shots .....	13
Highlights .....	189, 221
Histogram .....	190, 221

## I

Image comment .....	260
Image Dust Off ref photo .....	266
Image overlay .....	291
Image quality .....	98
Image review .....	221
Image size .....	100
Incandescent (White balance) .....	140
Info display auto off .....	8, 265
Info display format .....	264
In-focus indicator .....	50, 93, 96
Information display .....	6, 264
Interval timer shooting .....	109
ISO display .....	239
ISO sensitivity .....	107, 228
i-TTL .....	246, 247

i-TTL balanced fill-flash for digital SLR .....	247, 315
---	----------

## J

JPEG .....	98
JPEG basic .....	98
JPEG fine .....	98
JPEG normal .....	98

## L

Landscape (Set Picture Control) ..	155
Language .....	262
Large (Image size) .....	100
Lens .....	30, 305, 369
Lens focus ring .....	95, 369, 375, 380
Lens mount .....	1, 30, 96
Lens vibration reduction switch ..	32, 382
Live view .....	47, 164
Location data .....	195, 269
Lock mirror up for cleaning .....	330
Long exposure NR .....	230
Low-angle shots .....	13

## M

Manage Picture Control .....	161
Manual .....	95, 123
Manual focus .....	83, 95
Manual focus ring in AF mode .....	238
Manual movie settings .....	169
Matrix metering .....	128
Maximum sensitivity .....	228
Medium (Image size) .....	100
Memory buffer .....	77
Memory card .....	27, 259, 324, 387
Memory card capacity .....	387
Metering .....	128
Microphone .....	169
Miniature effect .....	72, 295
Minimum shutter speed .....	228
Mired .....	144

Mirror.....	1, 330
Mode dial .....	4
Monitor.....	13, 184, 263
Monitor brightness.....	263
Monochrome.....	290
Monochrome (Set Picture Control) ...	155
Mounting mark.....	30, 369, 375, 380
Movie quality.....	168
Movie settings.....	168
Movie-record button .....	165
Movies.....	164
My Menu .....	301
<b>N</b>	
<hr/>	
NEF (RAW).....	98, 227, 280
NEF (RAW) processing.....	280
NEF (RAW) recording .....	227
Neutral (Set Picture Control).....	155
Nikon Transfer 2 .....	212
No. of copies (PictBridge).....	215
Non-CPU lens.....	308
Normal-area AF.....	89
Number of exposures remaining ..	46
Number of focus points.....	236
Number of shots.....	388
<b>O</b>	
<hr/>	
Optical VR .....	232
Optional flash .....	315
Output resolution (HDMI) .....	219
Overview data .....	194
<b>P</b>	
<hr/>	
Page size (PictBridge) .....	215
Painting .....	298
Perspective control .....	288
Photo Illustration .....	70, 294
Photo information .....	188, 221
PictBridge.....	214, 365
Picture Controls.....	155, 157
Playback.....	184
Playback display options .....	221
Playback folder .....	221
Playback information .....	188, 221
Playback menu .....	220
Playback zoom .....	196
Portrait (Set Picture Control) .....	155
Power connector .....	321, 325
Preset manual (White balance) ..	140, 145
Press the shutter-release button all the way down .....	51, 52
Press the shutter-release button halfway .....	50, 52
Print date (PictBridge).....	215
Print select .....	216
Printing.....	214
Programmed auto.....	119
Protecting photographs .....	200
<b>Q</b>	
<hr/>	
Quick retouch .....	286
Quiet shutter release.....	75, 78
<b>R</b>	
<hr/>	
Rangefinder .....	237
Rank items (My Menu) .....	304
Rating.....	201, 209
Rear-curtain sync .....	104
Recent settings.....	300
Red-eye correction.....	286
Red-eye reduction.....	102, 104
Release mode.....	75
Remote control.....	270, 323
Remote cord.....	125, 324
Remote shutter release .....	270
Remove items (My Menu).....	303
Reset.....	115, 225, 235
Reset custom settings.....	235
Reset shooting menu.....	225
Resize .....	283



Retouch menu..... 277  
Retractable lens barrel button.31, 32  
Reverse dial rotation ..... 256  
Reverse indicators..... 245  
RGB..... 190, 230  
RGB histogram ..... 190  
Rotate tall..... 222

## S

---

Save selected frame ..... 182  
Scene auto selector .....52  
Scene mode .....58  
Select to send to smart device .... 204  
Select to send to smart device/  
deselect..... 203  
Selective color ..... 73, 296  
Self-portrait ..... 13  
Self-timer..... 75, 79, 241  
Send to smart device (auto) ..... 272  
Sensitivity..... 107, 228  
Sepia ..... 290  
Set Picture Control..... 157  
Setup menu..... 257  
Shade (White balance) ..... 140  
Shooting data..... 192  
Shooting menu ..... 223  
Shutter speed ..... 118, 121, 123  
Shutter-priority auto ..... 121  
Shutter-release button..... 51, 52, 93,  
130, 239  
Shutter-release button AE-L..... 239  
Side-by-side comparison..... 298  
Single frame (Release mode) .....75  
Single-point AF (AF-area mode) ....87  
Single-servo AF ..... 82, 83  
Size ..... 100, 168, 282  
Skylight (Filter effects)..... 289  
Slide show..... 208  
Slot empty release lock ..... 268  
Slow sync..... 102, 104  
Small (Image size) ..... 100

SnapBridge..... i, 33  
Soft (Filter effects) ..... 289  
Special effects mode ..... 65  
Speedlight..... 315  
Spot metering ..... 128  
sRGB..... 230  
Standard (Set Picture Control) ..... 155  
Standard i-TTL fill-flash for digital  
SLR..... 247, 315  
Standby timer .....53, 240  
Start printing (PictBridge).... 216, 217  
Storage folder ..... 225  
Straighten..... 287  
Subject-tracking AF ..... 90  
Sync with smart device..... 262

## T

---

Television..... 218  
Thumbnail playback..... 185  
Time..... 125, 127  
Time zone ..... 40, 262  
Time zone and date ..... 40, 262  
Time-lapse movie ..... 171  
Timer ..... 79, 109  
Toning..... 158, 160  
Touch controls..... 15, 160, 263  
Touch screen ..... 15  
Touch shutter..... 19  
Trim..... 198, 282  
Trimming movies..... 178  
Type D lens..... 307  
Type E lens ..... 307  
Type G lens..... 307

## U

---

USB cable..... 211, 214, 324

## V

---

Vari-angle monitor ..... 13  
Vibration reduction32, 232, 372, 377,  
382

Viewfinder .....	5, 41, 357
Viewfinder eyepiece cap .....	80
Viewfinder grid display .....	243
ViewNX-i .....	210
Vignette control .....	231
Vivid (Set Picture Control) .....	155
Volume .....	177, 208

## **W**

---

Warm filter (Filter effects) .....	289
WB .....	140
WB bracketing (Auto bracketing set)	151
White balance .....	140
Wide-area AF .....	89
Wi-Fi .....	xxii, 272
Wind noise reduction .....	169
Wireless .....	xxii
Wireless remote controller ..	270, 324



No reproduction in any form of this manual, in whole or in part (except for brief quotation in critical articles or reviews), may be made without written authorization from NIKON CORPORATION.

**NIKON CORPORATION**

---

© 2016 Nikon Corporation



SB8L04(11)  
6MB36711-04