

Nikon

DIGITAL CAMERA

D4s

User's Manual



Nikon Manual Viewer 2

Use the Nikon Manual Viewer 2 app to view manuals anytime, anywhere on your smartphone or tablet.

En

To get the most from your camera, please be sure to read all instructions thoroughly and keep them where they will be read by all those who use the product.

Symbols and Conventions

To make it easier to find the information you need, the following symbols and conventions are used:



This icon marks cautions; information that should be read before use to prevent damage to the camera.



This icon marks notes; information that should be read before using the camera.



This icon marks references to other pages in this manual.

Menu items, options, and messages displayed in the camera monitor are shown in **bold**.

Camera Settings

The explanations in this manual assume that default settings are used.

Nikon Manual Viewer 2



Install the Nikon Manual Viewer 2 app on your smartphone or tablet to view Nikon digital camera manuals, anytime, anywhere. Nikon Manual Viewer 2 can be downloaded free of charge from the App Store and Google Play. Download of the app and any product manuals requires an Internet connection, for which fees may be levied by your phone or Internet service provider.



For Your Safety

Before using the camera for the first time, read the safety instructions in “For Your Safety” (📖 xii–xv).

Package Contents

Be sure all items listed here were included with your camera.



- D4S digital camera (☞ 1)



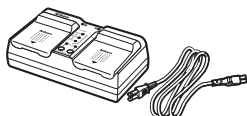
- BF-1B body cap (☞ 27, 411)



- BS-2 accessory shoe cover (☞ 16, 195)



- EN-EL18a rechargeable Li-ion battery with terminal cover (☞ 21, 24)



- MH-26a battery charger with power cable and two contact protectors (shape of power cable depends on country of sale; ☞ 21, 459)



- USB cable clip (☞ 273)



- HDMI cable clip (☞ 287)



- UF-2 connector cover for stereo mini plug cable (☞ 413)

- UC-E15 USB cable (☞ 272, 280)
- ViewNX 2 installer CD (☞ 269)
- *User's Manual* (this guide)

- AN-DC11 strap (☞ 21)
- Warranty
- *Network Guide*

Memory cards are sold separately. Cameras purchased in Japan display menus and messages in English and Japanese only; other languages are not supported. We apologize for any inconvenience this may cause.

Table of Contents

For Your Safety	xii
Notices.....	xvi

Introduction **1**

Getting to Know the Camera.....	1
Camera Body	1
The Top Control Panel	6
The Rear Control Panel	8
The Viewfinder Display.....	10
The Information Display.....	12
The BS-2 Accessory Shoe Cover	16

Tutorial **17**

Camera Menus.....	17
Using Camera Menus	18
Help	20
First Steps	21
Attach the Camera Strap.....	21
Charge the Battery	21
Insert the Battery	24
Attach a Lens.....	27
Basic Setup.....	29
Insert a Memory Card.....	32
Format the Memory Card	35
Adjust Viewfinder Focus	38
Basic Photography and Playback.....	40
Turn the Camera On	40
Ready the Camera	42
Focus and Shoot	43
Viewing Photographs	46
Deleting Unwanted Photographs	47

Focusing in Live View Photography and Movie Live View	52
The Live View Display: Live View Photography	55
The Information Display: Live View Photography.....	58
Manual Focus	59
Live View Shutter Release Options	60

Movie Live View

Indices	66
The Live View Display: Movie Live View	67
The Information Display: Movie Live View.....	69
Image Area	70
Taking Photos During Movie Live View	71
Movie Settings	74
Viewing Movies	77
Editing Movies	79
Trimming Movies	79
Saving Selected Frames.....	82

Image Recording Options

Image Area	85
Image Quality.....	90
Image Size	94
Using Two Memory Cards	96

Focus **97**

Autofocus	97
Autofocus Mode	97
AF-Area Mode	100
Focus Point Selection	103
Focus Lock.....	105
Manual Focus	108

Release Mode **111**

Choosing a Release Mode	111
Continuous Release Modes	112
Self-Timer Mode.....	114
Mirror up Mode	116

ISO Sensitivity **117**

Manual Adjustment	117
Auto ISO Sensitivity Control	119

Exposure **123**

Metering	123
Exposure Mode.....	125
<i>P</i> : Programmed Auto	127
<i>S</i> : Shutter-Priority Auto	128
<i>A</i> : Aperture-Priority Auto	129
<i>M</i> : Manual	130
Long Time-Exposures (<i>M</i> Mode Only).....	132
Shutter-Speed and Aperture Lock.....	134
Autoexposure (AE) Lock.....	136
Exposure Compensation.....	138
Bracketing	140

White Balance **155**

White Balance Options	155
Fine-Tuning White Balance	158
Choosing a Color Temperature	161
Preset Manual	164
Viewfinder Photography	165
Live View (Spot White Balance)	169
Managing Presets	172

Image Enhancement **177**

Picture Controls.....	177
Selecting a Picture Control	177
Modifying Picture Controls	179
Creating Custom Picture Controls	183
Sharing Custom Picture Controls.....	186
Preserving Detail in Highlights and Shadows.....	188
Active D-Lighting	188
High Dynamic Range (HDR)	190

Flash Photography **195**

Using a Flash	195
The Nikon Creative Lighting System (CLS)	196
i-TTL Flash Control	202
Flash Modes.....	203
Flash Compensation.....	206
FV Lock	208

Other Shooting Options **211**

Two-Button Reset: Restoring Default Settings	211
Multiple Exposure	214
Interval Timer Photography.....	221
Time-Lapse Photography	229
Non-CPU Lenses.....	235
Location Data.....	238

More About Playback **241**

Viewing Images	241
Full-Frame Playback	241
Thumbnail Playback	241
Playback Controls	242
Photo Information.....	244
Taking a Closer Look: Playback Zoom.....	253
Protecting Photographs from Deletion.....	255
Deleting Photographs	257
Full-Frame and Thumbnail Playback.....	257
The Playback Menu.....	259

Voice Memos **261**

Recording Voice Memos	261
Playing Voice Memos	266

Connections **269**


Installing ViewNX 2	269
Using ViewNX 2	272
Copy Pictures to the Computer.....	272
View Pictures.....	275
Ethernet and Wireless Networks.....	276

Printing Photographs.....	279
Connecting the Printer	280
Printing Pictures One at a Time	280
Printing Multiple Pictures	282
Creating a DPOF Print Order: Print Set.....	283
Viewing Photographs on TV	285
HDMI Options.....	286





Menu Guide

289

▶ The Playback Menu: Managing Images	289
Playback Folder	290
Hide Image.....	290
Playback Display Options	291
Copy Image(s).....	292
Image Review.....	295
After Delete	296
Rotate Tall	296
Slide Show.....	297
📷 The Shooting Menu: Shooting Options	299
Shooting Menu Bank.....	300
Extended Menu Banks	301
Storage Folder	302
File Naming.....	304
JPEG/TIFF Recording	304
NEF (RAW) Recording.....	304
Color Space.....	305
Vignette Control	306
Auto Distortion Control	307
Long Exposure NR	
(Long Exposure Noise Reduction)	308
High ISO NR	308

 Custom Settings: Fine-Tuning Camera Settings.....	309
Custom Settings Bank	311
a: Autofocus.....	313
a1: AF-C Priority Selection.....	313
a2: AF-S Priority Selection	314
a3: Focus Tracking with Lock-On	314
a4: AF Activation	315
a5: Focus Point Illumination.....	315
a6: Focus Point Wrap-Around	316
a7: Number of Focus Points	316
a8: Assign AF-ON Button	317
a9: Assign AF-ON Button (Vert.).....	318
a10: Store by Orientation	319
a11: Limit AF-Area Mode Selection	320
a12: Autofocus Mode Restrictions	320
b: Metering/Exposure	321
b1: ISO Sensitivity Step Value	321
b2: EV Steps for Exposure Cntrl.....	321
b3: Exp./Flash Comp. Step Value.....	321
b4: Easy Exposure Compensation.....	322
b5: Matrix Metering.....	323
b6: Center-Weighted Area.....	323
b7: Fine-Tune Optimal Exposure.....	323
c: Timers/AE Lock.....	324
c1: Shutter-Release Button AE-L.....	324
c2: Standby Timer	324
c3: Self-Timer	325
c4: Monitor off Delay	325
d: Shooting/Display	326
d1: Beep.....	326
d2: Continuous Shooting Speed	326
d3: Max. Continuous Release.....	327
d4: Exposure Delay Mode	327
d5: File Number Sequence	328
d6: Viewfinder Grid Display.....	329
d7: Control Panel/Viewfinder	329
d8: Screen Tips	329
d9: Information Display	330
d10: LCD Illumination.....	330

e: Bracketing/Flash	331
e1: Flash Sync Speed	331
e2: Flash Shutter Speed.....	332
e3: Optional Flash.....	332
e4: Exposure Comp. for Flash.....	333
e5: Modeling Flash.....	333
e6: Auto Bracketing Set.....	333
e7: Auto Bracketing (Mode M)	334
e8: Bracketing Order.....	334
f: Controls.....	335
f1: Multi Selector Center Button.....	335
f2: Multi Selector	336
f3: Assign Fn Button.....	337
f4: Assign Preview Button.....	342
f5: Assign Sub-selector	342
f6: Assign Sub-selector Center.....	342
f7: Assign Fn Button (Vert.)	343
f8: Shutter Spd & Aperture Lock.....	343
f9: Assign BKT Button	344
f10: Customize Command Dials	345
f11: Release Button to Use Dial.....	347
f12: Slot Empty Release Lock.....	347
f13: Reverse Indicators.....	347
f14: Assign Multi Selector (Vert.)	348
f15: Playback Zoom	348
f16: Assign Movie Record Button.....	349
f17: Live View Button Options	349
f18: Assign Remote (WR) Fn Button.....	350
f19: Lens Focus Function Buttons	351
g: Movie	353
g1: Assign Fn Button	353
g2: Assign Preview Button	355
g3: Assign Sub-selector Center	356
g4: Assign Shutter Button	357

 The Setup Menu: Camera Setup.....	358
Format Memory Card	359
Monitor Brightness	359
Monitor Color Balance	360
Image Dust Off Ref Photo	361
Flicker Reduction.....	363
Time Zone and Date	363
Language	364
Auto Image Rotation	364
Battery Info.....	365
Image Comment	366
Copyright Information	367
IPTC	368
Save/Load Settings.....	370
Virtual Horizon	372
AF Fine-Tune.....	373
Firmware Version	374
 The Retouch Menu: Creating Retouched Copies	375
D-Lighting.....	379
Red-Eye Correction.....	380
Trim	381
Monochrome	382
Filter Effects.....	382
Color Balance.....	383
Image Overlay	384
NEF (RAW) Processing	387
Resize.....	389
Straighten	391
Distortion Control.....	392
Perspective Control.....	393
Side-by-Side Comparison	394
 My Menu/  Recent Settings.....	396

Compatible Lenses	401
Other Accessories	408
Attaching a Power Connector and AC Adapter	414
Caring for the Camera.....	416
Storage.....	416
Cleaning	416
The Low-Pass Filter	417
“Clean Now”	417
“Clean at Startup/Shutdown”	418
Manual Cleaning.....	420
Replacing the Clock Battery	424
Caring for the Camera and Battery: Cautions.....	426
Defaults	430
Exposure Program.....	438
Troubleshooting	439
Battery/Display	439
Shooting.....	439
Playback	442
Miscellaneous.....	443
Error Messages	444
Specifications	450
Calibrating Batteries	459
Approved Memory Cards	462
Memory Card Capacity	464
Battery Life	467
Index.....	469

For Your Safety

To prevent damage to your Nikon product or injury to yourself or to others, read the following safety precautions in their entirety before using this equipment. Keep these safety instructions where all those who use the product will read them.

The consequences that could result from failure to observe the precautions listed in this section are indicated by the following symbol:



This icon marks warnings. To prevent possible injury, read all warnings before using this Nikon product.

■ ■ WARNINGS



Keep the sun out of the frame

Keep the sun well out of the frame when shooting backlit subjects. Sunlight focused into the camera when the sun is in or close to the frame could cause a fire.



Do not look at the sun through the viewfinder

Viewing the sun or other strong light source through the viewfinder could cause permanent visual impairment.



Using the viewfinder diopter adjustment control

When operating the viewfinder diopter adjustment control with your eye to the viewfinder, care should be taken not to put your finger in your eye accidentally.



Turn off immediately in the event of malfunction

Should you notice smoke or an unusual smell coming from the equipment or AC adapter (available separately), unplug the AC adapter and remove the battery immediately, taking care to avoid burns. Continued operation could result in injury. After removing the battery, take the equipment to a Nikon-authorized service center for inspection.



Do not disassemble

Touching the product's internal parts could result in injury. In the event of malfunction, the product should be repaired only by a qualified technician. Should the product break open as the result of a fall or other accident, remove the battery and/or AC adapter and then take the product to a Nikon-authorized service center for inspection.

⚠ Do not use in the presence of flammable gas

Do not use electronic equipment in the presence of flammable gas, as this could result in explosion or fire.

⚠ Keep out of reach of children

Failure to observe this precaution could result in injury. In addition, note that small parts constitute a choking hazard. Should a child swallow any part of this equipment, consult a physician immediately.

⚠ Do not place the strap around the neck of an infant or child

Placing the camera strap around the neck of an infant or child could result in strangulation.

⚠ Do not remain in contact with the camera, battery, or charger for extended periods while the devices are on or in use

Parts of the device become hot. Leaving the device in direct contact with the skin for extended periods may result in low-temperature burns.

⚠ Do not leave the product where it will be exposed to extremely high temperatures, such as in an enclosed automobile or in direct sunlight

Failure to observe this precaution could cause damage or fire.

⚠ Observe proper precautions when handling batteries

Batteries may leak or explode if improperly handled. Observe the following precautions when handling batteries for use in this product:

- Use only batteries approved for use in this equipment.
- Use only CR1616 lithium batteries to replace the clock battery. Using another type of battery could cause an explosion. Dispose of used batteries as directed.
- Do not short or disassemble the battery.
- Be sure the product is off before replacing the battery. If you are using an AC adapter, be sure it is unplugged.
- Do not attempt to insert the battery upside down or backwards.
- Do not expose the battery to flame or to excessive heat.
- Do not immerse in or expose to water.
- Replace the terminal cover when transporting the battery. Do not transport or store the battery with metal objects such as necklaces or hairpins.
- Batteries are prone to leakage when fully discharged. To avoid damage to the product, be sure to remove the battery when no charge remains.
- When the battery is not in use, attach the terminal cover and store in a cool, dry place.

- The battery may be hot immediately after use or when the product has been used on battery power for an extended period. Before removing the battery turn the camera off and allow the battery to cool.
- Discontinue use immediately should you notice any changes in the battery, such as discoloration or deformation.

⚠ Observe proper precautions when handling the charger

- Keep dry. Failure to observe this precaution could result in injury or product malfunction due to fire or electric shock.
- Dust on or near the metal parts of the plug should be removed with a dry cloth. Continued use could result in fire.
- Do not handle the power cable or go near the charger during thunderstorms. Failure to observe this precaution could result in electric shock.
- Do not damage, modify, or forcibly tug or bend the power cable. Do not place it under heavy objects or expose it to heat or flame. Should the insulation be damaged and the wires become exposed, take the power cable to a Nikon-authorized service representative for inspection. Failure to observe this precaution could result in fire or electric shock.

- Do not handle the plug or charger with wet hands. Failure to observe this precaution could result in injury or product malfunction due to fire or electric shock.
- Do not use with travel converters or adapters designed to convert from one voltage to another or with DC-to-AC inverters. Failure to observe this precaution could damage the product or cause overheating or fire.

⚠ Use appropriate cables

When connecting cables to the input and output jacks, use only the cables provided or sold by Nikon for the purpose to maintain compliance with product regulations.

⚠ CD-ROMs

CD-ROMs containing software or manuals should not be played back on audio CD equipment. Playing CD-ROMs on an audio CD player could cause hearing loss or damage the equipment.

⚠ Do not aim a flash at the operator of a motor vehicle

Failure to observe this precaution could result in accidents.

⚠ Observe caution when using the flash

- Using optional flash units in close contact with the skin or other objects could cause burns.
- Using optional flash units close to the subject's eyes could cause temporary visual impairment. The flash should be no less than one meter (3 ft 4 in.) from the subject. Particular care should be observed when photographing infants.

⚠ Avoid contact with liquid crystal

Should the monitor break, care should be taken to avoid injury due to broken glass and to prevent the liquid crystal from the monitor touching the skin or entering the eyes or mouth.

⚠ Do not carry tripods with a lens or camera attached

You could trip or accidentally strike others, resulting in injury.

⚠ Follow the instructions of airline and hospital personnel

This camera transmits radio frequencies that could interfere with medical equipment or aircraft navigation. Disable the wireless network feature and remove all wireless accessories from the camera before boarding an aircraft, and turn the camera off during take off and landing. In medical facilities, follow staff instructions regarding the use of wireless devices.

Notices

- No part of the manuals included with this product may be reproduced, transmitted, transcribed, stored in a retrieval system, or translated into any language in any form, by any means, without Nikon's prior written permission.
- Nikon reserves the right to change the specifications of the hardware and software described in these manuals at any time and without prior notice.
- Nikon will not be held liable for any damages resulting from the use of this product.
- While every effort has been made to ensure that the information in these manuals is accurate and complete, we would appreciate it were you to bring any errors or omissions to the attention of the Nikon representative in your area (address provided separately).

Notices for Customers in Canada

CAN ICES-3 B / NMB-3 B

Notices for Customers in Europe

CAUTION

RISK OF EXPLOSION IF BATTERY IS REPLACED BY AN INCORRECT TYPE. DISPOSE OF USED BATTERIES ACCORDING TO THE INSTRUCTIONS.

This symbol indicates that electrical and electronic equipment is to be collected separately.



The following apply only to users in European countries:

- This product is designated for separate collection at an appropriate collection point. Do not dispose of as household waste.
- Separate collection and recycling helps conserve natural resources and prevent negative consequences for human health and the environment that might result from incorrect disposal.
- For more information, contact the retailer or the local authorities in charge of waste management.

This symbol on the battery indicates that the battery is to be collected separately.



The following apply only to users in European countries:

- All batteries, whether marked with this symbol or not, are designated for separate collection at an appropriate collection point. Do not dispose of as household waste.
- For more information, contact the retailer or the local authorities in charge of waste management.

The Battery Charger

IMPORTANT SAFETY INSTRUCTIONS—SAVE THESE INSTRUCTIONS

DANGER—TO REDUCE THE RISK OF FIRE OR ELECTRIC SHOCK, CAREFULLY FOLLOW THESE INSTRUCTIONS

For connection to a supply not in the U.S.A., use an attachment plug adapter of the proper configuration for the power outlet if needed. This power unit is intended to be correctly oriented in a vertical or floor mount position.

Federal Communications Commission (FCC) Radio Frequency Interference Statement

This equipment has been tested and found to comply with the limits for a Class B digital device, pursuant to Part 15 of the FCC rules. These limits are designed to provide reasonable protection against harmful interference in a residential installation. This equipment generates, uses, and can radiate radio frequency energy and, if not installed and used in accordance with the instructions, may cause harmful interference to radio communications. However, there is no guarantee that interference will not occur in a particular installation. If this equipment does cause harmful interference to radio or television reception, which can be determined by turning the equipment off and on, the user is encouraged to try to correct the interference by one or more of the following measures:

- Reorient or relocate the receiving antenna.
- Increase the separation between the equipment and receiver.
- Connect the equipment into an outlet on a circuit different from that to which the receiver is connected.
- Consult the dealer or an experienced radio/television technician for help.



Nikon
D4S

CAUTIONS

Modifications

The FCC requires the user be notified that any changes or modifications made to this device that are not expressly approved by Nikon Corporation may void the user's authority to operate the equipment.

The accessory power cord must be used

For USA only: Over AC 125 V

Use a power cord over AWG 18 in size suited to the voltage in use with plugs rated for AC 250 V 15 A (NEMA 6P-15) and a minimum of SVT type cord for insulation.

Power Supply Cord

Use a UL Listed, 1.8 to 3 m (6 to 10 ft), SPT-2, AWG no. 18 power supply cord rated for 125 V 7 A, with a non-polarized NEMA 1-15P plug rated for 125 V 15 A.

Notice for Customers in the State of California

WARNING: Handling the cord on this product may expose you to lead, a chemical known to the State of California to cause birth defects or other reproductive harm. *Wash hands after handling.*

Nikon Inc., 1300 Walt Whitman Road,
Melville, New York 11747-3064, U.S.A.
Tel.: 631-547-4200

Disposing of Data Storage Devices

Please note that deleting images or formatting memory cards or other data storage devices does not completely erase the original image data. Deleted files can sometimes be recovered from discarded storage devices using commercially available software, potentially resulting in the malicious use of personal image data. Ensuring the privacy of such data is the user's responsibility.

Before discarding a data storage device or transferring ownership to another person, erase all data using commercial deletion software, or format the device and then completely refill it with images containing no private information (for example, pictures of empty sky). Be sure to also replace any pictures selected for preset manual (□ 172). Care should be taken to avoid injury when physically destroying data storage devices.

Before discarding the camera or transferring ownership to another person, you should also use the **Network > Network settings** option in the camera setup menu to delete any personal network information. For more information on deleting network profiles, see the supplied network guide.

AVC Patent Portfolio License

THIS PRODUCT IS LICENSED UNDER THE AVC PATENT PORTFOLIO LICENSE FOR THE PERSONAL AND NON-COMMERCIAL USE OF A CONSUMER TO (i) ENCODE VIDEO IN COMPLIANCE WITH THE AVC STANDARD ("AVC VIDEO") AND/OR (ii) DECODE AVC VIDEO THAT WAS ENCODED BY A CONSUMER ENGAGED IN A PERSONAL AND NON-COMMERCIAL ACTIVITY AND/OR WAS OBTAINED FROM A VIDEO PROVIDER LICENSED TO PROVIDE AVC VIDEO. NO LICENSE IS GRANTED OR SHALL BE IMPLIED FOR ANY OTHER USE. ADDITIONAL INFORMATION MAY BE OBTAINED FROM MPEG LA, L.L.C. SEE <http://www.mpegla.com>

Notice Concerning Prohibition of Copying or Reproduction

Note that simply being in possession of material that has been digitally copied or reproduced by means of a scanner, digital camera, or other device may be punishable by law.

• Items prohibited by law from being copied or reproduced

Do not copy or reproduce paper money, coins, securities, government bonds, or local government bonds, even if such copies or reproductions are stamped "Sample."

The copying or reproduction of paper money, coins, or securities which are circulated in a foreign country is prohibited.

Unless the prior permission of the government has been obtained, the copying or reproduction of unused postage stamps or post cards issued by the government is prohibited.

The copying or reproduction of stamps issued by the government and of certified documents stipulated by law is prohibited.

• Cautions on certain copies and reproductions

The government has issued cautions on copies or reproductions of securities issued by private companies (shares, bills, checks, gift certificates, etc.), commuter passes, or coupon tickets, except when a minimum of necessary copies are to be provided for business use by a company. Also, do not copy or reproduce passports issued by the government, licenses issued by public agencies and private groups, ID cards, and tickets, such as passes and meal coupons.

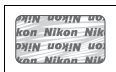
• Comply with copyright notices

The copying or reproduction of copyrighted creative works such as books, music, paintings, woodcuts, prints, maps, drawings, movies, and photographs is governed by national and international copyright laws. Do not use this product for the purpose of making illegal copies or to infringe copyright laws.

Use Only Nikon Brand Electronic Accessories

Nikon cameras are designed to the highest standards and include complex electronic circuitry. Only Nikon brand electronic accessories (including chargers, batteries, AC adapters, and flash accessories) certified by Nikon specifically for use with this Nikon digital camera are engineered and proven to operate within the operational and safety requirements of this electronic circuitry.

The use of non-Nikon electronic accessories could damage the camera and may void your Nikon warranty. The use of third-party rechargeable Li-ion batteries not bearing the Nikon holographic seal shown at right could interfere with normal operation of the camera or result in the batteries overheating, igniting, rupturing, or leaking.



For more information about Nikon brand accessories, contact a local authorized Nikon dealer.

Use Only Nikon Brand Accessories

Only Nikon brand accessories certified by Nikon specifically for use with your Nikon digital camera are engineered and proven to operate within its operational and safety requirements. THE USE OF NON-NIKON ACCESSORIES COULD DAMAGE YOUR CAMERA AND MAY VOID YOUR NIKON WARRANTY.

Servicing the Camera and Accessories

The camera is a precision device and requires regular servicing. Nikon recommends that the camera be inspected by the original retailer or a Nikon-authorized service representative once every one to two years, and that it be serviced once every three to five years (note that fees apply to these services). Frequent inspection and servicing are particularly recommended if the camera is used professionally. Any accessories regularly used with the camera, such as lenses or optional flash units, should be included when the camera is inspected or serviced.

Before Taking Important Pictures

Before taking pictures on important occasions (such as at weddings or before taking the camera on a trip), take a test shot to ensure that the camera is functioning normally. Nikon will not be held liable for damages or lost profits that may result from product malfunction.

Life-Long Learning

As part of Nikon's "Life-Long Learning" commitment to ongoing product support and education, continually-updated information is available on-line at the following sites:

- **For users in the U.S.A.:** <http://www.nikonusa.com/>
 - **For users in Europe and Africa:** <http://www.europe-nikon.com/support/>
 - **For users in Asia, Oceania, and the Middle East:** <http://www.nikon-asia.com/>
- Visit these sites to keep up-to-date with the latest product information, tips, answers to frequently-asked questions (FAQs), and general advice on digital imaging and photography. Additional information may be available from the Nikon representative in your area. See the following URL for contact information: <http://imaging.nikon.com/>

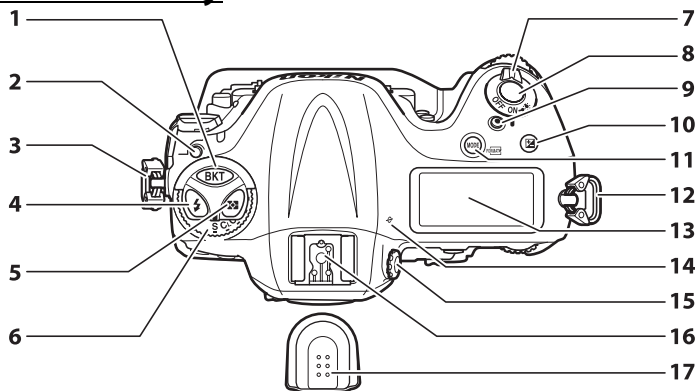


Introduction

Getting to Know the Camera

Take a few moments to familiarize yourself with camera controls and displays. You may find it helpful to bookmark this section and refer to it as you read through the rest of the manual.

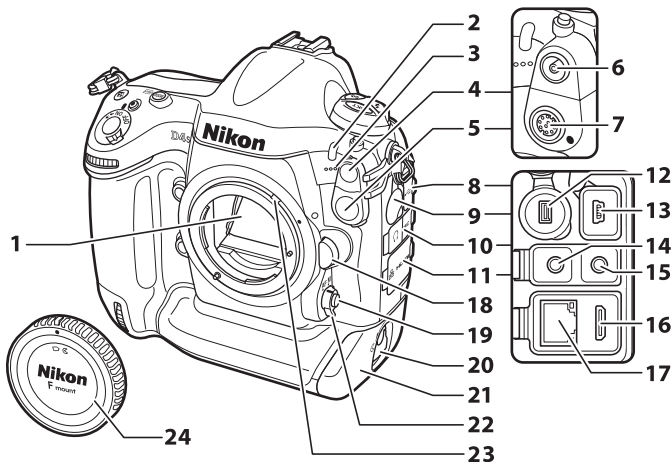
Camera Body



1 BKT button Bracketing..... 142, 146, 150, 344	10 button Exposure compensation 138
2 Release mode dial lock release..... 111	11 MODE/QUALITY button Exposure mode 125 Formatting memory cards 35
3 Eyelet for camera strap 21	12 Eyelet for camera strap..... 21
4 button Flash mode 204 Flash compensation 206	13 Top control panel..... 6
5 button Metering..... 124	14 Focal plane mark (\ominus) 109
6 Release mode dial..... 111	15 Diopter adjustment control 38
7 Power switch 9, 40	16 Accessory shoe (for optional flash unit)..... 16, 195
8 Shutter-release button 43, 44	17 Accessory shoe cover 16, 195, 428
9 Movie-record button..... 65, 349	



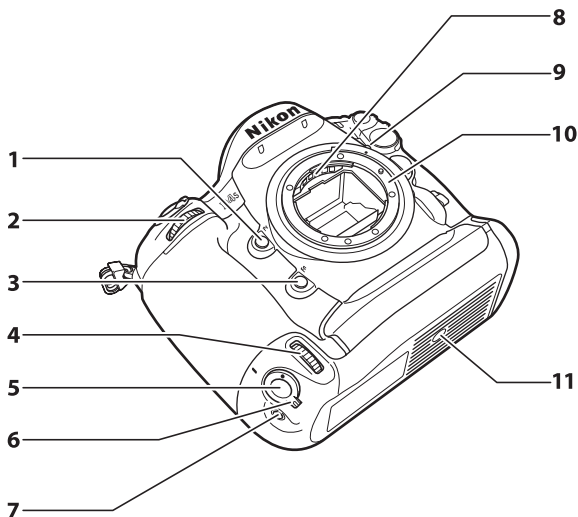
Camera Body (Continued)



1 Mirror..... 116, 420	13 USB connector272, 280
2 Self-timer lamp 115	14 Headphone connector 68, 267
3 Microphone (for movies).....65, 75	15 Connector for external microphone 75, 261
4 Flash sync terminal cover 195	16 HDMI connector285
5 Ten-pin remote terminal cover 238, 412	17 Ethernet connector276
6 Flash sync terminal 195	18 Lens release button 28
7 Ten-pin remote terminal ...238, 412	19 AF-mode button52, 54, 98, 101
8 USB connector cover 272, 280	20 Battery-chamber cover latch..... 24
9 Peripheral connector cover.....409	21 Battery-chamber cover 24
10 Audio connector cover..... 75, 261	22 Focus-mode selector 52, 97, 108
11 HDMI/Ethernet connector cover276, 285	23 Meter coupling lever453
12 Peripheral connector.....409	24 Body cap27, 411

Close the Connector Cover

Close the connector cover when the connectors are not in use. Foreign matter in the connectors can interfere with data transfer.

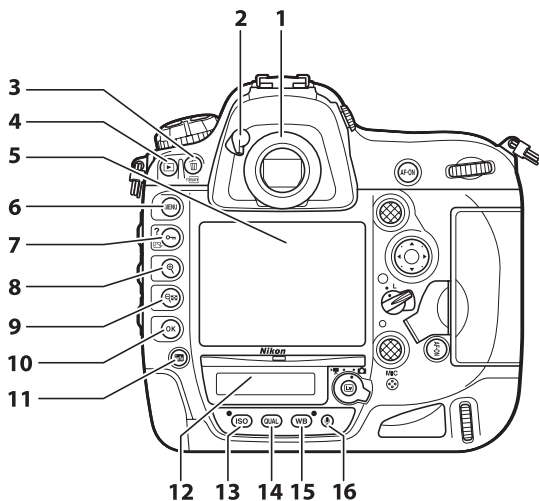


<p>1 Pv button Using the Pv button 54, 66, 126, 342, 355</p>	<p>6 Vertical shooting shutter-release button lock.....42</p>
<p>2 Sub-command dial..... 345</p>	<p>7 Fn button (vertical) Using the Fn button (vertical) ... 343</p>
<p>3 Fn button Using the Fn button89, 208, 337, 353</p>	<p>8 CPU contacts</p>
<p>4 Sub-command dial for vertical shooting..... 345</p>	<p>9 Lens mounting mark.....28</p>
<p>5 Shutter-release button for vertical shooting</p>	<p>10 Lens mount28, 109</p>
	<p>11 Tripod socket</p>

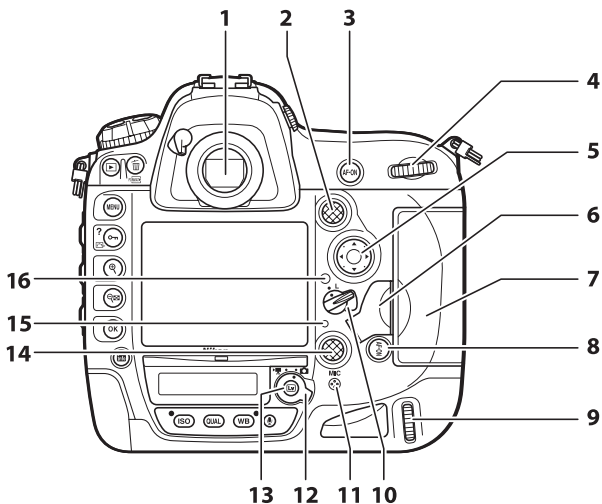
The Speaker

Do not place the speaker in close proximity to magnetic devices. Failure to observe this precaution could affect the data recorded on the magnetic devices.

Camera Body (Continued)

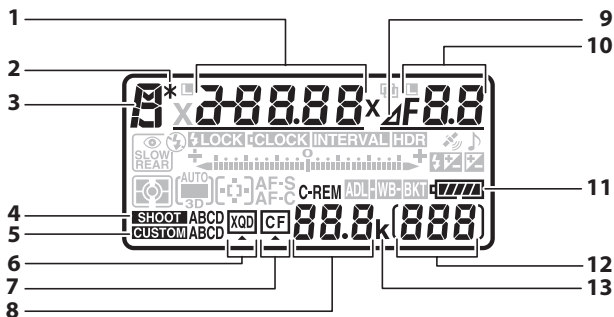


1	Viewfinder eyepiece 39, 114	10	OK (OK) button..... 18, 242
2	Eyepiece shutter lever..... 39, 114	11	info (info) button 12, 15
3	button Deletion 47, 257 Formatting memory cards 35	12	Rear control panel..... 8, 329
4	button Playback..... 46, 241	13	ISO button ISO sensitivity 117 Auto ISO sensitivity control.... 119 Two-button reset 211
5	Monitor 46, 49, 63, 241, 359, 360	14	QUAL button Image quality and size 91, 94
6	MENU button Menus..... 17, 289	15	WB button White balance 155, 160, 163 Two-button reset 211
7	(/?) button Protection..... 255 Picture Controls 177 Help 20	16	button Using the microphone 262, 263, 264
8	button Playback zoom in..... 253		
9	button Thumbnails 241 Playback zoom out..... 253		

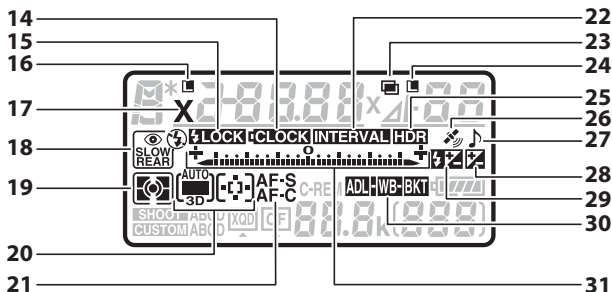


1 Viewfinder	38	10 Focus selector lock	103
2 Sub-selector	104, 105, 136, 342, 356	11 Microphone (for voice memos).....	261
3 AF-ON button	99, 106, 317	12 Live view selector	49, 63
4 Main command dial	345	13 $\frac{1}{2}$ button	49, 63, 349
5 Multi selector	18, 45, 243	14 Multi selector (vertical)	348
6 Card slot cover release button (under cover)	32	15 Memory card access lamp	33, 44
7 Memory card slot cover	32, 34	16 Ambient brightness sensor for automatic monitor brightness control	57, 359
8 $\frac{1}{2}$ button			
Using the AF-ON button for vertical shooting	318		
9 Main command dial (vertical)....	345		
Speaker	78, 267		

The Top Control Panel



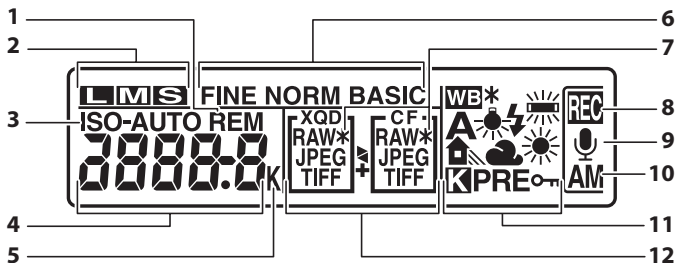
1	Shutter speed 128, 130	8	Number of exposures remaining 41, 464
	AF-area mode 100, 102		Number of shots remaining before memory buffer fills 113, 464
	Exposure compensation value 138		Capture mode indicator 411
	Flash compensation value 206	9	Aperture stop indicator 129, 405
	Number of shots in exposure and flash bracketing sequence 142	10	Aperture (f-number) 129, 130
	Number of shots in WB bracketing sequence 146		Aperture (number of stops) ... 129, 405
	HDR exposure differential 194		Bracketing increment 143, 147
	Number of exposures (multiple exposure) 216		Number of shots in ADL bracketing sequence 150
	Number of intervals for interval timer photography 226		Number of shots per interval 226
	Focal length (non-CPU lenses) 237		Maximum aperture (non-CPU lenses) 237
	ISO sensitivity 117		PC mode indicator 411
2	Flexible program indicator 127	11	Battery indicator 40
3	Exposure mode 125	12	Frame count 45
4	Shooting menu bank 300		Preset white balance recording indicator 166
5	Custom settings bank 311		Active D-Lighting amount ... 151, 341
6	XQD card indicator 34, 35		Manual lens number 237
7	CompactFlash card indicator 34, 35		Time-lapse recording indicator 233
		13	"k" (appears when memory remains for over 1000 exposures) 41



14	Clock battery indicator 31, 424	27	“Beep” indicator 326
15	FV lock indicator..... 209	28	Exposure compensation indicator 138
16	Shutter-speed lock icon 134	29	Flash compensation indicator 206
17	Flash sync indicator 331	30	Exposure and flash bracketing indicator..... 142
18	Flash mode 203		WB bracketing indicator 146
19	Metering..... 124		ADL bracketing indicator..... 150
20	AF-area mode 100, 102		Active D-Lighting indicator 151, 341
21	Autofocus mode..... 97, 98	31	Exposure indicator..... 131
22	Interval timer indicator..... 226		Exposure compensation display 138
23	Time-lapse on indicator 233		Bracketing progress indicator:
24	Aperture lock icon 135		Exposure and flash bracketing 142
	HDR (series) indicator 194		WB bracketing 146
	Multiple exposure (series) indicator 216		ADL bracketing..... 150
25	HDR indicator 191		PC connection indicator..... 411
26	Satellite signal indicator..... 239		

Note: Display shown with all indicators lit for illustrative purposes.



The Rear Control Panel



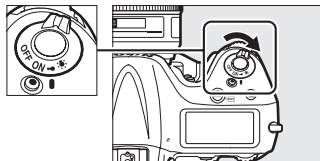
1 "Remaining" indicator	329	6 Image quality (JPEG images)	90
2 Image size (JPEG and TIFF images)	94	7 Small image size indicator (NEF/RAW images)	95
3 ISO sensitivity indicator	117	8 Voice memo recording indicator (shooting mode)	262
Auto ISO sensitivity indicator	121	9 Voice memo status indicator	264, 265
4 ISO sensitivity	117	10 Voice memo recording mode	262
ISO sensitivity (high/low gain)	118	11 White balance	155
Number of exposures remaining	329	White balance fine-tuning indicator	160
Length of voice memo	264	White balance preset protection indicator	176
White balance fine-tuning	160	12 Secondary slot function	96
White balance preset number	166	Image quality	90
Color temperature	157, 161		
PC mode indicator	411		
5 "k" (appears when memory remains for over 1000 exposures)	41		
Color temperature indicator	163		

Note: Display shown with all indicators lit for illustrative purposes.

LCD Illuminators

Rotating the power switch toward  activates the standby timer, control panel backlights (LCD illuminators), and button backlights (☐ 330), making it easier to use the camera in the dark. After the power switch is released, the backlights will remain lit for six seconds while the standby timer is active or until the shutter is released or the power switch is rotated toward  again.

Power switch

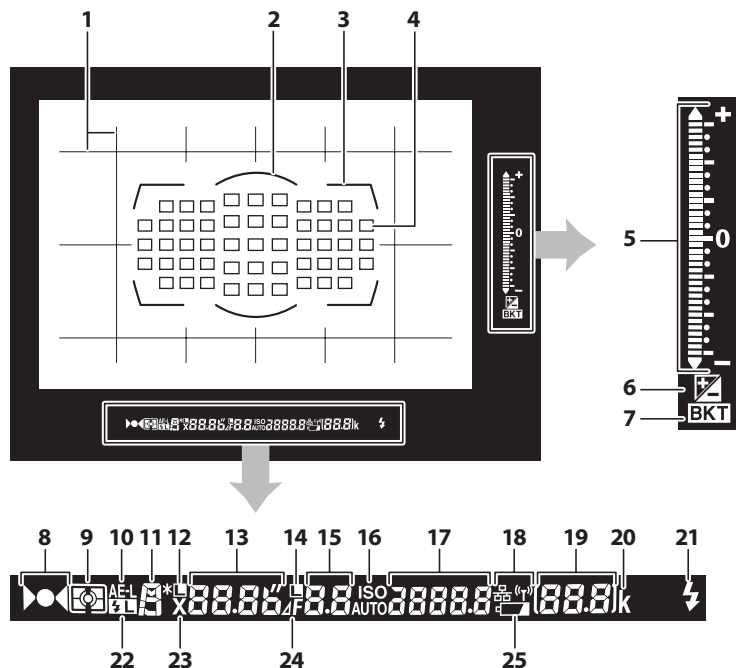


The Control Panel and Viewfinder Displays

The brightness of the control panel and viewfinder displays varies with temperature, and the response times of the displays may drop at low temperatures. This is normal and does not indicate a malfunction.



The Viewfinder Display



- 1 Framing grid (displayed when **On** is selected for Custom Setting d6)329
- 2 12-mm reference circle for center-weighted metering..... 123
- 3 AF area brackets 38
- 4 Focus points..... 43, 103, 315, 316
Spot metering targets..... 123
AF-area mode indicator 101
Roll indicator ¹340

- 5 Exposure indicator 131
Exposure compensation display 138
- Bracketing progress indicator:
Exposure and flash
bracketing 142
- Pitch indicator ²340
- 6 Exposure compensation
indicator 138
Flash compensation indicator206

7	Bracketing indicator: Exposure and flash bracketing 140 WB bracketing 146 ADL bracketing 150	19	Frame count 329 Number of exposures remaining 41, 329, 464 Number of shots remaining before memory buffer fills 43, 113, 464 Preset white balance recording indicator 166 Exposure compensation value 138 Flash compensation value 206 PC mode indicator 411
8	Focus indicator 43, 109	20	"k" (appears when memory remains for over 1000 exposures) 41
9	Metering 123	21	Flash-ready indicator ³ 199, 209, 454
10	Autoexposure (AE) lock 136	22	FV lock indicator 209
11	Exposure mode 125	23	Flash sync indicator 331
12	Shutter speed lock icon 134	24	Aperture stop indicator 129, 405
13	Shutter speed 128, 130 Autofocus mode 97, 98	25	Low battery warning 40
14	Aperture lock icon 135		
15	Aperture (f-number) 129, 130 Aperture (number of stops) 129, 405		
16	ISO sensitivity indicator 117 Auto ISO sensitivity indicator 120		
17	ISO sensitivity 117 Active D-Lighting amount 341 AF-area mode 101, 102		
18	Network display 276		



- 1 Functions as a pitch indicator when camera is rotated to take pictures in "tall" (portrait) orientation.
- 2 Functions as a roll indicator when camera is rotated to take pictures in "tall" (portrait) orientation.
- 3 Displayed when an optional flash unit is attached (□ 196). The flash-ready indicator lights when the flash is charged.

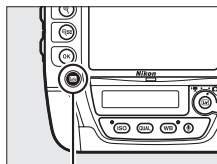
Note: Display shown with all indicators lit for illustrative purposes.

✓ No Battery

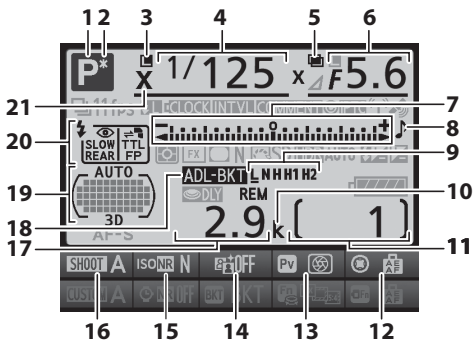
When the battery is totally exhausted or no battery is inserted, the display in the viewfinder will dim. This is normal and does not indicate a malfunction. The viewfinder display will return to normal when a fully-charged battery is inserted.

The Information Display

Shooting information, including shutter speed, aperture, frame count, number of exposures remaining, and AF-area mode, is displayed in the monitor when the **info** button is pressed.



info button




1	Exposure mode.....	125	6	Aperture (f-number)	129, 130
2	Flexible program indicator	127		Aperture (number of stops)....	129, 405
3	Shutter-speed lock icon	134		Bracketing increment	143, 147
4	Shutter speed	128, 130		Number of shots in ADL bracketing sequence	150
	Exposure compensation value	138		Maximum aperture (non-CPU lenses)	237
	Flash compensation value	206	7	Exposure indicator	131
	Number of shots in exposure and flash bracketing sequence	142		Exposure compensation display	138
	Number of shots in WB bracketing sequence	146		Bracketing progress indicator: Exposure and flash bracketing ...	142
	Number of exposures (multiple exposure)	216		WB bracketing	146
	Focal length (non-CPU lenses)	237		ADL bracketing.....	150
5	Multiple exposure indicator	215	8	“Beep” indicator	326

<p>9 Position of current frame in bracketing sequence 144, 148 ADL bracketing amount 151</p> <p>10 “k” (appears when memory remains for over 1000 exposures) 41</p> <p>11 Frame count 45 Manual lens number 237</p> <p>12 Sub-selector center assignment 342</p> <p>13 Pv button assignment 342</p> <p>14 Active D-Lighting indicator 189</p> <p>15 High ISO noise reduction indicator 308</p>	<p>16 Shooting menu bank 300</p> <p>17 Number of exposures remaining 41, 464</p> <p>18 Exposure and flash bracketing indicator 142 WB bracketing indicator 146 ADL bracketing indicator 150</p> <p>19 Focus points indicator 103 AF-area mode indicator 100, 101</p> <p>20 Flash mode 203</p> <p>21 Flash sync indicator 331</p>
--	--





Note: Display shown with all indicators lit for illustrative purposes.

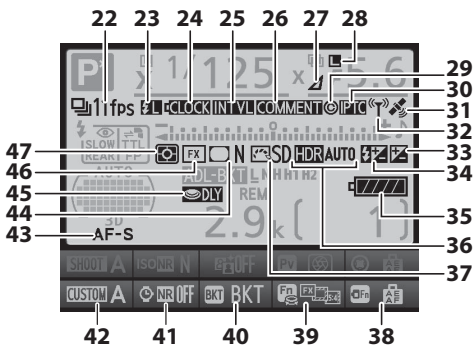
 **Turning the Monitor Off**

To clear shooting information from the monitor, press the  button twice more or press the shutter-release button halfway. The monitor will turn off automatically if no operations are performed for about 10 seconds.

 **See Also**

For information on choosing how long the monitor stays on, see Custom Setting c4 (**Monitor off delay**,  325). For information on changing the color of the lettering in the information display, see Custom Setting d9 (**Information display**,  330).

The Information Display (Continued)

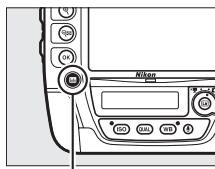


22 Release mode indicator.....	111	34 Flash compensation indicator.....	206
23 Continuous shooting speed.....	112	35 Battery indicator.....	40
24 FV lock indicator.....	209	36 HDR indicator.....	191
25 Clock battery indicator.....	31, 424	37 HDR exposure differential.....	194
26 Interval timer indicator.....	226	38 Picture Control indicator.....	178
27 Time-lapse indicator.....	233	39 Function assigned to Fn button (vert.).....	343
28 Image comment indicator.....	366	40 BKT button assignment.....	344
29 Aperture stop indicator.....	129, 405	41 Long exposure noise reduction indicator.....	308
30 Aperture lock icon.....	135	42 Custom settings bank.....	311
31 HDR (series) indicator.....	194	43 Autofocus mode indicator.....	97, 98
32 Multiple exposure (series) indicator.....	216	44 Vignette control indicator.....	306
33 Copyright information indicator.....	367	45 Exposure delay mode.....	327
34 IPTC indicator.....	368	46 Image area indicator.....	85
35 Satellite signal indicator.....	239	47 Metering.....	123
36 Network display.....	276		
37 Exposure compensation indicator.....	138		

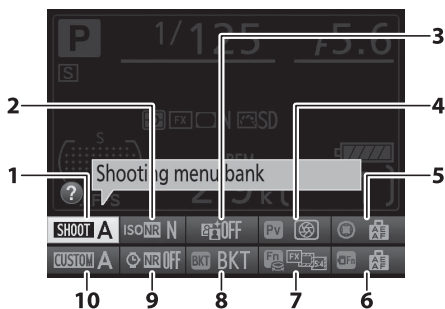
Note: Display shown with all indicators lit for illustrative purposes.

■ Changing Settings in the Information Display

To change settings for the items listed below, press the **Info** button in the information display. Highlight items using the multi selector and press **OK** to view options for the highlighted item.




Info button



1 Shooting menu bank.....	300	6 Fn button (vert.) assignment	343
2 High ISO noise reduction.....	308	7 Fn button assignment.....	337
3 Active D-Lighting.....	188	8 BKT button assignment.....	344
4 Pv button assignment	342	9 Long exposure noise reduction	308
5 Sub-selector center assignment.....	342	10 Custom settings bank.....	311

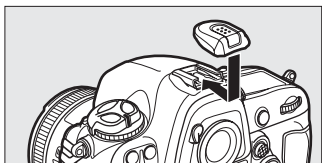
Tool Tips

A tool tip giving the name of the selected item appears in the information display. Tool tips can be turned off using Custom Setting d8 (**Screen tips**;  329).

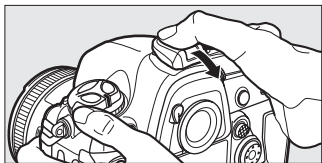


The BS-2 Accessory Shoe Cover

The supplied BS-2 accessory shoe cover can be used to protect the accessory shoe or to prevent light reflected from the metal parts of the shoe from appearing in photographs. The BS-2 attaches to the camera accessory shoe as shown at right.



To remove the accessory shoe cover, hold it down with your thumb and slide it off as shown at right while keeping a firm grip on the camera.

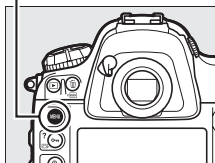


Tutorial

Camera Menu

Most shooting, playback, and setup options can be accessed from the camera menu. To view the menus, press the **MENU** button.

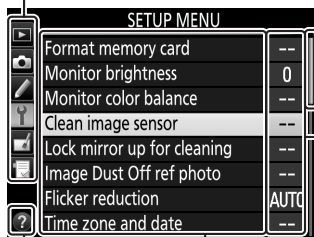
MENU button



Tabs

Choose from the following menus:

- : **Playback** (book 289)
- : **Shooting** (book 299)
- : **Custom Settings** (book 309)
- : **Setup** (book 358)
- : **Retouch** (book 375)
- / : **MY MENU** or **RECENT SETTINGS** (defaults to **MY MENU**; book 396)



Slider shows position in current menu.

Current settings are shown by icons.

Menu options
Options in current menu.



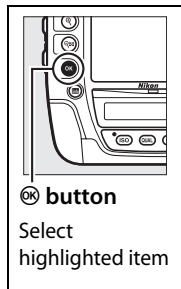
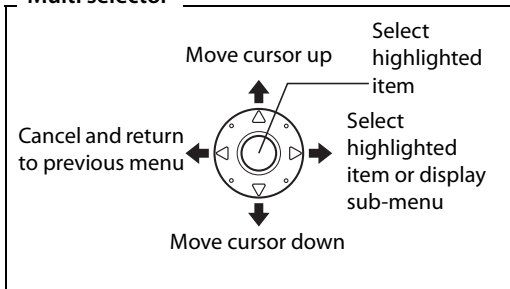
If icon is displayed, help for current item can be viewed by pressing (/) button (book 20).

Using Camera Menu

Menu Controls

The multi selector and **OK** button are used to navigate the menus.

Multi selector



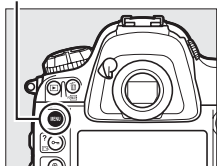
Navigating the Menus

Follow the steps below to navigate the menus.

1 Display the menus.

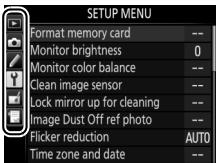
Press the **MENU** button to display the menus.

MENU button



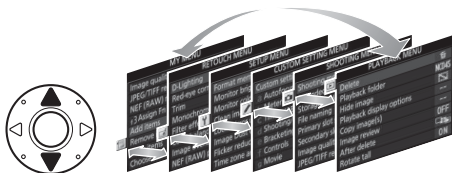
2 Highlight the icon for the current menu.

Press **◀** to highlight the icon for the current menu.



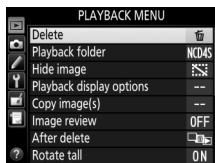
3 Select a menu.

Press ▲ or ▼ to select the desired menu.



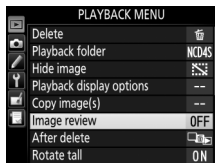
4 Position the cursor in the selected menu.

Press ► to position the cursor in the selected menu.



5 Highlight a menu item.

Press ▲ or ▼ to highlight a menu item.



6 Display options.

Press ► to display options for the selected menu item.



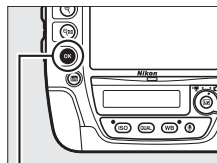
7 Highlight an option.

Press ▲ or ▼ to highlight an option.



8 Select the highlighted item.

Press **OK** to select the highlighted item. To exit without making a selection, press the **MENU** button.



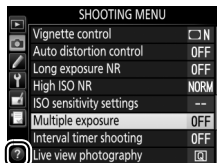
OK button

Note the following points:

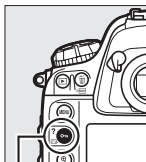
- Menu items that are displayed in gray are not currently available.
- While pressing **▶** or the center of the multi selector generally has the same effect as pressing **OK**, there are some cases in which selection can only be made by pressing **OK**.
- To exit the menus and return to shooting mode, press the shutter-release button halfway (□ 44).

Help

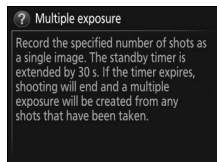
If a **?** icon is displayed at the bottom left corner of the monitor, help can be displayed by pressing the **?** (**INFO/?**) button.



A description of the currently selected option or menu will be displayed while the button is pressed. Press **▲** or **▼** to scroll through the display.



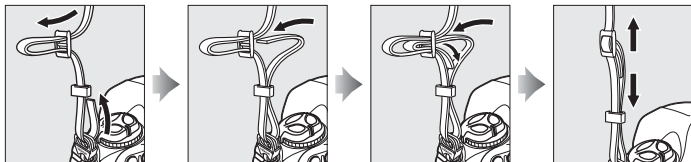
? (**INFO/?**) button



First Steps

Attach the Camera Strap

Attach the strap securely to the camera eyelets.

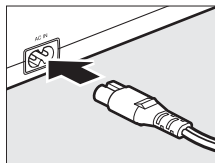


Charge the Battery

The D4S is powered by an EN-EL18a rechargeable Li-ion battery (supplied). To maximize shooting time, charge the battery in the supplied MH-26a battery charger before use. Batteries take about 2 hours and 35 minutes to fully recharge when no charge remains.

1 Plug the charger in.

Insert the AC adapter plug into the battery charger and plug the power cable into an electrical outlet.



2 Remove the terminal cover.

Remove the terminal cover from the battery.

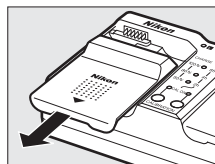


See Also

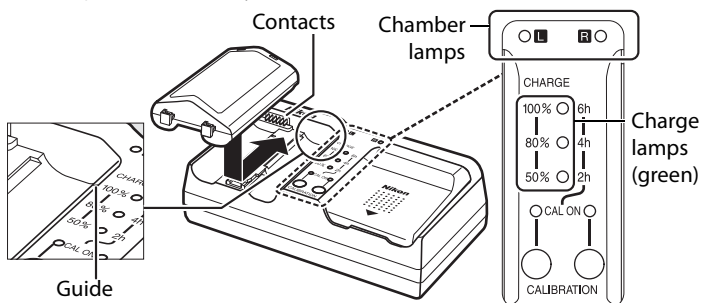
For information on using the MH-26a to charge two batteries, see page 460.

3 Remove the contact protector.

Remove the contact protector from the charger battery chamber.



4 Charge the battery.



Insert the battery (terminals first), aligning the end of the battery with the guide and then sliding the battery in the direction indicated until it clicks into place. The chamber lamp and charge lamps will flash slowly while the battery charges:

Charge state	Chamber lamp	Charge lamps		
		50%	80%	100%
Less than 50% of maximum capacity	☼ (flashes slowly)	☼ (flashes slowly)	● (off)	● (off)
50–80% of maximum capacity	☼ (flashes slowly)	○ (glows)	☼ (flashes slowly)	● (off)
More than 80% but less than 100% of maximum capacity	☼ (flashes slowly)	○ (glows)	○ (glows)	☼ (flashes slowly)
100% of maximum capacity	○ (glows)	● (off)	● (off)	● (off)

Charging is complete when the chamber lamp stops flashing and the charge lamps turn off. About 2 hours and 35 minutes are required to fully charge an exhausted battery; note that the battery will not charge if its temperature is below 0 °C (32 °F) or above 60 °C (140 °F).

-
- 5 Remove the battery when charging is complete.**
Remove the battery and unplug the charger.



Calibration

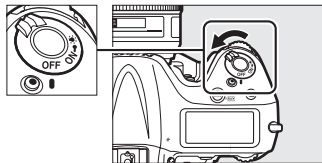
See page 459 for more information on calibration.

Insert the Battery

1 Turn the camera off.

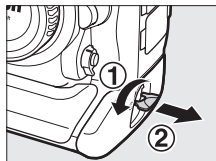
✓ Inserting and Removing Batteries

Always turn the camera off before inserting or removing batteries.



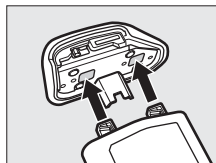
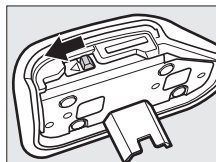
2 Remove the battery-chamber cover.

Lift the battery-chamber cover latch, turn it to the open (⊂) position (①) and remove the BL-6 battery-chamber cover (②).



3 Attach the cover to the battery.

If the battery release is positioned so that the arrow (◀) is visible, slide the battery release to cover the arrow. Insert the two projections on the battery into the matching slots in the cover and slide the battery release to completely reveal the arrow.



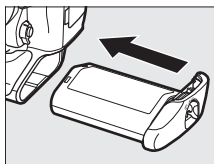
✓ The BL-6 Battery-Chamber Cover

The battery can be charged with the BL-6 attached. To prevent dust from accumulating inside the battery chamber when the battery is not inserted, slide the battery release in the direction indicated by the arrow (◀), remove the BL-6 from the battery, and replace it on the camera.

Other battery covers can not be used with this camera.

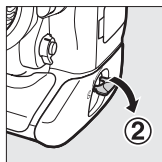
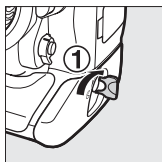
4 Insert the battery.

Insert the battery as shown at right.



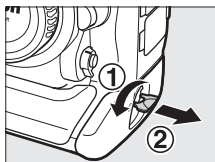
5 Latch the cover.

To prevent the battery from becoming dislodged during operation, rotate the latch to the closed position and fold it down as shown at right. Be sure the cover is securely latched.



Removing the Battery

Before removing the battery, turn the camera off, lift the battery-chamber cover latch, and turn it to the open (☞) position. Note that the battery may be hot after use; observe due caution when removing the battery. To prevent short-circuits, replace the terminal cover when the battery is not in use.



EN-EL18a Rechargeable Li-ion Batteries

The supplied EN-EL18a shares information with compatible devices, enabling the camera to show battery charge state in six levels (☞ 40). The **Battery info** option in the setup menu details battery charge, battery life, and the number of pictures taken since the battery was last charged (☞ 365). The battery can be recalibrated as necessary to ensure that battery level continues to be reported accurately (☞ 459).

The Battery and Charger

Read and follow the warnings and cautions on pages xii–xv and 426–429 of this manual. Do not use the battery at ambient temperatures below 0 °C (32 °F) or above 40 °C (104 °F); failure to observe this precaution could damage the battery or impair its performance. Capacity may be reduced and charging times increase at battery temperatures from 0 °C (32 °F) to 15 °C (59 °F) and from 45 °C (113 °F) to 60 °C (140 °F).

Do not short the charger terminals; failure to observe this precaution could result in overheating and damage to the charger. Charge indoors at ambient temperatures of 5 °C (41 °F) to 35 °C (95 °F). Battery capacity may temporarily drop if the battery is charged at low temperatures or used at a temperature below the temperature at which it was charged. If the battery is charged at a temperature below 5 °C (41 °F), the battery life indicator in the **Battery info** (□ 365) display may show a temporary decrease.

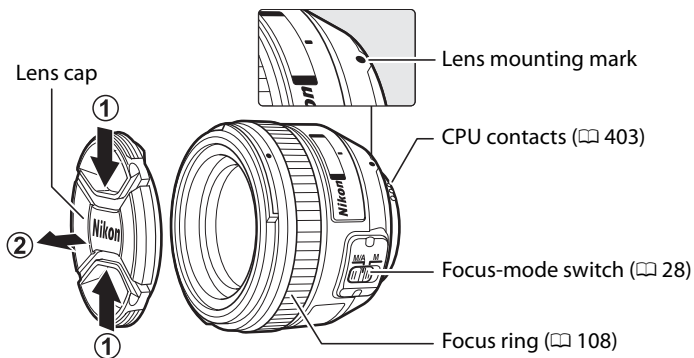
Use the charger with compatible batteries only. Unplug when not in use.

A marked drop in the time a fully charged battery retains its charge when used at room temperature indicates that it requires replacement. Purchase a new EN-EL18a battery.



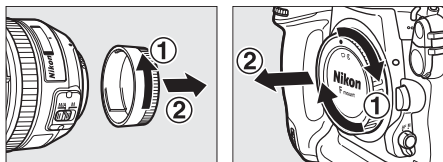
Attach a Lens

Care should be taken to prevent dust from entering the camera when the lens is removed. The lens generally used in this manual for illustrative purposes is an AF-S NIKKOR 50mm f/1.4G.

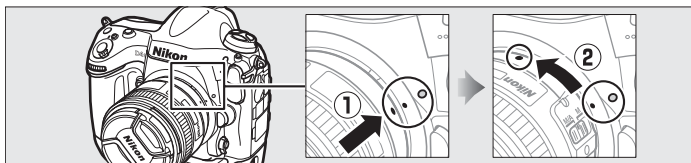


1 Turn the camera off.

2 Remove the rear lens cap and the camera body cap.



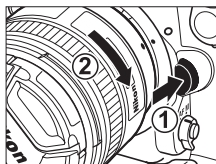
3 Attach the lens.



Keeping the mounting mark on the lens aligned with the mounting mark on the camera body, position the lens in the camera's bayonet mount (①). Being careful not to press the lens-release button, rotate the lens counter-clockwise until it clicks into place (②).

Detaching the Lens

Be sure the camera is off when removing or exchanging lenses. To remove the lens, press and hold the lens release button (①) while turning the lens clockwise (②). After removing the lens, replace the lens caps and camera body cap.



Lens Focus Mode

If the lens is equipped with a focus mode switch, select autofocus mode (A, M/A, or A/M).



CPU Lenses with Aperture Rings

In the case of CPU lenses equipped with an aperture ring (📖 403), lock aperture at the minimum setting (highest f-number).

Image Area

The DX format image area is automatically selected when a DX lens is attached (📖 86).



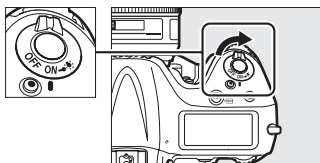
Image area

Basic Setup

The language option in the setup menu is automatically highlighted the first time menus are displayed. Choose a language and set the camera clock.

1 Turn the camera on.

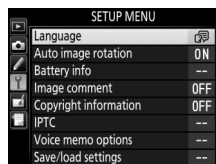
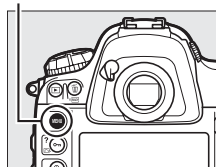
Power switch



2 Select Language in the setup menu.

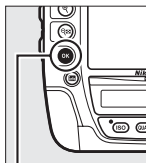
Press the MENU button to display the camera menus, then select **Language** in the setup menu. For information on using menus, see “Using Camera Menus” (18).

MENU button



3 Select a language.

Press ▲ or ▼ to highlight the desired language and press **OK**.



OK button



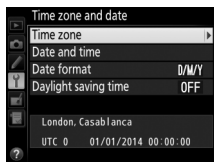
4 Select Time zone and date.

Select **Time zone and date** and press ►.



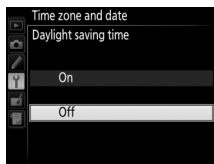
5 Set time zone.

Select **Time zone** and press ►. Press ◀ or ▶ to highlight the local time zone (the **UTC** field shows the difference between the selected time zone and Coordinated Universal Time, or UTC, in hours) and press Ⓞ.



6 Turn daylight saving time on or off.

Select **Daylight saving time** and press ►. Daylight saving time is off by default; if daylight saving time is in effect in the local time zone, press ▲ to highlight **On** and press Ⓞ.



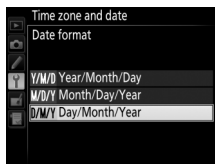
7 Set the date and time.

Select **Date and time** and press ►. Press ◀ or ▶ to select an item, ▲ or ▼ to change. Press Ⓞ when the clock is set to the current date and time (note that the camera uses a 24-hour clock).



8 Set date format.

Select **Date format** and press **▶**. Press **▲** or **▼** to choose the order in which the year, month, and day will be displayed and press **OK**.



9 Exit to shooting mode.

Press the shutter-release button halfway to exit to shooting mode.



The Clock Battery

The camera clock is powered by a separate, non-rechargeable CR1616 lithium battery with a life of about two years. When this battery is low, a **CLOCK** icon will be displayed in the top control panel while the standby timer is on. For information on replacing the clock battery, see page 424.


The Camera Clock

The camera clock is less accurate than most watches and household clocks. Check the clock regularly against more accurate time pieces and reset as necessary.

GPS Units (📖 238)

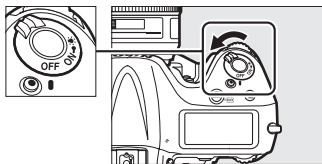
If a GPS unit (📖 412) is connected, the camera clock will be set to the time and date provided by the GPS unit (📖 240).

Insert a Memory Card

Pictures are stored on memory cards (available separately;  462). The camera is equipped with two card slots, one for XQD and the other for Type I CompactFlash cards. Type II cards and microdrives can not be used.

1 Turn the camera off.

Power switch

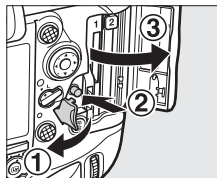


Inserting and Removing Memory Cards

Always turn the camera off before inserting or removing memory cards.

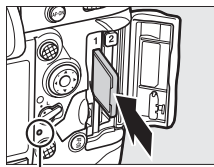
2 Open the card slot cover.

Open the door protecting the card-slot cover release button (1) and press the release button (2) to open the card slot (3).



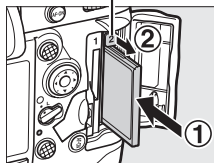
3 Insert the memory card.

XQD memory cards: Holding the card with the rear label toward the monitor, slide it into the XQD card slot until it clicks into place. The green memory card access lamp will light briefly.



Memory card access lamp

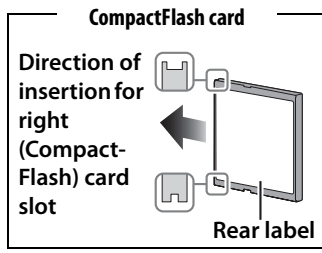
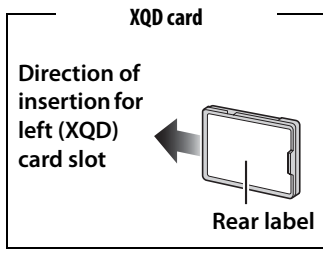
CompactFlash memory cards: Insert the card into the CompactFlash card slot with the rear label toward the monitor (①). When the memory card is fully inserted, the eject button will pop up (②) and the green memory card access lamp will light briefly.



Eject button

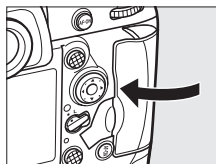
✓ Inserting Memory Cards

After confirming that you are inserting the card into the correct slot, insert the memory card terminals first. Inserting the card into the wrong slot or inserting it upside down or backwards could damage the camera or the card. Check to be sure that the card is in the correct orientation.



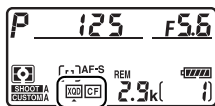
4 Close the card slot cover.

If this is the first time the memory card will be used after being used or formatted in another device, format the card as described on page 35.



Memory Card Icons

The memory cards currently inserted in the camera are indicated as shown (the example at right shows the icons displayed when both an XQD and a CompactFlash card are inserted). If the memory card is full or an error has occurred, the icon for the affected card will flash (☞ 446).



Top control panel

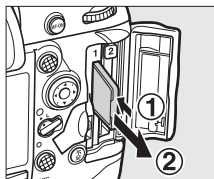
Using Two Memory Cards

When two memory cards are inserted, you can choose either of the two to serve as the primary card (☞ 41) and select the role played by the remaining card (☞ 96).

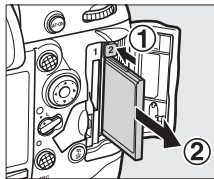
Removing Memory Cards

After confirming that the memory card access lamp is off, turn the camera off and open the memory card slot cover.

XQD memory cards: Press the card in to eject it (①). The memory card can then be removed by hand.



CompactFlash memory cards: Press the eject button (①) to partially eject the card (②). The memory card can then be removed by hand. Do not push on the memory card while pressing the eject button. Failure to observe this precaution could damage the camera or memory card.



Format the Memory Card

Memory cards must be formatted before first use or after being used or formatted in other devices.

✔ Formatting Memory Cards

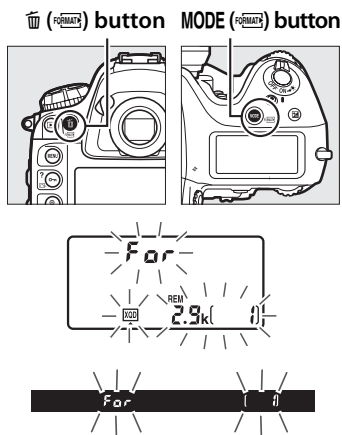
Formatting memory cards permanently deletes any data they may contain.

Be sure to copy any photographs and other data you wish to keep to a computer before proceeding (📖 272).

1 Turn the camera on.

2 Press the **MODE** (FORMAT) and **🗑️** (FORMAT) buttons.

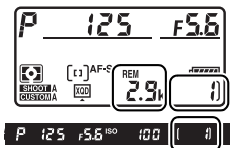
Hold the **MODE** (FORMAT) and **🗑️** (FORMAT) buttons down simultaneously until a flashing **F o r** appears in the shutter-speed displays in the top control panel and viewfinder. If two memory cards are inserted, the card to be formatted is shown by a flashing icon. By default, the primary card slot (📖 96) will be selected; you can choose the secondary slot by rotating the main command dial. To exit without formatting the memory card, wait until **F o r** stops flashing (about six seconds) or press any button other than the **MODE** (FORMAT) and **🗑️** (FORMAT) buttons.



3 Press the **MODE** (FORMAT) and **DISP** (FORMAT) buttons again.

Press the **MODE** (FORMAT) and **DISP** (FORMAT) buttons together a second time while **F a r** is flashing to format the memory card. *Do not remove the memory card or remove or disconnect the power source during formatting.*

When formatting is complete, the top control panel will show the number of photographs that can be recorded at current settings and the frame-count displays will show 1.

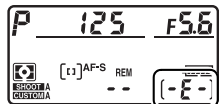


✔ Memory Cards

- Memory cards may be hot after use. Observe due caution when removing memory cards from the camera.
- Turn the power off before inserting or removing memory cards. Do not remove memory cards from the camera, turn the camera off, or remove or disconnect the power source during formatting or while data are being recorded, deleted, or copied to a computer. Failure to observe these precautions could result in loss of data or in damage to the camera or card.
- Do not touch the card terminals with your fingers or metal objects.
- Do not bend, drop, or subject to strong physical shocks.
- Do not apply force to the card casing. Failure to observe this precaution could damage the card.
- Do not expose to water, high levels of humidity, or direct sunlight.
- Do not format memory cards in a computer.

✎ No Memory Card

If no memory card is inserted, the top control panel and viewfinder will show (- E -). If the camera is turned off with a charged battery and no memory card inserted, (- E -) will be displayed in the top control panel.



✎ See Also

See page 359 for information on formatting memory cards using the **Format memory card** option in the setup menu.



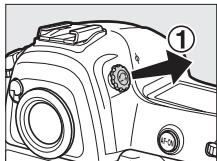
Adjust Viewfinder Focus

The camera is equipped with diopter adjustment to accommodate individual differences in vision. Check that the display in the viewfinder is in focus before shooting.

1 Turn the camera on.

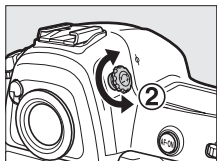
Remove the lens cap and turn the camera on.

2 Lift the diopter adjustment control (①).

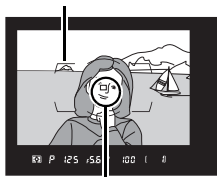


3 Focus the viewfinder.

Rotate the diopter adjustment control (②) until the viewfinder display, focus points, and AF area brackets are in sharp focus. When operating the control with your eye to the viewfinder, be careful not to put your fingers or fingernails in your eye.



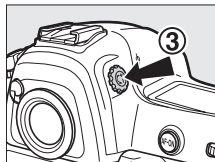
AF area brackets







Focus point

4 Replace the diopter adjustment control.


Push the diopter adjustment control back in (3).



Adjusting Viewfinder Focus

If you are unable to focus the viewfinder as described above, select single-servo AF (**AF-S**;  97), single-point AF ( 100), and the center focus point ( 103), and then frame a high-contrast subject in the center focus point and press the shutter-release button halfway to focus the camera. With the camera in focus, use the diopter adjustment control to bring the subject into clear focus in the viewfinder. If necessary, viewfinder focus can be further adjusted using optional corrective lenses ( 410).

Diopter-Adjustment Viewfinder Lenses

Corrective lenses (available separately;  410) can be used to further adjust viewfinder diopter. Before attaching a diopter-adjustment viewfinder lens, remove the DK-17 viewfinder eyepiece by closing the viewfinder shutter to release the eyepiece lock (1) and then unscrewing the eyepiece as shown at right (2).



Basic Photography and Playback

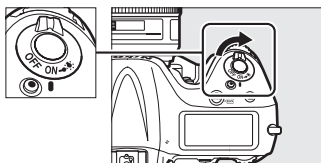
Turn the Camera On

Before taking photographs, turn the camera on and check the battery level and number of exposures remaining as described below.

1 Turn the camera on.

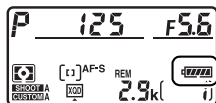
Turn the camera on. The control panels will turn on and the display in the viewfinder will light.

Power switch




2 Check the battery level.

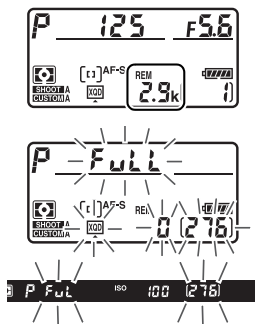
Check the battery level in the top control panel or viewfinder.






Icon		Description
Control panel	Viewfinder	
	—	Battery partially discharged.
	—	
	—	
	—	
		Low battery. Charge battery or ready spare battery.
(flashes)	(flashes)	Shutter release disabled. Charge or exchange battery.

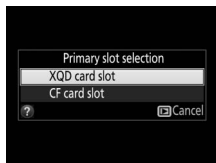
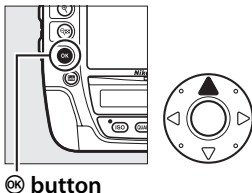
3 Check the number of exposures remaining.

The top control panel shows the number of photographs that can be taken at current settings (values over 1000 are rounded down to the nearest hundred; e.g., values between 2900 and 2999 are shown as 2.9 k). If two memory cards are inserted, the displays show the space available on the card in the primary slot. When this number reaches zero,  will flash in the exposure-count displays while the shutter-speed displays will show a flashing **F u l l** or **F u l** and the icon for the affected card will flash. Insert another memory card or delete some photos.



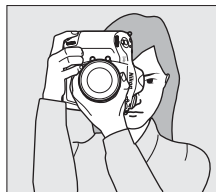
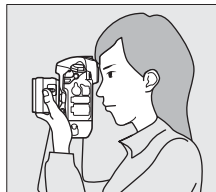
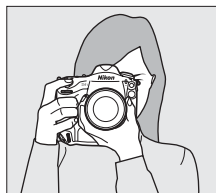
Choosing the Primary Card Slot

The **Primary slot selection** option is used to choose which of the two card slots serves as the primary slot. **Primary slot selection** can be accessed from the shooting menu (📖 96) or in viewfinder photography by keeping the  button pressed and pressing . Highlight the desired slot and press  to select.



Ready the Camera

When framing photographs in the viewfinder, hold the handgrip in your right hand and cradle the camera body or lens with your left. Keep your elbows propped lightly against your torso for support and place one foot half a pace ahead of the other to keep your upper body stable. When framing photographs in portrait (tall) orientation, hold the camera as shown in the bottom of the three illustrations at right.



Framing Photos in Portrait (Tall) Orientation

The camera is equipped with controls for use in portrait (tall) orientation, including a vertical shutter-release, **Fn**, and **AF-ON** buttons, main and sub-command dials, and multi selector (☐ 104, 318, 343, 348). Rotate the vertical shooting shutter-release button lock to **L** to avoid accidentally operating these controls when the camera is in landscape (wide) orientation.

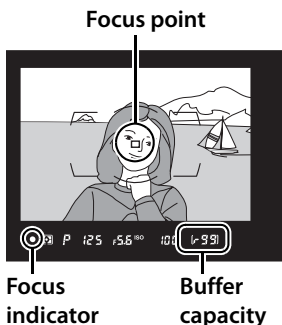


Vertical shooting shutter-release button lock

Focus and Shoot

1 Press the shutter-release button halfway (📖 44).

At default settings, the camera will focus on the subject in the center focus point. Frame a photo in the viewfinder with the main subject positioned in the center focus point and press the shutter-release button halfway.



2 Check indicators in the viewfinder.

When the focus operation is complete, the in-focus indicator (●) will appear in the viewfinder.

Viewfinder display	Description
●	Subject in focus.
▶	Focus point is between camera and subject.
◀	Focus point is behind subject.
▶◀ (flashes)	Camera unable to focus on subject in focus point using autofocus.

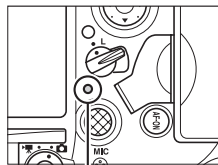
While the shutter-release button is pressed halfway, focus will lock and the number of exposures that can be stored in the memory buffer ("99"; 📖 113) will be shown in the viewfinder display.



For information on what to do if the camera is unable to focus using autofocus, see "Getting Good Results with Autofocus" (📖 107).

3 Shoot.

Smoothly press the shutter-release-button the rest of the way down to release the shutter and record the photograph. While the photograph is being recorded to the memory card, the memory card access lamp will light. *Do not eject the memory card or remove or disconnect the power source until the lamp has gone out and recording is complete.*



Memory card access lamp

The Shutter-Release Button

The camera has a two-stage shutter-release button. The camera focuses when the shutter-release button is pressed halfway. To take the photograph, press the shutter-release button the rest of the way down.



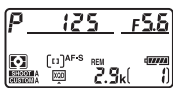
Focus



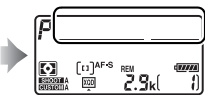
Take photograph

The Standby Timer

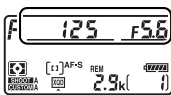
The shutter speed and aperture displays in the top control panel and viewfinder will turn off if no operations are performed for about six seconds, reducing the drain on the battery. Press the shutter-release button halfway to reactivate the display in the viewfinder.




Exposure meters
on




Exposure meters
off

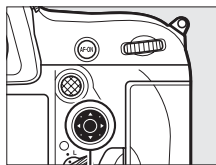


Exposure meters
on

The length of time before the standby timer expires automatically can be adjusted using Custom Setting c2 (**Standby timer**,  324).

The Multi Selector

The multi selector can be used to select the focus point while the exposure meters are on ( 103).



Multi selector

Camera Off Display

If the camera is turned off with a battery and memory card inserted, the memory card icon, frame count, and number of exposures remaining will be displayed (some memory cards may in rare cases only display this information when the camera is on).



Top control panel

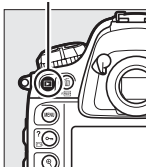


Viewing Photographs






1 Press the button.

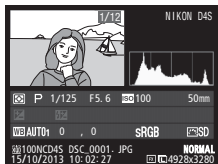
A photograph will be displayed in the monitor. The memory card containing the picture currently displayed is shown by an icon.

 button



2 View additional pictures.

Additional pictures can be displayed by pressing  or . To view additional information on the current photograph, press  and  ( 244).



To end playback and return to shooting mode, press the shutter-release button halfway.


Image Review

When **On** is selected for **Image review** in the playback menu ( 295), photographs are automatically displayed in the monitor after shooting.

See Also

See page 242 for information on choosing a memory card slot.

Deleting Unwanted Photographs




Unwanted photographs can be deleted by pressing the  (FORMAT) button. Note that photographs can not be recovered once deleted.

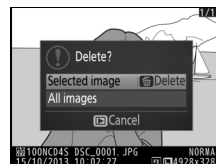
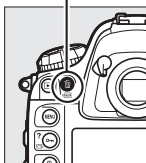
1 Display the photograph.

Display the photograph you wish to delete as described in “Viewing Photographs” on the previous page. The location of the current image is shown by an icon at the bottom left corner of the display.




2 Delete the photograph. (FORMAT) button

Press the  (FORMAT) button. A confirmation dialog will be displayed; highlight **Selected image** and press  (FORMAT) again to delete the image and return to playback (for information on the **All images** option, see page 257). To exit without deleting the picture, press .




Delete

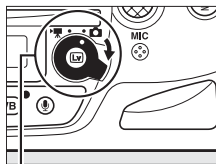
To delete multiple images or to select the memory card from which images will be deleted, use the **Delete** option in the playback menu ( 259).




Live View Photography

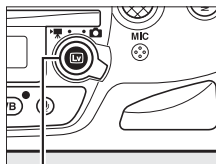
Follow the steps below to take photographs in live view.

- 1 Rotate the live view selector to  (live view photography).**



Live view selector

- 2 Press the  button.**
The mirror will be raised and the view through the lens will be displayed in the camera monitor. The subject will no longer be visible in the viewfinder.



 button

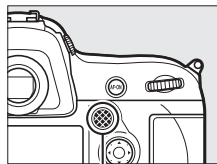
- 3 Position the focus point.**
Position the focus point over your subject as described on page 53.

4 Focus.

Press the shutter-release button halfway to focus.




The focus point will flash green while the camera focuses. If the camera is able to focus, the focus point will be displayed in green; if the camera is unable to focus, the focus point will flash red (note that pictures can be taken even when the focus point flashes red; check focus in the monitor before shooting). Exposure can be locked by pressing the center of the sub-selector (☞ 136); focus locks while the shutter-release button is pressed halfway.



Sub-selector

Exposure Preview

During live view photography, you can press  to preview the effects of shutter speed, aperture, and ISO sensitivity on exposure. When **Quiet** is selected for **Live view photography** in the shooting menu, exposure can be adjusted by ± 5 EV (☞ 138), although only values between -3 and $+3$ EV are reflected in the preview display. Note that the preview may not accurately reflect the final results when flash lighting is used, Active D-Lighting (☞ 188), High Dynamic Range (HDR; ☞ 190), or bracketing is in effect, **A** (auto) is selected for the Picture Control **Contrast** parameter (☞ 180), or **x 25 a** is selected for shutter speed. If the subject is very bright or very dark, the exposure indicators will flash to warn that the preview may not accurately reflect exposure. Exposure preview is not available when **b**, **w**, **i**, **b** or **-** is selected for shutter speed.



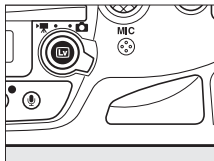
5 Take the picture.

Press the shutter-release button the rest of the way down to shoot. The monitor will turn off.



6 Exit live view mode.

Press the **[Lv]** button to exit live view mode.



✓ Using Autofocus in Live View Photography and Movie Live View

Use an AF-S lens. The desired results may not be achieved with other lenses or teleconverters. Note that in live view, autofocus is slower and the monitor may brighten or darken while the camera focuses. The focus point may sometimes be displayed in green when the camera is unable to focus. The camera may be unable to focus in the following situations:

- The subject contains lines parallel to the long edge of the frame
- The subject lacks contrast
- The subject in the focus point contains areas of sharply contrasting brightness, or includes spot lighting or a neon sign or other light source that changes in brightness
- Flicker or banding appears under fluorescent, mercury-vapor, sodium-vapor, or similar lighting
- A cross (star) filter or other special filter is used
- The subject appears smaller than the focus point
- The subject is dominated by regular geometric patterns (e.g., blinds or a row of windows in a skyscraper)
- The subject is moving

See Also

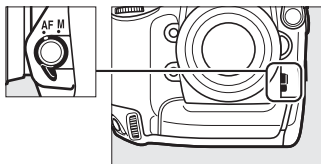
See page 169 for information on measuring a value for preset white balance during live view photography and movie live view.



Focusing in Live View Photography and Movie Live View

To focus using autofocus, rotate the focus-mode selector to **AF** and follow the steps below to choose autofocus and AF-area modes. For information on focusing manually, see page 59.

Focus-mode selector



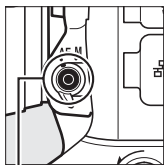
■ ■ Choosing a Focus Mode

The following autofocus modes are available during live view photography and movie live view:

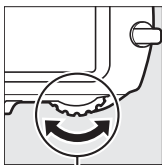
LV

Mode	Description
AF-S	Single-servo AF: For stationary subjects. Focus locks when shutter-release button is pressed halfway.
AF-F	Full-time servo AF: For moving subjects. Camera focuses continuously until shutter-release button is pressed. Focus locks when shutter-release button is pressed halfway.

To choose an autofocus mode, press the AF-mode button and rotate the main command dial until the desired mode is displayed in the monitor.



AF-mode button







Main command dial



Monitor

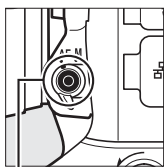
■ ■ Choosing an AF-Area Mode

The following AF-area modes can be selected during live view photography and movie live view:

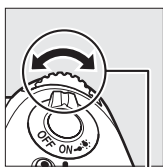
Mode	Description
	Face-priority AF: Use for portraits. The camera automatically detects and focuses on portrait subjects; the selected subject is indicated by a double yellow border (if multiple faces, up to a maximum of 35, are detected, the camera will focus on the closest subject; to choose a different subject, use the multi selector). If the camera can no longer detect the subject (because, for example, the subject has turned to face away from the camera), the border will no longer be displayed.
	Wide-area AF: Use for hand-held shots of landscapes and other non-portrait subjects. Use the multi selector to move the focus point anywhere in the frame, or press the center of the multi selector to position the focus point in the center of the frame.
	Normal-area AF: Use for pin-point focus on a selected spot in the frame. Use the multi selector to move the focus point anywhere in the frame, or press the center of the multi selector to position the focus point in the center of the frame. A tripod is recommended.
	Subject-tracking AF: Position the focus point over your subject and press the center of the multi selector. The focus point will track the selected subject as it moves through the frame. To end tracking, press the center of the multi selector again. Note that the camera may be unable to track subjects if they move quickly, leave the frame or are obscured by other objects, change visibly in size, color, or brightness, or are too small, too large, too bright, too dark, or similar in color or brightness to the background.



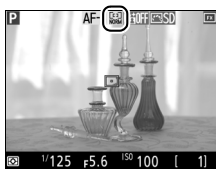
To choose an AF-area mode, press the AF-mode button and rotate the sub-command dial until the desired mode is displayed in the monitor.



AF-mode
button



Sub-command
dial



Monitor



Previewing Focus During Live View Photography

To temporarily select maximum aperture for an improved focus preview during live view photography, press the **Pv** button. To return aperture to its original value, press the button again or focus using autofocus. If the shutter-release button is pressed all the way down to take a picture during focus preview, aperture will return to the original value before the photo is taken.

The Live View Display: Live View Photography



Item	Description	
① Time remaining	The amount of time remaining before live view ends automatically. Displayed if shooting will end in 30 s or less.	55, 68
② Monitor hue (monitor white balance) indicator	Adjust monitor hue (monitor white balance).	56
③ Autofocus mode	The current autofocus mode.	52
④ AF-area mode	The current AF-area mode.	53
⑤ Focus point	The current focus point. The display varies with the option selected for AF-area mode.	49
⑥ Monitor brightness indicator	A monitor brightness indicator.	57
⑦ Guide	A guide to the options available during live view photography.	56, 57


The Count Down Display

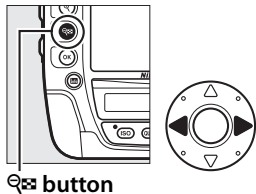
A count down will be displayed 30 s before live view ends automatically (the timer turns red if live view is about to end to protect the internal circuits or, if an option other than **No limit** is selected for Custom Setting c4—**Monitor off delay > Live view**; 325—5 s before the monitor is due to turn off automatically). Depending on shooting conditions, the timer may appear immediately when live view is selected.

■ Adjusting Monitor Hue (Monitor White Balance)

If flash lighting is used with **Flash** or **Preset manual** white balance (☞ 155), the colors in the monitor may differ from those in the final photograph. Monitor hue can be adjusted to reduce the effects of ambient lighting on the display in the monitor during live view photography, for example when using a flash.



1 Highlight the monitor hue indicator.

Press and hold  and press ◀ or ▶ to highlight the monitor hue indicator at the left side of the display.





 button

2 Adjust monitor hue.


Keeping the  button pressed, rotate the main command dial to adjust monitor hue (select  to preview the hue of the final photograph in the monitor;



if another option is selected when **Quiet** is chosen for **Live view photography** in the shooting menu (☞ 60), the hue seen in the monitor during live view photography will differ from that seen in the final image). At settings other than , the icon for the selected option will be displayed in the monitor when you release the  button. Monitor hue is reset when the camera is turned off.




Recalling Monitor Hue (Monitor White Balance)

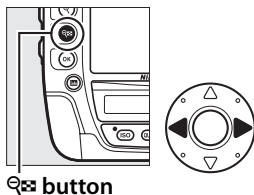
To restore the most recently selected monitor hue when starting live view, hold the **WB** button while pressing .

■ ■ Adjusting Monitor Brightness


Monitor brightness can be adjusted as described below. Note that brightness adjustment is not available during exposure preview.

1 Highlight the monitor brightness indicator.

Press and hold  and press ◀ or ▶ to highlight the monitor brightness indicator at the right side of the display.



2 Adjust monitor brightness.

Keeping the  button pressed, press ▲ or ▼ to adjust monitor brightness (note that this affects live view only and has no effect on photographs or movies or on the brightness of the monitor for menus or playback; to adjust the brightness of the monitor for menus and playback without affecting live view photography or movie live view, use the **Monitor brightness** option in the setup menu as described on page 359). If **A** (auto) is selected and the monitor is on, the camera will automatically adjust brightness in response to ambient lighting conditions as measured by the ambient brightness sensor (□ 5).

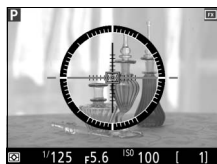


The Information Display: Live View Photography

To hide or display indicators in the monitor during live view photography, press the **info** button.

Virtual horizon

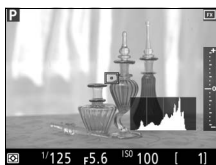
( 372)




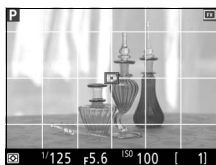
Information on



Information off



Histogram
(exposure preview
only;  50)



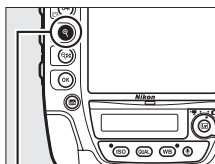
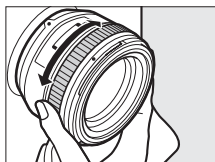
Framing guides

LV

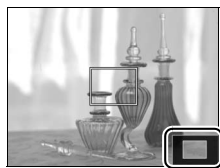
Manual Focus

To focus in manual focus mode (📖 108), rotate the lens focus ring until the subject is in focus.

To magnify the view in the monitor up to about 15 × for precise focus, press the 🔍 button. While the view through the lens is zoomed in, a navigation window will appear in a gray frame at the bottom right corner of the display. Use the multi selector to scroll to areas of the frame not visible in the monitor (available only if wide- or normal-area AF is selected for AF-area mode), or press 🔍➡ to zoom out.



🔍 button







Navigation window



Live View Shutter Release Options

The following options can be displayed by pressing **MENU** and selecting **Live view photography** in the shooting menu:

Mode	Description
 Quiet	Except when an optional flash unit is used, the mirror remains up during live view photography, reducing noise during shooting. The noise of the shutter is still audible.
 Silent	The mirror remains up and the shutter stays open during live view photography for less noise than Quiet mode;  is displayed in the monitor. While the shutter-release button is pressed, the camera will take up to five seconds of JPEG photos at about 12 fps in continuous low-speed release mode, or at about 24 fps in continuous high-speed release mode; the time remaining is shown in the frame-count display. In other release modes, one photo will be taken each time the shutter-release button is pressed. ISO sensitivity is set automatically except in exposure mode M , when you can choose from values between ISO 200 and Hi 4 (📖 76). In exposure mode M , shutter speed can be set to values between $1/25$ s and $1/8000$ s. Exposure can be previewed in the monitor (📖 50); to view or hide an indicator (📖 131) showing the difference between the value selected by the camera and the value you have selected, press  .

Silent Mode

In silent mode, the flash will not fire, Active D-Lighting (☐ 188), HDR (☐ 190), vignette control (☐ 306), distortion control (☐ 307), multiple exposure (☐ 214), and high ISO noise reduction (☐ 308) turn off, and image quality is fixed at JPEG fine. Image size is determined solely by the option selected for **Image area** (☐ 86) and is unaffected by the option selected for **JPEG/TIFF recording > Image size**:

- **FX (36 × 24) 1.0x**: 1920 × 1280
- **DX (24 × 16) 1.5x**: 1280 × 848
- **1.2x (30 × 20) 1.2x**: 1600 × 1064
- **5:4 (30 × 24)**: 1600 × 1280

Exposure can be adjusted by ±3 EV (☐ 138). Matrix metering is selected automatically, and the following settings can be adjusted.


	Aperture	Shutter speed	ISO sensitivity
<i>P, S</i>	—	—	—
<i>A</i>	✓	—	—
<i>M</i>	✓	✓	✓

Note that silent mode is not completely silent: the shutter sounds and the mirror is raised and lowered at the start and end of live view photography.

HDMI

If the camera is connected to an HDMI video device during live view photography, the camera monitor will remain on and the video device will display the view through the lens.

See Also

For information on choosing the roles played by the center of the multi selector and by the movie-record button and command dials, see Custom Settings f1 (**Multi selector center button**, ☐ 335) and f16 (**Assign movie record button**, ☐ 349). For information on preventing unintended operation of the  button, see Custom Setting f17 (**Live view button options**, ☐ 349).




Shooting in Live View Mode

To prevent light entering via the viewfinder from interfering with photographs or exposure, close the viewfinder eyepiece shutter.

Although they will not appear in the final picture unless **Silent** is selected for **Live view photography** (☐ 60), jagged edges, color fringing, moiré, and bright spots may appear in the monitor, while bright bands may appear in some areas with flashing signs and other intermittent light sources or if the subject is briefly illuminated by a strobe or other bright, momentary light source. In addition, distortion may occur if the camera is panned horizontally or an object moves at high speed through the frame. Flicker and banding visible in the monitor under fluorescent, mercury vapor, or sodium lamps can be reduced using **Flicker reduction** (☐ 363), although they may still be visible in the final photograph at some shutter speeds. When shooting in live view mode, avoid pointing the camera at the sun or other strong light sources. Failure to observe this precaution could result in damage to the camera's internal circuitry.

Live view may end automatically to prevent damage to the camera's internal circuits; exit live view when the camera is not in use. Note that the temperature of the camera's internal circuits may rise and noise (bright spots, randomly-spaced bright pixels, or fog) may be displayed in the following instances (the camera may also become noticeably warm, but this does not indicate a malfunction):


- The ambient temperature is high
- The camera has been used for extended periods in live view or to record movies
- The camera has been used in continuous release mode for extended periods

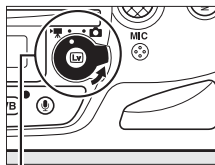
If live view does not start when you press the  button, wait for the internal circuits to cool and then try again.

Movie recording is not available during live view photography and pressing the movie-record button has no effect. Select movie live view (☐ 63) to shoot movies.

Movie Live View

Movies can be recorded in live view.

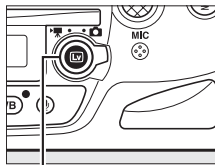
- 1 Rotate the live view selector to  (movie live view).



Live view selector

- 2 Press the  button.

The mirror will be raised and the view through the lens will be displayed in the camera monitor, modified for the effects of exposure. The subject will no longer be visible in the viewfinder.



Lv button

The Icon

A  icon (□ 67) indicates that movies can not be recorded.

Before Recording

Before recording, choose a color space (□ 305) and Picture Control (□ 177). White balance can be set at any time by pressing the **WB** button and rotating the main command dial (□ 155).

- 3 Choose a focus mode (□ 52).



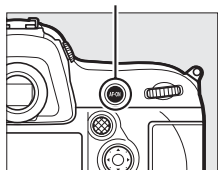
4 Choose an AF-area mode (53).



5 Focus.

Frame the opening shot and press the **AF-ON** button to focus. Note that the number of subjects that can be detected in face-priority AF drops in movie live view.

AF-ON button



Focusing in Movie Live View

Focus can also be adjusted by pressing the shutter-release button halfway before beginning recording.

Exposure Mode

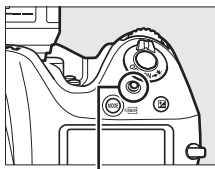
The following settings can be adjusted in movie live view:

	Aperture	Shutter speed	ISO sensitivity	Exposure compensation
<i>P, S</i>	—	—	—	✓
<i>A</i>	✓	—	—	✓
<i>M</i>	✓	✓	✓	—

In exposure mode *M*, shutter speed can be set to values between $1/25$ s and $1/8000$ s (the slowest available shutter speed varies with the frame rate; 74). In other exposure modes, shutter speed is adjusted automatically. If the subject is over- or under-exposed in mode *P* or *S*, end live view and start movie live view again or select exposure *A* and adjust aperture.

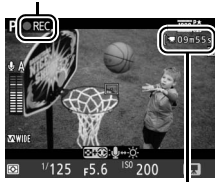
6 Start recording.

Press the movie-record button to start recording. A recording indicator and the time available are displayed in the monitor. Exposure is set using matrix metering and can be locked by pressing the center of the sub-selector (☐ 136) or altered by up to ± 3 EV using exposure compensation (☐ 138). In autofocus mode, the camera can be refocused by pressing the **AF-ON** button.



Movie-record button

Recording indicator



Time remaining

Audio

The camera can record both video and sound; do not cover the microphone on the front of the camera during movie recording. Note that the built-in microphone may record sounds made by the lens during autofocus, vibration reduction, or changes to aperture.

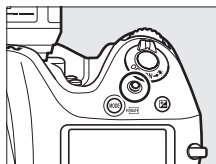
See Also

Frame size, frame rate, microphone sensitivity, card slot, and ISO sensitivity options are available in the **Movie settings** menu (☐ 74). Focus can be adjusted manually as described on page 59. The roles played by the center of the multi selector, the **Fn** and **Pv** buttons, and the center of the sub-selector can be chosen using Custom Settings f1 (**Multi selector center button**; ☐ 335), g1 (**Assign Fn button**; ☐ 353), g2 (**Assign preview button**; ☐ 355), and g3 (**Assign sub-selector center**; ☐ 356), respectively. Custom Setting g4 (**Assign shutter button**; ☐ 357) controls whether the shutter-release button can be used to start movie live view, or to start and end movie recording, or (when pressed all the way down) to take photographs during movie recording. For information on preventing unintended operation of the **[Lv]** button, see Custom Setting f17 (**Live view button options**; ☐ 349). See page 169 for information on measuring a value for preset white balance during live view photography and movie live view.



7 End recording.


Press the movie-record button again to end recording. Recording will end automatically when the maximum length is reached, or the memory card is full.

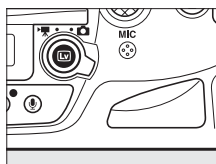


Maximum Length





The maximum length for individual movie files is 4 GB (for maximum recording times, see page 74); note that depending on memory card write speed, shooting may end before this length is reached.

8 Exit live view mode.

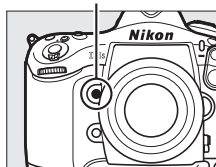
Press the  button to exit live view mode.



Indices

If **Index marking** is selected as the “press” option for Custom Setting g1 (**Assign Fn button**;  353), g2 (**Assign preview button**;  355), or g3 (**Assign sub-selector center**;  356), you can press the selected control during recording to add indices that can be used to locate frames during editing and playback ( 77). Up to 20 indices can be added to each movie.

Pv button



Index



The Live View Display: Movie Live View






Item	Description	
① Headphone volume	Volume of audio output to headphones.	68
② Microphone sensitivity	Microphone sensitivity for movie recording.	68
③ Sound level	Sound level for audio recording. Displayed in red if level is too high; adjust microphone sensitivity accordingly. Left (L) and right (R) channel indicators appear when optional ME-1 or other stereo microphone is used.	68
④ Frequency response	Display the option selected for Movie settings > Frequency response in the shooting menu.	75
⑤ Wind noise reduction	Displayed when On is selected for Movie settings > Wind noise reduction in the shooting menu.	75
⑥ “No movie” icon	Indicates that movies can not be recorded.	—
⑦ Movie frame size	The frame size for movie recording.	74
⑧ Time remaining (movie live view)	The recording time available for movies.	65
⑨ Monitor brightness indicator	A monitor brightness indicator.	68
⑩ Guide	A guide to the options available during movie live view.	68

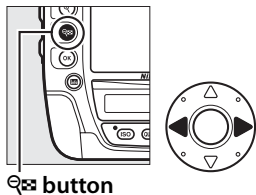


■ Adjusting Settings in the Live View Display




Microphone sensitivity, headphone volume, and monitor brightness can be adjusted as described below. Note that headphone volume can not be adjusted during recording, and that brightness affects the monitor only (☞ 57); pictures recorded with the camera are unaffected. If an option other than  (microphone off) is currently selected, microphone sensitivity can be changed to any setting other than  while recording is in progress.

1 Highlight a setting.

Press and hold  and press  or  to highlight the indicator for the desired setting.



2 Adjust the highlighted setting.

Keeping the  button pressed, press  or  to adjust the highlighted setting.



Headphones

Third-party headphones can be used. Note that high sound levels may result in high volume; particular care should be taken when headphones are used.

The Count-Down Display

A count down will be displayed 30 s before live view ends automatically (☞ 55). Depending on shooting conditions, the timer may appear immediately when movie recording begins. Note that regardless of the amount of recording time available, live view will still end automatically when the timer expires. Wait for the internal circuits to cool before resuming movie recording.

The Information Display: Movie Live View

To hide or display indicators in the monitor during movie live view, press the **info** button.

Virtual horizon
(372)



Information on



Information off



Histogram




Framing guides

HDMI

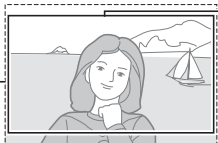
If the camera is connected to an HDMI device (285), the view through the lens will appear both in the camera monitor and on the HDMI device.

Image Area

Regardless of the option selected for **Image area** in the shooting menu (☐ 88), all movies and photographs recorded in movie live view have an aspect ratio of 16 : 9 (or 3 : 2 when the movie frame size is 640 × 424). Movies recorded with an FX-format lens and **FX (36×24) 1.0×, 1.2× (30×20) 1.2×, or 5 : 4 (30×24)** selected for **Image area** are recorded in a format referred to as “FX-based movie format”, while “DX-based movie format” is used for those recorded with a DX-format lens and **Auto DX crop** (☐ 86) selected for **Image area**, or with a DX- or FX-format lens and **DX (24×16) 1.5×** selected for **Image area**. The differences between the crops displayed during viewfinder and live view photography and movie live view photo crop are shown below.



Crop for viewfinder
and live view
photography



16 : 9 photo crop for
movie live view

Crop for viewfinder
and live view
photography



3 : 2 photo crop for
movie live view

The approximate size of the area at the center of the image sensor used to record photographs taken in movie live view is 35.7 × 20.1 mm (16 : 9, FX-based movie format), 23.3 × 13.0 mm (16 : 9, DX-based movie format), 35.7 × 23.8 mm (3 : 2, FX-based movie format), or 23.3 × 15.4 mm (3 : 2, DX-based movie format).

Taking Photos During Movie Live View

If **Take photos** is selected for Custom Setting g4 (**Assign shutter button**, □ 357), photographs can be taken at any time during movie live view by pressing the shutter-release button all the way down. If movie recording is in progress, recording will end and the footage recorded to that point will be saved. Except when a “1920 × 1080 crop” option is selected for **Frame size/frame rate** in the **Movie settings** menu, photographs are recorded in the format selected for **Image quality** in the shooting menu (□ 90). Photographs taken when a “1920 × 1080 crop” option is selected are recorded as fine-quality JPEG images. For information on image size, see page 72. Note that the exposure for photographs can not be previewed during movie live view; mode **P**, **S**, or **A** is recommended but accurate results can be achieved in mode **M** by adjusting exposure during live view photography (□ 49) and then ending live view photography, starting movie live view, and checking the image area.



Wireless Remote Controllers and Remote Cords

If **Record movies** is selected for Custom Setting g4 (**Assign shutter button**), the shutter-release buttons on optional wireless remote controllers and remote cords (□ 411, 412) can be used to start movie live view and to start and end movie recording (□ 357).

Image Size

The following table shows the size of photographs (aspect ratio 16 : 9) taken in movie live view at frame sizes other than 640 × 424:

Image area	Option	Size (pixels)	Print size (cm/in.)*
FX-based format (16 : 9)	Large	4928 × 2768	41.7 × 23.4/16.4 × 9.2
	Medium	3696 × 2072	31.3 × 17.5/12.3 × 6.9
	Small	2464 × 1384	20.9 × 11.7/ 8.2 × 4.6
DX-based format (16 : 9)	Large	3200 × 1792	27.1 × 15.2/10.7 × 6.0
	Medium	2400 × 1344	20.3 × 11.4/ 8.0 × 4.5
	Small	1600 × 896	13.5 × 7.6/ 5.3 × 3.0
1920 × 1080; 30p/ 25p/24p crop	—	1920 × 1080	16.3 × 9.1/ 6.4 × 3.6

The following table shows the size of photographs (aspect ratio 3 : 2) taken in movie live view at frame sizes of 640 × 424:

Image area	Option	Size (pixels)	Print size (cm/in.)*
FX-based movie format (3 : 2)	Large	4928 × 3280	41.7 × 27.8/16.4 × 10.9
	Medium	3696 × 2456	31.3 × 20.8/12.3 × 8.2
	Small	2464 × 1640	20.9 × 13.9/ 8.2 × 5.5
DX-based movie format (3 : 2)	Large	3200 × 2128	27.1 × 18.0/10.7 × 7.1
	Medium	2400 × 1592	20.3 × 13.5/ 8.0 × 5.3
	Small	1600 × 1064	13.5 × 9.0/ 5.3 × 3.5

* Approximate size when printed at 300 dpi. Print size in inches equals image size in pixels divided by printer resolution in dots per inch (dpi); 1 inch = approximately 2.54 cm).

Metering Exposure and White Balance

The area used for metering exposure or auto white balance when photographs are recorded at a movie frame size of **1920 × 1080; 30p crop**, **1920 × 1080; 25p crop**, or **1920 × 1080; 24p crop** (□ 74) is not the same as the area in the final photograph, with the result that optimal results may not be achieved. Take test shots and check the results in the monitor.

Recording Movies


Flicker, banding, or distortion may be visible in the monitor and in the final movie under fluorescent, mercury vapor, or sodium lamps or if the camera is panned horizontally or an object moves at high speed through frame (for information on reducing flicker and banding, see **Flicker reduction**, □ 363). Jagged edges, color fringing, moiré, and bright spots may also appear. Bright bands may appear in some areas of the frame with flashing signs and other intermittent light sources or if the subject is briefly illuminated by a strobe or other bright, momentary light source. When recording movies, avoid pointing the camera at the sun or other strong light sources. Failure to observe this precaution could result in damage to the camera's internal circuitry. Note that noise (randomly-spaced bright pixels, fog, or lines) and unexpected colors may appear if you zoom in on the view through the lens (□ 59) during movie live view.

Flash lighting can not be used during movie live view.

Recording ends automatically if the lens is removed or the live view selector is rotated to a new setting.

Live view may end automatically to prevent damage to the camera's internal circuits; exit live view when the camera is not in use. Note that the temperature of the camera's internal circuits may rise and noise (bright spots, randomly-spaced bright pixels, or fog) may be displayed in the following instances (the camera may also become noticeably warm, but this does not indicate a malfunction):

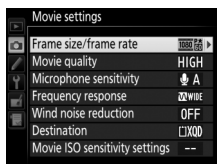
- The ambient temperature is high
- The camera has been used for extended periods in live view or to record movies
- The camera has been used in continuous release mode for extended periods

If live view does not start when you press the  button, wait for the internal circuits to cool and then try again.



Movie Settings

Use the **Movie settings** option in the shooting menu (☐ 299) to adjust the following settings.



- **Frame size/frame rate, Movie quality:** Choose from the following options:

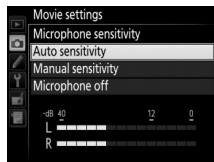
Option ¹	Maximum bit rate (Mbps) (★ high quality/Normal)	Maximum length (★ high quality/Normal)
1920 × 1080; 60p²	42/24	10 min./20 min.
1920 × 1080; 50p²		
1920 × 1080; 30p²	24/12	20 min./ 29 min. 59 s
1920 × 1080; 25p²		
1920 × 1080; 24p²		
1280 × 720; 60p		
1280 × 720; 50p		
640 × 424; 30p	8/5	29 min. 59 s/ 29 min. 59 s
640 × 424; 25p		
1920 × 1080; 30p crop³	24/12	20 min./ 29 min. 59 s
1920 × 1080; 25p crop³		
1920 × 1080; 24p crop³		

- 1 Actual frame rate is 29.97 fps for values listed as 30p, 23.976 fps for values listed as 24p, and 59.94 fps for values listed as 60p.
- 2 In DX-based movie format, image quality is equivalent to movies recorded at a frame size of 1280 × 720.
- 3 Matrix metering selected automatically. Picture angle equivalent to a focal length 2.7× FX-based movie format length, allowing a telephoto effect without changing to a longer lens; is displayed in the monitor. HDR is not available with photos taken in this mode (☐ 190).

Frame Size and Rate

Frame size and rate affects the distribution and amount of noise (randomly-spaced bright pixels, fog, or bright spots).

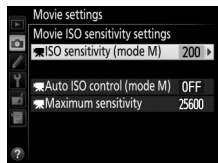
- **Microphone sensitivity:** Turn the built-in or optional stereo microphones (📖 413) on or off or adjust microphone sensitivity. Choose **Auto sensitivity** to adjust sensitivity automatically, **Microphone off** to turn sound recording off; to select microphone sensitivity manually, select **Manual sensitivity** and choose a sensitivity.
- **Frequency response:** If **WIDE Wide range** is selected, the built-in microphone and optional stereo microphones (📖 413) will respond to a wide range of frequencies, from music to the bustling hum of a city street. Choose **VOICE Vocal range** to bring out human voices.
- **Wind noise reduction:** Select **On** to enable the low-cut filter for the built-in microphone (optional stereo microphones are unaffected), reducing noise produced by wind blowing over the microphone (note that other sounds may also be affected). Wind-noise reduction for optional stereo microphones can be enabled or disabled using microphone controls.
- **Destination:** Choose the slot to which movies are recorded. The menu shows the time available on each card; recording ends automatically when no time remains. Note that regardless of the option selected, photographs are recorded to the card in the primary slot (📖 96).



Using an External Microphone

The optional ME-1 stereo microphone can be used to record sound in stereo or to avoid recording lens noise caused by autofocus (📖 413).


- **Movie ISO sensitivity settings:** Adjust the following ISO sensitivity settings.
 - **ISO sensitivity (mode M):** Choose the ISO sensitivity for exposure mode **M** from values between ISO 200 and Hi 4. Auto ISO sensitivity control is used in other exposure modes.
 - **Auto ISO control (mode M):** Select **On** for auto ISO sensitivity control in exposure mode **M**, **Off** to use the value selected for **ISO sensitivity (mode M)**.
 - **Maximum sensitivity:** Choose the upper limit for auto ISO sensitivity control from values between ISO 400 and Hi 4. The lower limit is ISO 200. Auto ISO sensitivity control is used in exposure modes **P**, **S**, and **A** and when **On** is selected for **Auto ISO control (mode M)** in exposure mode **M**.

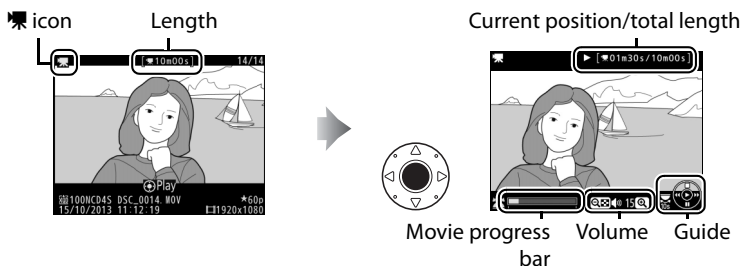


Auto ISO Sensitivity Control







At high ISO sensitivities, the camera may have difficulty focusing and noise (randomly-spaced bright pixels, fog, or lines) may increase. This can be prevented by choosing a lower value for **Movie ISO sensitivity settings** > **Maximum sensitivity**.

Viewing Movies








Movies are indicated by a  icon in full-frame playback (241). Press the center of the multi selector to start playback; your current position is indicated by the movie progress bar.



The following operations can be performed:



To	Use	Description
Pause		Pause playback.
Play		Resume playback when movie is paused or during rewind/advance.
Rewind/advance		Speed increases with each press, from 2× to 4× to 8× to 16×; keep pressed to skip to beginning or end of movie (first frame is indicated by  in top right corner of monitor, last frame by ). If playback is paused, movie rewinds or advances one frame at a time; hold for continuous rewind or advance.
Skip 10 s		Rotate the main command dial to skip ahead or back 10 s.



To	Use	Description
Skip ahead/ back		Rotate the sub-command dial to skip to next or previous index, or to skip to the last or first frame if the movie contains no indices.
Adjust volume		Press  to increase volume,  to decrease.
Trim movie		See page 79 for more information.
Exit		Exit to full-frame playback.
Return to shooting mode		Press the shutter-release button halfway to exit to shooting mode.




The Icon

Movies with indices ( 66) are indicated by a  icon in full-frame playback.





The Icon

 is displayed in full-frame and movie playback if the movie was recorded without sound.



Editing Movies

Trim footage to create edited copies of movies or save selected frames as JPEG stills.

Option	Description
 Choose start/end point	Create a copy from which the opening or closing footage has been removed.
 Save selected frame	Save a selected frame as a JPEG still.

Trimming Movies

To create trimmed copies of movies:

1 Display a movie full frame (📖 241).

2 Pause the movie on the new opening or closing frame.

Play the movie back as described on page 77, pressing the center of the multi selector to start and resume playback and ▼ to pause and pressing ◀

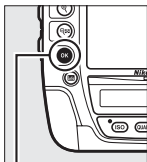
or ▶ or rotating the main or sub-command dials to locate the desired frame. Your approximate position in the movie can be ascertained from the movie progress bar. Pause playback when you reach the new opening or closing frame.



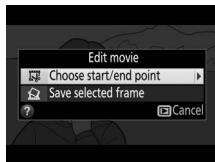
Movie progress bar

3 Select **Choose start/end point**.

Press **OK**, then highlight **Choose start/end point** and press ▶.

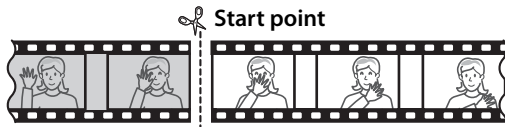
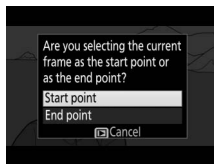


OK button

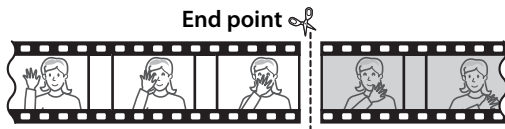


4 Choose the current frame as the new start or end point.

To create a copy that begins from the current frame, highlight **Start point** and press **OK**. The frames before the current frame will be removed when you save the copy.



To create a copy that ends at the current frame, highlight **End point** and press **OK**. The frames after the current frame will be removed when you save the copy.



5 Confirm the new start or end point.

If the desired frame is not currently displayed, press **◀** or **▶** to advance or rewind (to skip to 10 s ahead or back, rotate the main command dial; to skip to an index, or to the first or last frame if the movie contains no indices, rotate the sub-command dial).



6 Create the copy.

Once the desired frame is displayed, press ▲.

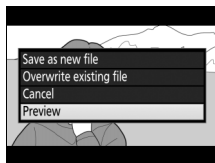


7 Preview the movie.

To preview the copy, highlight

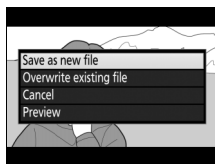
Preview and press OK (to interrupt the preview and return to the save options

menu, press ▲). To abandon the current copy and return to Step 5, highlight **Cancel** and press OK; to save the copy, proceed to Step 8.



8 Save the copy.

Highlight **Save as new file** and press OK to save the copy to a new file. To replace the original movie file with the edited copy, highlight **Overwrite existing file** and press OK.




Trimming Movies


Movies must be at least two seconds long. The copy will not be saved if there is insufficient space available on the memory card.

Copies have the same time and date of creation as the original.

Choosing the Role of the Current Frame

To make the frame displayed in Step 5 the new end point (⏪) instead of the new start point (⏩) or vice versa, press the  button.



 button



Saving Selected Frames

To save a copy of a selected frame as a JPEG still:

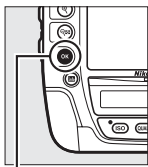
1 Pause the movie on the desired frame.

Play the movie back as described on page 77, pressing the center of the multi selector to start and resume playback and ▼ to pause. Pause the movie at the frame you intend to copy.

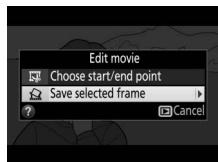


2 Choose Save selected frame.

Press **OK**, then highlight **Save selected frame** and press ►.



OK button



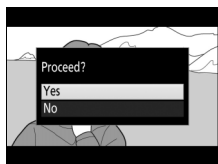
3 Create a still copy.

Press ▲ to create a still copy of the current frame.



4 Save the copy.

Highlight **Yes** and press **OK** to create a fine-quality (90) JPEG copy of the selected frame.



Save Selected Frame

JPEG movie stills created with the **Save selected frame** option can not be retouched. JPEG movie stills lack some categories of photo information (📖 244).

The Retouch Menu

Movies can also be edited using the **Edit movie** option in the retouch menu (📖 375).

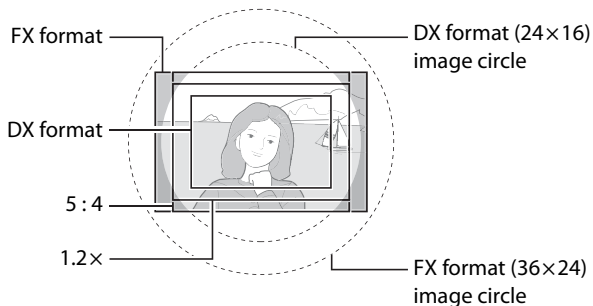




Image Recording Options





Image Area

Choose from image areas of **FX (36 × 24) 1.0×** (FX format), **DX (24 × 16) 1.5×** (DX format), **5 : 4 (30 × 24)**, and **1.2× (30 × 20) 1.2×**. See page 464 for information on the number of pictures that can be stored at different image area settings.



■ ■ Image Area Options

The camera offers a choice of the following image areas:

Option	Description
 FX (36×24) 1.0× (FX format)	Images are recorded in FX format using the full area of the image sensor (36.0 × 23.9 mm), producing an angle of view equivalent to a NIKKOR lens on a 35 mm format camera.
 1.2× (30×20) 1.2×	A 29.9 × 19.9 mm area at the center of the image sensor is used to record photographs. To calculate the approximate focal length of the lens in 35 mm format, multiply by 1.2.
 DX (24×16) 1.5× (DX format)	An area at the center of the image sensor 23.4 × 15.5 mm is used to record pictures in DX format. To calculate the approximate focal length of the lens in 35 mm format, multiply by 1.5.
 5 : 4 (30×24)	Pictures are recorded with an aspect ratio of 5 : 4 (29.9 × 23.9 mm).

■ ■ Automatic Crop Selection

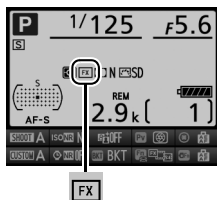
To automatically select to a DX crop when a DX lens is attached, select **On** for **Image area > Auto DX crop** in the shooting menu (☞ 299). The image area selected in the shooting menu or with the camera controls will be used only when a non-DX lens is attached. Select **Off** to use the currently-selected image area with all lenses.

Auto DX Crop

The controls listed on page 89 can not be used to select image area when a DX lens is attached and **Auto DX crop** is on.

Image Area

The selected option is shown in the information display.



DX Lenses

DX lenses are designed for use with DX format cameras and have a smaller angle of view than lenses for 35 mm format cameras. If **Auto DX crop** is off and an option other than **DX (24×16)** (DX format) is selected for **Image area** when a DX lens is attached, the edges of the image may be eclipsed. This may not be apparent in the viewfinder, but when the images are played back you may notice a drop in resolution or that the edges of the picture are blacked out.

The Viewfinder Display

The 1.2×, DX format, and 5 : 4 crops are shown below.



1.2×



DX format



5 : 4

See Also

See page 70 for information on the crops available in movie live view.



The image area can be selected using the **Image area > Choose image area** option in the shooting menu or by pressing a control and rotating a command dial.

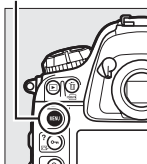
■ The Image Area Menu

1 Select Image area in the shooting menu.

Press the **MENU** button to display the menus.

Highlight **Image area** in the shooting menu and press **▶**.

MENU button



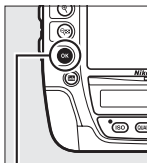
2 Select Choose image area.

Highlight **Choose image area** and press **▶**.



3 Adjust settings.

Choose an option and press **OK**. The selected crop is displayed in the viewfinder (87).



OK button

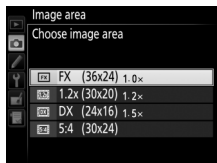


Image Size

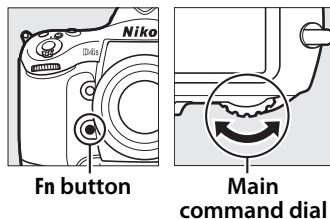
Image size varies with the option selected for image area.

- 1 Assign image area selection to a camera control.**

Select **Choose image area** as the “press + command dials” option for a camera control in the Custom Settings menu (☐ 341). Image area selection can be assigned to the **Fn** button (Custom Setting f3, **Assign Fn button**, ☐ 337), the **Pv** button (Custom Setting f4, **Assign preview button**, ☐ 342), the center of the sub-selector (Custom Setting f6, **Assign sub-selector center**, ☐ 342), or the movie-record button (Custom Setting f16, **Assign movie record button**, ☐ 349).

- 2 Use the selected control to choose an image area.**

The image area can be selected by pressing the selected control and rotating the main or sub-command dial until the desired crop is displayed in the viewfinder (☐ 87).



The option currently selected for image area can be viewed by pressing the control to display the image area in the top control panel or information display. FX format is displayed as “36 × 24”, 1.2 × as “30 × 20”, DX format as “24 × 16”, and 5 : 4 as “30 × 24”.

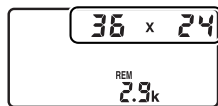


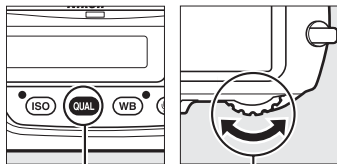
Image Quality

The D4S supports the following image quality options. See page 464 for information on the number of pictures that can be stored at different image quality and size settings.

Option	File type	Description
NEF (RAW)	NEF	RAW data from the image sensor are saved without additional processing. Settings such as white balance and contrast can be adjusted after shooting.
TIFF (RGB)	TIFF (RGB)	Record uncompressed TIFF-RGB images at a bit depth of 8 bits per channel (24-bit color). TIFF is supported by a wide variety of imaging applications.
JPEG fine	JPEG	Record JPEG images at a compression ratio of roughly 1:4 (fine quality).*
JPEG normal		Record JPEG images at a compression ratio of roughly 1:8 (normal quality).*
JPEG basic		Record JPEG images at a compression ratio of roughly 1:16 (basic quality).*
NEF (RAW)+ JPEG fine	NEF/ JPEG	Two images are recorded, one NEF (RAW) image and one fine-quality JPEG image.
NEF (RAW)+ JPEG normal		Two images are recorded, one NEF (RAW) image and one normal-quality JPEG image.
NEF (RAW)+ JPEG basic		Two images are recorded, one NEF (RAW) image and one basic-quality JPEG image.

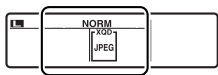
* **Size priority** selected for **JPEG/TIFF recording** > **JPEG compression**.

Image quality is set by pressing the **QUAL** button and rotating the main command dial until the desired setting is displayed in the rear control panel.





QUAL button

Main command dial



Rear control panel


NEF (RAW) Images

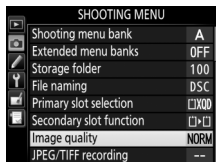
NEF (RAW) images can be viewed on the camera or using software such as Capture NX 2 (available separately;  411) or ViewNX 2 (available on the supplied ViewNX 2 installer CD). JPEG copies of NEF (RAW) images can be created using the **NEF (RAW) processing** option in the retouch menu ( 387).

NEF+JPEG

When photographs taken at settings of NEF (RAW) + JPEG are viewed on the camera with only one memory card inserted, only the JPEG image will be displayed. If both copies are recorded to the same memory card, both copies will be erased when the photo is deleted. If the JPEG copy is recorded to a separate memory card using the **Secondary slot function > RAW primary - JPEG secondary** option, deleting the JPEG copy will not delete the NEF (RAW) image.

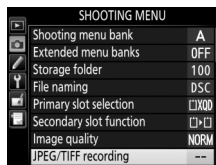
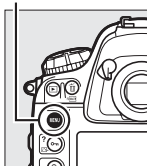
The Image Quality Menu

Image quality can also be adjusted using the **Image quality** option in the shooting menu ( 299).



The following options can be accessed from the shooting menu. Press the **MENU** button to display the menus, highlight the desired option and press **▶**.

MENU button



■■ JPEG/TIFF Recording > JPEG Compression

Choose the type of compression for JPEG images.

Option	Description
Size priority	Images are compressed to produce relatively uniform file size.
Optimal quality	Optimal image quality. File size varies with scene recorded.

■■ NEF (RAW) Recording > NEF (RAW) Compression


Choose the type of compression for NEF (RAW) images.

Option	Description
Lossless compressed	NEF images are compressed using a reversible algorithm, reducing file size by about 20–40% with no effect on image quality.
Compressed	NEF images are compressed using a non-reversible algorithm, reducing file size by about 35–55% with almost no effect on image quality.
Uncompressed	NEF images are not compressed.

■■ NEF (RAW) Recording > NEF (RAW) Bit Depth

Choose a bit depth for NEF (RAW) images.

Option	Description
12-bit 12-bit	NEF (RAW) images are recorded at a bit-depth of 12 bits.
14-bit 14-bit	NEF (RAW) images are recorded at a bit depth of 14 bits, producing files larger than those with a bit depth of 12 bits but increasing the color data recorded.

 **See Also**

See page 94 for the image size options available for JPEG and TIFF images, page 95 for the image size options available for NEF (RAW) images.



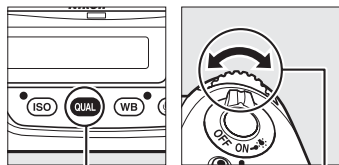
Image Size

Image size is measured in pixels. In the case of JPEG and TIFF images, you can choose from **L**Large, **M**Medium, or **S**Small (note that image size varies depending on the option selected for **Image area**, **85**):

Image area	Option	Size (pixels)	Print size (cm/in.)*
FX (36×24) 1.0× (FX format)	Large	4928 × 3280	41.7 × 27.8/16.4 × 10.9
	Medium	3696 × 2456	31.3 × 20.8/12.3 × 8.2
	Small	2464 × 1640	20.9 × 13.9/ 8.2 × 5.5
1.2× (30×20) 1.2×	Large	4096 × 2720	34.7 × 23.0/13.7 × 9.1
	Medium	3072 × 2040	26.0 × 17.3/10.2 × 6.8
	Small	2048 × 1360	17.3 × 11.5/ 6.8 × 4.5
DX (24×16) 1.5× (DX format)	Large	3200 × 2128	27.1 × 18.0/10.7 × 7.1
	Medium	2400 × 1592	20.3 × 13.5/ 8.0 × 5.3
	Small	1600 × 1064	13.5 × 9.0/ 5.3 × 3.5
5 : 4 (30×24)	Large	4096 × 3280	34.7 × 27.8/13.7 × 10.9
	Medium	3072 × 2456	26.0 × 20.8/10.2 × 8.2
	Small	2048 × 1640	17.3 × 13.9/ 6.8 × 5.5

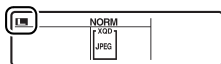
* Approximate size when printed at 300 dpi. Print size in inches equals image size in pixels divided by printer resolution in dots per inch (dpi; 1 inch = approximately 2.54 cm).

Image size for JPEG and TIFF images can be set by pressing the **QUAL** button and rotating the sub-command dial until the desired option is displayed in the rear control panel.



QUAL button

Sub-command dial



Rear control panel

The Image Size Menu

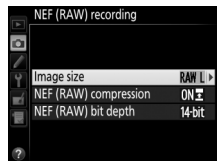
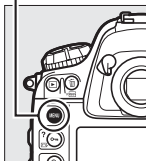
Image size for JPEG and TIFF images can also be adjusted using the **JPEG/TIFF recording** > **Image size** option in the shooting menu (☰ 304).



■■ NEF (RAW) Images

When recording photographs in NEF (RAW) format, you can choose from sizes of **RAW L Large** and **RAW S Small** using the **NEF (RAW) recording** > **Image size** option in the shooting menu. Small-size images are about half the size of their large-size counterparts. An asterisk (*) appears in the rear control panel when **RAW S Small** is selected.

MENU button



Rear control panel

NEF (RAW) Images

Image size for NEF (RAW) photographs can not be selected using the **QUAL** button and command dials. Small-size NEF (RAW) images are recorded in uncompressed 12-bit format, regardless of the options selected for **NEF (RAW) compression** and **NEF (RAW) bit depth** in the **NEF (RAW) recording** sub-menu, and can not be retouched (☰ 375).

Using Two Memory Cards

When two memory cards are inserted in the camera, you can choose one as the primary card using the **Primary slot selection** item in the shooting menu. Select **XQD card slot** to designate the card in the XQD card slot as the primary card, **CF card slot** to choose the CompactFlash card. The roles played by the primary and secondary cards can be chosen using the **Secondary slot function** option in the shooting menu. Choose from **Overflow** (the secondary card is used only when the primary card is full), **Backup** (each picture is recorded to both the primary and secondary card), and **RAW primary - JPEG secondary** (as for **Backup**, except that the NEF/RAW copies of photos recorded at settings of NEF/RAW + JPEG are recorded only to the primary card and the JPEG copies only to the secondary card).



“Backup” and “RAW Primary - JPEG Secondary”

The camera shows the number of exposures remaining on the card with the least amount of memory. Shutter release will be disabled when either card is full. Voice memos (🗨 261) are appended to the copy recorded to the memory card in the primary slot.

Recording Movies

When two memory cards are inserted in the camera, the slot used to record movies can be selected using the **Movie settings > Destination** option in the shooting menu (🗨 75).

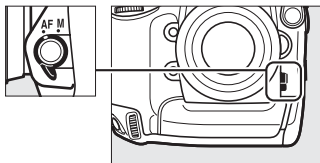
Focus

This section describes the focus options available when photographs are framed in the viewfinder. Focus can be adjusted automatically (see below) or manually (▢ 108). The user can also select the focus point for automatic or manual focus (▢ 103) or use focus lock to focus to recompose photographs after focusing (▢ 105).

Autofocus

To use autofocus, rotate the focus-mode selector to **AF**.

Focus-mode selector

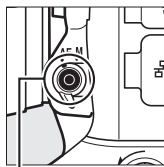


Autofocus Mode

Choose from the following autofocus modes:

Mode	Description
AF-S	Single-servo AF: For stationary subjects. Focus locks when shutter-release button is pressed halfway. At default settings, shutter can only be released when in-focus indicator (●) is displayed (<i>focus priority</i> ; ▢ 314).
AF-C	Continuous-servo AF: For moving subjects. Camera focuses continuously while shutter-release button is pressed halfway; if subject moves, camera will engage <i>predictive focus tracking</i> (▢ 99) to predict final distance to subject and adjust focus as necessary. At default settings, shutter can be released whether or not subject is in focus (<i>release priority</i> ; ▢ 313).

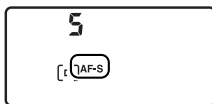
Autofocus mode can be selected by pressing the AF-mode button and rotating the main command dial until the desired setting is displayed in the viewfinder and top control panel.



AF-mode button



Main command dial



Top control panel




Viewfinder

See Also

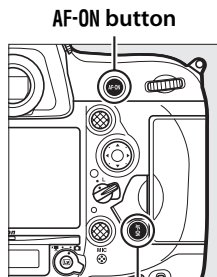
For information on using focus priority in continuous-servo AF, see Custom Setting a1 (**AF-C priority selection**, [□ 313](#)). For information on using release priority in single-servo AF, see Custom Setting a2 (**AF-S priority selection**, [□ 314](#)). For information on preventing the camera from focusing when the shutter-release button is pressed halfway, see Custom Setting a4 (**AF activation**, [□ 315](#)). See Custom Setting a12 (**Autofocus mode restrictions**, [□ 320](#)) for information on limiting focus-mode selection to **AF-S** or **AF-C** and f10 (**Customize command dials**) > **Change main/sub** ([□ 345](#)) for information on using the sub-command dial to choose the focus mode. See page 52 for information on the autofocus options available in live view or during movie recording.

The AF-ON Buttons

For the purpose of focusing the camera, pressing either of the **AF-ON** buttons has the same effect as pressing the shutter-release button halfway (note that the **AF-ON** button for vertical shooting can only be used when the vertical shooting shutter-release button lock is unlocked;  42).

Predictive Focus Tracking

In **AF-C** mode, the camera will initiate predictive focus tracking if the subject moves toward or away from the camera while the shutter-release button is pressed halfway or either of the **AF-ON** buttons is pressed. This allows the camera to track focus while attempting to predict where the subject will be when the shutter is released.



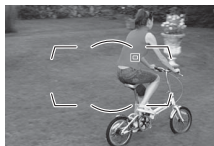
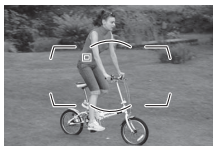
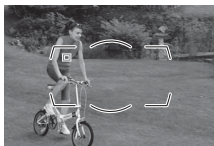
AF-ON button for vertical shooting



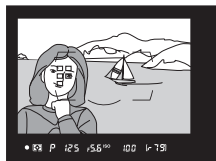
AF-Area Mode

Choose how the focus point for autofocus is selected.

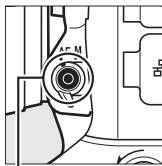
- **Single-point AF:** Select the focus point as described on page 103; the camera will focus on the subject in the selected focus point only. Use with stationary subjects.
- **Dynamic-area AF:** Select the focus point as described on page 103. In **AF-C** focus mode, the camera will focus based on information from surrounding focus points if the subject briefly leaves the selected point. The number of focus points varies with the mode selected:
 - **9-point dynamic-area AF:** Choose when there is time to compose the photograph or when photographing subjects that are moving predictably (e.g., runners or race cars on a track).
 - **21-point dynamic-area AF:** Choose when photographing subjects that are moving unpredictably (e.g., players at a football game).
 - **51-point dynamic-area AF:** Choose when photographing subjects that are moving quickly and can not be easily framed in the viewfinder (e.g., birds).
- **3D-tracking:** Select the focus point as described on page 103. In **AF-C** focus mode, the camera will track subjects that leave the selected focus point and select new focus points as required. Use to quickly compose pictures with subjects that are moving erratically from side to side (e.g., tennis players). If the subject leaves viewfinder, remove your finger from the shutter-release button and recompose the photograph with the subject in the selected focus point.



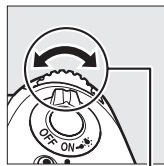
- **Group-area AF:** The camera focuses using a group of focus points selected by the user, reducing the risk of the camera focusing on the background instead of on the main subject. Choose for subjects that are difficult to photograph using a single focus point. If faces are detected in **AF-S** focus mode, the camera will give priority to portrait subjects.
- **Auto-area AF:** The camera automatically detects the subject and selects the focus point; if a face is detected, the camera will give priority to the portrait subject. The active focus points are highlighted briefly after the camera focuses; in **AF-C** mode, the main focus point remains highlighted after the other focus points have turned off.



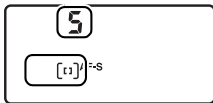
AF-area mode can be selected by pressing the AF-mode button and rotating the sub-command dial until the desired setting is displayed in the viewfinder and top control panel.



AF-mode button



Sub-command dial



Top control panel



Viewfinder

3D-tracking

When the shutter-release button is pressed halfway, the colors in the area surrounding the focus point are stored in the camera. Consequently 3D-tracking may not produce the desired results with subjects that are similar in color to the background or that occupy a very small area of the frame.

AF-Area Mode

AF-area mode is shown in the top control panel and viewfinder.






AF-area mode	Top control panel	Viewfinder	AF-area mode	Top control panel	Viewfinder
Single-point AF	S	S	3D-tracking	3d	3d
9-point dynamic-area AF*	d 9	d 9	Group-area AF	GrP	GrP
21-point dynamic-area AF*	d21	d21	Auto-area AF	Auto	Auto
51-point dynamic-area AF*	d51	d51			

* Only active focus point is displayed in the viewfinder. Remaining focus points provide information to assist focus operation.

Manual Focus

Single-point AF is automatically selected when manual focus is used.

See Also

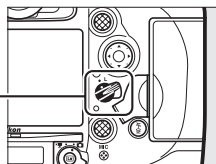
For information on adjusting how long the camera waits before refocusing when an object moves in front of the camera, see Custom Setting a3 (**Focus tracking with lock-on**,  314). See Custom Setting a5 (**Focus point illumination**,  315) for information on choosing how the focus point is displayed in dynamic-area and group-area AF, a10 (**Store by orientation**,  319) for information on choosing different focus points and/or AF-area modes for portrait- and landscape-orientation photographs, a11 (**Limit AF-area mode selection**,  320) for information on limiting AF-area mode selection, and f10 (**Customize command dials**) > **Change main/sub** ( 345) for information on using the main command dial to choose the AF-area mode. See page 53 for information on the autofocus options available in live view or during movie recording.

Focus Point Selection

The camera offers a choice of 51 focus points that can be used to compose photographs with the main subject positioned almost anywhere in the frame. Follow the steps below to choose the focus point (in group-area AF, you can follow these steps to choose a group of focus points).

1 Rotate the focus selector lock to ●.

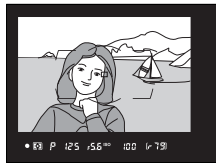
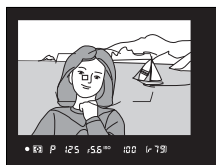
This allows the multi selector to be used to select the focus point.



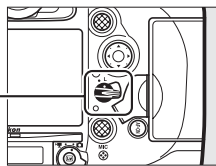
Focus selector lock

2 Select the focus point.

Use the multi selector to select the focus point in the viewfinder while the exposure meters are on. The center focus point can be selected by pressing the center of the multi selector.



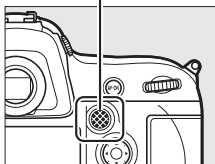
The focus selector lock can be rotated to the locked (L) position following selection to prevent the selected focus point from changing when the multi selector is pressed.



The Sub-selector

The sub-selector can be used in place of the multi selector to select the focus point. Press the center of the sub-selector to lock exposure (☐ 136) and focus (☐ 105). Be careful not to put your fingers or fingernails in your eye when using the sub-selector.

Sub-selector



Portrait (Tall-Orientation) Photographs

When framing shots in portrait (“tall”) orientation, use the multi selector for vertical shooting to select the focus point. For more information, see Custom Setting f14 (**Assign multi selector (vert.)**, ☐ 348).

Using the Sub-selector and Multi Selector for Vertical Shooting

Use as shown at right. Pressing the sides may not have the desired effect.



Auto-area AF

The focus point for auto-area AF is selected automatically; manual focus-point selection is not available.

See Also

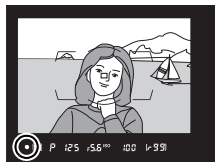
For information on choosing when the focus point is illuminated, see Custom Setting a5 (**Focus point illumination**, ☐ 315). For information on setting focus-point selection to “wrap around,” see Custom Setting a6 (**Focus point wrap-around**, ☐ 316). For information on choosing the number of focus points that can be selected using the multi selector, see Custom Setting a7 (**Number of focus points**, ☐ 316). For information on choosing separate focus points and/or AF-area modes for vertical and horizontal orientations, see Custom Setting a10 (**Store by orientation**, ☐ 319). For information on changing the role of the multi selector center button, see Custom Setting f1 (**Multi selector center button**, ☐ 335). For information on changing the role played by the sub-selector, see Custom Settings f5 (**Assign sub-selector**, ☐ 342) and f6 (**Assign sub-selector center**, ☐ 342).

Focus Lock

Focus lock can be used to change the composition after focusing, making it possible to focus on a subject that will not be in a focus point in the final composition. If the camera is unable to focus using autofocus (☐ 107), focus lock can also be used to recompose the photograph after focusing on another object at the same distance as your original subject. Focus lock is most effective when an option other than auto-area AF is selected for AF-area mode (☐ 100).

1 Focus.

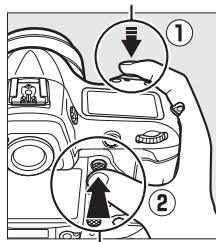
Position the subject in the selected focus point and press the shutter-release button halfway to initiate focus. Check that the in-focus indicator (●) appears in the viewfinder.



2 Lock focus.

AF-C focus mode (☐ 97): With the shutter-release button pressed halfway (①), press the center of the sub-selector (②) to lock both focus and exposure (an **AE-L** icon will be displayed in the viewfinder). Focus will remain locked while the center of the sub-selector is pressed, even if you later remove your finger from the shutter-release button.

Shutter-release button



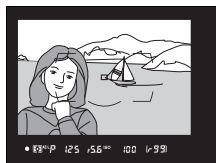
Center of sub-selector



AF-S focus mode: Focus locks automatically when the in-focus indicator (●) appears, and remain locked until you remove your finger from the shutter-release button. Focus can also be locked by pressing the center of the sub-selector (see above).

3 Recompose the photograph and shoot.

Focus will remain locked between shots if you keep the shutter-release button pressed halfway (**AF-S**) or keep the center of the sub-selector pressed, allowing several photographs in succession to be taken at the same focus setting.



Do not change the distance between the camera and the subject while focus lock is in effect. If the subject moves, focus again at the new distance.



Locking Focus with the AF-ON Button

During viewfinder photography, focus can be locked using either of the **AF-ON** buttons in place of the shutter-release button (□ 99). If **AF-ON only** is selected for Custom Setting a4 (**AF activation**, □ 315), the camera will not focus when the shutter-release button is pressed halfway; instead, the camera will focus when an **AF-ON** button is pressed, at which point focus will lock and remain locked until either **AF-ON** button is pressed again. The shutter can be released at any time and the in-focus indicator (●) will not be displayed in the viewfinder. This applies in **AF-C** regardless of the option selected for Custom Setting a1 (**AF-C priority selection**, □ 313) and in **AF-S** except when **Focus** is selected for Custom Setting a2 (**AF-S priority selection**, □ 314) in single-point AF AF-area mode.

See Also

See Custom setting c1 (**Shutter-release button AE-L**, □ 324) for information on using the shutter-release button to lock exposure, Custom Setting f6 (**Assign sub-selector center**, □ 342) for information on choosing the role played by the center of the sub-selector.

Getting Good Results with Autofocus

Autofocus does not perform well under the conditions listed below. The shutter release may be disabled if the camera is unable to focus under these conditions, or the in-focus indicator (●) may be displayed and the camera may sound a beep, allowing the shutter to be released even when the subject is not in focus. In these cases, use manual focus (☐ 108) or use focus lock (☐ 105) to focus on another subject at the same distance and then recompose the photograph.



There is little or no contrast between the subject and the background.

Example: Subject is the same color as the background.



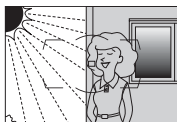
The focus point contains objects at different distances from the camera.

Example: Subject is inside a cage.



The subject is dominated by regular geometric patterns.

Example: Blinds or a row of windows in a skyscraper.



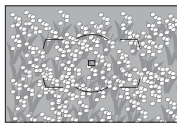
The focus point contains areas of sharply contrasting brightness.

Example: Subject is half in the shade.



Background objects appear larger than the subject.

Example: A building is in the frame behind the subject.



The subject contains many fine details.

Example: A field of flowers or other subjects that are small or lack variation in brightness.



Manual Focus

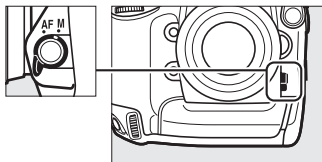
Manual focus is available for lenses that do not support autofocus (non-AF NIKKOR lenses) or when the autofocus does not produce the desired results (☞ 107).

- **AF-S lenses:** Set the lens focus mode switch to **M**.
- **AF lenses:** Set the lens focus mode switch (if present) and camera focus-mode selector to **M**.

☑ AF Lenses

Do not use AF lenses with the lens focus mode switch set to **M** and the camera focus-mode selector set to **AF**. Failure to observe this precaution could damage the camera or lens.

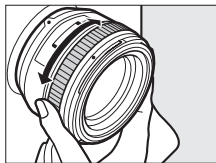
Focus-mode selector



- **Manual focus lenses:** Set the camera focus-mode selector to **M**.

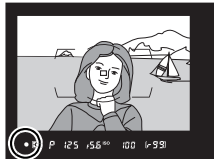
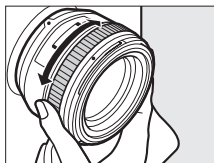
To focus manually, adjust the lens focus ring until the image displayed on the clear matte field in the viewfinder is in focus.

Photographs can be taken at any time, even when the image is not in focus.



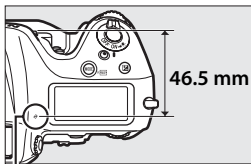
The Electronic Rangefinder

The viewfinder focus indicator can be used to confirm whether the subject in the selected focus point is in focus (the focus point can be selected from any of the 51 focus points). After positioning the subject in the selected focus point, press the shutter-release button halfway and rotate the lens focus ring until the in-focus indicator (●) is displayed. Note that with the subjects listed on page 107, the in-focus indicator may sometimes be displayed when the subject is not in focus; confirm focus in the viewfinder before shooting. For information on using the electronic rangefinder with optional AF-S/AF-I teleconverters, see page 404.



Focal Plane Position

To determine the distance between your subject and the camera, measure from the focal plane mark (∅) on the camera body. The distance between the lens mounting flange and the focal plane is 46.5 mm (1.83 in.).



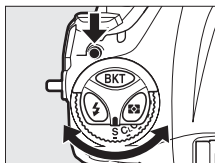
Focal plane mark



Release Mode



Choosing a Release Mode



To choose a release mode, press the release mode dial lock release and turn the release mode dial to the desired setting.



Mode	Description
S	Single frame: Camera takes one photograph each time shutter-release button is pressed.
CL	Continuous low speed: While shutter-release button is held down, camera records photographs at the frame rate selected for Custom Setting d2 (Continuous shooting speed , □ 326) > Continuous low-speed (□ 112).
CH	Continuous high speed: While shutter-release button is held down, camera records photographs at the frame rate selected for Custom Setting d2 (Continuous shooting speed , □ 326) > Continuous high-speed (□ 112). Use for active subjects.
Q	Quiet shutter-release: As for single frame, except that mirror does not click back into place while shutter-release button is fully pressed, allowing user to control timing of click made by mirror, which is also quieter than in single frame mode. In addition, beep does not sound regardless of setting selected for Custom Setting d1 (Beep ; □ 326).
☺	Self-timer: Take pictures with the self-timer (□ 114).
MUP	Mirror up: Choose this mode to minimize camera shake in telephoto or close-up photography or in other situations in which the slightest camera movement can result in blurred photographs (□ 116).

Continuous Release Modes

In continuous low speed mode, the camera records photographs at the frame rate selected for Custom Setting d2 (**Continuous shooting speed**,  326) > **Continuous low-speed**. In continuous high speed mode, the maximum frame rate can be chosen from 10 and 11 fps using Custom Setting d2 (**Continuous shooting speed**,  326) > **Continuous high-speed**.

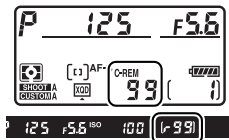
The foregoing frame rates assume continuous-servo AF, manual or shutter-priority auto exposure, a shutter speed of $1/250$ s or faster, and other settings at default values. The stated rates may not be available with some lenses; in addition, frame rates may drop at extremely small apertures (high f-numbers) or slow shutter speeds, when vibration reduction (available with VR lenses) or auto ISO sensitivity control ( 119) is on, or when the battery is low, a non-CPU lens is attached, or **Aperture ring** is selected for Custom Setting f10 (**Customize command dials**) > **Aperture setting** ( 345).



The Memory Buffer


The camera is equipped with a memory buffer for temporary storage, allowing shooting to continue while photographs are being saved to the memory card. Up to 200 photographs can be taken in succession; note, however, that frame rate will drop when the buffer is full (P00).

The approximate number of images that can be stored in the memory buffer at current settings is shown in the exposure-count displays in the viewfinder and top control panel while the shutter-release button is pressed halfway. The illustration at right shows the display when space remains in the buffer for about 99 pictures.



While photographs are being recorded to the memory card, the memory card access lamp will light. Depending on shooting conditions and memory card performance, recording may take from a few seconds to a few minutes. *Do not remove the memory card or remove or disconnect the power source until the access lamp has gone out.* If the camera is switched off while data remain in the buffer, the power will not turn off until all images in the buffer have been recorded. If the battery is exhausted while images remain in the buffer, the shutter release will be disabled and the images transferred to the memory card.

See Also

For information on choosing the maximum number of photographs that can be taken in a single burst, see Custom Setting d3 (**Max. continuous release**,  327). For information on the number of pictures that can be taken in a single burst, see page 464.




Self-Timer Mode

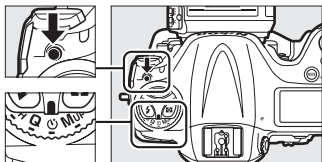
The self-timer can be used to reduce camera shake or for self-portraits.

1 Mount the camera on a tripod.

Mount the camera on a tripod or place the camera on a stable, level surface.



2 Select self-timer mode.

Press the release mode dial lock release and turn the release mode dial to .



Release mode dial

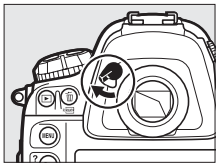
3 Frame the photograph and focus.

In single-servo AF ( 97), photographs can only be taken if the in-focus () indicator appears in the viewfinder.



Close the Viewfinder Eyepiece Shutter

When taking photos without your eye to the viewfinder, close the viewfinder eyepiece shutter to prevent light entering via the viewfinder from appearing in photographs or interfering with exposure.



4 Start the timer.



Press the shutter-release button all the way down to start the timer. The self-timer lamp will start to flash. Two seconds before the photograph is taken, the self-timer lamp will stop flashing. The shutter will be released about ten seconds after the timer starts.



To turn the self-timer off before a photograph is taken, turn the release mode dial to another setting.



See Also

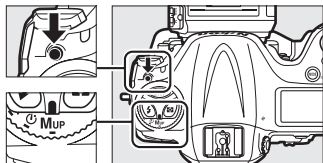
For information on choosing the duration of the self-timer, the number of shots taken, and the interval between shots, see Custom Setting c3 (**Self-timer**,  325). For information on controlling the beeps that sound when the self-timer is used, see Custom Setting d1 (**Beep**,  326).

Mirror up Mode

Choose this mode to minimize blurring caused by camera movement when the mirror is raised. Use of a tripod is recommended.

1 Select mirror up mode.

Press the release mode dial lock release and turn the release mode dial to **MUP**.



Release mode dial

2 Raise the mirror.

Frame the picture, focus, and then press the shutter-release button the rest of the way down to raise the mirror.



Mirror Up

While the mirror is raised, photos can not be framed in the viewfinder and autofocus and metering will not be performed.

3 Take a picture.

Press the shutter-release button all the way down again to take a picture. To prevent blurring caused by camera movement, press the shutter-release button smoothly. The mirror lowers when shooting ends.



Mirror up Mode

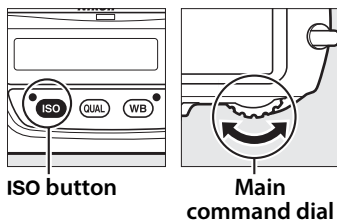
A picture will be taken automatically if no operations are performed for about 30 s after the mirror is raised.

ISO Sensitivity

Manual Adjustment

The camera's sensitivity to light can be adjusted according to the amount of light available. Choose from settings that range from ISO 100 and ISO 25600 in steps equivalent to $\frac{1}{3}$ EV. Settings of from about 0.3 to 1 EV below ISO 100 and 0.3 to 4 EV above ISO 25600 are also available for special situations. The higher the ISO sensitivity, the less light needed to make an exposure, allowing higher shutter speeds or smaller apertures.

ISO sensitivity can be adjusted by pressing the **ISO** button and rotating the main command dial until the desired setting is displayed in the control panels or viewfinder.



Top control panel



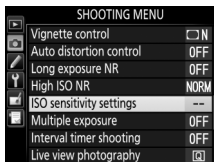
Rear control panel



Viewfinder

The ISO Sensitivity Menu

ISO sensitivity can also be adjusted using the **ISO sensitivity settings** option in the shooting menu (☐ 299).



ISO Sensitivity

The higher the ISO sensitivity, the less light needed to make an exposure, allowing faster shutter speeds or smaller apertures, but the more likely the image is to be affected by noise (randomly-spaced bright pixels, fog, or lines). Noise is particularly likely at settings between **Hi 0.3** and **Hi 4**.

Hi 0.3–Hi 4

The settings **Hi 0.3** through **Hi 4** correspond to ISO sensitivities 0.3–4 EV over ISO 25600 (ISO 32000–409600 equivalent).

Lo 0.3–Lo 1

The settings **Lo 0.3** through **Lo 1** correspond to ISO sensitivities 0.3–1 EV below ISO 100 (ISO 80–50 equivalent). Use for larger apertures when lighting is bright. Contrast is slightly higher than normal; in most cases, ISO sensitivities of ISO 100 or above are recommended.

See Also

For information on choosing the ISO sensitivity step size, see Custom Setting b1 (**ISO sensitivity step value**; ☐ 321). For information on using the **High ISO NR** option in the shooting menu to reduce noise at high ISO sensitivities, see page 308.

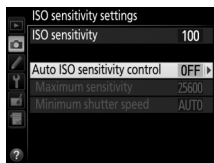
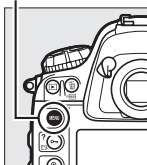
Auto ISO Sensitivity Control

If **On** is selected for **ISO sensitivity settings > Auto ISO sensitivity control** in the shooting menu, ISO sensitivity will automatically be adjusted if optimal exposure can not be achieved at the value selected by the user (ISO sensitivity is adjusted appropriately when the flash is used).

1 Select Auto ISO sensitivity control for ISO sensitivity settings in the shooting menu.

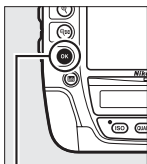
To display the menus, press the **MENU** button. Select **ISO sensitivity settings** in the shooting menu, highlight **Auto ISO sensitivity control**, and press **▶**.

MENU button

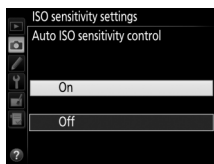


2 Select On.

Highlight **On** and press **OK** (if **Off** is selected, ISO sensitivity will remain fixed at the value selected by the user).



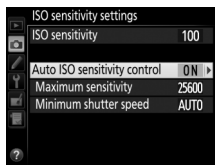
OK button



ISO

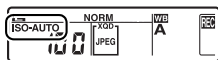
3 Adjust settings.

The maximum value for auto ISO sensitivity can be selected using **Maximum sensitivity** (the minimum value for auto ISO sensitivity is automatically



set to ISO 100; note that if the ISO sensitivity selected by the user is higher than that chosen for **Maximum sensitivity**, the value selected by the user will be used instead). In exposure modes **P** and **A**, sensitivity will only be adjusted if underexposure would result at the shutter speed selected for **Minimum shutter speed** ($1/4000$ – 30 s, or **Auto**; in modes **S** and **M**, ISO sensitivity will be adjusted for optimal exposure at the shutter speed selected by the user). If **Auto** is selected, the camera will choose the minimum shutter speed based on the focal length of the lens. Press **OK** to exit when settings are complete.

When **On** is selected, the viewfinder and rear control panel show **ISO-AUTO**. When sensitivity is altered from the value selected by the user, these indicators flash and the altered value is shown in the viewfinder and rear control panel.



Minimum Shutter Speed



Auto shutter-speed selection can be fine-tuned by highlighting **Auto** and pressing **▶**: for example, values faster than those usually selected automatically can be used with telephoto lenses to reduce blur. Note, however, that **Auto** is available only with CPU lenses or when lens data are provided for non-CPU lenses; if a non-CPU lens is used without lens data, minimum shutter speed is fixed at $1/30$ s. Shutter speeds may drop below the selected minimum if optimum exposure can not be achieved at the ISO sensitivity chosen for **Maximum sensitivity**.

Turning Auto ISO Sensitivity Control On or Off

You can turn auto ISO sensitivity control on or off by pressing the **ISO** button and rotating the sub-command dial. The rear control panel displays an **ISO-AUTO** icon when auto ISO sensitivity control is on and **ISO** when it is off.



Auto ISO Sensitivity Control




Noise (randomly-spaced bright pixels, fog, or lines) is more likely at higher sensitivities. Use the **High ISO NR** option in the shooting menu to reduce noise (see page 308). When a flash is used, the value selected for **Minimum shutter speed** is ignored in favor of the option selected for Custom Setting e1 (**Flash sync speed**,  331). Note that ISO sensitivity may be raised automatically when auto ISO sensitivity control is used in combination with slow sync flash modes (available with optional flash units;  196), possibly preventing the camera from selecting slow shutter speeds.




Exposure

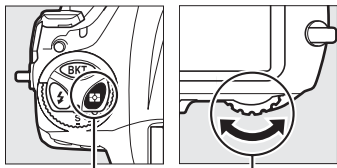
Metering

Metering determines how the camera sets exposure. The following options are available:

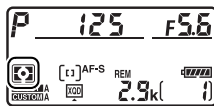
Option	Description
	Matrix: Produces natural results in most situations. Camera meters a wide area of the frame and set exposure according to tone distribution, color, composition, and, with type G, E, or D lenses (☐ 401), distance information (3D color matrix metering III; with other CPU lenses, camera uses color matrix metering III, which does not include 3D distance information). With non-CPU lenses, camera uses color matrix metering if focal length and maximum aperture are specified using Non-CPU lens data option in setup menu (☐ 236); otherwise camera uses center-weighted metering.
	Center-weighted: Camera meters entire frame but assigns greatest weight to center area (if CPU lens is attached, size of area can be selected using Custom Setting b6, Center-weighted area , ☐ 323; if non-CPU lens is attached, area is 12 mm in diameter). Classic meter for portraits; recommended when using filters with an exposure factor (filter factor) over 1×.
	Spot: Camera meters circle 4 mm (0.16 in.) in diameter (approximately 1.5% of frame). Circle is centered on current focus point, making it possible to meter off-center subjects (if non-CPU lens is used or if auto-area AF is in effect, camera will meter center focus point). Ensures that subject will be correctly exposed, even when background is much brighter or darker.



To choose a metering option, press the  button and rotate the main command dial until the desired setting is displayed in the viewfinder and top control panel.



 button Main command dial





Top control panel



Viewfinder



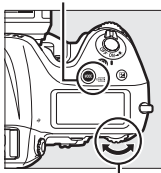
See Also

See Custom Setting b5 (**Matrix metering**,  323) for information on choosing whether matrix metering uses face detection. For information on making separate adjustments to optimal exposure for each metering method, see Custom Setting b7 (**Fine-tune optimal exposure**,  323).

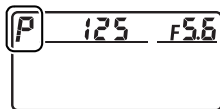
Exposure Mode

To determine how the camera sets shutter speed and aperture when adjusting exposure, press the **MODE** (FORMAT) button and rotate the main command dial until the desired option appears in the top control panel.

MODE (FORMAT) button



Main command dial



Mode	Description
P	Programmed auto (☞ 127): Camera sets shutter speed and aperture for optimal exposure. Recommended for snapshots and in other situations in which there is little time to adjust camera settings.
S	Shutter-priority auto (☞ 128): User chooses shutter speed; camera selects aperture for best results. Use to freeze or blur motion.
A	Aperture-priority auto (☞ 129): User chooses aperture; camera selects shutter speed for best results. Use to blur background or bring both foreground and background into focus.
M	Manual (☞ 130): User controls both shutter speed and aperture. Set shutter speed to Bulb (b u l b) or Time (- -) for long time-exposures.



Lens Types

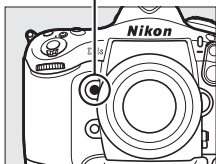
When using a CPU lens equipped with an aperture ring (□ 403), lock the aperture ring at the minimum aperture (highest f-number). Type G and E lenses are not equipped with an aperture ring.

When using non-CPU lenses (□ 235), select exposure mode **A** (aperture-priority auto) or **M** (manual). In other modes, exposure mode **A** is automatically selected when a non-CPU lens is attached (□ 405). The exposure mode indicator (**P** or **S**) will flash in the top control panel and **A** will be displayed in the viewfinder.

Depth-of-Field Preview

To preview the effects of aperture, press and hold the **Pv** button. The lens will be stopped down to the aperture value selected by the camera (modes **P** and **S**) or the value chosen by the user (modes **A** and **M**), allowing depth of field to be previewed in the viewfinder.

Pv button



Custom Setting e5—Modeling Flash

This setting controls whether optional flash units that support the Nikon Creative Lighting System (CLS; □ 198) will emit a modeling flash when the **Pv** button is pressed. See page 333 for more information.



P: Programmed Auto

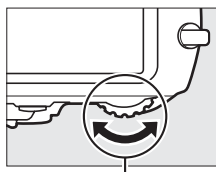
In this mode, the camera automatically adjusts shutter speed and aperture according to a built-in program to ensure optimal exposure in most situations.

Flexible Program

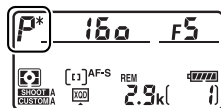
In exposure mode **P**, different combinations of shutter speed and aperture can be selected by rotating the main command dial while the exposure meters are on (“flexible program”). Rotate the dial to the right for large apertures (low f-numbers) that blur background details or fast shutter speeds that “freeze” motion. Rotate the dial to the left for small apertures (high f-numbers) that increase depth of field or slow shutter speeds that blur motion. All combinations produce the same exposure. While flexible program is in effect, an asterisk (“*”) appears in the top control panel. To restore default shutter speed and aperture settings, rotate the dial until the asterisk is no longer displayed, choose another mode, or turn the camera off.

See Also

See page 438 for information on the built-in exposure program. For information on activating the exposure meters, see “The Standby Timer” on page 44.



Main command dial



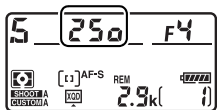
5: Shutter-Priority Auto

In shutter-priority auto, you choose the shutter speed while the camera automatically selects the aperture that will produce the optimal exposure.

To choose a shutter speed, rotate the main command dial while the exposure meters are on. Shutter speed can be set to “x 250” or to values between 30 s and $1/8000$ s. Shutter speed can be locked at the selected setting (📖 134).



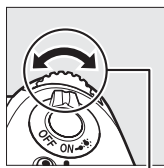
Main command dial



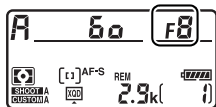
A: Aperture-Priority Auto

In aperture-priority auto, you choose the aperture while the camera automatically selects the shutter speed that will produce the optimal exposure.

To choose an aperture between the minimum and maximum values for the lens, rotate the sub-command dial while the exposure meters are on. Aperture can be locked at the selected setting (📖 134).



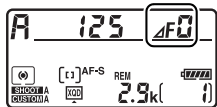
Sub-command dial



Non-CPU Lenses (📖 401, 405)

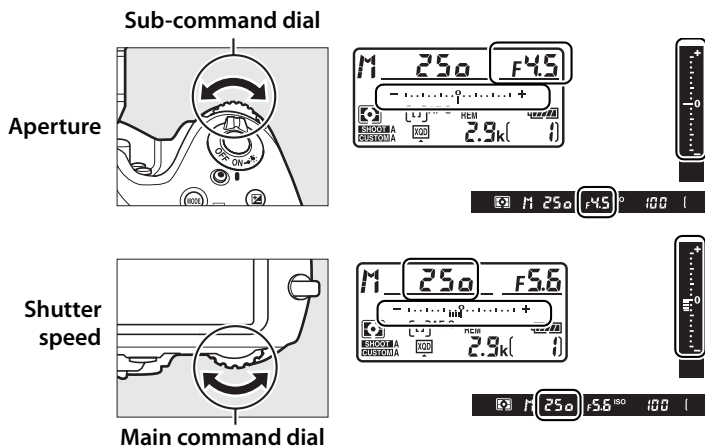
Use the lens aperture ring to adjust aperture. If the maximum aperture of the lens has been specified using the **Non-CPU lens data** item in setup menu (📖 236) when a non-CPU lens is attached, the current f-number will be displayed in the viewfinder and top control panel, rounded to the nearest full stop.

Otherwise the aperture displays will show only the number of stops (ΔF , with maximum aperture displayed as $\Delta F0$) and the f-number must be read from the lens aperture ring.



M: Manual

In manual exposure mode, you control both shutter speed and aperture. While the exposure meters are on, rotate the main command dial to choose a shutter speed, and the sub-command dial to set aperture. Shutter speed can be set to “x 250” or to values between 30 s and $\frac{1}{8000}$ s, or the shutter can be held open indefinitely for a long time-exposure (b u l b or - -, □ 132). Aperture can be set to values between the minimum and maximum values for the lens. Use the exposure indicators to check exposure.










Shutter speed and aperture can be locked at the selected setting (□ 134).

AF Micro NIKKOR Lenses


Provided that an external exposure meter is used, the exposure ratio need only be taken into account when the lens aperture ring is used to set aperture.

Exposure Indicators

The exposure indicators in the viewfinder and top control panel show whether the photograph would be under- or over-exposed at current settings. Depending on the option chosen for Custom Setting b2 (**EV steps for exposure cntrl**,  321), the amount of under- or over-exposure is shown in increments of $\frac{1}{3}$ EV, $\frac{1}{2}$ EV, or 1 EV. If the limits of the exposure metering system are exceeded, the displays will flash.

Custom Setting b2 set to 1/3 step			
	Optimal exposure	Underexposed by $\frac{1}{3}$ EV	Overexposed by over 3 EV
Top control panel			
Viewfinder			

See Also

For information on reversing the exposure indicators so that negative values are displayed on the right and positive values on the left, see Custom Setting f13 (**Reverse indicators**,  347).



Long Time-Exposures (M Mode Only)

Select the following shutter speeds for long time-exposures of moving lights, the stars, night scenery, or fireworks.

- **Bulb** (b, L, b): The shutter remains open while the shutter-release button is held down. To prevent blur, use a tripod or an optional wireless remote controller (☐ 411) or remote cord (☐ 412).
- **Time** (- -): Start the exposure by using the shutter-release button on the camera or on an optional remote cord, or wireless remote controller. The shutter remains open for thirty minutes or until the button is pressed a second time.



Length of exposure: 35 s
Aperture: f/25



1 Ready the camera.

Mount the camera on a tripod or place it on a stable, level surface.

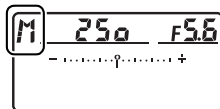
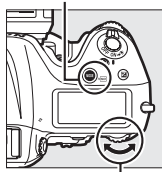
Long Time-Exposures

Close the viewfinder eyepiece shutter to prevent light entering via the viewfinder from appearing in the photograph or interfering with exposure (☐ 114). Nikon recommends using a fully charged battery or an optional AC adapter and power connector to prevent loss of power while the shutter is open. Note that noise (bright spots, randomly-spaced bright pixels or fog) may be present in long exposures; before shooting, choose **On** for the **Long exposure NR** option in the shooting menu (☐ 308).

2 Select exposure mode *M*.

Press the **MODE** (FORMAT) button and rotate the main command dial until *M* is displayed in the top control panel.

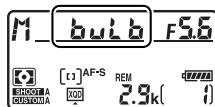
MODE (FORMAT) button



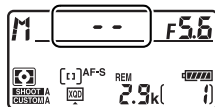
Main command dial

3 Choose a shutter speed.

While the exposure meters are on, rotate the main command dial to choose a shutter speed of Bulb (*b u l b*) or Time (*- -*). The exposure indicators do not appear when Bulb (*b u l b*) or Time (*- -*) is selected.



Bulb



Time

4 Open the shutter.

Bulb: After focusing, press the shutter-release button on the camera or optional remote cord or wireless remote controller all the way down. Keep the shutter-release button pressed until the exposure is complete.

Time: Press the shutter-release button all the way down.

5 Close the shutter.

Bulb: Take your finger off the shutter-release button.

Time: Press the shutter-release button all the way down. Shooting ends automatically after thirty minutes.




Shutter-Speed and Aperture Lock

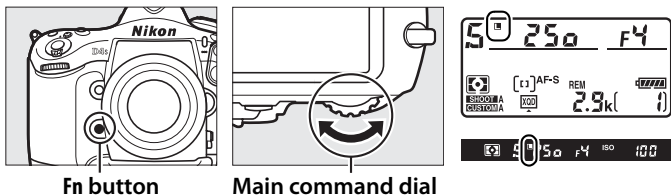
Shutter speed lock is available in shutter-priority auto and manual exposure modes, aperture lock in aperture-priority auto and manual exposure modes. Shutter speed and aperture lock are not available in programmed auto exposure mode.


1 Assign shutter speed and aperture lock to a camera control.


Select **Shutter spd & aperture lock** as the “Press + command dials” option in the Custom Settings menu (☞ 341). Shutter speed and aperture lock can be assigned to the **Fn** button (Custom Setting f3, **Assign Fn button**, ☞ 337), the **Pv** button (Custom Setting f4, **Assign preview button**, ☞ 342), or the center of the sub-selector (Custom Setting f6, **Assign sub-selector center**, ☞ 342).

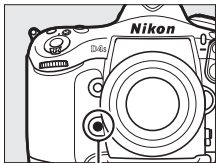
2 Lock shutter speed and/or aperture.

Shutter speed (exposure modes S and M): Press the selected control and rotate the main command dial until  icons appear in the viewfinder and top control panel.

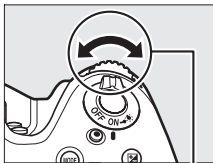


To unlock shutter speed, press the control and rotate the main command dial until the  icons disappear from the displays.

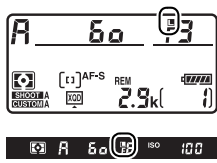
Aperture (exposure modes A and M): Press the selected control and rotate the sub-command dial until  icons appear in the viewfinder and the top control panel.




Fn button



Sub-command dial



To unlock aperture, press the control and rotate the sub-command dial until the  icons disappear from the displays.



 **See Also**

Use Custom Setting f8 (**Shutter spd & aperture lock**;  343) to keep shutter speed and/or aperture locked at the selected values.

Autoexposure (AE) Lock

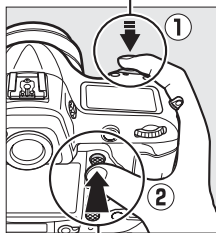
Use autoexposure lock to recompose photographs after using center-weighted metering and spot metering (📖 123) to meter exposure. Note that matrix metering will not produce the desired results.

1 Lock exposure.

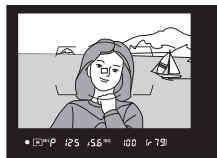
Position the subject in the selected focus point and press the shutter-release button halfway. With the shutter-release button pressed halfway and the subject positioned in the focus point, press the center of the sub-selector to lock exposure (if you are using autofocus, confirm that the ● in-focus indicator appears in the viewfinder).

While exposure lock is in effect, an **AE-L** indicator will appear in the viewfinder.

Shutter-release button

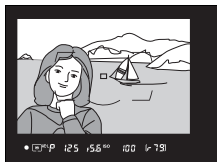


Center of sub-selector



2 Recompose the photograph.

Keeping the center of the sub-selector pressed, recompose the photograph and shoot.




Metered Area

In spot metering, exposure will be locked at the value metered in a 4-mm (0.16 in.) circle centered on the selected focus point. In center-weighted metering, exposure will be locked at the value metered in a 12-mm circle in the center of the viewfinder.



Adjusting Shutter Speed and Aperture

While exposure lock is in effect, the following settings can be adjusted without altering the metered value for exposure:

Exposure mode	Setting
P	Shutter speed and aperture (flexible program;  127)
S	Shutter speed
A	Aperture

The new values can be confirmed in the viewfinder and top control panel. Note that the metering method can not be changed while exposure lock is in effect.

See Also

If **On** is selected for Custom Setting c1 (**Shutter-release button AE-L**,  324), exposure will lock when the shutter-release button is pressed halfway. For information on changing the role of the center of the sub-selector, see Custom Setting f6 (**Assign sub-selector center**,  342).



Exposure Compensation

Exposure compensation is used to alter exposure from the value suggested by the camera, making pictures brighter or darker. It is most effective when used with center-weighted or spot metering (123). Choose from values between -5 EV (underexposure) and $+5$ EV (overexposure) in increments of $1/3$ EV. In general, positive values make the subject brighter while negative values make it darker.




-1 EV

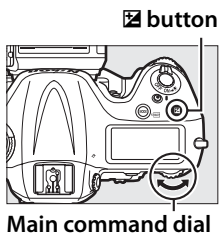


No exposure compensation



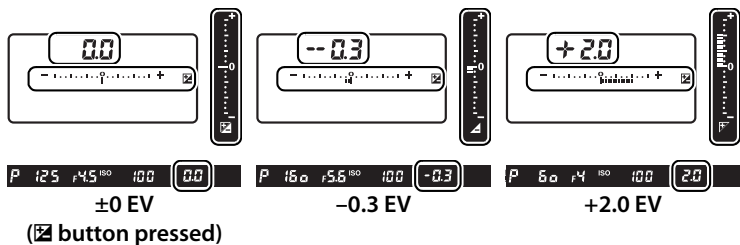
+1 EV




To choose a value for exposure compensation, press the  button and rotate the main command dial until the desired value is displayed in the viewfinder or top control panel.

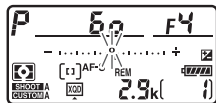


 button

Main command dial



At values other than ± 0.0 , the 0 at the center of the exposure indicators will flash (exposure modes *P*, *S*, and *A* only) and a  icon will be displayed in the viewfinder and top control panel after you release the  button. The current value for exposure compensation can be confirmed in the exposure indicator by pressing the  button.




Normal exposure can be restored by setting exposure compensation to ± 0.0 . Exposure compensation is not reset when the camera is turned off.




Exposure Mode *M*

In exposure mode *M*, exposure compensation affects only the exposure indicator; shutter speed and aperture do not change.

Using a Flash

When a flash is used, exposure compensation affects both flash level and exposure, altering the brightness of both the main subject and the background. Custom Setting e4 (**Exposure comp. for flash**,  333) can be used to restrict the effects of exposure compensation to the background only.

See Also

For information on choosing the size of the increments available for exposure compensation, see Custom Setting b3 (**Exp./flash comp. step value**,  321). For information on making adjustments to exposure compensation without pressing the  button, see Custom Setting b4 (**Easy exposure compensation**,  322). For information on automatically varying exposure, flash level, white balance, or Active D-Lighting, see page 140.



Bracketing

Bracketing automatically varies exposure, flash level, Active D-Lighting (ADL), or white balance slightly with each shot, “bracketing” the current value. Choose in situations in which it is difficult to set exposure, flash level (i-TTL and, where supported, auto aperture flash control modes only; see pages 197 and 202), Active D-Lighting, or white balance and there is not time to check results and adjust settings with each shot, or to experiment with different settings for the same subject.

■ ■ *Exposure and Flash Bracketing*

To vary exposure and/or flash level over a series of photographs:



Exposure modified by:
0 EV



Exposure modified by:
-1 EV



Exposure modified by:
+1 EV

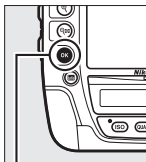
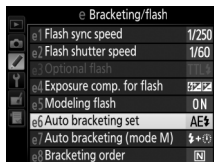
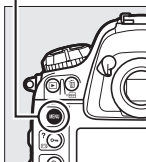


1 Select flash or exposure bracketing for Custom Setting e6 (Auto bracketing set) in the Custom Settings menu.

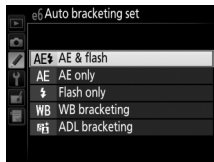
To display the menus, press the MENU button. Select Custom Setting e6 (Auto bracketing set) in the Custom Settings menu, highlight an option, and press OK. Choose **AE & flash** to vary both

exposure and flash level, **AE only** to vary only exposure, or **Flash only** to vary only flash level.

MENU button

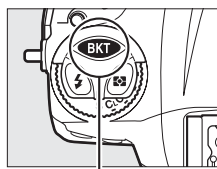


OK button

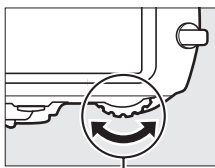


2 Choose the number of shots.

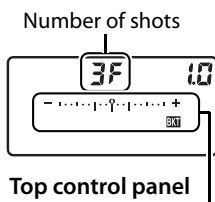
Pressing the **BKT** button, rotate the main command dial to choose the number of shots in the bracketing sequence. The number of shots is shown in the top control panel.



BKT button



Main command dial



Number of shots

Top control panel

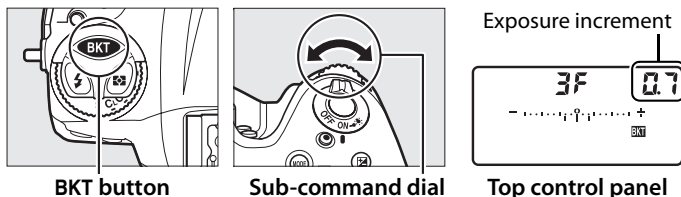
Exposure and flash bracketing indicator

At settings other than zero, a **BKT** icon and exposure and flash bracketing indicator will be displayed in the viewfinder and top control panel.



3 Select an exposure increment.

Pressing the **BKT** button, rotate the sub-command dial to choose the exposure increment.



At default settings, the size of the increment can be chosen from 0.3 ($1/3$), 0.7 ($2/3$), 1, 2, and 3 EV. The bracketing programs with an increment of 0.3 ($1/3$) EV are listed below.

Control panel display	No. of shots	Bracketing order (EVs)
0F 0.3	0	0
+ 3F 0.3	3	0/+0.3/+0.7
-- 3F 0.3	3	0/-0.7/-0.3
+ 2F 0.3	2	0/+0.3
-- 2F 0.3	2	0/-0.3
3F 0.3	3	0/-0.3/+0.3
5F 0.3	5	0/-0.7/-0.3/+0.3/+0.7
7F 0.3	7	0/-1.0/-0.7/-0.3/+0.3/ +0.7/+1.0
9F 0.3	9	0/-1.3/-1.0/-0.7/-0.3/ +0.3/+0.7/+1.0/+1.3

Note that for exposure increments of 2 EV or more, the maximum number of shots is 5; if a higher value was selected in Step 2, the number of shots will automatically be set to 5.

See Also

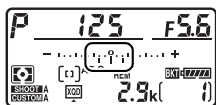
For information on choosing the size of the exposure increment, see Custom Setting b2 (**EV steps for exposure ctrl**, [321](#)). For information on choosing the order in which bracketing is performed, see Custom Setting e8 (**Bracketing order**, [334](#)). For information on choosing the role of the **BKT** button, see Custom Setting f9 (**Assign BKT button**, [344](#)).

4 Frame a photograph, focus, and shoot.

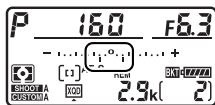


The camera will vary exposure and/or flash level shot-by-shot according to the bracketing program selected. Modifications to exposure are added to those made with exposure compensation (see page 138).

While bracketing is in effect, a bracketing progress indicator will be displayed in the viewfinder and top control panel. A segment will disappear from the indicator after each shot.



No. shots: 3; increment: 0.7



Display after first shot

Canceling Bracketing

To cancel bracketing, press the **BKT** button and rotate the main command dial until the number of shots in the bracketing sequence is zero (0F) and **BKT** is no longer displayed. The program last in effect will be restored the next time bracketing is activated. Bracketing can also be cancelled by performing a two-button reset (211), although in this case the bracketing program will not be restored the next time bracketing is activated.

Exposure and Flash Bracketing

In continuous low speed and continuous high speed modes, shooting will pause after the number of shots specified in the bracketing program have been taken. Shooting will resume the next time the shutter-release button is pressed. In self-timer mode, the camera will take the number of shots selected in Step 2 on page 142 each time the shutter-release button is pressed, regardless of the option selected for Custom Setting c3 (**Self-timer**) > **Number of shots** (□ 325); the interval between shots is however controlled by Custom Setting c3 (**Self-timer**) > **Interval between shots**. In other modes, one shot will be taken each time the shutter-release button is pressed.

If the memory card fills before all shots in the sequence have been taken, shooting can be resumed from the next shot in the sequence after the memory card has been replaced or shots have been deleted to make room on the memory card. If the camera is turned off before all shots in the sequence have been taken, bracketing will resume from the next shot in the sequence when the camera is turned on.

Exposure Bracketing

The camera modifies exposure by varying shutter speed and aperture (programmed auto), aperture (shutter-priority auto), or shutter speed (aperture-priority auto, manual exposure mode). If **On** is selected for **ISO sensitivity settings > Auto ISO sensitivity control** (□ 119) in modes *P*, *S*, and *M* and no flash is attached, the camera will modify exposure by varying ISO sensitivity and only vary shutter speed and/or aperture if the limits of exposure system are exceeded. Custom Setting e7 (**Auto bracketing (mode M)**, □ 334) can be used to change how the camera performs exposure and flash bracketing in manual exposure mode. Bracketing can be performed by varying flash level together with shutter speed and/or aperture, or by varying flash level alone.

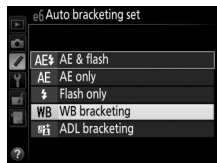


■ White Balance Bracketing

The camera creates multiple copies of each photograph, each with a different white balance. For more information on white balance, see page 155.

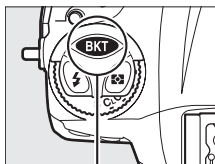
1 Select white balance bracketing.

Choose **WB bracketing** for Custom Setting e6 **Auto bracketing set**.

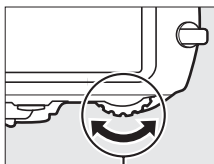


2 Choose the number of shots.

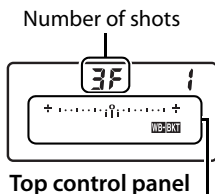
Pressing the **BKT** button, rotate the main command dial to choose the number of shots in the bracketing sequence. The number of shots is shown in the top control panel.



BKT button



Main command dial



Top control panel

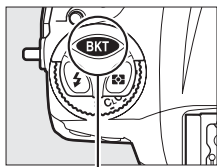
WB bracketing indicator

At settings other than zero, a **WB-BKT** icon and **WB** bracketing indicator will appear in the top control panel and **BKT** will be displayed in the viewfinder.

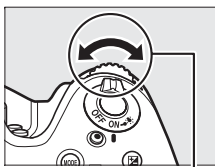


3 Select a white balance increment.

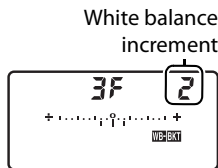
Pressing the **BKT** button, rotate the sub-command dial to choose the white balance adjustment. Each increment is roughly equivalent to 5 mired.



BKT button



Sub-command dial



Top control panel

Choose from increments of 1 (5 mired), 2 (10 mired), or 3 (15 mired). Higher **B** values correspond to increased amounts of blue, higher **A** values to increased amounts of amber (159). The bracketing programs with an increment of 1 are listed below.

Control panel display	No. of shots	White balance increment	Bracketing order
0F 1 +.....o.....+	0	1	0
b3F 1 +.....ii.....+	3	1 B	0 / 1 B / 2 B
R3F 1 +.....ii.....+	3	1 A	0 / 2 A / 1 A
b2F 1 +.....ii.....+	2	1 B	0 / 1 B
R2F 1 +.....ii.....+	2	1 A	0 / 1 A
3F 1 +.....ii.....+	3	1 A, 1 B	0 / 1 A / 1 B
5F 1 +.....iiiii.....+	5	1 A, 1 B	0 / 2 A / 1 A / 1 B / 2 B
7F 1 +.....iiiiii.....+	7	1 A, 1 B	0 / 3 A / 2 A / 1 A / 1 B / 2 B / 3 B
9F 1 +.....iiiiiii.....+	9	1 A, 1 B	0 / 4 A / 3 A / 2 A / 1 A / 1 B / 2 B / 3 B / 4 B

See Also

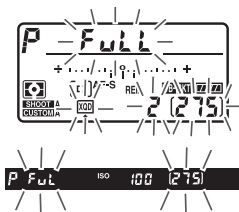
See page 160 for a definition of “mired.”

4 Frame a photograph, focus, and shoot.



Each shot will be processed to create the number of copies specified in the bracketing program, and each copy will have a different white balance. Modifications to white balance are added to the white balance adjustment made with white balance fine-tuning.

If the number of shots in the bracketing program is greater than the number of exposures remaining, **FULL** and the icon for the affected card will flash in the top control panel, a flashing **FuL** icon will appear in the viewfinder as shown at right, and the shutter release will be disabled.



Shooting can begin when a new memory card is inserted.



■ ■ **Canceling Bracketing**

To cancel bracketing, press the **BKT** button and rotate the main command dial until the number of shots in the bracketing sequence is zero (**0F**) and **WB-BKT** is no longer displayed. The program last in effect will be restored the next time bracketing is activated. Bracketing can also be cancelled by performing a two-button reset (**□ 211**), although in this case the bracketing program will not be restored the next time bracketing is activated.

White Balance Bracketing

White balance bracketing is not available at an image quality of NEF (RAW). Selecting **NEF (RAW)**, **NEF (RAW)+JPEG fine**, **NEF (RAW)+JPEG normal**, or **NEF (RAW)+JPEG basic** cancels white balance bracketing.

White balance bracketing affects only color temperature (the amber-blue axis in the white balance fine-tuning display, **□ 159**). No adjustments are made on the green-magenta axis.

In self-timer mode, the number of copies specified in the white-balance program will be created each time the shutter is released, regardless of the option selected for Custom Setting c3 (**Self-timer**) > **Number of shots** (**□ 325**).

If the camera is turned off while the memory card access lamp is lit, the camera will power off only after all photographs in the sequence have been recorded.

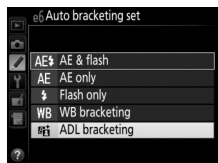


■ ■ ADL Bracketing

The camera varies Active D-Lighting over a series of exposures. For more information on Active D-Lighting, see page 188.

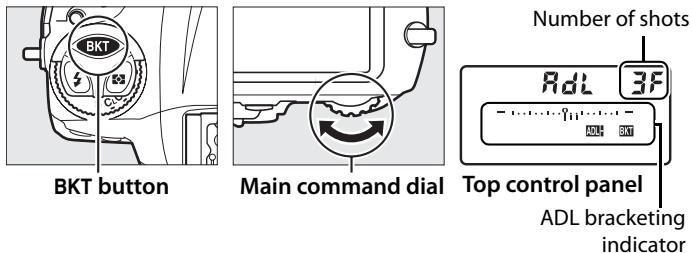
1 Select ADL bracketing.

Choose **ADL bracketing** for Custom Setting e6 **Auto bracketing set**.



2 Choose the number of shots.

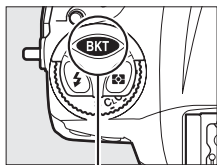
Pressing the **BKT** button, rotate the main command dial to choose the number of shots in the bracketing sequence. The number of shots is shown in the top control panel.



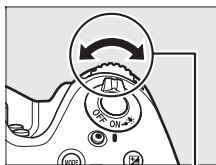
At settings other than zero, a **ADL-BKT** icon and an ADL bracketing indicator appear in the top control panel and **BKT** will be displayed in the viewfinder. Choose two shots to take one photograph with Active D-Lighting off and another at a selected value. Choose three to five shots to take a series of photographs with Active D-Lighting set successively to values between **Off** and **Normal** (three shots), between **Off** and **High** (four shots), or between **Off** and **Extra high 1** or **Low** and **Extra high 2** (five shots). If you choose more than two shots, proceed to Step 4.

3 Select Active D-Lighting.

Pressing the **BKT** button, rotate the sub-command dial to choose Active D-Lighting.



BKT button



Sub-command dial

Active D-Lighting is shown in the top control panel.

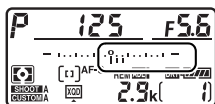
Control panel display	ADL	Control panel display	ADL
The control panel display shows 'AdL 2F' at the top. Below it is a horizontal bar with a scale from 0 to 100. A small 'A' icon is visible in the bottom right corner of the display area.	暗A Auto	The control panel display shows 'AdL 2F' at the top. Below it is a horizontal bar with a scale from 0 to 100. A small 'H' icon is visible in the bottom right corner of the display area.	暗H High
The control panel display shows 'AdL 2F' at the top. Below it is a horizontal bar with a scale from 0 to 100. A small 'L' icon is visible in the bottom right corner of the display area.	暗L Low	The control panel display shows 'AdL 2F' at the top. Below it is a horizontal bar with a scale from 0 to 100. A small 'H1' icon is visible in the bottom right corner of the display area.	暗H1 Extra high 1
The control panel display shows 'AdL 2F' at the top. Below it is a horizontal bar with a scale from 0 to 100. A small 'N' icon is visible in the bottom right corner of the display area.	暗N Normal	The control panel display shows 'AdL 2F' at the top. Below it is a horizontal bar with a scale from 0 to 100. A small 'H2' icon is visible in the bottom right corner of the display area.	暗H2 Extra high 2



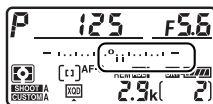
4 Frame a photograph, focus, and shoot.



The camera will vary Active D-Lighting shot-by-shot according to the bracketing program selected. While bracketing is in effect, a bracketing progress indicator will be displayed in the top control panel. A segment will disappear from the indicator after each shot.



No. shots: 3



Display after first shot



■ ■ *Canceling Bracketing*

To cancel bracketing, press the **BKT** button and rotate the main command dial until the number of shots in the bracketing sequence is zero (**0F**) and **ADL BKT** is no longer displayed. The program last in effect will be restored the next time bracketing is activated. Bracketing can also be cancelled by performing a two-button reset (**□ 211**), although in this case the bracketing program will not be restored the next time bracketing is activated.

ADL Bracketing

In continuous low speed and continuous high speed modes, shooting will pause after the number of shots specified in the bracketing program have been taken. Shooting will resume the next time the shutter-release button is pressed. In self-timer mode, the camera will take the number of shots selected in Step 2 on page 150 each time the shutter-release button is pressed, regardless of the option selected for Custom Setting c3 (**Self-timer**) > **Number of shots** (**□ 325**); the interval between shots is however controlled by Custom Setting c3 (**Self-timer**) > **Interval between shots**. In other modes, one shot will be taken each time the shutter-release button is pressed.

If the memory card fills before all shots in the sequence have been taken, shooting can be resumed from the next shot in the sequence after the memory card has been replaced or shots have been deleted to make room on the memory card. If the camera is turned off before all shots in the sequence have been taken, bracketing will resume from the next shot in the sequence when the camera is turned on.









White Balance

White Balance Options

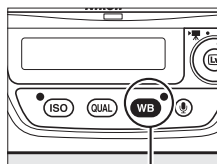
White balance ensures that colors are unaffected by the color of the light source. Auto white balance is recommended with most light sources. If the desired results can not be achieved with auto white balance, choose an option from the list below or use preset white balance.

Option	Color temp. *	Description
AUTO Auto	3500– 8000 K	White balance is adjusted automatically. For best results, use type G, E or D lens. If optional flash fires, results are adjusted appropriately.
Normal		
Keep warm lighting colors		
 Incandescent	3000 K	Use under incandescent lighting.
 Fluorescent		Use with:
Sodium-vapor lamps	2700 K	• Sodium-vapor lighting (found in sports venues).
Warm-white fluorescent	3000 K	• Warm-white fluorescent lights.
White fluorescent	3700 K	• White fluorescent lights.
Cool-white fluorescent	4200 K	• Cool-white fluorescent lights.
Day white fluorescent	5000 K	• Daylight white fluorescent lights.
Daylight fluorescent	6500 K	• Daylight fluorescent lights.
High temp. mercury-vapor	7200 K	• High color temperature light sources (e.g. mercury-vapor lamps).
 Direct sunlight	5200 K	Use with subjects lit by direct sunlight.
 Flash	5400 K	Use with optional flash units.

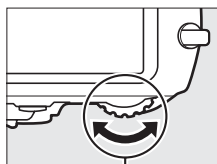
Option	Color temp.*	Description
Cloudy	6000 K	Use in daylight under overcast skies.
Shade	8000 K	Use in daylight with subjects in the shade.
Choose color temp.	2500–10,000 K	Choose color temperature from list of values (📖 161).
PRE Preset manual	—	Use subject, light source, or existing photograph as reference for white balance (📖 164).

* All values are approximate and do not reflect fine-tuning (if applicable).

White balance can be selected by pressing the **WB** button and rotating the main command dial until the desired setting is displayed in the rear control panel.



WB button



Main command dial



Rear control panel

WB

The Shooting Menu


White balance can also be adjusted using the **White balance** option in the shooting menu (📖 299), which also can be used to fine-tune white balance (📖 158) or measure a value for preset white balance (📖 164). The **Auto** option in the **White balance** menu offers a choice of **Normal** and **Keep warm lighting colors**, which preserves the warm colors produced by incandescent lighting, while the **Fluorescent** option can be used to select the light source from the bulb types.



Studio Flash Lighting













Auto white balance may not produce the desired results with large studio flash units. Use preset white balance or set white balance to **Flash** and use fine-tuning to adjust white balance.

See Also

When **WB bracketing** is selected for Custom Setting e6 (**Auto bracketing set**,  333), the camera will create several images each time the shutter is released. White balance will be varied with each image, “bracketing” the value currently selected for white balance. See page 146 for more information.

Color Temperature

The perceived color of a light source varies with the viewer and other conditions. Color temperature is an objective measure of the color of a light source, defined with reference to the temperature to which an object would have to be heated to radiate light in the same wavelengths. While light sources with a color temperature in the neighborhood of 5000–5500 K appear white, light sources with a lower color temperature, such as incandescent light bulbs, appear slightly yellow or red. Light sources with a higher color temperature appear tinged with blue. The camera white balance options are adapted to the following color temperatures (all figures are approximate):

- | | |
|--|---|
| •  (sodium-vapor lamps): 2700 K | •  (direct sunlight): 5200 K |
| •  (incandescent)/ | •  (flash): 5400 K |
| •  (warm-white fluorescent.): | •  (cloudy): 6000 K |
| • 3000 K | •  (daylight fluorescent): 6500 K |
| •  (white fluorescent): 3700 K | •  (high temp. mercury-vapor): |
| •  (cool-white fluorescent): | • 7200 K |
| • 4200 K | •  (shade): 8000 K |
| •  (day white fluorescent): 5000 K | |

Fine-Tuning White Balance

White balance can be “fine-tuned” to compensate for variations in the color of the light source or to introduce a deliberate color cast into an image. White balance is fine-tuned using the **White balance** option in the shooting menu or by pressing the **WB** button and rotating the sub-command dial.

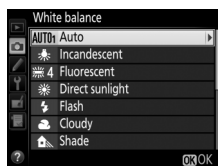
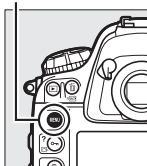
■ ■ The White Balance Menu

1 Select a white balance option in the shooting menu.

To display the menus, press the **MENU** button. Select **White balance** in the shooting menu, then

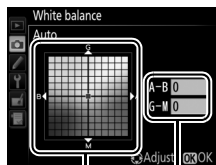
highlight a white balance option and press **▶**. If an option other than **Auto**, **Fluorescent**, **Choose color temp.**, or **Preset manual** is selected, proceed to Step 2. If **Auto** or **Fluorescent** is selected, highlight the desired setting and press **▶**. For information on fine-tuning preset white balance, see page 174.

MENU button



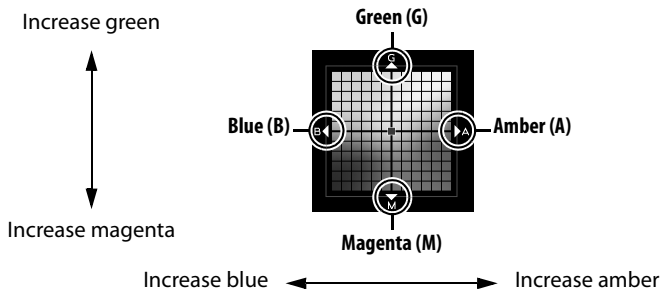
2 Fine-tune white balance.

Use the multi selector to fine-tune white balance. White balance can be fine-tuned on the amber (A)–blue (B) axis in steps of 0.5 and the green (G)–magenta (M) axis in steps of 0.25. The horizontal (amber–blue) axis corresponds to color temperature, while the vertical (green–magenta) axis has the similar effects to the corresponding color compensation (CC) filters. The horizontal axis is ruled in increments equivalent to about 5 mired, the vertical axis in increments of about 0.05 diffuse density units.



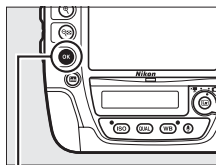
Coordinates

Adjustment

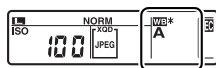


3 Press **OK**.

Press **OK** to save settings and return to the shooting menu. If white balance has been fine-tuned, an asterisk ("*****") will be displayed in the rear control panel.

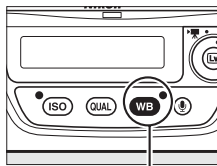


OK button

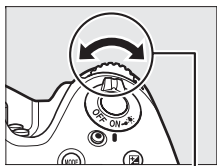


■ The WB Button

At settings other than **K** (Choose color temp.) and **PRE** (Preset manual), the **WB** button can be used to fine-tune white balance on the amber (A)–blue (B) axis (☞ 159; to fine-tune white balance when **PRE** is selected, use the shooting menu as described on page 158). Press the **WB** button and rotate the sub-command dial to fine-tune white balance in steps of 0.5 (with each full increment equivalent to about 5 mired) until the desired value is displayed in the rear control panel. Rotating the sub-command dial to the left increases the amount of amber (A). Rotating the sub-command dial to the right increases the amount of blue (B). At settings other than 0, an asterisk (“*”) appears in the rear control panel.



WB button



Sub-command dial



Rear control panel

🔍 White Balance Fine-Tuning

The colors on the fine-tuning axes are relative, not absolute. For example, moving the cursor to **B** (blue) when a “warm” setting such as **☀** (Incandescent) is selected for white balance will make photographs slightly “colder” but will not actually make them blue.

🔍 “Mired”



Any given change in color temperature produces a greater difference in color at low color temperatures than it would at higher color temperatures. For example, a change of 1000 K produces a much greater change in color at 3000 K than at 6000 K. Mired, calculated by multiplying the inverse of the color temperature by 10^6 , is a measure of color temperature that takes such variation into account, and as such is the unit used in color-temperature compensation filters. E.g.:

- 4000 K–3000 K (a difference of 1000 K)=83 mired
- 7000 K–6000 K (a difference of 1000 K)=24 mired


Choosing a Color Temperature

When (**Choose color temp.**) is selected for white balance, color temperature can be selected using the **White balance** option in the shooting menu or by using the **WB** button, multi selector, and sub-command dial.


Choose Color Temperature

Note that the desired results will not be obtained with flash or fluorescent lighting. Choose  (**Flash**) or  (**Fluorescent**) for these sources. With other light sources, take a test shot to determine if the selected value is appropriate.

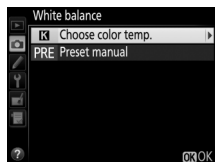
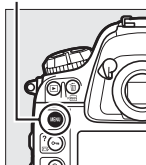
■ The White Balance Menu

Enter values for the amber-blue and green-magenta axes ( 159).





1 Select Choose color temp.

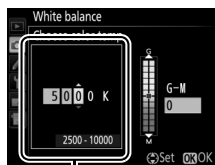
Press the **MENU** button and select **White balance** in the shooting menu. Highlight **Choose color temp.** and press .

MENU button



2 Select a value for amber-blue.

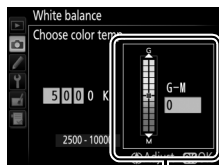
Press  or  to highlight digits and press  or  to change.



Value for amber (A)-blue (B) axis

3 Select a value for green-magenta.

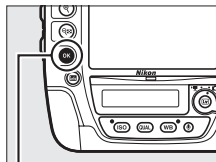
Press ◀ or ▶ to highlight the **G** (green) or **M** (magenta) axis and press ▲ or ▼ to select a value.



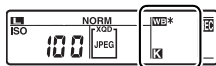
Value for green (G)-magenta (M) axis

4 Press **OK**.

Press **OK** to save changes and return to the shooting menu. If a value other than 0 is selected for the green (G)-magenta (M) axis, an asterisk ("*") will be displayed in the rear control panel.

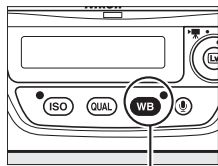


OK button

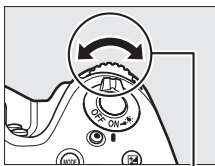


■ The WB Button

The **WB** button can be used to select the color temperature for the amber (A)–blue (B) axis only. Press the **WB** button and rotate the sub-command dial until the desired value is displayed in the rear control panel (adjustments are made in mireds; □ 160). To enter a color temperature directly in increments of 10 K, press the **WB** button and press ◀ or ▶ to highlight a digit and press ▲ or ▼ to change.



WB button



Sub-command dial



Rear control panel



Preset Manual

Preset manual is used to record and recall custom white balance settings for shooting under mixed lighting or to compensate for light sources with a strong color cast. The camera can store up to six values for preset white balance in presets d-1 through d-6. Two methods are available for setting preset white balance:

Method	Description
Direct measurement	Neutral gray or white object is placed under lighting that will be used in final photograph and white balance is measured by camera (☞ 165). In live view photography and movie live view (☞ 49, 63), white balance can be measured in a selected area of the frame (spot white balance, ☞ 169).
Copy from existing photograph	White balance is copied from photo on memory card (☞ 172).



White Balance Presets

Changes to white balance presets apply to all shooting menu banks (☞ 300). A confirmation dialog will be displayed if the user attempts to change a white balance preset created in another shooting menu bank.

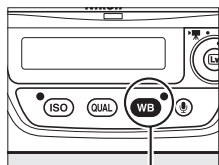
Viewfinder Photography

1 Light a reference object.

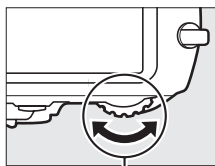
Place a neutral gray or white object under the lighting that will be used in the final photograph. In studio settings, a standard gray panel can be used as a reference object. Note that exposure is automatically increased by 1 EV when measuring white balance; in exposure mode **M**, adjust exposure so that the exposure indicator shows ± 0 (☞ 131).

2 Set white balance to PRE (Preset manual).

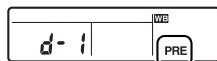
Press the **WB** button and rotate the main command dial until **PRE** is displayed in the rear control panel.



WB button



Main command dial



Rear control panel

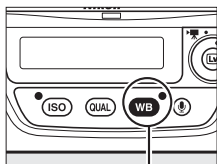
Measuring Preset White Balance (Viewfinder Photography)

Preset manual white balance can not be measured while you are shooting an HDR photograph (☞ 190) or multiple exposure (☞ 214), or when **Record movies** is selected for Custom Setting g4 (**Assign shutter button**, ☞ 357).

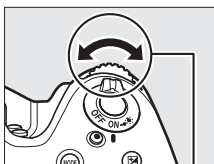


3 Select a preset.

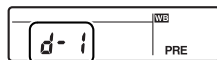
Press the **WB** button and rotate the sub-command dial until the desired white balance preset (d-1 to d-6) is displayed in the rear control panel.



WB button



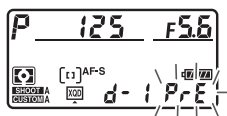
Sub-command dial



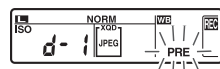
Rear control panel

4 Select direct measurement mode.

Release the **WB** button briefly and then press the button until the **PRE** icon in the rear control panel starts to flash. A flashing **P r E** will also appear in the top control panel and viewfinder. The displays will flash for about six seconds.



Top control panel



Rear control panel



Viewfinder

5 Measure white balance.

Before the indicators stop flashing, frame the reference object so that it fills the viewfinder and press the shutter-release button all the way down.



The camera will measure a value for white balance and store it in the preset selected in Step 3. No photograph will be recorded; white balance can be measured accurately even when the camera is not in focus.

6 Check the results.

If the camera was able to measure a value for white balance, **Good** will flash in the control panels for about six seconds, while the viewfinder will show a flashing **Gd**.



Top control panel

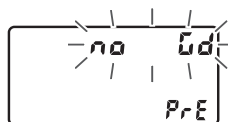


Rear control panel

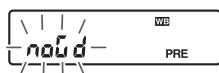


Viewfinder

If lighting is too dark or too bright, the camera may be unable to measure white balance. A flashing **no Gd** will appear in the control panels and viewfinder for about six seconds. Press the shutter-release button halfway to return to Step 5 and measure white balance again.



Top control panel



Rear control panel



Viewfinder



✔ **Direct Measurement Mode**

If no operations are performed during viewfinder photography while the displays are flashing, direct measurement mode will end in the time selected for Custom Setting c2 (**Standby timer**, 324).

✔ **Protected Presets**

If the current preset is protected (176), **P** will flash in the top control panel and viewfinder (and **OK** in the rear control panel) if you attempt to measure a new value.

✔ **Selecting a Preset**

Selecting **Preset manual** for the **White balance** option in the shooting menu displays the dialog shown at right; highlight a preset and press **OK**. If no value currently exists for the selected preset, white balance will be set to 5200 K, the same as **Direct sunlight**.

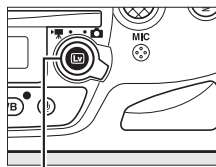


Live View (Spot White Balance)

In live view photography and movie live view (☐ 49, 63), white balance can be measured in a selected area of the frame, eliminating the need to prepare a reference object or change lenses during telephoto photography.

1 Press the **Lv** button.

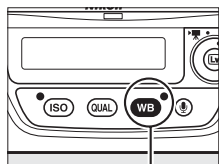
The mirror will be raised and the view through the lens will be displayed in the camera monitor.



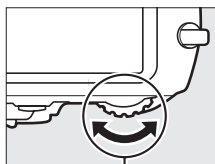
Lv button

2 Set white balance to PRE (Preset manual).

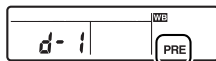
Press the **WB** button and rotate the main command dial until **PRE** is displayed in the rear control panel.



WB button



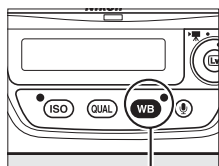
Main command dial



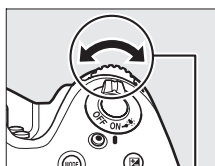
Rear control panel

3 Select a preset.

Press the **WB** button and rotate the sub-command dial until the desired white balance preset (d-1 to d-6) is displayed in the rear control panel.



WB button



Sub-command dial



Rear control panel



4 Select direct measurement mode.

Release the **WB** button briefly and then press the button until the **PRE** icon in the rear control panel starts to flash. A spot white balance target (□) will be displayed at the selected focus point.



Rear control panel

5 Position the target over a white or grey area.

While **PRE** flashes in the display, use the multi selector to position the □ over a white or grey area of the subject. To zoom the area around the target in for more precise positioning, press the \mathcal{Q} button.



6 Measure white balance.

Press the center of the multi selector or press the shutter-release button all the way down to measure white balance. The time available to measure white balance is that selected for Custom Setting c4 (**Monitor off delay**) > **Live view** (□ 325).



If the camera is unable to measure white balance, the message shown at right will be displayed. Choose a new white balance target and repeat the process from Step 4.








7 Exit direct measurement mode.

Press the **WB** button to exit direct measurement mode.

When **Preset manual** is selected for **White balance** in the shooting menu, the position of the target used to measure preset white balance will be displayed on presets recorded during live view photography.



Measuring Preset White Balance (Live View Photography)

Preset manual white balance can not be measured when **Record movies** is selected for Custom Setting g4 (**Assign shutter button**,  357) and the live view selector is rotated to . Preset manual white balance can not be set while an HDR exposure is in progress ( 190) or when a setting other than  is selected for monitor hue ( 56).

Managing Presets

■ Copying White Balance from a Photograph

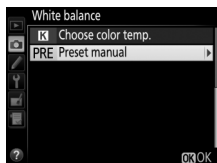
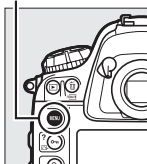
Follow the steps below to copy a value for white balance from an existing photograph to a selected preset.

- 1 Select PRE (Preset manual) for White balance in the shooting menu.**

Press the **MENU** button and select **White balance** in the shooting menu.

Highlight **Preset manual** and press **▶**.

MENU button



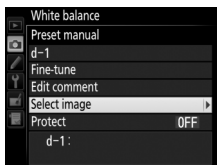
- 2 Select a destination.**

Highlight the destination preset (d-1 to d-6) and press the center of the multi selector.




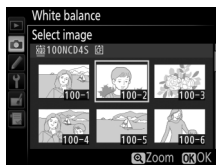
- 3 Choose Select image.**


Highlight **Select image** and press **▶**.

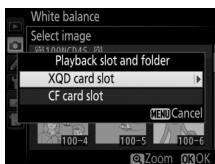


4 Highlight a source image.


Highlight the source image. To view the highlighted image full frame, press and hold the  button.

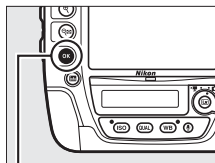


To view images in other locations, press  and select the desired card and folder (see 242).



5 Copy white balance.

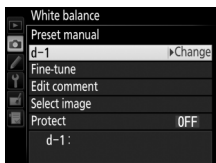
Press  to copy the white balance value for the highlighted photograph to the selected preset. If the highlighted photograph has a comment (see 366), the comment will be copied to the comment for the selected preset.



 button

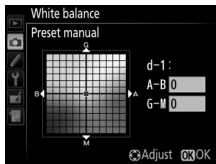
Choosing a White Balance Preset

Press ▲ to highlight the current white balance preset (d-1 – d-6) and press ► to select another preset.



Fine-Tuning Preset White Balance

The selected preset can be fine-tuned by selecting **Fine-tune** and adjusting white balance as described on page 159.

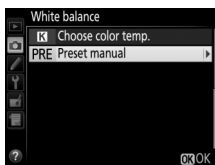


■ Entering a Comment

Follow the steps below to enter a descriptive comment of up to thirty-six characters for a selected white balance preset.

1 Select PRE (Preset manual).

Highlight **Preset manual** in the white balance menu (📖 172) and press ►.



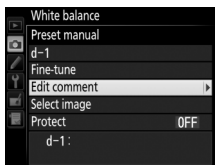
2 Select a preset.

Highlight the desired preset and press the center of the multi selector.



3 Select Edit comment.

Highlight **Edit comment** and press ►.



4 Edit the comment.

Edit the comment as described on page 184.

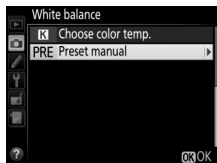


■ Protecting a White Balance Preset

Follow the steps below to protect the selected white balance preset. Protected presets can not be modified and the **Fine-tune** and **Edit comment** options can not be used.

1 Select PRE (Preset manual).

Highlight **Preset manual** in the white balance menu (172) and press ►.



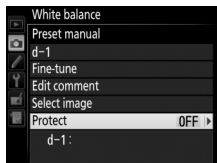
2 Select a preset.

Highlight the desired preset and press the center of the multi selector.



3 Select Protect.

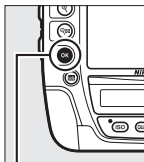
Highlight **Protect** and press ►.



WB

4 Select On.

Highlight **On** and press **OK** to protect the selected white balance preset. To remove protection, select **Off**.



OK button

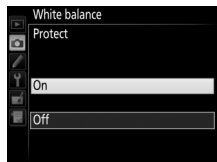








Image Enhancement



Picture Controls

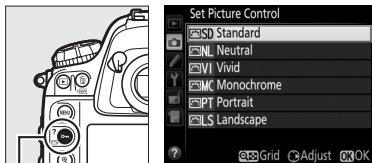
Nikon's unique Picture Control system makes it possible to share image processing settings, including sharpening, contrast, brightness, saturation, and hue, among compatible devices and software.



Selecting a Picture Control

The camera offers a choice of preset Picture Controls. Choose a Picture Control according to the subject or type of scene.

Option	Description
 Standard	Standard processing for balanced results. Recommended for most situations.
 Neutral	Minimal processing for natural results. Choose for photographs that will later be extensively processed or retouched.
 Vivid	Pictures are enhanced for a vivid, photoprint effect. Choose for photographs that emphasize primary colors.
 Monochrome	Take monochrome photographs.
 Portrait	Process portraits for skin with natural texture and a rounded feel.
 Landscape	Produces vibrant landscapes and cityscapes.

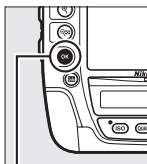
- 1 Press  ( / ?).
A list of Picture Controls will be displayed.



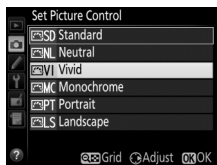
 ( / ?) button

2 Select a Picture Control.

Highlight the desired Picture Control and press **OK**.



OK button

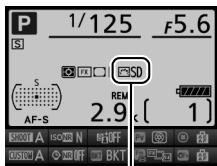


Custom Picture Controls

Custom Picture Controls are created through modifications to existing Picture Controls using the **Manage Picture Control** option in the shooting menu (183). Custom Picture Controls can be saved to a memory card for sharing among other cameras of the same model and compatible software (186).

The Picture Control Indicator

The current Picture Control is shown in the information display when the **Info** button is pressed.



Picture Control indicator

The Shooting Menu

Picture Controls can also be selected using the **Set Picture Control** option in the shooting menu (299).

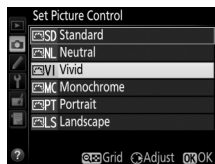


Modifying Picture Controls

Existing preset or custom Picture Controls (📖 183) can be modified to suit the scene or the user's creative intent. Choose a balanced combination of settings using **Quick adjust**, or make manual adjustments to individual settings.

1 Select a Picture Control.


Highlight the desired Picture Control in the Picture Control list (📖 177) and press ►.



2 Adjust settings.

Press ▲ or ▼ to highlight the desired setting and press ◀ or ▶ to choose a value (📖 180).

Repeat this step until all settings have been adjusted, or

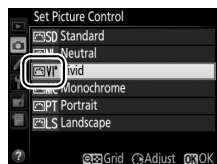
select **Quick adjust** to choose a preset combination of settings. Default settings can be restored by pressing the  (FORMAT) button.



3 Press OK.

Modifications to Original Picture Controls

Picture Controls that have been modified from default settings are indicated by an asterisk ("*") in the **Set Picture Control** menu.





Picture Control Settings

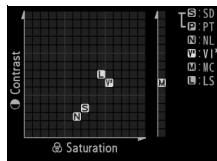
Option	Description
Quick adjust	Choose from options between -2 and +2 to reduce or exaggerate the effect of the selected Picture Control (note that this resets all manual adjustments). For example, choosing positive values for Vivid makes pictures more vivid. Not available with Neutral , Monochrome , or custom Picture Controls.
Manual adjustments (all Picture Controls)	Sharpening Control the sharpness of outlines. Select A to adjust sharpening automatically according to the type of scene, or choose from values between 0 (no sharpening) and 9 (the higher the value, the greater the sharpening).
	Contrast Select A to adjust contrast automatically according to the type of scene, or choose from values between -3 and +3 (choose lower values to prevent highlights in portrait subjects from being “washed out” in direct sunlight, higher values to preserve detail in misty landscapes and other low-contrast subjects).
	Brightness Choose -1 for reduced brightness, +1 for enhanced brightness. Does not affect exposure.
Manual adjustments (non-monochrome only)	Saturation Control the vividness of colors. Select A to adjust saturation automatically according to the type of scene, or choose from values between -3 and +3 (lower values reduce saturation and higher values increase it).
	Hue Choose negative values (to a minimum of -3) to make reds more purple, blues more green, and greens more yellow, positive values (up to +3) to make reds more orange, greens more blue, and blues more purple.
Manual adjustments (monochrome only)	Filter effects Simulate the effect of color filters on monochrome photographs. Choose from OFF , yellow, orange, red, and green (☞ 181).
	Toning Choose the tint used in monochrome photographs from B&W (black-and-white), Sepia , Cyanotype (blue-tinted monochrome), Red , Yellow , Green , Blue Green , Blue , Purple Blue , Red Purple (☞ 182).

✓ "A" (Auto)

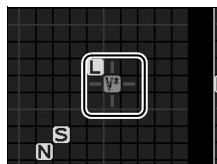
Results for auto sharpening, contrast, and saturation vary with exposure and the position of the subject in the frame. Use a type G, E, or D lens for best results.

✎ The Picture Control Grid

Pressing the  button in Step 2 on page 179 displays a Picture Control grid showing the contrast and saturation for the selected Picture Control in relation to the other Picture Controls (only contrast is displayed when **Monochrome** is selected). Release the  button to return to the Picture Control menu.



The icons for Picture Controls that use auto contrast and saturation are displayed in green in the Picture Control grid, and lines appear parallel to the axes of the grid.



✎ Previous Settings

The line under the value display in the Picture Control setting menu indicates the previous value for the setting. Use this as a reference when adjusting settings.



✎ Filter Effects (Monochrome Only)

The options in this menu simulate the effect of color filters on monochrome photographs. The following filter effects are available:

Option	Description
Y Yellow	Enhances contrast. Can be used to tone down the brightness of the sky in landscape photographs. Orange produces more contrast than yellow, red more contrast than orange.
O Orange	
R Red	
G Green	Softens skin tones. Can be used for portraits.

Note that the effects achieved with **Filter effects** are more pronounced than those produced by physical glass filters.



Toning (Monochrome Only)

Pressing ▼ when **Toning** is selected displays saturation options. Press ◀ or ▶ to adjust saturation. Saturation control is not available when **B&W** (black-and-white) is selected.



Custom Picture Controls

The options available with custom Picture Controls are the same as those on which the custom Picture Control was based.



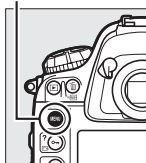
Creating Custom Picture Controls

The preset Picture Controls supplied with the camera can be modified and saved as custom Picture Controls.

1 Select Manage Picture Control in the shooting menu.

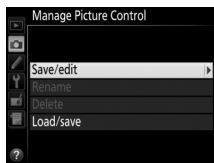
To display the menus, press the **MENU** button. Highlight **Manage Picture Control** in the shooting menu and press **▶**.

MENU button



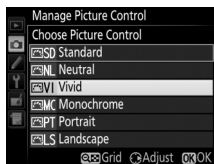
2 Select Save/edit.

Highlight **Save/edit** and press **▶**.





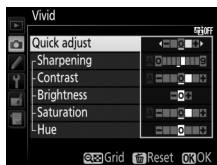
3 Select a Picture Control.

Highlight an existing Picture Control and press **▶**, or press **OK** to proceed to Step 5 to save a copy of the highlighted Picture Control without further modification.




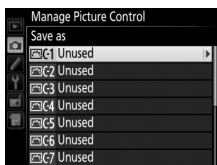
4 Edit the selected Picture Control.

See page 180 for more information. To abandon any changes and start over from default settings, press the  (FORMAT) button. Press  when settings are complete.



5 Select a destination.

Choose a destination for the custom Picture Control (C-1 through C-9) and press .







6 Name the Picture Control.

The text-entry dialog shown at right will be displayed. By default, new Picture Controls are named



Keyboard area

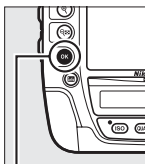
Name area

by adding a two-digit number (assigned automatically) to the name of the existing Picture Control; to use the default name, proceed to Step 7. To move the cursor in the name area, hold the  button and press  or . To enter a new letter at the current cursor position, use the multi selector to highlight the desired character in the keyboard area and press the center of the multi selector. To delete the character at the current cursor position, press the  (FORMAT) button.

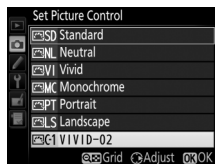
Custom Picture Control names can be up to nineteen characters long. Any characters after the nineteenth will be deleted.

7 Save changes and exit.

Press **OK** to save changes and exit. The new Picture Control will appear in the Picture Control list.



OK button



Manage Picture Control > Rename

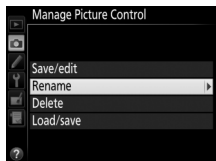
Custom Picture Controls can be renamed at any time using the **Rename** option in the **Manage Picture Control** menu.

Manage Picture Control > Delete

The **Delete** option in the **Manage Picture Control** menu can be used to delete selected custom Picture Controls when they are no longer needed.

The Original Picture Control Icon

The original preset Picture Control on which the custom Picture Control is based is indicated by an icon in the top right corner of the edit display.



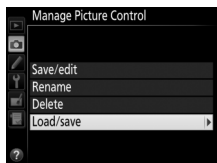
Original Picture Control icon



Sharing Custom Picture Controls

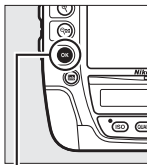
Custom Picture Controls created using the Picture Control Utility available with ViewNX 2 or optional software such as Capture NX 2 can be copied to a memory card and loaded into the camera, or custom Picture Controls created with the camera can be copied to the memory card to be used in other D4S cameras and compatible software and then deleted when no longer needed (if two memory cards are inserted, the card in the primary slot will be used; □ 96).

To copy custom Picture Controls to or from the memory card, or to delete custom Picture Controls from the memory card, highlight **Load/Save** in the **Manage Picture Control** menu and press **▶**. The following options will be displayed:



- **Copy to camera:** Copy custom Picture Controls from the memory card to custom Picture Controls C-1 through C-9 on the camera and name them as desired.

- **Delete from card:** Delete selected custom Picture Controls from the memory card. The confirmation dialog shown at right will be displayed before a Picture Control is deleted; to delete the selected Picture Control, highlight **Yes** and press **OK**.



OK button



- **Copy to card:** Copy a custom Picture Control (C-1 through C-9) from the camera to a selected destination (1 through 99) on the memory card.

Saving Custom Picture Controls

Up to 99 custom Picture Controls can be stored on the memory card at any one time. The memory card can only be used to store user-created custom Picture Controls. The preset Picture Controls supplied with the camera (📖 177) can not be copied to the memory card, renamed, or deleted.



Preserving Detail in Highlights and Shadows

Active D-Lighting

Active D-Lighting preserves details in highlights and shadows, creating photographs with natural contrast. Use for high contrast scenes, for example when photographing brightly lit outdoor scenery through a door or window or taking pictures of shaded subjects on a sunny day. It is most effective when used with matrix metering (☞ 123).



Active D-Lighting off



Active D-Lighting: 暗A Auto



“Active D-Lighting” versus “D-Lighting”

The **Active D-Lighting** option in the shooting menu adjusts exposure before shooting to optimize the dynamic range, while the **D-Lighting** option in the retouch menu (☞ 379) brightens shadows in images after shooting.

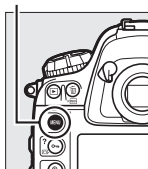
To use Active D-Lighting:

1 Select Active D-Lighting in the shooting menu.

To display the menus, press the **MENU** button. Highlight **Active D-Lighting** in the shooting menu and press

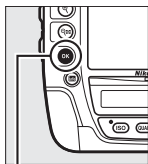


MENU button

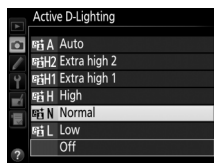


2 Choose an option.

Highlight the desired option and press **OK**. If **Auto** is selected, the camera will automatically adjust Active D-Lighting according to shooting conditions (in exposure mode **M**, however, **Auto** is equivalent to **Normal**).





OK button



Active D-Lighting

Active D-Lighting can not be used with movies. Noise (randomly-spaced bright pixels, fog, or lines) may appear in photographs taken with Active D-Lighting. Uneven shading may be visible with some subjects. Active D-Lighting can not be used at ISO sensitivities of Hi 0.3 or above.

See Also

When **ADL bracketing** is selected for Custom Setting e6 (**Auto bracketing set**,  333), the camera varies Active D-Lighting over a series of shots ( 150).



High Dynamic Range (HDR)

Used with high-contrast subjects, High Dynamic Range (HDR) preserves details in highlights and shadows by combining two shots taken at different exposures. HDR is most effective when used with matrix metering (□ 123; with other metering methods and a non-CPU lens, an exposure differential of **Auto** is equivalent to about 2 EV). It can not be used to record NEF (RAW) images. Movie recording (□ 63), flash lighting (□ 195), bracketing (□ 140), multiple exposure (□ 214), and time-lapse photography (□ 229) can not be used while HDR is in effect and shutter speeds of $\frac{1}{250}$ and $\frac{1}{500}$ are not available.



First exposure
(darker)

+



Second exposure
(brighter)



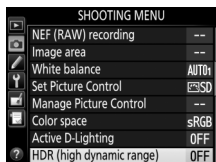
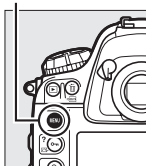
Combined HDR
image

1 Select HDR (high dynamic range).

Press the MENU button to display the menus.

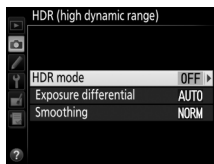
Highlight **HDR (high dynamic range)** in the shooting menu and press ►.

MENU button



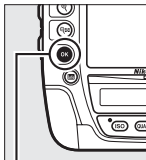
2 Select a mode.

Highlight **HDR mode** and press **▶**.

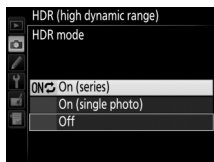


Highlight one of the following and press **OK**.

- **To take a series of HDR photographs**, select **ON↻ On (series)**. HDR shooting will continue until you select **Off** for **HDR mode**.

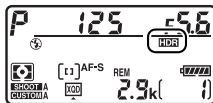


OK button



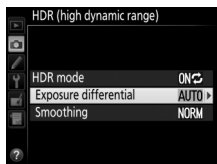
- **To take one HDR photograph**, select **On (single photo)**. Normal shooting will resume automatically after you have created a single HDR photograph.
- **To exit without creating additional HDR photographs**, select **Off**.

If **On (series)** or **On (single photo)** is selected, a **HDR** icon will be displayed in the top control panel.

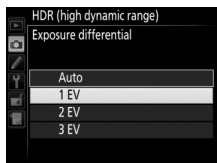


3 Choose the exposure differential.

To choose the difference in exposure between the two shots, highlight **Exposure differential** and press ►.

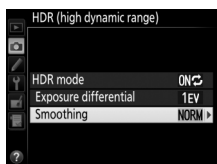


The options shown at right will be displayed. Highlight an option and press **OK**. Choose higher values for high-contrast subjects, but note that choosing a value higher than required may not produce the desired results; if **Auto** is selected, the camera will automatically adjust exposure to suit the scene.

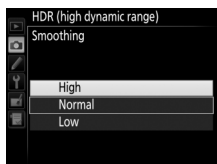


4 Choose the amount of smoothing.

To choose how much the boundaries between the two images are smoothed, highlight **Smoothing** and press ►.

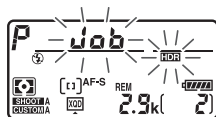


The options shown at right will be displayed. Highlight an option and press **OK**. Higher values produce a smoother composite image. Uneven shading may be visible with some subjects.



5 Frame a photograph, focus, and shoot.


The camera takes two exposures when the shutter-release button is pressed all the way down. “Job HDR” will be displayed in the top control panel and *Job Hdr* in the viewfinder while the images are combined; no photographs can be taken until recording is complete. Regardless of the option currently selected for release mode, only one photograph will be taken each time the shutter-release button is pressed.



Top control panel






Viewfinder

If **On (series)** is selected, HDR will only turn off when **Off** is selected for **HDR mode**; if **On (single photo)** is selected, HDR turns off automatically after the photograph is taken. The  icon clears from the display when HDR shooting ends.

Framing HDR Photographs

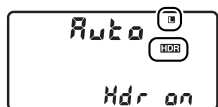
The edges of the image may be cropped out. The desired results may not be achieved if the camera or subject moves during shooting. Use of a tripod is recommended. Depending on the scene, shadows may appear around bright objects or halos may appear around dark objects; this effect can be reduced by adjusting the amount of smoothing.

The BKT Button

If **HDR (high dynamic range)** is selected for Custom Setting f9 (**Assign BKT button**;  344), you can select the HDR mode by pressing the **BKT** button and rotating the main command dial and the exposure differential by pressing the **BKT** button and rotating the sub-command dial. The mode and exposure differential are shown in the top control panel:  and 

appear when **On (series)** is selected and 




when **On (single photo)** is selected; no icon appears when HDR is off.



Interval Timer Photography

If **On (series)** is selected for **HDR mode** before interval timer shooting begins, the camera will continue to shoot HDR photographs at the selected interval (if **On (single photo)** is selected, interval timer shooting will end after a single shot).

Shooting Menu Banks

HDR settings can be adjusted separately for each bank ( 300), but switching to a bank in which HDR is active during multiple exposure ( 214) or interval timer shooting ( 221) disables HDR. HDR is also disabled if you switch to a bank in which an NEF (RAW) option is selected for image quality.



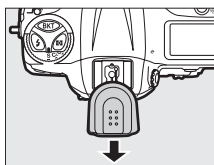


Flash Photography

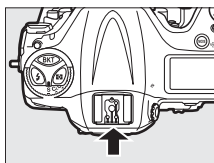
Using a Flash

The camera supports the Nikon Creative Lighting System (CLS) and can be used with CLS-compatible flash units. Optional flash units can be attached directly to the camera accessory shoe as described below. The accessory shoe is equipped with a safety lock for flash units with a locking pin.

- 1 Remove the accessory shoe cover.**



- 2 Mount the flash unit on the accessory shoe.**
See the manual provided with the flash unit for details.



The Sync Terminal

A sync cable can be connected to the sync terminal as required. Do not connect another flash unit via a sync cable when performing rear-curtain sync flash photography with a flash unit mounted on the camera accessory shoe.



The Nikon Creative Lighting System (CLS)


Nikon's advanced Creative Lighting System (CLS) offers improved communication between the camera and compatible flash units for improved flash photography.

■ CLS-Compatible Flash Units

The camera can be used with the following CLS-compatible flash units:

- **The SB-910, SB-900, SB-800, SB-700, SB-600, SB-400, SB-300, and SB-R200:**

Flash unit		SB-910 ¹	SB-900 ¹	SB-800	SB-700 ¹	SB-600	SB-400 ²	SB-300 ²	SB-R200 ³
Feature									
Guide	ISO 100	34/111	34/111	38/125	28/92	30/98	21/69	18/59	10/33
No. ⁴	ISO 200	48/157	48/157	53/174	39/128	42/138	30/98	25/82	14/46

- 1 If a color filter is attached to the SB-910, SB-900, or SB-700 when AUTO or  (flash) is selected for white balance, the camera will automatically detect the filter and adjust white balance appropriately.
 - 2 Wireless flash control is not available.
 - 3 Controlled remotely with optional SB-910, SB-900, SB-800, or SB-700 flash unit or SU-800 wireless Speedlight commander.
 - 4 m/ft, 20 °C (68 °F), SB-910, SB-900, SB-800, SB-700, and SB-600 at 35 mm zoom head position; SB-910, SB-900, and SB-700 with standard illumination.
- **SU-800 Wireless Speedlight Commander:** When mounted on a CLS-compatible camera, the SU-800 can be used as a commander for remote SB-910, SB-900, SB-800, SB-700, SB-600, or SB-R200 flash units in up to three groups. The SU-800 itself is not equipped with a flash.



Guide Number

To calculate the range of the flash at full power, divide the Guide Number by the aperture. If, for example, the flash unit has a Guide Number of 34 m or 111 ft (ISO 100, 20 °C/68 °F); its range at an aperture of f/5.6 is $34 \div 5.6$ or about 6.1 meters (or in feet, $111 \div 5.6 =$ approximately 19 ft 10 in.). For each twofold increase in ISO sensitivity, multiply the Guide Number by the square root of two (approximately 1.4).

The following features are available with CLS-compatible flash units:

		CLS-compatible flash units									
		SB-910 SB-900 SB-800	SB-700	SB-600	SU-800			SB-R200	SB-400	SB-300	
					Commander	Close-up photography					
Single flash	i-TTL	i-TTL balanced fill-flash for digital SLR ¹	✓	✓	✓	—	—	—	✓	✓	
		Standard i-TTL flash for digital SLR	✓ ²	✓	✓ ²	—	—	—	✓	✓	
	AA	Auto aperture	✓ ³	—	—	—	—	—	—	—	
	A	Non-TTL auto	✓ ³	—	—	—	—	—	—	—	
	GN	Distance-priority manual	✓	✓	—	—	—	—	—	—	
	M	Manual	✓	✓	✓	—	—	—	✓ ⁴	✓ ⁴	
	RPT	Repeating flash	✓	✓	—	—	—	—	—	—	
Advanced Wireless Lighting	Master	Remote flash control	✓	✓	—	✓	✓	—	—	—	
		i-TTL i-TTL	✓	✓	—	—	—	—	—	—	
		[A:B]	Quick wireless flash control	—	✓	—	—	✓	—	—	—
		AA	Auto aperture	✓ ⁵	—	—	—	—	—	—	—
		A	Non-TTL auto	✓	—	—	—	—	—	—	—
		M	Manual	✓	✓	—	—	—	—	—	—
		RPT	Repeating flash	✓	✓	—	—	—	—	—	—
	Remote	i-TTL	i-TTL	✓	✓	✓	—	—	✓	—	—
		[A:B]	Quick wireless flash control	✓	✓	✓	—	—	✓	—	—
		AA	Auto aperture	✓ ⁵	—	—	—	—	—	—	—
		A	Non-TTL auto	✓	—	—	—	—	—	—	—
		M	Manual	✓	✓	✓	—	—	✓	—	—
		RPT	Repeating flash	✓	✓	✓	—	—	—	—	—
			Flash Color Information Communication	✓	✓	✓	—	—	—	✓	✓
	Auto FP High-Speed Sync ⁶	✓	✓	✓	✓	✓	✓	—	—		
	FV lock ⁷	✓	✓	✓	✓	✓	✓	✓	✓		
	AF-assist for multi-area AF	✓	✓	✓	✓	—	—	—	—		
	Red-eye reduction	✓	✓	✓	—	—	—	✓	—		
	Camera modeling illumination	✓	✓	✓	✓	✓	✓	—	—		
	Camera flash mode selection	—	—	—	—	—	—	✓	✓		
	Camera flash unit firmware update	✓ ⁸	✓	—	—	—	—	—	✓		



- 1 Not available with spot metering.
- 2 Can also be selected with flash unit.
- 3 AA/A mode selection performed on flash unit using custom settings. Unless lens data have been provided using the **Non-CPU lens data** option in the setup menu, "A" will be selected when a non-CPU lens is used.
- 4 Can only be selected with camera.
- 5 Unless lens data have been provided using the **Non-CPU lens data** option in the setup menu, non-TTL auto (A) is used with non-CPU lenses, regardless of mode selected with flash unit.
- 6 Available only in i-TTL, AA, A, GN, and M flash-control modes.
- 7 Available only in i-TTL, AA, and A flash-control modes.
- 8 Firmware updates for the SB-910 and SB-900 can be performed from the camera.




Modeling Illumination

CLS-compatible flash units such as the SB-910, SB-900, SB-800, SB-700, and SB-600 emit a modeling flash when the camera **Pv** button is pressed. This feature can be used with Advanced Wireless Lighting to preview the total lighting effect achieved with multiple flash units. Modeling illumination can be turned off using Custom Setting e5 **Modeling flash** (□ 333).

Other Flash Units

The following flash units can be used in non-TTL auto and manual modes.

Flash unit	SB-80DX, SB-28DX, SB-28, SB-26, SB-25, SB-24	SB-50DX	SB-30, SB-27 ¹ , SB-22S, SB-22, SB-20, SB-16B, SB-15	SB-23, SB-29 ² , SB-21B ² , SB-29S ²
A Non-TTL auto	✓	—	✓	—
M Manual	✓	✓	✓	✓
 Repeating flash	✓	—	—	—
REAR Rear-curtain sync ³	✓	✓	✓	✓

- Flash mode is automatically set to TTL and shutter-release is disabled. Set flash unit to **A** (non-TTL auto flash).
- Autofocus is available with AF-S VR Micro-Nikkor 105mm f/2.8G IF-ED and AF-S Micro NIKKOR 60mm f/2.8G ED lenses only.
- Available when camera is used to select flash mode.

Notes on Optional Flash Units

Refer to the flash unit manual for detailed instructions. If the unit supports CLS, refer to the section on CLS-compatible digital SLR cameras. The D4S is not included in the “digital SLR” category in the SB-80DX, SB-28DX, and SB-50DX manuals.

i-TTL flash control can be used at ISO sensitivities between 100 and 12800. At values over 12800, the desired results may not be achieved at some ranges or aperture settings. If the flash-ready indicator flashes for about three seconds after a photograph is taken in i-TTL or non-TTL auto mode, the flash has fired at full power and the photograph may be underexposed.

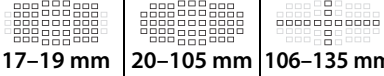

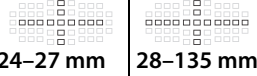
When an SC-series 17, 28, or 29 sync cable is used for off-camera flash photography, correct exposure may not be achieved in i-TTL mode. We recommend that you select standard i-TTL flash control. Take a test shot and view the results in the monitor.

In i-TTL, use the flash panel or bounce adapter provided with the flash unit. Do not use other panels such as diffusion panels, as this may produce incorrect exposure.



Notes on Optional Flash Units (Continued)

The SB-910, SB-900, SB-800, SB-700, SB-600, and SB-400 provide red-eye reduction, while the SB-910, SB-900, SB-800, SB-700, SB-600, and SU-800 provide AF-assist illumination with the following restrictions:

- SB-910 and SB-900:** AF-assist illumination is available with 17–135 mm AF lenses, however, autofocus is available only with the focus points shown at right.

- SB-800, SB-600, and SU-800:** AF-assist illumination is available with 24–105 mm AF lenses, however, autofocus is available only with the focus points shown at right.

- SB-700:** AF-assist illumination is available with 24–135 mm AF lenses, however, autofocus is available only with the focus points shown at right.


In exposure mode **P**, the maximum aperture (minimum f-number) is limited according to ISO sensitivity, as shown below:














Maximum aperture at ISO equivalent of:							
100	200	400	800	1600	3200	6400	12800
4	4.8	5.6	6.7	8	9.5	11	13

If the maximum aperture of the lens is smaller than given above, the maximum value for aperture will be the maximum aperture of the lens.



Flash Control Mode

The information display shows the flash control mode for optional flash units as follows:

	Flash sync	Auto FP (📖 331)
i-TTL		
Auto aperture (AA)		
Non-TTL auto flash (A)		
Distance-priority manual (GN)		
Manual		
Repeating flash		—
Advanced wireless lighting		

Use Only Nikon Flash Accessories

Use only Nikon flash units. Negative voltages or voltages over 250 V applied to the accessory shoe could not only prevent normal operation, but damage the sync circuitry of the camera or flash. Before using a Nikon flash unit not listed in this section, contact a Nikon-authorized service representative for more information.



i-TTL Flash Control

When a CLS-compatible flash unit is set to TTL, the camera automatically selects one of the following types of flash control:








i-TTL balanced fill-flash for digital SLR: Flash unit emits series of nearly invisible preflashes (monitor preflashes) immediately before main flash. Preflashes reflected from objects in all areas of frame are picked up by RGB sensor with approximately 91K (91,000) pixels and are analyzed in combination with range information from matrix metering system to adjust flash output for natural balance between main subject and ambient background lighting. If type G, E, or D lens is used, distance information is included when calculating flash output. Precision of calculation can be increased for non-CPU lenses by providing lens data (focal length and maximum aperture; see □ 235). Not available when spot metering is used.

Standard i-TTL flash for digital SLR: Flash output adjusted to bring lighting in frame to standard level; brightness of background is not taken into account. Recommended for shots in which main subject is emphasized at expense of background details, or when exposure compensation is used. Standard i-TTL flash for digital SLR is activated automatically when spot metering is selected.




Flash Modes

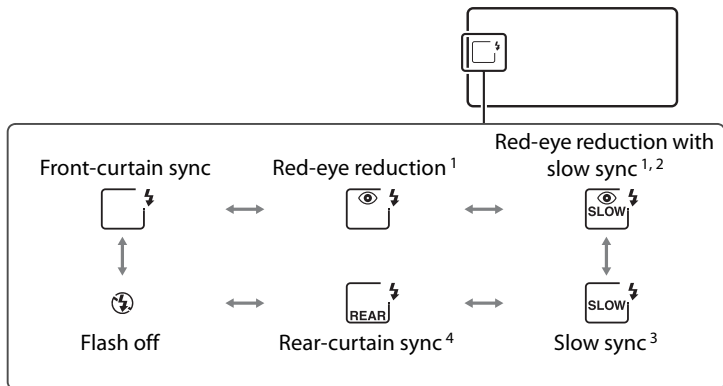
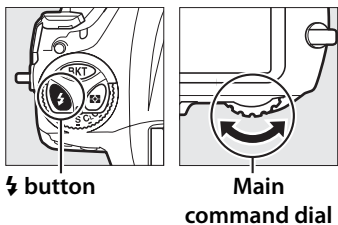
The camera supports the following flash modes:




Flash mode	Description
 Front-curtain sync	This mode is recommended for most situations. In programmed auto and aperture-priority auto modes, shutter speed will automatically be set to values between $1/250$ and $1/60$ s ($1/8000$ to $1/60$ s with Auto FP High-Speed Sync;  331).
 Red-eye reduction	Choose this mode (available with SB-910, SB-900, SB-800, SB-700, SB-600, and SB-400 only) to reduce “red-eye” effect sometimes caused by flash. Not recommended with moving subjects or in other situations in which quick shutter response is required. Do not move camera during shooting.
 Red-eye reduction with slow sync	Combines red-eye reduction with slow sync. Use for portraits taken against a backdrop of night scenery. Available only with SB-910, SB-900, SB-800, SB-700, SB-600, and SB-400 in programmed auto and aperture-priority auto exposure modes. Use of a tripod is recommended to prevent blurring caused by camera shake.
 Slow sync	Flash is combined with shutter speeds as slow as 30 s to capture both subject and background at night or under dim light. This mode is only available in programmed auto and aperture-priority auto exposure modes. Use of tripod is recommended to prevent blurring caused by camera shake.
 Rear-curtain sync	In shutter-priority auto or manual exposure mode, flash fires just before the shutter closes. Use to create effect of a stream of light behind moving objects. In programmed auto and aperture-priority auto, slow rear-curtain sync is used to capture both subject and background. Use of tripod is recommended to prevent blurring caused by camera shake.
 Flash off	The flash does not fire.



■ ■ Choosing a Flash Mode

To choose the flash mode, press the  button and rotate the main command dial until the desired flash mode is selected in the top control panel:



- 1  icon flashes if flash unit does not support red-eye reduction.
- 2 Red-eye reduction with slow sync is available only in exposure modes **P** and **A**. In modes **S** and **M**, red-eye reduction with slow sync becomes red-eye reduction.
- 3 Available only in exposure modes **P** and **A**. In modes **S** and **M**, slow sync becomes front-curtain sync.
- 4 In exposure modes **P** and **A**, flash-sync mode will be set to slow rear-curtain sync when the  button is released. 


Studio Flash Systems

Rear-curtain sync can not be used with studio flash systems, as the correct synchronization can not be obtained.




Shutter Speed and Aperture

Shutter speed and aperture can be set as follows when an optional flash unit is used:

Mode	Shutter speed	Aperture	See page
P	Set automatically by camera ($1/250$ s– $1/60$ s) ^{1,2}	Set automatically by camera	127
S	Value selected by user ($1/250$ s–30 s) ²		128
A	Set automatically by camera ($1/250$ s– $1/60$ s) ^{1,2}	Value selected by user ³	129
M	Value selected by user ($1/250$ s–30 s, b , l , b , - -) ²		130

- 1 Shutter speed may be set as slow as 30 s in slow sync, slow rear-curtain sync, and slow sync with red-eye reduction flash modes.
- 2 Speeds as fast as $1/8000$ s are available with optional flash units that support auto FP high-speed sync when **1/250 s (Auto FP)** is selected for Custom Setting e1 (**Flash sync speed**,  331).
- 3 Flash range varies with aperture and ISO sensitivity. When setting aperture in exposure modes **A** and **M**, consult the table of flash ranges provided with optional flash unit.


See Also

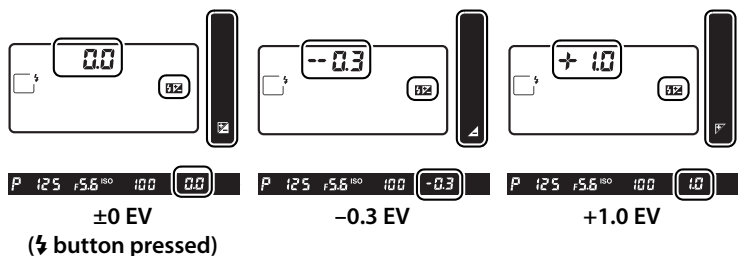
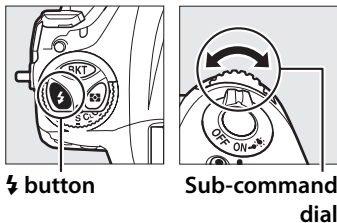
For information on choosing a flash sync speed, see Custom Setting e1 (**Flash sync speed**,  331). For information on choosing the slowest shutter speed available when using the flash, see Custom Setting e2 (**Flash shutter speed**,  332). For information on turning the flash on or off using the **Fn** button, see Custom Setting f3 (**Assign Fn button**,  337).







Flash Compensation

Flash compensation is used to alter flash output by from -3 EV to $+1$ EV in increments of $\frac{1}{3}$ EV, changing the brightness of the main subject relative to the background. Flash output can be increased to make the main subject appear brighter, or reduced to prevent unwanted highlights or reflections. In general, choose positive values to make the main subject brighter, negative values to make it darker.

To choose a value for flash compensation, press the  button and rotate the sub-command dial until the desired value is displayed in the top control panel.





At values other than ± 0.0 , a  icon will be displayed in the top control panel and  will be displayed in the viewfinder after you release the  button. The current value for flash compensation can be confirmed by pressing the  button.

Normal flash output can be restored by setting flash compensation to ± 0.0 . Flash compensation is not reset when the camera is turned off.

Optional Flash Units

The flash compensation selected with the optional flash unit is added to the flash compensation selected with the camera.

See Also

For information on choosing the size of the increments available for flash compensation, see Custom Setting b3 (**Exp./flash comp. step value**,  321). For information on choosing whether flash compensation is applied in addition to exposure compensation when the flash is used, see Custom Setting e4 (**Exposure comp. for flash**,  333). For information on automatically varying flash level over a series of shots, see page 140.



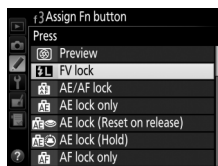
FV Lock

This feature is used to lock flash output, allowing photographs to be recomposed without changing the flash level and ensuring that flash output is appropriate to the subject even when the subject is not positioned in the center of the frame. Flash output is adjusted automatically for any changes in ISO sensitivity and aperture. FV lock is available with CLS compatible flash units only (☞ 196).

To use FV lock:

1 Assign FV lock to a camera control.

Select **FV lock** as the “press” option for Custom Setting f3 (**Assign Fn button**, ☞ 337), f4 (**Assign preview button**, ☞ 342), or f5 (**Assign sub-selector center**, ☞ 342).



2 Attach a CLS-compatible flash unit.

Mount a CLS-compatible flash unit (☞ 197) on the camera accessory shoe.

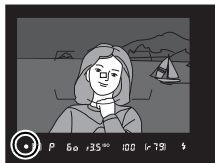
3 Set the flash unit to the appropriate mode.

Turn the flash unit on and set the flash mode to TTL, monitor pre-flash AA, or monitor pre-flash A. See the Speedlight instruction manual for details.



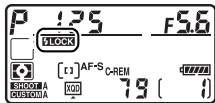
4 Focus.

Position the subject in the center of the frame and press the shutter-release button halfway to focus.

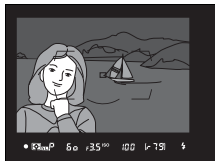


5 Lock flash level.

After confirming that the flash-ready indicator (⚡) is displayed in the viewfinder, press the button selected in Step 1. The flash will emit a monitor preflash to determine the appropriate flash level. Flash output will be locked at this level and FV lock icons (⚡LOCK and ⚡) will appear in the top control panel and viewfinder.



6 Recompose the photograph.





7 Take the photograph.

Press the shutter-release button the rest of the way down to shoot. If desired, additional pictures can be taken without releasing FV lock.



8 Release FV lock.

Press the button selected in Step 1 to release FV lock. Confirm that the FV lock icons ( and ) are no longer displayed in the top control panel and viewfinder.

Metering

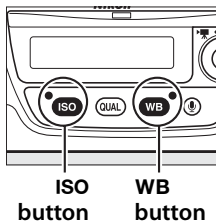
The metering areas for FV lock are as follows:

Flash unit	Flash mode	Metered area
Stand-alone flash unit	i-TTL	6-mm circle in center of frame
	AA	Area metered by flash exposure meter
Used with other flash units (Advanced Wireless Lighting)	i-TTL	Entire frame
	AA	Area metered by flash exposure meter
	A (master flash)	

Other Shooting Options

Two-Button Reset: Restoring Default Settings

The camera settings listed below can be restored to default values by holding the **ISO** and **WB** buttons down together for more than two seconds (these buttons are marked by a green dot). The control panels turn off briefly while settings are reset.



■ ■ Settings Accessible from the Shooting Menu ¹

Option	Default
Extended menu banks	Off
Image quality	JPEG normal
JPEG/TIFF recording	
Image size	Large
NEF (RAW) recording	
Image size	Large
White balance	Auto > Normal
Fine-tuning	A-B: 0, G-M: 0
Picture Control settings ²	Unmodified
HDR (high dynamic range)	Off ³
ISO sensitivity settings	
ISO sensitivity	100
Auto ISO sensitivity control	Off

Option	Default
Multiple exposure	Off ⁴
Interval timer shooting	Off ⁵
Live view photography	Quiet
Movie settings >	
Movie ISO sensitivity settings	
ISO sensitivity (mode M)	200
Auto ISO control (mode M)	Off
Maximum sensitivity	25600

1 With the exception of multiple exposure and interval timer settings, only settings in the bank currently selected using the **Shooting menu bank** option will be reset (☐ 300). Settings in the remaining banks are unaffected.

2 Current Picture Control only.

3 Exposure differential and smoothing are not reset.

4 If multiple exposure is currently in progress, shooting will end and multiple exposure will be created from exposures recorded to that point. Gain and number of shots are not reset.

5 If interval timer shooting is currently in progress, shooting will end. Starting time, shooting interval, number of intervals and shots, and exposure smoothing are not reset.



■ ■ Other Settings

Option	Default	Option	Default
Focus point ¹	Center	Live view monitor hue	--
Preset focus point	Center	Metering	Matrix metering
Exposure mode	Programmed auto	Bracketing	Off ²
Flexible program	Off	Flash mode	Front-curtain sync
Exposure compensation	Off	Flash compensation	Off
AE lock hold	Off	FV lock	Off
Aperture lock	Off	Exposure delay mode	Off ³
Shutter speed lock	Off		
Autofocus mode	AF-S		
AF-area mode			
Viewfinder	Single-point AF		
Live view/movie	Normal-area AF		

- 1 Focus point not displayed if auto-area AF is selected for AF-area mode.
- 2 Number of shots is reset to zero. Bracketing increment is reset to 1EV (exposure/flash bracketing) or 1 (white balance bracketing). **AF-A Auto** is selected for the second shot of two-shot ADL bracketing programs.
- 3 Only settings in the bank currently selected using the **Custom settings bank** option will be reset (□ 311). Settings in the remaining banks are unaffected.

See Also

See page 430 for a list of default settings.




Multiple Exposure

Follow the steps below to record a series of two to ten exposures in a single photograph. Multiple exposures can make use of RAW data from the camera image sensor to produce colors noticeably superior to those in software-generated photographic overlays.

■ Creating a Multiple Exposure

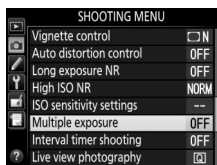
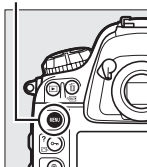
Multiple exposures can not be recorded in live view. Exit live view before proceeding. Note that at default settings, shooting will end and a multiple exposure will be recorded automatically if no operations are performed for 30 s.

Extended Recording Times

For an interval between exposures of more than 30 s, extend the meter-off delay using Custom Setting c2 (**Standby timer**,  324). The maximum interval between exposures is 30 s longer than the option selected for Custom Setting c2. If no operations are performed for 30 s after the monitor has turned off during playback or menu operations, shooting will end and a multiple exposure will be created from the exposures that have been recorded to that point.

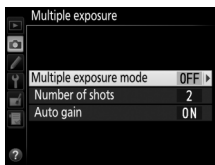
- 1 Select Multiple exposure in the shooting menu.**
Press the **MENU** button to display the menus. Highlight **Multiple exposure** in the shooting menu and press **▶**.

MENU button



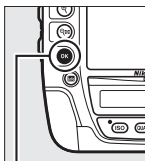
2 Select a mode.

Highlight **Multiple exposure mode** and press ►.

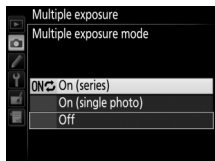


Highlight one of the following and press OK:


- **To take a series of multiple exposures, select ON (series).** Multiple exposure shooting will continue until you select **Off** for **Multiple exposure mode**.

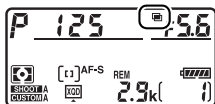


OK button



- **To take one multiple exposure, select On (single photo).** Normal shooting will resume automatically after you have created a single multiple exposure.
- **To exit without creating additional multiple exposures, select Off.**

If **On (series)** or **On (single photo)** is selected, a  icon will be displayed in the top control panel.

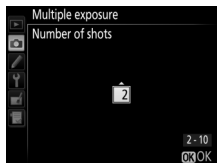
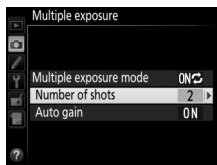


3 Choose the number of shots.


Highlight **Number of shots** and press **▶**.

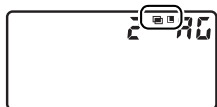




Press **▲** or **▼** to choose the number of exposures that will be combined to form a single photograph and press **OK**.



The BKT Button

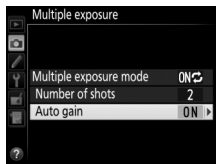
If **Multiple exposure** is selected for Custom Setting f9 (**Assign BKT button**;  344), you can select the multiple exposure mode by pressing the **BKT** button and rotating the main command dial and the number of shots by pressing the **BKT** button and rotating the sub-command dial. The mode and number of shots are shown in the top control panel:



 appears when **On (series)** is selected and  when **On (single photo)** is selected; no icon appears when multiple exposure is off.

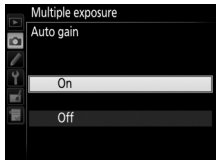
4 Choose the amount of gain.

Highlight **Auto gain** and press **▶**.



The following options will be displayed. Highlight an option and press **OK**.


- **On**: Gain is adjusted according to number of exposures actually recorded (gain for each exposure is set to $1/2$ for 2 exposures, $1/3$ for 3 exposures, etc.).
- **Off**: Gain is not adjusted when recording multiple exposure. Note that photographs may be affected by noise (randomly-spaced bright pixels, fog, or lines).




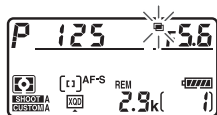
5 Frame a photograph, focus, and shoot.

In continuous release modes (☞ 111), the camera records all exposures in a single burst. If **On (series)** is selected, the camera will continue to record multiple exposures while the shutter-release button is pressed; if **On (single photo)** is selected, multiple exposure shooting will end after the first photograph. In self-timer mode, the camera will automatically record the number of exposures selected in Step 3 on page 216, regardless of the option selected for Custom Setting c3 (**Self-timer**) > **Number of shots** (☞ 325); the interval between shots is however controlled by Custom Setting c3 (**Self-timer**) > **Interval between shots**. In other release modes, one photograph will be taken each time the shutter-release button is pressed; continue shooting until all exposures have been recorded (for information on interrupting a multiple exposure before all photographs are recorded, see page 219).



The  icon will flash until shooting ends.

If **On (series)** is selected, multiple exposure shooting will only end when **Off** is selected for multiple exposure mode; if **On (single photo)** is selected, multiple exposure shooting ends automatically when the multiple exposure is complete. The  icon clears from the display when multiple exposure shooting ends.



■ ■ *Interrupting Multiple Exposures*

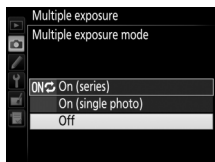
To interrupt a multiple exposure before the specified number of exposures have been taken, select **Off** for multiple exposure mode.

If shooting ends before the specified number of exposures have been taken, a multiple exposure will be created from the exposures that have been recorded to that point.

If **Auto gain** is on, gain will be adjusted to reflect the number of exposures actually recorded.

Note that shooting will end automatically if:

- A two-button reset is performed (☞ 211)
- The camera is turned off
- The battery is exhausted
- Pictures are deleted



Multiple Exposure

Do not remove or replace the memory card while recording a multiple exposure.

Multiple exposures can not be recorded in live view. Taking photographs in live view resets **Multiple exposure mode** to **Off**.

The shooting information listed in the playback photo information display (including date of recording and camera orientation) is for the first shot in the multiple exposure.

Voice Memos

Voice recording is disabled while multiple exposures are being shot, but a memo can be recorded when shooting finishes (☐ 261).

Interval Timer Photography

If interval timer photography is activated before the first exposure is taken, the camera will record exposures at the selected interval until the number of exposures specified in the multiple exposure menu have been taken (the number of shots listed in the interval timer shooting menu is ignored). These exposures will then be recorded as a single photograph and interval timer shooting will end (if **On (single photo)** is selected for multiple exposure mode, multiple exposure shooting will also end automatically).

Other Settings

While a multiple exposure is being shot, memory cards can not be formatted and some menu items are grayed out and can not be changed.



Interval Timer Photography

The camera is equipped to take photographs automatically at preset intervals.

☑ Before Shooting

Select a release mode other than self-timer (Ⓢ) when using the interval timer. Before beginning interval timer photography, take a test shot at current settings and view the results in the monitor.

Before choosing a starting time, select **Time zone and date** in the setup menu and make sure that the camera clock is set to the correct time and date (📅 30).

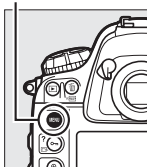
Use of a tripod is recommended. Mount the camera on a tripod before shooting begins. To ensure that shooting is not interrupted, be sure the camera battery is fully charged. If in doubt, charge the battery before use or use an AC adapter and power connector (available separately).

1 Select Interval timer shooting in the shooting menu.

Press the **MENU** button to display the menus.

Highlight **Interval timer shooting** in the shooting menu and press ►.

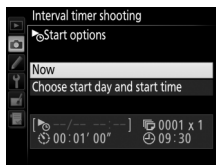
MENU button



2 Choose a start option.

Highlight **Start options** and press ► and then choose from the following starting triggers.

- **To start shooting immediately**, highlight **Now** and press Ⓞ. Shooting begins about 3 s after settings are completed; proceed to Step 3.

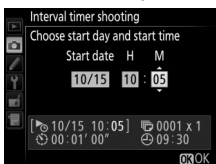


- **To choose a starting time**, highlight **Choose start day and start time** and press ► to

display the start time options shown at right. Press ◀ or ▶



to highlight the start date (any day within the next 8 days), hour (H), or minute (M) and press ▲ or ▼ to change. Press Ⓞ to return to the interval timer menu.



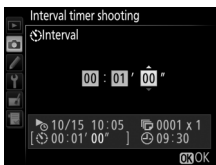
3 Choose the interval.

Highlight **Interval** and press ►, then press ◀ or ▶ to highlight hours, minutes, or seconds and press ▲ or ▼ to change.



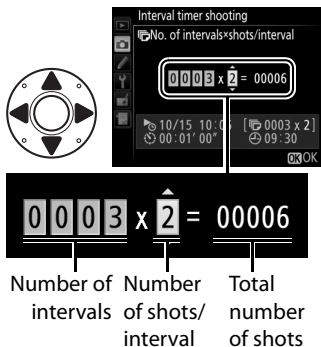
Choose an interval longer than

the time needed to take the number of shots selected in Step 4. If the interval is too short, the number of photos taken may be less than the total listed in Step 4 (the number of intervals multiplied by the number of shots per interval). Press Ⓞ to return to the interval timer menu.



4 Choose the number of intervals and number of shots per interval.

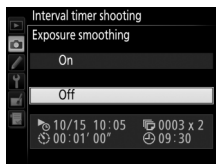
Highlight **No. of intervals** × **shots/interval** and press ►, then press ◀ or ▶ to highlight number of intervals or number of shots and press ▲ or ▼ to change. Press Ⓞ to return to the interval timer menu.




5 Choose whether to enable exposure smoothing.

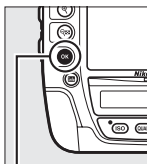
Highlight **Exposure smoothing** and press ►, then press ▲ or ▼ to highlight an option and press Ⓞ to select.

Selecting **On** allows the camera to adjust exposure to match the first shot in each series in **P**, **S**, and **A** modes (note that exposure smoothing only takes effect in mode **M** if auto ISO sensitivity control is on).

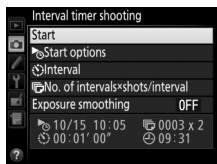


6 Start shooting.

Highlight **Start** and press . The first series of shots will be taken at the specified starting time, or after about 3 s if **Now** was selected for **Start options**



 button



in Step 2. Shooting will continue at the selected interval until all shots have been taken. Note that because the shutter speed, frame rate, and time needed to record images may vary from one interval to the next, the time between the end of one interval and the beginning of the next may vary. If shooting can not proceed at current settings (for example, if the interval is set to zero seconds or if a shutter speed of **b u l b** or **- -** is currently selected in manual exposure mode or the start time is in less than a minute), a warning will be displayed in the monitor.



Cover the Viewfinder

To prevent light entering via the viewfinder interfering with photographs and exposure, close the viewfinder eyepiece shutter (☞ 114).

Out of Memory

If the memory card is full, the interval timer will remain active but no pictures will be taken. Resume shooting (☞ 227) after deleting some pictures or turning the camera off and inserting another memory card.

Interval Timer Photography

Interval timer photography can not be combined with time-lapse photography (☞ 229) and is not available when **Record movies** is selected for Custom Setting g4 (**Assign shutter button**, ☞ 357).

Bracketing

Adjust bracketing settings before starting interval timer photography. If exposure, flash, or ADL bracketing is active while interval timer photography is in effect, the camera will take the number of shots in the bracketing program at each interval, regardless of the number of shots specified in the interval timer menu. If white balance bracketing is active while interval timer photography is in effect, the camera will take one shot at each interval and process it to create the number of copies specified in the bracketing program.

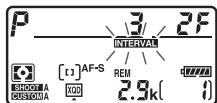


During Shooting

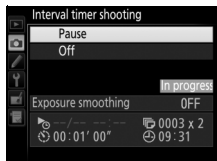
During interval timer photography, the **INTERVAL** icon will flash in the top control panel.

Immediately before the next shooting interval begins, the shutter speed display will show the number of intervals remaining, and the

aperture display will show the number of shots remaining in the current interval. At other times, the number of intervals remaining and the number of shots in each interval can be viewed by pressing the shutter-release button halfway (once the button is released, the shutter speed and aperture will be displayed until the standby timer expires).



To view current interval timer settings or to pause (☐ 227) or end (☐ 228) interval timer shooting, select **Interval timer shooting** between shots. While interval timer photography is in progress, the interval timer menu will show the starting time, the shooting interval, the number of intervals and shots remaining, and exposure smoothing. None of these items can be changed while interval timer photography is in progress.



Pictures can be played back and shooting and menu settings can be adjusted freely while interval timer photography is in progress. The monitor will turn off automatically about four seconds before each interval.

■ Pausing Interval Timer Photography

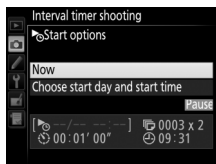
Interval timer photography can be paused by:

- Pressing the **OK** button between intervals
- Selecting **Pause** in the interval timer menu
- Turning the camera off and then on again (if desired, the memory card can be replaced while the camera is off)
- Selecting self-timer (☺) release mode

To resume shooting:

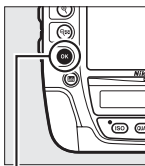
1 Choose new start options.

Choose new start options as described on page 222.

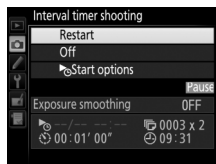


2 Resume shooting.

Highlight **Restart** and press **OK**. Note that if interval timer photography was paused during shooting, any shots remaining in the current interval will be canceled.



OK button



■ Interrupting Interval Timer Photography

Interval timer shooting will end automatically if the battery is exhausted. Interval timer photography can also be ended by:

- Selecting **Off** in the interval timer menu
- Performing a two button reset (☞ 211)
- Resetting settings for the current shooting menu bank using the **Shooting menu bank** item in the shooting menu (☞ 300)
- Changing bracketing settings (☞ 140)
- Terminating HDR (☞ 190) or multiple exposure shooting (☞ 214)

Normal shooting will resume when interval timer photography ends.

■ No Photograph

The camera will skip the current interval if any of the following situations persist for eight seconds or more after the interval was due to start: the photograph or photographs for the previous interval have yet to be taken, the memory card is full, the number of shots available in continuous shooting modes is 0, or the camera is unable to focus in **AF-S** (note that the camera focuses again before each shot). Shooting will resume with the next interval.

Release Mode

Regardless of the release mode selected, the camera will take the specified number of shots at each interval.

Shooting Menu Banks

Changes to interval timer settings apply to all shooting menu banks (☞ 300). If shooting menu settings are reset using the **Shooting menu bank** item in the shooting menu (☞ 301), interval timer shooting will end and interval timer settings will be reset as follows:

- Start options: Now
- Interval: 00:01:00"
- Number of intervals: 1
- Number of shots: 1
- Exposure smoothing: Off

Time-Lapse Photography

The camera automatically takes photos at selected intervals to create a silent time-lapse movie using the options currently selected for **Frame size/frame rate**, **Movie quality**, and **Destination** in the movie settings menu (📖 74).

Before Shooting

Before beginning time-lapse photography, take a test shot at current settings (framing the photo in the viewfinder for an accurate exposure preview) and view the results in the monitor. To record changes in brightness, choose manual exposure (📖 130); for consistent coloration, choose a white balance setting other than auto (📖 155). We also recommend that you briefly switch to movie live view and check the current image area crop in the monitor (📖 63); note, however, that time-lapse photography is not available in live view.

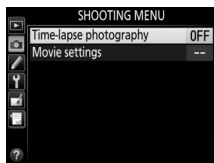
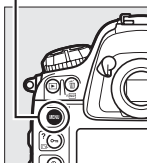
Use of a tripod is recommended. Mount the camera on a tripod before shooting begins. To ensure that shooting is not interrupted, use an optional AC adapter and power connector or a fully-charged battery.

1 Select Time-lapse photography in the shooting menu.

Press the **MENU** button to display the menus.

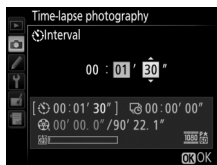
Highlight **Time-lapse photography** in the shooting menu and press **▶**.

MENU button



2 Choose the interval.

Highlight **Interval** and press ►, then press ◀ or ▶ to highlight minutes, or seconds and press ▲ or ▼ to change. Choose an interval longer than the slowest anticipated shutter speed. Press Ⓚ to return to the time-lapse photography menu.



3 Select the shooting time.

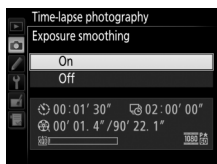
Highlight **Shooting time** and press ►, then press ◀ or ▶ to highlight hours or minutes and press ▲ or ▼ to change. The maximum shooting time is 7 hours and 59 minutes. Press Ⓚ to return to the time-lapse photography menu.



4 Choose whether to enable exposure smoothing.

Highlight **Exposure smoothing** and press ►, then press ▲ or ▼ to highlight an option and press Ⓚ to select.

Selecting **On** allows the camera to adjust exposure to match the first shot in each series in **P**, **S**, and **A** modes (note that exposure smoothing only takes effect in mode **M** if auto ISO sensitivity control is on).




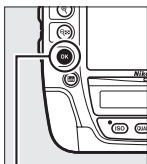
5 Start shooting.

Highlight **Start** and press .

Time-lapse photography starts after 3 s. The camera takes photographs at the interval selected in Step 2

for the time selected in Step 3. Note that because shutter speed and the time needed to record the image to the memory card may vary from shot to shot, the interval between a shot being recorded and the start of the next shot may vary. Shooting will not begin if a time-lapse movie can not be recorded at current settings (for example, if the memory card is full, the interval or shooting time is zero, or the interval is longer than the shooting time).

When complete, time-lapse movies are recorded to the memory card selected for **Movie settings > Destination** ( 75).



 button



Time-Lapse Photography

Time-lapse is not available in live view (☐ 49, 63), at a shutter speed of **b u l b** or **- -** (☐ 132) or when bracketing (☐ 140), High Dynamic Range (HDR, ☐ 190), multiple exposure (☐ 214), or interval timer photography (☐ 221) is active.

Frame Size

The area used for metering exposure, flash level, or auto white balance when photographs are recorded at a movie frame size of **1920 × 1080; 30p crop, 1920 × 1080; 25p crop**, or **1920 × 1080; 24p crop** (☐ 74) is not the same as the area in the final photograph, with the result that optimal results may not be achieved. Take test shots and check the results in the monitor.

Release Mode

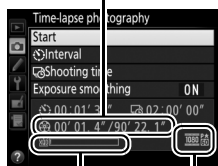
Regardless of the release mode selected, the camera will take one shot at each interval. The self-timer can not be used.



Calculating the Length of the Final Movie

The total number of frames in the final movie can be calculated by dividing the shooting time by the interval and rounding up. The length of the final movie can then be calculated by dividing the number of shots by the frame rate selected for **Movie settings > Frame size/frame rate**. A 48 frame movie recorded at **1920 x 1080; 24p**, for example, will be about two seconds long. The maximum length for movies recorded using time-lapse photography is 20 minutes.


Length recorded/
maximum length




Memory card
indicator

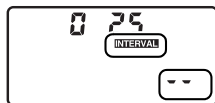
Frame size/frame rate


Cover the Viewfinder

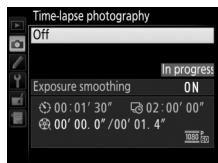
To prevent light entering via the viewfinder interfering with photographs and exposure, close the viewfinder eyepiece shutter ( 114).

During Shooting

During time-lapse photography, **INTERVAL** will flash and the time-lapse recording indicator will be displayed in the top control panel. The time remaining (in hours and minutes) appears in the shutter-speed display immediately before each frame is recorded. At other times, the time remaining can be viewed by pressing the shutter-release button halfway. Regardless of the option selected for Custom Setting c2 (**Standby timer**,  324), the standby timer will not expire during shooting.



To view current time-lapse photography settings or end time-lapse photography ( 234), press the **MENU** button between shots. While time-lapse photography is in progress, the time-lapse photography menu will show exposure smoothing, the interval, and the time remaining. These settings can not be changed while time-lapse photography is in progress, nor can pictures be played back or other menu settings adjusted.



■ Interrupting Time-Lapse Photography

Time-lapse photography will end automatically if the battery is exhausted. The following will also end time-lapse photography:


- Selecting **Off** in the **Time-lapse photography** menu
- Pressing the **OK** button between frames or immediately after a frame is recorded
- Turning the camera off
- Removing the lens
- Connecting an HDMI cable
- Inserting a memory card into an empty slot
- Pressing the shutter-release button all the way down to take a photograph

A movie will be created from the frames shot to the point where time-lapse photography ended. Note that time-lapse photography will end and no movie will be recorded if the power source is removed or disconnected or the destination memory card is ejected.

■ No Photograph

The camera will skip the current frame if the camera is unable to focus in **AF-S** (note that the camera focuses again before each shot). Shooting will resume with the next frame.

Image Review

The  button can not be used to view pictures while time-lapse photography is in progress, but the current frame will be displayed for a few seconds after each shot if **On** is selected for **Image review** in the playback menu (□ 295). Other playback operations can not be performed while the frame is displayed.

See Also

For information on setting a beep to sound when time-lapse photography is complete, see Custom Setting d1 (**Beep**, □ 326).

Non-CPU Lenses

Non-CPU lenses can be used in exposure modes **A** and **M**, with aperture set using the lens aperture ring. By specifying lens data (lens focal length and maximum aperture), the user can gain access to the following CPU lens functions.

If the focal length of the lens is known:

- Power zoom can be used with optional flash units (☐ 196)
- Lens focal length is listed (with an asterisk) in the playback photo info display

If the maximum aperture of the lens is known:

- The aperture value is displayed in the top control panel and viewfinder
- Flash level is adjusted for changes in aperture if the flash unit supports AA (auto aperture) mode
- Aperture is listed (with an asterisk) in the playback photo info display

Specifying both the focal length and maximum aperture of the lens:

- Enables color matrix metering (note that it may be necessary to use center-weighted or spot metering to achieve accurate results with some lenses, including Reflex-NIKKOR lenses)
- Improves the precision of center-weighted and spot metering and i-TTL balanced fill-flash for digital SLR

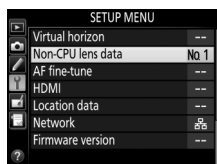
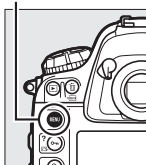


The camera can store data for up to nine non-CPU lenses. To enter or edit data for a non-CPU lens:

1 Select Non-CPU lens data in the setup menu.

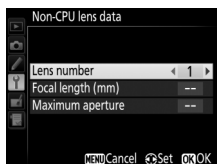
Press the MENU button to display the menus. Highlight **Non-CPU lens data** in the setup menu and press ►.

MENU button



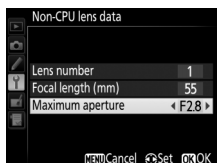
2 Select a lens number.

Highlight **Lens number** and press ◀ or ▶ to choose a lens number between 1 and 9.



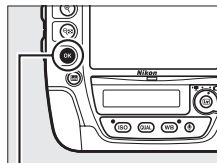
3 Enter the focal length and aperture.

Highlight **Focal length (mm)** or **Maximum aperture** and press ◀ or ▶ to edit the highlighted item. Focal length can be selected from values between 6 and 4000 mm, maximum aperture from values between f/1.2 and f/22.



4 Save settings and exit.

Press OK. The specified focal length and aperture will be stored under the chosen lens number.



OK button

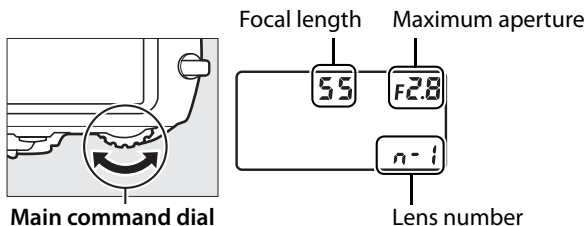
To recall lens data when using a non-CPU lens:

1 Assign non-CPU lens number selection to a camera control.

Select **Choose non-CPU lens number** as the “Press + command dials” option for a camera control in the Custom Settings menu (☞ 341). Non-CPU lens number selection can be assigned to the **Fn** button (Custom Setting f3, **Assign Fn button**, ☞ 337), the **Pv** button (Custom Setting f4, **Assign preview button**, ☞ 342), or the center of the sub-selector (Custom Setting f6, **Assign sub-selector center**, ☞ 342).

2 Use the selected control to choose a lens number.

Press the selected control and rotate the main or sub-command dial until the desired lens number is displayed in the top control panel.



Focal Length Not Listed

If the correct focal length is not listed, choose the closest value greater than the actual focal length of the lens.

Teleconverters and Zoom Lenses

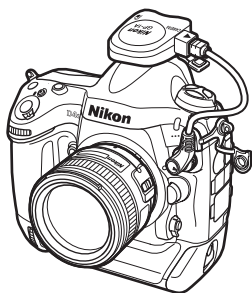
The maximum aperture for teleconverters is the combined maximum aperture of the teleconverter and the lens. Note that lens data are not adjusted when non-CPU lenses are zoomed in or out. The data for different focal lengths can be entered as separate lens numbers, or the data for the lens can be edited to reflect the new values for lens focal length and maximum aperture each time zoom is adjusted.

Location Data


A GPS unit can be connected to the ten-pin remote terminal, allowing the current latitude, longitude, altitude, Coordinated Universal Time (UTC), and heading to be recorded with each photograph taken. The camera can be used with optional GP-1 and GP-1A GPS units (see below; note that these units do not provide the compass heading), or with compatible third-party units connected via an optional MC-35 GPS adapter cord (☐ 413).




■ ■ GP-1/GP-1A GPS Units

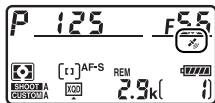
These optional GPS units are designed for use with Nikon digital cameras. For information on connecting the unit, see the manual provided with the device.



The Icon

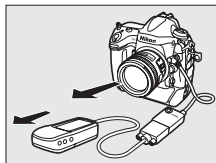
Connection status is shown by the  icon:

-  (**static**): The camera has established communication with the GPS device. Photo information for pictures taken while this icon is displayed include an additional page of location data (☞ 251).
-  (**flashing**): The GPS device is searching for a signal. Pictures taken while the icon is flashing do not include location data.
- **No icon**: No new location data have been received from the GPS device for at least two seconds. Pictures taken when the  icon is not displayed do not include location data.



Heading

The heading is only recorded if the GPS device is equipped with a digital compass (note that the GP-1 and GP-1A are not equipped with a compass). Keep the GPS device pointing in the same direction as the lens and at least 20 cm (8 in.) from the camera.



Coordinated Universal Time (UTC)

UTC data is provided by the GPS device and is independent of the camera clock.



■ ■ Setup Menu Options

The **Location data** item in the setup menu contains the options listed below.

- **Standby timer:** Choose whether or not the exposure meters will turn off automatically when a GPS unit is attached.

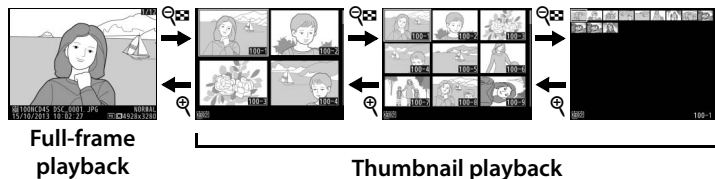
Option	Description
Enable	Exposure meters will turn off automatically if no operations are performed for the period specified in Custom Setting c2 (Standby timer (□ 324)); to allow the camera time to acquire location data when a GP-1 or GP-1A is connected, the delay is extended by up to one minute after exposure meters are activated or the camera is turned on). This reduces the drain on the battery.
Disable	Exposure meters will not turn off while a GPS unit is connected; location data will always be recorded.

- **Position:** This item is only available if a GPS device is connected, when it displays the current latitude, longitude, altitude, Coordinated Universal Time (UTC), and heading (if supported) as reported by the GPS device.
- **Set clock from satellite:** Select **Yes** to synchronize the camera clock with the time reported by the GPS device.








More About Playback

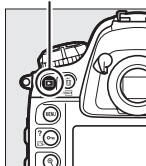
Viewing Images






Full-Frame Playback

To play photographs back, press the  button. The most recent photograph will be displayed in the monitor. Additional pictures can be displayed by pressing  or ; to view additional information on the current photograph, press  or  (📖 244).

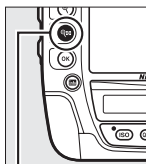
 button



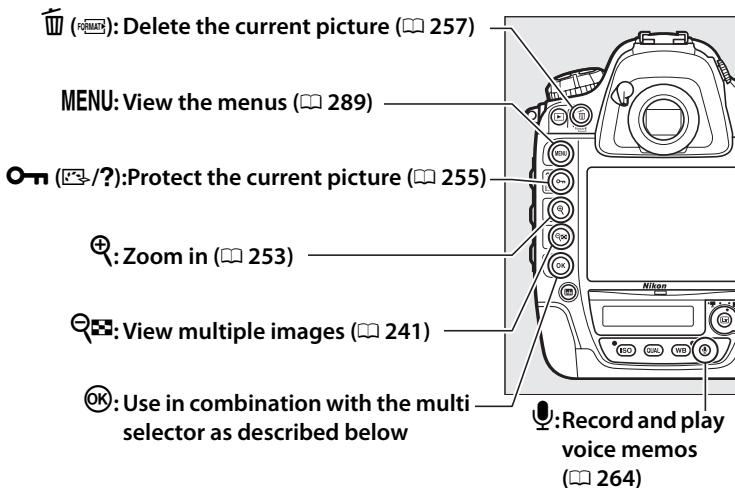
Thumbnail Playback

To view multiple images, press the  button when a picture is displayed full frame. The number of images displayed increases from 4 to 9 to 72 each time the  button is pressed, and decreases with each press of the  button. Use the multi selector to highlight images and press the center of the multi selector to view the highlighted image full frame.

 button



Playback Controls



+	Display slot/folder selection dialog. To choose card and folder from which pictures are played back, highlight slot and press to display list of folders, then highlight folder and press .
+	Create retouched copy of current photograph (📖 378) or create edited copy of current movie (📖 79).
+	View the IPTC presets stored on the camera (📖 368). To embed IPTC preset in current photo, highlight preset and press (any preset already embedded in current photo will be replaced).
+	Upload photographs over a wireless or Ethernet network (📖 276).

Two Memory Cards

If two memory cards are inserted, you can select a memory card for playback by pressing the button when 72 thumbnails are displayed.

Rotate Tall


To display “tall” (portrait-orientation) photographs in tall orientation, select **On** for the **Rotate tall** option in the playback menu (☞ 296).



Image Review

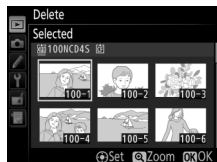
When **On** is selected for **Image review** in the playback menu (☞ 295), photographs are automatically displayed in the monitor after shooting (because the camera is already in the correct orientation, images are not rotated automatically during image review). In continuous release mode, display begins when shooting ends, with the first photograph in the current series displayed.

Resuming Shooting

To turn the monitor off and return to shooting mode, press  or press the shutter-release button halfway. Photographs can be taken immediately.

The Multi Selector

The multi selector can be used to highlight pictures in the thumbnail display and in displays like that shown at right.



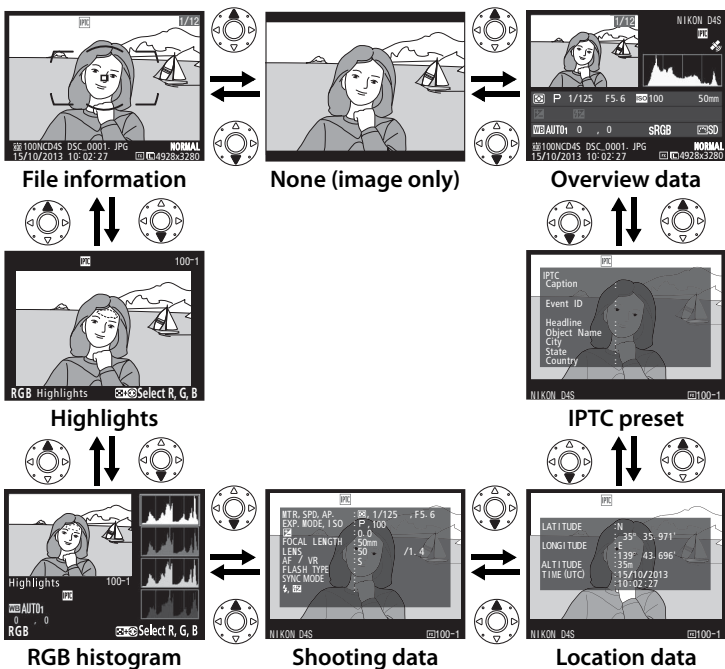
See Also

For information on choosing how long the monitor will remain on when no operations are performed, see Custom Setting c4 (**Monitor off delay**, ☞ 325). For information on choosing the role played by the center of the multi selector, see Custom Setting f1 (**Multi selector center button**, ☞ 335). For information on using the command dials for image or menu navigation, see Custom Setting f10 (**Customize command dials**) > **Menus and playback** (☞ 346).

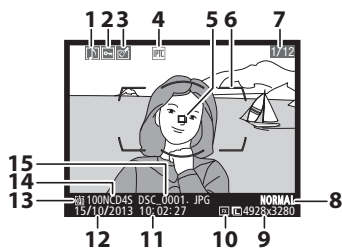


Photo Information

Photo information is superimposed on images displayed in full-frame playback. Press ▲ or ▼ to cycle through photo information as shown below. Note that “image only”, shooting data, RGB histograms, and highlights are only displayed if corresponding option is selected for **Playback display options** (📖 291). Location data are only displayed if a GPS device was used when the photo was taken (📖 238), while IPTC presets are displayed only if embedded in the photo (📖 368).



File Information

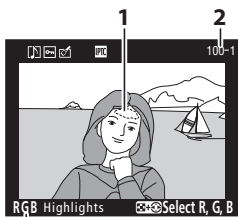


1	Voice memo icon	261
2	Protect status.....	255
3	Retouch indicator	375
4	IPTC preset indicator.....	242, 368
5	Focus point ^{1, 2}	103
6	AF area brackets ¹	38
7	Frame number/total number of frames	
8	Image quality	90
9	Image size	94
10	Image area	85
11	Time of recording	30, 363
12	Date of recording	30, 363
13	Current card slot	34
14	Folder name	302
15	File name	304




- 1 Displayed only if **Focus point** is selected for **Playback display options** (☐ 291).
- 2 If photograph was taken using **AF-S**, display shows point where focus first locked. If photograph was taken using **AF-C**, focus point is only displayed if option other than auto-area AF was selected for AF-area mode and camera was able to focus.

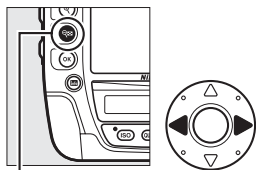


■ Highlights

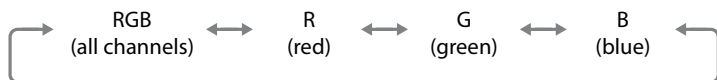


- 1 Image highlights*
- 2 Folder number–frame number 302
- 3 Current channel*

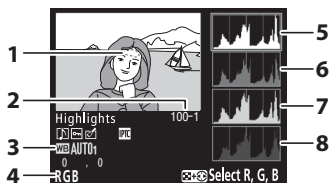
* Flashing areas indicate highlights (areas that may be overexposed) for current channel. Hold  button and press  or  to cycle through channels as follows:




 button

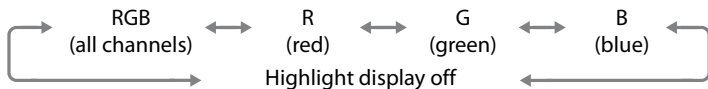
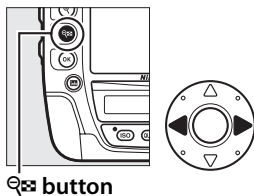


RGB Histogram






- | | |
|---|---|
| 1 | Image highlights* |
| 2 | Folder number–frame number.....302 |
| 3 | White balance155
Color temperature.....161
White balance fine-tuning.....158
Preset manual164 |
| 4 | Current channel* |
| 5 | Histogram (RGB channel). In all histograms, horizontal axis gives pixel brightness, vertical axis number of pixels. |
| 6 | Histogram (red channel) |
| 7 | Histogram (green channel) |
| 8 | Histogram (blue channel) |

* Flashing areas indicate highlights (areas that may be overexposed) for current channel. Hold  button and press ◀ or ▶ to cycle through channels as follows:



Playback Zoom

To zoom in on the photograph when the histogram is displayed, press . Use the  and  buttons to zoom in and out and scroll the image with the multi selector. The histogram will be updated to show only the data for the portion of the image visible in the monitor.



Histograms

Camera histograms are intended as a guide only and may differ from those displayed in imaging applications. Some sample histograms are shown below:

If the image contains objects with a wide range of brightnesses, the distribution of tones will be relatively even.



If the image is dark, tone distribution will be shifted to the left.



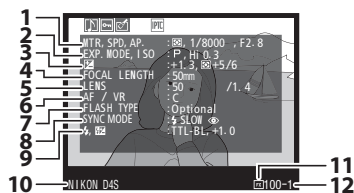
If the image is bright, tone distribution will be shifted to the right.



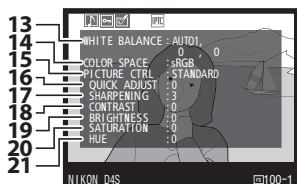
Increasing exposure compensation shifts the distribution of tones to the right, while decreasing exposure compensation shifts the distribution to the left. Histograms can provide a rough idea of overall exposure when bright ambient lighting makes it difficult to see photographs in the monitor.



Shooting Data



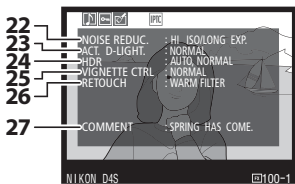
1	Metering	123
	Shutter speed	128, 130
	Aperture.....	129, 130
2	Exposure mode	125
	ISO sensitivity ¹	117



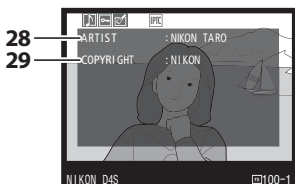
3	Exposure compensation.....	138
	Optimal exposure tuning ²	323
4	Focal length	235, 406
5	Lens data	235
6	Focus mode	52, 97
	Lens VR (vibration reduction) ³	
7	Flash type ⁴	
	Commander mode ⁴	
8	Flash mode ⁴	203
9	Flash control ⁴	332
	Flash compensation ⁴	206
10	Camera name	
11	Image area	85
12	Folder number–frame number.....	302

13	White balance	155
	Color temperature.....	161
	White balance fine-tuning	158
	Preset manual	164
14	Color space	305
15	Picture Control	177
16	Quick adjust ⁵	180
	Original Picture Control ⁶	177
17	Sharpening	180
18	Contrast	180
19	Brightness	180
20	Saturation ⁷	180
	Filter effects ⁸	180
21	Hue ⁷	180
	Toning ⁸	180





22	High ISO noise reduction.....	308
	Long exposure noise reduction	308
23	Active D-Lighting	188
24	HDR exposure differential	192
	HDR smoothing	192
25	Vignette control.....	306
26	Retouch history.....	375
27	Image comment	366

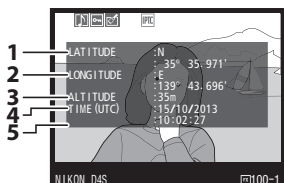


28	Name of photographer ⁹	367
29	Copyright holder ⁹	367

- 1 Displayed in red if photo was taken with auto ISO sensitivity control on.
- 2 Displayed if Custom Setting b7 (**Fine-tune optimal exposure**, 323) has been set to a value other than zero for any metering method.
- 3 Displayed only if VR lens is attached.
- 4 Displayed only if optional flash unit (195) is used.
- 5 **Standard, Vivid, Portrait, and Landscape** Picture Controls only.
- 6 **Neutral, Monochrome**, and custom Picture Controls.
- 7 Not displayed with monochrome Picture Controls.
- 8 Monochrome Picture Controls only.
- 9 The fourth page of the shooting data is only displayed if copyright information was recorded with the photograph as described on page 367.



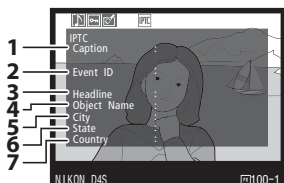
Location Data¹ (📖 238)



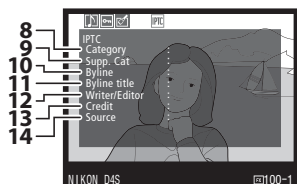
- 1 Latitude
- 2 Longitude
- 3 Altitude
- 4 Coordinated Universal Time (UTC)
- 5 Heading²

- 1 Data for movies are for start of recording.
- 2 Displayed only if GPS device is equipped with electronic compass.

IPTC Preset (📖 368)



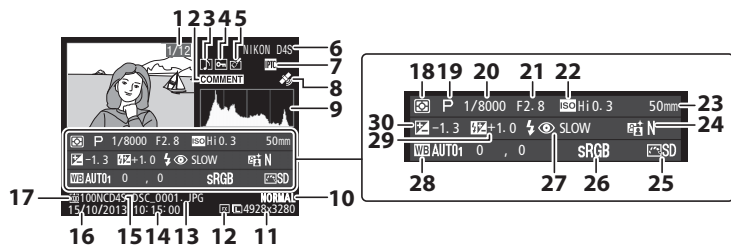
- 1 Caption
- 2 Event ID
- 3 Headline
- 4 Object name
- 5 City
- 6 State
- 7 Country



- 8 Category
- 9 Supplemental Categories (Supp. Cat.)
- 10 Byline
- 11 Byline title
- 12 Writer/editor
- 13 Credit
- 14 Source



Overview Data




1 Frame number/total number of frames	18 Metering	123
2 Image comment indicator	19 Exposure mode	125
3 Voice memo icon	20 Shutter speed	128, 130
4 Protect status	21 Aperture	129, 130
5 Retouch indicator	22 ISO sensitivity ¹	117
6 Camera name	23 Focal length	235, 406
7 IPTC preset indicator	24 Active D-Lighting	188
8 Location data indicator	25 Picture Control	177
9 Histogram showing the distribution of tones in the image (□ 248).	26 Color space	305
10 Image quality	27 Flash mode ²	203
11 Image size	28 White balance	155
12 Image area	Color temperature	161
13 File name	White balance fine-tuning	158
14 Time of recording	Preset manual	164
15 Folder name	29 Flash compensation ²	206
16 Date of recording	Commander mode ²	
17 Current card slot	30 Exposure compensation	138

1 Displayed in red if photo was taken with auto ISO sensitivity control on.

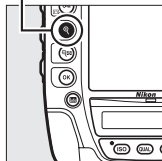
2 Displayed only if photo was taken with optional flash unit (□ 195).








Taking a Closer Look: Playback Zoom


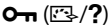


Press the  button to zoom in on the image displayed in full-frame playback or on the image currently highlighted in thumbnail playback. The following operations can be performed while zoom is in effect:

 button



To	Use	Description
Zoom in or out		Press  to zoom 36×24 (3 : 2) format images in to maximum of approximately 30 × (large images), 23 × (medium images) or 15 × (small images). Press  to zoom out.
View other areas of image		While photo is zoomed in, use multi selector to view areas of image not visible in monitor. Keep multi selector pressed to scroll rapidly to other areas of frame. Navigation window is displayed when zoom ratio is altered; area currently visible in monitor is indicated by yellow border.
Select faces		Faces (up to 35) detected during zoom are indicated by white borders in navigation window. Rotate sub-command dial to view other faces.



To	Use	Description
View other images		Rotate main command dial to view same location in other photos at current zoom ratio. Playback zoom is cancelled when a movie is displayed.
Change protect status		See page 255 for more information.
Return to shooting mode		Press the shutter-release button halfway or press the  button to exit to shooting mode.
Display menus	MENU	See page 289 for more information.



Protecting Photographs from Deletion

In full-frame, zoom, and thumbnail playback, the **Protect** (🔒/?) button can be used to protect photographs from accidental deletion. Protected files can not be deleted using the **Delete** (🗑️) button or the **Delete** option in the playback menu. Note that protected images *will* be deleted when the memory card is formatted (📖 35, 359).

To protect a photograph:

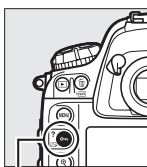
1 Select an image.

Display the image in full-frame playback or playback zoom or highlight it in the thumbnail list.



2 Press the **Protect** (🔒/?) button.

The photograph will be marked with a **Protect** (🔒) icon. To remove protection from the photograph so that it can be deleted, display the photograph or highlight it in the thumbnail list and then press the **Protect** (🔒/?) button.





Protect (🔒/?) button



Voice Memos


Changes to the protect status of images also apply to any voice memos that may have been recorded with the images. Voice memo overwrite status can not be set separately.

Removing Protection from All Images

To remove protection from all images in the folder or folders currently selected in the **Playback folder** menu, press the  (▶) and  (FORMAT) buttons together for about two seconds during playback.



Deleting Photographs

To delete all photographs in the current folder or the photograph displayed in full-frame playback or highlighted in the thumbnail list, press the  button. To delete multiple selected photographs, use the **Delete** option in the playback menu. Once deleted, photographs can not be recovered. Note that pictures that are protected or hidden can not be deleted.



Full-Frame and Thumbnail Playback


Press the  button to delete the current photograph.

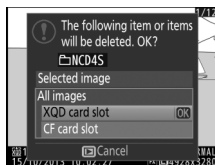
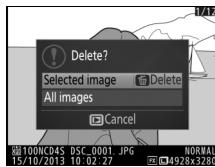
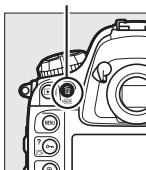
1 Select an image.

Display the image or highlight it in the thumbnail list.




2 Press the button.

The menu shown at right will be displayed; highlight **Selected image** (to delete all pictures in the folder currently selected for playback— 290—press  and choose a slot).


 button



3 Delete the photograph(s).

To delete the photograph or photographs, press the  button (**Selected image**) or  button (**All images**). To exit without deleting the photograph or photographs, press the  button.



See Also


The **After delete** option in the playback menu determines whether the next image or the previous image is displayed after an image is deleted ( 296).

Voice Memos

If a voice memo has been recorded with the selected image, the confirmation dialog shown at right will be displayed when **Selected image** is chosen in Step 2 on the previous page. This dialog is not displayed when **All images** is selected.




- **Image/sound:** Select this option and press the  button to delete both photo and voice memo.
- **Sound only:** Select this option and press the  button to delete only the voice memo.

To exit without deleting either voice memo or photo, press .

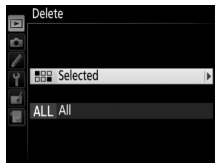
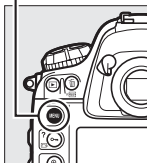
The Playback Menu

Select **Delete** in the playback menu to delete pictures and their associated voice memos. Note that depending on the number of images, some time may be required for deletion.

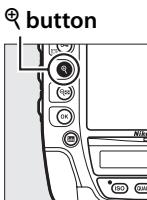
Option	Description
 Selected	Delete selected pictures.
ALL All	Delete all pictures in the folder currently selected for playback (📁 290). If two cards are inserted, you can select the card from which pictures will be deleted.

■ Selected: Deleting Selected Photographs


- 1 Choose Selected for the Delete option in the playback menu.**
Press the **MENU** button and select **Delete** in the playback menu. Highlight **Selected** and press **▶**.



- 2 Highlight a picture.**
Use the multi selector to highlight a picture (to view the highlighted picture full screen, press and hold the **Q** button; to view images in other locations, press **Q** and select the desired card and folder as described on page 242).




3 Select the highlighted picture.

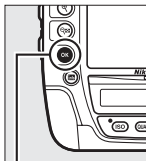
Press the center of the multi selector to select the highlighted picture. Selected pictures are marked by a  icon.

Repeat steps 2 and 3 to select additional pictures; to deselect a picture, highlight it and press the center of the multi selector.



4 Press to complete the operation.

A confirmation dialog will be displayed; highlight **Yes** and press .



 button



Voice Memos

Recording Voice Memos

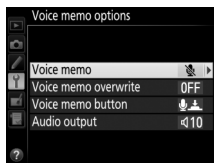
Voice memos up to sixty seconds long can be added to photographs using the built-in or optional ME-1 stereo microphones.






Readying the Camera for Recording

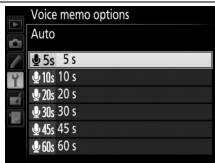
Before recording voice memos, adjust settings using the **Voice memo options** item in the setup menu.

■ Voice Memo

This option controls whether voice memos are recorded automatically or manually. The following options are available:

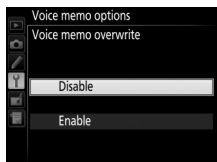


Option	Description
 Off	Voice memos can not be recorded in shooting mode.
 On (Auto and manual)	Selecting this option displays menu shown at right; select maximum recording time from 5, 10, 20, 30, 45, or 60 s. Unless On is selected for Image review in playback menu (□ 295), recording will begin when shutter-release button is released after shooting. Recording ends when  button is pressed or after specified recording time has ended.
 Manual only	Memo can be recorded for most recent photograph by pressing and holding  button (□ 263).



■ Voice Memo Overwrite

This option controls whether the voice memo for the most recent photograph can be overwritten in shooting mode. The following options are available:








Option	Description
Disable	Voice memo can not be recorded in shooting mode if one already exists for most recent image.
Enable	Voice memo can be recorded in shooting mode even if one already exists for most recent image (□ 263). Existing memo will be deleted and replaced by new memo.

■ Voice Memo Button

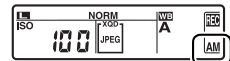
This option controls manual recording. The following options are available:



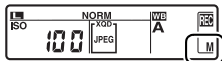
Option	Description
 Press and hold	Voice memo is recorded while  button is held down. Recording will end automatically after 60 s.
 Press to start/stop	Recording begins when  button is pressed and ends when  button is pressed again. Recording will end automatically after 60 s.

Voice Memo

The option selected for **Voice memo** is indicated by an icon in the rear control panel.




On (auto and manual)





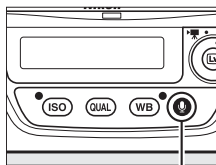
Manual only

Automatic Recording (Shooting Mode)

If **On (Auto and manual)** is selected for **Voice memo** (☞ 261), a voice memo will be added to the most recent photograph when shooting ends. Recording will end when the  button is pressed or after the specified recording time has ended.

Manual Recording (Shooting Mode)

If **On (Auto and manual)** or **Manual only** is selected for **Voice memo** (☞ 261), a voice memo can be recorded for the most recent photograph by pressing and holding the  button. A voice memo will be recorded while the button is held down (note that no voice memo will be recorded if the  button is not held down for at least one second).



 button

Automatic Recording

Voice memos will not be recorded automatically during live view (☞ 49), movie recording (☞ 63), or time-lapse photography (☞ 229), or when **On** is selected for the **Image review** option (☞ 295) in the playback menu. A voice memo can however be added to the photograph displayed during image review even if **Off** is selected for **Voice memo**.

Secondary slot function

If two memory cards are inserted and **Backup** or **RAW primary - JPEG secondary** is selected for the **Secondary slot function** option (☞ 96) in the shooting menu, voice memos will be associated with the images recorded to the memory card in the primary slot.



Playback Mode

To add a voice memo to the photograph currently displayed in full-frame playback or highlighted in the thumbnail list (🗉 241):

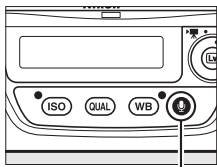
1 Choose a photograph.

Display or highlight the photograph. Only one voice memo can be recorded per image; additional voice memos can not be recorded for images already marked with a 🗉 icon.



2 Press and hold the 🗣️ button.

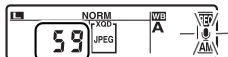
A voice memo will be recorded while the 🗣️ button is held down (note that no voice memo will be recorded if the 🗣️ button is not held down for at least one second).



🗣️ button

🗣️ During Recording

During recording, the 🗣️ icon in the rear control panel will flash. A countdown timer in the rear control panel shows the length of the voice memo that can be recorded (in seconds).



Rear control panel


In playback mode, a 🗣️ icon is displayed in the monitor during recording.

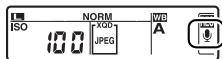


Interrupting Recording


Pressing the shutter-release button or operating other camera controls may end recording. During interval timer photography, recording ends automatically about two seconds before the next photograph is taken. Recording also ends automatically when the camera is turned off.

After Recording

If a voice memo has been recorded for the most recent photograph, a  icon will be displayed in the rear control panel.



Rear control panel

If a voice memo exists for the photograph currently selected in playback mode, a  icon will be displayed in the monitor.




Voice Memo File Names





Voice memos are stored as WAV files with names of the form “xxxxnnnn.WAV,” where “xxxxnnnn” is a file name copied from the image with which the voice memo is associated. For example, the voice memo for the image “DSC_0002.JPG” would have the file name “DSC_0002.WAV.” Voice memo file names can be viewed on a computer.



Playing Voice Memos

Voice memos can be played back over the camera's built-in speaker when the associated image is viewed in full-frame playback or highlighted in the thumbnail list (□ 241). The presence of a voice memo is indicated by an  icon.



To	Press	Description
Start/end playback		Press  to start playback. Playback will end when  button is pressed again or entire memo has been played back.
Delete voice memo		See page 258.

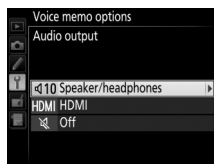





Interrupting Playback

Pressing the shutter-release button or operating other camera controls may end playback. Playback ends automatically when another image is selected or the camera is turned off.

Voice Memo Playback Options

The **Voice memo options > Audio output** item in the setup menu controls whether voice memos are played back by the camera (from either the built-in speaker or optional headphones) or by a device to which the camera is connected via an HDMI cable. When sound is played back by the camera, the **Audio output** option also controls playback volume.



Option	Description
 Speaker/headphones	Voice memos are played back over built-in speaker or (if connected) over optional headphones. Selecting this option displays menu shown at right. Press ▲ or ▼ to change volume. Beep will sound when option is selected. Press ⊗ to make selection and return to setup menu.
HDMI HDMI	Audio signal output to HDMI terminal.
 Off	Voice memos are not played back.  icon is displayed when photo for which voice memo exists is viewed in monitor.







Connections

Installing ViewNX 2

Install the supplied software to display and edit photographs and movies that have been copied to your computer. Before installing ViewNX 2, confirm that your computer meets the system requirements on page 271. Be sure to use the latest version of ViewNX 2, which is available for download from the websites listed on page xx, as earlier versions that do not support the D4S may fail to transfer NEF (RAW) images correctly.



1 Launch the installer.

Start the computer, insert the installer CD, and launch the installer. A language selection dialog will be displayed. If the desired language is not available, click **Region Selection** to choose a different region (region selection is not available in the European release).

① Select region (if required)



② Select language

③ Click Next



-
- 2 Start the installer.**
Click **Install** and follow the on-screen instructions.



Click Install

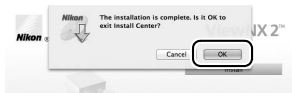
-
- 3 Exit the installer.**

Windows



Click Yes

Mac



Click OK

-
- 4 Remove the installer CD from the CD-ROM drive.**

 **Viewing the Nikon Website**

To visit the Nikon website after installing ViewNX 2, select **All Programs > Link to Nikon** from the Windows start menu (Internet connection required).

System Requirements

	Windows	Mac
CPU	<ul style="list-style-type: none">• Photos: Intel Celeron, Pentium 4, or Core series, 1.6 GHz or better• Movies (playback): Pentium D 3.0 GHz or better; Intel Core i5 or better recommended when viewing movies with a frame size of 1280 × 720 or more at a frame rate of 30 fps or above or movies with a frame size of 1920 × 1080 or more• Movies (editing): Intel Core i5 or better	<ul style="list-style-type: none">• Photos: Intel Core or Xeon series• Movies (playback): Core Duo 2 GHz or better; Intel Core i5 or better recommended when viewing movies with a frame size of 1280 × 720 or more at a frame rate of 30 fps or above or movies with a frame size of 1920 × 1080 or more• Movies (editing): Intel Core i5 or better
OS	Pre-installed versions of Windows 8.1, Windows 7, Windows Vista, and Windows XP; note that 64-bit versions of Windows XP are not supported	OS X 10.9, 10.8, or 10.7
Memory (RAM)	<ul style="list-style-type: none">• 32-bit Windows 8.1, Windows 7, or Windows Vista: 1 GB or more (2 GB or more recommended)• 64-bit Windows 8.1, Windows 7, or Windows Vista: 2 GB or more (4 GB or more recommended)• Windows XP: 512 MB or more (2 GB or more recommended)	2 GB or more (4 GB or more recommended)
Hard disk space	A minimum of 1 GB available on the startup disk (3 GB or more recommended)	
Graphics	Resolution: 1024 × 768 pixels (XGA) or more (1280 × 1024 pixels or more recommended) Color: 24-bit color (True Color) or more	Resolution: 1024 × 768 pixels (XGA) or more (1280 × 1024 pixels or more recommended) Color: 24-bit color (millions of colors) or more

See the websites listed on page xx for the latest information on supported operating systems.



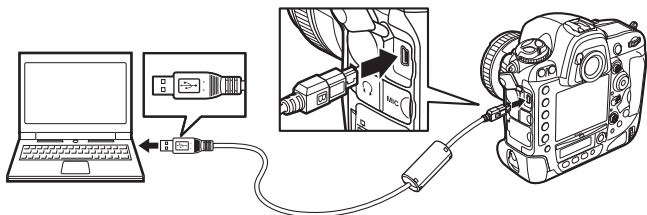
Using ViewNX 2

Copy Pictures to the Computer

Before proceeding, be sure you have installed the software on the supplied ViewNX 2 CD (☞ 269).

1 Connect the USB cable.

After turning the camera off and ensuring that a memory card is inserted, connect the supplied USB cable as shown and then turn the camera on.



Use a Reliable Power Source

To ensure that data transfer is not interrupted, be sure the camera battery is fully charged.

Connecting Cables

Be sure the camera is off when connecting or disconnecting interface cables. Do not use force or attempt to insert the connectors at an angle.

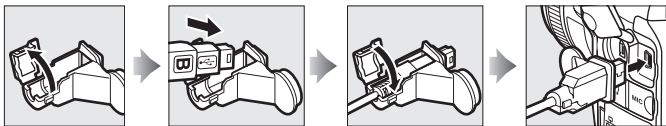
During Transfer

Do not turn the camera off or disconnect the USB cable while transfer is in progress.



✓ The USB Cable Clip

To prevent cable from being disconnected, attach the supplied clip as shown.



✎ USB Hubs

Connect the camera directly to the computer; do not connect the cable via a USB hub or keyboard.

2 Start Nikon Transfer 2 component of ViewNX 2.

If a message is displayed prompting you to choose a program, select Nikon Transfer 2.

✎ Windows 7

If the following dialog is displayed, select Nikon Transfer 2 as described below.

1 Under **Import pictures and videos**, click **Change program**. A program selection dialog will be displayed; select **Import file using Nikon Transfer 2** and click **OK**.



2 Double-click **Import file**.



3 Click Start Transfer.

At default settings, pictures on the memory card will be copied to the computer.



Start Transfer

4 Terminate the connection.

When transfer is complete, turn the camera off and disconnect the USB cable.

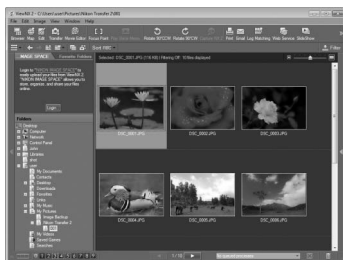


View Pictures

Pictures are displayed in ViewNX 2 when transfer is complete.

Starting ViewNX 2 Manually

- Windows: Double-click the ViewNX 2 shortcut on the desktop.
- Mac: Click the ViewNX 2 icon in the Dock.



Retouching Photographs

To crop pictures and perform such tasks as adjusting sharpness and tone levels, click the **Edit** button in the ViewNX 2 toolbar.



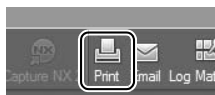
Editing Movies

To perform such tasks as trimming unwanted footage from movies shot with the camera, click the **Movie Editor** button in the ViewNX 2 toolbar.



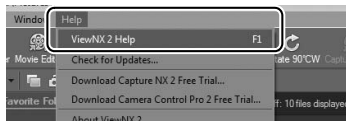
Printing Pictures

Click the **Print** button in the ViewNX 2 toolbar. A dialog will be displayed, allowing you to print pictures on a printer connected to the computer.



For More Information

Consult online help for more information on using ViewNX 2.



Ethernet and Wireless Networks

The camera can be connected to Ethernet or wireless networks using the built-in Ethernet port or an optional WT-5 or WT-4 wireless transmitter (📖 409). Note that an Ethernet cable (available separately from commercial sources) is required for an Ethernet connection.

■ ■ *The Built-in Ethernet Port and WT-5 Wireless Transmitter*

The following modes are available when the camera is connected to a network using the built-in Ethernet port or an optional WT-5 wireless transmitter:

Mode	Function
FTP upload	Upload existing photos and movies to a computer or ftp server, or upload new photos as they are taken.
Image transfer	
Camera control	Control the camera using optional Camera Control Pro 2 software and save new photos and movies directly to the computer.
HTTP server	View and take pictures remotely using a browser-equipped computer or iPhone.
Synchronized release (WT-5 only)	Synchronize the shutter releases for multiple remote cameras with a master camera.

■ ■ *WT-4 Wireless Transmitter*

The WT-4 can be used in any of the following modes:

Mode	Function
Transfer mode	Upload existing photos and movies to a computer or ftp server, or upload new photos as they are taken.
PC mode	Control the camera using optional Camera Control Pro 2 software and save new photos and movies directly to the computer.




For more information, see the *Network Guide* and the documentation for the wireless transmitter or communication unit. Be sure to update to the latest versions of the wireless transmitter or communication unit firmware and supplied software.

Optional UT-1 Communication Units

In place of the built-in Ethernet port, an optional UT-1 communication unit (☐ 409) can be used to connect the camera to a local area network (LAN). The UT-1 supports the same modes as the WT-4 and can be used with Ethernet networks or combined with an optional WT-5 wireless transmitter for connection to wireless networks.

Image Upload

In image transfer, ftp upload, and transfer modes, the picture currently displayed in full-frame or thumbnail playback can be uploaded to the computer by holding  and pressing the center of the multi selector.

During Transfer

Movies can not be recorded or played back in image transfer mode (“image transfer mode” applies when images are being transferred via an Ethernet or wireless network and when images remain to be sent). Live view photography is not available during transfer if **Silent** is selected for **Live view photography** in the shooting menu.

Movies

Movies can be uploaded in transfer mode if the camera is connected to an Ethernet or a wireless network and **Auto send** or **Send folder** is not selected for **Network > Options**.



HTTP Server Mode

The camera can not be used to record or view movies in http server mode, while live view photography is not available if **Silent** is selected for **Live view photography** in the shooting menu.

Wireless Transmitters

The principal differences between the WT-4 and WT-4A/B/C/D/E and the WT-5 and WT-5A/B/C/D/E is in the number of channels supported; unless otherwise stated, all references to the WT-4 also apply to the WT-4A/B/C/D/E, while all references to the the WT-5 also apply to the WT-5A/B/C/D/E.



Printing Photographs

Selected JPEG images can be printed on a PictBridge printer (📖 461) connected directly to the camera.

✔ Selecting Photographs for Printing

Images created at image quality settings of NEF (RAW) or TIFF (RGB) (📖 90) can not be selected for printing. JPEG copies of NEF (RAW) images can be created using the **NEF (RAW) processing** option in the retouch menu (📖 387).

📎 Printing Via Direct USB Connection

Be sure the battery is fully charged or use an optional AC adapter and power connector. When taking photographs to be printed via direct USB connection, set **Color space** to **sRGB** (📖 305).

📎 See Also

See page 448 for information on what to do if an error occurs during printing.



Connecting the Printer

Connect the camera using the supplied USB cable.

1 Turn the camera off.

2 Connect the USB cable.

Turn the printer on and connect the USB cable. Do not use force or attempt to insert the connectors at an angle.

 **USB Hubs**

Connect the camera directly to the printer; do not connect the cable via a USB hub.

3 Turn the camera on.

A welcome screen will be displayed in the monitor, followed by a PictBridge playback display. To print pictures one at a time, follow the steps below. To print multiple selected pictures or all pictures, proceed to page 282.

Printing Pictures One at a Time

1 Display the desired picture.

Press ◀ or ▶ to view additional pictures. Press the Ⓚ button to zoom in on the current frame (⏏ 253, press ▶ to exit zoom). To view six pictures at a time, press the center of the multi selector. Use the multi selector to highlight pictures, or press the center of the multi selector again to display the highlighted picture full frame. To view images in other locations, press Ⓚ when thumbnails are displayed and select the desired card and folder as described on page 242.



2 Adjust printing options.

Press **OK** to display the following items, then press **▲** or **▼** to highlight an item and press **▶** to view options (only options supported by the current printer are listed; to use the default option, select **Printer default**). After selecting an option, press **OK** to return to the printer settings menu.

Option	Description
Page size	Choose a page size.
No. of copies	This option is listed only when pictures are printed one at a time. Press ▲ or ▼ to choose number of copies (maximum 99).
Border	Choose whether to frame photos in white borders.
Time stamp	Choose whether to print the times and dates of recordings on photos.
Cropping	This option is listed only when pictures are printed one at a time. To exit without cropping, highlight No cropping and press OK . To crop the current picture, highlight Crop and press ▶ . A crop selection dialog will be displayed; press ↻ to increase the size of the crop, ↻ to decrease, and use the multi selector to position the crop. Note that print quality may drop if small crops are printed at large sizes.

3 Start printing.

Select **Start printing** and press **OK** to start printing. To cancel before all copies have been printed, press **OK**.








Printing Multiple Pictures

1 Display the PictBridge menu.

Press the MENU button in the PictBridge playback display.

2 Choose an option.



Highlight one of the following options and press ►.

- **Print select:** Select pictures for printing. Use the multi selector to highlight pictures (to view images in other locations, press  and select the desired card and folder as described on page 242; to display the current picture full screen, press and hold the  button) and, keeping the  (/?) button pressed, press ▲ or ▼ to choose the number of prints (maximum 99). To deselect a picture, set the number of prints to zero.
 - **Print (DPOF):** Print the current DPOF print order ( 283). The order can be viewed and modified before printing as described in the description for **Print select**, above.
 - **Index print:** To create an index print of all JPEG pictures on the memory card, proceed to Step 3. Note that if the memory card contains more than 256 pictures, only the first 256 images will be printed. A warning will be displayed if the page size selected in Step 3 is too small for an index print.
-

3 Adjust printing options.

Adjust printer settings as described in Step 2 on page 281.

4 Start printing.

Select **Start printing** and press  to start printing. To cancel before all copies have been printed, press .



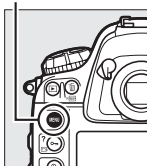
Creating a DPOF Print Order: Print Set

The **DPOF print order** option in the playback menu is used to create digital “print orders” for PictBridge-compatible printers and devices that support DPOF (📖 461).

1 Choose DPOF print order > Select/set.

Press the **MENU** button and select **DPOF print order** in the playback menu. Highlight **Select/set** and press **▶** (to remove all photographs from the print order, select **Deselect all**).

MENU button



2 Select pictures.

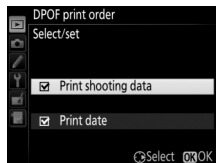
Use the multi selector to highlight pictures (to view images in other locations, press **🔍** and select the desired card and folder as described on page 242; to display the current picture full screen, press and hold the **🔍** button) and, keeping the **🔍** (**🔍**/?) button pressed, press **▲** or **▼** to choose the number of prints (maximum 99). To deselect a picture, set the number of prints to zero. Press **OK** when all the desired pictures have been selected.



3 Select imprint options.

Highlight the following options and press **▶** to toggle the highlighted option on or off.

- **Print shooting data:** Print shutter speed and aperture on all pictures in print order.
- **Print date:** Print date of recording on all pictures in print order.



4 Complete the print order.

Press **OK** to complete the print order.

DPOF Print Orders

To print the current print order when the camera is connected to a PictBridge printer, select **Print (DPOF)** in the PictBridge menu and follow the steps in "Printing Multiple Pictures" to modify and print the current order (□ 282). DPOF print date and shooting data options are not supported when printing via direct USB connection; to print the date of recording on photographs in the current print order, use the PictBridge **Time stamp** option.

The **DPOF print order** option can not be used if there is not enough space on the memory card to store the print order.

NEF (RAW) photographs (□ 90) can not be selected for printing using this option. JPEG copies of NEF (RAW) images can be created using the **NEF (RAW) processing** option in the retouch menu (□ 387).

Print orders may not print correctly if images are deleted using a computer or other device after the print order is created.

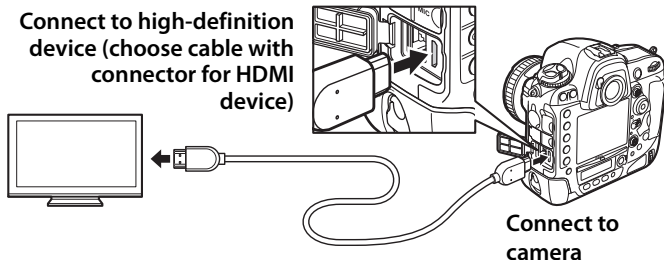
Viewing Photographs on TV

The optional High-Definition Multimedia Interface (HDMI) cable (☐ 410) or a type C HDMI cable (available separately from third-party suppliers) can be used to connect the camera to high-definition video devices.

1 Turn the camera off.

Always turn the camera off before connecting or disconnecting an HDMI cable.

2 Connect the HDMI cable as shown.

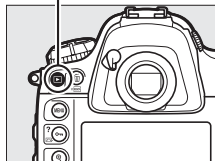


3 Tune the device to the HDMI channel.

4 Turn the camera on and press button.

During playback, images will be displayed on the television screen.

 button

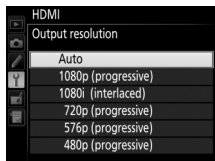


HDMI Options

The **HDMI** option in the setup menu (☰ 358) controls output resolution and other advanced HDMI options.

■ ■ Output Resolution

Choose the format for images output to the HDMI device. If **Auto** is selected, the camera will automatically select the appropriate format.



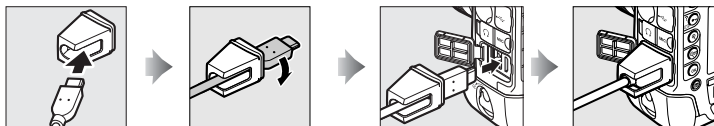
■ ■ Advanced

Option	Description
Output range	Auto is recommended in most situations. If the camera is unable to determine the correct RGB video signal output range for the HDMI device, you can choose from the following options: <ul style="list-style-type: none">• Limited range: For devices with an RGB video signal input range of 16 to 235. Choose this option if you notice loss of detail in shadows.• Full range: For devices with an RGB video signal input range of 0 to 255. Choose this option if shadows are “washed out” or too bright.
Output display size	Choose horizontal and vertical frame coverage for HDMI output from 95% or 100%.
Live view on-screen display	If Off is selected when the camera is connected to an HDMI device, shooting information will not be displayed in the monitor during live view photography.
Dual monitor	Choose On to mirror the HDMI display on the camera monitor, Off to turn the camera monitor off to save power. Dual monitor turns on automatically when Live view on-screen display is Off .



The HDMI Cable Clip

When using the optional Nikon HDMI cable, attach the supplied clip as shown to prevent accidental disconnection. Do not use cable clips with non-Nikon cables.



Television Playback

Use of an AC adapter and power connector (available separately) is recommended for extended playback. If the edges of photographs are not visible in the television display, select **95%** for **HDMI > Advanced > Output display size** (📖 286).

Video Recorders

To record uncompressed HDMI output, use an AJA Video Systems Ki Pro-series or Atomos Ninja-series video recorder (available separately from third-party suppliers).

Voice Memo Options > Audio Output (📖 267)

Set **HDMI** to play back voice memos on the HDMI device.

Slide Shows

The **Slide show** option in the playback menu can be used for automated playback (📖 297).

Audio

Stereo sound recorded with optional ME-1 (📖 413) stereo microphones plays in stereo when movies are viewed on HDMI devices using a camera connected via an HDMI cable. Volume can be adjusted using television controls; the camera controls can not be used.



HDMI and Live View

When the camera is connected via an HDMI cable, HDMI displays can be used for live view photography and movie live view (☞ 61, 69). Note that if **1920 × 1080; 60p** is selected for the **Movie settings > Frame size/frame rate** option in the shooting menu (☞ 74), the selected setting will only be reflected in the HDMI output during movie recording if all the following conditions are met: **Auto** or **1080p (progressive)** is selected for **HDMI > Output resolution**, **100%** is selected for **HDMI > Advanced > Output display size**, and **Off** is selected for **HDMI > Advanced > Live view on-screen display** (☞ 286). At other settings, the output resolution, display size, or frame rate may differ from that selected in the camera menus.



Menu Guide

▶ The Playback Menu: *Managing Images*

To display the playback menu, press **MENU** and select the ▶ (playback menu) tab.

MENU button




Option	Option
Delete	259
Playback folder	290
Hide image	290
Playback display options	291
Copy image(s)	292
Image review	295
After delete	296
Rotate tall	296
Slide show	297
DPOF print order	283

✍ See Also

Menu defaults are listed on page 430.

Playback Folder

MENU button →  playback menu

Choose a folder for playback ( 241).

Option	Description
NCD4S	Pictures in all folders created with the D4S will be visible during playback.
All	Pictures in all folders will be visible during playback.
Current	Only pictures in the current folder will be visible during playback.

Hide Image



MENU button →  playback menu

Hide or reveal selected pictures as described below. Hidden pictures are visible only in the **Hide image** menu and can only be deleted by formatting the memory card.

Protected and Hidden Images




Revealing a protected image will also remove protection from the image.

1 Choose Select/set.

Highlight **Select/set** and press  (to skip the remaining steps and reveal all pictures, highlight **Deselect all** and press .



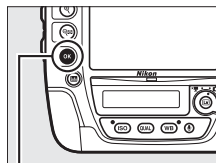
2 Select pictures.

Use the multi selector to scroll through the pictures on the memory card (to view the highlighted picture full screen, press and hold the  button; to view images in other locations, press  and select the desired card and folder as described on page 242) and press the center of the multi selector to select the current picture. Selected pictures are marked by a  icon; to deselect a picture, highlight it and press the center of the multi selector again. Continue until all the desired pictures have been selected.



3 Press .








Press  to complete the operation.



 button

Playback Display Options


MENU button →  playback menu

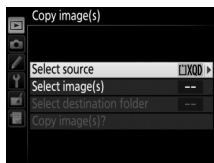
Choose the information available in the playback photo information display ( 244). Press  or  to highlight an option, then press  to select the option for the photo information display. A  appears next to selected items; to deselect, highlight an item and press . To return to the playback menu, press .




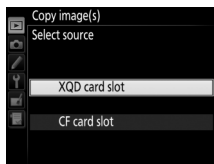
Copy pictures from one memory card to another.

Option	Description
Select source	Choose card from which pictures will be copied.
Select image(s)	Select pictures to be copied.
Select destination folder	Select destination folder on remaining card.
Copy image(s)?	Copy selected pictures to specified destination.

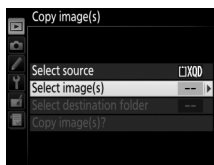
- 1 Choose Select source.**
Highlight **Select source** and press .



- 2 Select the source card.**
Highlight the slot for the card containing the images to be copied and press .

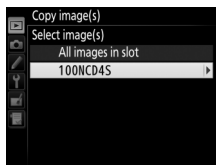


- 3 Choose Select image(s).**
Highlight **Select image(s)** and press .



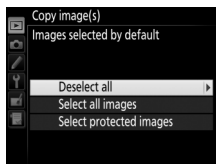
4 Select the source folder.

Highlight the folder containing the images to be copied and press ►.



5 Make the initial selection.

Before going on to select or deselect individual images, you can mark all or all protected images in the folder for copying by choosing **Select all images** or **Select protected images**. To mark only individually selected images for copying, choose **Deselect all** before proceeding.



6 Select additional images.

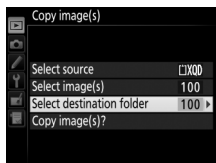
Highlight pictures and press the center of the multi selector to select or deselect (to view the highlighted picture full screen, press and hold the Ⓜ button).



Selected images are marked with a ✓. Press OK to proceed to Step 7 when your selection is complete.

7 Choose Select destination folder.

Highlight **Select destination folder** and press ►.

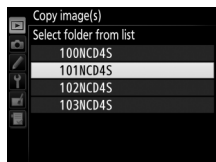


8 Select a destination folder.

To enter a folder number, choose **Select folder by number**, enter the number (00-302), and press **OK**.

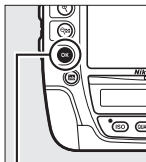


To choose from a list of existing folders, choose **Select folder from list**, highlight a folder, and press **OK**.



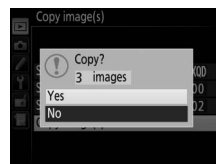
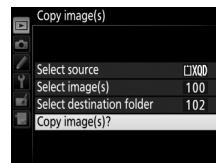
9 Copy the images.

Highlight **Copy image(s)?** and press **OK**.



OK button

A confirmation dialog will be displayed; highlight **Yes** and press **OK**. Press **OK** again to exit when copying is complete.



✓ Copying Images

Images will not be copied if there is insufficient space on the destination card. Be sure the battery is fully charged before copying movies.

If the destination folder contains an image with the same name as one of the images to be copied, a confirmation dialog will be displayed.

Select **Replace existing image** to replace the image with the image to be copied, or select

Replace all to replace all existing images with the same names without further prompting. To

continue without replacing the image, select **Skip**, or select **Cancel** to exit without copying any further images. Hidden or protected files in the destination folder will not be replaced.

Protect status is copied with the images but print marking (📄 283) is not. Voice memos will be copied with their associated images. Hidden images can not be copied.

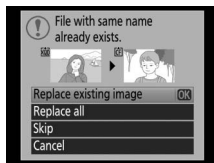



Image Review

MENU button →  playback menu




Choose whether pictures are automatically displayed in the monitor immediately after shooting. If **Off** is selected, pictures can only be displayed by pressing the  button.



After Delete

MENU button →  playback menu


Choose the picture displayed after an image is deleted.

Option	Description
 Show next	Display following picture. If deleted picture was last frame, previous picture will be displayed.
 Show previous	Display previous picture. If deleted picture was first frame, following picture will be displayed.
 Continue as before	If user was scrolling through pictures in order recorded, following picture will be displayed as described for Show next . If user was scrolling through pictures in reverse order, previous picture will be displayed as described for Show previous .



Rotate Tall


MENU button →  playback menu


Choose whether to rotate “tall” (portrait-orientation) pictures for display during playback. Note that because the camera itself is already in the appropriate orientation during shooting, images are not rotated automatically during image review.

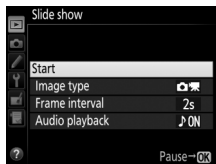
Option	Description
On	“Tall” (portrait-orientation) pictures are automatically rotated for display in the camera monitor. Pictures taken with Off selected for Auto image rotation ( 364) will be displayed in “wide” (landscape) orientation.
Off	“Tall” (portrait-orientation) pictures are displayed in “wide” (landscape) orientation.













Create a slide show of the pictures in the current playback folder ( 290). Hidden images ( 290) are not displayed.

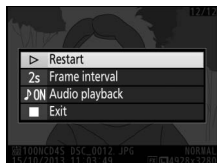
Option	Description
Start	Start slide show.
Image type	Choose type of image displayed from Still images and movies , Still images only , and Movies only .
Frame interval	Choose how long each picture will be displayed.
Audio playback	Display menu of voice memo playback options ( 298).

To start the slide show, highlight **Start** and press . The following operations can be performed while the slide show is in progress:



To	Press	Description
Skip back/skip ahead		Press  to return to previous frame,  to skip to next frame.
View additional photo info		Change or hide photo info (still images only;  244).
Pause/resume		Pause or resume slide show. Voice memo playback may continue after  button has been pressed.
Exit to playback menu	MENU	End slide show and return to playback menu.
Exit to playback mode		End slide show and exit to full-frame or thumbnail playback ( 241).
Exit to shooting mode		Press shutter-release button halfway to return to shooting mode.

The dialog shown at right is displayed when the show ends. Select **Restart** to restart or **Exit** to return to the playback menu.



■ ■ *Audio Playback*


Choose **On** to play voice memos during slide shows (the sound recorded with movies always plays regardless of the option selected). The following options will be displayed:

Option	Description
Frame interval	Playback ends when next frame is displayed, even if entire memo has not been played.
Length of voice memo	Next frame is not displayed until entire memo has been played, even if frame interval is shorter than voice memo.

Choose **Off** to disable voice memo playback during slide shows.



The Shooting Menu: *Shooting Options*

To display the shooting menu, press **MENU** and select the  (shooting menu) tab.

MENU button



Option		Option	
Shooting menu bank	300	Color space	305
Extended menu banks	301	Active D-Lighting	188
Storage folder	302	HDR (high dynamic range)	190
File naming	304	Vignette control	306
Primary slot selection	96	Auto distortion control	307
Secondary slot function	96	Long exposure NR	308
Image quality	90	High ISO NR	308
JPEG/TIFF recording	304	ISO sensitivity settings	117
NEF (RAW) recording	304	Multiple exposure	214
Image area	85	Interval timer shooting	221
White balance	155	Live view photography	60
Set Picture Control	177	Time-lapse photography	229
Manage Picture Control	183	Movie settings	74

See Also

Menu defaults are listed on page 430.

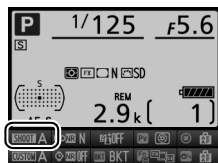
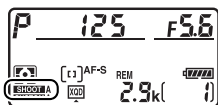


Shooting menu options are stored in one of four banks. With the exceptions of **Extended menu banks**, **Multiple exposure**, **Interval timer shooting**, **Time-lapse photography**, and modifications to Picture Controls (quick adjust and other manual adjustments), changes to settings in one bank have no effect on the others. To store a particular combination of frequently-used settings, select one of the four banks and set the camera to these settings. The new settings will be stored in the bank even when the camera is turned off, and will be restored the next time the bank is selected. Different combinations of settings can be stored in the other banks, allowing the user to switch instantly from one combination to another by selecting the appropriate bank from the bank menu.

The default names for the four shooting menu banks are A, B, C, and D. A descriptive caption up to 20 characters long can be added as described on page 184 by highlighting the menu bank and pressing ►.

Shooting Menu Bank



The top control panel and information displays show the current shooting menu bank.




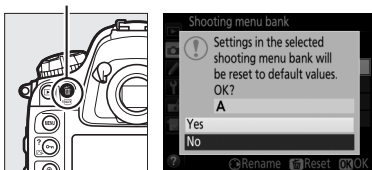
See Also

Exposure and flash modes, shutter speed, and aperture can be included in shooting menu banks using the **Extended menu banks** option in the shooting menu (📖 301). For information on using the controls on the camera body to select the shooting menu bank, see Custom Setting f3 (**Assign Fn button**) > **Press + command dials** (📖 341).

■ Restoring Default Settings

To restore default settings, highlight a bank in the **Shooting menu bank** menu and press  (**FORMAT**). A confirmation dialog will be displayed; highlight **Yes** and press  to restore default settings for the selected bank. See page 430 for a list of default settings.

 (**FORMAT**) button



Extended Menu Banks

MENU button →  shooting menu


Select **On** to include exposure and flash modes, shutter speed (modes **S** and **M** only), and aperture (modes **A** and **M** only) in the information recorded in each of the four shooting menu banks, to be recalled whenever the bank is selected. Selecting **Off** restores the values in effect before **On** was selected.



Select the folder in which subsequent images will be stored.




■ Select Folder by Number




1 Choose **Select folder by number**.

Highlight **Select folder by number** and press **▶**. The dialog shown at right will be displayed, with the current primary slot ( 96) underlined.



2 Choose a folder number.

Press **◀** or **▶** to highlight a digit, press **▲** or **▼** to change. If a folder with the selected number already exists, a , , or  icon will be displayed to the left of the folder number:

-  : Folder is empty.
-  : Folder is partially full.
-  : Folder contains 999 pictures or a picture numbered 9999. No further pictures can be stored in this folder.

3 Save changes and exit.

Press **OK** to complete the operation and return to the shooting menu (to exit without changing the storage folder, press the **MENU** button). If a folder with the specified number does not already exist, a new folder will be created on the card in the primary slot. Subsequent photographs will be stored in the selected folder unless it is already full.

■ Select Folder from List

1 Choose Select folder from list.

Highlight **Select folder from list** and press ►.



2 Highlight a folder.

Press ▲ or ▼ to highlight a folder.

3 Select the highlighted folder.

Press **OK** to select the highlighted folder and return to the shooting menu. Subsequent photographs will be stored in the selected folder.

Folder and File Numbers

If the current folder is numbered 999 and contains 999 pictures or a picture numbered 9999, the shutter-release will be disabled and no further photographs can be taken. To continue shooting, create a folder with a number less than 999, or select an existing folder with a number less than 999 and less than 999 images.

Startup Time

Additional time may be required for camera startup if the memory card contains a very large number of files or folders.



File Naming

MENU button →  shooting menu

Photographs are saved using file names consisting of “DSC_” or, in the case of images that use the Adobe RGB color space (☞ 305), “_DSC”, followed by a four-digit number and a three-letter extension (e.g., “DSC_0001.JPG”). The **File naming** option is used to select three letters to replace the “DSC” portion of the file name. For information on editing file names, see page 184.

Extensions

The following extensions are used: “.NEF” for NEF (RAW) images, “.TIF” for TIFF (RGB) images, “.JPG” for JPEG images, “.MOV” for movies, and “.NDF” for dust off reference data. In each pair of photographs recorded at image-quality settings of NEF (RAW)+JPEG, the NEF and JPEG images have the same file names but different extensions.

JPEG/TIFF Recording

MENU button →  shooting menu

Adjust compression (☞ 92) and size (☞ 94) settings for photographs recorded in JPEG and TIFF formats.

NEF (RAW) Recording

MENU button →  shooting menu

Choose the compression (☞ 92), bit-depth (☞ 92), and size (☞ 95) of photographs recorded in NEF (RAW) format.

The color space determines the gamut of colors available for color reproduction. **sRGB** is recommended for movies and for general-purpose printing and display, **Adobe RGB**, with its broader gamut of colors, for professional publication and commercial printing.

Adobe RGB

For accurate color reproduction, Adobe RGB images require applications, displays, and printers that support color management.

Color Space




ViewNX 2 (supplied) and Capture NX 2 (available separately) automatically select the correct color space when opening photographs created with this camera. Results can not be guaranteed with third-party software.




“Vignetting” is a drop in brightness at the edges of a photograph. **Vignette control** reduces vignetting for type G, E, and D lenses (DX and PC lenses excluded). Its effects vary from lens to lens and are most noticeable at maximum aperture. Choose from **High**, **Normal**, **Low**, and **Off**.

Vignette Control

Depending on the scene, shooting conditions, and type of lens, TIFF and JPEG images may exhibit noise (fog) or variations in peripheral brightness, while custom Picture Controls and preset Picture Controls that have been modified from default settings may not produce the desired effect. Take test shots and view the results in the monitor.

Vignette control does not apply to movies ( 63), multiple exposures ( 214), or photographs recorded with a DX lens or **DX (24 × 16) 1.5 ×** (DX format) selected for image area ( 86).



Select **On** to reduce barrel distortion when shooting with wide-angle lenses and to reduce pin-cushion distortion when shooting with long lenses (note that the edges of the area visible in the viewfinder may be cropped out of the final photograph, and that the time needed to process photographs before recording begins may increase). This option does not apply to movies and is available only with type G, E, and D lenses (PC, fisheye, and certain other lenses excluded); results are not guaranteed with other lenses. Before using auto distortion control with DX lenses, select **On** for **Auto DX crop** or choose an image area of **DX (24×16) 1.5x** ( 86); selecting other options may result in heavily cropped photographs or in photographs with severe peripheral distortion.

Retouch: Distortion Control

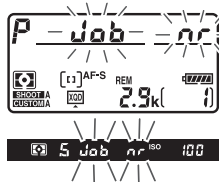
For information on creating copies of existing photographs with reduced barrel and pin-cushion distortion, see page 392.



Long Exposure NR (Long Exposure Noise Reduction)

MENU button →  shooting menu

If **On** is selected, photographs taken at shutter speeds slower than 1 s will be processed to reduce noise (bright spots, randomly-spaced bright pixels, or fog). The time required for processing roughly doubles; during processing, “Job nr” will flash in the shutter speed/aperture displays and pictures can not be taken (if the camera is turned off before processing is complete, the picture will be saved but noise reduction will not be performed). In continuous release mode, frame rates will slow and while photographs are being processed, the capacity of the memory buffer will drop.




High ISO NR

MENU button →  shooting menu

Photographs taken at high ISO sensitivities can be processed to reduce noise.

Option	Description
High	Reduce noise (randomly-spaced bright pixels, lines, or fog), particularly in photographs taken at high ISO sensitivities.
Normal	Choose the amount of noise reduction performed from High ,
Low	Normal , and Low .
Off	Noise reduction is performed only at ISO sensitivities of 6400 and higher. The amount of noise reduction is less than the amount performed when Low is selected for High ISO NR .

Custom Settings: *Fine-Tuning Camera Settings*

To display the Custom Settings menu, press **MENU** and select the  (Custom Settings menu) tab.

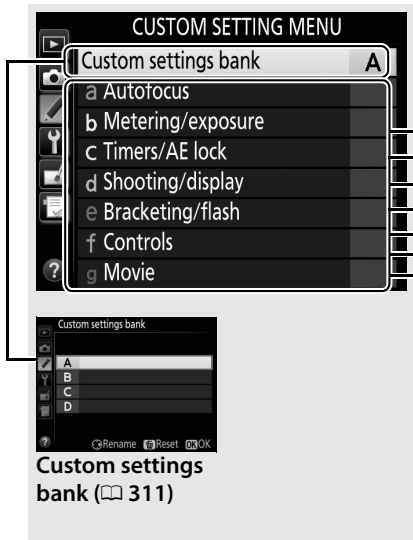
MENU button



Custom Settings are used to customize camera settings to suit individual preferences.

Custom Setting groups

Main menu




The following Custom Settings are available:

Custom Setting		📖
Custom settings bank		311
a Autofocus		
a1	AF-C priority selection	313
a2	AF-S priority selection	314
a3	Focus tracking with lock-on	314
a4	AF activation	315
a5	Focus point illumination	315
a6	Focus point wrap-around	316
a7	Number of focus points	316
a8	Assign AF-ON button	317
a9	Assign AF-ON button (vert.)	318
a10	Store by orientation	319
a11	Limit AF-area mode selection	320
a12	Autofocus mode restrictions	320
b Metering/exposure		
b1	ISO sensitivity step value	321
b2	EV steps for exposure cntrl	321
b3	Exp./flash comp. step value	321
b4	Easy exposure compensation	322
b5	Matrix metering	323
b6	Center-weighted area	323
b7	Fine-tune optimal exposure	323
c Timers/AE lock		
c1	Shutter-release button AE-L	324
c2	Standby timer	324
c3	Self-timer	325
c4	Monitor off delay	325
d Shooting/display		
d1	Beep	326
d2	Continuous shooting speed	326
d3	Max. continuous release	327
d4	Exposure delay mode	327
d5	File number sequence	328
d6	Viewfinder grid display	329
d7	Control panel/viewfinder	329
d8	Screen tips	329
d9	Information display	330
d10	LCD illumination	330




Custom Setting		📖
e Bracketing/flash		
e1	Flash sync speed	331
e2	Flash shutter speed	332
e3	Optional flash	332
e4	Exposure comp. for flash	333
e5	Modeling flash	333
e6	Auto bracketing set	333
e7	Auto bracketing (mode M)	334
e8	Bracketing order	334
f Controls		
f1	Multi selector center button	335
f2	Multi selector	336
f3	Assign Fn button	337
f4	Assign preview button	342
f5	Assign sub-selector	342
f6	Assign sub-selector center	342
f7	Assign Fn button (vert.)	343
f8	Shutter spd & aperture lock	343
f9	Assign BKT button	344
f10	Customize command dials	345
f11	Release button to use dial	347
f12	Slot empty release lock	347
f13	Reverse indicators	347
f14	Assign multi selector (vert.)	348
f15	Playback zoom	348
f16	Assign movie record button	349
f17	Live view button options	349
f18	Assign remote (WR) Fn button	350
f19	Lens focus function buttons	351
g Movie		
g1	Assign Fn button	353
g2	Assign preview button	355
g3	Assign sub-selector center	356
g4	Assign shutter button	357




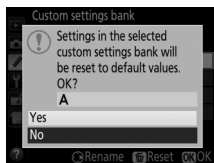
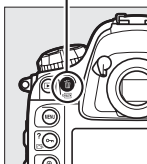
Custom Settings are stored in one of four banks. Changes to settings in one bank have no effect on the others. To store a particular combination of frequently-used settings, select one of the four banks and set the camera to these settings. The new settings will be stored in the bank even when the camera is turned off, and will be restored the next time the bank is selected. Different combinations of settings can be stored in the other banks, allowing the user to switch instantly from one combination to another by selecting the appropriate bank from the bank menu.

The default names for the four Custom Settings banks are A, B, C, and D. A descriptive caption up to 20 characters long can be added as described on page 184 by highlighting the menu bank and pressing .

■ Restoring Default Settings

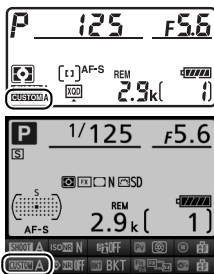
To restore default settings, highlight a bank in the **Custom settings bank** menu and press  (FORMAT). A confirmation dialog will be displayed; highlight **Yes** and press  to restore default settings for the selected bank ( 433).

 (FORMAT) button



Custom Settings Bank

The top control panel and information displays show the current Custom Settings bank.




See Also





Menu defaults are listed on page 433. If settings in the current bank have been modified from default values, an asterisk will be displayed adjacent to the altered settings in the second level of the Custom Settings menu.

a: Autofocus

a1: AF-C Priority Selection

MENU button →  Custom Settings menu

When **AF-C** is selected for viewfinder photography ( 97), this option controls whether photographs can be taken whenever the shutter-release button is pressed (*release priority*) or only when the camera is in focus (*focus priority*).


Option	Description
 Release	Photos can be taken whenever the shutter-release button is pressed.
 Focus + release	Photos can be taken even when the camera is not in focus. If the subject is dark or low contrast and the camera is in continuous mode, priority will be given to focus for the first shot in each series and to frame rate for the remaining shots, ensuring a high frame rate if the distance to the subject does not change during shooting.
 Release + focus	Photos can be taken even when the camera is not in focus. In continuous mode, frame rate slows for improved focus if the subject is dark or low contrast.
 Focus	Photos can only be taken when the in-focus indicator (●) is displayed.




Regardless of the option selected, focus will not lock when **AF-C** is selected for autofocus mode. The camera will continue to adjust focus until the shutter is released.




a2: AF-S Priority Selection


MENU button →  Custom Settings menu


When **AF-S** is selected for viewfinder photography ( 97), this option controls whether photographs can be taken only when the camera is in focus (*focus priority*) or whenever the shutter-release button is pressed (*release priority*).







Option	Description
 Release	Photos can be taken whenever the shutter-release button is pressed.
 Focus	Photos can only be taken when the in-focus indicator () is displayed.

Regardless of the option selected, if the in-focus indicator () is displayed when **AF-S** is selected for autofocus mode, focus will lock while the shutter-release button is pressed halfway. Focus lock continues until the shutter is released.

a3: Focus Tracking with Lock-On

MENU button →  Custom Settings menu

This option controls how autofocus adjusts to sudden large changes in the distance to the subject when **AF-C** is selected during viewfinder photography ( 97).

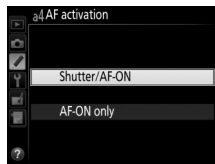
Option	Description
AF  5 (Long)	When the distance to the subject changes abruptly, the camera waits for the specified period before adjusting the distance to the subject. This prevents the camera from refocusing when the subject is briefly obscured by objects passing through the frame. Note that 2 , 1 (Short) , and Off are equivalent to 3 (Normal) when 3D-tracking or auto-area AF is selected for AF-area mode ( 100).
AF  4	
AF  3 (Normal)	
AF  2	
AF  1 (Short)	
Off	The camera immediately adjusts focus when the distance to the subject changes. Use when photographing a series of subjects at varying distances in quick succession.




a4: AF Activation

MENU button →  Custom Settings menu


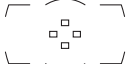



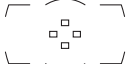


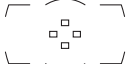


If **Shutter/AF-ON** is selected, both the shutter-release button and the **AF-ON** button can be used to initiate autofocus. Select **AF-ON only** to prevent the camera focusing when the shutter-release button is pressed halfway.



a5: Focus Point Illumination

MENU button →  Custom Settings menu

Choose from the following focus point display options.




Option	Description					
Manual focus mode	Choose On to display the active focus point in manual focus mode, Off to display the focus point only during focus point selection.					
Continuous mode	Choose On to display the active focus point in Ch (continuous high-speed) and Cl (continuous low-speed) modes.					
Focus point brightness	Choose the brightness of the focus point display in the viewfinder from Extra high , High , Normal , and Low .					
Dynamic-area AF display	Choose On to display both the selected focus point and the surrounding focus points in dynamic-area AF mode (☞ 100). When 3D-tracking is used, a dot will be displayed in the center of the focus point (☞).					
Group-area AF illumination	Choose how the active focus points are displayed in group-area AF (☞ 101).					
	<table border="1"><thead><tr><th>Option</th><th>Focus point display</th></tr></thead><tbody><tr><td></td><td></td></tr><tr><td></td><td></td></tr></tbody></table>	Option	Focus point display			
Option	Focus point display					
						
						




a6: Focus Point Wrap-Around

MENU button →  Custom Settings menu

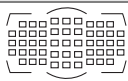

Choose whether focus-point selection “wraps around” from one edge of the viewfinder to another.

Option	Description
Wrap	Focus-point selection “wraps around” from top to bottom, bottom to top, right to left, and left to right, so that, for example, pressing  when a focus point at the right edge of the viewfinder display is highlighted (①) selects the corresponding focus point at the left edge of the display (②). 
No wrap	The focus-point display is bounded by the outermost focus points so that, for example, pressing  when a focus point at the right edge of the display is selected has no effect.

a7: Number of Focus Points


MENU button →  Custom Settings menu

Choose the number of focus points available for manual focus-point selection.

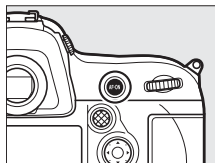
Option	Description
AF51 51 points	Choose from the 51 focus points shown at right. 
AF11 11 points	Choose from the 11 focus points shown at right. Use for quick focus-point selection. 









a8: Assign AF-ON Button

MENU button →  Custom Settings menu

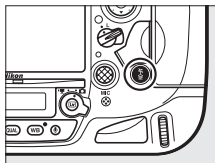
Choose the function performed when the AF-ON button is pressed.










Option	Description
 AF-ON	Pressing the AF-ON button initiates autofocus.
 AE/AF lock	Focus and exposure lock while the AF-ON button is pressed.
 AE lock only	Exposure locks while the AF-ON button is pressed.
 AE lock (Reset on release)	Exposure locks when the AF-ON button is pressed, and remains locked until the button is pressed a second time, the shutter is released, or the standby timer expires.
 AE lock (Hold)	Exposure locks when the AF-ON button is pressed, and remains locked until the button is pressed a second time or the standby timer expires.
 AF lock only	Focus locks while the AF-ON button is pressed.
None	No operation is performed when the AF-ON button is pressed.



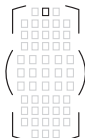
Choose the function assigned to the **AF-ON** button for vertical shooting.



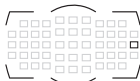
Option	Description
 Same as AF-ON button	Both AF-ON buttons perform the function selected for Custom Setting a8.
 AF-ON	Pressing the vertical AF-ON button initiates autofocus.
 AE/AF lock	Focus and exposure lock while the vertical AF-ON button is pressed.
 AE lock only	Exposure locks while the vertical AF-ON button is pressed.
 AE lock (Reset on release)	Exposure locks when the vertical AF-ON button is pressed, and remains locked until the button is pressed a second time, the shutter is released, or the standby timer expires.
 AE lock (Hold)	Exposure locks when the vertical AF-ON button is pressed, and remains locked until the button is pressed a second time or the standby timer expires.
 AF lock only	Focus locks while the vertical AF-ON button is pressed.
None	No operation is performed when the vertical AF-ON button is pressed.

Choose whether separate focus points can be selected for “wide” (landscape) orientation, for “tall” (portrait) orientation with the camera rotated 90° clockwise, and for “tall” orientation with the camera rotated 90° counterclockwise.

Select **Off** to use the same focus point and AF-area mode regardless of camera orientation.



Camera rotated
90°counterclockwise



Landscape (wide)
orientation

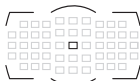


Camera rotated
90°clockwise

Choose **Focus point** to enable separate focus-point selection, or **Focus point and AF-area mode** to enable separate selection of both the focus point and the AF-area mode.



Camera rotated
90°counterclockwise



Landscape (wide)
orientation






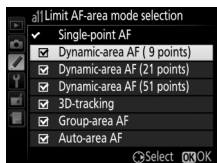
Camera rotated
90°clockwise



a11: Limit AF-Area Mode Selection


MENU button →  Custom Settings menu

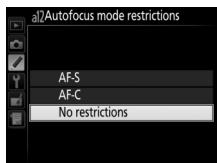
Choose the AF-area modes that can be selected using the AF-mode button and sub-command dial in viewfinder photography (live view is unaffected;  100). Highlight the desired modes and press  to select or deselect. Press  to save changes when settings are complete.



a12: Autofocus Mode Restrictions


MENU button →  Custom Settings menu

Choose the autofocus modes available in viewfinder photography ( 97). If only one mode is selected, the autofocus mode can not be chosen using the AF-mode button and main command dial.

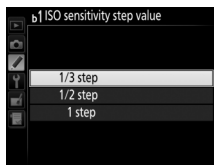


b: Metering/Exposure


b1: ISO Sensitivity Step Value

MENU button →  Custom Settings menu

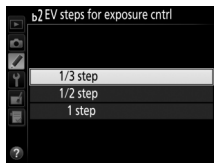
Select the increments used when making adjustments to ISO sensitivity (📖 117). If possible, the current ISO sensitivity setting is maintained when the step value is changed. If the current ISO sensitivity setting is not available at the new step value, ISO sensitivity will be rounded to the nearest available setting.



b2: EV Steps for Exposure Cntrl

MENU button →  Custom Settings menu

Select the increments used when making adjustments to shutter speed, aperture, and bracketing.






b3: Exp./Flash Comp. Step Value

MENU button →  Custom Settings menu

Select the increments used when making adjustments to exposure and flash compensation.



This option controls whether the  button is needed to set exposure compensation (□ 138). If **On (Auto reset)** or **On** is selected, the 0 at the center of the exposure display will flash even when exposure compensation is set to ± 0 .

Option	Description
On (Auto reset)	Exposure compensation is set by rotating one of the command dials (see note below). The setting selected using the command dial is reset when the camera turns off or the standby timer expires (exposure compensation settings selected using the  button are not reset).
On	As above, except that the exposure compensation value selected using the command dial is not reset when the camera turns off or the standby timer expires.
Off	Exposure compensation is set by pressing the  button and rotating the main command dial.

Change Main/Sub

The dial used to set exposure compensation when **On (Auto reset)** or **On** is selected for Custom Setting b4 (**Easy exposure compensation**) depends on the option selected for Custom Setting f10 (**Customize command dials**) > **Change main/sub** (□ 345).

		Customize command dials > Change main/sub	
		Off	On
Exposure mode	P	Sub-command dial	Sub-command dial
	S	Sub-command dial	Main command dial
	A	Main command dial	Sub-command dial
	M	N/A	

b5: Matrix Metering

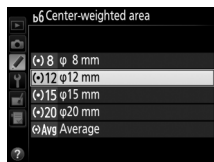
MENU button → Custom Settings menu

Choose **ON Face detection on** to enable face detection when shooting portraits with matrix metering during viewfinder photography (□ 123).

b6: Center-Weighted Area

MENU button → Custom Settings menu

When calculating exposure, center-weighted metering assigns the greatest weight to a circle in the center of the frame. The diameter (ϕ) of this circle can be set to 8, 12, 15, or 20 mm or to the average of the entire frame.

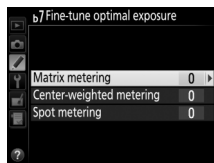


Note that the diameter is fixed at 12 mm when a non-CPU lens is used, regardless of the setting selected for **Non-CPU lens data** in the setup menu (□ 235).

b7: Fine-Tune Optimal Exposure

MENU button → Custom Settings menu

Use this option to fine-tune the exposure value selected by the camera. Exposure can be fine-tuned separately for each metering method by from +1 to -1 EV in steps of $1/6$ EV.



Fine-Tuning Exposure

Exposure can be fine-tuned separately for each Custom Settings bank and is not affected by two-button resets. Note that as the exposure compensation (icon) is not displayed, the only way to determine how much exposure has been altered is to view the amount in the fine-tuning menu. Exposure compensation (□ 138) is preferred in most situations.



c: Timers/AE Lock

c1: Shutter-Release Button AE-L MENU button → Custom Settings menu

If **On** is selected, exposure will lock when the shutter-release button is pressed halfway.

c2: Standby Timer MENU button → Custom Settings menu


Choose how long the camera continues to meter exposure when no operations are performed. The shutter-speed and aperture displays in the top control panel and viewfinder turn off automatically when the standby timer expires.



Choose a shorter standby timer delay for longer battery life.



c3: Self-Timer

MENU button →  Custom Settings menu

Choose the length of the shutter release delay, the number of shots taken, and the interval between shots in self-timer mode.

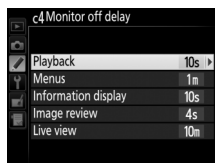
- **Self-timer delay:** Choose the length of the shutter-release delay.
- **Number of shots:** Press ▲ and ▼ to choose the number of shots taken each time the shutter-release button is pressed.
- **Interval between shots:** Choose the interval between shots when the **Number of shots** is more than 1.



c4: Monitor off Delay

MENU button →  Custom Settings menu






Choose how long the monitor remains on when no operations are performed during playback (**Playback**; defaults to 10 s) and image review (**Image review**; defaults to 4 s), when menus (**Menus**; defaults to 1 minute) or information (**Information display**; defaults to 10 s) are displayed, or during live view and movie recording (**Live view**; defaults to 10 minutes). Choose a shorter monitor-off delay for longer battery life.




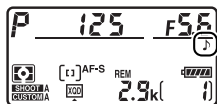
d: Shooting/Display

d1: Beep

MENU button →  Custom Settings menu

Choose the pitch and volume of the beep that sounds when the camera focuses using single-servo AF (**AF-S**;  97), when focus locks during live view photography, or while the release timer is counting down in self-timer mode ( 114), or when time-lapse photography ends ( 229). Note that regardless of the option selected, a beep will not sound in movie live view ( 63), or quiet-shutter release mode (mode **Q**;  111), or if **Silent** is selected during live view photography.

- **Volume:** Choose **3** (high), **2** (medium), **1** (low) or **Off** (mute). When an option other than **Off** is selected,  appears in the top control panel and information display.
- **Pitch:** Choose **High** or **Low**.



d2: Continuous Shooting Speed

MENU button →  Custom Settings menu

Choose the maximum frame advance rate for **CH** (continuous high-speed) and **CL** (continuous low-speed) modes. For more information on frame rate, see page 112.


Option	Description
Continuous high-speed	Choose the frame advance rate for CH (continuous high-speed) mode from 10 and 11 fps.
Continuous low-speed	Choose the frame advance rate for CL (continuous low-speed) mode from values between 1 and 10 fps.

d3: Max. Continuous Release


MENU button →  Custom Settings menu


The maximum number of shots that can be taken in a single burst in continuous mode can be set to any value between 1 and 200.

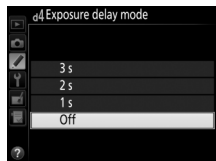
The Memory Buffer

Regardless of the option selected for Custom Setting d3, shooting will slow when the memory buffer fills (). See page 464 for more information on the capacity of the memory buffer.

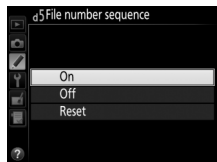
d4: Exposure Delay Mode

MENU button →  Custom Settings menu

In situations where the slightest camera movement can blur pictures, select **1 s**, **2 s**, or **3 s** to delay shutter release until one, two, or three seconds after the mirror is raised. Exposure delay is not available when **Silent** is selected for **Live view photography** in the shooting menu ( 60).



When a photograph is taken, the camera names the file by adding one to the last file number used. This option controls whether file numbering continues from the last number used when a new folder is created, the memory card is formatted, or a new memory card is inserted in the camera.



Option	Description
On	When a new folder is created, the memory card formatted, or a new memory card inserted in the camera, file numbering continues from the last number used or from the largest file number in the current folder, whichever is higher. If a photograph is taken when the current folder contains a photograph numbered 9999, a new folder will be created automatically and file numbering will begin again from 0001.
Off	File numbering is reset to 0001 when a new folder is created, the memory card is formatted, or a new memory card is inserted in the camera. Note that a new folder is created automatically if a photograph is taken when the current folder contains 999 photographs.
Reset	As for On , except that the next photograph taken is assigned a file number by adding one to the largest file number in the current folder. If the folder is empty, file numbering is reset to 0001.

File Number Sequence

If the current folder is numbered 999 and contains either 999 photographs or a photograph numbered 9999, the shutter-release button will be disabled and no further photographs can be taken. Choose **Reset** for Custom Setting d5 (**File number sequence**) and then either format the current memory card or insert a new memory card.

d6: Viewfinder Grid Display

MENU button →  Custom Settings menu

Choose **On** to display on-demand grid lines in the viewfinder for reference when composing photographs (📖 10).

d7: Control Panel/Viewfinder

MENU button →  Custom Settings menu

Choose the information displayed in the viewfinder and rear control panel.

Option	Description
Rear control panel	Choose from ISO sensitivity (ISO) and Exposures remaining (🕒). If Exposures remaining is selected, ISO sensitivity will only be displayed while the ISO button is pressed.
Viewfinder display	Choose from Frame count (📷) and Exposures remaining (🕒). Note that regardless of the option selected, memory buffer capacity will be shown while the shutter-release button is pressed.

d8: Screen Tips


MENU button →  Custom Settings menu

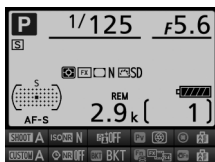
Choose **On** to display tool tips for items selected in the information display (📖 15).



d9: Information Display

MENU button →  Custom Settings menu

If **Auto (AUTO)** is selected, the color of the lettering in the information display ( 12) will automatically change from black to white or white to black to maintain contrast with the background. To always use the same color lettering, select **Manual** and choose **Dark on light (B; black lettering)** or **Light on dark (W; white lettering)**. Monitor brightness will automatically be adjusted for maximum contrast with the selected text color.





Dark on light











Light on dark

d10: LCD Illumination

MENU button →  Custom Settings menu

If **Off** is selected, the control panel and button backlights (illuminators) will only light while the power switch is rotated toward . If **On** is selected, the backlights will remain on while the standby timer is active ( 44; note that regardless of the option selected, the backlights turn off while the shutter-release button is pressed). Select **Off** for increased battery life.

Button Backlights

The following controls are equipped with backlights: the BKT, , , MENU, , , , , , , **WB**, **QUAL**, and **ISO** buttons and the release mode dial.

e: Bracketing/Flash

e1: Flash Sync Speed

MENU button →  Custom Settings menu

This option controls flash sync speed.

Option	Description
1/250 s (Auto FP)	Auto FP high-speed sync is used when a compatible flash unit is attached (☐ 197). If other flash units are used, shutter speed is set to 1/250 s. When the camera shows a shutter speed of 1/250 s in exposure mode P or A , auto FP high-speed sync will be activated if the actual shutter speed is faster than 1/250 s.
1/250 s–1/60 s	Flash sync speed set to selected value.

Fixing Shutter Speed at the Flash Sync Speed Limit

To fix shutter speed at the sync speed limit in shutter-priority auto or manual exposure modes, select the next shutter speed after the slowest possible shutter speed (30 s or -). An X (flash sync indicator) will be displayed in the viewfinder and top control panel.

Auto FP High-Speed Sync

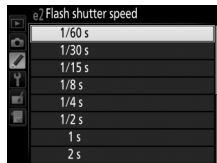
Allows the flash to be used at the highest shutter speed supported by the camera, making it possible to choose the maximum aperture for reduced depth of field even when the subject is backlit in bright sunlight. The information display flash mode indicator shows “FP” when auto FP high-speed sync is active (☐ 201).



e2: Flash Shutter Speed

MENU button →  Custom Settings menu



This option determines the slowest shutter speed available when using front- or rear-curtain sync or red-eye reduction in programmed auto or aperture-priority auto exposure modes (regardless of the setting chosen, shutter speeds can be as slow as 30 s in shutter-priority auto and manual exposure modes or at flash settings of slow sync, slow rear-curtain sync, or red-eye reduction with slow sync). Options range from $\frac{1}{60}$ s (**1/60 s**) to 30 s (**30 s**).



e3: Optional Flash

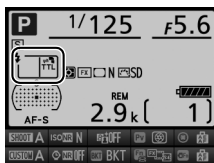
MENU button →  Custom Settings menu

Choose a flash control mode for optional SB-400 or SB-300 flash units.


Option	Description
TTL 	Flash output is adjusted automatically in response to shooting conditions (📖 199).
 Manual	Choose a flash level. Monitor pre-flashes are not emitted.

Flash Control Mode



The flash control mode is shown in the information display (📖 12, 201).



e4: Exposure Comp. for Flash

MENU button →  Custom Settings menu

Choose how the camera adjusts flash level when exposure compensation is used.

Option	Description
 Entire frame	Both flash level and exposure compensation are adjusted to modify exposure over the entire frame.
 Background only	Exposure compensation applies to background only.

e5: Modeling Flash

MENU button →  Custom Settings menu

If **On** is selected when the camera is used with an optional flash unit that supports the Nikon Creative Lighting system (□ 196), a modeling flash will be emitted when the camera **Pv** button is pressed (□ 126). No modeling flash is emitted if **Off** is selected.

e6: Auto Bracketing Set

MENU button →  Custom Settings menu





Choose the setting or settings bracketed when auto bracketing (□ 140) is in effect. Choose **AE & flash** (AE~~z~~) to perform both exposure and flash-level bracketing, **AE only** (AE) to bracket only exposure, **Flash only** (z) to perform only flash-level bracketing, **WB bracketing** (WB) to perform white balance bracketing (□ 146), or **ADL bracketing** (ADL) to perform bracketing using Active D-Lighting (□ 150). Note that white balance bracketing is not available at image quality settings of NEF (RAW) or NEF (RAW) + JPEG.



e7: Auto Bracketing (Mode M)

MENU button →  Custom Settings menu

This option determines which settings are affected when **AE & flash** or **AE only** is selected for Custom Setting e6 in manual exposure mode.

Option	Description
 Flash/speed	Camera varies shutter speed (Custom Setting e6 set to AE only) or shutter speed and flash level (Custom Setting e6 set to AE & flash).
 Flash/speed/aperture	Camera varies shutter speed and aperture (Custom Setting e6 set to AE only) or shutter speed, aperture, and flash level (Custom Setting e6 set to AE & flash).
 Flash/aperture	Camera varies aperture (Custom Setting e6 set to AE only) or aperture and flash level (Custom Setting e6 set to AE & flash).
 Flash only	Camera varies flash level only (Custom Setting e6 set to AE & flash).

Flash bracketing is performed only with i-TTL or AA flash control. If a setting other than **Flash only** is selected and the flash is not used, ISO sensitivity will be fixed at the value for the first shot, regardless of the setting selected for auto ISO sensitivity control (📖 119).

e8: Bracketing Order

MENU button →  Custom Settings menu

At the default setting of **MTR > under > over** (📷), exposure, flash, and white balance bracketing are performed in the order described on pages 143 and 147. If **Under > MTR > over** (→→+) is selected, shooting will proceed in order from the lowest to the highest value. This setting has no effect on ADL bracketing.




f: Controls

f1: Multi Selector Center Button MENU button → Custom Settings menu





This option determines the role assigned to the center of the multi selector during viewfinder photography, playback, and live view (regardless of the option selected, pressing the center of the multi selector when a movie is displayed full frame starts movie playback).

■ Shooting Mode


Option	Role assigned to center of multi selector
RESET Select center focus point	Select the center focus point.
PRE ^[*] Preset focus point	Pressing the center of the multi selector selects a preset focus point. To choose the point, select it and press the center of the multi selector while pressing the AF-mode button until the focus point flashes. Separate focus points can be selected for “wide” (landscape) orientation and for each of the two “tall” (portrait) orientations if Focus point or Focus point and AF-area mode is selected for Custom Setting a10 (Store by orientation ,  319).
None	Pressing the center of the multi selector has no effect in viewfinder photography.



■ Playback Mode

Option	Role assigned to center of multi selector
 Thumbnail on/off	Toggle between full-frame and thumbnail playback.
 View histograms	In both full-frame and thumbnail playback, a histogram is displayed while the center of the multi selector is pressed.
 Zoom on/off	Toggle between full-frame or thumbnail playback and playback zoom. Choose the initial zoom setting from Low magnification (50%) , 1 : 1 (100%) , and High magnification (200%) . The zoom display will center on the active focus point (if the picture was taken in viewfinder photography) or on the center of the image (if the picture was taken during live view).
 Choose slot and folder	Display the slot and folder selection dialog (📖 242).

■ Live View

Option	Role assigned to center of multi selector
RESET Select center focus point	Pressing the center of the multi selector in live view selects the center focus point.
 Zoom on/off	Press the center of the multi selector to toggle zoom on and off. Choose the initial zoom setting from Low magnification (50%) , 1 : 1 (100%) , and High magnification (200%) . The zoom display will center on the active focus point.
None	Pressing the center of the multi selector has no effect in live view.

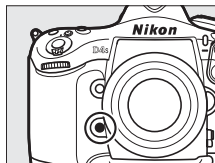
f2: Multi Selector

MENU button →  Custom Settings menu

If **Restart standby timer** is selected, operating the multi selector when the standby timer expires (📖 44) will activate the meters and start the standby timer. If **Do nothing** is selected, the timer will not start when the multi selector is pressed.











Choose the role played by the **Fn** button, either by itself (**Press**) or when used in combination with the command dials (**Press + command dials**).











■ ■ Press








Selecting **Press** displays the following options:

Option	Description
 Preview	During viewfinder photography, you can preview depth of field while the Fn button is pressed (□ 126). During live view photography, you can press the button once to open the lens to maximum aperture, making it easier to check focus; pressing the button again restores aperture to its original value (□ 54).
 FLV lock	Press the Fn button to lock flash value (supported flash units only, □ 196, 208). Press again to cancel FLV lock.
 AE/AF lock	Focus and exposure lock while the Fn button is pressed.
 AE lock only	Exposure locks while the Fn button is pressed.
 AE lock (Reset on release)	Exposure locks when the Fn button is pressed, and remains locked until the button is pressed a second time, the shutter is released, or the standby timer expires.
 AE lock (Hold)	Exposure locks when the Fn button is pressed, and remains locked until the button is pressed a second time or the standby timer expires.
 AF lock only	Focus locks while the Fn button is pressed.
 AF-ON	Pressing the Fn button initiates autofocus.



Option	Description
 Disable/enable	If the flash is currently off, front-curtain sync will be selected while the Fn button is pressed. If the flash is currently enabled, it will instead be disabled while the Fn button is pressed.
 Bracketing burst	If the Fn button is pressed while exposure, flash, or ADL bracketing is active in single frame or quiet shutter-release mode, all shots in the current bracketing program will be taken each time the shutter-release button is pressed. If white balance bracketing is active or continuous release mode (mode CH or CL) is selected, the camera will repeat the bracketing burst while the shutter-release button is held down.
 + NEF (RAW)	If image quality is set to JPEG fine , JPEG normal , or JPEG basic , “RAW” will be displayed in the rear control panel and an NEF (RAW) copy will be recorded with the next picture taken after the Fn button is pressed (the original image quality setting will be restored when you remove your finger from the shutter-release button). NEF (RAW) copies are recorded at the settings currently selected for NEF (RAW) recording in the shooting menu (☰ 304). To exit without recording an NEF (RAW) copy, press the Fn button again.
 Matrix metering	Matrix metering is activated while the Fn button is pressed.
 Center-weighted metering	Center-weighted metering is activated while the Fn button is pressed.
 Spot metering	Spot metering is activated while the Fn button is pressed.
 Viewfinder grid display	Press the Fn button to turn the framing grid display in the viewfinder on or off (☰ 10).
 Viewfinder virtual horizon	Press the Fn button to view a virtual horizon display in the viewfinder (☰ 340).



Option	Description
 Disable synchronized release	Keep the Fn button pressed to take photographs with the master camera only when using a wireless transmitter or wireless remote controller for remote synchronized release.
 Remote release only	Keep the Fn button pressed to take photographs with the remote cameras only when using a wireless transmitter or wireless remote controller for remote synchronized release.
 MY MENU	Pressing the Fn button displays “MY MENU”.
 Access top item in MY MENU	Press the Fn button to jump to the top item in “MY MENU.” Select this option for quick access to a frequently-used menu item.
 Playback	Fn button performs same function as  button. Select when using a telephoto lens or in other circumstances in which it is difficult to operate the  button with your left hand.
None	Pressing the button has no effect.

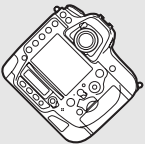

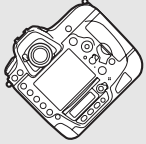



Incompatible Options

If the option selected for **Press** can not be used in combination with the option selected for **Press + command dials**, a message will be displayed and whichever of **Press** or **Press + command dials** was selected first will be set to **None**.


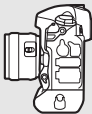




Virtual Horizon

When **Viewfinder virtual horizon** is selected for f3 (**Assign Fn button**) > **Press**, pressing the **Fn** button displays a pitch and roll indicators in the viewfinder. Press the button a second time to clear the indicators from display.

Roll

Camera tilted right	Camera level	Camera tilted left
		
		


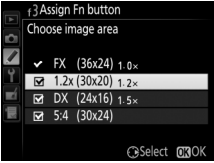





Pitch

Camera tilted forward	Camera level	Camera tilted back
		
		

The roles of the pitch and roll indicators are reversed when the camera is rotated to take pictures in “tall” (portrait) orientation. Note that the display may not be accurate when the camera is tilted at a sharp angle forward or back. If the camera is unable to measure tilt, the amount of tilt will not be displayed.

■ ■ Press + command dials

Selecting **Press + command dials** displays the following options:

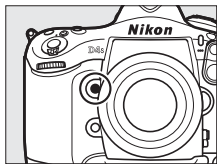
Option	Description
 Choose image area	<p>Press the FN button and rotate a command dial to choose from pre-selected image areas (☞ 85). Selecting Choose image area displays a list of image areas; highlight options and press ▶ to select or deselect, then press OK.</p> 
 Shutter spd & aperture lock	<p>Press the FN button and rotate the main command dial to lock shutter speed in modes S and M; press the FN button and rotate the sub-command dial to lock aperture in modes A and M. See page 134 for more information.</p>
 1 step spd/aperture	<p>If the FN button is pressed when the command dials are rotated, changes to shutter speed (exposure modes S and M) and aperture (exposure modes A and M) are made in increments of 1 EV, regardless of the option selected for Custom Setting b2 (EV steps for exposure cntrl, ☞ 321).</p>
 Choose non-CPU lens number	<p>Press the FN button and rotate a command dial to choose a lens number specified using the Non-CPU lens data option (☞ 235).</p>
 Active D-Lighting	<p>Press the FN button and rotate the command dials to adjust Active D-Lighting (☞ 188).</p>
 Shooting menu bank	<p>If this option is selected, the shooting menu bank can be selected by pressing the FN button and rotating a command dial.</p>
None	<p>No operation is performed when the command dials are rotated while the FN button is pressed.</p>



f4: Assign Preview Button

MENU button →  Custom Settings menu

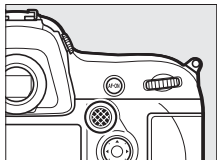
Choose the role played by the **Pv** button, either by itself (**Press**) or when used in combination with the command dials (**Press + command dials**). The options available are the same as for **Assign Fn button** (☐ 337). The default options for **Press** and **Press + command dials** are **Preview** and **None**, respectively.



f5: Assign Sub-selector

MENU button →  Custom Settings menu

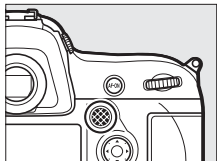
Choose whether the sub-selector is used for focus point selection (**Focus point selection**; ☐ 103) or performs the same role as the multi selector (**Same as multi selector**).



f6: Assign Sub-selector Center

MENU button →  Custom Settings menu

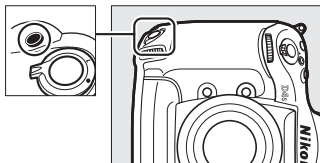
Choose the role played by the center of the sub-selector, either by itself (**Press**) or when used in combination with the command dials (**Press + command dials**). The options available are the same as for **Assign Fn button** (☐ 337), except that **Press** has additional **Select center focus point** and **Preset focus point** options that allow the center of the sub-selector to be used to select the center focus point or a preset focus point (☐ 335) and that **1 step spd/aperture** and **Active D-Lighting** are not available for **Press + command dials**. The default options for **Press** and **Press + command dials** are **AE/AF lock** and **None**, respectively.



f7: Assign Fn Button (Vert.)

MENU button →  Custom Settings menu

Choose the role played by the **Fn** button for vertical shooting, either by itself (**Press**) or when used in combination with the command dials (**Press + command dials**). The options available are the same as for



Assign Fn button (☐ 337), except that **AF-ON**, **Disable synchronized release**, and **Remote release only** are not available for **Press** and that **Press + command dials** has additional **ISO sensitivity**, **Exposure mode**, **Exposure compensation**, and **Metering** options that allow the **Fn** button for vertical shooting and command dials to be used to select ISO sensitivity (☐ 117), exposure mode (☐ 125), exposure compensation (☐ 138), or metering (☐ 123), respectively. The default options for **Press** and **Press + command dials** are respectively **AE/AF lock** and **None**.

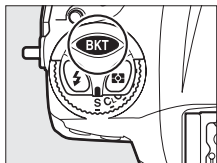
f8: Shutter Spd & Aperture Lock


MENU button →  Custom Settings menu

Selecting **On** for **Shutter speed lock** locks shutter speed at the value currently selected in mode **S** or **M**. Selecting **On** for **Aperture lock** locks aperture at the value currently selected in mode **A** or **M**. Shutter speed and aperture lock are not available in mode **P**.

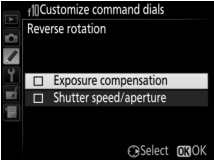
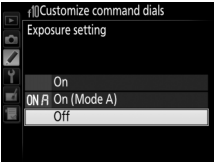


Choose the role played by the **BKT** button. If high dynamic range or multiple exposure is active while another function is assigned to the **BKT** button, the **BKT** button can not be used until high dynamic range or multiple exposure photography ends.



Option	Description
BKT Auto bracketing	Press the BKT button and rotate a command dial to choose the bracketing increment and number of shots in the bracketing sequence (📖 140).
 Multiple exposure	Press the BKT button and rotate a command dial to choose the mode and number of shots for multiple exposures (📖 216).
HDR HDR (high dynamic range)	Press the BKT button and rotate a command dial to choose the mode and the exposure differential (📖 194).
None	Pressing the button has no effect.

This option controls the operation of the main and sub-command dials.

Option	Description
Reverse rotation	<p>Reverse the direction of rotation of the command dials when they are used to make adjustments to Exposure compensation and/or Shutter speed/aperture. Highlight options and press ▶ to select or deselect, then press OK. This setting also applies to the command dials for vertical shooting.</p> 
Change main/sub	<p>Exposure setting: If Off is selected, the main command dial controls shutter speed and the sub-command dial controls aperture. If On is selected, the main command dial will control aperture and the sub-command dial shutter speed. If On (Mode A) is selected, the main command dial will be used to set aperture in exposure mode A only.</p> <p>Autofocus setting: If On is selected, autofocus mode can be selected by keeping the AF-mode button pressed and rotating the sub-command dial, AF-area mode by keeping the AF-mode button pressed and rotating the main command dial.</p> <p>These settings also apply to the command dials for vertical shooting.</p> 
Aperture setting	<p>If Sub-command dial is selected, aperture can only be adjusted with the sub-command dial (or with the main command dial if On is selected for Change main/sub). If Aperture ring is selected, aperture can only be adjusted with the lens aperture ring and the camera aperture display will show aperture in increments of 1 EV (aperture for type G and E lenses is still set using the sub-command dial). Note that regardless of the setting chosen, the aperture ring must be used to adjust aperture when a non-CPU lens is attached.</p>









Option	Description
Menus and playback	<p>If Off is selected, the multi selector is used to choose the picture displayed during full-frame playback, highlight thumbnails, and navigate menus. If On or On (image review excluded) is selected, the main command dial can be used to choose the picture displayed during full-frame playback, move the cursor left or right during thumbnail playback, and move the menu highlight bar up or down. The sub-command dial is used in full-frame playback to skip forward or back according to the option selected for Sub-dial frame advance and in thumbnail playback to page up or down. While menus are displayed, rotating the sub-command dial right displays the sub-menu for the selected option, while rotating it left displays the previous menu. To make a selection, press ►, the center of the multi selector, or ⊗. Select On (image review excluded) to prevent the command dials from being used for playback during image review.</p>
Sub-dial frame advance	<p>When On or On (image review excluded) is selected for Menus and playback, the sub-command dial can be rotated during full-frame playback to select a folder or to skip forward or back 10 or 50 frames at a time.</p>



f11: Release Button to Use Dial

MENU button →  Custom Settings menu

Selecting **Yes** allows adjustments that are normally made by holding the **MODE** ()^{FORMAT}, , **BKT**, , **ISO**, **QUAL**, **WB**, or AF-mode button and rotating a command dial to be made by rotating the command dial after the button is released (this also applies to the **Fn** and **Pv** buttons and the **Fn** button for vertical shooting, if they have been assigned **Active D-Lighting** using Custom Setting f3, **Assign Fn button**;  337, Custom Setting f4, **Assign preview button**;  342, or Custom Setting f7, **Assign Fn button (vert.)**;  343). Setting ends when any of the affected buttons is pressed again or the shutter-release button is pressed halfway. Except when **No limit** is selected for Custom Setting c2 **Standby timer**, setting will also end when the standby timer expires.



f12: Slot Empty Release Lock

MENU button →  Custom Settings menu

Selecting **Enable release** allows the shutter to be released when no memory card is inserted, although no pictures will be recorded (they will however be displayed in the monitor in demo mode). If **Release locked** is selected, the shutter-release button is only enabled when a memory card is inserted in the camera.



f13: Reverse Indicators

MENU button →  Custom Settings menu

If  (-0+) is selected, the exposure indicators in the top control panel and information display are displayed with negative values on the left and positive values on the right. Select  (+0-) to display positive values on the left and negative values on the right.














f14: Assign Multi Selector (Vert.) MENU button → Custom Settings menu


Choose whether the multi selector for vertical shooting is used for focus point selection (**Focus point selection**;  103) or performs the same role as the matching controls on the multi selector (**Same as multi selector**; note that in this case, you can select **Info◀▶/Playback▲▼** for **Photo info playback** to reverse the role of the buttons so that pressing the selector up or down displays additional images and pressing the selector left or right changes the photo information displayed). The role played by the center of the multi selector for vertical shooting when **Focus point selection** is chosen is that selected for Custom Setting f6 (**Assign sub-selector center**,  342) > **Press**.










f15: Playback Zoom MENU button → Custom Settings menu

Choose the controls used for playback zoom.



Option	Description
 Use  and 	Press  to zoom in,  to zoom out.
 Use  /  + 	Press either  or  and rotate the main command dial right to zoom in, left to zoom out. Pressing either button without rotating the command dial has no effect.

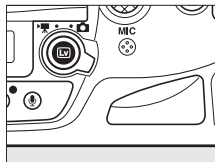
f16: Assign Movie Record Button MENU button → Custom Settings menu

Choose the role played by the movie-record button when  is selected with the live view selector.

Option	Description
 ISO sensitivity	Press the button and rotate a command dial to choose an ISO sensitivity ( 117).
 Choose image area	Press the button and rotate a command dial to choose from pre-selected image areas ( 85). Selecting Choose image area displays a list of image areas; highlight options and press  to select or deselect, then press  .
 Shooting menu bank	The shooting menu bank can be selected by pressing the button and rotating a command dial ( 300).
 Shutter spd & aperture lock	Press the button and rotate the main command dial to lock shutter speed in modes S and M ; press the button and rotate the sub-command dial to lock aperture in modes A and M . See page 134 for more information.
None	No operation is performed if the command dials are rotated while the button is pressed.

f17: Live View Button Options MENU button → Custom Settings menu

Select **Disable** to disable the  button, preventing live view from starting accidentally. If **Enable (standby timer active)** is selected, the  button can only be used to start live view while the standby timer is active.











f18: Assign Remote (WR) Fn Button

MENU button →  Custom Settings menu

Choose the role played by the **Fn** button on the wireless remote controller.



Option	Description
 Preview	During viewfinder photography, you can preview depth of field while the Fn button is pressed (📖 126). During live view photography, you can press the button once to open the lens to maximum aperture, making it easier to check focus; pressing the button again restores aperture to its original value (📖 54).
 FV lock	Press the Fn button to lock flash value (supported flash units only, 📖 196, 208). Press again to cancel FV lock.
 AE/AF lock	Focus and exposure lock while the Fn button is pressed.
 AE lock only	Exposure locks while the Fn button is pressed.
 AE lock (Reset on release)	Exposure locks when the Fn button is pressed, and remains locked until the button is pressed a second time, the shutter is released, or the standby timer expires.
 AF lock only	Focus locks while the Fn button is pressed.
 AF-ON	Pressing the Fn button initiates autofocus.
 Disable/enable	If the flash is currently off, front-curtain sync will be selected while the Fn button is pressed. If the flash is currently enabled, it will instead be disabled while the Fn button is pressed.

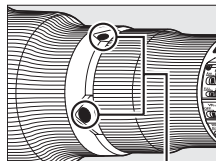


Option	Description
+RAW + NEF (RAW)	If image quality is set to JPEG fine , JPEG normal , or JPEG basic , “RAW” will be displayed in the rear control panel and an NEF (RAW) copy will be recorded with the next picture taken after the Fn button is pressed (the original image quality setting will be restored when you remove your finger from the shutter-release button). NEF (RAW) copies are recorded at the settings currently selected for NEF (RAW) recording in the shooting menu (☐ 92). To exit without recording an NEF (RAW) copy, press the Fn button again.
Lv Live view	Pressing the Fn button starts and ends live view.
None	Pressing the button has no effect.




f19: Lens Focus Function Buttons

MENU button →  Custom Settings menu




Choose the role played by the focus function buttons on the lens. The buttons can be used for the assigned function only when **AF-L** is selected with the focus function selector.



Focus function buttons

Option	Description
 AF lock only	Focus locks while a focus function button is pressed.
 AE/AF lock	Focus and exposure lock while a focus function button is pressed.
 AE lock only	Exposure locks while a focus function button is pressed.
PRE ^[Fn] Preset focus point	Keep a focus function button pressed to select a preset focus point (☐ 335). Release the button to restore the original focus point selection.




Option	Description
[12] AF-area mode	Highlight this option and press ► to select an AF-area mode (3D-tracking excluded; □ 100). The selected mode will take effect while a focus function button is pressed; releasing the button restores the original AF-area mode. The lens focus function buttons can not be used to choose the AF-area mode during autofocus if 3D-tracking is selected using the controls on the camera.
 Disable/enable	If the flash is currently off, front-curtain sync will be selected while a focus function button is pressed. If the flash is currently enabled, it will instead be disabled while a focus function button is pressed.
 Disable synchronized release	Keep any of the focus function buttons pressed to take photographs with the master camera only when using a wireless transmitter or wireless remote controller for remote synchronized release.
 Remote release only	Keep any of the focus function buttons pressed to take photographs with the remote cameras only when using a wireless transmitter or wireless remote controller for remote synchronized release.



g: Movie




g1: Assign Fn Button

MENU button →  Custom Settings menu

Choose the role played by the **Fn** button during movie live view.


■ ■ Press

Selecting **Press** displays the following options:

Option	Description
 Power aperture (open)	Aperture widens while the button is pressed. Use in combination with Custom Setting g2 (Assign preview button) > Press > Power aperture (close) for button-controlled aperture adjustment.
 Index marking	Press the button during movie recording to add an index at the current position (□ 66). Indices can be used when viewing and editing movies.
 View photo shooting info	Press the button to display information on shutter speed, aperture, and other photo settings in place of movie recording information. Press again to return to the movie recording display.
None	Pressing the button has no effect.

■ ■ Press + Command Dials

Selecting **Press + command dials** displays the following options:

Option	Description
 Choose image area	Press the button and rotate a command dial to select an image area for movie live view (□ 70).
None	No operation is performed when the command dials are rotated while the button is pressed.



Choose Image Area




When **Choose image area** is selected, the button can be used in combination with the command dials to cycle from FX-based movie format to DX-based movie format to a 1920×1080 crop (except when frame rates of 60p or 50p are selected, movies with a 1920×1080 crop will be shot at the frame rate chosen for **Movie settings > Frame size/frame rate**; when 60p or 50p is selected, movies with a 1920×1080 crop will be recorded at half the selected frame rate). The image area can not be changed during shooting.



Choose the role played by the **Pv** button during movie live view.

■ ■ Press


Selecting **Press** displays the following options:

Option	Description
 Power aperture (close)	Aperture narrows while the button is pressed. Use in combination with Custom Setting g1 (Assign Fn button) > Press > Power aperture (open) for button-controlled aperture adjustment.
 Index marking	Press the button during movie recording to add an index at the current position (□ 66). Indices can be used when viewing and editing movies.
 View photo shooting info	Press the button to display information on shutter speed, aperture, and other photo settings in place of movie recording information. Press again to return to the movie recording display.
None	Pressing the button has no effect.

■ ■ Press + Command Dials

Choose the role played by the **Pv** button when used in combination with the command dials. The options available are the same as for Custom Setting g1 (**Assign Fn button**) > **Press + command dials** (□ 353). The default option is **None**.

Power Aperture







Power aperture is available only in exposure modes **A** and **M** and can not be used during movie recording or while photo shooting info is displayed (a  icon indicates that power aperture can not be used). The display may flicker while aperture is adjusted.



Choose the role played by the center of the sub-selector during movie live view.


■ ■ Press







Selecting **Press** displays the following options:

Option	Description
 Index marking	Press the control during movie recording to add an index at the current position (📖 66). Indices can be used when viewing and editing movies.
 View photo shooting info	Press the control to display information on shutter speed, aperture, and other photo settings in place of movie recording information. Press again to return to the movie recording display.
 AE/AF lock	Focus and exposure lock while the control is pressed.
 AE lock only	Exposure locks while the control is pressed.
 AE lock (Hold)	Exposure locks when the control is pressed, and remains locked until the control is pressed a second time or the standby timer expires.
 AF lock only	Focus locks while the control is pressed.
None	Pressing the control has no effect.



■ ■ Press + Command Dials

Choose the role played by the center of the sub-selector when used in combination with the command dials. The options available are the same as for Custom Setting g1 (**Assign Fn button**) > **Press + command dials** (📖 353). The default option is **None**.

Choose the role played by pressing the shutter-release button when  is selected with the live view selector.

Option	Description
 Take photos	Press the shutter-release button all the way down to end movie recording and take a photograph with an aspect ratio that matches that of a movie frame (for information on image size, see page 70).
 Record movies	Press the shutter-release button halfway to start movie live view. You can then press the shutter-release button halfway to focus (autofocus mode only) and press it all the way down to start or end recording. To end movie live view, press the  button. The shutter-release button on an optional wireless remote controller or remote cord ( 411, 412) functions in the same way as the camera shutter-release button.
 Live frame grab	If the shutter-release button is pressed all the way down during movie recording, the camera will record a photograph without interrupting movie recording. Photos are recorded at an image quality of JPEG fine and the size selected for Movie settings > Frame size/frame rate in the shooting menu ( 74). Note that during movie recording, photos are taken one at a time regardless of the release mode selected; this restriction does not apply if movie recording is not currently in progress.

Record Movies

When this option is selected, interval timer photography ( 221) is not available and any functions assigned to the shutter-release button (such as taking photographs, measuring preset white balance, and taking image dust-off reference photos) can not be used when  is selected with the live view selector. Select **Take photos** or **Live frame grab** to use these options.



Y The Setup Menu: *Camera Setup*

To display the setup menu, press **MENU** and select the **Y** (setup menu) tab.

MENU button



Option	
Format memory card	359
Monitor brightness	359
Monitor color balance	360
Clean image sensor	417
Lock mirror up for cleaning*	420
Image Dust Off ref photo	361
Flicker reduction	363
Time zone and date	363
Language	364
Auto image rotation	364
Battery info	365
Image comment	366

Option	
Copyright information	367
IPTC	368
Voice memo options	261
Save/load settings	370
Virtual horizon	372
Non-CPU lens data	236
AF fine-tune	373
HDMI	286
Location data	240
Network	276
Firmware version	374

* Not available when battery is low.

See Also

Menu defaults are listed on page 437.

Network > Network Connection

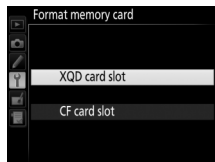
Firmware updates are not available when **Enable** is selected for **Network > Network connection**.



Format Memory Card

MENU button → setup menu

To begin formatting, choose a memory card slot and select **Yes**. *Note that formatting permanently deletes all pictures and other data on the card in the selected slot.* Before formatting, be sure to make backup copies as required.



During Formatting

Do not turn the camera off or remove memory cards during formatting.

Two-Button Format

Memory cards can also be formatted by pressing the (FORMAT) and MODE (FORMAT) buttons for more than two seconds (□ 35).

Monitor Brightness

MENU button → setup menu

Adjust the brightness of the monitor for playback, menus, and the information display.

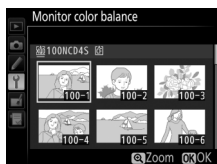
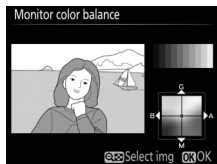
Option	Description
Auto	When the monitor is on, monitor brightness is automatically adjusted according to ambient lighting conditions. Care should be taken not to cover the ambient brightness sensor (□ 5).
Manual	Press ▲ or ▼ to choose monitor brightness. Choose higher values for increased brightness, lower values for reduced brightness.

See Also

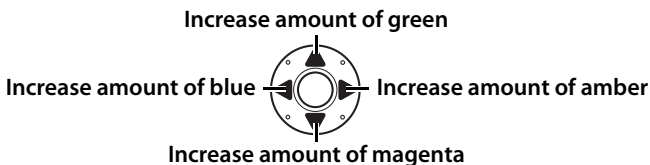
The option selected for **Monitor brightness** has no effect on the brightness of the display during live view photography or movie live view. For information on adjusting monitor brightness in live view, see page 57.



Use the multi selector as shown below to adjust monitor color balance with reference to a sample image. The sample image is the last photograph taken or, in playback mode, the last photograph displayed; to choose a different image, press the button and select an image from a thumbnail list (to view the highlighted image full frame, press and hold ; to view images in other locations, press and select the desired card and folder as described on page 242). If the




memory card contains no photographs, an empty frame with a gray border will be displayed in place of the sample image. Press to exit when adjustments are complete. Monitor color balance applies only to menus, playback, and the view through the lens displayed during live view photography and movie live view; pictures taken with the camera are not affected.

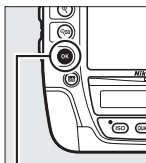


Acquire reference data for the Image Dust Off option in Capture NX 2 (available separately; for more information, see the Capture NX 2 manual).

Image Dust Off ref photo is available only when a CPU lens is mounted on the camera. A non-DX lens with a focal length of at least 50 mm is recommended. When using a zoom lens, zoom all the way in.

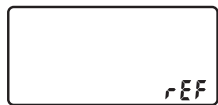
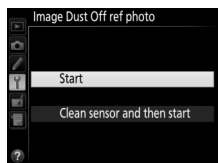
1 Choose a start option.

Highlight one of the following options and press . To exit without acquiring image dust off data, press MENU.



 button

- **Start:** The message shown at right will be displayed and “rEF” will appear in the viewfinder and control panel displays.
- **Clean sensor and then start:** Select this option to clean the image sensor before starting. The message shown at right will be displayed and “rEF” will appear in the viewfinder and control panel displays when cleaning is complete.



2 Frame a featureless white object in the viewfinder.

With the lens about ten centimeters (four inches) from a well-lit, featureless white object, frame the object so that it fills the viewfinder and then press the shutter-release button halfway.

In autofocus mode, focus will automatically be set to infinity; in manual focus mode, set focus to infinity manually.

3 Acquire dust off reference data.

Press the shutter-release button the rest of the way down to acquire Image Dust Off reference data. The monitor turns off when the shutter-release button is pressed. Note that noise reduction will be performed if the subject is poorly lit, increasing recording times.

If the reference object is too bright or too dark, the camera may be unable to acquire Image Dust Off reference data and the message shown at right will be displayed. Choose another reference object and repeat the process from Step 1.



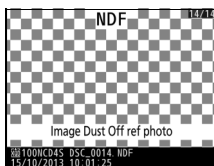
Image Sensor Cleaning

Dust off reference data recorded before image sensor cleaning is performed can not be used with photographs taken after image sensor cleaning is performed. Select **Clean sensor and then start** only if the dust off reference data will not be used with existing photographs.


Image Dust Off Reference Data

The same reference data can be used for photographs taken with different lenses or at different apertures. Reference images can not be viewed using computer imaging software.

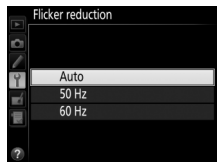
A grid pattern is displayed when reference images are viewed on the camera.



Flicker Reduction

MENU button →  setup menu


Reduce flicker and banding when shooting under fluorescent or mercury-vapor lighting during live view or movie recording. Choose **Auto** to allow the camera to automatically choose the correct frequency, or manually match the frequency to that of the local AC power supply.




Flicker Reduction

If **Auto** fails to produce the desired results and you are unsure as to the frequency of the local power supply, test both the 50 and 60 Hz options and choose the one that produces the best results. Flicker reduction may not produce the desired results if the subject is very bright, in which case you should try choosing a smaller aperture (higher f-number). To prevent flicker, select mode *M* and choose a shutter speed adapted to the frequency of the local power supply: $1/125$ s, $1/60$ s, or $1/30$ s for 60 Hz; $1/100$ s, $1/50$ s, or $1/25$ s for 50 Hz.

Time Zone and Date

MENU button →  setup menu

Change time zones, set the camera clock, choose the date display order, and turn daylight saving time on or off ( 30).



Option	Description
Time zone	Choose a time zone. The camera clock is automatically set to the time in the new time zone.
Date and time	Set the camera clock.
Date format	Choose the order in which the day, month, and year are displayed.
Daylight saving time	Turn daylight saving time on or off. The camera clock will automatically be advanced or set back one hour. The default setting is Off .

 flashes in the top control panel when the clock is not set.



Choose a language for camera menus and messages.

Auto Image Rotation

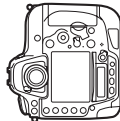
Photographs taken while **On** is selected contain information on camera orientation, allowing them to be rotated automatically during playback ( 296) or when viewed in ViewNX 2 (supplied) or in Capture NX 2 (available separately;  411). The following orientations are recorded:



Landscape (wide)
orientation




Camera rotated 90°
clockwise



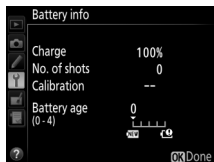
Camera rotated 90°
counter-clockwise

Camera orientation is not recorded when **Off** is selected. Choose this option when panning or taking photographs with the lens pointing up or down.

Rotate Tall

To automatically rotate “tall” (portrait-orientation) photographs for display during playback, select **On** for the **Rotate tall** option in the playback menu ( 296).

View information on the battery currently inserted in the camera.



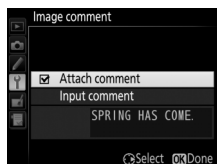
Item	Description
Charge	The current battery level expressed as a percentage.
No. of shots	The number of times the shutter has been released with the current battery since the battery was last charged. Note that the camera may sometimes release the shutter without recording a photograph, for example when measuring preset white balance.
Calibration	<ul style="list-style-type: none"> • CAL: Due to repeated use and recharging, calibration is required to ensure that battery level can be measured accurately; recalibrate battery before charging (☰ 459). • —: Calibration not required.
Battery age	A five-level display showing battery age. 0 () indicates that battery performance is unimpaired, 4 () that the battery has reached the end of its charging life and should be replaced. Note that fresh batteries charged at temperatures under about 5 °C (41 °F) may show a temporary drop in charging life; the battery age display will however return to normal once the battery has been recharged at a temperature of about 20 °C (68 °F) or higher.



Add a comment to new photographs as they are taken.

Comments can be viewed as metadata in ViewNX 2 (supplied) or Capture NX 2 (available separately; □ 411). The comment is also visible on the shooting data page in the photo information display (□ 250). The following options are available:

- **Input comment:** Input a comment as described on page 184. Comments can be up to 36 characters long.
- **Attach comment:** Select this option to attach the comment to all subsequent photographs. **Attach comment** can be turned on and off by highlighting it and pressing ►. After choosing the desired setting, press Ⓞ to exit.



Add copyright information to new photographs as they are taken. Copyright information is included in the shooting data shown in the photo information display (☐ 250) and can be viewed as metadata in ViewNX 2 (supplied) or in Capture NX 2 (available separately; ☐ 411). The following options are available:

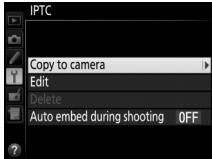

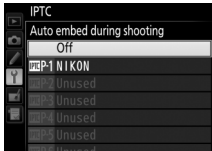
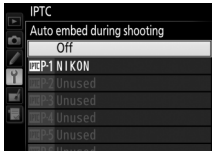
- **Artist:** Enter a photographer name as described on page 184. Photographer names can be up to 36 characters long.
- **Copyright:** Enter the name of the copyright holder as described on page 184. Copyright holder names can be up to 54 characters long.
- **Attach copyright information:** Select this option to attach copyright information to all subsequent photographs. **Attach copyright information** can be turned on and off by highlighting it and pressing ►. After choosing the desired setting, press **OK** to exit.



Copyright Information

To prevent unauthorized use of the artist or copyright holder names, make sure that **Attach copyright information** is not selected and that the **Artist** and **Copyright** fields are blank before lending or transferring the camera to another person. Nikon does not accept liability for any damages or disputes arising from the use of the **Copyright information** option.

The software needed to create IPTC presets and save them to a memory card can be downloaded using the supplied ViewNX 2 installer CD (Internet connection required) and installed on your computer (for more information, see the software's on-line help). The memory card can then be inserted in the camera's primary card slot and the options in the **IPTC** menu used to copy presets to the camera and embed them in new photographs as described below:

- Copy to camera:** Copy IPTC presets from the card in the primary card slot (□ 96) to a selected destination on the camera. The camera can store up to ten presets. To copy a preset, highlight it and press **OK**, then highlight a destination and press **OK** again (to preview the preset highlighted in the source list, press **▶**, then press **OK** after viewing the preset to proceed to the destination list).
 
- Edit:** Select a preset from the list of IPTC presets stored on the camera and choose **Rename** to rename the preset or **Edit IPTC information** to select fields and edit their contents as described on page 184.
 
- Delete:** Select a preset for deletion from the camera. A confirmation dialog will be displayed; highlight **Yes** and press **OK** to delete the selected preset.
 
- Auto embed during shooting:** Highlight the camera IPTC preset that will be embedded in all subsequent photographs and press **OK** (to disable embedding, select **Off**).
 

IPTC Information

IPTC is a standard established by the International Press Telecommunications Council (IPTC) with the intent of clarifying and simplifying the information required when photographs are shared with a variety of publications. The camera supports standard roman alphanumeric characters only; other characters will not display correctly except on a computer. Preset names (☐ 368) may be up to 18 characters long (if a longer name is created using a computer, all characters after the eighteenth will be deleted); the number of characters that may appear in each field is given below; any characters over the limit will not be displayed.

Field	Maximum length	Field	Maximum length
Caption	2000	Supplemental	256
Event ID	64	Categories	
Headline	256	(Supp. Cat.)	
Object name	256	Byline	256
City	256	Byline title	256
State	256	Writer/editor	256
Country	256	Credit	256
Category	3	Source	256



Select **Save settings** to save the following settings to the memory card, or to the memory card in the primary card slot if two memory cards are inserted (□ 96; if the card is full, an error will be displayed). Use this option to share settings among D4S cameras.

Menu	Option
Playback	Playback display options
	Image review
	After delete
	Rotate tall
Shooting (all banks)	Shooting menu bank
	Extended menu banks
	File naming
	Primary slot selection
	Secondary slot function
	Image quality
	JPEG/TIFF recording
	NEF (RAW) recording
	Image area
	White balance (with fine-tuning and presets d-1–d-6)
	Set Picture Control; note that Standard is used for Picture Controls other than the six preset Picture Controls supplied with the camera (Standard , Neutral , Vivid , Monochrome , Portrait , and Landscape)
	Color space
	Active D-Lighting
	Vignette control
	Auto distortion control
Long exposure NR	

Menu	Option
Shooting (all banks)	High ISO NR
	ISO sensitivity settings
	Live view photography
	Movie settings
Custom settings (all banks)	All Custom Settings
	Clean image sensor
	Flicker reduction
	Time zone and date (excepting date and time)
	Language
	Auto image rotation
	Image comment
	Copyright information
	IPTC
	Voice memo options
	Non-CPU lens data
	HDMI
	Location data
My Menu/ Recent Settings	All My Menu items
	All recent settings
	Choose tab

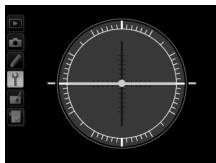
Settings saved using the D4S can be restored by selecting **Load settings**. Note that **Save/load settings** is only available when a memory card is inserted in the camera, and that the **Load settings** option is only available if the card contains saved settings.

Saved Settings

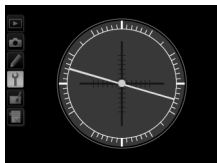
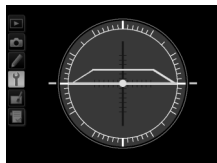
Settings are saved in a file named NCSETUPE. The camera will not be able to load settings if the file name is changed.



Display roll and pitch information based on information from the camera tilt sensor. If the camera is tilted neither left nor right, the roll reference line will turn green, while if the camera is tilted neither forward nor back, the dot in the center of the display will turn green. Each division is equivalent to 5°.




Camera level

Camera tilted left or
rightCamera tilted forward
or back

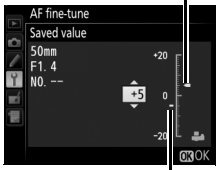


Tilting the Camera

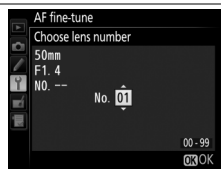
The virtual horizon display is not accurate when the camera is tilted at a sharp angle forward or back. If the camera is unable to measure tilt, the amount of tilt will not be displayed.

See Also

For information on viewing a virtual horizon display in the viewfinder, see Custom Setting f3 (**Assign Fn button > Press**;  337, 338). For information on displaying a virtual horizon in live view, see pages 58 and 69.

Fine-tune focus for up to 20 lens types. AF tuning is not recommended in most situations and may interfere with normal focus; use only when required.

Option	Description	
AF fine tune (On/Off)	<ul style="list-style-type: none"> • On: Turn AF tuning on. • Off: Turn AF tuning off. 	
Saved value	Tune AF for the current lens (CPU lenses only). Press ▲ or ▼ to choose a value between +20 and -20. Values for up to 20 lens types can be stored. Only one value can be stored for each type of lens.	Move focal point away from camera. Current value 
Default	Choose the AF tuning value used when no previously saved value exists for the current lens (CPU lenses only).	Move focal point toward camera. Previous value
List saved values	List previously saved AF tuning values. To delete a lens from the list, highlight the desired lens and press  (FORMAT). To change a lens identifier (for example, to choose an identifier that is the same as the last two digits of the lens serial number to distinguish it from other lenses of the same type in light of the fact that Saved value can be used with only one lens of each type), highlight the desired lens and press ►. The menu shown at right will be displayed; press ▲ or ▼ to choose an identifier and press  to save changes and exit.	



AF Tuning

The camera may be unable to focus at minimum range or at infinity when AF tuning is applied.


Live View

Tuning is not applied to autofocus during live view (📖 52).

Saved Value

Only one value can be stored for each type of lens. If a teleconverter is used, separate values can be stored for each combination of lens and teleconverter.


Firmware Version

MENU button →  setup menu

View the current camera firmware version.

















The Retouch Menu: Creating Retouched Copies




To display the retouch menu, press **MENU** and select the  (retouch menu) tab.

MENU button



The options in the retouch menu are used to create trimmed, or retouched copies of existing pictures. The retouch menu is only displayed when a memory card containing photographs other than small NEF (RAW) images is inserted in the camera.

Option		Option	
 D-Lighting	379	 NEF (RAW) processing	387
 Red-eye correction	380	 Resize	389
 Trim	381	 Straighten	391
 Monochrome	382	 Distortion control	392
 Filter effects	382	 Perspective control	393
 Color balance	383	 Edit movie	79
 Image overlay¹	384	 Side-by-side comparison²	394

- 1 Can only be selected by pressing **MENU** and selecting .
- 2 Can only be displayed by holding  and pressing  in full-frame playback when a retouched image or original is displayed.

Small NEF (RAW) + JPEG Images

If the JPEG copies of small NEF (RAW) images taken at image quality settings of NEF (RAW) + JPEG are recorded to the same memory card (□ 96), neither the NEF (RAW) images nor the JPEG copies can be edited.

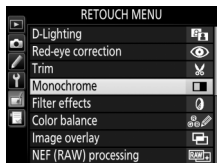


Creating Retouched Copies

To create a retouched copy:


1 Select an item in the retouch menu.

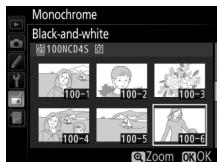
Press ▲ or ▼ to highlight an item, ► to select.




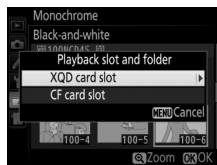
2 Select a picture.

Highlight a picture and press OK.

To view the highlighted picture full screen, press and hold the  button.



To view images in other locations, press  and select the desired card and folder as described on page 242.




Retouch

In the case of images recorded at image quality settings of NEF + JPEG, only the NEF (RAW) image will be retouched. The camera may not be able to display or retouch images created with other devices.



3 Select retouch options.

For more information, see the section for the selected item. To exit without creating a retouched copy, press **MENU**.

Monitor off Delay

The monitor will turn off and the operation will be cancelled if no actions are performed for a brief period. Any unsaved changes will be lost. To increase the time the monitor remains on, choose a longer menu display time for Custom Setting c4 (**Monitor off delay**,  325).

4 Create a retouched copy.

Press  to create a retouched copy. Retouched copies are indicated by a  icon.

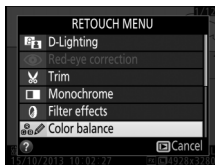


Creating Retouched Copies During Playback

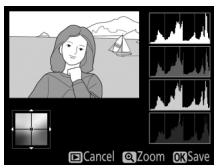
Retouched copies can also be created during playback.



Display picture full frame and hold **OK** and press **▶**.



Highlight an option and press **OK**.



Create retouched copy.

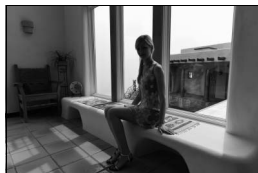
Retouching Copies

Most options can be applied to copies created using other retouch options, although (with the exceptions of **Image overlay** and **Edit movie > Choose start/end point**) each option can be applied only once (note that multiple edits may result in loss of detail). Options that can not be applied to the current image are grayed out and unavailable.

Image Quality

Except in the case of copies created with **Trim**, **Image overlay**, **NEF (RAW) processing**, and **Resize**, copies created from JPEG images are the same size and quality as the original, copies created from NEF (RAW) photos are saved as large fine-quality JPEG images, and copies created from TIFF (RGB) photos are saved as fine-quality JPEG images of the same size as the original. Size-priority compression is used when copies are saved in JPEG format.

D-Lighting brightens shadows, making it ideal for dark or backlit photographs.

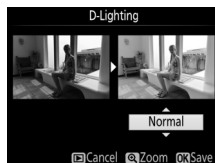


Before











After

Press ▲ or ▼ to choose the amount of correction performed. The effect can be previewed in the edit display. Press Ⓞ to copy the photograph.











This option is used to correct “red-eye” caused by the flash and is available only with photographs taken using a flash. The photograph selected for red-eye correction can be previewed in the edit display. Confirm the effects of red-eye correction and create a copy as described in the following table. Note that red-eye correction may not always produce the expected results and may in very rare circumstances be applied to portions of the image that are not affected by red-eye; check the preview thoroughly before proceeding.

To	Use	Description
Zoom in		Press  to zoom in,  to zoom out. While photo is zoomed in, use multi selector to view areas of image not visible in monitor. Keep multi selector pressed to scroll rapidly to other areas of frame.
Zoom out		
View other areas of image		Navigation window is displayed when zoom buttons or multi selector are pressed; area currently visible in monitor is indicated by yellow border. Press  to cancel zoom.
Cancel zoom		
Create copy		If the camera detects red-eye in the selected photograph, a copy will be created that has been processed to reduce its effects. No copy will be created if the camera is unable to detect red-eye.

Create a cropped copy of the selected photograph. The selected photograph is displayed with the selected crop shown in yellow; create a cropped copy as described in the following table.



To	Use	Description
Reduce size of crop		Press  to reduce the size of the crop.
Increase size of crop		Press  to increase the size of the crop.
Change crop aspect ratio		Rotate the main command dial to switch between aspect ratios of 3 : 2, 4 : 3, 5 : 4, 1 : 1, and 16 : 9.
Position crop		Use multi selector to position the crop. Press and hold to move the crop rapidly to the desired position.
Preview crop		Press center of multi selector to preview cropped image.
Create copy		Save the current crop as a separate file.

Trim: Image Quality and Size

Copies created from NEF (RAW), NEF (RAW) + JPEG, or TIFF (RGB) photos have an image quality (📖 90) of JPEG fine; cropped copies created from JPEG photos have the same image quality as the original. The size of the copy varies with crop size and aspect ratio and appears at upper left in the crop display.



Viewing Cropped Copies

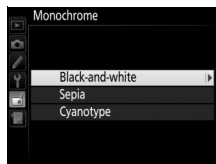
Playback zoom may not be available when cropped copies are displayed.



Monochrome

MENU button →  retouch menu

Copy photographs in **Black-and-white**, **Sepia**, or **Cyanotype** (blue and white monochrome).

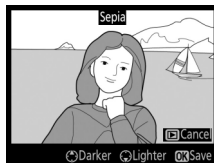


Selecting **Sepia** or **Cyanotype** displays a preview of the selected image; press ▲ to increase color saturation, ▼ to decrease. Press OK to create a monochrome copy.

Increase saturation




Decrease saturation




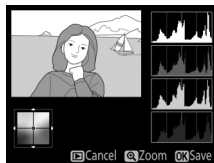
Filter Effects

MENU button →  retouch menu

Choose from the following color filter effects. After adjusting filter effects as described below, press OK to copy the photograph.

Option	Description
Skylight	Creates the effect of a skylight filter, making the picture less blue. The effect can be previewed in the monitor as shown at right. 
Warm filter	Creates a copy with warm tone filter effects, giving the copy a "warm" red cast. The effect can be previewed in the monitor.

Use the multi selector to create a copy with modified color balance as shown below. The effect is displayed in the monitor together with red, green, and blue histograms (📖 247) giving the distribution of tones in the copy. Press  to copy the photograph.



Increase amount of green



Zoom






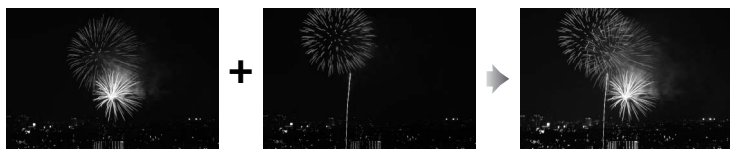
To zoom in on the image displayed in the monitor, press . The histogram will be updated to show data only for the portion of the image displayed in the monitor. While the image is zoomed in, press  (/?) to toggle back and forth between color balance and zoom. When zoom is selected, you can zoom in and out with the  and  buttons and scroll the image with the multi selector.

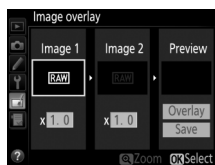


Image overlay combines two existing NEF (RAW) photographs to create a single picture that is saved separately from the originals; the results, which make use of RAW data from the camera image sensor, are noticeably better than photographs combined in an imaging application. The new picture is saved at current image quality and size settings; before creating an overlay, set image quality and size (☐ 90, 94; all options are available). To create a NEF (RAW) copy, choose an image quality of **NEF (RAW)** and an image size of **Large** (the overlay will be saved as a large NEF/RAW image even if **Small** is selected).




1 Select Image overlay.



Highlight **Image overlay** in the retouch menu and press ►. The dialog shown at right will be displayed, with **Image 1** highlighted; press OK to display a picture selection dialog listing only large NEF (RAW) images created with this camera (small NEF/RAW images can not be selected).




2 Select the first image.

Use the multi selector to highlight the first photograph in the overlay. To view the highlighted photograph full frame, press and hold the 





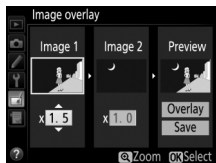
button. To view images in other locations, press  and select the desired card and folder as described on page 242. Press  to select the highlighted photograph and return to the preview display.

3 Select the second image.


The selected image will appear as **Image 1**. Highlight **Image 2** and press , then select the second photo as described in Step 2.

4 Adjust gain.

Highlight **Image 1** or **Image 2** and optimize exposure for the overlay by pressing  or  to select the gain from values between 0.1 and 2.0. Repeat for the second image. The default value is 1.0; select 0.5 to halve gain or 2.0 to double it. The effects of gain are visible in the **Preview** column.



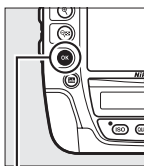
5 Preview the overlay.

Press ◀ or ▶ to place the cursor in the **Preview** column and press ▲ or ▼ to highlight **Overlay**. Press **OK** to preview the overlay as shown at right (to save the overlay without displaying a preview, select **Save**). To return to Step 4 and select new photos or adjust gain, press .



6 Save the overlay.

Press **OK** while the preview is displayed to save the overlay. After an overlay is created, the resulting image will be displayed full-frame in the monitor.



OK button



Image Overlay


Only NEF (RAW) photographs with the same image area and bit-depth can be combined.

The overlay has the same photo info (including date of recording, metering, shutter speed, aperture, exposure mode, exposure compensation, focal length, and image orientation) and values for white balance and Picture Control as the photograph selected for **Image 1**. The current image comment is appended to the overlay when it is saved; copyright information, however, are not copied. Overlays saved in NEF (RAW) format use the compression selected for **NEF (RAW) compression** in the **NEF (RAW) recording** menu and have the same bit depth as the original images; JPEG overlays are saved using size-priority compression.

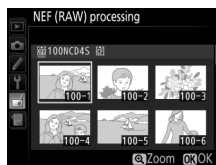


Create JPEG copies of NEF (RAW) photographs.




1 Select NEF (RAW) processing.

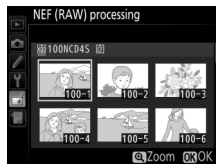
Highlight **NEF (RAW) processing** in the retouch menu and press  to display a picture selection dialog listing

only large NEF (RAW) images created with this camera. Small NEF/RAW images can not be selected; to create JPEG copies of small NEF (RAW) images, use the supplied ViewNX 2 software (□ 269) or the Capture NX 2 (available separately, □ 411).



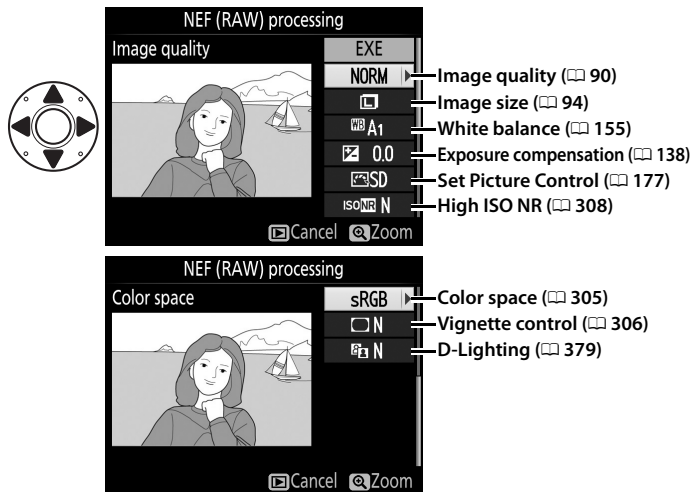
2 Select a photograph.

Highlight a photograph (to view the highlighted photograph full frame, press and hold the  button; to view images in other locations as described on page 242, press ). Press  to select the highlighted photograph and proceed to the next step.



3 Choose settings for the JPEG copy.

Adjust the settings listed below. Note that white balance and vignette control are not available with multiple exposures or pictures created with image overlay and that exposure compensation can only be set to values between -2 and $+2$ EV. The Picture Control grid is not displayed when Picture Controls are adjusted.



4 Copy the photograph.

Highlight **EXE** and press **OK** to create a JPEG copy of the selected photograph. To exit without copying the photograph, press the **MENU** button.



Create small copies of selected photographs.

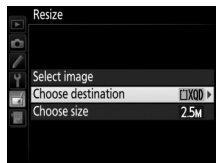
1 Select **Resize**.

To resize selected images, press **MENU** to display the menus and select **Resize** in the retouch menu.

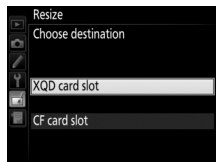


2 Choose a destination.

If two memory cards are inserted, you can choose a destination for the resized copies by highlighting **Choose destination** and pressing **▶** (if only one memory card is inserted, proceed to Step 3).

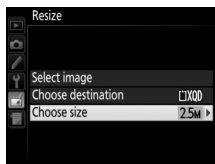


The menu shown at right will be displayed; highlight a card slot and press **OK**.

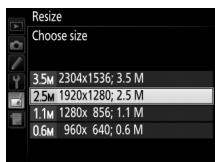


3 Choose a size.

Highlight **Choose size** and press **▶**.

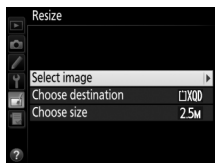


The options shown at right will be displayed; highlight an option and press **OK**.





4 Choose pictures.

Highlight **Select image** and press **▶**.



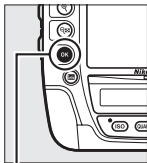
Highlight pictures and press the center of the multi selector to select or deselect (to view the highlighted picture full screen, press and hold the **Q** button; to view pictures in other locations



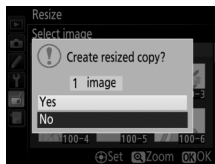
as described on page 242, press **Q**). Selected pictures are marked by a  icon. Press **OK** when the selection is complete. Note that photographs taken at an image-area setting of 5 : 4 () can not be resized.

5 Save the resized copies.

A confirmation dialog will be displayed. Highlight **Yes** and press **OK** to save the resized copies.



OK button



Viewing Resized Copies

Playback zoom may not be available when resized copies are displayed.

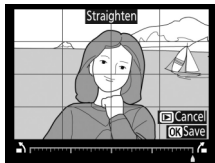
Image Quality

Copies created from NEF (RAW), NEF (RAW) + JPEG, or TIFF (RGB) photos have an image quality (📄 90) of JPEG fine; copies created from JPEG photos have the same image quality as the original.

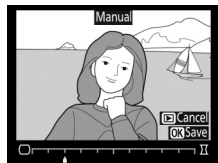
Straighten

MENU button →  retouch menu

Create a straightened copy of the selected image. Press **▶** to rotate the image clockwise by up to five degrees in increments of approximately 0.25 degrees, **◀** to rotate it counterclockwise (the effect can be previewed in the edit display; note that edges of the image will be trimmed to create a square copy). Press **OK** to copy the photograph, or press **▶** to exit to playback without creating a copy.



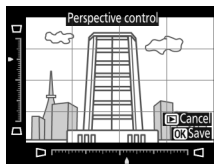
Create copies with reduced peripheral distortion. Select **Auto** to let the camera correct distortion automatically and then make fine adjustments using the multi selector, or select **Manual** to reduce distortion manually (note that **Auto** is not available with photos taken using auto distortion control; see page 307). Press **▶** to reduce barrel distortion, **◀** to reduce pincushion distortion (the effect can be previewed in the edit display; note that greater amounts of distortion control result in more of the edges being cropped out). Press **OK** to copy the photograph, or press **▶** to exit to playback without creating a copy. Note that distortion control may heavily crop or distort the edges of copies created from photographs taken with DX lenses at image areas other than **DX (24×16) 1.5x**.



Auto

Auto is for use only with pictures taken with type G, E, and D lenses (PC, fisheye, and certain other lenses excluded). Results are not guaranteed with other lenses.

Create copies that reduce the effects of perspective taken from the base of a tall object. Use the multi selector to adjust perspective (note that greater amounts of perspective control result in more of the edges being cropped out). The results can be previewed in the edit display. Press **OK** to copy the photograph, or press **▶** to exit to playback without creating a copy.





Before






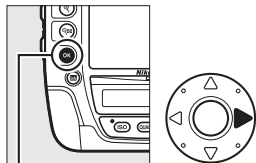
After

Side-by-Side Comparison

Compare retouched copies to the original photographs. This option is only available if the retouch menu is displayed by pressing the  and  buttons when a copy or original is displayed full frame.

1 Select a picture.


Select a retouched copy (shown by a  icon) or a photograph that has been retouched in full-frame playback and press the  and  buttons.



 button






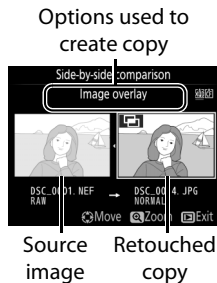
2 Select Side-by-side comparison.

Highlight **Side-by-side comparison** and press .





3 Compare the copy with the original.

The source image is displayed on the left, the retouched copy on the right, with the options used to create the copy listed at the top of the display. Press ◀ or ▶ to switch between the source image and the retouched copy. To view the highlighted picture full frame, press and hold the  button. If the copy was created from two source images using **Image overlay**, or if the source has been copied multiple times, press ▲ or ▼ to view the other source image. To exit to playback, press the  button, or press  to exit to playback with the highlighted image selected.




Side-by-Side Comparison

The source image will not be displayed if the copy was created from a photograph that was protected ( 255) or has since been deleted or hidden ( 290).




My Menu / Recent Settings

To display My Menu, press **MENU** and select the  (My Menu) tab.

MENU button



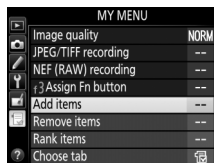
The **MY MENU** option can be used to create and edit a customized list of options from the playback, shooting, Custom Settings, setup, and retouch menus for quick access (up to 20 items). If desired, recent settings can be displayed in place of My Menu ( 400).

Options can be added, deleted, and reordered as described on the following pages.

■ Adding Options to My Menu

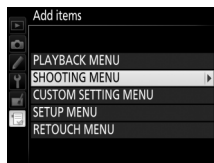
1 Select Add items.

In My Menu (☰), highlight **Add items** and press ►.



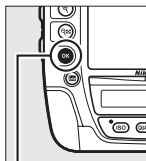
2 Select a menu.

Highlight the name of the menu containing the option you wish to add and press ►.



3 Select an item.

Highlight the desired menu item and press OK.

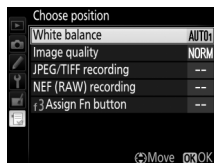


OK button



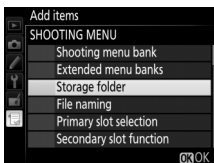
4 Position the new item.

Press ▲ or ▼ to move the new item up or down in My Menu. Press OK to add the new item.



5 Add more items.

The items currently displayed in My Menu are indicated by a check mark. Items indicated by a ☒ icon can not be selected. Repeat steps 1–4 to select additional items.



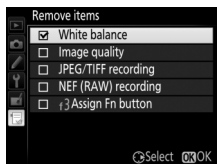
■ Deleting Options from My Menu

1 Select Remove items.

In My Menu (☰), highlight **Remove items** and press ►.

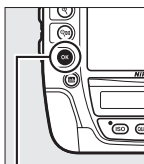
2 Select items.

Highlight items and press ► to select or deselect. Selected items are indicated by a check mark.

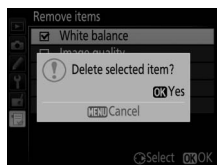


3 Delete the selected items.

Press **OK**. A confirmation dialog will be displayed; press **OK** again to delete the selected items.



OK button



Deleting Items in My Menu

To delete the item currently highlighted in My Menu, press the **FORMAT** button. A confirmation dialog will be displayed; press **FORMAT** again to remove the selected item from My Menu.

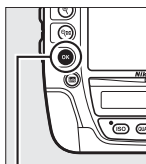
Reordering Options in My Menu

1 Select Rank items.

In My Menu (☰), highlight **Rank items** and press ►.

2 Select an item.

Highlight the item you wish to move and press OK.

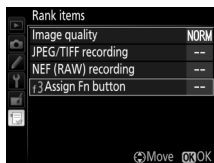


OK button



3 Position the item.

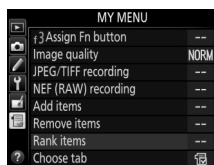
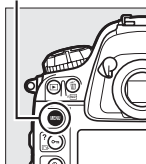
Press ▲ or ▼ to move the item up or down in My Menu and press OK. Repeat Steps 2–3 to reposition additional items.



4 Exit to My Menu.

Press the MENU button to return to My Menu.

MENU button





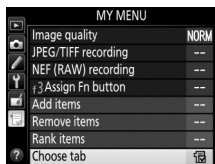
Recent Settings

To display the twenty most recently used settings, select

 **RECENT SETTINGS** for  **MY MENU** > **Choose tab**.

1 Select **Choose tab**.

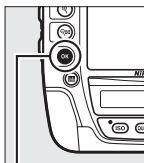
In My Menu () , highlight **Choose tab** and press .



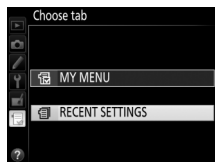
2 Select **RECENT SETTINGS**.



Highlight  **RECENT SETTINGS** and press .

The name of the menu will change from “MY MENU” to “RECENT SETTINGS.”





 **button**



Menu items will be added to the top of the recent settings menu as they are used. To view My Menu again, select  **MY MENU** for  **RECENT SETTINGS** > **Choose tab**.

Removing Items from the Recent Settings Menu

To remove an item from the recent settings menu, highlight it and press the  (**FORMAT**) button. A confirmation dialog will be displayed; press  (**FORMAT**) again to delete the selected item.



Technical Notes

Read this chapter for information on compatible accessories, cleaning and storing the camera, and what to do if an error message is displayed or you encounter problems using the camera.

Compatible Lenses

Camera setting Lens/accessory		Focus mode			Exposure mode		Metering system		
		AF	M (with electronic rangefinder)	M	P	A	☑		☑
					S	M	3D	Color	☐
CPU lenses ¹	Type G, E, or D AF NIKKOR ² AF-S, AF-I NIKKOR	✓	✓	✓	✓	✓	✓	—	✓ ³
	PC-E NIKKOR series	—	✓ ⁴	✓	✓ ⁴	✓ ⁴	✓ ⁴	—	✓ ^{3,4}
	PC Micro 85mm f/2.8D ⁵	—	✓ ⁴	✓	—	✓ ⁶	✓	—	✓ ^{3,4}
	AF-S / AF-I Teleconverter ⁷	✓	✓	✓	✓	✓	✓	—	✓ ³
	Other AF NIKKOR (except lenses for F3AF)	✓ ⁸	✓ ⁸	✓	✓	✓	—	✓	✓ ³
	AI-P NIKKOR	—	✓ ⁹	✓	✓	✓	—	✓	✓ ³
Non-CPU lenses ¹⁰	AI-, AI-modified NIKKOR or Nikon Series E lenses ¹¹	—	✓ ⁹	✓	—	✓ ¹²	—	✓ ¹³	✓ ¹⁴
	Medical-NIKKOR 120mm f/4	—	✓	✓	—	✓ ¹⁵	—	—	—
	Reflex-NIKKOR	—	—	✓	—	✓ ¹²	—	—	✓ ¹⁴
	PC-NIKKOR	—	✓ ⁴	✓	—	✓ ¹⁶	—	—	✓
	AI-type Teleconverter ¹⁷	—	✓ ¹⁸	✓	—	✓ ¹²	—	✓ ¹³	✓ ¹⁴
	PB-6 Bellows Focusing Attachment ¹⁹	—	✓ ¹⁸	✓	—	✓ ²⁰	—	—	✓
Auto extension rings (PK-series 11A, 12, or 13; PN-11)	—	✓ ¹⁸	✓	—	✓ ¹²	—	—	✓	

1 IX-NIKKOR lenses can not be used.

2 Vibration Reduction (VR) supported with VR lenses.

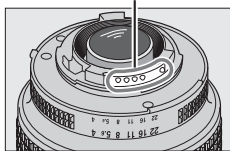
3 Spot metering meters selected focus point (☐ 123).

- 4 Can not be used with shifting or tilting.
 - 5 The camera's exposure metering and flash control systems do not work properly when shifting and/or tilting the lens, or when an aperture other than the maximum aperture is used.
 - 6 Manual exposure mode only.
 - 7 Can be used with AF-S and AF-I lenses only (□ 404). For information on the focus points available for autofocus and electronic rangefinding, see page 404.
 - 8 When focusing at minimum focus distance with AF 80–200mm f/2.8, AF 35–70mm f/2.8, AF 28–85mm f/3.5–4.5 <New>, or AF 28–85mm f/3.5–4.5 lens at maximum zoom, in-focus indicator may be displayed when image on matte screen in viewfinder is not in focus. Adjust focus manually until image in viewfinder is in focus.
 - 9 With maximum aperture of f/5.6 or faster.
 - 10 Some lenses can not be used (see page 405).
 - 11 Range of rotation for AI 80–200mm f/2.8 ED tripod mount is limited by camera body. Filters can not be exchanged while AI 200–400mm f/4 ED is mounted on camera.
 - 12 If maximum aperture is specified using **Non-CPU lens data** (□ 235), aperture value will be displayed in viewfinder and top control panel.
 - 13 Can be used only if lens focal length and maximum aperture are specified using **Non-CPU lens data** (□ 235). Use spot or center-weighted metering if desired results are not achieved.
 - 14 For improved precision, specify lens focal length and maximum aperture using **Non-CPU lens data** (□ 235).
 - 15 Can be used in manual exposure modes at shutter speeds slower than flash sync speed by one step or more.
 - 16 Exposure determined by presetting lens aperture. In aperture-priority auto exposure mode, preset aperture using lens aperture ring before performing AE lock and shifting lens. In manual exposure mode, preset aperture using lens aperture ring and determine exposure before shifting lens.
 - 17 Exposure compensation required when used with AI 28–85mm f/3.5–4.5, AI 35–105mm f/3.5–4.5, AI 35–135mm f/3.5–4.5, or AF-S 80–200mm f/2.8D.
 - 18 With maximum effective aperture of f/5.6 or faster.
 - 19 Requires PK-12 or PK-13 auto extension ring. PB-6D may be required depending on camera orientation.
 - 20 Use preset aperture. In aperture-priority auto exposure mode, set aperture using focusing attachment before determining exposure and taking photograph.
- PF-4 Reprocopy Outfit requires PA-4 Camera Holder.
 - Noise in the form of lines may appear during autofocus at high ISO sensitivities. Use manual focus or focus lock. Lines may also appear at high ISO sensitivities when aperture is adjusted during movie recording or live view photography.

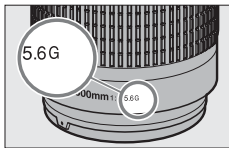
Recognizing CPU and Type G, E, and D Lenses

CPU lenses (particularly types G, E, and D) are recommended, but note that IX-NIKKOR lenses can not be used. CPU lenses can be identified by the presence of CPU contacts, type G, E, and D lenses by a letter on the lens barrel. Type G and E lenses are not equipped with a lens aperture ring.

CPU contacts

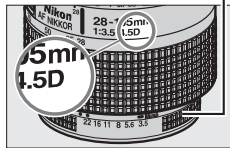


CPU lens



Type G/E lens

Aperture ring










Type D lens

Lens f-number

The f-number given in lens names is the maximum aperture of the lens.

The AF-S/AF-I Teleconverter

The table below shows the focus points available for autofocus and electronic rangefinding when an AF-S/AF-I teleconverter is attached. Note that the camera may be unable to focus on dark or low-contrast subjects if the combined aperture is slower than $f/5.6$. Autofocus is not available when teleconverters are used with the AF-S VR Micro-Nikkor 105mm $f/2.8G$ IF-ED.

Accessory	Maximum aperture of lens	Focus points	Accessory	Maximum aperture of lens	Focus points
TC-14E, TC-14E II	$f/4$ or faster		TC-20E, TC-20E II, TC-20E III	$f/2.8$ or faster	
	$f/5.6$	 1		$f/4$	 3
				$f/5.6$	— 2
TC-17E II	$f/2.8$ or faster		TC-800- 1.25E ED	$f/5.6$	 1
	$f/4$	 1			
	$f/5.6$	— 2			

- 1 Single point AF is used when 3D-tracking or auto-area AF is selected for AF-area mode (☞ 100).
- 2 Autofocus not available.
- 3 Focus data for focus points other than the center focus point are obtained from line sensors.

Compatible Non-CPU Lenses

Non-CPU lens data (☐ 235) can be used to enable many of the features available with CPU lenses, including color matrix metering; if no data are provided, center-weighted metering will be used in place of color matrix metering, while if the maximum aperture is not provided, the camera aperture display will show the number of stops from maximum aperture and the actual aperture value must be read off the lens aperture ring.


Incompatible Accessories and Non-CPU Lenses

The following can NOT be used with the D4S:

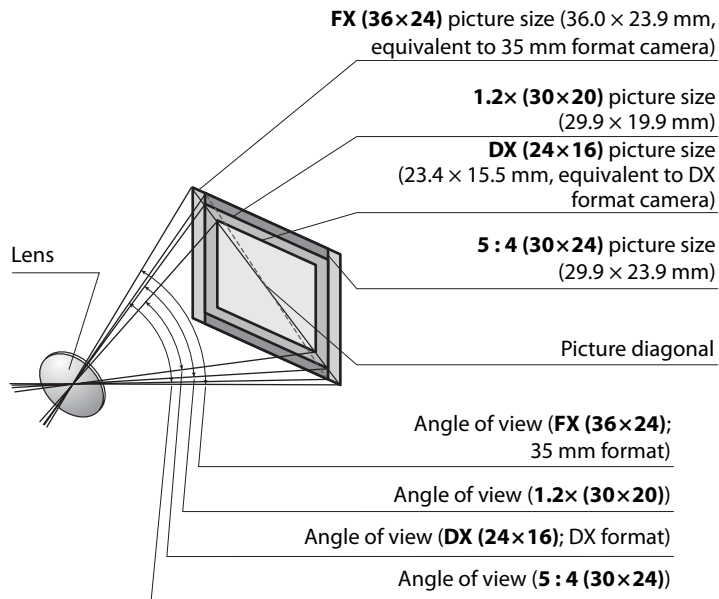
- TC-16A AF teleconverter
- Non-AI lenses
- Lenses that require the AU-1 focusing unit (400mm f/4.5, 600mm f/5.6, 800mm f/8, 1200mm f/11)
- Fisheye (6mm f/5.6, 7.5mm f/5.6, 8mm f/8, OP 10mm f/5.6)
- 2.1cm f/4
- Extension Ring K2
- 180–600mm f/8 ED (serial numbers 174041–174180)
- 360–1200mm f/11 ED (serial numbers 174031–174127)
- 200–600mm f/9.5 (serial numbers 280001–300490)
- AF lenses for the F3AF (AF 80mm f/2.8, AF 200mm f/3.5 ED, AF Teleconverter TC-16)
- PC 28mm f/4 (serial number 180900 or earlier)
- PC 35mm f/2.8 (serial numbers 851001–906200)
- PC 35mm f/3.5 (old type)
- Reflex 1000mm f/6.3 (old type)
- Reflex 1000mm f/11 (serial numbers 142361–143000)
- Reflex 2000mm f/11 (serial numbers 200111–200310)



Calculating Angle of View

The D4S can be used with Nikon lenses for 35 mm (135) format cameras. If **Auto DX crop** is on ( 86) and a 35 mm format lens is attached, the angle of view will be the same as a frame of 35 mm film (36.0 × 23.9 mm); if a DX lens is attached, the angle of view will automatically be adjusted to 23.4 × 15.5 mm (DX format).

To choose an angle of view different from that of the current lens, turn **Auto DX crop** off and select from **FX (36×24)**, **1.2× (30×20)**, **DX (24×16)**, and **5 : 4 (30×24)**. If a 35 mm format lens is attached, the angle of view could be reduced by 1.5 × by selecting **DX (24×16)** or by 1.2 × by selecting **1.2× (30×20)**, to expose a smaller area, or the aspect ratio could be changed by selecting **5 : 4 (30×24)**.



Calculating Angle of View (Continued)

The **DX (24×16)** angle of view is about 1.5 times smaller than the 35 mm format angle of view, while the **1.2× (30×20)** angle of view is about 1.2 times smaller and the **5 : 4 (30×24)** angle of view is about 1.1 times smaller. To calculate the focal length of lenses in 35 mm format when **DX (24×16)** is selected, multiply the focal length of the lens by about 1.5, by about 1.2 when is **1.2× (30×20)** selected, or by about 1.1 when **5 : 4 (30×24)** is selected (for example, the effective focal length of a 50mm lens in 35 mm format would be 75 mm when **DX (24×16)** is selected, 60 mm when **1.2× (30×20)** is selected, or 55 mm when **5 : 4 (30×24)** is selected).

Other Accessories


At the time of writing, the following accessories were available for the D4S.

Power sources	<ul style="list-style-type: none">• Rechargeable Li-ion Battery EN-EL18a (□ 21, 24): EN-EL18 batteries can also be used. Additional EN-EL18a batteries are available from local retailers and Nikon service representatives.• Battery Charger MH-26a (□ 21, 459): The MH-26a can be used to recharge and calibrate EN-EL18a and EN-EL18 batteries.• Power Connector EP-6, AC Adapter EH-6b: These accessories can be used to power the camera for extended periods (EH-6a and EH-6 AC adapters can also be used). The EP-6 is required to connect the EH-6b to the camera; see page 414 for details.
Filters	<ul style="list-style-type: none">• Filters intended for special-effects photography may interfere with autofocus or the electronic rangefinder.• The D4S can not be used with linear polarizing filters. Use the C-PL or C-PLII circular polarizing filter instead.• Use NC filters to protect the lens.• To prevent ghosting, use of a filter is not recommended when the subject is framed against a bright light, or when a bright light source is in the frame.• Center-weighted metering is recommended with filters with exposure factors (filter factors) over 1× (Y44, Y48, Y52, O56, R60, X0, X1, C-PL, ND2S, ND4, ND4S, ND8, ND8S, ND400, A2, A12, B2, B8, B12). See the filter manual for details.

LAN adapters
(📖 276)

- **Wireless Transmitter WT-4:** Connects the camera to wireless and Ethernet networks. The photographs on the camera memory card can be copied to a computer for long-term storage. The camera can also be controlled from any computer on the network using Camera Control Pro 2 (available separately).
- **Wireless Transmitter WT-5:** Connect the WT-5 to the camera's peripheral connector to upload pictures over a wireless network, to control the camera from a computer running Camera Control Pro 2 (available separately), or to take and browse pictures remotely from a computer or iPhone.
- **Communication Unit UT-1:** When connected to the camera using the USB cable supplied with the unit, the UT-1 can be used to connect to Ethernet networks (or, with a WT-5, to wireless networks) and upload pictures to an ftp server or control the camera remotely using optional Camera Control Pro 2 software.

Note: An Ethernet or wireless network and some basic network knowledge is required when using a communication unit or wireless transmitter. Be sure to upgrade the software supplied with the communication unit or wireless transmitter to the latest version.

Viewfinder eyepiece accessories	<ul style="list-style-type: none"> • Rubber Eyecup DK-19: The DK-19 makes the image in the viewfinder easier to see, preventing eye fatigue. • Dioptr-Adjustment Viewfinder Lens DK-17C: To accommodate individual differences in vision, viewfinder lenses are available with diopters of -3, -2, 0, $+1$, and $+2$ m⁻¹. Use diopter adjustment lenses only if the desired focus can not be achieved with the built-in diopter adjustment control (-3 to $+1$ m⁻¹). Test diopter adjustment lenses before purchase to ensure that the desired focus can be achieved. • Magnifying Eyepiece DK-17M: The DK-17M magnifies the view through the viewfinder by approximately $1.2 \times$ for greater precision when framing. • Eyepiece Magnifier DG-2: The DG-2 magnifies the scene at the center of the viewfinder for more accurate focus. DK-18 eyepiece adapter (available separately) required. • Eyepiece Adapter DK-18: The DK-18 is used when attaching the DG-2 magnifier or DR-3 right-angle viewing attachment to the D4S. • Antifog Finder Eyepiece DK-14/Antifog Finder Eyepiece DK-17A: These viewfinder eyepieces prevent fogging in humid or cold conditions. • Right-Angle Viewing Attachment DR-5/Right-Angle Viewing Attachment DR-4: The DR-5 and DR-4 attach to the viewfinder eyepiece at a right angle, allowing the image in the viewfinder to be viewed from above when the camera is in the horizontal shooting position. The DR-5 supports diopter adjustment and can also magnify the view through the viewfinder by $2 \times$ for greater precision when framing (note that the edges of the frame will not be visible when the view is magnified).
HDMI cables  285	HDMI Cable HC-E1: An HDMI cable with a type C connector for connection to the camera and a type A connector for connection to HDMI devices.
PC card adapters	PC Card Adapter EC-AD1: The EC-AD1 PC card adapter allows Type I CompactFlash memory cards to be inserted in PCMCIA card slots.



Software	<ul style="list-style-type: none"> • Capture NX 2: A complete photo editing package with such advanced editing features as selection control points and an auto retouch brush. • Camera Control Pro 2: Control the camera remotely from a computer and save photographs directly to the computer hard disk. When Camera Control Pro 2 is used to capture photographs directly to the computer, a PC connection indicator (P C) will appear in the top control panel. <p>Note: Use the latest versions of Nikon software; see the websites listed on page xx for the latest information on supported operating systems. At default settings, Nikon Message Center 2 will periodically check for updates to Nikon software and firmware while you are logged in to an account on the computer and the computer is connected to the Internet. A message is automatically displayed when an update is found.</p>
Body caps	<p>Body Cap BF-1B/Body Cap BF-1A: The body cap keeps the mirror, viewfinder screen, and low-pass filter free of dust when a lens is not in place.</p>
Wireless remote controllers	<ul style="list-style-type: none"> • Wireless Remote Controller WR-R10/WR-T10: When a WR-R10 wireless remote controller is attached to ten-pin remote terminal using a WR-A10 adapter, the camera can be controlled wirelessly using a WR-T10 wireless remote controller. • Wireless Remote Controller WR-1: WR-1 units are used with WR-R10 or WR-T10 wireless remote controllers or with other WR-1 remote controllers, with the WR-1 units functioning as either transmitters or receivers. For example, a WR-1 can be attached to the ten-pin remote terminal and used as a receiver, allowing the shutter to be released remotely by another WR-1 acting as a transmitter.

**Remote
terminal
accessories**

The D4S is equipped with a ten-pin remote terminal (□ 2) for remote control and automatic photography. The terminal is provided with a cap, which protects the contacts when the terminal is not in use. The following accessories can be used (all lengths are approximate):

- **Remote Cord MC-22/MC-22A:** Remote shutter release with blue, yellow, and black terminals for connection to a remote shutter-triggering device, allowing control via sound or electronic signals (length 1 m/3 ft 3 in.).
- **Remote Cord MC-30/MC-30A:** Remote shutter release; can be used to reduce camera shake (length 80 cm/2 ft 7 in.).
- **Remote Cord MC-36/MC-36A:** Remote shutter release; can be used for interval timer photography or to reduce camera shake or keep the shutter open during a time exposure (length 85 cm/2 ft 9 in.).
- **Extension Cord MC-21/MC-21A:** Can be connected to ML-3 or MC-series 20, 22, 22A, 23, 23A, 25, 25A, 30, 30A, 36, or 36A. Only one MC-21 or MC-21A can be used at a time (length 3 m/9 ft 10 in.).
- **Connecting Cord MC-23/MC-23A:** Connects two cameras with ten-pin remote terminals for simultaneous operation (length 40 cm/1 ft 4 in.).
- **Adapter Cord MC-25/MC-25A:** Ten-pin to two-pin adapter cord for connection to devices with two-pin terminals, including the MW-2 radio control set, MT-2 intervalometer, and ML-2 modulite control set (length 20 cm/8 in.).
- **WR Adapter WR-A10:** An adapter used to connect WR-R10 wireless remote controllers to cameras with ten-pin remote terminals.
- **GPS Unit GP-1/GP-1A** (□ 238): Record latitude, longitude, altitude, and UTC time with pictures.

Remote terminal accessories

- **GPS Adapter Cord MC-35** (☞ 238): This 35 cm (1 ft 2 in.) cable connects the camera to older GARMIN eTrex- and geko-series GPS units that conform to version 2.01 or 3.01 of the National Marine Electronics Association NMEA0183 data format. Only models that support PC interface cable connections are supported; the MC-35 can not be used to connect GPS units via USB. The units connect to the MC-35 using a cable with a D-sub 9-pin connector provided by the manufacturer of the GPS device; see the MC-35 instruction manual for details. Before turning the camera on, set the GPS device to NMEA mode (4800 baud); for more information, see the documentation provided with the GPS device.
- **Modulite Remote Control Set ML-3**: Allows infrared remote control at ranges of up to 8 m (26 ft 3 in.).

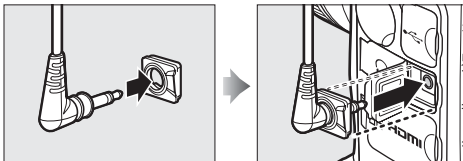
Microphones

Stereo Microphone ME-1: Connect the ME-1 to the camera microphone jack to record stereo sound while reducing the noise caused by lens vibration being recorded with movies during autofocus (☞ 75).

Availability may vary with country or region. See our website or brochures for the latest information.

 **The UF-2 Connector Cover for Stereo Mini-Plug Cables**

The camera comes with a UF-2 connector cover for the stereo mini-plug cable on the optional ME-1 stereo microphone (☞ i) that prevents the cable connecting the ME-1 to the camera being accidentally disconnected. The cover attaches as shown.



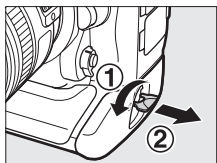
Attaching a Power Connector and AC Adapter

Adapter

Turn the camera off before attaching an optional power connector and AC adapter.

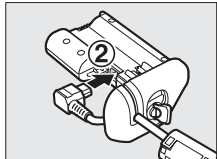
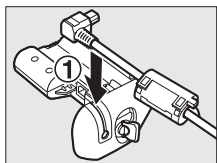
1 Remove the battery-chamber cover.

Lift the battery-chamber cover latch, turn it to the open (☞) position (①), and remove the BL-6 battery-chamber cover (②).



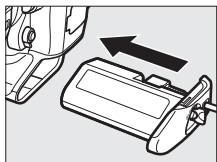
2 Connect the AC adapter.

Pass the DC cable over the power connector cable guide (①) and slide it down until it is at the bottom of the slot, and then insert the DC plug into the DC IN connector (②).



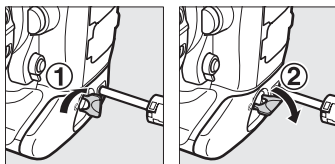
3 Insert the power connector.

Fully insert the power connector into the battery chamber as shown.



4 Latch the power connector.

Rotate the latch to the closed position (①) and fold it down as shown (②). To prevent the power connector being dislodged during operation, be sure that it is securely latched.



The battery level is not displayed in the top control panel while the camera is powered by the AC adapter and power connector.

Caring for the Camera

Storage

When the camera will not be used for an extended period, remove the battery and store it in a cool, dry area with the terminal cover in place. To prevent mold or mildew, store the camera in a dry, well-ventilated area. Do not store your camera with naphtha or camphor moth balls or in locations that:

- are poorly ventilated or subject to humidities of over 60%
- are next to equipment that produces strong electromagnetic fields, such as televisions or radios
- are exposed to temperatures above 50 °C (122 °F) or below -10 °C (14 °F)

Cleaning

Camera body	Use a blower to remove dust and lint, then wipe gently with a soft, dry cloth. After using the camera at the beach or seaside, wipe off sand or salt with a cloth lightly dampened in distilled water and dry thoroughly. Important: <i>Dust or other foreign matter inside the camera may cause damage not covered under warranty.</i>
Lens, mirror, and viewfinder	These glass elements are easily damaged. Remove dust and lint with a blower. If using an aerosol blower, keep the can vertical to prevent the discharge of liquid. To remove fingerprints and other stains, apply a small amount of lens cleaner to a soft cloth and clean with care.
Monitor	Remove dust and lint with a blower. When removing fingerprints and other stains, wipe the surface lightly with a soft cloth or chamois leather. Do not apply pressure, as this could result in damage or malfunction.

Do not use alcohol, thinner, or other volatile chemicals.

The Low-Pass Filter

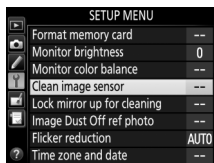
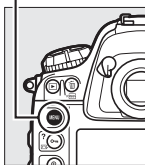
The image sensor that acts as the camera's picture element is fitted with a low-pass filter to prevent moiré. If you suspect that dirt or dust on the filter is appearing in photographs, you can clean the filter using the **Clean image sensor** option in the setup menu. The filter can be cleaned at any time using the **Clean now** option, or cleaning can be performed automatically when the camera is turned on or off.

■ "Clean Now"

1 Select **Clean image sensor** in the setup menu.

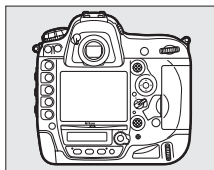
Press the **MENU** button to display the menus. Highlight **Clean image sensor** in the setup menu and press ►.

MENU button



🔧 Place the Camera Base Down

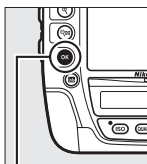
Image sensor cleaning is most effective when the camera is placed base down as shown at right.



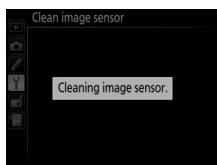
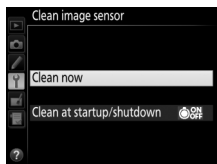
2 Select Clean now.

Highlight **Clean now** and press **OK**.

The camera will check the image sensor and then begin cleaning. During cleaning, **buSy** flashes in the top control panel and other operations can not be performed. Do not remove or disconnect the power source until cleaning is complete and **buSy** is no longer displayed.






OK button



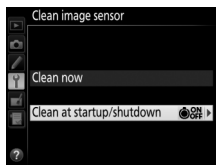
■ “Clean at Startup/Shutdown”

Choose from the following options:

Option	Description
 Clean at startup	The image sensor is automatically cleaned each time the camera is turned on.
 Clean at shutdown	The image sensor is automatically cleaned during shutdown each time the camera is turned off.
 Clean at startup & shutdown	The image sensor is cleaned automatically at startup and at shutdown.
Cleaning off	Automatic image sensor cleaning off.

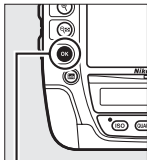
1 Select Clean at startup/ shutdown.

Display the **Clean image sensor** menu as described in Step 2 on the previous page. Highlight **Clean at startup/
shutdown** and press ►.

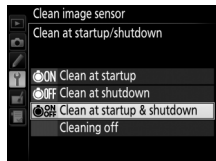


2 Select an option.

Highlight an option and press **OK**.



OK button



✓ Image Sensor Cleaning

Using camera controls during startup interrupts image sensor cleaning.

Cleaning is performed by vibrating the low-pass filter. If dust can not be fully removed using the options in the **Clean image sensor** menu, clean the image sensor manually or consult a Nikon-authorized service representative.


If image sensor cleaning is performed several times in succession, image sensor cleaning may be temporarily disabled to protect the camera's internal circuitry. Cleaning can be performed again after a short wait.



Manual Cleaning

If foreign matter can not be removed from the low-pass filter using the **Clean image sensor** (☞ 417) option in the setup menu, the filter can be cleaned manually as described below. Note, however, that the filter is extremely delicate and easily damaged. Nikon recommends that the filter be cleaned only by Nikon-authorized service personnel.

1 Charge the battery or connect an AC adapter.

A reliable power source is required when inspecting or cleaning the low-pass filter. Turn the camera off and insert a fully-charged battery or connect an optional AC adapter and power connector. The **Lock mirror up for cleaning** option is only available in the setup menu at battery levels over .

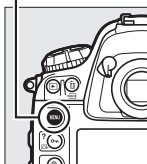
2 Remove the lens.

Turn the camera off and remove the lens.

3 Select Lock mirror up for cleaning.

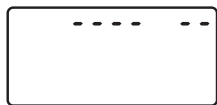
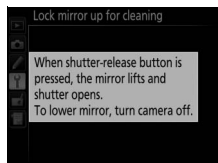
Turn the camera on and press the **MENU** button to display the menus. Highlight **Lock mirror up for cleaning** in the setup menu and press **▶**.

MENU button



4 Press .

The message shown at right will be displayed in the monitor and a row of dashes will appear in the top control panel and viewfinder. To restore normal operation without inspecting the low-pass filter, turn the camera off.



5 Raise the mirror.

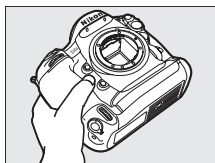
Press the shutter-release button all the way down.

The mirror will be raised and the shutter curtain will open, revealing the low-pass filter. The display in the viewfinder and rear control panel will turn off and the row of dashes in the top control panel will flash.



6 Examine the low-pass filter.

Holding the camera so that light falls on the low-pass filter, examine the filter for dust or lint. If no foreign objects are present, proceed to Step 8.



7 Clean the filter.

Remove any dust and lint from the filter with a blower. Do not use a blower-brush, as the bristles could damage the filter. Dirt that can not be removed with a blower can only be removed by Nikon-authorized service personnel. Under no circumstances should you touch or wipe the filter.



8 Turn the camera off.

The mirror will return to the down position and the shutter curtain will close. Replace the lens or body cap.

Use a Reliable Power Source

The shutter curtain is delicate and easily damaged. If the camera powers off while the mirror is raised, the curtain will close automatically. To prevent damage to the curtain, observe the following precautions:

- Do not turn the camera off or remove or disconnect the power source while the mirror is raised.
- If the battery runs low while the mirror is raised, a beep will sound and the self-timer lamp will flash to warn that the shutter curtain will close and the mirror will be lowered after about two minutes. End cleaning or inspection immediately.

✔ Foreign Matter on the Low-Pass Filter



Nikon takes every possible precaution to prevent foreign matter from coming into contact with the low-pass filter during production and shipping. The D4S, however, is designed to be used with interchangeable lenses, and foreign matter may enter the camera when lenses are removed or exchanged. Once inside the camera, this foreign matter may adhere to the low-pass filter, where it may appear in photographs taken under certain conditions. To protect the camera when no lens is in place, be sure to replace the body cap provided with the camera, being careful to first remove all dust and other foreign matter that may be adhering to the body cap. Avoid exchanging lenses in dusty environments.

Should foreign matter find its way onto the low-pass filter, clean the filter as described above, or have the filter cleaned by authorized Nikon service personnel. Photographs affected by the presence of foreign matter on the filter can be retouched using Capture NX 2 (available separately; ☐ 411) or the clean image options available in some third-party imaging applications.

✔ Servicing the Camera and Accessories

The camera is a precision device and requires regular servicing. Nikon recommends that the camera be inspected by the original retailer or Nikon service representative once every one to two years, and that it be serviced once every three to five years (note that fees apply to these services). Frequent inspection and servicing are particularly recommended if the camera is used professionally. Any accessories regularly used with the camera, such as lenses or optional flash units, should be included when the camera is inspected or serviced.

Replacing the Clock Battery

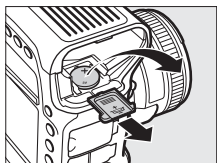
The camera clock is powered by a CR1616 lithium battery with a life of about two years. If the  icon is displayed in the top control panel while the standby timer is on, the battery is running low and needs to be replaced. When the battery is exhausted, the  icon will flash while the standby timer is on. Photographs can still be taken but will not be stamped with the correct time and date. Replace the battery as described below.

1 Remove the main battery.

The clock battery chamber is located on the roof of the main battery chamber. Turn the camera off and remove the EN-EL18a battery.

2 Open the clock battery chamber.

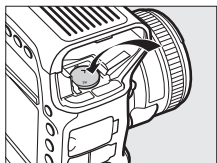
Slide the clock battery chamber cover toward the front of the main battery chamber.



3 Remove the clock battery.

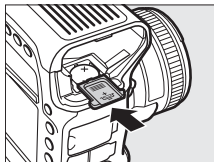
4 Insert the replacement battery.

Insert a new CR1616 lithium battery so that the positive side (the side marked with “+” and the battery name) is visible.



5 Close the clock battery chamber.

Slide the clock battery chamber cover towards the back of the main battery chamber until it clicks into place.

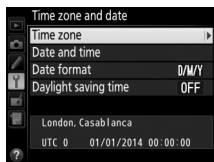


6 Replace the main battery.

Reinsert the EN-EL18a.

7 Set the camera clock.

Set the camera to the current date and time (📖 30). Until the date and time have been set, the **CLOCK** icon will flash in the top control panel.



CAUTION

Use only CR1616 lithium batteries. Using another type of battery could cause an explosion. Dispose of used batteries as directed.

Inserting the Clock Battery

Insert the clock battery in the correct orientation. Inserting the battery incorrectly could not only prevent the clock from functioning but could damage the camera.



Caring for the Camera and Battery: Cautions

Do not drop: The product may malfunction if subjected to strong shocks or vibration.

Keep dry: This product is not waterproof, and may malfunction if immersed in water or exposed to high levels of humidity. Rusting of the internal mechanism can cause irreparable damage.

Avoid sudden changes in temperature: Sudden changes in temperature, such as those that occur when entering or leaving a heated building on a cold day, can cause condensation inside the device. To prevent condensation, place the device in a carrying case or plastic bag before exposing it to sudden changes in temperature.

Keep away from strong magnetic fields: Do not use or store this device in the vicinity of equipment that generates strong electromagnetic radiation or magnetic fields. Strong static charges or the magnetic fields produced by equipment such as radio transmitters could interfere with the monitor, damage data stored on the memory card, or affect the product's internal circuitry.

Do not leave the lens pointed at the sun: Do not leave the lens pointed at the sun or other strong light source for an extended period. Intense light may cause the image sensor to deteriorate or produce a white blur effect in photographs.



Cleaning: When cleaning the camera body, use a blower to gently remove dust and lint, then wipe gently with a soft, dry cloth. After using the camera at the beach or seaside, wipe off any sand or salt using a cloth lightly dampened in pure water and then dry the camera thoroughly. In rare instances, static electricity may cause the LCD displays to light up or go dark. This does not indicate a malfunction, and the display will soon return to normal.

The lens and mirror are easily damaged. Dust and lint should be gently removed with a blower. When using an aerosol blower, keep the can vertical to prevent discharge of liquid. To remove fingerprints and other stains from the lens, apply a small amount of lens cleaner to a soft cloth and wipe the lens carefully.

See “The Low-Pass Filter” (📖 417) for information on cleaning the low-pass filter.

Lens contacts: Keep the lens contacts clean.

Do not touch the shutter curtain: The shutter curtain is extremely thin and easily damaged. Under no circumstances should you exert pressure on the curtain, poke it with cleaning tools, or subject it to powerful air currents from a blower. These actions could scratch, deform, or tear the curtain.

The shutter curtain may appear to be unevenly colored, but this has no affect on pictures and does not indicate a malfunction.

Storage: To prevent mold or mildew, store the camera in a dry, well-ventilated area. If you are using an AC adapter, unplug the adapter to prevent fire. If the product will not be used for an extended period, remove the battery to prevent leakage and store the camera in a plastic bag containing a desiccant. Do not, however, store the camera case in a plastic bag, as this may cause the material to deteriorate. Note that desiccant gradually loses its capacity to absorb moisture and should be replaced at regular intervals.

To prevent mold or mildew, take the camera out of storage at least once a month. Turn the camera on and release the shutter a few times before putting it away.

Store the battery in a cool, dry place. Replace the terminal cover before putting the battery away.



Turn the product off before removing or disconnecting the power source: Do not unplug the product or remove the battery while the product is on or while images are being recorded or deleted. Forcibly cutting power in these circumstances could result in loss of data or in damage to product memory or internal circuitry. To prevent an accidental interruption of power, avoid carrying the product from one location to another while the AC adapter is connected.

Dry the accessory shoe cover: If the camera is used in the rain, water may penetrate the supplied BS-2 accessory shoe cover. Remove and dry the accessory shoe cover after using the camera in the rain.

Notes on the monitor: The monitor is constructed with extremely high precision; at least 99.99% of pixels are effective, with no more than 0.01% being missing or defective. Hence while these displays may contain pixels that are always lit (white, red, blue, or green) or always off (black), this is not a malfunction and has no effect on images recorded with the device.

Images in the monitor may be difficult to see in a bright light.

Do not apply pressure to the monitor, as this could cause damage or malfunction. Dust or lint on the monitor can be removed with a blower. Stains can be removed by wiping lightly with a soft cloth or chamois leather. Should the monitor break, care should be taken to avoid injury from broken glass and to prevent liquid crystal from the monitor touching the skin or entering the eyes and mouth.

Batteries: Batteries may leak or explode if improperly handled. Observe the following precautions when handling batteries:

- Use only batteries approved for use in this equipment.
- Do not expose the battery to flame or excessive heat.
- Keep the battery terminals clean.
- Turn the product off before replacing the battery.
- Remove the battery from the camera or charger when not in use and replace the terminal cover. These devices draw minute amounts of charge even when off and could draw the battery down to the point that it will no longer function. If the battery will not be used for some time, insert it in the camera and run it flat before removing it from the camera for storage. The battery should be stored in a cool location with an ambient temperature of 15 °C to 25 °C (59 °F to 77 °F; avoid hot or extremely cold locations). Repeat this process at least once every six months.



- Turning the camera on or off repeatedly when the battery is fully discharged will shorten battery life. Batteries that have been fully discharged must be charged before use.
- The internal temperature of the battery may rise while the battery is in use. Attempting to charge the battery while the internal temperature is elevated will impair battery performance, and the battery may not charge or charge only partially. Wait for the battery to cool before charging.
- Continuing to charge the battery after it is fully charged can impair battery performance.
- A marked drop in the time a fully charged battery retains its charge when used at room temperature indicates that it requires replacement. Purchase a new EN-EL18a battery.
- Charge the battery before use. When taking photographs on important occasions, ready a spare battery and keep it fully charged. Depending on your location, it may be difficult to purchase replacement batteries on short notice. Note that on cold days, the capacity of batteries tends to decrease. Be sure the battery is fully charged before taking photographs outside in cold weather. Keep a spare battery in a warm place and exchange the two as necessary. Once warmed, a cold battery may recover some of its charge.
- Used batteries are a valuable resource; recycle in accord with local regulations.

Defaults

The default settings for the options in the camera menus are listed below. For information on two-button reset, see page 211.

■ Playback Menu Defaults

Option	Default
Playback folder (☐ 290)	NCD4S
Image review (☐ 295)	Off
After delete (☐ 296)	Show next
Rotate tall (☐ 296)	On
Slide show (☐ 297)	
Image type (☐ 297)	Still images and movies
Frame interval (☐ 297)	2 s
Audio playback (☐ 298)	On

■ Shooting Menu Defaults ¹

Option	Default
Extended menu banks (☐ 301)	Off
File naming (☐ 304)	DSC
Primary slot selection (☐ 96)	XQD card slot
Secondary slot function (☐ 96)	Overflow
Image quality (☐ 90)	JPEG normal
JPEG/TIFF recording (☐ 304)	
Image size (☐ 94)	Large
JPEG compression (☐ 92)	Size priority
NEF (RAW) recording (☐ 304)	
Image size (☐ 95)	Large
NEF (RAW) compression (☐ 92)	Lossless compressed
NEF (RAW) bit depth (☐ 92)	14-bit
Image area (☐ 85)	
Choose image area (☐ 86)	FX (36×24)
Auto DX crop (☐ 86)	On

Option	Default
White balance (☞ 155)	Auto > Normal
Fine-tuning (☞ 158)	A-B: 0, G-M: 0
Choose color temp. (☞ 161)	5000 K
Preset manual (☞ 164)	d-1
Set Picture Control (☞ 177)	Standard
Color space (☞ 305)	sRGB
Active D-Lighting (☞ 188)	Off
HDR (high dynamic range) (☞ 190)	
HDR mode (☞ 191)	Off
Exposure differential (☞ 192)	Auto
Smoothing (☞ 192)	Normal
Vignette control (☞ 306)	Normal
Auto distortion control (☞ 307)	Off
Long exposure NR (☞ 308)	Off
High ISO NR (☞ 308)	Normal
ISO sensitivity settings (☞ 117)	
ISO sensitivity (☞ 117)	100
Auto ISO sensitivity control (☞ 119)	Off
Multiple exposure (☞ 214) ²	
Multiple exposure mode (☞ 215)	Off
Number of shots (☞ 216)	2
Auto gain (☞ 217)	On
Interval timer shooting (☞ 221)	Off
Start options (☞ 222)	Now
Interval (☞ 222)	0
No. of intervals×shots/interval (☞ 223)	0001×1
Exposure smoothing (☞ 223)	Off
Live view photography (☞ 60)	Quiet
Time-lapse photography (☞ 229)	Off
Interval (☞ 230)	5 s
Shooting time (☞ 230)	25 minutes
Exposure smoothing (☞ 230)	On

Option	Default
Movie settings (☞ 74)	
Frame size/frame rate (☞ 74)	1920 × 1080; 60p
Movie quality (☞ 74)	High quality
Microphone sensitivity (☞ 75)	Auto sensitivity
Frequency response (☞ 75)	Wide range
Wind noise reduction (☞ 75)	Off
Destination (☞ 75)	XQD card slot
Movie ISO sensitivity settings (☞ 76)	ISO sensitivity (mode M): 200 Auto ISO control (mode M): Off Maximum sensitivity: 25600




- 1 Default settings can be restored using **Shooting menu bank** (☞ 301). With the exceptions of **Extended menu banks**, **Multiple exposure**, **Interval timer shooting**, and **Time-lapse photography**, only settings in the current shooting menu bank will be reset.
- 2 Applies to all banks. Shooting menu reset is not available while shooting is in progress.

■ Custom Settings Menu Defaults *

Option		Default
a1	AF-C priority selection (☞ 313)	Release
a2	AF-S priority selection (☞ 314)	Focus
a3	Focus tracking with lock-on (☞ 314)	3 (Normal)
a4	AF activation (☞ 315)	Shutter/AF-ON
a5	Focus point illumination (☞ 315)	
	Manual focus mode	On
	Continuous mode	On
	Focus point brightness	Normal
	Dynamic-area AF display	Off
	Group-area AF illumination	☒ (Squares)
a6	Focus point wrap-around (☞ 316)	No wrap
a7	Number of focus points (☞ 316)	51 points
a8	Assign AF-ON button (☞ 317)	AF-ON
a9	Assign AF-ON button (vert.) (☞ 318)	AF-ON
a10	Store by orientation (☞ 319)	Off
a12	Autofocus mode restrictions (☞ 320)	No restrictions
b1	ISO sensitivity step value (☞ 321)	1/3 step
b2	EV steps for exposure cntrl (☞ 321)	1/3 step
b3	Exp./flash comp. step value (☞ 321)	1/3 step
b4	Easy exposure compensation (☞ 322)	Off
b5	Matrix metering (☞ 323)	Face detection on
b6	Center-weighted area (☞ 323)	∅ 12 mm
b7	Fine-tune optimal exposure (☞ 323)	
	Matrix metering	0
	Center-weighted metering	0
	Spot metering	0
c1	Shutter-release button AE-L (☞ 324)	Off
c2	Standby timer (☞ 324)	6 s
c3	Self-timer (☞ 325)	
	Self-timer delay	10 s
	Number of shots	1
	Interval between shots	0.5 s

	Option	Default
c4	Monitor off delay (☞ 325)	
	Playback	10 s
	Menus	1 min
	Information display	10 s
	Image review	4 s
d1	Live view	10 min
	Beep (☞ 326)	
	Volume	Off
	Pitch	Low
d2	Continuous shooting speed (☞ 326)	
	Continuous high-speed	11 fps
	Continuous low-speed	5 fps
d3	Max. continuous release (☞ 327)	200
d4	Exposure delay mode (☞ 327)	Off
d5	File number sequence (☞ 328)	On
d6	Viewfinder grid display (☞ 329)	Off
d7	Control panel/viewfinder (☞ 329)	
	Rear control panel	ISO sensitivity
	Viewfinder display	Frame count
d8	Screen tips (☞ 329)	On
d9	Information display (☞ 330)	Auto
d10	LCD illumination (☞ 330)	Off
e1	Flash sync speed (☞ 331)	1/250 s
e2	Flash shutter speed (☞ 332)	1/60 s
e3	Optional flash (☞ 332)	TTL
e4	Exposure comp. for flash (☞ 333)	Entire frame
e5	Modeling flash (☞ 333)	On
e6	Auto bracketing set (☞ 333)	AE & flash
e7	Auto bracketing (mode M) (☞ 334)	Flash/speed
e8	Bracketing order (☞ 334)	MTR > under > over

	Option	Default
f1	Multi selector center button (☐ 335)	
	Shooting mode (☐ 335)	Select center focus point
	Playback mode (☐ 336)	Thumbnail on/off
	Live view (☐ 336)	Select center focus point
f2	Multi selector (☐ 336)	Do nothing
f3	Assign Fn button (☐ 337)	
	Press (☐ 337)	None
	Press + command dials (☐ 341)	Choose image area
f4	Assign preview button (☐ 342)	
	Press	Preview
	Press + command dials	None
f5	Assign sub-selector (☐ 342)	Focus point selection
f6	Assign sub-selector center (☐ 342)	
	Press	AE/AF lock
	Press + command dials	None
f7	Assign Fn button (vert.) (☐ 343)	
	Press	AE/AF lock
	Press + command dials	None
f8	Shutter spd & aperture lock (☐ 343)	
	Shutter speed lock	Off
	Aperture lock	Off
f9	Assign BKT button (☐ 344)	Auto bracketing
f10	Customize command dials	
	Reverse rotation (☐ 345)	Exposure compensation: ☐ Shutter speed/aperture: ☐
	Change main/sub (☐ 345)	Exposure setting: Off Autofocus setting: Off
	Aperture setting (☐ 345)	Sub-command dial
	Menus and playback (☐ 346)	Off
	Sub-dial frame advance (☐ 346)	10 frames

Option		Default
f11	Release button to use dial (📖 347)	No
f12	Slot empty release lock (📖 347)	Enable release
f13	Reverse indicators (📖 347)	
f14	Assign multi selector (vert.) (📖 348)	Same as multi selector
f15	Playback zoom (📖 348)	Use  and 
f16	Assign movie record button (📖 349)	
	Press + command dials	None
f17	Live view button options (📖 349)	Enable
f18	Assign remote (WR) Fn button (📖 350)	None
f19	Lens focus function buttons (📖 351)	AF lock only
g1	Assign Fn button (📖 353)	
	Press	None
	Press + command dials	None
g2	Assign preview button (📖 355)	
	Press	Index marking
	Press + command dials	None
g3	Assign sub-selector center (📖 356)	
	Press	AE/AF lock
	Press + command dials	None
g4	Assign shutter button (📖 357)	Take photos

* Defaults for the current Custom Settings bank can be restored using **Custom settings bank** (📖 311).

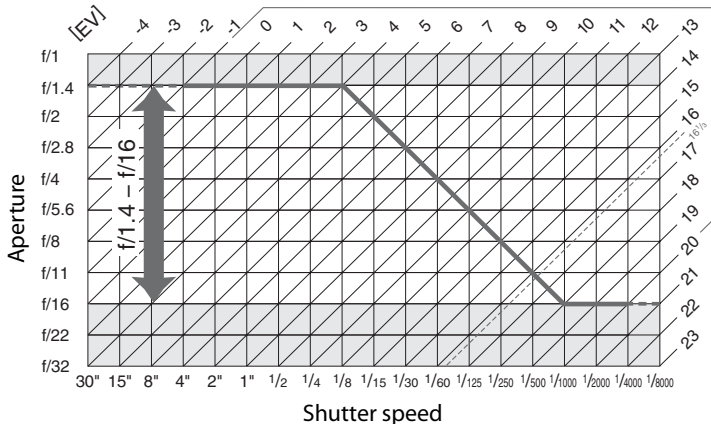
■ ■ Setup Menu Defaults

Option	Default
Monitor brightness (☞ 359)	Manual
Manual	0
Monitor color balance (☞ 360)	A-B: 0, G-M: 0
Clean image sensor (☞ 417)	
Clean at startup/shutdown (☞ 418)	Clean at startup & shutdown
Flicker reduction (☞ 363)	Auto
Time zone and date (☞ 363)	
Daylight saving time	Off
Auto image rotation (☞ 364)	On
Voice memo options	
Voice memo (☞ 261)	Off
Voice memo overwrite (☞ 262)	Disable
Voice memo button (☞ 262)	Press and hold
Audio output (☞ 267)	Speaker/headphones
HDMI (☞ 286)	
Output resolution	Auto
Advanced	
Output range	Auto
Output display size	100%
Live view on-screen display	On
Dual monitor	On
Location data (☞ 240)	
Standby timer	Enable
Set clock from satellite	Yes

Exposure Program

The exposure program for programmed auto (☞ 127) is shown in the following graph:

— ISO 100; lens with maximum aperture of f/1.4 and minimum aperture of f/16 (e.g., AF-S NIKKOR 50mm f/1.4G)



The maximum and minimum values for EV vary with ISO sensitivity; the above graph assumes an ISO sensitivity of ISO 100 equivalent. When matrix metering is used, values over $16 \frac{1}{3}$ EV are reduced to $16 \frac{1}{3}$ EV.

Troubleshooting

If the camera fails to function as expected, check the list of common problems below before consulting your retailer or Nikon-authorized service representative.

Battery/Display

The camera is on but does not respond: Wait for recording to end. If the problem persists, turn the camera off. If the camera does not turn off, remove and reinsert the battery or, if you are using an AC adapter, disconnect and reconnect the AC adapter. Note that although any data currently being recorded will be lost, data that have already been recorded will not be affected by removing or disconnecting the power source.

Viewfinder is out of focus: Adjust viewfinder focus or use optional diopter adjustment lenses (☐ 38, 410).

Viewfinder is dark: Insert a fully-charged battery (☐ 21, 40).

Displays turn off without warning: Choose longer delays for Custom Setting c2 (**Standby timer**) or c4 (**Monitor off delay**) (☐ 324, 325).

Displays in control panels or viewfinder are unresponsive and dim: The response times and brightness of these displays vary with temperature.


Shooting

Camera takes time to turn on: Delete files or folders.

Shutter-release disabled:



- Memory card is full (☐ 32, 41).
- **Release locked** is selected for Custom Setting f12 (**Slot empty release lock**; ☐ 347) and no memory card is inserted (☐ 32).
- Aperture ring for CPU lens not locked at highest f-number (does not apply to type G and E lenses). If **fE E** is displayed in the top control panel, select **Aperture ring** for Custom Setting f10 (**Customize command dials**) > **Aperture setting** to use lens aperture ring to adjust aperture (☐ 345).
- Exposure mode **S** selected with **b** or **l** or **b** or **-** selected for shutter speed (☐ 445).





Camera is slow to respond to shutter-release button: Select **Off** for Custom Setting d4 (**Exposure delay mode**;  327).

Only one shot taken each time shutter-release button is pressed in continuous release mode: Turn HDR off ( 190).






Photos are out of focus:

- Rotate focus-mode selector to **AF** ( 97).
- Camera unable to focus using autofocus: use manual focus or focus lock ( 105, 108).

Full range of shutter speeds not available: Flash in use. Flash sync speed can be selected using Custom Setting e1 (**Flash sync speed**); when using compatible flash units, choose **1/250 s (Auto FP)** for full range of shutter speeds ( 331).

Focus does not lock when shutter-release button is pressed halfway: Camera is in focus mode **AF-C**: use the center of the sub-selector to lock focus ( 105).

Can not select focus point:

- Unlock focus selector lock ( 103).
 - Auto-area or face-priority AF selected for AF-area mode; choose another mode ( 53, 100).
 - Camera is in playback mode ( 241).
 - Menus are in use ( 289).
 - Press shutter-release button halfway to start standby timer ( 44).
-

Can not select AF mode:

- Rotate focus-mode selector to **AF** ( 97).
 - Select **No restrictions** for Custom Setting a12 (**Autofocus mode restrictions**,  320).
-





Can not select AF-area mode: Rotate focus-mode selector to **AF** ( 97).

Image size can not be changed: Image quality set to NEF (RAW) ( 90). Choose image size using **NEF (RAW) recording > Image size** option in shooting menu.

Camera is slow to record photos: Turn long exposure noise reduction off ( 308).

Flicker or banding appears during live view or movie recording: Choose an option for **Flicker reduction** that matches the frequency of the local AC power supply ( 363).

Bright bands appear during live view or movie recording: A flashing sign, flash, or other light source with brief duration was used during live view or movie recording.

Noise (bright spots, randomly-spaced bright pixels, fog, lines, or reddish areas) appears in photos:

- To reduce randomly-spaced bright pixels, fog, or lines, choose lower ISO sensitivity or use high ISO noise reduction (☞ 117, 308).
- To reduce bright spots, randomly-spaced bright pixels, or fog at shutter speeds slower than 1 s or to reduce reddish areas and other artifacts in long time-exposures, enable long exposure noise reduction (☞ 308).
- Turn **Active D-Lighting** off to avoid heightening the effects of noise (☞ 188).

Smudges appear in photographs: Clean front and rear lens elements. If problem persists, perform image sensor cleaning (☞ 417).

Colors are unnatural:

- Adjust white balance to match light source (☞ 155).
- Adjust **Set Picture Control** settings (☞ 177).

Can not measure white balance: Subject is too dark or too bright (☞ 165).

Image can not be selected as source for preset white balance: Image was not created with D4S (☞ 172).

White balance bracketing unavailable:

- NEF (RAW) or NEF+JPEG image quality option selected for image quality (☞ 90).
- Multiple exposure mode is in effect (☞ 214).

Photographs and movies do not appear to have the same exposure as the preview shown in the monitor during live view: Changes to monitor brightness during live view photography and movie live view have no effect on images recorded with the camera (☞ 57).

Effects of Picture Control differ from image to image: A (auto) is selected for sharpening, contrast, or saturation. For consistent results over a series of photographs, choose another setting (☞ 181).

Metering can not be changed: Autoexposure lock is in effect (☞ 137).

Exposure compensation can not be used: Choose exposure mode **P**, **S**, or **A** (☞ 125, 139).

Sound is not recorded with movies: Microphone off is selected for **Movie settings > Microphone sensitivity** (☞ 75).

Playback

NEF (RAW) image is not played back: Photo was taken at image quality of NEF + JPEG (☞ 91).

Can not view pictures recorded with other cameras: Pictures recorded with other makes of camera may not be displayed correctly.

Some photos are not displayed during playback: Select **All** for **Playback folder** (☞ 290).

“Tall” (portrait) orientation photos are displayed in “wide” (landscape) orientation:

- Select **On** for **Rotate tall** (☞ 296).
 - Photo was taken with **Off** selected for **Auto image rotation** (☞ 364).
 - Photo is displayed in image review (☞ 295).
 - Camera was pointed up or down when photo was taken (☞ 364).
-

Can not delete photo: Picture is protected. Remove protection (☞ 255).

Can not retouch picture: Photo can not be further edited with this camera (☞ 376).

Message is displayed stating that no images are available for playback: Select **All** for **Playback folder** (☞ 290).

Can not change print order: Memory card is full: delete photos (☞ 41, 257).

Can not print photos: NEF (RAW) and TIFF photos can not be printed by direct USB connection. Transfer photos to computer and print using ViewNX 2 (supplied) or Capture NX 2 (available separately; ☞ 411). NEF (RAW) photos can be saved in JPEG format using **NEF (RAW) processing** (☞ 387).

Photo is not displayed on high-definition video device: Confirm that HDMI cable (available separately) is connected (☞ 285).

Photos are not displayed in Capture NX 2: Update to the latest version (☞ 411).

Image Dust Off option in Capture NX 2 does not have desired effect: Image sensor cleaning changes the position of dust on the low-pass filter. Dust off reference data recorded before image sensor cleaning is performed can not be used with photographs taken after image sensor cleaning is performed. Dust off reference data recorded after image sensor cleaning is performed can not be used with photographs taken before image sensor cleaning is performed (☞ 362).

Computer displays NEF (RAW) images differently from camera: Third-party software does not display effects of Picture Controls, Active D-Lighting, or vignette control. Use ViewNX 2 (supplied) or optional Nikon software such as Capture NX 2 (available separately).

Can not transfer photos to computer: OS not compatible with camera or transfer software. Use card reader to copy photos to computer (☞ 271).

Miscellaneous

Date of recording is not correct: Set camera clock (☞ 30).




Menu item can not be selected: Some options are not available at certain combinations of settings or when no memory card is inserted. Note that **Battery info** option is not available when camera is powered by an optional power connector and AC adapter (☞ 365).

Error Messages

This section lists the indicators and error messages that appear in the viewfinder, top control panel, and monitor.



Indicator		Problem	Solution	📖
Control panel	Viewfinder			
fE E (flashes)		Lens aperture ring is not set to minimum aperture.	Set ring to minimum aperture (highest f-number).	28
		Low battery.	Ready a fully-charged spare battery.	40
(flashes)	(flashes)	<ul style="list-style-type: none"> Battery exhausted. Battery can not be used. An extremely exhausted rechargeable Li-ion battery or a third-party battery is inserted in the camera. High battery temperature. 	<ul style="list-style-type: none"> Recharge or replace battery. Contact Nikon-authorized service representative. Replace the battery, or recharge the battery if the rechargeable Li-ion battery is exhausted. Remove battery and wait for it to cool. 	xix, 21, 24, 408 —
(flashes)	—	Camera clock is not set.	Set camera clock.	30
ΔF		No lens attached, or non-CPU lens attached without specifying maximum aperture. Aperture shown in stops from maximum aperture.	Aperture value will be displayed if maximum aperture is specified.	235

Indicator		Problem	Solution	📖
Control panel	View-finder			
—	▶ ◀ (flashes)	Camera unable to focus using autofocus.	Change composition or focus manually.	43, 108
(Exposure indicators and shutter speed or aperture display flash)		Subject too bright; photo will be overexposed.	• Use a lower ISO sensitivity.	117
			• Use optional ND filter.	408
			In exposure mode: S Increase shutter speed	128
			A Choose a smaller aperture (higher f-number)	129
		Subject too dark; photo will be underexposed.	• Use a higher ISO sensitivity.	117
			• Use optional flash. In exposure mode:	195
			S Lower shutter speed	128
			A Choose a larger aperture (lower f-number)	129
bulb (flashes)		bulb selected in exposure mode S.	Change shutter speed or select manual exposure mode.	128, 130
-- (flashes)		-- selected in exposure mode S.	Change shutter speed or select manual exposure mode.	128, 130
busy (flashes)	busy (flashes)	Processing in progress.	Wait until processing is complete.	—
—	⚡ (flashes)	If indicator flashes for 3s after flash fires, photo may be underexposed.	Check photo in monitor; if underexposed, adjust settings and try again.	199


Indicator		Problem	Solution	
Control panel	View-finder			
 (flashes)	—	Flash unit that does not support red-eye reduction attached and flash sync mode set to red-eye reduction.	Change flash sync mode or use flash unit that supports red-eye reduction.	197, 204
Full  (flashes)	Full (flashes)	Memory insufficient to record further photos at current settings, or camera has run out of file or folder numbers.	<ul style="list-style-type: none"> • Reduce quality or size. • Delete photographs after copying important images to computer or other device. • Insert new memory card. 	90, 94 257, 269 32
Err (flashes)		Camera malfunction.	Release shutter. If error persists or appears frequently, consult Nikon-authorized service representative.	—

 **The XQD and CF Icons**

These icons flash to show the card affected.

Indicator		Problem	Solution	
Monitor	Control panel			
No memory card.	[- E -]	Camera cannot detect memory card.	Turn camera off and confirm that card is correctly inserted.	32
This memory card cannot be used. Card may be damaged. Insert another card.	[Err], [Err]  (flashes)	<ul style="list-style-type: none"> • Error accessing memory card. • Unable to create new folder. 	<ul style="list-style-type: none"> • Use Nikon-approved card. • Check that contacts are clean. If card is damaged, contact retailer or Nikon-authorized service representative. • Delete files or insert new memory card after copying important images to computer or other device. 	462 — 32, 257, 269
This card is not formatted. Format the card.	[For] (flashes)	Memory card has not been formatted for use in camera.	Format memory card or insert new memory card.	32, 35
Failed to update flash unit firmware. Flash cannot be used. Contact a Nikon-authorized service representative.	—	Firmware for flash unit mounted on camera was not updated correctly.	Contact a Nikon-authorized service representative.	—

Indicator		Problem	Solution	📖
Monitor	Control panel			
Unable to start live view. Please wait.	—	The internal temperature of the camera is high.	Wait for the internal circuits to cool before resuming live view or movie recording.	62, 73
Folder contains no images.	—	No images on memory card or in folder(s) selected for playback.	Select folder containing images from Playback folder menu or insert memory card containing images.	32, 290
All images are hidden.	—	All photos in current folder are hidden.	No images can be played back until another folder has been selected or Hide image used to allow at least one image to be displayed.	290
Cannot display this file.	—	File has been created or modified using a computer or different make of camera, or file is corrupt.	File can not be played back on camera.	—
Cannot select this file.	—	Selected image can not be retouched.	Images created with other devices can not be retouched.	376
Check printer.	—	Printer error.	Check printer. To resume, select Continue (if available).	280*

Indicator		Problem	Solution	
Monitor	Control panel			
Check paper.	—	Paper in printer is not of selected size.	Insert paper of correct size and select Continue.	280 *
Paper jam.	—	Paper is jammed in printer.	Clear jam and select Continue.	280 *
Out of paper.	—	Printer is out of paper.	Insert paper of selected size and select Continue.	280 *
Check ink supply.	—	Ink error.	Check ink. To resume, select Continue.	280 *
Out of ink.	—	Printer is out of ink.	Replace ink and select Continue.	280 *

* See printer manual for more information.

Specifications

■ Nikon D4S Digital Camera

Type	
Type	Single-lens reflex digital camera
Lens mount	Nikon F mount (with AF coupling and AF contacts)
Effective angle of view	Nikon FX format
Effective pixels	
Effective pixels	16.2 million
Image sensor	
Image sensor	36.0 × 23.9 mm CMOS sensor
Total pixels	16.6 million
Dust-reduction System	Image sensor cleaning, Image Dust Off reference data (optional Capture NX 2 software required)
Storage	
Image size (pixels)	<ul style="list-style-type: none">• FX (36×24) image area 4928×3280 (L) 3696×2456 (M) 2464×1640 (S)• 1.2× (30×20) image area 4096×2720 (L) 3072×2040 (M) 2048×1360 (S)• DX (24×16) image area 3200×2128 (L) 2400×1592 (M) 1600×1064 (S)• 5 : 4 (30×24) image area 4096×3280 (L) 3072×2456 (M) 2048×1640 (S)• FX-format photographs taken in movie live view (16:9) 4928×2768 (L) 3696×2072 (M) 2464×1384 (S)• DX-format photographs taken in movie live view (16:9) 3200×1792 (L) 2400×1344 (M) 1600×896 (S)• FX-format photographs taken in movie live view (3:2) 4928×3280 (L) 3696×2456 (M) 2464×1640 (S)• DX-format photographs taken in movie live view (3:2) 3200×2128 (L) 2400×1592 (M) 1600×1064 (S) <p>Note: A DX-based format is used for photographs taken using the DX (24 × 16) 1.5× image area; an FX-based format is used for all other photographs.</p>



Storage	
File format	<ul style="list-style-type: none"> • NEF (RAW): 12 or 14 bit, lossless compressed, compressed, or uncompressed; small size available (12-bit uncompressed only) • TIFF (RGB) • JPEG: JPEG-Baseline compliant with fine (approx. 1 : 4), normal (approx. 1 : 8), or basic (approx. 1 : 16) compression (Size priority); Optimal quality compression available • NEF (RAW)+JPEG: Single photograph recorded in both NEF (RAW) and JPEG formats
Picture Control System	Standard, Neutral, Vivid, Monochrome, Portrait, Landscape; selected Picture Control can be modified; storage for custom Picture Controls
Media	XQD and Type I CompactFlash memory cards (UDMA compliant)
Dual card slots	Either card can be used for primary or backup storage or for separate storage of NEF (RAW) and JPEG images; pictures can be copied between cards.
File system	DCF 2.0, DPOF, Exif 2.3, PictBridge

Viewfinder	
Viewfinder	Eye-level pentaprism single-lens reflex viewfinder
Frame coverage	<ul style="list-style-type: none"> • FX (36×24): Approx. 100% horizontal and 100% vertical • 1.2× (30×20): Approx. 97% horizontal and 97% vertical • DX (24×16): Approx. 97% horizontal and 97% vertical • 5:4 (30×24): Approx. 97% horizontal and 100% vertical
Magnification	Approx. $0.7 \times$ (50 mm f/1.4 lens at infinity, -1.0 m^{-1})
Eye point	18 mm (-1.0 m^{-1} ; from center surface of viewfinder eyepiece lens)
Diopter adjustment	-3 – $+1 \text{ m}^{-1}$
Focusing screen	Type B BriteView Clear Matte Mark VIII screen with AF area brackets (framing grid can be displayed)



Viewfinder	
Reflex mirror	Quick return
Depth-of-field preview	Pressing Pv button stops lens aperture down to value selected by user (A and M modes) or by camera (P and S modes)
Lens aperture	Instant return, electronically controlled

Lens	
Compatible lenses	<p>Compatible with AF NIKKOR lenses, including type G, E, and D lenses (some restrictions apply to PC lenses) and DX lenses (using DX 24 × 16 1.5× image area), AI-P NIKKOR lenses, and non-CPU AI lenses (exposure modes A and M only). IX NIKKOR lenses, lenses for the F3AF, and non-AI lenses can not be used.</p> <p>The electronic rangefinder can be used with lenses that have a maximum aperture of f/5.6 or faster (the electronic rangefinder supports the 11 focus points with lenses that have a maximum aperture of f/8 or faster).</p>

Shutter	
Type	Electronically-controlled vertical-travel focal-plane shutter
Speed	$1/8000$ – 30 s in steps of $1/3$, $1/2$, or 1 EV, bulb, time, X250
Flash sync speed	$X = 1/250$ s; synchronizes with shutter at $1/250$ s or slower

Release	
Release mode	S (single frame), CL (continuous low speed), CH (continuous high speed), Q (quiet shutter-release), ⌚ (self-timer), MUP (mirror up)
Approximate frame advance rate	Up to 10 fps (CL) or 10–11 fps (CH)
Self-timer	2 s, 5 s, 10 s, 20 s; 1–9 exposures at intervals of 0.5, 1, 2, or 3 s

Exposure	
Metering	TTL exposure metering using RGB sensor with approximately 91K (91,000) pixels
Metering method	<ul style="list-style-type: none"> • Matrix: 3D color matrix metering III (type G, E, and D lenses); color matrix metering III (other CPU lenses); color matrix metering available with non-CPU lenses if user provides lens data • Center-weighted: Weight of 75% given to 12 mm circle in center of frame. Diameter of circle can be changed to 8, 15, or 20 mm, or weighting can be based on average of entire frame (non-CPU lenses use 12-mm circle) • Spot: Meters 4 mm circle (about 1.5% of frame) centered on selected focus point (on center focus point when non-CPU lens is used)
Range (ISO 100, f/1.4 lens, 20 °C/68 °F)	<ul style="list-style-type: none"> • Matrix or center-weighted metering: -1 – +20 EV • Spot metering: 2 – 20 EV
Exposure meter coupling	Combined CPU and AI
Exposure mode	Programmed auto with flexible program (P); shutter-priority auto (S); aperture-priority auto (A); manual (M)
Exposure compensation	-5 – +5 EV in increments of $\frac{1}{3}$, $\frac{1}{2}$, or 1 EV
Exposure bracketing	2–9 frames in steps of $\frac{1}{3}$, $\frac{1}{2}$, $\frac{2}{3}$, or 1 EV; 2–5 frames in steps of 2 or 3 EV
Flash bracketing	2–9 frames in steps of $\frac{1}{3}$, $\frac{1}{2}$, $\frac{2}{3}$, or 1 EV; 2–5 frames in steps of 2 or 3 EV
White balance bracketing	2–9 frames in steps of 1, 2, or 3
ADL bracketing	2 frames using selected value for one frame or 3–5 frames using preset values for all frames
Exposure lock	Luminosity locked at detected value with the center of the sub-selector
ISO sensitivity (Recommended Exposure Index)	ISO 100 – 25600 in steps of $\frac{1}{3}$, $\frac{1}{2}$, or 1 EV. Can also be set to approx. 0.3, 0.5, 0.7, or 1 EV (ISO 50 equivalent) below ISO 100 or to approx. 0.3, 0.5, 0.7, 1, 2, 3, or 4 EV (ISO 409600 equivalent) above ISO 25600; auto ISO sensitivity control available
Active D-Lighting	Can be selected from Auto , Extra high +2/+1, High , Normal , Low , or Off



Focus	
Autofocus	Nikon Advanced Multi-CAM 3500FX autofocus sensor module with TTL phase detection, fine-tuning, and 51 focus points (including 15 cross-type sensors; f/8 supported by 11 sensors)
Detection range	-2 – +19 EV (ISO 100, 20 °C/68 °F)
Lens servo	<ul style="list-style-type: none"> • Autofocus (AF): Single-servo AF (AF-S); continuous-servo AF (AF-C); predictive focus tracking automatically activated according to subject status • Manual focus (M): Electronic rangefinder can be used
Focus point	Can be selected from 51 or 11 focus points
AF-area mode	Single-point AF, 9-, 21-, or 51- point dynamic-area AF, 3D-tracking, group-area AF, auto-area AF
Focus lock	Focus can be locked by pressing shutter-release button halfway (single-servo AF) or by pressing the center of the sub-selector

Flash	
Flash control	TTL: i-TTL flash control using RGB sensor with approximately 91K (91,000) pixels is available with SB-910, SB-900, SB-800, SB-700, SB-600, SB-400, or SB-300; i-TTL balanced fill-flash for digital SLR is used with matrix and center-weighting metering, standard i-TTL flash for digital SLR with spot metering
Flash mode	Front curtain sync, slow sync, rear-curtain sync, red-eye reduction, red-eye reduction with slow sync, slow rear-curtain sync, off, Auto FP High-Speed Sync supported
Flash compensation	-3 – +1 EV in increments of $\frac{1}{3}$, $\frac{1}{2}$, or 1 EV
Flash-ready indicator	Lights when optional flash unit is fully charged; flashes after flash is fired at full output
Accessory shoe	ISO 518 hot-shoe with sync and data contacts and safety lock

Flash	
Nikon Creative Lighting System (CLS)	Advanced Wireless Lighting supported with SB-910, SB-900, SB-800, or SB-700 as a master flash, and SB-600 or SB-R200 as remotes, or SU-800 as commander; Auto FP High-Speed Sync and modeling illumination supported with all CLS-compatible flash units except SB-400 and SB-300; Flash Color Information Communication and FV lock supported with all CLS-compatible flash units
Sync terminal	ISO 519 sync terminal with locking thread

White balance	
White balance	Auto (2 types), incandescent, fluorescent (7 types), direct sunlight, flash, cloudy, shade, preset manual (up to 6 values can be stored, spot white balance measurement available during live view), choose color temperature (2500 K–10000 K), all with fine-tuning.

Live view	
Modes	Live view photography (quiet or silent), movie live view
Lens servo	<ul style="list-style-type: none"> • Autofocus (AF): Single-servo AF (AF-S); full-time servo AF (AF-F) • Manual focus (M)
AF-area mode	Face-priority AF, wide-area AF, normal-area AF, subject-tracking AF
Autofocus	Contrast-detect AF anywhere in frame (camera selects focus point automatically when face-priority AF or subject-tracking AF is selected)

Movie	
Metering	TTL exposure metering using main image sensor
Frame size (pixels) and frame rate	<ul style="list-style-type: none"> • 1920 × 1080; 60 p (progressive), 50 p, 30 p, 25 p, 24 p • 1920 × 1080 crop; 30 p, 25 p, 24 p • 1280 × 720; 60 p, 50 p • 640 × 424; 30 p, 25 p <p>Actual frame rates for 60 p, 50 p, 30 p, 25 p, and 24 p are 59.94, 50, 29.97, 25, and 23.976 fps respectively; all options support both ★ high and normal image quality</p>

Movie	
File format	MOV
Video compression	H.264/MPEG-4 Advanced Video Coding
Audio recording format	Linear PCM
Audio recording device	Built-in monaural or external stereo microphone; sensitivity adjustable
ISO sensitivity	<ul style="list-style-type: none"> • Exposure modes P, S, and A: Auto ISO sensitivity control (ISO 200 to Hi 4) with selectable upper limit • Exposure mode M: Auto ISO sensitivity control (ISO 200 to Hi 4) available with selectable upper limit; manual selection (ISO 200 to 25600 in steps of $\frac{1}{3}$, $\frac{1}{2}$, or 1 EV) with additional options available equivalent to approximately 0.3, 0.5, 0.7, 1, 2, 3, or 4 EV (ISO 409600 equivalent) above ISO 25600
Other options	Index marking, time-lapse photography

Monitor	
Monitor	8-cm/3.2-in., approx. 921k-dot (VGA) TFT LCD with 170 ° viewing angle, approximately 100% frame coverage, manual monitor brightness control, and automatic monitor brightness control using ambient brightness sensor

Playback	
Playback	Full-frame and thumbnail (4, 9, or 72 images) playback with playback zoom, movie playback, photo and/or movie slide shows, histogram display, highlights, photo information, location data display, auto image rotation, voice memo input and playback, and IPTC information embedding and display

Interface	
USB	Hi-Speed USB
HDMI output	Type C HDMI connector
Audio input	Stereo mini-pin jack (3.5 mm diameter; plug-in power supported)
Audio output	Stereo mini-pin jack (3.5 mm diameter)



Interface	
Ten-pin remote terminal	Can be used to connect optional remote control, optional WR-R10 (requires WR-A10 adapter) or WR-1 wireless remote controller, GP-1/GP-1A GPS unit, or GPS device compliant with NMEA0183 version 2.01 or 3.01 (requires optional MC-35 GPS adapter cord and cable with D-sub 9-pin connector)
Ethernet	RJ-45 connector <ul style="list-style-type: none"> • Standards: IEEE 802.3ab (1000BASE-T)/IEEE 802.3u (100BASE-TX)/IEEE 802.3 (10BASE-T) • Data rates: 10/100/1000 Mbps with auto detect (maximum logical data rates according to IEEE standard; actual rates may differ) • Port: 1000BASE-T/100BASE-TX/10BASE-T (AUTO-MDIX)
Peripheral connector	For WT-5

Supported languages	
Supported languages	Arabic, Chinese (Simplified and Traditional), Czech, Danish, Dutch, English, Finnish, French, German, Indonesian, Italian, Japanese, Korean, Norwegian, Polish, Portuguese (Portugal and Brazil), Romanian, Russian, Spanish, Swedish, Thai, Turkish, Ukrainian

Power source	
Battery	One rechargeable Li-ion EN-EL18a battery
AC adapter	EH-6b AC adapter; requires EP-6 power connector (available separately)

Tripod socket	
Tripod socket	1/4 in. (ISO 1222)

Dimensions/weight	
Dimensions (W × H × D)	Approx. 160 × 156.5 × 90.5 mm (6.3 × 6.2 × 3.6 in.)
Weight	Approx. 1350 g (2 lb. 15.6 oz.) with battery and XQD memory card but without body cap and accessory shoe cover; approx. 1180 g/2 lb. 9.6 oz. (camera body only)



Operating environment	
Temperature	0 °C–40 °C (+32 °F–104 °F)
Humidity	85% or less (no condensation)

- Unless otherwise stated, all figures are for a camera with a fully-charged battery operating at the temperature specified by the Camera and Imaging Products Association (CIPA): 23 ±3 °C (73.4 ±5.4 °F).
- Nikon reserves the right to change the specifications of the hardware and software described in this manual at any time and without prior notice. Nikon will not be held liable for damages that may result from any mistakes that this manual may contain.

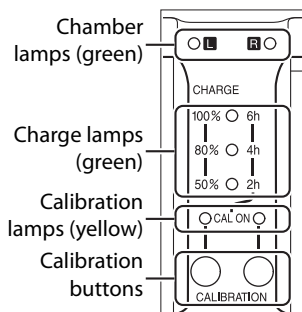
MH-26a battery charger	
Rated input	AC 100 to 240 V, 50/60 Hz
Charging output	DC 12.6 V/1.2 A
Applicable batteries	Nikon EN-EL18a rechargeable Li-ion batteries
Charging time per battery	Approx. 2 hours and 35 minutes at ambient temperature of 25 °C (77 °F) when no charge remains
Operating temperature	0 °C–40 °C (+32 °F–104 °F)
Dimensions (W × H × D)	Approx. 160 × 85 × 50.5 mm (6.3 × 3.3 × 2 in.)
Length of power cable	Approx. 1.8 m/6 ft (U.S.A. and Canada) or 1.5 m/4.9 ft (other countries)
Weight	<ul style="list-style-type: none"> • Approx. 285 g (10.1 oz), including two contact protectors but excluding power cable • Approx. 265 g (9.3 oz), excluding contact protectors and power cable

EN-EL18a rechargeable Li-ion battery	
Type	Rechargeable lithium-ion battery
Rated capacity	10.8 V/2500 mAh
Operating temperature	0 °C–40 °C (+32 °F–104 °F)
Dimensions (W × H × D)	Approx. 56.5 × 27 × 82.5 mm (2.2 × 1.1 × 3.2 in.)
Weight	Approx. 160 g (5.6 oz), excluding terminal cover

Calibrating Batteries

The MH-26a battery charger is equipped with a battery calibration feature. Calibrate the battery as required to ensure the accuracy of the camera and charger battery level displays.

If the calibration lamp for the current battery chamber flashes when a battery is inserted, the battery needs to be calibrated. To begin calibration, press the calibration button for the current chamber for about a second. The time needed to calibrate the battery is shown by the charge and calibration lamps:



Approximate time needed to recalibrate battery	Calibration lamp	Charge lamps		
		2 h	4 h	6 h
Over 6 hours	○ (glows)	○ (glows)	○ (glows)	○ (glows)
4 – 6 hours	○ (glows)	○ (glows)	○ (glows)	● (off)
2 – 4 hours	○ (glows)	○ (glows)	● (off)	● (off)
Under 2 hours	○ (glows)	● (off)	● (off)	● (off)

When calibration is complete, the calibration and charge lamps will turn off and charging will begin immediately.

Although calibration is recommended for accurate measurement of battery charge state, calibration need not be performed when the calibration lamp flashes. Once begun, calibration can be interrupted as desired.

- If the calibration button is not pressed while the calibration lamp is flashing, normal charging will begin after about ten seconds.
- To interrupt calibration, press the calibration button again. Calibration will end and charging will begin.

Battery Warning

If the chamber and calibration lamps flash on and off in sequence when no battery is inserted, there is a problem with the charger. If the chamber and calibration lamps flash on and off in sequence when a battery is inserted, a problem has occurred with the battery or charger during charging. Remove the battery, unplug the charger, and take the battery and charger to a Nikon-authorized service representative for inspection.

Charging and Calibrating Two Batteries

The MH-26a charges only one battery at a time. If batteries are inserted in both chambers, they will be charged in the order inserted. If the calibration button for the first battery is pressed, the second battery can not be calibrated or charged until calibration and charging of the first battery are complete.

FreeType License (FreeType2)

Portions of this software are copyright © 2012 The FreeType Project (<http://www.freetype.org>). All rights reserved.

MIT License (HarfBuzz)

Portions of this software are copyright © 2014 The HarfBuzz Project (<http://www.freedesktop.org/wiki/Software/HarfBuzz>). All rights reserved.

Trademark Information

IOS is a trademark or registered trademark of Cisco Systems, Inc., in the United States and/or other countries and is used under license. Mac and OS X are registered trademarks of Apple Inc. in the United States and/or other countries. Microsoft, Windows and Windows Vista are either registered trademarks, or trademarks of Microsoft Corporation in the United States and/or other countries. PictBridge is a trademark. XQD is a trademark of Sony Corporation. CompactFlash is a trademark of SanDisk Corporation. HDMI, the HDMI logo and High-Definition Multimedia Interface are trademarks or registered trademarks of HDMI Licensing LLC.

HDMI

All other trade names mentioned in this manual or the other documentation provided with your Nikon product are trademarks or registered trademarks of their respective holders.

Supported Standards

- **DCF Version 2.0:** The Design Rule for Camera File System (DCF) is a standard widely used in the digital camera industry to ensure compatibility among different makes of camera.
- **DPOF:** Digital Print Order Format (DPOF) is an industry-wide standard that allows pictures to be printed from print orders stored on the memory card.
- **Exif version 2.3:** The camera supports Exif (Exchangeable Image File Format for Digital Still Cameras) version 2.3, a standard in which information stored with photographs is used for optimal color reproduction when the images are output on Exif-compliant printers.
- **PictBridge:** A standard developed through cooperation with the digital camera and printer industries, allowing photographs to be output directly to a printer without first transferring them to a computer.
- **HDMI:** High-Definition Multimedia Interface is a standard for multimedia interfaces used in consumer electronics and AV devices capable of transmitting audiovisual data and control signals to HDMI-compliant devices via a single cable connection.

Approved Memory Cards

The camera accepts the XQD and CompactFlash memory cards listed in the following sections. Other cards have not been tested. For more details on the cards listed below, please contact the manufacturer.

■ XQD Memory Cards

The following XQD memory cards have been tested and approved for use in the camera.

Sony	S series	QD-S32/QD-S32E	32 GB
		QD-S64/QD-S64E	64 GB
	H series	QD-H16	16 GB
		QD-H32	32 GB
	N series	QD-N32	32 GB
		QD-N64	64 GB
Lexar Media	Professional	1100 ×	32 GB, 64 GB

■ ■ CompactFlash Memory Cards

The following Type I CompactFlash memory cards have been tested and approved for use in the camera. Type II cards and microdrives can not be used.

SanDisk	Extreme Pro	SDCFXPS	16 GB, 32 GB, 64 GB, 128 GB, 256 GB
		SDCFXP	16 GB, 32 GB, 64 GB, 128 GB
	Extreme	SDCFXS	8 GB, 16 GB, 32 GB, 64 GB, 128 GB
		SDCFX	8 GB, 16 GB, 32 GB
	Extreme IV	SDCFX4	2 GB, 4 GB, 8 GB, 16 GB
	Extreme III	SDCFX3	2 GB, 4 GB, 8 GB, 16 GB
	Ultra II	SDCFH	2 GB, 4 GB, 8 GB
	Ultra	SDCFHS	4 GB, 8 GB, 16 GB
SDCFHG		4 GB, 8 GB, 16 GB	
Standard	SDCFB	2 GB, 4 GB	
Lexar Media	Professional UDMA	1000 ×	16 GB, 32 GB, 64 GB, 128 GB, 256 GB
		800 ×	8 GB, 16 GB, 32 GB, 64 GB, 128 GB
		600 ×	8 GB, 16 GB, 32 GB
		400 ×	8 GB, 16 GB, 32 GB, 64 GB, 128 GB
		300 ×	2 GB, 4 GB, 8 GB, 16 GB
	Professional	233 ×	2 GB, 4 GB, 8 GB
		133 ×	2 GB, 4 GB, 8 GB
		80 ×	2 GB, 4 GB
	Platinum II	200 ×	4 GB, 8 GB, 16 GB
		80 ×	2 GB, 4 GB, 8 GB, 16 GB
		60 ×	4 GB

Cards with write speeds of 30 MB/s (200×) or better are recommended for movie recording. Slower speeds may interrupt recording or cause jerky, uneven playback.



Memory Card Capacity

The following table shows the approximate number of pictures that can be stored on a 32 GB Sony S-series QD-S32E XQD card at different image quality, image size, and image area settings.

■ FX (36×24) Image Area*

Image quality	Image size	File size ¹	No. of images ¹	Buffer capacity ²
NEF (RAW), Lossless compressed, 12-bit	Large	15.4 MB	1100	133
NEF (RAW), Lossless compressed, 14-bit	Large	19.3 MB	859	78
NEF (RAW), Compressed, 12-bit	Large	14.1 MB	1400	176
NEF (RAW), Compressed, 14-bit	Large	17.3 MB	1200	104
NEF (RAW), Uncompressed, 12-bit	Large	25.9 MB	1100	88
	Small	13.1 MB	2100	36
NEF (RAW), Uncompressed, 14-bit	Large	33.6 MB	859	60
TIFF (RGB)	Large	48.9 MB	599	55
	Medium	28.1 MB	1000	81
	Small	13.1 MB	2100	157
JPEG fine ³	Large	9.1 MB	2600	200
	Medium	5.6 MB	4300	200
	Small	3.0 MB	7800	200
JPEG normal ³	Large	4.6 MB	5100	200
	Medium	2.8 MB	8200	200
	Small	1.6 MB	14,400	200
JPEG basic ³	Large	2.1 MB	9800	200
	Medium	1.5 MB	15,300	200
	Small	0.9 MB	25,400	200

* Includes images taken with non-DX lenses when **On** is selected for **Auto DX crop**.


■ DX (24×16) Image Area*

Image quality	Image size	File size ¹	No. of images ¹	Buffer capacity ²
NEF (RAW), Lossless compressed, 12-bit	Large	7.4 MB	1600	200
NEF (RAW), Lossless compressed, 14-bit	Large	9.1 MB	1300	200
NEF (RAW), Compressed, 12-bit	Large	6.7 MB	2200	200
NEF (RAW), Compressed, 14-bit	Large	8.1 MB	1800	200
NEF (RAW), Uncompressed, 12-bit	Large	11.7 MB	1600	200
	Small	6.3 MB	4400	38
NEF (RAW), Uncompressed, 14-bit	Large	15.0 MB	1300	144
TIFF (RGB)	Large	21.2 MB	1300	96
	Medium	12.4 MB	2200	155
	Small	6.3 MB	4400	163
JPEG fine ³	Large	4.4 MB	5300	200
	Medium	2.9 MB	8000	200
	Small	2.1 MB	12,400	200
JPEG normal ³	Large	2.2 MB	10,200	200
	Medium	1.5 MB	14,800	200
	Small	1.1 MB	22,300	200
JPEG basic ³	Large	1.2 MB	18,600	200
	Medium	0.9 MB	26,100	200
	Small	0.7 MB	37,200	200

* Includes images taken with DX lenses when **On** is selected for **Auto DX crop**.

- 1 All figures are approximate. File size varies with scene recorded.
- 2 Maximum number of exposures that can be stored in memory buffer at ISO 100. Drops if **Optimal quality** is selected for **JPEG/TIFF recording > JPEG compression** or auto distortion control is on.
- 3 Figures assume **JPEG/TIFF recording > JPEG compression** is set to **Size priority**. Selecting **Optimal quality** increases the file size of JPEG images; number of images and buffer capacity drop accordingly.



 **d3—Max. Continuous Release** (📖 327)

The maximum number of photographs that can be taken in a single burst can be set to any amount between 1 and 200.

Battery Life

The movie footage or number of shots that can be recorded with fully-charged batteries varies with the condition of the battery, temperature, the interval between shots, and the length of time menus are displayed. Sample figures for EN-EL18a (2500 mAh) batteries are given below.


- **Photographs, single-frame release mode (CIPA standard ¹):** Approximately 3020 shots
- **Photographs, continuous release mode (Nikon standard ²):** Approximately 5960 shots
- **Movies:** Approximately 55 minutes at 1080/60p ³
 - 1 Measured at 23 °C/73.4 °F (± 3 °C/5.4 °F) with an AF-S NIKKOR 24–70mm f/2.8G ED lens under the following test conditions: lens cycled from infinity to minimum range and one photograph taken at default settings once every 30 s. Live view not used.
 - 2 Measured at 20 °C/68 °F with an AF-S VR ED 70–200mm f/2.8G lens under the following test conditions: vibration reduction off, image quality set to JPEG normal, image size set to L (large), shutter speed $1/250$ s, focus cycled from infinity to minimum range three times after shutter-release button has been pressed halfway for 3 s; six shots are then taken in succession and monitor turned on for 5 s and then turned off; cycle repeated once standby timer has expired.
 - 3 Measured at 23 °C/73.4 °F (± 3 °C/5.4 °F) with the camera at default settings and an AF-S NIKKOR 24–70mm f/2.8G ED lens under conditions specified by the Camera and Imaging Products Association (CIPA). Individual movies can be up to 10 minutes in length or 4 GB in size; recording may end before these limits are reached if the camera temperature rises.



The following can reduce battery life:

- Using the monitor
- Keeping the shutter-release button pressed halfway
- Repeated autofocus operations
- Taking NEF (RAW) or TIFF (RGB) photographs
- Slow shutter speeds
- Connecting to Ethernet or wireless networks
- Using a GP-1 or GP-1A GPS unit
- Using a WR-R10/WR-1 wireless remote controller or ML-3 modulite remote control set
- Using VR (vibration reduction) mode with VR lenses

To ensure that you get the most from rechargeable Nikon EN-EL18a batteries:

- Keep the battery contacts clean. Soiled contacts can reduce battery performance.
- Use batteries immediately after charging. Batteries will lose their charge if left unused.
- Check the condition of the battery regularly using the **Battery info** option in the setup menu (□ 365). If CAL is displayed for **Calibration**, calibrate the battery using the MH-26a battery charger (if the battery has not been used for more than six months, recharge the battery when calibration is complete).

Index

Symbols

P (Programmed auto)	125, 127
S (Shutter-priority auto)	125, 128
R (Aperture-priority auto)	125, 129
M (Manual).....	125, 130
S	111
CL	111, 112, 326
CH	111, 112, 326
Q	111
☺ (Self-timer).....	111, 114
MUP	111, 116
[] (Single-point AF)	100
[] (Dynamic-area AF)	100, 315
[] (Group-area AF)	101, 315
[] (Auto-area AF)	101
[] (Face-priority AF)	53
[] (Wide-area AF)	53
[] (Normal-area AF)	53
[] (Subject-tracking AF)	53
[] (Matrix)	123, 323
[] (Center-weighted)	123, 323
[] (Spot).....	123
[] (Info) button.....	12, 15, 58, 69
[] (Live view) button	349
[] (Live view)	49, 63, 169
? (Help)	17, 20
[] (Memory buffer)	43, 327, 464
[] switch.....	9, 330
● (Focus indicator).....	43, 105, 109
PRE (Preset manual)	156, 164

Numerics

1.2× (30 × 20).....	86
12-bit	92
14-bit	92
3D color matrix metering III	123
3D-tracking	100, 101
5 : 4 (30 × 24).....	86

A

AC adapter	408, 414
------------------	----------

Accessories.....	408
Accessory shoe	16, 195
Active D-Lighting.....	150, 188, 341
Add items (My Menu).....	397
ADL bracketing.....	150, 333
Adobe RGB	305
AE & flash (Auto bracketing set)	140, 333
AE only (Auto bracketing set)..	140, 333
AF.....	52–54, 97–107, 313–320
AF activation.....	315
AF area brackets.....	10, 38
AF fine-tune.....	373
AF-area mode.....	53, 100, 320
AF-C	97, 313
AF-F	52
AF-ON button	99, 315, 317
AF-ON button for vertical shooting.....	99, 318
AF-S.....	52, 97, 314
After delete	296
Ambient brightness sensor....	5, 57, 359
Angle of view	85, 406–407
Aperture	129–130, 134
Aperture Lock.....	134, 343
Aperture-priority auto	129
Aspect ratio.....	70, 86, 381
Attaching the lens	27
Audio	65, 267, 297, 298
Audio output.....	267, 456
Auto (White balance)	155
Auto bracketing	140, 333, 334
Auto bracketing (mode M).....	334
Auto distortion control.....	307
Auto DX crop	86
Auto FP high-speed sync	197, 331
Auto image rotation	364
Auto ISO sensitivity control.....	119
Auto-area AF.....	101, 102
Autofocus	52–54, 97–107, 313–320
Autofocus mode.....	52, 97, 320



Autofocus mode restrictions..... 320

B

Backlight..... 9, 330

Battery..... 21–26, 40, 365, 458, 459

Battery info..... 365

Beep..... 326

BKT button..... 142, 143, 146, 147, 150,
151, 194, 216, 344

Black-and-white (Monochrome)..... 382

Body cap..... 27, 411

Border..... 281

Bracketing..... 140, 333, 334

Bracketing order..... 334

Bulb..... 132

Burst..... 112, 327, 338

Button backlights..... 9, 330

C

Calibration..... 459

Camera Control Pro 2..... 411

Capture NX 2..... 91, 186, 361, 411

Center-weighted metering..... 123, 323

CF card..... 32, 96, 463

CF card slot..... 96

Charging the battery..... 21–23

Choose color temp. (White balance).....
156, 161

Choose image area..... 70, 86, 88, 341

Choose start/end point..... 79

Clean image sensor..... 417

Clock..... 30, 363

Clock battery..... 31, 424

Cloudy (White balance)..... 156

CLS..... 196

Color balance..... 383

Color space..... 305

Color temperature ... 155, 156, 157, 161

Communication unit..... 277, 409

CompactFlash..... 32, 96, 463

Compatible lenses..... 401

Compressed (NEF (RAW) compression)
92

Connector for external microphone.. 2,
413

Continuous high speed ... 111, 112, 326

Continuous low speed..... 111, 112, 326

Continuous release mode..... 111

Continuous-servo AF..... 97, 313

Control panel..... 6–8

Copy image(s)..... 292

Copyright information..... 367

CPU contacts..... 403

CPU lens..... 28, 401, 403

Creative Lighting System..... 195, 196

Crop..... 70, 72, 74, 354

Cropping (PictBridge [Setup] menu).....
281

Custom Settings..... 309

Custom settings bank..... 311

Customize command dials..... 345

Cyanotype (Monochrome)..... 382

D

Date and time..... 30, 363

Date format..... 31, 363

Daylight saving time..... 30, 363

DCF..... 461

Default settings..... 211, 430

Delete..... 47, 257

Delete all images..... 257, 259

Delete current image..... 47, 257

Depth of field..... 126, 337

Destination (Movie settings)..... 75

Digital Print Order Format (DPOF) . 282,
283, 461

Diopter..... 38, 410

Direct sunlight (White balance)..... 155

Distortion control..... 392

D-Lighting..... 379

DPOF..... 282, 283, 461

DPOF print order..... 283

Dual monitor..... 286

DX (24 × 16) 1.5 ×..... 86, 88, 89

DX format..... 85, 86, 87

DX-based movie format..... 70

Dynamic-area AF..... 100, 102



E

Easy exposure compensation..... 322
Edit movie..... 79, 82
Electronic rangefinder..... 109
Ethernet..... 276, 409
EV steps for exposure cntrl..... 321
Exif..... 461
Exp./flash comp. step value..... 321
Exposure..... 123, 125, 136, 138
Exposure bracketing..... 140, 333, 334
Exposure comp. for flash..... 333
Exposure compensation..... 138, 322
Exposure delay mode..... 327
Exposure differential..... 192
Exposure indicator..... 131
Exposure lock..... 136
Exposure meters..... 44, 240, 324
Exposure mode..... 125
Exposure program..... 438
Exposure smoothing..... 223, 230
Extended menu banks..... 301
External microphone..... 75, 261, 413

F

Face detection..... 323
Face-priority AF..... 53
File information..... 245
File naming..... 304
File number sequence..... 328
Filter effects..... 180, 181, 382
Fine-tune optimal exposure..... 323
Firmware version..... 374
Flash..... 195, 196, 203, 206, 208
Flash (White balance)..... 155
Flash bracketing..... 140, 333, 334
Flash compensation..... 206
Flash control..... 202
Flash mode..... 203, 204
Flash only (Auto bracketing set)..... 141, 333, 334
Flash range..... 196
Flash shutter speed..... 332
Flash sync speed..... 331
Flash sync terminal..... 195

Flash-ready indicator.. 11, 199, 209, 454
Flexible program..... 127
Flicker reduction..... 363
Fluorescent (White balance)..... 155
Fn button..... 89, 337, 353
Fn button (vertical)..... 343
f-number..... 129, 403
Focal length..... 237, 406–407
Focal plane mark..... 109
Focus..... 52–54, 59, 97–109, 313–320
Focus indicator..... 43, 105, 109
Focus lock..... 105
Focus mode..... 52, 97, 108
Focus mode switch..... 28, 108
Focus point..... 53, 100, 103, 315, 316
Focus point illumination..... 315
Focus point wrap-around..... 316
Focus tracking..... 99, 314
Focus tracking with lock-on..... 314
Focusing screen..... 451
Focus-mode selector..... 52, 97, 108
Format..... 35, 359
Format memory card..... 359
Frame interval (Slide show)..... 297
Frame rate..... 74
Frame size/frame rate..... 74
Frequency response (Movie settings) ...
75
Front-curtain sync..... 203
Full-frame playback..... 241
Full-time servo AF..... 52
FV lock..... 208, 337, 350
FX (36 × 24) 1.0 ×..... 86
FX format..... 85, 86
FX-based movie format..... 70

G

GPS..... 238, 240, 251
GPS unit..... 238, 412
Group-area AF..... 101, 102

H

H.264..... 456
HDMI..... 267, 285, 461



HDMI connector	285
HDR (high dynamic range)	190
Headphones.....	68, 267
Help.....	17, 20
Hi	118
Hide image	290
High definition	285, 461
High Dynamic Range (HDR)	190
High ISO NR.....	308
Highlights.....	246
Histogram	247, 248, 336

I

Image area	28, 70, 85, 88, 94
Image comment	366
Image Dust Off ref photo	361
Image overlay	384
Image quality.....	90
Image review	243, 295
Image size	94
Incandescent (White balance).....	155
Index marking	66, 353, 355, 356
Index print	282
In-focus indicator	43, 105, 109
Information	244, 291
Information display	12, 329, 330
Interval timer shooting	221
IPTC.....	251, 368
ISO sensitivity	76, 117, 119
ISO sensitivity step value.....	321
i-TTL.....	197, 202

J

JPEG.....	90, 92, 304, 387
JPEG basic	90
JPEG fine	90
JPEG normal	90
JPEG/TIFF recording	92, 304

L

L (large).....	72, 94, 95
LAN	409
Landscape (Set Picture Control)	177
Language	29, 364
LCD	9, 330

LCD illumination.....	330
Lens.....	27–28, 235, 373, 401
Lens cap.....	27
Lens focus function buttons	351
Lens focus ring.....	27, 59, 108
Lens mount	3, 28, 109
Lens mounting mark	3, 27, 28
Limit AF-area mode selection	320
Live view	49, 63
Live view button options	349
Live view photography	49–62
Live view selector.....	49, 63
Lo	118
Location data.....	238, 251
Lock mirror up for cleaning.....	420
Long exposure NR	308
Lossless compressed (NEF (RAW) compression).....	92

M

M (Manual focus)	59, 108
M (medium)	72, 94
Manage Picture Control.....	183
Manual (Exposure mode).....	130
Manual focus	59, 108
Matrix metering.....	123, 323
Max. continuous release.....	327
Maximum aperture	54, 200, 235, 403
Maximum sensitivity.....	120
Memory buffer	43, 113, 327
Memory card	32, 35, 96, 359, 462
Memory card capacity	464
Metering	123
Microphone	2, 5, 75, 261, 413
Microphone sensitivity (Movie settings) 75	
Minimum aperture	28, 126
Minimum shutter speed.....	120
Mired	160
Mirror.....	116, 420
Mirror up mode	111, 116
Modeling flash	126, 333
Monitor.....	49, 57, 241, 325, 359
Monitor brightness	57, 359

Monitor color balance	360	Playback menu	289
Monitor hue	56	Playback zoom.....	253, 348
Monitor off delay.....	325	Portrait (Set Picture Control).....	177
Monochrome.....	177, 382	Power aperture.....	353, 355
Movie ISO sensitivity settings (Movie settings)	76	Power connector.....	408, 414
Movie live view	63, 353	Predictive focus tracking.....	99
Movie quality (Movie settings).....	74	Preset focus point.....	335, 351
Movie settings.....	74	Preset manual (White balance).....	156, 164
Movie-record button	65, 349	Press the shutter-release button halfway.....	44
Multi selector.....	18, 336	Primary slot selection.....	41, 96
Multi selector (vertical)	348	Print (DPOF)	282
Multiple exposure.....	214	Print options (PictBridge [Setup] menu)	281
Multi-selector center button.....	335	Print select.....	282
My Menu	339, 396	Printing	279
N		Programmed auto	127
NEF (RAW)	90, 91, 92, 95, 304, 387	Protecting photographs.....	255
NEF (RAW) bit depth	92	Pv button.....	54, 66, 126, 333, 342, 355
NEF (RAW) processing	387	Q	
NEF (RAW) recording	92, 95, 304	Quiet (Live view photography).....	60
Neutral (Set Picture Control)	177	R	
No. of copies (PictBridge [Setup] menu)	281	Rank items (My Menu)	399
Non-CPU lens	235, 401, 405	Rear control panel	8
Non-CPU lens data.....	235, 236	Rear-curtain sync	203
Normal-area AF.....	53	Recent settings	396
Number of focus points.....	316	Rechargeable Li-ion battery .. i, 21, 458, 459	
O		Red-eye correction.....	380
Optimal quality (JPEG compression) 92		Red-eye reduction.....	203
Overview data	252	Release button to use dial	347
P		Release mode.....	111
Page size.....	281	Remote cord	71, 132, 412
Peripheral connector	2, 409	Remove items (My Menu).....	398
Perspective control.....	393	Removing the lens from the camera	28
Photo information	244, 291	Reset.....	211, 301, 311
PictBridge.....	279, 461	Resize	389
Picture Controls	177	Restoring default settings	211, 301, 311, 430
Pitching.....	340, 372	Retouch menu	375
Playback	46, 77, 241, 285	Reverse indicators	347
Playback display options.....	291		
Playback folder.....	290		
Playback information.....	244, 291		



RGB 90, 247, 305
RGB Histogram 247
Rolling 340, 372
Rotate tall 296

S

S (small) 72, 94, 95
Save selected frame 79
Save/load settings 370
Screen tips 329
Secondary slot function 96
Self-timer 111, 114, 325
Sensitivity 117, 119
Set clock from satellite 240
Set Picture Control 177
Setup menu 358
Shade (White balance) 156
Shooting data 249
Shooting menu 299
Shooting menu bank 300
Shutter speed 128, 130, 134
Shutter speed lock 134, 343
Shutter-priority auto 128
Shutter-release button 43, 44, 105, 136, 357
Shutter-release button AE-L 324
Side-by-side comparison 394
Silent (Live view photography) 60
Single frame 111
Single-point AF 100, 102
Single-servo AF 52, 97, 314
Size 72, 94, 381, 389
Size priority (JPEG compression) 92
Skylight 382
Slide show 297
Slot 32, 41, 75, 96, 242
Slot empty release lock 347
Slot selection 41, 96, 242
Slow sync 203
Smoothing 192
Speaker 266, 267
Speedlights 195, 196
Spot 123
Spot white balance 169

sRGB 305
Standard (Set Picture Control) 177
Standard i-TTL flash for digital SLR 197, 202

Standby timer 44, 240, 324
Start printing 281, 282
Storage folder 302
Store by orientation 319
Straighten 391
Sub-dial frame advance 346
Sub-selector 104, 105, 136, 342, 356
Synchronized release 339, 352

T

Television 285
Ten-pin remote terminal 2, 238, 412, 413
Thumbnail 241, 336
TIFF (RGB) 90, 92, 304
Time 30, 363
Time stamp 281
Time zone 30, 363
Time zone and date 30, 363
Time-lapse photography 229
Timer 114, 221
Toning (Set Picture Control) 180, 182
Top control panel 6–7
Trim 381
Two-button reset 211
Type D lens 403
Type E lens 403
Type G lens 403

U

Uncompressed (NEF (RAW) compression) 92
USB 280
USB cable i, 280
UT-1 277, 409
UTC 30, 239, 251

V

Viewfinder 10, 38, 451
Viewfinder eyepiece 39, 114
Viewfinder focus 38, 39, 410

Viewfinder grid display	329
ViewNX 2	91, 269, 272, 364, 366
Vignette control.....	306
Virtual horizon.....	58, 69, 340, 372
Vivid (Set Picture Control)	177
Voice memo	261–267
Voice memo button	262
Voice memo overwrite	262

W

Warm filter	382
WB.....	146, 155
WB bracketing (Auto bracketing set)	146, 333
White balance.....	146, 155
White balance bracketing	146, 333
Wide-area AF	53
Wind noise reduction (Movie settings) ..	75
Wireless network.....	276, 409
Wireless remote controller. 71, 350, 411	
Wireless transmitter	276, 409
WT-4.....	276, 409
WT-5.....	276, 409

X

XQD card	32, 96, 462
XQD card slot	96

No reproduction in any form of this manual, in whole or in part (except for brief quotation in critical articles or reviews), may be made without written authorization from NIKON CORPORATION.

