

Nikon

DIGITAL CAMERA

D3s

User's Manual

En

Where to Find It

Find what you're looking for from:



The Table of Contents



x-xvii

Find items by function or menu name.



The Q&A Index



iv-ix

Know what you want to do but don't know the function name? Find it from the "question and answer" index.



The Quick Start Guide



19-20

A brief guide for those who want to get started taking pictures right away.



The Index



425-430

Search by key word.



Error Messages



403-407

If a warning is displayed in the viewfinder, monitor, or control panel, find the solution here.



Troubleshooting



398-402

Camera behaving unexpectedly? Find the solution here.



For Your Safety

Before using the camera for the first time, read the safety instructions in "For Your Safety" (xviii-xx).

Help

Use the camera's on-board help feature for help on menu items and other topics. See page 25 for details.

Digitutor

Digitutor, a series of "watch and learn" manuals in movie form, is available from the following website:

http://www.nikondigitutor.com/index_eng.html

Package Contents

Be sure all items listed here were included with your camera.
Memory cards are sold separately.

- D3S digital camera (☞ 3)



- BF-1B body cap (☞ 31, 375)



- BS-2 accessory shoe cover (☞ 18, 186)



- EN-EL4a rechargeable Li-ion battery with terminal cover (☞ 26, 28)



- MH-22 quick charger with power cable and two contact protectors (☞ 26, 417)

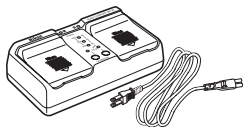

- AN-DC5 strap (☞ 18)

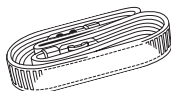

- EG-D2 audio/video cable (☞ 269)

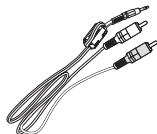

- UC-E4 USB cable (☞ 254, 259)

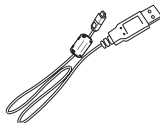

- USB cable clip (☞ 255)



-
- Warranty
 - *User's Manual* (this guide)
 - *Quick Guide*
 - *Software Installation Guide*
 - Software Suite CD-ROM
 - Registration card (U. S. A. only)

Symbols and Conventions

To make it easier to find the information you need, the following symbols and conventions are used:



This icon marks cautions; information that should be read before use to prevent damage to the camera.



This icon marks notes; information that should be read before using the camera.



This icon marks references to other pages in this manual.





































Menu items, options, and messages displayed in the camera monitor are shown in **bold**.



Trademark Information

Macintosh, Mac OS, and QuickTime are registered trademarks of Apple Inc. in the United States and/or other countries. Microsoft, Windows and Windows Vista are either registered trademarks, or trademarks of Microsoft Corporation in the United States and/or other countries. CompactFlash is a trademark of SanDisk Corporation. HDMI, the HDMI logo and High-Definition Multimedia Interface are trademarks or registered trademarks of HDMI Licensing LLC. PictBridge is a trademark. All other trade names mentioned in this manual or the other documentation provided with your Nikon product are trademarks or registered trademarks of their respective holders.

D3s

| | |
|--|--|
| Q&A Index |  iv |
| Table of Contents |  x |
|  Introduction |  1 |
|  Tutorial |  21 |
|  Framing Pictures in the Monitor (Live View) |  53 |
|  Recording and Viewing Movies |  65 |
|  Image Recording Options |  77 |
|  Focus |  89 |
|  Release Mode |  101 |
|  ISO Sensitivity |  109 |
|  Exposure |  115 |
|  White Balance |  149 |
|  Image Enhancement |  169 |
|  Flash Photography |  185 |
|  Other Shooting Options |  199 |
|  More About Playback |  221 |
|  Voice Memos |  245 |
|  Connections |  253 |
|  Menu Guide |  273 |
|  Technical Notes |  365 |

Q&A Index

Find what you're looking for using this "question and answer" index.

■ ■ New Features

| Question | Key phrase | 📖 |
|---|--------------------------------|-----|
| <i>How do I take pictures in 35mm format?</i> | > Image area | 78 |
| <i>How do I take high-quality NEF (RAW) photos?</i> | > 14-bit NEF (RAW) | 85 |
| <i>Can I use the monitor as a viewfinder?</i> | > Live view | 53 |
| <i>How do I shoot movies?</i> | > Movies | 65 |
| <i>Can I shoot movies under low light?</i> | > High-sensitivity movie mode | 72 |
| <i>How do I record photographs using two memory cards?</i> | > Slot 2 | 88 |
| <i>Can I control how photos are processed?</i> | > Picture Controls | 170 |
| <i>How do I preserve details in shadows and highlights?</i> | > Active D-Lighting | 181 |
| <i>How do I focus on erratically moving subjects?</i> | > 3D-tracking | 297 |
| <i>How do I tell if the camera is level?</i> | > Virtual horizon | 338 |
| <i>Can I adjust focus separately for different lenses?</i> | > AF fine tune | 339 |
| <i>How do I remove dust from the low-pass filter protecting the image sensor?</i> | > Cleaning the low-pass filter | 378 |

■ ■ Camera Setup

| Question | Key phrase | 📖 |
|--|---------------------|------------|
| <i>How do I keep the monitor from turning off?</i> | > Monitor off delay | 306 |
| <i>How do I keep the shutter speed and aperture displays from turning off?</i> | > Auto meter off | 45, 305 |

| Question | Key phrase |  |
|---|-------------------------|---|
| <i>How do I set the clock?</i> | | |
| <i>How do I set the clock for daylight savings time?</i> | > Time zone and date | 34, 330 |
| <i>How do I change time zones when I travel?</i> | | |
| <i>How do I adjust monitor brightness for menus or playback?</i> | > LCD brightness | 326 |
| <i>Can I reverse the exposure indicator?</i> | > Reverse indicators | 324 |
| <i>Can I display the menus in a different language?</i> | > Language | 33, 331 |
| <i>Can I save menu settings for use on a different D3S camera?</i> | > Save/load settings | 336 |
| <i>How do I restore default settings?</i> | > Two-button reset | 200 |
| <i>How do I restore shooting menu defaults?</i> | > Reset shooting menu | 287 |
| <i>How do I restore Custom Setting defaults?</i> | > Reset custom settings | 294 |

■ ■ Menus and Displays

| Question | Key phrase |  |
|---|-------------------------------|---|
| <i>How do I get more information on a menu?</i> | > Help | 25 |
| <i>How do I use the menus?</i> | > Using the menus | 22 |
| <i>Can I get quick access to frequently-used settings?</i> | > My Menu | 359 |
| <i>Can I get quick access to recently-used settings?</i> | > Recent settings | 363 |
| <i>What does this warning mean?</i> | > Error messages and displays | 403 |
| <i>How much charge does the battery have left?</i> | > Battery level | 43 |

| Question | Key phrase | 📖 |
|--|------------------------|-----|
| <i>How do I get more information about the battery?</i> | > Battery info | 333 |
| <i>How do I keep the file number from being reset when I insert a new memory card?</i> | > File number sequence | 308 |
| <i>How do I reset file numbering to 1?</i> | | |
| <i>How do I clean the camera or lens?</i> | > Cleaning the camera | 377 |

■ Taking Photographs

| Question | Key phrase | 📖 |
|---|---------------------------------|----------|
| <i>How many more shots can I take with this card?</i> | > Number of exposures remaining | 44 |
| <i>How do I take bigger photographs?</i> | | |
| <i>How can I get more photos on the memory card?</i> | > Image quality and size | 83, 86 |
| <i>How do I focus the viewfinder?</i> | > Viewfinder focus | 41 |
| <i>Can I control how the camera focuses?</i> | > Autofocus | 89 |
| <i>Can I choose the focus point?</i> | > Focus point | 94 |
| <i>How do I take a lot of photographs quickly?</i> | > Release mode | 102 |
| <i>Can I change the frame advance rate?</i> | > Shooting speed | 104, 307 |
| <i>Can I take pictures under low light without the flash?</i> | > ISO sensitivity | 110 |
| <i>Can the ISO sensitivity I choose be adjusted to ensure optimal exposure?</i> | > ISO sensitivity auto control | 112 |
| <i>Can I make photos brighter or darker?</i> | > Exposure compensation | 134 |
| <i>How do I make a time exposure?</i> | > Long time-exposures | 128 |

| Question | | Key phrase |  |
|---|---|-------------------------------|---|
| <i>Can I vary exposure or flash level automatically over a series of photos?</i> | ➤ | Exposure and flash bracketing | 136, 312 |
| <i>Can I create multiple copies of a photo using different white balance settings?</i> | ➤ | White balance bracketing | 141, 312 |
| <i>Can I vary Active D-Lighting automatically over a series of photos?</i> | ➤ | ADL bracketing | 145, 312 |
| <i>How do I adjust white balance?</i> | ➤ | White balance | 149 |
| <i>How do I change settings for optional flash units?</i> | ➤ | Flash mode | 193 |
| <i>How can I record multiple shots as a single photograph?</i> | ➤ | Multiple exposure | 202 |
| <i>Can I record voice memo when taking a photograph?</i> | ➤ | Voice memo | 246 |
| <i>Can I pick the standard exposure level?</i> | ➤ | Fine tune optimal exposure | 304 |
| <i>How can I reduce blur?</i> | ➤ | Exposure delay mode | 310 |
| <i>How do I select movie frame size, microphone sensitivity, high-sensitivity movie mode, and card slot options?</i> | ➤ | Movie settings | 70 |

■■ Viewing Photographs

| Question | | Key phrase |  |
|---|---|------------------------|---|
| <i>Can I view my photographs on the camera?</i> | ➤ | Camera playback | 222 |
| <i>Can I view movies on the camera?</i> | ➤ | Viewing movies | 73 |
| <i>Can I view more information about photos?</i> | ➤ | Photo info | 225 |
| <i>Why do parts of my photos blink?</i> | ➤ | Photo info, highlights | 227, 277 |

| Question | Key phrase | 📖 |
|--|------------------------------|----------|
| <i>How do I get rid of an unwanted photo?</i> | > Deleting individual photos | 240 |
| <i>Can I delete several photos at once?</i> | > Delete | 242 |
| <i>Can I zoom in on pictures?</i> | > Playback zoom | 237 |
| <i>Can I protect photos from accidental deletion?</i> | > Protect | 238 |
| <i>Can I hide selected photos?</i> | > Hide image | 275 |
| <i>How do I tell if parts of my photos may be overexposed?</i> | > Display mode: highlights | 227, 277 |
| <i>How do I tell where the camera focused?</i> | > Display mode: focus point | 226, 277 |
| <i>Can I view photos as they are taken?</i> | > Image review | 281 |
| <i>Can I record voice memos with photos?</i> | > Voice memo | 249 |
| <i>Is there an automatic playback (“slide show”) option?</i> | > Slide show | 282 |

■ ■ Retouching Photographs

| Question | Key phrase | 📖 |
|---|---------------------------------|-----|
| <i>How do I bring out details in shadows?</i> | > D-Lighting | 344 |
| <i>Can I get rid of red eye?</i> | > Red-eye correction | 345 |
| <i>Can I crop photographs on the camera?</i> | > Trim | 346 |
| <i>Can I create a monochrome copy of a photograph?</i> | > Monochrome | 347 |
| <i>Can I create a copy with different colors?</i> | > Filter effects, Color balance | 348 |
| <i>Can I use the camera to create JPEG copies of NEF (RAW) photographs?</i> | > NEF (RAW) processing | 353 |
| <i>Can I overlay two NEF (RAW) photos to make a single image?</i> | > Image overlay | 349 |
| <i>Can I trim movies or save movie stills?</i> | > Editing movies | 74 |

■■ Viewing or Printing Photographs on Other Devices

| Question | Key phrase | 📖 |
|---|----------------------------|-----|
| <i>Can I view my photos on TV?</i> | ➤ Television playback | 269 |
| <i>Can I view my photos in High Definition?</i> | ➤ HDMI | 271 |
| <i>How do I copy photos to my computer?</i> | ➤ Connecting to a computer | 254 |
| <i>How do I print photographs?</i> | ➤ Printing photographs | 258 |
| <i>Can I print photos without a computer?</i> | ➤ Printing via USB | 259 |
| <i>Can I print the date on my photographs?</i> | ➤ Time stamp | 261 |

■■ Optional Accessories

| Question | Key phrase | 📖 |
|--|-------------------------|-----|
| <i>What memory cards can I use?</i> | ➤ Approved memory cards | 419 |
| <i>What lenses can I use?</i> | ➤ Compatible lenses | 366 |
| <i>What optional flash units (Speedlights) can I use?</i> | ➤ Optional flash units | 187 |
| <i>What software is available for my camera?</i> | ➤ Other accessories | 375 |
| <i>What AC adapters, remote cords, and viewfinder accessories are available for my camera?</i> | ➤ Other accessories | 372 |

Table of Contents

| | |
|-----------------------|-------|
| Q&A Index | iv |
| For Your Safety | xviii |
| Notices..... | xxi |

Introduction **1**

| | |
|-------------------------------------|----|
| Overview | 2 |
| Getting to Know the Camera..... | 3 |
| Camera Body | 3 |
| The Top Control Panel | 8 |
| The Rear Control Panel | 10 |
| The Viewfinder Display | 12 |
| The Information Display..... | 14 |
| The Camera Strap | 18 |
| The BS-2 Accessory Shoe Cover | 18 |
| Quick Start Guide..... | 19 |

Tutorial **21**

| | |
|-------------------------------------|----|
| Camera Menus..... | 22 |
| Using Camera Menus | 23 |
| Help | 25 |
| First Steps | 26 |
| Charge the Battery | 26 |
| Insert the Battery | 28 |
| Attach a Lens..... | 31 |
| Basic Setup..... | 33 |
| Insert a Memory Card..... | 36 |
| Format the Memory Card | 39 |
| Adjust Viewfinder Focus | 41 |
| Basic Photography and Playback..... | 43 |
| Turn the Camera On | 43 |
| Adjust Camera Settings..... | 46 |

| | |
|--|------------|
| Focus and Shoot | 49 |
| Viewing Photographs | 51 |
| Deleting Unwanted Photographs | 52 |
| Framing Pictures in the Monitor (Live View) | 53 |
| <hr/> | |
| Framing Photographs in the Monitor | 54 |
| Recording and Viewing Movies | 65 |
| <hr/> | |
| Recording Movies | 66 |
| Viewing Movies | 73 |
| Editing Movies | 74 |
| Image Recording Options | 77 |
| <hr/> | |
| Image Area | 78 |
| Image Quality | 83 |
| Image Size | 86 |
| Slot 2 | 88 |
| Focus | 89 |
| <hr/> | |
| Focus Mode | 90 |
| AF-Area Mode | 92 |
| Focus Point Selection | 94 |
| Focus Lock | 96 |
| Manual Focus | 99 |
| Release Mode | 101 |
| <hr/> | |
| Choosing a Release Mode | 102 |
| Continuous Mode | 104 |
| Self-Timer Mode | 106 |
| Mirror up Mode | 108 |

ISO Sensitivity **109**

| | |
|--|-----|
| Choosing ISO Sensitivity Manually..... | 110 |
| Auto ISO Sensitivity Control | 112 |

Exposure **115**

| | |
|---|-----|
| Metering | 116 |
| Exposure Mode..... | 118 |
| <i>P</i> : Programmed Auto | 120 |
| <i>S</i> : Shutter-Priority Auto | 122 |
| <i>A</i> : Aperture-Priority Auto | 123 |
| <i>M</i> : Manual..... | 125 |
| Long Time-Exposures..... | 128 |
| Shutter-Speed and Aperture Lock..... | 130 |
| Autoexposure (AE) Lock..... | 132 |
| Exposure Compensation..... | 134 |
| Bracketing | 136 |

White Balance **149**

| | |
|------------------------------------|-----|
| White Balance Options | 150 |
| Fine-Tuning White Balance | 153 |
| Choosing a Color Temperature | 157 |
| Preset Manual | 158 |

Image Enhancement **169**

| | |
|---|-----|
| Picture Controls..... | 170 |
| Selecting a Picture Control..... | 170 |
| Modifying Existing Picture Controls | 172 |
| Creating Custom Picture Controls..... | 176 |
| Sharing Custom Picture Controls | 179 |
| Active D-Lighting..... | 181 |
| Color Space | 183 |

Flash Photography

185

| | |
|--|-----|
| Using a Flash | 186 |
| The Nikon Creative Lighting System (CLS) | 187 |
| Other Flash Units..... | 189 |
| i-TTL Flash Control | 192 |
| Flash Modes..... | 193 |
| FV Lock | 196 |

Other Shooting Options

199

| | |
|--|-----|
| Two-Button Reset: Restoring Default Settings | 200 |
| Multiple Exposure | 202 |
| Interval Timer Photography | 208 |
| Non-CPU Lenses..... | 214 |
| Using a GPS Unit | 217 |

More About Playback

221

| | |
|---|-----|
| Full-Frame Playback | 222 |
| Photo Information..... | 225 |
| Viewing Multiple Images: Thumbnail Playback | 235 |
| Taking a Closer Look: Playback Zoom..... | 237 |
| Protecting Photographs from Deletion..... | 238 |
| Deleting Photographs | 240 |
| Full-Frame and Thumbnail Playback | 240 |
| The Playback Menu | 242 |



Voice Memos

245

| | |
|-----------------------------|-----|
| Recording Voice Memos | 246 |
| Playing Voice Memos | 251 |

| | |
|--|-----|
| Connecting to a Computer | 254 |
| Direct USB Connection | 255 |
| Wireless and Ethernet Networks | 257 |
| Printing Photographs..... | 258 |
| Connecting the Printer | 259 |
| Printing Pictures One at a Time | 260 |
| Printing Multiple Pictures | 263 |
| Creating a DPOF Print Order: Print Set | 267 |
| Viewing Photographs on TV | 269 |
| Standard Definition Devices..... | 269 |
| High-Definition Devices | 271 |

| | |
|--|-----|
| ▶ The Playback Menu: Managing Images..... | 274 |
| Playback Folder..... | 275 |
| Hide Image | 275 |
| Display Mode..... | 277 |
| Copy Image(s) | 278 |
| Image Review | 281 |
| After Delete | 281 |
| Rotate Tall | 282 |
| Slide Show | 282 |
| 📷 The Shooting Menu: Shooting Options..... | 284 |
| Shooting Menu Bank | 285 |
| Reset Shooting Menu | 287 |
| Extended Menu Banks..... | 287 |
| Active Folder..... | 288 |
| File Naming | 290 |
| Vignette Control..... | 290 |
| Long Exp. NR (Long Exposure Noise Reduction) | 291 |
| High ISO NR..... | 291 |

| | |
|--|-----|
|  Custom Settings: Fine-Tuning Camera Settings | 292 |
|  Custom Setting Bank | 294 |
|  Reset Custom Settings | 294 |
| a: Autofocus | 295 |
| a1: AF-C Priority Selection | 295 |
| a2: AF-S Priority Selection | 296 |
| a3: Dynamic AF Area | 296 |
| a4: Focus Tracking with Lock-On | 298 |
| a5: AF Activation | 298 |
| a6: Focus point Illumination | 299 |
| a7: Focus Point Wrap-Around | 299 |
| a8: AF Point Selection | 300 |
| a9: AF-ON Button | 300 |
| a10: Vertical AF-ON Button | 301 |
| b: Metering/Exposure | 302 |
| b1: ISO Sensitivity Step Value | 302 |
| b2: EV Steps for Exposure Cntrl. | 302 |
| b3: EV Steps for Exposure Comp. | 302 |
| b4: Easy Exposure Compensation | 303 |
| b5: Center-Weighted Area | 304 |
| b6: Fine Tune Optimal Exposure | 304 |
| c: Timers/AE Lock | 305 |
| c1: Shutter-Release Button AE-L | 305 |
| c2: Auto Meter-off Delay | 305 |
| c3: Self-Timer | 305 |
| c4: Monitor off Delay | 306 |
| d: Shooting/Display | 306 |
| d1: Beep | 306 |
| d2: Shooting Speed | 307 |
| d3: Max. Continuous Release | 307 |
| d4: File Number Sequence | 308 |
| d5: Control Panel/Viewfinder | 309 |
| d6: Information Display | 309 |
| d7: Screen Tips | 310 |
| d8: LCD Illumination | 310 |
| d9: Exposure Delay Mode | 310 |
| e: Bracketing/Flash | 311 |
| e1: Flash Sync Speed | 311 |
| e2: Flash Shutter Speed | 312 |

| | |
|--|------------|
| e3: Modeling Flash..... | 312 |
| e4: Auto Bracketing Set | 312 |
| e5: Auto Bracketing (Mode M)..... | 313 |
| e6: Bracketing Order | 313 |
| f: Controls | 314 |
| f1: Multi Selector Center Button | 314 |
| f2: Multi Selector..... | 315 |
| f3: Photo Info/Playback..... | 315 |
| f4: Assign Fn Button | 316 |
| f5: Assign Preview Button | 321 |
| f6: Assign AE-L/AF-L Button | 321 |
| f7: Assign BKT Button..... | 322 |
| f8: Customize Command Dials | 322 |
| f9: Release Button to Use Dial..... | 324 |
| f10: No Memory Card?..... | 324 |
| f11: Reverse Indicators | 324 |
| Y The Setup Menu: Camera Setup..... | 325 |
| Format Memory Card | 326 |
| LCD Brightness..... | 326 |
| Image Dust Off Ref Photo | 327 |
| Video Mode | 329 |
| HDMI..... | 329 |
| Flicker Reduction..... | 330 |
| Time Zone and Date | 330 |
| Language | 331 |
| Image Comment | 331 |
| Auto Image Rotation | 332 |
| Battery Info | 333 |
| Image Authentication | 334 |
| Copyright Information | 335 |
| Save/Load Settings..... | 336 |
| Virtual Horizon | 338 |
| AF Fine Tune | 339 |
| Firmware Version | 340 |
| ☑ The Retouch Menu: Creating Retouched Copies | 341 |
| D-Lighting..... | 344 |
| Red-Eye Correction..... | 345 |
| Trim | 346 |

| | |
|---|-----|
| Monochrome | 347 |
| Filter Effects | 348 |
| Color Balance | 348 |
| Image Overlay..... | 349 |
| NEF (RAW) Processing..... | 353 |
| Resize | 355 |
| Side-by-Side Comparison | 357 |
|  My Menu: Creating a Custom Menu | 359 |

Technical Notes

365

| | |
|--|-----|
| Compatible Lenses | 366 |
| Other Accessories | 372 |
| Caring for the Camera..... | 377 |
| Storage..... | 377 |
| Cleaning | 377 |
| The Low-Pass Filter | 378 |
| “Clean Now” | 378 |
| “Clean at Startup/Shutdown” | 379 |
| Manual Cleaning..... | 381 |
| Replacing the Focusing Screen..... | 384 |
| Replacing the Clock Battery | 386 |
| Caring for the Camera and Battery: Cautions..... | 388 |
| Defaults | 392 |
| Exposure Program..... | 397 |
| Troubleshooting | 398 |
| Error Messages | 403 |
| Specifications | 408 |
| Calibrating Batteries | 417 |
| Approved Memory Cards | 419 |
| Memory Card Capacity | 420 |
| Battery Life | 423 |
| Index..... | 425 |

For Your Safety

To prevent damage to your Nikon product or injury to yourself or to others, read the following safety precautions in their entirety before using this equipment. Keep these safety instructions where all those who use the product will read them.

The consequences that could result from failure to observe the precautions listed in this section are indicated by the following symbol:



This icon marks warnings. To prevent possible injury, read all warnings before using this Nikon product.

■ ■ WARNINGS

- ⚠ Keep the sun out of the frame**
Keep the sun well out of the frame when shooting backlit subjects. Sunlight focused into the camera when the sun is in or close to the frame could cause a fire.
- ⚠ Do not look at the sun through the viewfinder**
Viewing the sun or other strong light source through the viewfinder could cause permanent visual impairment.
- ⚠ Using the viewfinder diopter control**
When operating the viewfinder diopter control with your eye to the viewfinder, care should be taken not to put your finger in your eye accidentally.
- ⚠ Turn off immediately in the event of malfunction**
Should you notice smoke or an unusual smell coming from the equipment or AC adapter (available separately), unplug the AC adapter and remove the battery immediately, taking care to avoid burns. Continued operation could result in injury. After removing the battery, take the equipment to a Nikon-authorized service center for inspection.
- ⚠ Do not disassemble**
Touching the product's internal parts could result in injury. In the event of malfunction, the product should be repaired only by a qualified technician. Should the product break open as the result of a fall or other accident, remove the battery and/or AC adapter and then take the product to a Nikon-authorized service center for inspection.

⚠ Do not use in the presence of flammable gas

Do not use electronic equipment in the presence of flammable gas, as this could result in explosion or fire.

⚠ Keep out of reach of children

Failure to observe this precaution could result in injury.

⚠ Do not place the strap around the neck of an infant or child

Placing the camera strap around the neck of an infant or child could result in strangulation.

⚠ Observe proper precautions when handling batteries

Batteries may leak or explode if improperly handled. Observe the following precautions when handling batteries for use in this product:

- Use only batteries approved for use in this equipment.
- Use only CR1616 lithium batteries to replace the clock battery. Using another type of battery could cause an explosion. Dispose of used batteries as directed.
- Do not short or disassemble the battery.
- Be sure the product is off before replacing the battery. If you are using an AC adapter, be sure it is unplugged.
- Do not attempt to insert the battery upside down or backwards.
- Do not expose the battery to flame or to excessive heat.

- Do not immerse in or expose to water.
- Replace the terminal cover when transporting the battery. Do not transport or store the battery with metal objects such as necklaces or hairpins.
- Batteries are prone to leakage when fully discharged. To avoid damage to the product, be sure to remove the battery when no charge remains.
- When the battery is not in use, attach the terminal cover and store in a cool, dry place.
- The battery may be hot immediately after use or when the product has been used on battery power for an extended period. Before removing the battery turn the camera off and allow the battery to cool.
- Discontinue use immediately should you notice any changes in the battery, such as discoloration or deformation.

⚠ Observe proper precautions when handling the quick charger

- Keep dry. Failure to observe this precaution could result in fire or electric shock.
- Dust on or near the metal parts of the plug should be removed with a dry cloth. Continued use could result in fire.
- Do not handle the power cable or go near the charger during thunderstorms. Failure to observe this precaution could result in electric shock.
- Do not damage, modify, or forcibly tug or bend the power cable. Do not place it under heavy objects or expose it to heat or flame. Should the insulation be damaged and the wires become exposed, take the power cable to a Nikon-authorized service representative for inspection. Failure to observe this precaution could result in fire or electric shock.
- Do not handle the plug or charger with wet hands. Failure to observe this precaution could result in electric shock.
- Do not use with travel converters or adapters designed to convert from one voltage to another or with DC-to-AC inverters. Failure to observe this precaution could damage the product or cause overheating or fire.

⚠ Use appropriate cables

When connecting cables to the input and output jacks, use only the cables provided or sold by Nikon for the purpose to maintain compliance with product regulations.

⚠ CD-ROMs

CD-ROMs containing software or manuals should not be played back on audio CD equipment. Playing CD-ROMs on an audio CD player could cause hearing loss or damage the equipment.

⚠ Observe caution when using the flash

- Using optional flash units in close contact with the skin or other objects could cause burns.
- Using optional flash units close to the subject's eyes could cause temporary visual impairment. Particular care should be observed when photographing infants, when the flash should be no less than one meter (39 in.) from the subject.

⚠ Avoid contact with liquid crystal

Should the monitor break, care should be taken to avoid injury due to broken glass and to prevent the liquid crystal from the monitor touching the skin or entering the eyes or mouth.

Notices

- No part of the manuals included with this product may be reproduced, transmitted, transcribed, stored in a retrieval system, or translated into any language in any form, by any means, without Nikon's prior written permission.
- Nikon reserves the right to change the specifications of the hardware and software described in these manuals at any time and without prior notice.
- Nikon will not be held liable for any damages resulting from the use of this product.
- While every effort has been made to ensure that the information in these manuals is accurate and complete, we would appreciate it were you to bring any errors or omissions to the attention of the Nikon representative in your area (address provided separately).

Notices for Customers in Canada

CAUTION

This Class B digital apparatus complies with Canadian ICES-003.

ATTENTION

Cet appareil numérique de la classe B est conforme à la norme NMB-003 du Canada.

Notices for Customers in Europe

CAUTION

RISK OF EXPLOSION IF BATTERY IS REPLACED BY AN INCORRECT TYPE. DISPOSE OF USED BATTERIES ACCORDING TO THE INSTRUCTIONS.

This symbol indicates that this product is to be collected separately.

The following apply only to users in European countries:

- This product is designated for separate collection at an appropriate collection point. Do not dispose of as household waste.
- For more information, contact the retailer or the local authorities in charge of waste management.



This symbol on the battery indicates that the battery is to be collected separately.



The following apply only to users in European countries:

- All batteries, whether marked with this symbol or not, are designated for separate collection at an appropriate collection point. Do not dispose of as household waste.
- For more information, contact the retailer or the local authorities in charge of waste management.

Notices for Customers in the U.S.A.

The Battery Charger

IMPORTANT SAFETY INSTRUCTIONS—SAVE THESE INSTRUCTIONS

DANGER—TO REDUCE THE RISK OF FIRE OR ELECTRIC SHOCK, CAREFULLY FOLLOW THESE INSTRUCTIONS

For connection to a supply not in the U.S.A., use an attachment plug adapter of the proper configuration for the power outlet if needed. This power unit is intended to be correctly oriented in a vertical or floor mount position.

Federal Communications Commission (FCC) Radio Frequency Interference Statement

This equipment has been tested and found to comply with the limits for a Class B digital device, pursuant to Part 15 of the FCC rules. These limits are designed to provide reasonable protection against harmful interference in a residential installation. This equipment generates, uses, and can radiate radio frequency energy and, if not installed and used in accordance with the instructions, may cause harmful interference to radio communications. However, there is no guarantee that interference will not occur in a particular installation. If this equipment does cause harmful interference to radio or television reception, which can be determined by turning the equipment off and on, the user is encouraged to try to correct the interference by one or more of the following measures:

- Reorient or relocate the receiving antenna.
- Increase the separation between the equipment and receiver.
- Connect the equipment into an outlet on a circuit different from that to which the receiver is connected.
- Consult the dealer or an experienced radio/television technician for help.



Nikon
D3S

CAUTIONS

Modifications

The FCC requires the user be notified that any changes or modifications made to this device that are not expressly approved by Nikon Corporation may void the user's authority to operate the equipment.

Interface Cables

Use the interface cables sold or provided by Nikon for your equipment. Using other interface cables may exceed the limits of Class B Part 15 of the FCC rules.

Notice for Customers in the State of California

WARNING: Handling the cord on this product may expose you to lead, a chemical known to the State of California to cause birth defects or other reproductive harm. *Wash hands after handling.*

Nikon Inc., 1300 Walt Whitman Road,
Melville, New York 11747-3064, U.S.A.
Tel.: 631-547-4200

Disposing of Data Storage Devices

Please note that deleting images or formatting memory cards or other data storage devices does not completely erase the original image data. Deleted files can sometimes be recovered from discarded storage devices using commercially available software, potentially resulting in the malicious use of personal image data. Ensuring the privacy of such data is the user's responsibility.

Before discarding a data storage device or transferring ownership to another person, erase all data using commercial deletion software, or format the device and then completely refill it with images containing no private information (for example, pictures of empty sky). Be sure to also replace any pictures selected for preset manual. Care should be taken to avoid injury when physically destroying data storage devices.

Notice Concerning Prohibition of Copying or Reproduction

Note that simply being in possession of material that has been digitally copied or reproduced by means of a scanner, digital camera, or other device may be punishable by law.

• Items prohibited by law from being copied or reproduced

Do not copy or reproduce paper money, coins, securities, government bonds, or local government bonds, even if such copies or reproductions are stamped "Sample."

The copying or reproduction of paper money, coins, or securities which are circulated in a foreign country is prohibited.

Unless the prior permission of the government has been obtained, the copying or reproduction of unused postage stamps or post cards issued by the government is prohibited.

The copying or reproduction of stamps issued by the government and of certified documents stipulated by law is prohibited.

• Cautions on certain copies and reproductions

The government has issued cautions on copies or reproductions of securities issued by private companies (shares, bills, checks, gift certificates, etc.), commuter passes, or coupon tickets, except when a minimum of necessary copies are to be provided for business use by a company. Also, do not copy or reproduce passports issued by the government, licenses issued by public agencies and private groups, ID cards, and tickets, such as passes and meal coupons.

• Comply with copyright notices

The copying or reproduction of copyrighted creative works such as books, music, paintings, woodcuts, prints, maps, drawings, movies, and photographs is governed by national and international copyright laws. Do not use this product for the purpose of making illegal copies or to infringe copyright laws.

Use Only Nikon Brand Electronic Accessories

Nikon cameras are designed to the highest standards and include complex electronic circuitry. Only Nikon brand electronic accessories (including battery chargers, batteries, AC adapters, and flash accessories) certified by Nikon specifically for use with this Nikon digital camera are engineered and proven to operate within the operational and safety requirements of this electronic circuitry.

The use of non-Nikon electronic accessories could damage the camera and may void your Nikon warranty. The use of third-party rechargeable Li-ion batteries not bearing the Nikon holographic seal shown at right could interfere with normal operation of the camera or result in the batteries overheating, igniting, rupturing, or leaking.

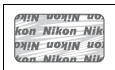

For more information about Nikon brand accessories, contact a local authorized Nikon dealer.

Before Taking Important Pictures

Before taking pictures on important occasions (such as at weddings or before taking the camera on a trip), take a test shot to ensure that the camera is functioning normally. Nikon will not be held liable for damages or lost profits that may result from product malfunction.

Life-Long Learning

As part of Nikon's "Life-Long Learning" commitment to ongoing product support and education, continually-updated information is available on-line at the following sites:

- For users in the U.S.A.: <http://www.nikonusa.com/>
- For users in Europe and Africa: <http://www.europe-nikon.com/support/>
- For users in Asia, Oceania, and the Middle East: <http://www.nikon-asia.com/>

Visit these sites to keep up-to-date with the latest product information, tips, answers to frequently-asked questions (FAQs), and general advice on digital imaging and photography. Additional information may be available from the Nikon representative in your area. See the following URL for contact information: <http://imaging.nikon.com/>



Introduction



This chapter covers information you will need to know before using the camera, including the names of camera parts.

| | |
|---|-----------|
| Overview | 2 |
| Getting to Know the Camera | 3 |
| Camera Body | 3 |
| The Top Control Panel..... | 8 |
| The Rear Control Panel | 10 |
| The Viewfinder Display | 12 |
| The Information Display..... | 14 |
| The Camera Strap | 18 |
| The BS-2 Accessory Shoe Cover | 18 |
| Quick Start Guide | 19 |

Overview

Thank you for your purchase of a Nikon single-lens reflex (SLR) digital camera. Please be sure to read all instructions thoroughly to get the most from the camera, and keep them where they will be read by all those who use the product.



Use Only Nikon Brand Accessories

Only Nikon brand accessories certified by Nikon specifically for use with your Nikon digital camera are engineered and proven to operate within its operational and safety requirements. THE USE OF NON-NIKON ACCESSORIES COULD DAMAGE YOUR CAMERA AND MAY VOID YOUR NIKON WARRANTY.

Servicing the Camera and Accessories

The camera is a precision device and requires regular servicing. Nikon recommends that the camera be inspected by the original retailer or a Nikon-authorized service representative once every one to two years, and that it be serviced once every three to five years (note that fees apply to these services). Frequent inspection and servicing are particularly recommended if the camera is used professionally. Any accessories regularly used with the camera, such as lenses or optional flash units, should be included when the camera is inspected or serviced.

Camera Settings





The explanations in this manual assume that default settings are used.

Getting to Know the Camera

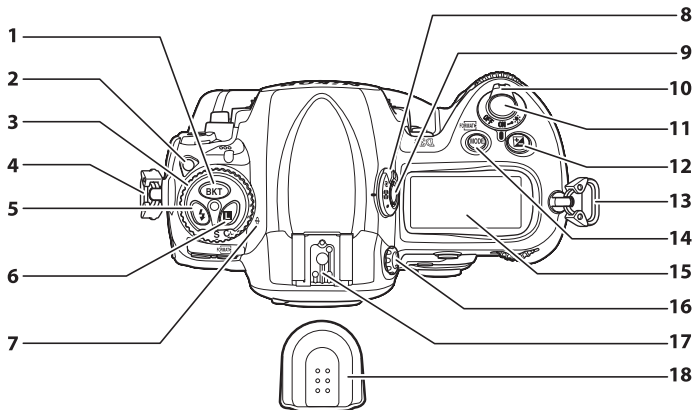
Take a few moments to familiarize yourself with camera controls and displays. You may find it helpful to bookmark this section and refer to it as you read through the rest of the manual.

Camera Body



| | |
|--|---|
| 1 BKT (bracketing) button..... 137, 141, 145, 204, 322 | 11 Shutter-release button49, 50 |
| 2 Release mode dial lock release..... 103 | 12  (exposure compensation) button..... 134 |
| 3 Release mode dial..... 103 | 13 Eyelet for camera strap..... 18 |
| 4 Eyelet for camera strap..... 18 | 14 MODE (exposure mode) button..... 120, 122, 123, 125 |
| 5  (flash mode) button..... 194 | FORMATT (format) button..... 39 |
| 6  (command lock) button..... 130, 131 | 15 Top control panel.....8 |
| 7 Focal plane mark ()..... 100 | 16 Diopter adjustment control..... 41 |
| 8 Metering selector..... 117 | 17 Accessory shoe (for optional flash unit)..... 18, 186 |
| 9 Metering selector lock button..... 117 | 18 Accessory shoe cover..... 18, 186, 390 |
| 10 Power switch.....10, 43 | |



Camera Body (Continued)

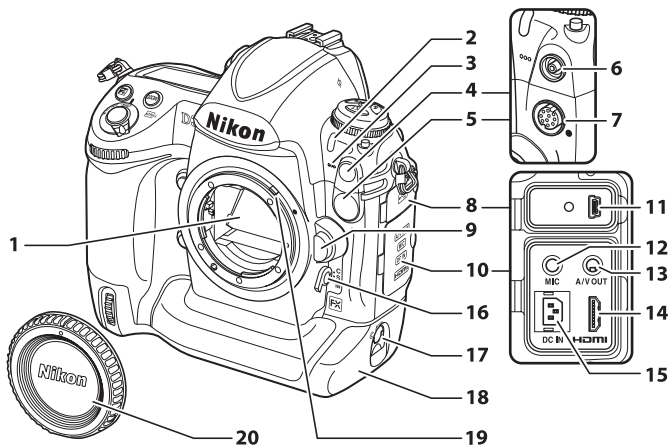

| | | | | | |
|-----------|------------------------------------|----------|-----------|--|---------|
| 1 | Mirror | 108, 381 | 12 | Connector for external microphone | 71 |
| 2 | Self-timer lamp | 107 | 13 | Audio/video (A/V) connector | 269 |
| 3 | Microphone (for movies)..... | 67, 71 | 14 | HDMI mini-pin connector | 271 |
| 4 | Flash sync terminal cover..... | 186 | 15 | DC-IN connector for optional EH-6 AC adapter | 372 |
| 5 | Ten-pin remote terminal cover..... | 217, 376 | 16 | Focus-mode selector | 90, 99 |
| 6 | Flash sync terminal | 186 | 17 | Battery-chamber cover latch..... | 28 |
| 7 | Ten-pin remote terminal ... | 217, 376 | 18 | Battery-chamber cover | 28 |
| 8 | USB connector cover | 255, 259 | 19 | Meter coupling lever | 411 |
| 9 | Lens release button | 32 | 20 | Body cap..... | 31, 375 |
| 10 | Connector cover..... | 269, 271 | | | |
| 11 | USB connector | 255, 259 | | | |

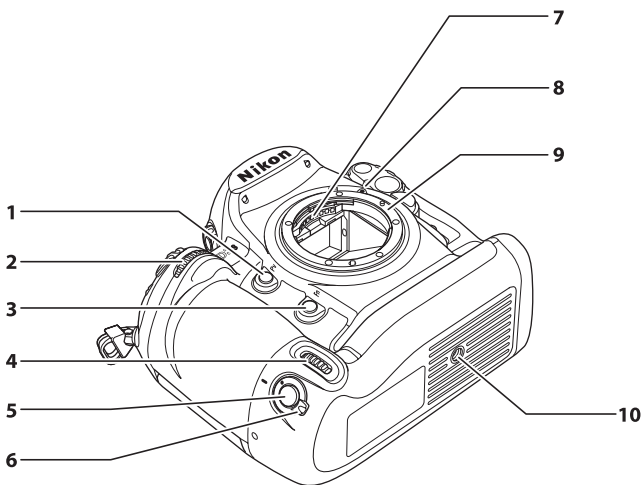

- 1** **Pv** (depth-of-field preview) button 67, 119, 321
- 2** Sub-command dial 222, 322
- 3** **Fn** button 82, 197, 316
- 4** Sub-command dial for vertical shooting 320
- 5** Shutter-release button for vertical shooting 320

- 6** Vertical shooting shutter-release button lock 320
- 7** CPU contacts
- 8** Mounting index 32
- 9** Lens mount 32, 100
- 10** Tripod socket

✓ The Microphone and Speaker

Do not place the microphone or speaker in close proximity to magnetic devices. Failure to observe this precaution could affect the data recorded on the magnetic devices.

Camera Body (Continued)

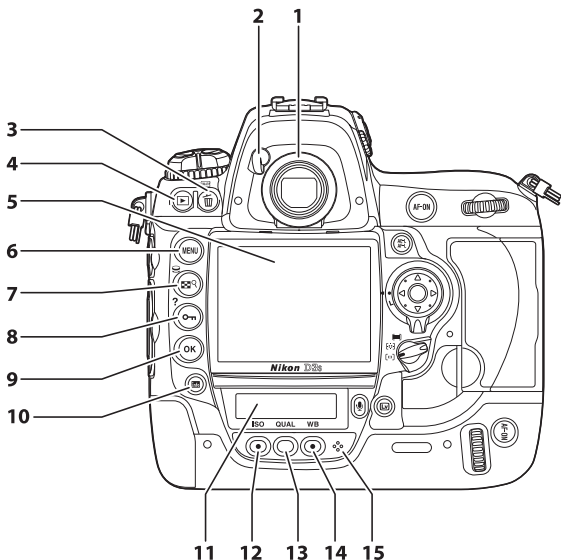

| | | | | | |
|-----------|---------------------------------|-------------|-----------|--|---------------|
| 1 | Viewfinder eyepiece..... | 42 | 11 | Rear control panel..... | 10, 309 |
| 2 | Eyepiece shutter lever..... | 42 | 12 | ISO (ISO sensitivity) button..... | 110 |
| 3 | ☒ (delete) button | 52, 240 | | Two-button reset button | 200 |
| 4 | FORMAT (format) button..... | 39 | 13 | QUAL (image quality/size) | |
| 5 | Monitor..... | 51, 53, 222 | | button | 84, 86 |
| 6 | MENU (menu) button | 22, 273 | 14 | WB (white balance) | |
| 7 | ☑ (playback) button | 51, 222 | | button | 151, 156, 157 |
| 8 | ☑ (protect) button | 238 | | Two-button reset button | 200 |
| 9 | OK (OK) button | 23 | 15 | Microphone | |
| 10 | Info (info) button | 14 | | (for voice memos) | 246 |

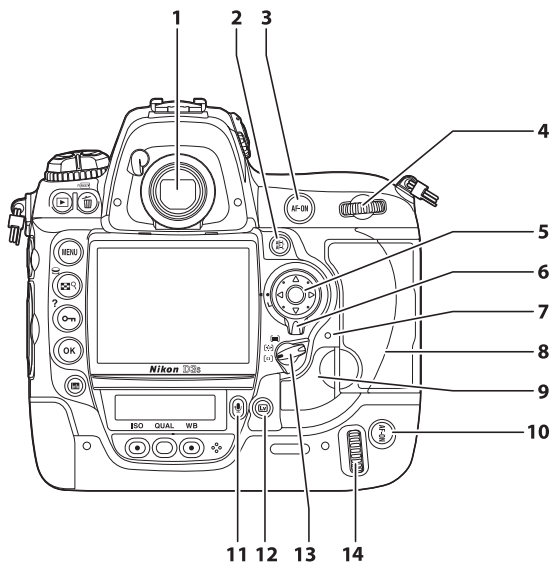

| | |
|---|---|
| 1 Viewfinder..... 41 | 9 Card slot cover release button (under cover)..... 36 |
| 2 $\overline{AE-L/AF-L}$ (AE/AF lock) button96, 97, 321 | 10 AF-ON (AF-ON) button for vertical shooting301 |
| 3 AF-ON (AF-ON) button 56, 67, 91 | 11 \overline{M} (microphone) button 247, 248 |
| 4 Main command dial 222, 322 | 12 \overline{Lv} (live view) button 55, 59, 66 |
| 5 Multi selector 23 | 13 AF-area mode selector..... 92 |
| 6 Focus selector lock..... 94 | 14 Main command dial for vertical shooting 320 |
| 7 Memory card access lamp38, 50 | |
| 8 Memory card slot cover36, 38 | |



The Top Control Panel

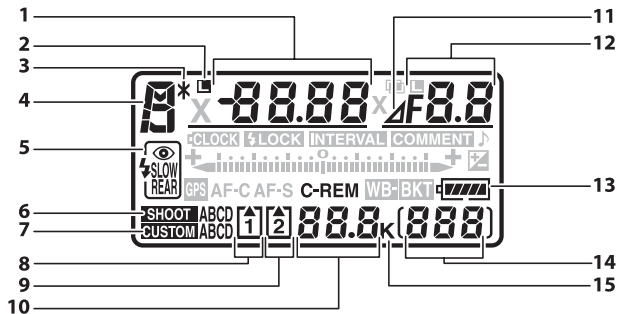

| | |
|---|---|
| <p>1 Shutter speed 122, 126 Exposure compensation value 134 Number of shots in exposure and flash bracketing sequence 137 Number of shots in WB bracketing sequence 141 Number of intervals for interval timer photography 211 Focal length (non-CPU lenses) 216 ISO sensitivity 110</p> | <p>10 Number of exposures remaining ... 44 Number of shots remaining before memory buffer fills 105 Capture mode indicator 257</p> |
| <p>2 Shutter-speed lock icon 130</p> | <p>11 Aperture stop indicator 124, 369</p> |
| <p>3 Flexible program indicator 121</p> | <p>12 Aperture (f-number) 123, 126 Aperture (number of stops) ... 124, 369 Bracketing increment 138, 142 Number of shots in ADL bracketing sequence 145 Number of shots per interval 211 Maximum aperture (non-CPU lenses) 216 PC mode indicator 257</p> |
| <p>4 Exposure mode 118</p> | <p>13 Battery indicator 43</p> |
| <p>5 Flash mode 193</p> | <p>14 Frame count 44 Preset white balance recording indicator 160 Manual lens number 216</p> |
| <p>6 Shooting menu bank 285</p> | <p>15 "K" (appears when memory remains for over 1000 exposures) 44</p> |
| <p>7 Custom settings bank 294</p> | |
| <p>8 Memory card indicator (slot 1) 37, 39</p> | |
| <p>9 Memory card indicator (slot 2) 37, 39</p> | |

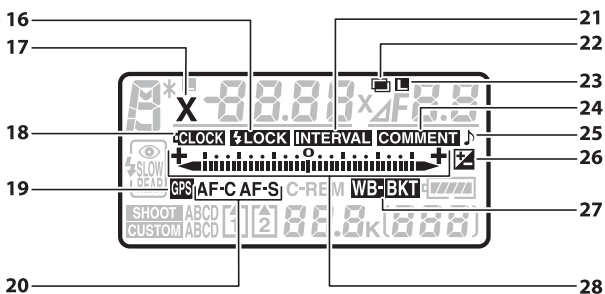

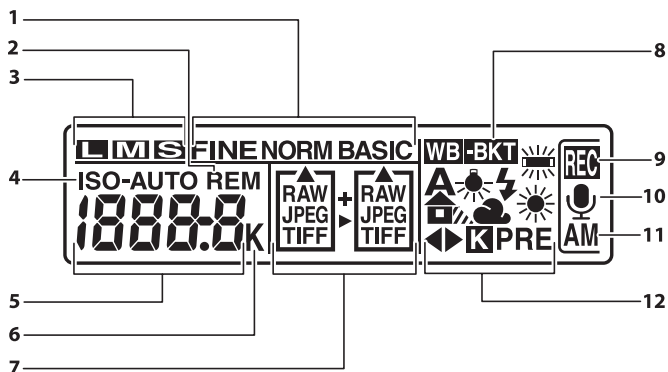

| | | | |
|---|---------|--|-----|
| 16 FV lock indicator | 197 | 27 Exposure and flash bracketing indicator | 137 |
| 17 Flash sync indicator..... | 311 | WB bracketing indicator..... | 141 |
| 18 Clock battery indicator | 35, 386 | ADL bracketing indicator | 145 |
| 19 GPS connection indicator | 219 | 28 Exposure indicator | 127 |
| 20 Focus mode indicator | 90 | Exposure compensation indicator | 134 |
| 21 Interval timer indicator | 211 | Bracketing progress indicator: Exposure and flash bracketing... | 137 |
| 22 Multiple exposure indicator..... | 203 | WB bracketing..... | 141 |
| 23 Aperture lock icon | 131 | ADL bracketing | 145 |
| Multiple exposure (series) indicator | 204 | PC connection indicator | 257 |
| 24 Image comment indicator..... | 331 | Tilt indicator..... | 318 |
| 25 "Beep" indicator..... | 306 | | |
| 26 Exposure compensation indicator..... | 134 | | |

The Rear Control Panel



LCD Illuminators

Rotating the power switch toward  activates the exposure meters and the control panel backlights (LCD illuminator), allowing the displays to be read in the dark. After the power switch is released, the illuminators will remain lit for six seconds while the exposure meters are active or until the shutter is released or the power switch is rotated toward  again.

Power switch

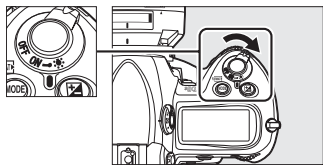

| | | | | | |
|----------|---|-----|-----------|--|----------|
| 1 | Image quality (JPEG images) | 84 | 6 | “K” (appears when memory remains for over 1000 exposures) | 44 |
| 2 | “Remaining” indicator | 309 | | Color temperature indicator | 157 |
| 3 | Image size | 86 | 7 | Memory card slot indicators | 88 |
| 4 | ISO sensitivity indicator | 110 | | Image quality | 84 |
| | Auto ISO sensitivity indicator | 113 | 8 | White balance bracketing indicator | 141 |
| 5 | ISO sensitivity | 110 | 9 | Voice memo recording indicator (shooting mode) | 247 |
| | ISO sensitivity (high/low gain) | 111 | 10 | Voice memo status indicator | 249, 250 |
| | Number of exposures remaining | 44 | 11 | Voice memo recording mode | 247 |
| | Length of voice memo | 249 | 12 | White balance | 151 |
| | White balance fine-tuning | 156 | | White balance fine-tuning indicator | 156 |
| | White balance preset number | 167 | | | |
| | Color temperature | 157 | | | |
| | PC mode indicator | 257 | | | |



The Viewfinder Display

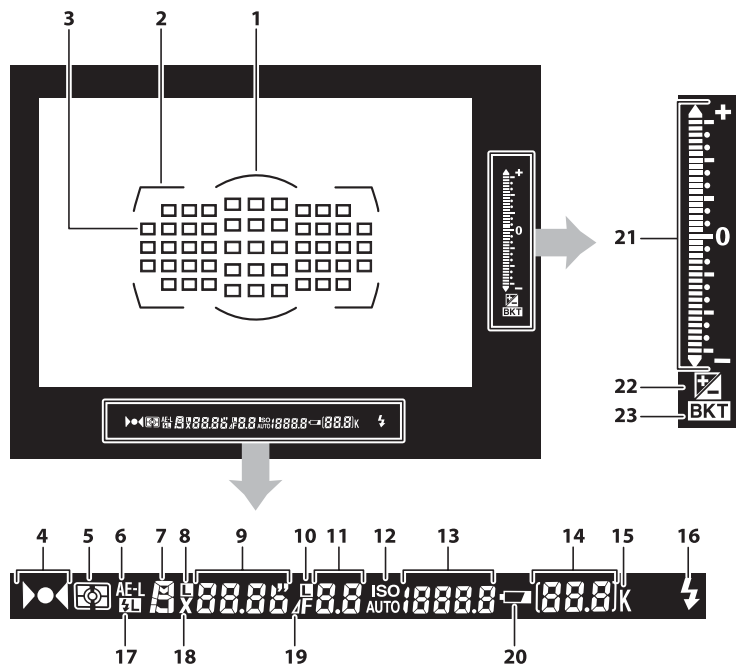

| | | | | | |
|---|--|--------------|----|-------------------------------|----------|
| 1 | 12-mm reference circle for center-weighted metering..... | 116 | 6 | Autoexposure (AE) lock | 132 |
| 2 | AF area brackets | 41, 59 | 7 | Exposure mode..... | 118 |
| 3 | Focus points | 94, 299, 300 | 8 | Shutter speed lock icon | 130 |
| | Spot metering targets..... | 116 | 9 | Shutter speed..... | 122, 126 |
| 4 | Focus indicator | 49, 100 | 10 | Aperture lock icon..... | 131 |
| 5 | Metering..... | 116 | | | |

| | |
|---|---|
| <p>11 Aperture (f-number) 123, 126 Aperture (number of stops) 124, 369</p> <p>12 ISO sensitivity indicator 110 Auto ISO sensitivity indicator 113</p> <p>13 ISO sensitivity 110</p> <p>14 Frame count 309 Number of exposures remaining 44 Number of shots remaining before memory buffer fills 49, 105 Preset white balance recording indicator 160 Exposure compensation value ... 134 PC mode indicator 257</p> | <p>15 "K" (appears when memory remains for over 1000 exposures) 44</p> <p>16 Flash-ready indicator * 197, 412</p> <p>17 FV lock indicator 197</p> <p>18 Flash sync indicator 311</p> <p>19 Aperture stop indicator 124</p> <p>20 Battery indicator 43</p> <p>21 Exposure indicator 127 Exposure compensation display 134 Tilt indicator 318</p> <p>22 Exposure compensation indicator 134</p> <p>23 Exposure and flash bracketing indicator 137</p> |
|---|---|



* Displayed when an optional flash unit is attached (☐ 187). The flash-ready indicator lights when the flash is charged.

☑ No Battery

When the battery is totally exhausted or no battery is inserted, the display in the viewfinder will dim. This is normal and does not indicate a malfunction. The viewfinder display will return to normal when a fully-charged battery is inserted.

☑ The Control Panel and Viewfinder Displays

The brightness of the control panel and viewfinder displays varies with temperature, and the response times of the displays may drop at low temperatures. This is normal and does not indicate a malfunction.

The Information Display

Shooting information, including shutter speed, aperture, frame count, number of exposures remaining, and AF-area mode, is displayed in the monitor when the **info** button is pressed.

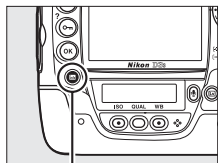



info button

Turning the Monitor Off

To clear shooting information from the monitor, press the **info** button twice more or press the shutter-release button halfway. The monitor will turn off automatically if no operations are performed for about 10 seconds. The information display can be restored by pressing the **info** button.

See Also

For information on choosing how long the monitor stays on, see Custom Setting c4 (**Monitor off delay**,  306). For information on changing the color of the lettering in the information display, see Custom Setting d6 (**Information display**,  309).

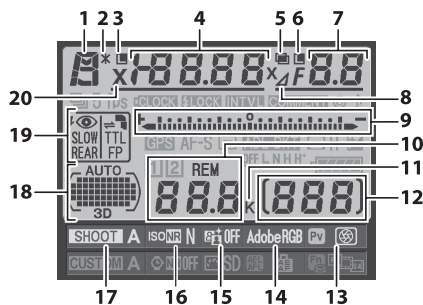

| | | | | | |
|----------|-------------------------------------|----------|-----------|-------------------------------------|--------------|
| 1 | Exposure mode | 118 | 9 | Exposure indicator | 127 |
| 2 | Flexible program indicator..... | 121 | | Exposure compensation indicator ... | 134 |
| 3 | Shutter-speed lock icon | 130 | | Bracketing progress indicator: | |
| 4 | Shutter speed | 122, 126 | | Exposure and flash bracketing.... | 137 |
| | Exposure compensation value | 134 | | WB bracketing..... | 141 |
| | Number of shots in exposure and | | | ADL bracketing | 145 |
| | flash bracketing sequence | 137 | 10 | Number of exposures | |
| | Number of shots in WB bracketing | | | remaining | 44 |
| | sequence | 141 | 11 | "K" (appears when memory | |
| | Focal length (non-CPU lenses) | 216 | | remains for over 1000 | |
| 5 | Multiple exposure indicator..... | 203 | | exposures)..... | 44 |
| 6 | Aperture lock icon | 131 | 12 | Frame count | 44 |
| | Multiple exposure (series) | | | Manual lens number | 216 |
| | indicator..... | 204 | 13 | Pv button assignment | 82, 119, 321 |
| 7 | Aperture (f-number) | 123, 126 | 14 | Color space indicator..... | 183 |
| | Aperture (number of stops).... | 124, 369 | 15 | Active D-Lighting indicator | 182 |
| | Bracketing increment | 138, 142 | 16 | High ISO noise reduction | |
| | Number of shots in ADL bracketing | | | indicator | 291 |
| | sequence | 145 | 17 | Shooting menu bank | 285 |
| | Maximum aperture | | 18 | Auto-area AF indicator..... | 93 |
| | (non-CPU lenses) | 216 | | Focus points indicator..... | 94 |
| 8 | Aperture stop indicator..... | 124 | | AF-area mode indicator..... | 93 |
| | | | | 3D-tracking indicator | 93, 297 |
| | | | 19 | Flash mode | 193 |
| | | | 20 | Flash sync indicator | 311 |

The Information Display (Continued)

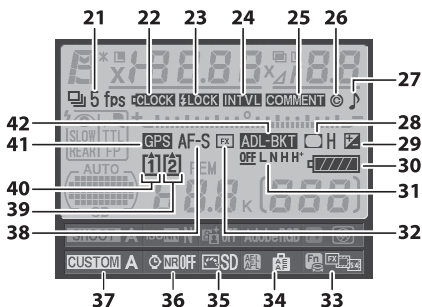

| | | | |
|-----------|--|-----------|---|
| 21 | Release mode (single frame/ continuous) indicator 102 | 33 | Fn button assignment316 |
| | Continuous shooting speed 104, 307 | 34 | AE-L/AF-L button assignment321 |
| 22 | Clock battery indicator35, 386 | 35 | Picture Control indicator 171 |
| 23 | FV lock indicator 197 | 36 | Long exposure noise reduction indicator291 |
| 24 | Interval timer indicator 211 | 37 | Custom settings bank294 |
| 25 | Image comment indicator..... 331 | 38 | Focus mode indicator.....90 |
| 26 | Copyright information indicator 335 | 39 | Memory card indicator (slot 2) 37, 39 |
| 27 | "Beep" indicator 306 | 40 | Memory card indicator (slot 1) 37, 39 |
| 28 | Vignette control indicator 290 | 41 | GPS connection indicator.....219 |
| 29 | Exposure compensation indicator 134 | 42 | Exposure and flash bracketing indicator137 |
| 30 | Battery indicator43 | | WB bracketing indicator141 |
| 31 | ADL bracketing amount 146 | | ADL bracketing indicator 145 |
| 32 | Image area indicator.....79 | | |

■ Changing Settings in the Information Display

To change settings for the items listed below, press the **Info** button in the information display. Highlight items using the multi selector and press **OK** to view options for the highlighted item.

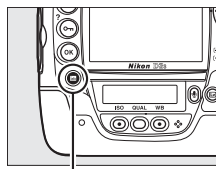

Info button

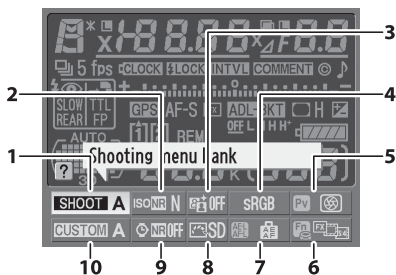

| | | | |
|--|-----|---|-----|
| 1 Shooting menu bank..... | 285 | 6 Fn button assignment..... | 316 |
| 2 High ISO noise reduction..... | 291 | 7 AE-L/AF-L button assignment..... | 321 |
| 3 Active D-Lighting..... | 181 | 8 Picture Control..... | 170 |
| 4 Color space..... | 183 | 9 Long exposure noise | |
| 5 Pv button assignment | 321 | reduction | 291 |
| | | 10 Custom settings bank..... | 294 |

Tool Tips

A tool tip giving the name of the selected item appears in the information display. Tool tips can be turned off using Custom Setting d7 (**Screen tips**; 310).

Viewing Button Assignments

Pv, **Fn**, and icons indicate the “button press” function (316, 321) performed respectively by the **Pv** button, **Fn** button, and **AE-L/AF-L** button. The “button+command dials” functions (318) are indicated by , , and icons. If separate functions have been assigned to “button press” and “button + command dials,” the latter assignment can be viewed by pressing the button.

The Camera Strap

Attach the camera strap securely to the two eyelets on the camera body as shown below.

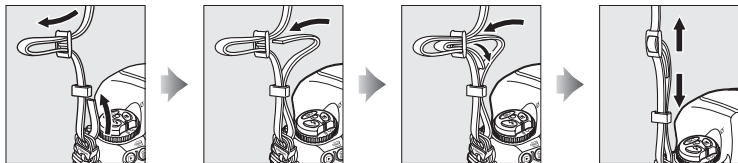

The BS-2 Accessory Shoe Cover

The supplied BS-2 accessory shoe cover can be used to protect the accessory shoe or to prevent light reflected from the metal parts of the shoe from appearing in photographs. The BS-2 attaches to the camera accessory shoe as shown at right.

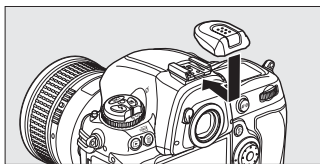

To remove the accessory shoe cover, hold it down with your thumb and slide it off as shown at right while keeping a firm grip on the camera.

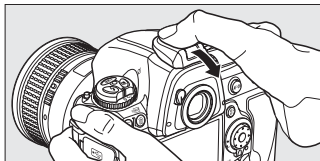

Quick Start Guide

Follow these steps for a quick start with the D3S.

1 Charge the battery (📖 26).

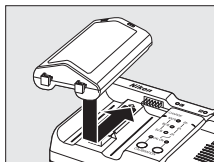

2 Insert the battery (📖 28).

Attach the battery-chamber cover before inserting the battery.

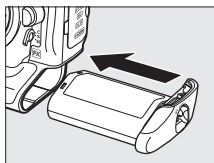

3 Attach a lens (📖 31).

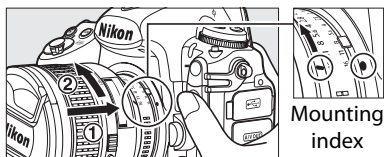

4 Insert a memory card (📖 36).

Back

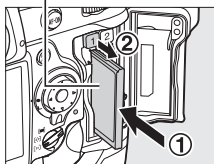

5 Turn the camera on (📖 43).

For information on choosing a language and setting the time and date, see page 33. See page 41 for information on adjusting viewfinder focus.

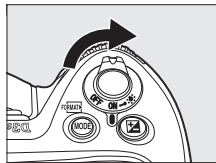

6 Select single-servo autofocus (📖 47, 90).

Rotate the focus-mode selector to **S** (single-servo autofocus).

7 Focus and shoot (📖 49, 50).

Press the shutter-release button halfway to focus, then press the shutter-release button the rest of the way down to take the photograph.

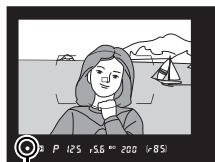

Focus indicator

8 View the photograph (📖 51).

▶ button

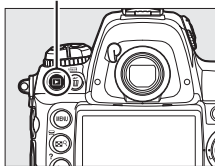



Tutorial

This section describes how to use the camera menus, how to ready the camera for use, and how to take your first pictures and play them back.



| | |
|---|-----------|
| Camera Menus | 22 |
| Using Camera Menus | 23 |
| Help | 25 |
| First Steps | 26 |
| Charge the Battery | 26 |
| Insert the Battery | 28 |
| Attach a Lens | 31 |
| Basic Setup | 33 |
| Insert a Memory Card | 36 |
| Format the Memory Card | 39 |
| Adjust Viewfinder Focus | 41 |
| Basic Photography and Playback | 43 |
| Turn the Camera On | 43 |
| Adjust Camera Settings | 46 |
| Focus and Shoot | 49 |
| Viewing Photographs | 51 |
| Deleting Unwanted Photographs | 52 |

Camera Menu

Most shooting, playback, and setup options can be accessed from the camera menu. To view the menus, press the **MENU** button.

MENU button

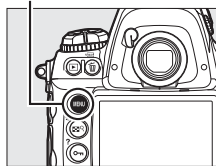

Tabs

Choose from the following menus:

- **Playback** (📖 274)
- **Shooting** (📖 284)
- **Custom Settings** (📖 292)
- **Setup** (📖 325)
- **Retouch** (📖 341)
- **My Menu or Recent settings** (defaults to **My Menu**; 📖 359)

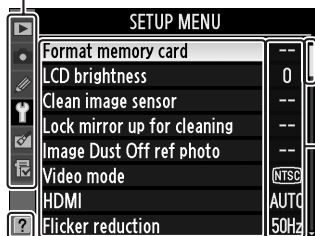

Slider shows position in current menu.

Current settings are shown by icons.

Menu options

Options in current menu.



If icon is displayed, help for current item can be viewed by pressing button (📖 25).

Using Camera Menus

Menu Controls

The multi selector and **OK** button are used to navigate the menus.

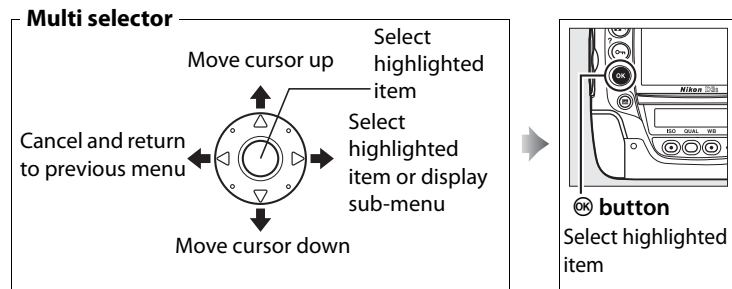

Navigating the Menus

Follow the steps below to navigate the menus.

1 Display the menus.

Press the **MENU** button to display the menus.

MENU button

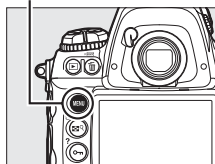

2 Highlight the icon for the current menu.

Press **◀** to highlight the icon for the current menu.



3 Select a menu.

Press ▲ or ▼ to select the desired menu.

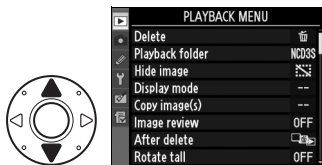

4 Position the cursor in the selected menu.

Press ► to position the cursor in the selected menu.

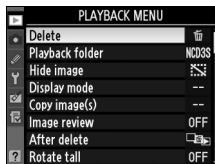

5 Highlight a menu item.

Press ▲ or ▼ to highlight a menu item.

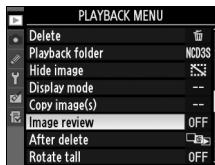

6 Display options.

Press ► to display options for the selected menu item.



7 Highlight an option.

Press ▲ or ▼ to highlight an option.



8 Select the highlighted item.

Press **OK** to select the highlighted item. To exit without making a selection, press the **MENU** button.

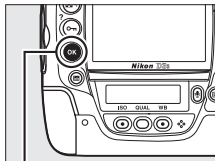

OK button



Note the following points:

- Menu items that are displayed in gray are not currently available.
- While pressing **▶** or the center of the multi selector generally has the same effect as pressing **OK**, there are some cases in which selection can only be made by pressing **OK**.
- To exit the menus and return to shooting mode, press the shutter-release button halfway (□ 50).

Help

If a **?** icon is displayed at the bottom left corner of the monitor, help can be displayed by pressing the **Q** (?) button.

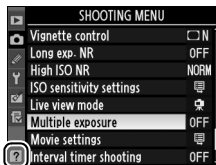

A description of the currently selected option or menu will be displayed while the button is pressed. Press **▲** or **▼** to scroll through the display.

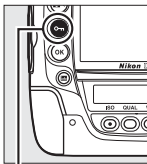

Q (?) button

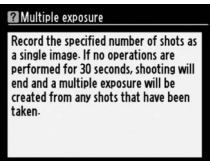

First Steps

Charge the Battery

The D3S is powered by an EN-EL4a rechargeable Li-ion battery (supplied). To maximize shooting time, charge the battery in the supplied MH-22 quick charger before use. About two hours and twenty-five minutes are required to fully recharge the battery when no charge remains.



1 Plug the charger in.

Insert the AC adapter plug into the battery charger and plug the power cable into an electrical outlet.

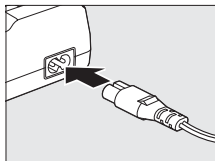

2 Remove the terminal cover.

Remove the terminal cover from the battery.



3 Remove the contact protector.

Remove the contact protector from the quick charger battery chamber.

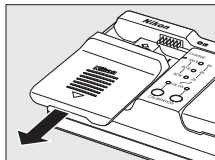

4 Charge the battery.

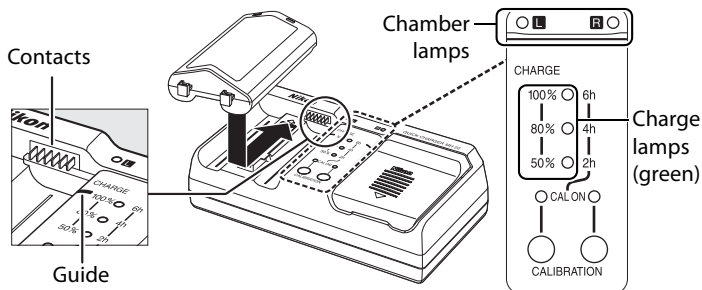

Insert the battery (terminals first), aligning the end of the battery with the guide and then sliding the battery in the direction indicated until it clicks into place. The chamber lamp and charge lamps will blink while the battery charges:

| Charge state | Chamber lamp | Charge lamps | | |
|--|--------------|--------------|------------|------------|
| | | 50% | 80% | 100% |
| Less than 50% of maximum capacity | ⚡ (blinks) | ⚡ (blinks) | ● (off) | ● (off) |
| 50–80% of maximum capacity | ⚡ (blinks) | ○ (glows) | ⚡ (blinks) | ● (off) |
| More than 80% but less than 100% of maximum capacity | ⚡ (blinks) | ○ (glows) | ○ (glows) | ⚡ (blinks) |
| 100% of maximum capacity | ○ (glows) | ● (off) | ● (off) | ● (off) |

Charging is complete when the chamber lamp stops blinking and the charge lamps turn off. About two hours and twenty-five minutes are required to fully charge an exhausted battery.

5 Remove the battery when charging is complete.

Remove the battery and unplug the charger.

✓ Calibration

See page 417 for more information on calibration.

Insert the Battery

1 Turn the camera off.

Power switch

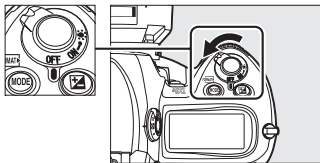

✓ Inserting and Removing Batteries

Always turn the camera off before inserting or removing batteries.

2 Remove the battery-chamber cover.

Lift the battery-chamber cover latch, turn it to the open (Ⓢ) position (①) and remove the BL-4 battery-chamber cover (②).

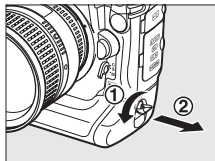

3 Attach the cover to the battery.

If the battery release is positioned so that the arrow (◀) is visible, slide the battery release to cover the arrow. Insert the two projections on the battery into the matching slots in the cover and slide the battery release to reveal the arrow.

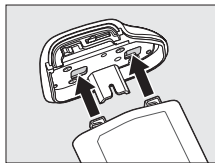
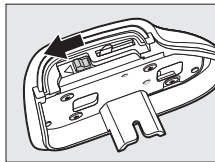

✓ The BL-4 Battery-Chamber Cover

The battery can be charged with the BL-4 attached. To prevent dust from accumulating inside the battery chamber when the battery is not inserted, slide the battery release in the direction indicated by the arrow (◀), remove the BL-4 from the battery, and replace it on the camera. The BL-1 battery-chamber cover for D2-series cameras can not be used.

4 Insert the battery.

Insert the battery as shown at right.

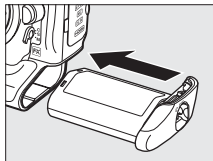

5 Latch the cover.

To prevent the battery from becoming dislodged during operation, rotate the latch to the closed position and fold it down as shown at right. Be sure the cover is securely latched.

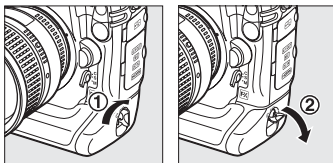

EN-EL4a Rechargeable Li-ion Batteries

The supplied EN-EL4a shares information with compatible devices, enabling the camera to show battery charge state in six levels (□ 43). The **Battery info** option in the setup menu details battery charge, battery life, and the number of pictures taken since the battery was last charged (□ 333). The battery can be recalibrated as necessary to ensure that battery level continues to be reported accurately (□ 417).

The Battery and Charger

Read and follow the warnings and cautions on pages xviii–xx and 388–391 of this manual.

Do not use the battery at ambient temperatures below 0 °C (32 °F) or above 40 °C (104 °F). Charge indoors at ambient temperatures in the vicinity of 5–35°C (41–95 °F); for best results, charge the battery at temperatures above 20 °C (68 °F). Battery capacity may temporarily drop if the battery is charged at low temperatures or used at a temperature below the temperature at which it was charged. If the battery is charged at a temperature below 5 °C (41 °F), the battery life indicator in the **Battery info** (📖 333) display may show a temporary decrease.

The battery may be hot immediately after use. Wait for the battery to cool before recharging.

Use the charger with compatible batteries only. Unplug when not in use.

Compatible Batteries

The camera can also be used with EN-EL4 rechargeable Li-ion batteries.

Removing the Battery

Before removing the battery, turn the camera off, lift the battery-chamber cover latch, and turn it to the open (🔓) position. To prevent short-circuits, replace the terminal cover when the battery is not in use.

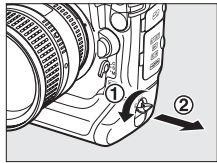

Attach a Lens

Care should be taken to prevent dust from entering the camera when the lens is removed. An AF Nikkor 85 mm f/1.4D IF lens is used in this manual for illustrative purposes.

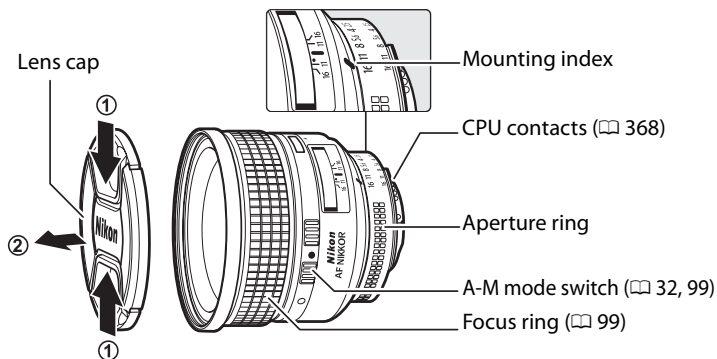

1 Turn the camera off.

2 Remove the rear lens cap and the camera body cap.

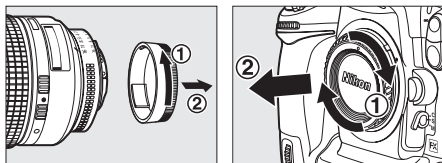

3 Attach the lens.

Keeping the mounting index on the lens aligned with the mounting index on the camera body, position the lens in the camera's bayonet mount

(1). Being careful not to press the lens-release button, rotate the lens counter-clockwise until it clicks into place (2).

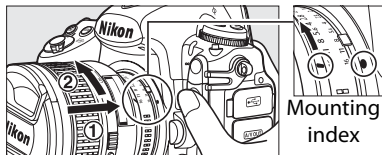

If the lens is equipped with an **A-M** or **M/A-M** switch, select **A** (autofocus) or **M/A** (autofocus with manual priority).



■ Detaching the Lens

Be sure the camera is off when removing or exchanging lenses. To remove the lens, press and hold the lens release button (1) while turning the lens clockwise (2). After removing the lens, replace the lens caps and camera body cap.

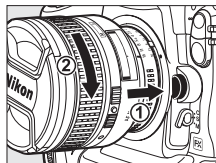

✓ CPU Lenses with Aperture Rings

In the case of CPU lenses equipped with an aperture ring (368), lock aperture at the minimum setting (highest f-number).

✍ Image Area

The DX format image area is automatically selected when a DX lens is attached (78).



Image area

Basic Setup

The language option in the setup menu is automatically highlighted the first time menus are displayed. Choose a language and set the time and date.

1 Turn the camera on.

Power switch

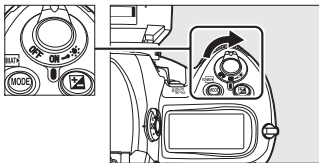

2 Select Language in the setup menu.

Press **MENU** to display the camera menus, then select **Language** in the setup menu. For information on using menus, see “Using Camera Menus” (p 23).

MENU button

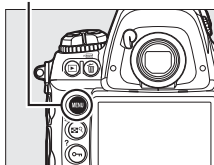

3 Select a language.

Press **▲** or **▼** to highlight the desired language and press **OK**.



4 Select Time zone and date.

Select **Time zone and date** and press ►.

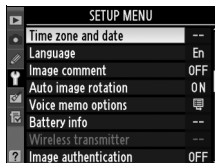

5 Set time zone.

Select **Time zone** and press ►. Press ◀ or ▶ to highlight the local time zone (the **UTC** field shows the difference between the selected time zone and Coordinated Universal Time, or UTC, in hours) and press OK.

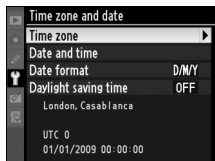

6 Turn daylight saving time on or off.

Select **Daylight saving time** and press ►. Daylight saving time is off by default; if daylight saving time is in effect in the local time zone, press ▲ to highlight **On** and press OK.

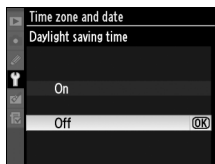

7 Set the date and time.

Select **Date and time** and press ►. Press ◀ or ▶ to select an item, ▲ or ▼ to change. Press OK when the clock is set to the current date and time.



8 Set date format.

Select **Date format** and press **▶**. Press **▲** or **▼** to choose the order in which the year, month, and day will be displayed and press **OK**.

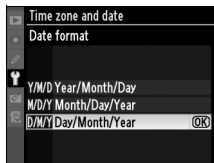

9 Exit to shooting mode.

Press the shutter-release button halfway to exit to shooting mode.



The **LOCK** Icon

If a flashing **LOCK** icon appears in the top control panel the first time the camera is used, check that clock settings (including time zone and daylight saving time) are correct. The icon disappears when the **OK** button is pressed to exit the menu.

The Clock Battery

The camera clock is powered by a separate, non-rechargeable CR1616 lithium battery with a life of about four years. When this battery is exhausted, a **LOCK** icon will be displayed in the top control panel while the exposure meters are on. For information on replacing the clock battery, see page 386.

The Camera Clock

The camera clock is less accurate than most watches and household clocks. Check the clock regularly against more accurate time pieces and reset as necessary.

GPS Units (☞ 217)

If a GPS unit (☞ 376) is connected, the camera clock will be set to the time and date provided by the GPS unit (☞ 220).

Nikon Transfer

If the camera is connected to a computer, the supplied Nikon Transfer software can be used to synchronize the camera clock with the computer (Mac OS X version 10.5.7 excluded). Nikon Transfer can be installed from the supplied Software Suite CD.

Insert a Memory Card

The camera stores photographs on Type I CompactFlash memory cards (available separately; □ 419). Type II cards and microdrives can not be used. Up to two memory cards can be inserted in the camera simultaneously. The following section describes how to insert and format a memory card.

1 Turn the camera off.

Power switch

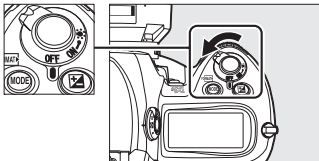

Inserting and Removing Memory Cards

Always turn the camera off before inserting or removing memory cards.

2 Open the card slot cover.

Open the door protecting the card-slot cover release button (1) and press the release button (2) to open the card slot (3).

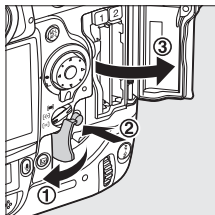

Memory Card Slots

Slot 1 is for the main card; the card in slot 2 plays a backup or secondary role. If the default setting of **Overflow** is selected for **Slot 2** (📖 88) when two memory cards are inserted, the card in slot 2 will only be used when the card in slot 1 is full.

The card currently in use is indicated in the top control panel and information display (the illustrations at right show the displays when two cards are inserted).

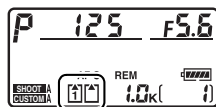
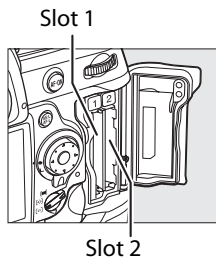

Top control panel

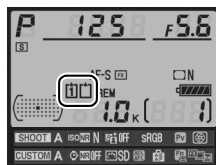

Information display

3 Insert the memory card.

Insert the first memory card in slot 1. Slot 2 should be used only if a card is already inserted in slot 1. Insert the memory card with the rear label toward the monitor (①). When the memory card is fully inserted, the eject button will pop up (②) and the green access lamp will light briefly.

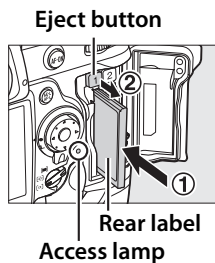

Eject button
Rear label
Access lamp

✔ Inserting Memory Cards

Insert the memory card terminals first. Inserting the card upside down or backwards could damage the camera or the card. Check to be sure that the card is in the correct orientation.

Direction of insertion

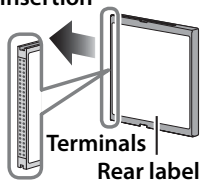

4 Close the card slot cover.

If this is the first time the memory card will be used after being used or formatted in another device, format the card as described on page 39.

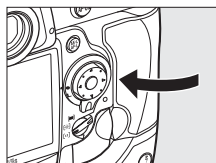

■ Removing Memory Cards

1 Turn the camera off.

Confirm that the access lamp is off and turn the camera off.

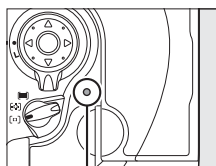

Access lamp

2 Remove the memory card.

Open the memory card slot cover (①) and press the eject button (②) to partially eject the card (③). The memory card can then be removed by hand. Do not push on the memory card while pressing the eject button. Failure to observe this precaution could damage the camera or memory card.

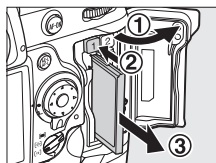

Format the Memory Card

Memory cards must be formatted before first use or after being used or formatted in other devices.





Formatting Memory Cards

Formatting memory cards permanently deletes any data they may contain.

Be sure to copy any photographs and other data you wish to keep to a computer before proceeding (□ 254).



1 Turn the camera on.

2 Press the buttons.

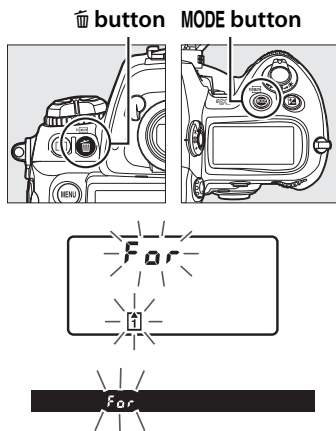
Hold the  (MODE and ) buttons down simultaneously until a blinking **F o r** appears in the shutter-speed displays in the top control panel and viewfinder. If two memory cards are inserted, the card in slot 1 (□ 37) will be selected; you can choose the card in slot 2 by rotating the main command dial. To exit without formatting the memory card, wait until **F o r** stops blinking (about six seconds) or press any button other than the  (MODE and ) buttons.



3 Press the buttons again.

Press the  (MODE and ) buttons together a second time while **F o r** is blinking to format the memory card. *Do not remove the memory card or remove or disconnect the power source during formatting.*

When formatting is complete, the top control panel and viewfinder will show the number of photographs that can be recorded at current settings and the frame-count displays will show 1.

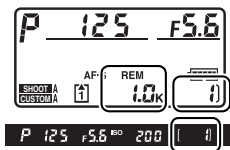

Memory Cards

- Memory cards may be hot after use. Observe due caution when removing memory cards from the camera.
- Turn the power off before inserting or removing memory cards. Do not remove memory cards from the camera, turn the camera off, or remove or disconnect the power source during formatting or while data are being recorded, deleted, or copied to a computer. Failure to observe these precautions could result in loss of data or in damage to the camera or card.
- Do not touch the card terminals with your fingers or metal objects.
- Do not bend, drop, or subject to strong physical shocks.
- Do not apply force to the card casing. Failure to observe this precaution could damage the card.
- Do not expose to water, high levels of humidity, or direct sunlight.

No Memory Card

If no memory card is inserted, the top control panel and viewfinder will show (-E-). If the camera is turned off with a charged EN-EL4a battery and no memory card inserted, (-E-) will be displayed in the top control panel.

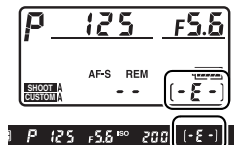

See Also

See page 326 for information on formatting memory cards using the **Format memory card** option in the setup menu.

Adjust Viewfinder Focus

The camera is equipped with diopter adjustment to accommodate individual differences in vision. Check that the display in the viewfinder is in focus before shooting.

1 Turn the camera on.

Remove the lens cap and turn the camera on.

2 Lift the diopter adjustment control (1).

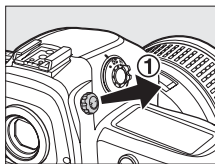

3 Focus the viewfinder.

Rotate the diopter adjustment control (2) until the viewfinder display, focus points, and AF area brackets are in sharp focus.

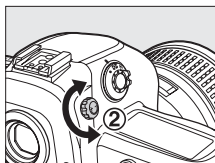

AF area brackets



Focus point



4 Replace the diopter adjustment control.

Push the diopter adjustment control back in (3).

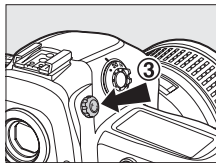

Diopter-Adjustment Viewfinder Lenses

Corrective lenses (available separately; □ 373) can be used to further adjust viewfinder diopter. Before attaching a diopter-adjustment viewfinder lens, remove the DK-17 viewfinder eyepiece by closing the viewfinder shutter to release the eyepiece lock (1) and then unscrewing the eyepiece as shown at right (2).

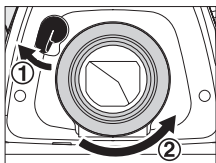

Basic Photography and Playback

Turn the Camera On

Before taking photographs, turn the camera on and check the battery level and number of exposures remaining as described below.

1 Turn the camera on.

Turn the camera on. The control panels will turn on and the display in the viewfinder will light.

Power switch

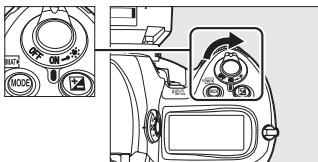

2 Check the battery level.

Check the battery level in the top control panel or viewfinder.

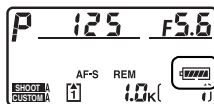

| Icon * | | Description | |
|---------------|------------|--|-------------------------------|
| Control panel | Viewfinder | | |
| | — | Battery fully charged. | |
| | — | | |
| | — | | Battery partially discharged. |
| | — | | |
| | | Low battery. Prepare to charge battery or ready spare battery. | |
| | | Shutter release disabled. Charge or exchange battery. | |

* No icon displayed when camera is powered by optional EH-6 AC adapter.



3 Check the number of exposures remaining.

The top control panel shows the number of photographs that can be taken at current settings. When this number reaches zero,  and **FULL** icons will flash in the top control panel and a flashing **FuL** icon will appear in the viewfinder as shown at right. No further pictures can be taken until you delete pictures or insert a new memory card. You may be able to take additional pictures at lower image quality or size settings.

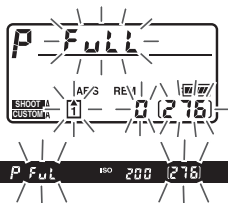
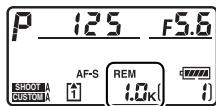

Large-Capacity Memory Cards

When enough memory remains on the memory card to record a thousand or more pictures at current settings, the number of exposures remaining will be shown in thousands, rounded down to the nearest hundred (e.g., if there is room for approximately 1,260 exposures, the exposure count display will show 1.2 K).

The Battery Indicator

If the segments in the top control panel battery icon blink on and off, the camera is calculating the battery charge. The battery level will be displayed in about three seconds.

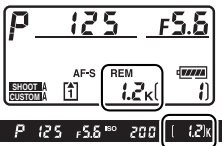

Auto Meter Off

The shutter speed and aperture displays in the top control panel and viewfinder will turn off if no operations are performed for about six seconds (auto meter off), reducing the drain on the battery. Press the shutter-release button halfway to reactivate the display in the viewfinder (☞ 50).

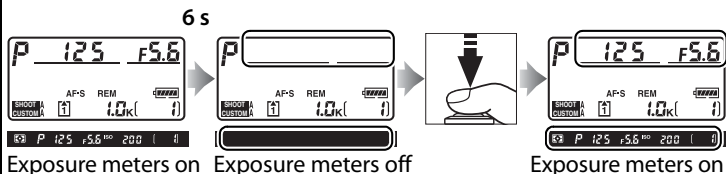

The length of time before the exposure meters turn off automatically can be adjusted using Custom Setting c2 (**Auto meter-off delay**, ☞ 305).

Camera Off Display

If the camera is turned off with a battery and memory card inserted, the memory card icon, frame count, and number of exposures remaining will be displayed (some memory cards may in rare cases only display this information when the camera is on).

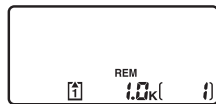

Top control panel

Adjust Camera Settings

This tutorial describes the basic steps involved in taking photos.

1 Choose exposure mode *P*.

Press the **MODE** button and rotate the main command dial to select exposure mode *P*. The camera will automatically adjust shutter speed and aperture for optimal exposure in most situations.

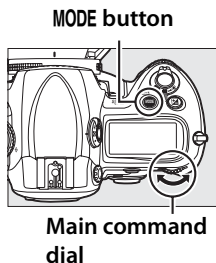

2 Choose single frame release mode.

Hold the release mode dial lock release down and turn the release mode dial to **S** (single frame). At this setting, the camera will take one photograph each time the shutter-release button is pressed.

Release mode dial
lock release

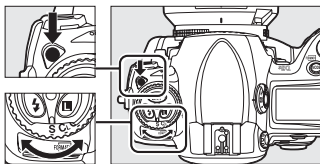

3 Choose single-point AF.

Rotate the AF-area mode selector until it clicks into place pointing to [•] (single-point AF). At this setting, the user can choose the focus point.

AF-area mode selector

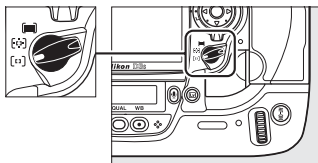

Focus point

4 Choose single-servo autofocus.

Rotate the focus-mode selector until it clicks into place pointing to S (single-servo autofocus). At this setting, the camera will automatically focus on the subject in the selected focus point when the shutter-release button is pressed halfway. Pictures can only be taken when the camera is in focus.

Focus-mode selector

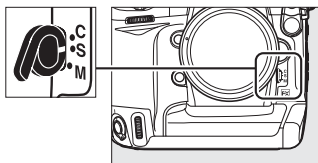

5 Choose matrix metering.

Press the metering selector lock button and rotate the metering selector to  (matrix metering). Matrix metering uses information from the 1,005-pixel RGB sensor to ensure optimal results for the entire frame.

Metering selector

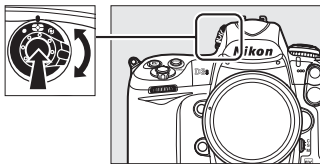

6 Check camera settings.

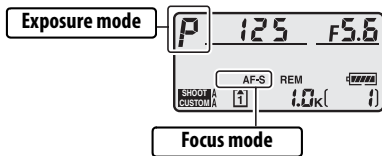

Top control panel



Viewfinder display

Focus and Shoot

1 Press the shutter-release button halfway to focus (📖 50).

At default settings, the camera will focus on the subject in the center focus point. Frame a photo in the viewfinder with the main subject positioned in the center focus point and press the shutter-release button halfway. If the camera is able to focus, the in-focus indicator (●) will appear in the viewfinder.

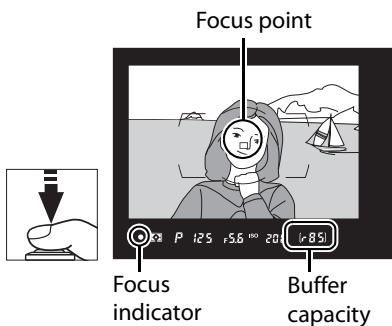

| Viewfinder display | Description |
|--------------------|---|
| ● | Subject in focus. |
| ▶ | Focus point is between camera and subject. |
| ◀ | Focus point is behind subject. |
| ▶◀ (blinks) | Camera unable to focus on subject in focus point using autofocus. |

While the shutter-release button is pressed halfway, focus will lock and the number of exposures that can be stored in the memory buffer ("185"; 📖 105) will be shown in the viewfinder display.



For information on what to do if the camera is unable to focus using autofocus, see "Getting Good Results with Autofocus" (📖 98).

2 Press the shutter-release button the rest of the way down to shoot.

Smoothly press the shutter-release-button the rest of the way down to take the picture.

While the photograph is being recorded to the memory card, the access lamp next to the card slot cover will light. *Do not eject the memory card or remove or disconnect the power source until the lamp has gone out.*

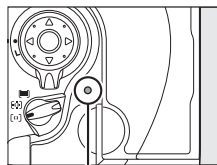

Access lamp



The Shutter-Release Button

The camera has a two-stage shutter-release button. The camera focuses when the shutter-release button is pressed halfway. To take the photograph, press the shutter-release button the rest of the way down.



Focus



Take photograph

Viewing Photographs



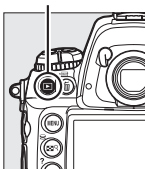

1 Press the button.

A photograph will be displayed in the monitor. The memory card containing the picture currently displayed is shown by an icon.

 button



2 View additional pictures.

Additional pictures can be displayed by pressing  or . To view additional information on the current photograph, press  and  (□ 225).

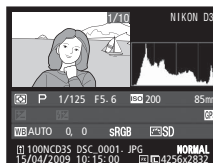

To end playback and return to shooting mode, press the shutter-release button halfway.

Image Review

When **On** is selected for **Image review** in the playback menu (□ 281), photographs are automatically displayed in the monitor after shooting.

See Also

See page 224 for information on choosing a memory card slot.

Deleting Unwanted Photographs

To delete the photograph currently displayed in the monitor, press the  button. Note that photographs can not be recovered once deleted.

1 Display the photograph.

Display the photograph you wish to delete as described in “Viewing Photographs” on the previous page.





2 Delete the photograph.

Press the  button. A confirmation dialog will be displayed (the location of the current picture is shown by the icon in the bottom left corner of the dialog).

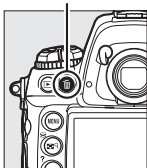
 button



Press the  button again to delete the image and return to playback. To exit without deleting the picture, press .

Delete

To delete multiple images or to select the memory card from which images will be deleted, use the **Delete** option in the playback menu ( 242).



Framing Pictures in the Monitor (Live View)



This chapter describes how to frame pictures in the monitor using live view.



Framing Photographs in the Monitor 54

Framing Photographs in the Monitor

Press the  button to frame pictures in the monitor. The following options are available:

- **Tripod** ( 55). You can zoom in on the image displayed in the monitor for precise focus, making this option suitable for static subjects. Contrast-detect autofocus can be used to compose photographs with the subject positioned anywhere in the frame.
- **Hand-held** ( 59). Camera focuses normally using phase-detection autofocus.

Phase-Detection Versus Contrast-Detect AF

The camera normally uses phase-detection autofocus, in which focus is adjusted based on data from a special focusing sensor. When **Tripod** is selected in live view, however, the camera uses contrast-detect autofocus, in which the camera analyses the data from the image sensor and adjusts focus to produce the greatest contrast. Contrast-detect autofocus takes longer than phase-detection autofocus.

Flicker

You may notice flicker or banding in the monitor during live view or when shooting movies under certain types of lighting, such as fluorescent or mercury-vapor lamps. Flicker and banding can be reduced by choosing a **Flicker reduction** option that matches the frequency of the local AC power supply ( 330).

Tripod Mode (三脚架)

1 Frame a picture in the viewfinder.

With the camera mounted on a tripod or resting on a stable, level surface, frame the subject in the viewfinder.

2 Choose Tripod for Live view mode in the shooting menu.

Press the MENU button and select the shooting menu. Select **Live view mode**, highlight **Tripod**, and press OK.

MENU button

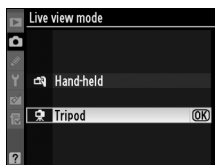
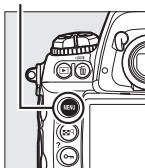

3 Press the Lv button.

The mirror will be raised and the view through the lens will be displayed in the camera monitor instead of the viewfinder.

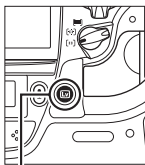

Lv button

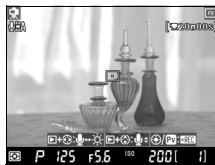

4 Focus.

Autofocus (focus mode **S** or **C**): In tripod mode, the focus point for contrast-detect autofocus can be moved to any point in the frame using the multi selector.

☐ is displayed when the focus point is at the center of the frame except when the view through the lens is zoomed in.



Contrast-detect focus point

To focus using contrast-detect autofocus, press the **AF-ON** button. The focus point will blink green and the monitor may brighten while the camera focuses. If the camera is able to focus using contrast-detect autofocus, the focus point will be displayed in green; if the camera is unable to focus, the focus point will blink red.

AF-ON button

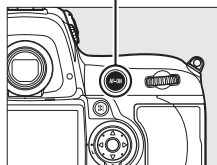

☑ **Contrast-Detect Autofocus**

The camera will not continue to adjust focus while the **AF-ON** button is pressed in continuous-servo autofocus mode. In both single-servo and continuous-servo autofocus modes, the shutter can be released even when the camera is not in focus.

Manual focus (focus mode **M**; ☐ 99): Use zoom for precise focus.

To magnify the view in the monitor up to 13 × and check focus, press the  button and rotate the main command dial. While the view through the lens is zoomed in, a navigation window will appear in the bottom right corner of the display.

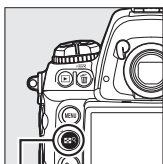

 button

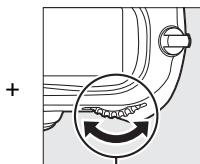

Main command dial





Use the multi selector to scroll to areas of the frame not visible in the monitor.



Exposure Preview

In tripod mode, you can press  to preview the effects of shutter speed, aperture, and ISO sensitivity on exposure during both still photography and movie recording.

Exposure is set using matrix metering and can be adjusted by ± 5 EV ( 134), although only values between -3 and $+3$ EV are reflected in the preview display. Note that the preview may not accurately reflect exposure when an optional flash unit is attached, Active D-Lighting ( 181) or bracketing is in effect, $\times 250$ is selected for shutter speed, or the subject is very bright or dark.

Exposure preview is not available when  is selected for shutter speed.



5 Take the picture.

Press the shutter-release button the rest of the way down to take the picture. The monitor turns off during shooting and turns back on once the photograph is recorded.



6 End live view.

Press the  button to end live view.



Focusing with Contrast-Detect Autofocus

Contrast-detect autofocus will take longer than normal (phase-detection) autofocus. In the following situations, the camera may be unable to focus using contrast-detect autofocus:

- The camera is not mounted on a tripod
- The subject contains lines parallel to the long edge of the frame
- The subject lacks contrast
- The subject in the focus point contains areas of sharply contrasting brightness, or the subject is lit by spot lighting or by a neon sign or other light source that changes in brightness
- Flicker or banding appears under fluorescent, mercury-vapor, sodium-vapor, or similar lighting
- A cross (star) filter or other special filter is used
- The subject appears smaller than the focus point
- The subject is dominated by regular geometric patterns (e.g., blinds or a row of windows in a skyscraper)
- The subject is moving

Note that the focus point may sometimes be displayed in green when the camera is unable to focus.

Use an AF-S lens. The desired results may not be achieved with other lenses or teleconverters.

Remote Cords

If the shutter-release button on a remote cord (available separately; see  376) is pressed halfway for over a second in tripod mode, it will activate contrast-detect autofocus. If the remote cord shutter-release button is pressed all the way down without focusing, focus will not be adjusted before the picture is taken.

Hand-Held Mode (📷)

1 Choose Hand-held for Live view mode in the shooting menu.

Press the MENU button and select the shooting menu. Select **Live view mode**, highlight **Hand-held**, and press OK.

MENU button

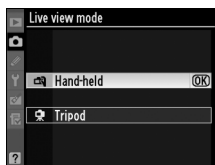
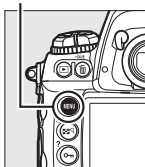

2 Press the LV button.

The mirror will be raised and the view through the lens will be displayed in the camera monitor instead of the viewfinder.

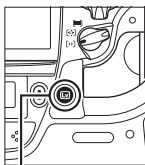

LV button



3 Frame a picture in the monitor.

To magnify the view in the monitor up to 13x, press the  button and rotate the main command dial.

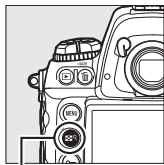

 button

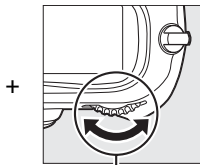

Main command dial



While the view through the lens is zoomed in, a navigation window will appear in the bottom right corner of the display. Use the multi selector to scroll within the AF area brackets.



4 Focus.

Autofocus (focus mode **S** or **C**):

Press the shutter-release button halfway or press the **AF-ON** button. The camera will

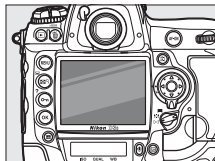

focus normally and set

exposure. Note that the mirror will click back into place while either button is pressed, temporarily interrupting live view.

Live view is restored when the button is released.

Manual focus (focus mode **M**;  99): Focus using the lens focus ring.



5 Take the picture.

Press the shutter-release button the rest of the way down to reset focus and exposure and take the picture. The monitor turns off during shooting and turns back



on once the photograph is recorded.



6 End live view.

Press the  button to end live view.

Shooting in Live View Mode

Although they will not appear in the final picture, flicker, banding, or distortion may be visible in the monitor under fluorescent, mercury vapor, or sodium lamps or if the camera is panned horizontally or if an object moves at high speed through the frame. Bright spots may also appear. When shooting in live view mode, avoid pointing the camera at the sun or other strong light sources. Failure to observe this precaution could result in damage to the camera's internal circuitry.

Noise may be audible when the camera adjusts aperture. Note that no pictures can be taken in live view if a CPU lens with an aperture ring is attached with **Aperture ring** selected for Custom Setting f8 (**Customize command dials**) > **Aperture setting** (□ 323). Select **Sub-command dial** when using a CPU lens with an aperture ring.

Shooting ends automatically if the lens is removed.

Live view mode can be used for up to an hour. Note, however, that when used in live view mode for extended periods, the camera may become noticeably warm and its internal temperature may rise, resulting in noise (randomly-spaced bright pixels or fog). To prevent damage to the camera's internal circuits, shooting will end automatically before the camera overheats. A count-down display will appear in the monitor 30 s before shooting ends. At high ambient temperatures, this display may appear immediately when live view mode is selected.

During live view, the camera displays shutter speed and aperture based on the lighting conditions metered at the start of live view. Exposure is metered again for the current subject when the shutter-release button is pressed all the way down.

A **HiISO** icon in the monitor indicates that **On** is selected for **Movie settings** > **High-sensitivity movie mode** in the shooting menu (□ 72). Live view is adjusted for sensitivities of from ISO 6400 to Hi 3, but photographs are taken at the sensitivity selected for **ISO sensitivity settings** in the shooting menu (□ 110).

Metering can not be changed during live view. Choose a metering method before starting live view. To reduce blur in tripod mode, choose **On** for Custom Setting d9 (**Exposure delay mode**, □ 310). To prevent light entering via the viewfinder from interfering with exposure, close the viewfinder eyepiece shutter (□ 106).



The Information Display

To hide or display indicators in the monitor in live view mode, press the **info** button.

*Virtual horizon**



Information on

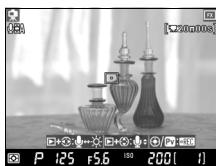

Information off



*Information + histogram (exposure preview only;  57)**

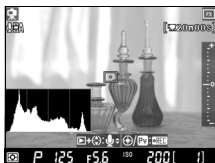

*Framing guides**

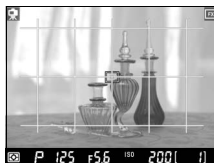

* Not displayed during zoom. Histogram not displayed during zoom or movie recording.

AF area brackets

AF area brackets are displayed only in hand-held mode.

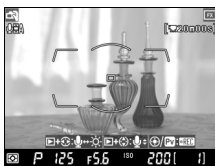

Hand-held









Tripod

✔ No Picture

After shooting, play the picture back in the monitor to ensure that the photograph has been recorded. In hand-held mode, note that the sound the mirror makes when the shutter-release button is pressed halfway or the **AF-ON** button is pressed can be mistaken for the sound of the shutter, and that if single-servo AF is used, a photograph will only be recorded if the camera is able to focus.

🔧 Monitor Brightness

Except during exposure preview, monitor brightness can be adjusted by pressing the  and  button. The brightness indicator at the right of the display will turn yellow; keeping the  button pressed, press  or  to adjust brightness (note that monitor brightness has no effect on pictures taken in live view mode). To return to live view, release the  button.



🔧 HDMI

If live view is used while the camera is attached to an HDMI video device, the camera monitor will turn off and the video device will display the view through the lens as shown at right. Press the **info** button to turn the histogram display on and off during exposure preview ( 57).







Recording and Viewing Movies

This chapter describes how to record movies in live view.



| | |
|-------------------------------|-----------|
| Recording Movies | 66 |
| Viewing Movies | 73 |
| Editing Movies | 74 |

Recording Movies

Movies can be recorded at 24 fps by pressing the **Pv** button in live view mode. If desired, choose a Picture Control (☰ 170) and color space (☰ 183) before recording.

1 Choose a live view mode in the shooting menu.

Press **MENU** and select the shooting menu. Select **Live view mode**, highlight an option, and press **OK**. If **Tripod** is selected, exposure can be previewed in the monitor by pressing **OK** (☰ 57).

MENU button

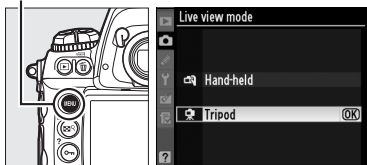

2 Press the **Lv** button.

The mirror is raised and the view through the lens is displayed in the monitor instead of the viewfinder.

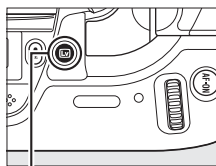

Lv button

Exposure (High-Sensitivity Movie Mode Excluded)

In Hand-held mode, the camera automatically adjusts shutter speed, aperture, and ISO sensitivity for all exposure modes.

In Tripod mode, movies are recorded at the aperture selected by the user (modes **M** and **M**) or the camera (modes **P** and **S**), while shutter speed and ISO sensitivity are controlled by the camera. In mode **M** (☰ 69), you can press **OK** and adjust aperture, shutter speed, and ISO sensitivity in the exposure preview (☰ 57). Exposure preview is not recommended in modes **P** and **S**, as the sound made by the lens when the camera adjusts aperture may be recorded with the movie.



✓ The Icon

A  icon indicates that movies can not be recorded.

3 Focus.

Focus before starting recording.
Frame the opening shot and either press the **AF-ON** button (**Tripod**) or press the shutter-release button halfway (**Hand-held**) to focus on your subject. In hand-held mode, autofocus is not available after recording begins.

AF-ON button

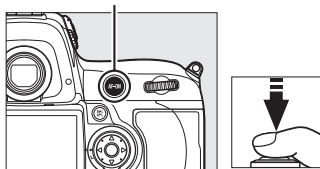

4 Start recording.

Press the **Pv** button or the center of the multi selector to start recording. Both video and monaural sound are recorded; do not cover the microphone during recording (the built-in microphone is located on the front of the camera). The **•REC** icon blinks and the time available is displayed in the monitor. Exposure can be altered by up to ± 3 EV using exposure compensation; note, however, that changes to exposure, including AE lock and exposure compensation, can only be made during exposure preview.

Pv button

•REC icon

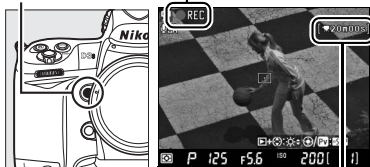

Time remaining

Focusing During Recording

To focus in tripod mode using contrast-detect autofocus, press the **AF-ON** button. Autofocus is not available in hand-held mode after recording begins; use manual focus to focus during recording ( 99; note that in hand-held mode, recording will end if the shutter-release button is pressed halfway or the **AF-ON** button is pressed).

5 End recording.

Press the **Pv** button again to end recording (to end recording and take a still picture in live view, press the shutter-release button all the way down). Recording will end automatically when the maximum size is reached or the memory card is full.

Maximum Size

Individual movie files can be up to 2 GB in size. The maximum length is 5 minutes for movies with a frame size of 1280 × 720, 20 minutes for other movies; note that depending on memory card write speed, shooting may end before this length is reached.









Flicker

You may notice flicker or banding in the monitor during live view or when shooting movies under certain types of lighting, such as fluorescent or mercury-vapor lamps. Flicker and banding can be reduced by choosing a **Flicker reduction** option that matches the frequency of the local AC power supply (□ 330).

See Also

Frame size, microphone sensitivity, high-sensitivity movie mode, and card slot options are available in the **Movie settings** menu (□ 70). The role played by the center of the multi selector (either selecting the center focus point or toggling zoom) can be selected using Custom Setting f1 (**Multi selector center button**; □ 314), and the behavior of the **AE-L/AF-L** button can be adjusted using Custom Setting f6 (**Assign AE-L/AF-L button**; □ 321).

Adjusting Microphone Sensitivity

Microphone sensitivity can be adjusted without leaving live view. Before starting recording, hold the  button and press  or . The microphone settings icon will turn yellow. Keep the  or  button pressed and press  and  to adjust microphone sensitivity.



✓ Recording Movies

Flicker, banding, or distortion may be visible in the monitor and in the final movie under fluorescent, mercury vapor, or sodium lamps or if the camera is panned horizontally or an object moves at high speed through frame. Jagged edges, false colors, moiré, and bright spots may also appear. If a flash or other light source with brief duration is used during recording, bright bands may appear or the top or bottom of the frame may brighten. When recording movies, avoid pointing the camera at the sun or other strong light sources. Failure to observe this precaution could result in damage to the camera's internal circuitry.

Matrix metering is used regardless of the metering method selected. Depending on the brightness of the subject, changes to exposure may have no visible effect. Shutter speed and sensitivity are displayed in live view and during recording, but do not always apply to movies. Note that movies can not be recorded if a CPU lens with an aperture ring is attached with **Aperture ring** selected for Custom Setting f8 (**Customize command dials**) > **Aperture setting** (☐ 323). Select **Sub-command dial** when using a CPU lens with an aperture ring.

Recording ends automatically if the lens is removed.

When used in live view mode for extended periods, the camera's internal temperature may rise, resulting in noise (randomly-spaced bright pixels or fog; the camera may also become noticeably warm, but this does not indicate a malfunction). To prevent damage to the camera's internal circuits, recording will end automatically before the camera overheats. A count-down display will appear in the monitor 30 s before shooting ends. At high ambient temperatures, this display may appear immediately when live view mode is selected.

Sounds made by the camera lens when aperture is adjusted or during focusing may be picked up by the microphone in tripod mode.

✓ Exposure Mode M

When exposure mode **M** is selected in tripod mode, shutter speed, aperture, and ISO sensitivity can be changed in the exposure preview (☐ 66). Note that the expected results will not be achieved at ISO sensitivities below ISO 200 or above ISO 12800 or at shutter speeds slower than $\frac{1}{25}$ s, and that auto ISO sensitivity control and high-sensitivity movie mode should be off.



■ Movie Settings

Adjust movie settings before recording.

1 Select Movie settings in the shooting menu.

Press the **MENU** button to display the menus. Highlight **Movie settings** in the shooting menu and press **▶**.

MENU button

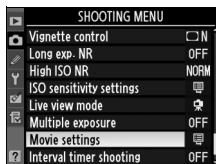
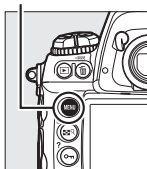

2 Choose movie options.

To choose a frame size, highlight **Quality** and press **▶**. Highlight one of the following options and press **OK** to select:

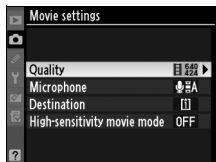

| Option | Frame size (pixels) | Maximum length |
|----------------------------------|---------------------|----------------|
| 1280/720 1280×720 (16:9)* | 1280 × 720 | 5 min. |
| 640/424 640×424 (3:2) | 640 × 424 | 20 min. |
| 320/216 320×216 (3:2) | 320 × 216 | |

* Available only when FX format is selected for **Image area**; if another option is selected, frame size will be 640 × 424.

Frame Size

If the aspect ratio of the crop currently selected for still images differs from that of the movie frame, guides showing the movie frame crop will be displayed during live view when indicators are hidden (62). The area outside the movie frame crop is grayed out during recording.



To turn the built-in or external microphone on or off or to adjust microphone sensitivity, highlight **Microphone** and press ►. To turn sound recording off, highlight **Microphone off** and press Ⓞ. To turn recording on and adjust microphone sensitivity automatically, select **Auto sensitivity (A)**. Selecting any other option turns recording on and sets the microphone to the selected sensitivity.

Using an External Microphone

Instead of the built-in microphone, commercially-available external microphones can be used to avoid picking up sounds produced by the lens during focusing or vibration reduction. Stereo recording is available with any microphone that has a stereo mini-pin jack (3.5 mm diameter).

To choose a destination when using two memory cards, highlight **Destination** and press ►. Select a slot and press Ⓞ. The menu shows the time available on each card; recording ends automatically when no time remains.

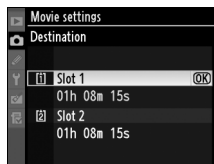

Using a TV as a Monitor

If the camera is connected to a TV using an A/V or HDMI cable, the television can be used as a monitor for live view and movie recording. If an A/V cable is connected when the  button is pressed, the view through the camera lens will be displayed both on the TV and in the camera monitor, but the camera monitor will turn off during movie recording. If an HDMI cable is connected, the camera monitor will remain off during both live view and movie recording.

To adjust ISO sensitivity to suit lighting conditions, highlight **High-sensitivity movie mode** and press **▶**. If lighting is so poor that the subject is difficult to see with the naked eye, highlight **On** and press **OK** to shoot at ISO sensitivities of ISO 6400 to Hi 3 (a **HiISO** icon will be displayed in the monitor). Select **Off** to shoot at ISO sensitivities between ISO 200 and ISO 12800.

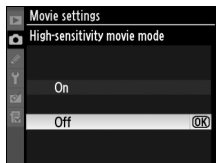

High-Sensitivity Movie Mode

Movies shot at high sensitivities are prone to noise (randomly-spaced bright pixels, fog, or lines) and after-images of light sources and other bright objects. If the subject is brightly lit, highlights may be “washed out” and details may be lost. Check the results in the monitor and turn high-sensitivity movie mode off if necessary. Note that the camera may have difficulty focusing using contrast-detect autofocus.



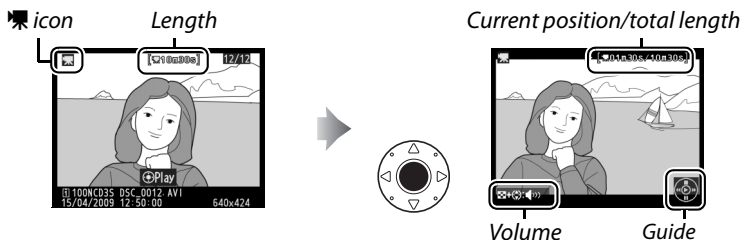

Although **HiISO** is displayed whenever high-sensitivity movie mode is enabled, photographs taken while high-sensitivity movie mode is in effect are shot at the ISO sensitivity selected for **ISO sensitivity** in the shooting menu (📖 110).

Viewing Movies

Movies are indicated by a  icon in full-frame playback (222). Press the center of the multi selector to start playback.



The following operations can be performed:

| To | Use | Description |
|-----------------|---|--|
| Pause | ▼/OK | Pause playback. |
| Play |  | Resume playback when movie is paused or during rewind/advance. |
| Rewind/advance |  | Speed doubles with each press, from 2x to 4x to 8x to 16x; keep pressed to skip to beginning or end of movie. If playback is paused, movie rewinds or advances one frame at a time; keep pressed for continuous rewind or advance. |
| Adjust volume |  | Hold  and press ▲ to increase volume, ▼ to decrease. |
| Trim movie | OK | See page 74 for more information. |
| Resume shooting |  | Monitor turns off. Photographs can be taken immediately. |
| Display menus | MENU | See page 273 for more information. |
| Exit | ▲/▶ | Exit to full-frame playback. |

icon

 is displayed in full-frame and movie playback if the movie was recorded without sound.



Editing Movies

Trim footage to create edited copies of movies or save selected frames as JPEG stills. To view movie retouch options, display a movie in full-frame playback and press **OK**.

Trimming Movies

1 Choose an option.

To trim the opening footage from the copy, highlight **Choose start point** in the edit movie menu and press **OK**. Select **Choose end point** to trim the ending footage.



2 View the movie and choose a starting or end point.

Press the center of the multi selector to start or resume playback, **▼** to pause, and **◀** or **▶** to rewind or advance (73; pause to rewind or advance one frame at a time). To adjust volume, hold **⊞** and press **▲** and **▼**. With the movie paused on the desired frame, press **▲** to delete all frames before (**Choose start point**) or after (**Choose end point**) the selected frame. Starting and ending frames are shown by **▶** and **◀** icons.



3 Save the copy.

Select **Yes** and press **OK** to save the edited copy. If necessary, the copy can be trimmed as described above to remove additional footage. Edited copies are indicated by a  icon in full-frame playback.



Trimming Movies

Movies must be at least two seconds long. The current position will be displayed in red if creating a copy at the current playback position would result in a movie less than two seconds long. The copy will not be saved if there is insufficient space available on the memory card.

To prevent the camera from turning off unexpectedly, use a fully-charged battery when editing movies.

The Retouch Menu

Movies can also be edited from the retouch menu (see 341).

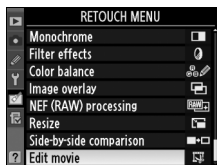

Saving Selected Frames

1 Choose **Save selected frame**.

To save a selected frame as a JPEG still, highlight **Save selected frame** in the edit movie menu and press **OK**.



2 View the movie and choose a frame.

Press the center of the multi selector to start or resume playback, **▼** to pause, and **◀** or **▶** to rewind or advance (☞ 73; pause to rewind or advance one frame at a time). To adjust volume, hold **ⓂR** and press **▲** and **▼**. Starting and ending frames are shown by **▶** and **▶** icons. With the movie paused on the desired frame, press **▲**.



3 Save the selected frame.

Select **Yes** and press **OK** to create a JPEG copy of the selected frame. Movie stills are indicated by a **📷** icon in full-frame playback.

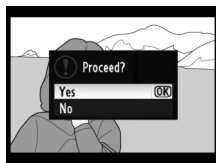

Save Selected Frame

JPEG movie stills created with the **Save selected frame** option can not retouched and lack some categories of photo information (☞ 225).



Image Recording Options

This section describes how to choose image area, quality, and size and how to choose the role played by memory card slot 2.

| | |
|--------------------|----|
| Image Area | 78 |
| Image Quality..... | 83 |
| Image Size..... | 86 |
| Slot 2 | 88 |



Image Area

The camera's FX format (36.0 × 23.9 mm) image sensor can be used to record pictures with an image area (picture angle) equivalent to a 35 mm (135) format film camera. Image area is selected using the **Image area** option in the shooting menu. At

the default setting of **Auto DX crop**, the camera will automatically crop pictures to the DX picture angle when a DX format lens is attached. The **Choose image area** option can be used to select a 35 mm picture angle or to crop photographs to the DX format or 1.2 × picture angle or to a 5 : 4 aspect ratio.



■ ■ Auto DX Crop

Choose whether to automatically select a DX crop when a DX lens is attached.

| Option | Description |
|------------|--|
| On | Camera automatically selects DX crop when DX lens is attached. If another lens is attached, the crop selected for Choose image area will be used. |
| Off | Crop selected for Choose image area is used. |

■ Choose Image Area

Choose the image area used when a non-DX lens is attached or a DX-lens is attached with **Off** selected for **Auto DX crop** (☞ 81).

| Option | Description |
|--|--|
| FX (36×24) FX 1.0× (FX format) | Images are recorded in FX format using the full area of the image sensor (36.0 × 23.9 mm), producing a picture angle equivalent to a NIKKOR lens on a 35mm format camera. The edges of pictures taken with DX format lenses will be blacked out. |
| 1.2× (30×20) 1.2× | A 30.0 × 20.0 mm area at the center of the image sensor is used to record photographs. To calculate the approximate focal length of the lens in 35mm format, multiply by 1.2. The edges of pictures taken with DX format lenses will be blacked out. |
| DX (24×16) DX 1.5× (DX format) | An area at the center of the image sensor 23.5 × 15.6 mm is used to record pictures in DX format. To calculate the approximate focal length of the lens in 35mm format, multiply by 1.5. |
| 5 : 4 (30×24) 5 : 4 | Pictures are recorded with an aspect ratio of 5 : 4 (30.0 × 23.9 mm). The edges of pictures taken with DX format lenses will be blacked out. |

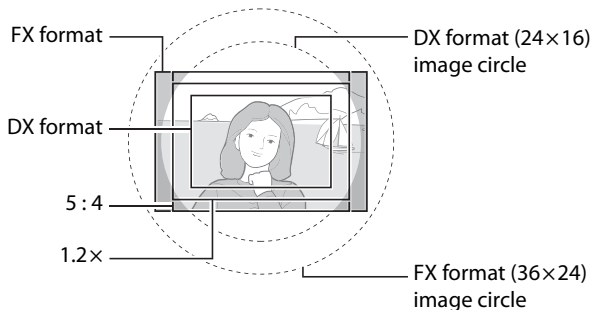
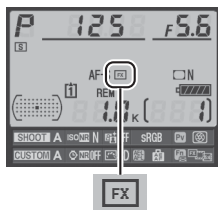

Image Area

The selected option is shown in the information display.



DX Lenses

DX lenses are designed for use with DX format cameras and have a smaller picture angle than lenses for 35mm format cameras. If **Auto DX crop** is off and an option other than **DX (24 × 16)** (DX format) is selected for **Image area** when a DX lens is attached, the edges of the image may be eclipsed. This may not be apparent in the viewfinder, but when the images are played back you may notice a drop in resolution or that the edges of the picture are blacked out.

The Viewfinder Display

The 1.2 ×, DX format, and 5 : 4 crops are shown below.



1.2 ×



DX format



5 : 4

Image area can be set using the **Image area** option in the shooting menu or by pressing the **Fn** button and rotating a command dial.

■ The Image Area Menu

1 Select Image area in the shooting menu.

Press **MENU** to display the menus. Highlight **Image area** in the shooting menu (☞ 284) and press **▶**.

MENU button

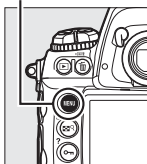

2 Choose an option.

Highlight **Auto DX crop** or **Choose image area** and press **▶**.



3 Adjust settings.

Choose an option and press **OK**. The selected crop is displayed in the viewfinder (☞ 80).

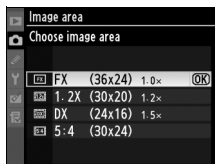

■ The Fn Button

The image area can be selected by pressing the **Fn** button and rotating the main or sub-command dial until the desired crop is displayed in the viewfinder (☞ 80). This operation can not be performed during live view or while a multiple exposure is being recorded.



Fn button

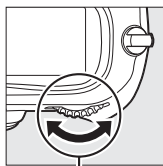

Main command dial

The option currently selected for image area can be viewed by pressing the **Fn** button to display the image area in the top control panel or information display. FX format is displayed as "36×24", 1.2 × as "30×20", DX format as "24×16", and 5 : 4 as "30 × 24".



☑ Auto DX Crop

The **Fn** button can not be used to select image area when a DX lens is attached and **Auto DX crop** is on.

✎ The Fn, Pv, and AE-L/AF-L Buttons

Changes to image area settings can be made using the **Fn** button (Custom Setting f4, **Assign Fn button**; ☞ 316), the **Pv** button (Custom setting f5, **Assign preview button**; ☞ 321), or the **AE-L/AF-L** button (Custom Setting f6, **Assign AE-L/AF-L button**; ☞ 321). Note that some "button press" options can not be combined with options using "+command dials."

✎ Image Size

Image size varies with the option selected for image area.

Image Quality

The D3S supports the following image quality options. See page 420 for information on the number of pictures that can be stored at different image quality and size settings.

| Option | File type | Description |
|---------------------------|--------------|---|
| NEF (RAW) | NEF | RAW data from the image sensor are saved directly to the memory card in Nikon Electronic Format (NEF). Use with images that will be transferred to a computer for printing or processing. |
| TIFF (RGB) | TIFF (RGB) | Record uncompressed TIFF-RGB images at a bit depth of 8 bits per channel (24-bit color). TIFF is supported by a wide variety of imaging applications. |
| JPEG fine | JPEG | Record JPEG images at a compression ratio of roughly 1:4 (fine image quality).* |
| JPEG normal | | Record JPEG images at a compression ratio of roughly 1:8 (normal image quality).* |
| JPEG basic | | Record JPEG images at a compression ratio of roughly 1:16 (basic image quality).* |
| NEF (RAW)+ JPEG fine | NEF/ JPEG | Two images are recorded, one NEF (RAW) image and one fine-quality JPEG image. |
| NEF (RAW)+ JPEG normal | | Two images are recorded, one NEF (RAW) image and one normal-quality JPEG image. |
| NEF (RAW)+ JPEG basic | | Two images are recorded, one NEF (RAW) image and one basic-quality JPEG image. |

* **Size priority** selected for **JPEG compression**.



Image quality is set by pressing the **QUAL** button and rotating the main command dial until the desired setting is displayed in the rear control panel.

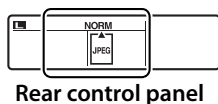
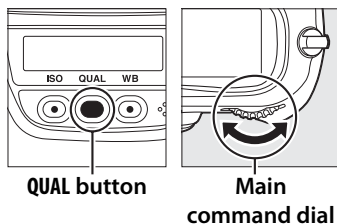

NEF (RAW)

Once transferred to a computer, NEF (RAW) images can only be viewed using ViewNX (available on the supplied Software Suite CD) or Capture NX 2 (available separately; □ 375). JPEG copies of NEF (RAW) images can be created using the **NEF (RAW) processing** option in the retouch menu (□ 353). Note that the option selected for image size does not affect the size of NEF (RAW) images.

NEF (RAW)+JPEG

When photographs taken at settings of NEF (RAW) + JPEG are viewed on the camera with only one memory card inserted, only the JPEG image will be displayed. If both copies are recorded to the same memory card, both copies will be erased when the photo is deleted. If the JPEG copy is recorded to a separate memory card using the **Slot 2 > RAW Slot 1 - JPEG Slot 2** option, deleting the JPEG copy will not delete the NEF (RAW) image.

The Image Quality Menu

Image quality can also be adjusted using the **Image quality** option in the shooting menu (□ 284).

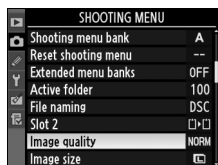

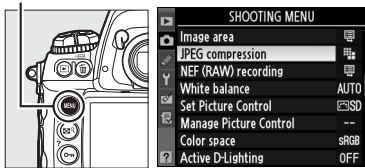

The following options can be accessed from the shooting menu. Press the **MENU** button to display the menus, highlight the desired option and press ►.

MENU button





■■ JPEG Compression

Choose the type of compression for JPEG images.

| Option | Description |
|--|--|
|  Size priority | Images are compressed to produce relatively uniform file size. |
|  Optimal quality | Optimal image quality. File size varies with scene recorded. |

■■ NEF (RAW) Recording > Type

Choose the type of compression for NEF (RAW) images.

| Option | Description |
|--|--|
|  Lossless compressed | NEF images are compressed using a reversible algorithm, reducing file size by about 20–40% with no effect on image quality. |
|  Compressed | NEF images are compressed using a non-reversible algorithm, reducing file size by about 40–55% with almost no effect on image quality. |
| Uncompressed | NEF images are not compressed. |

■■ NEF (RAW) Recording > NEF (RAW) Bit Depth

Choose a bit depth for NEF (RAW) images.

| Option | Description |
|----------------------|---|
| 12-bit 12-bit | NEF (RAW) images are recorded at a bit-depth of 12 bits. |
| 14-bit 14-bit | NEF (RAW) images are recorded at a bit-depth of 14 bits, producing files larger than 12-bit files but increasing the color data recorded. |

Image Size

Image size is measured in pixels. Choose from **Large**, **Medium**, or **Small** (note that image size varies depending on the option selected for **Image area**, □ 78):

| Image area | Option | Size (pixels) | Print size (cm/in.)* |
|--------------------------------|----------|---------------|------------------------|
| FX (36×24) 1.0× (FX format) | L | 4,256 × 2,832 | 36.0 × 24.0/14.2 × 9.4 |
| | M | 3,184 × 2,120 | 27.0 × 17.9/10.6 × 7.1 |
| | S | 2,128 × 1,416 | 18.0 × 12.0/ 7.1 × 4.7 |
| 1.2× (30×20) 1.2× | L | 3,552 × 2,368 | 30.1 × 20.0/11.8 × 7.9 |
| | M | 2,656 × 1,776 | 22.5 × 15.0/ 8.9 × 5.9 |
| | S | 1,776 × 1,184 | 15.0 × 10.0/ 5.9 × 3.9 |
| DX (24×16) 1.5× (DX format) | L | 2,784 × 1,848 | 23.6 × 15.6/ 9.3 × 6.2 |
| | M | 2,080 × 1,384 | 17.6 × 11.7/ 6.9 × 4.6 |
| | S | 1,392 × 920 | 11.8 × 7.8/ 4.6 × 3.1 |
| 5 : 4 (30×24) | L | 3,552 × 2,832 | 30.1 × 24.0/11.8 × 9.4 |
| | M | 2,656 × 2,120 | 22.5 × 17.9/ 8.9 × 7.1 |
| | S | 1,776 × 1,416 | 15.0 × 12.0/ 5.9 × 4.7 |

* Approximate size when printed at 300 dpi. Print size in inches equals image size in pixels divided by printer resolution in dots per inch (dpi; 1 inch = approximately 2.54 cm).

Image size can be set by pressing the **QUAL** button and rotating the sub-command dial until the desired option is displayed in the rear control panel.

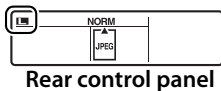
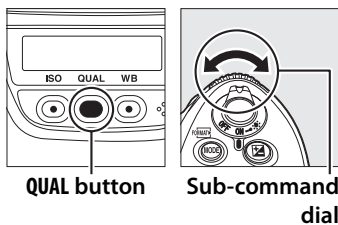

NEF (RAW) Images

Note that the option selected for image size does not affect the size of NEF (RAW) images. When opened in software such as ViewNX (supplied) or Capture NX 2 (available separately), NEF (RAW) images have the dimensions given for large (L-size) images in the table on the previous page.



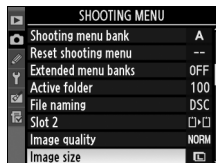

The Image Size Menu

Image size can also be adjusted using the **Image size** option in the shooting menu ( 284).

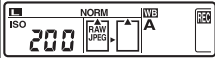

Slot 2

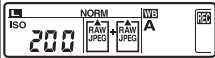
Use the **Slot 2** option in the shooting menu (☰ 284) to choose the role played by the memory card in slot 2.

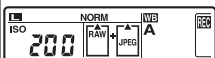
| Option | Rear control panel | Description |
|--|---|--|
|  Overflow |  | The memory card in slot 2 is used to record photographs when the memory card in slot 1 is full. |
|  Backup |  | Each photograph is recorded to both memory cards. |
|  RAW Slot 1 - JPEG Slot 2 |  | At image quality settings of NEF (RAW)+JPEG, the NEF (RAW) image is recorded to the memory card in slot 1, the JPEG image to the memory card in slot 2. At other image qualities, this option is the same as Backup . |

For information on saving movies to a selected slot, see page 71.

Backup/RAW Slot 1 - JPEG Slot 2

When the above options are selected, the shutter-release will be disabled when either of the memory cards is full. The viewfinder and top control panel show the number of exposures remaining on the card with the least amount of available memory. Voice memos (☰ 248) are appended to the copy recorded to the memory card in slot 1.



Focus

– Controlling How the Camera Focuses

This section describes the options that control how your camera focuses.

| | |
|------------------------------------|-----------|
| Focus Mode | 90 |
| AF-Area Mode | 92 |
| Focus Point Selection | 94 |
| Focus Lock | 96 |
| Manual Focus | 99 |



Focus Mode

Focus mode is controlled by the focus-mode selector on the front of the camera. There are two *autofocus* (AF) modes, in which the camera focuses automatically when the shutter-release button is pressed halfway, and one *manual focus* mode, in which focus must be adjusted manually using the focus ring on the lens:

Focus-mode selector

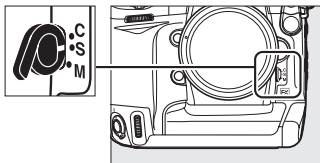

| Option | Description |
|--|--|
|  S Single-servo AF | Camera focuses when shutter-release button is pressed halfway. Focus locks when in-focus indicator (●) appears in viewfinder, and remains locked while shutter-release button is pressed halfway (<i>focus lock</i>). At default settings, shutter can only be released when in-focus indicator is displayed (<i>focus priority</i>). |
| C Continuous- servo AF | Camera focuses continuously while shutter-release button is pressed halfway. If subject moves, camera will engage <i>predictive focus tracking</i> (☐ 91) to predict final distance to subject and adjust focus as necessary. At default settings, shutter can be released whether or not subject is in focus (<i>release priority</i>). |
| M Manual (☐ 99) | Camera does not focus automatically; focus must be adjusted manually using the lens focus ring. If maximum aperture of lens is f/5.6 or faster, viewfinder focus indicator can be used to confirm focus (<i>electronic range finding</i> ; ☐ 100), but photographs can be taken at any time, whether or not subject is in focus. |

Choose single-servo AF for landscapes and other stationary subjects. Continuous-servo AF may be a better choice with erratically-moving subjects. Manual focus is recommended when the camera is unable to focus using autofocus.

The AF-ON Buttons

For the purpose of focusing the camera, pressing either of the **AF-ON** buttons has the same effect as pressing the shutter-release button halfway; note, however, that vibration reduction (available with VR lenses) can only be engaged by pressing the shutter-release button halfway.

AF-ON button

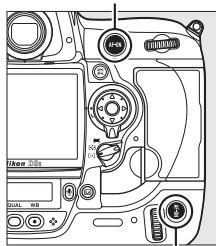



AF-ON button for vertical shooting

Predictive Focus Tracking

In continuous-servo AF, the camera will initiate predictive focus tracking if the subject moves toward or away from the camera while the shutter-release button is pressed halfway or either of the **AF-ON** buttons is pressed. This allows the camera to track focus while attempting to predict where the subject will be when the shutter is released.

See Also

For information on using focus priority in continuous-servo AF, see Custom Setting a1 (**AF-C priority selection**,  295). For information on using release priority in single-servo AF, see Custom Setting a2 (**AF-S priority selection**,  296). For information on preventing the camera from focusing when the shutter-release button is pressed halfway, see Custom Setting a5 (**AF activation**,  298).



AF-Area Mode

AF-area mode determines how the focus point is selected in autofocus mode (□ 90). To select the AF-area mode, rotate the AF-area mode selector. The following options are available:

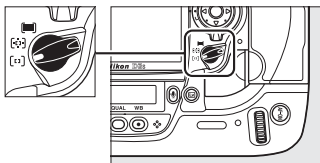

AF-area mode selector





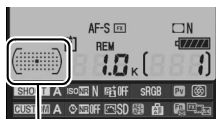

| Mode | Description |
|---------------------|--|
| [*] Single-point AF | User selects focus point manually; camera focuses on subject in selected focus point only. Use for relatively static compositions with subjects that will stay in selected focus point. |
| [*] Dynamic-area AF | <ul style="list-style-type: none"> • In continuous-servo AF (□ 90), user selects focus point manually; if subject briefly leaves selected focus point, camera will focus based on information from surrounding points. Number of focus points used can be selected from 9, 21, and 51 using Custom Setting a3 (Dynamic AF area, □ 296). If 51 points (3D-tracking) is selected for Custom Setting a3, focus point will be selected automatically using 3D-tracking. • In single-servo AF, user selects focus point manually; camera focuses on subject in selected focus point only. |
| [*] Auto-area AF | <p>Camera automatically detects subject and selects focus point. If type G or D lens is used, camera can distinguish human subjects from background for improved subject detection. In single-servo AF, active focus points are highlighted for about one second after camera focuses. Active focus points are not displayed in continuous-servo AF.</p> |

AF-Area Mode

AF-area mode is shown in the information display.

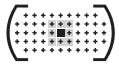
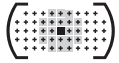
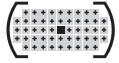
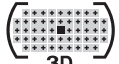

AF-area mode indicator

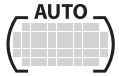

| AF-area mode | | Information display |
|--|---|---|
|  Single-point AF | |  |
|  Dynamic -area AF * | Custom Setting a3 (Dynamic AF area ,  296) | |
| | 9 points |  |
| | 21 points |  |
| | 51 points |  |
| | 51 points (3D-tracking) |  3D |
|  Auto-area AF | |  AUTO |

* Only active focus point is displayed in the viewfinder. Remaining focus points provide information to assist focus operation.

Manual Focus

Single-point AF is automatically selected when manual focus is used.

See Also

For information on the settings available in dynamic-area AF, see Custom Setting a3 (**Dynamic AF area**,  296). For information on adjusting how long the camera waits before refocusing when an object moves in front of the camera, see Custom Setting a4 (**Focus tracking with lock-on**,  298).

Focus Point Selection

The D3S offers a choice of 51 focus points that together cover a wide area of the frame. The focus point can be selected manually, allowing photographs to be composed with the main subject positioned almost anywhere in the frame (single-point and dynamic-area AF), or automatically (auto-area AF; note that manual focus point detection is not available when auto-area AF is selected). To select the focus point manually:

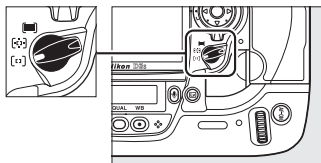

AF-area mode selector

1 Rotate the focus selector lock to ●.

This allows the multi selector to be used to select the focus point.

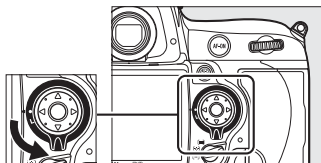

Focus selector lock

2 Select the focus point.

Use the multi selector to select the focus point. The center focus point can be selected by pressing the center of the multi selector.

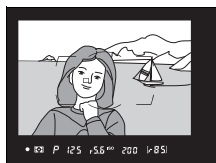



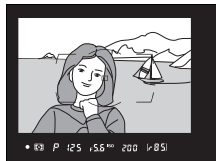

The focus selector lock can be rotated to the locked (L) position following selection to prevent the selected focus point from changing when the multi selector is pressed.



Portrait (Tall-Orientation) Photographs

When framing shots in portrait (“tall”) orientation, use the command dials to select the focus point. For more information, see Custom Setting f4 (**Assign Fn button**,  316).

See Also

For information on choosing when the focus point is illuminated, see Custom Setting a6 (**Focus point illumination**,  299). For information on setting focus-point selection to “wrap around,” see Custom Setting a7 (**Focus point wrap-around**,  299). For information on choosing the number of focus points that can be selected using the multi selector, see Custom Setting a8 (**AF point selection**,  300). For information on choosing the role of the AF-ON button for vertical shooting, see Custom Setting a10 (**Vertical AF-ON button**,  301). For information on changing the role of the multi selector center button, see Custom Setting f1 (**Multi selector center button**,  314).



Focus Lock

Focus lock can be used to change the composition after focusing, making it possible to focus on a subject that will not be in a focus point in the final composition. It can also be used when the autofocus system is unable to focus (📖 98).

1 Focus.

Position the subject in the selected focus point and press the shutter-release button halfway to initiate focus.



2 Check that the in-focus indicator (●) appears in the viewfinder.

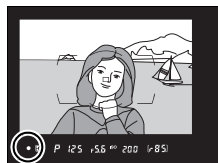

Single-servo AF

Focus will lock automatically when the in-focus indicator appears, and remain locked until you remove your finger from the shutter-release

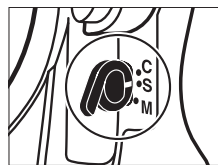

button. Focus can also be locked by pressing the **AE-L/AF-L** button (see following page).

Shutter-Release Button AE-L

If **On** is selected for Custom Setting c1 (**Shutter-release button AE-L**; 📖 305), exposure will lock when the shutter-release button is pressed halfway.

Continuous-servo AF

Press the **AE-L/AF-L** button to lock both focus and exposure (an **AE-L** icon appears in the viewfinder, see page 132). Focus and exposure will remain locked while the **AE-L/AF-L** button is pressed, even if you later remove your finger from the shutter-release button.

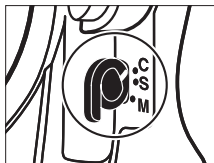

Shutter-release button

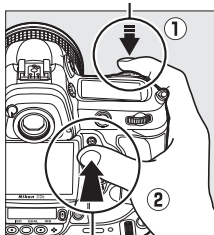

AE-L/AF-L button

3 **Recompose the photograph and shoot.**

Focus will remain locked between shots as long as the shutter-release button is kept pressed halfway, allowing several photographs in succession to be taken at the same focus setting. Focus will also remain locked between shots while the **AE-L/AF-L** button is pressed.

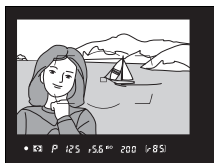

Do not change the distance between the camera and the subject while focus lock is in effect. If the subject moves, focus again at the new distance.

See Also

For information on choosing the role played by the **AE-L/AF-L** button, see Custom Setting f6 (**Assign AE-L/AF-L button**,  321).

Getting Good Results with Autofocus

Autofocus does not perform well under the conditions listed below. The shutter release may be disabled if the camera is unable to focus under these conditions, or the in-focus indicator (●) may be displayed and the camera may sound a beep, allowing the shutter to be released even when the subject is not in focus. In these cases, use manual focus (📖 99) or use focus lock (📖 96) to focus on another subject at the same distance and then recompose the photograph.

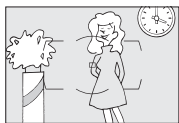

There is little or no contrast between the subject and the background

Example: subject is the same color as the background.



The focus point contains objects at different distances from the camera

Example: subject is inside a cage.



The subject is dominated by regular geometric patterns

Example: blinds or a row of windows in a skyscraper.

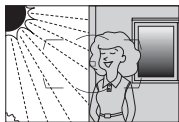

The focus point contains areas of sharply contrasting brightness

Example: subject is half in the shade.



Background objects appear larger than the subject

Example: a building is in the frame behind the subject.

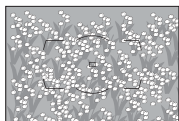

The subject contains many fine details

Example: a field of flowers or other subjects that are small or lack variation in brightness.

Manual Focus

Manual focus is available for lenses that do not support autofocus (non-AF NIKKOR lenses) or when the autofocus does not produce the desired results (☞ 98).

- **AF-S lenses:** Set the lens focus mode switch to **M**.
- **AF lenses:** Set the lens focus mode switch (if present) and camera focus-mode selector to **M**.

AF Lenses

Do not select focus mode **S** or **C**.
Failure to observe this precaution could damage the camera.

Focus-mode selector

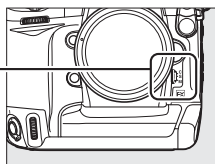

- **Manual focus lenses:** Set the camera focus-mode selector to **M**.

To focus manually, adjust the lens focus ring until the image displayed on the clear matte field in the viewfinder is in focus. Photographs can be taken at any time, even when the image is not in focus.

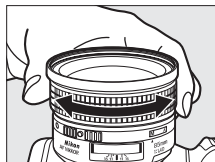

The Electronic Rangefinder

If the lens has a maximum aperture of $f/5.6$ or faster, the viewfinder focus indicator can be used to confirm whether the subject in the selected focus point is in focus (the focus point can be selected from any of the 51 focus points). After positioning the subject in the selected focus point, press the shutter-release button halfway and rotate the lens focus ring until the in-focus indicator (●) is displayed. Note that with the subjects listed on page 98, the in-focus indicator may sometimes be displayed when the subject is not in focus; confirm focus in the viewfinder before shooting.

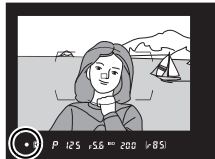
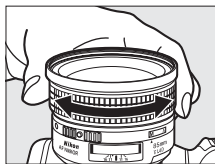

Focal Plane Position

To determine the distance between your subject and the camera, measure from the focal plane mark (⊖) on the camera body. The distance between the lens mounting flange and the focal plane is 46.5 mm (1.83 in.).

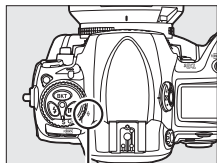

Focal plane mark



Release Mode

– *Single Frame, Continuous, Quiet Shutter-Release, Self-Timer, or Mirror Up*





Release mode determines how the camera takes photographs: one at a time (with or without reduced camera noise), in a continuous sequence, with a timed shutter-release delay, or with the mirror raised to enhance shutter response and minimize vibration.

| | |
|-------------------------------------|------------|
| Choosing a Release Mode..... | 102 |
| Continuous Mode..... | 104 |
| Self-Timer Mode | 106 |
| Mirror up Mode..... | 108 |



Choosing a Release Mode

The camera supports the following release modes:

| Mode | Description |
|---|---|
| S Single frame | Camera takes one photograph each time shutter-release button is pressed. |
| CL Continuous low speed | While shutter-release button is held down, camera records 1–9 frames per second.* |
| CH Continuous high speed | While shutter-release button is held down, camera records up to 9 frames per second (9–11 fps when DX (24×16) is selected for Image area ; see page 78).* |
| Q Quiet shutter-release | As for single-frame except that noise is reduced by disabling beeps and minimizing sound produced when mirror drops back into place. Beep does not sound when camera focuses regardless of setting selected for Custom Setting d1 (Beep ;  306) and mirror does not drop back into place until shutter-release button is returned to halfway position after shooting, allowing you to delay noise made by mirror. Mirror is quieter than in single-frame mode. |
|  Self-timer | Use self-timer for self-portraits or to reduce blurring caused by camera shake ( 106). |
| Mup Mirror up | Choose this mode to minimize camera shake in telephoto or close-up photography or in other situations in which the slightest camera movement can result in blurred photographs ( 108). |

* Average frame rate with continuous-servo AF, manual or shutter-priority auto exposure, a shutter speed of $1/250$ s or faster, other settings at default values, and memory remaining in memory buffer. Frame rate can be chosen using Custom Setting d2 (**Shooting speed**,  307).

To choose a release mode, press the release mode dial lock release and turn the release mode dial to the desired setting.

Release mode dial lock release

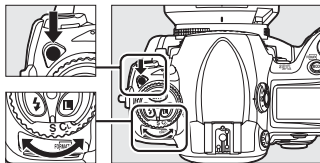

Release mode dial



Continuous Mode

To take pictures in **CH** (continuous high speed) and **CL** (continuous low speed) modes:

1 Select CH or CL mode.

Press the release mode dial lock release and turn the release mode dial to **CH** or **CL**.

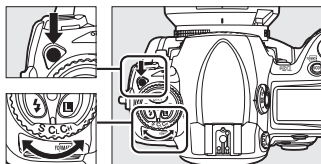

Release mode dial

2 Frame a photograph, focus, and shoot.



While the shutter-release button is pressed all the way down, pictures will be taken at the frame rate selected for Custom Setting d2 (**Shooting speed**,  307).

Continuous High Speed

In continuous high speed mode, the maximum frame rate for FX (36×24) format, 1.2 ×, and 5 : 4 (30×24) images is 9 fps. The maximum frame rate for DX (24×16) format images can be chosen from 9, 10, and 11 fps using Custom Setting d2 (**Shooting speed**,  307) >

Continuous high-speed (note that at 10 and 11 fps, focus will be fixed at the value for the first shot in each burst and that, when the subject is poorly lit, exposure will also be fixed at the value for the first shot).

Frame rate drops when vibration reduction (available with VR lenses) or auto ISO sensitivity control is on.

Buffer Size

The approximate number of images that can be stored in the memory buffer at current settings is shown in the exposure-count displays in the viewfinder and top control panel while the shutter-release button is pressed halfway. The illustration at right shows the display when space remains in the buffer for about 85 pictures.

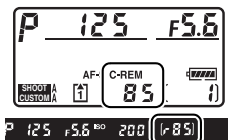

The Memory Buffer

The camera is equipped with a memory buffer for temporary storage, allowing shooting to continue while photographs are being saved to the memory card. Up to 130 photographs can be taken in succession; note, however, that frame rate will drop when the buffer is full.

While photographs are being recorded to the memory card, the access lamp next to the memory card slot will light. Depending on shooting conditions and memory card performance, recording may take from a few seconds to a few minutes. *Do not remove the memory card or remove or disconnect the power source until the access lamp has gone out.* If the camera is switched off while data remain in the buffer, the power will not turn off until all images in the buffer have been recorded. If the battery is exhausted while images remain in the buffer, the shutter release will be disabled and the images transferred to the memory card.

See Also

For information on choosing the maximum number of photographs that can be taken in a single burst, see Custom Setting d3 (**Max. continuous release**,  307). For information on the number of pictures that can be taken in a single burst, see page 420.



Self-Timer Mode

The self-timer can be used to reduce camera shake or for self-portraits. To use the self-timer, mount the camera on a tripod (recommended) or place the camera on a stable, level surface and follow the steps below:

1 Select self-timer mode.

Press the release mode dial lock release and turn the release mode dial to .

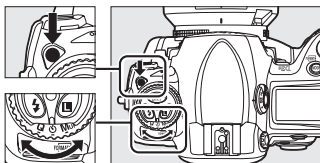

Release mode dial

2 Frame the photograph and focus.

In single-servo autofocus ( 90), photographs can only be taken if the in-focus (●) indicator appears in the viewfinder.



Close the Viewfinder Eyepiece Shutter

When taking photos without your eye to the viewfinder, close the viewfinder eyepiece shutter to prevent light entering via the viewfinder from appearing in photographs or interfering with exposure.

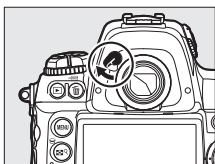

3 Start the timer.

Press the shutter-release button all the way down to start the timer. The self-timer lamp will start to blink. Two seconds before the photograph is taken, the self-timer lamp will stop blinking. The shutter will be released about ten seconds after the timer starts.



To turn the self-timer off before a photograph is taken, turn the release mode dial to another setting.



b_u l b

In self-timer mode, a shutter speed of **b_u l b** is equivalent to approximately $\frac{1}{5}$ s.

See Also

For information on changing the timer duration, see Custom Setting c3 (**Self-timer**, [□ 305](#)). For information on setting a beep to sound during the timer count-down, see Custom Setting d1 (**Beep**, [□ 306](#)).

Mirror up Mode

Choose this mode to minimize blurring caused by camera movement when the mirror is raised. Use of a tripod is recommended.

1 Select mirror up mode.

Press the release mode dial lock release and turn the release mode dial to **MUP**.

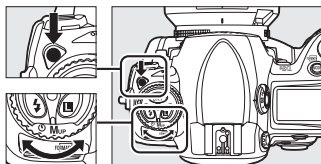

Release mode dial

2 Raise the mirror.

Frame the picture, focus, and then press the shutter-release button the rest of the way down to raise the mirror.



Using the Viewfinder

Note that autofocus, metering, and framing can not be confirmed in the viewfinder while mirror is raised.

3 Take a picture.

Press the shutter-release button all the way down again to take a picture. To prevent blurring caused by camera movement, press the shutter-release button smoothly, or use an optional remote cord (☞ 376). The mirror lowers when shooting ends.



Mirror up Mode

A picture will be taken automatically if no operations are performed for about 30 s after the mirror is raised.



ISO Sensitivity

– *Reacting Faster to Light*

“ISO sensitivity” is the digital equivalent of film speed. The higher the ISO sensitivity, the less light needed to make an exposure, allowing higher shutter speeds or smaller apertures. This chapter describes how to set ISO sensitivity manually and automatically.

| | |
|--|------------|
| Choosing ISO Sensitivity Manually | 110 |
| Auto ISO Sensitivity Control..... | 112 |

Choosing ISO Sensitivity Manually

ISO sensitivity can be set to values between ISO 200 and ISO 12800 in steps equivalent to $\frac{1}{3}$ EV. Settings of from about 0.3 to 1 EV below ISO 200 and 0.3 to 3 EV above ISO 12800 are also available for special situations.

ISO sensitivity can be adjusted by pressing the **ISO** button and rotating the main command dial until the desired setting is displayed in the control panels or viewfinder.

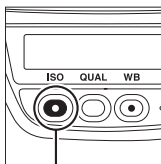

ISO button

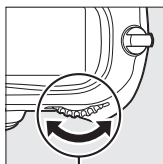

Main command dial



Top control panel



Rear control panel



Viewfinder



ISO sensitivity: 12800

The ISO Sensitivity Menu

ISO sensitivity can also be adjusted using the **ISO sensitivity** option in the shooting menu (☰ 284).

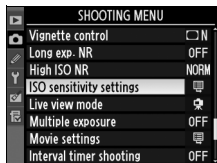

Hi 0.3–Hi 3

The settings **Hi 0.3** through **Hi 3** correspond to ISO sensitivities 0.3–3 EV over ISO 12800 (ISO 16000–102400 equivalent). Pictures taken at these settings are more likely to be subject to noise (randomly-spaced bright pixels, fog, or lines).

Lo 0.3–Lo 1

The settings **Lo 0.3** through **Lo 1** correspond to ISO sensitivities 0.3–1 EV below ISO 200 (ISO 160–100 equivalent). Use for larger apertures when lighting is bright. Contrast is slightly higher than normal; in most cases, ISO sensitivities of ISO 200 or above are recommended.

See Also

For information on Custom Setting b1 (**ISO sensitivity step value**), see page 302. For information on using the **High ISO NR** option in the shooting menu to reduce noise at high ISO sensitivities, see page 291.

Auto ISO Sensitivity Control

If **On** is selected for **ISO sensitivity settings > ISO sensitivity auto control** in the shooting menu, ISO sensitivity will automatically be adjusted if optimal exposure can not be achieved at the value selected by the user (ISO sensitivity is adjusted appropriately when the flash is used).

1 Select ISO sensitivity auto control for ISO sensitivity settings in the shooting menu.

To display the menus, press the **MENU** button.

Select **ISO sensitivity settings** in the shooting menu, highlight **ISO sensitivity auto control**, and press **▶**.

MENU button

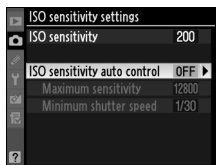
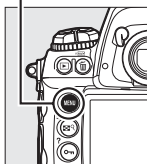

ISO

2 Select On.

Highlight **On** and press **OK** (if **Off** is selected, ISO sensitivity will remain fixed at the value selected by the user).

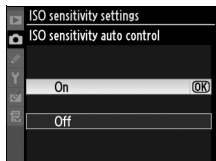

3 Adjust settings.

The maximum value for auto ISO sensitivity can be selected using **Maximum sensitivity** (the minimum value for auto ISO sensitivity is automatically

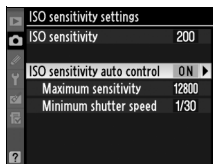

set to ISO 200; note that if the value selected for **Maximum sensitivity** is lower than the value currently selected for **ISO sensitivity**, the value selected for **Maximum sensitivity** will be used). In exposure modes **P** and **A**, sensitivity will only be adjusted if underexposure would result at the shutter speed selected for **Minimum shutter speed** ($1/4000-1$ s; in modes **S** and **M**, ISO sensitivity will be adjusted for optimal exposure at the shutter speed selected by the user). Slower shutter speeds may be used if optimum exposure can not be achieved at the ISO sensitivity value selected for **Maximum sensitivity**. Press **OK** to exit when settings are complete.

When **On** is selected, the viewfinder and rear control panel show **ISO-AUTO**. When sensitivity is altered from the value selected by the user, these indicators blink and the altered value is shown in the viewfinder and rear control panel.

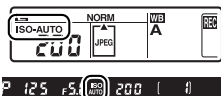

Auto ISO Sensitivity Control

Noise is more likely at higher sensitivities. Use the **High ISO NR** option in the shooting menu to reduce noise (see page 291). When a flash is used, the value selected for **Minimum shutter speed** is ignored in favor of the option selected for Custom Setting e1 (**Flash sync speed**, 311). Note that ISO sensitivity may be raised automatically when auto ISO sensitivity control is used in combination with slow sync flash modes (available with SB-900, SB-800, SB-600, and SB-400 flash units), possibly preventing the camera from selecting slow shutter speeds.



Exposure

– *Controlling How the Camera Sets Exposure*





This section describes the options available to control exposure, including metering, exposure mode, exposure lock, exposure compensation, and bracketing.

| | |
|--|------------|
| Metering | 116 |
| Exposure Mode | 118 |
| <i>P</i> : Programmed Auto | 120 |
| <i>S</i> : Shutter-Priority Auto | 122 |
| <i>A</i> : Aperture-Priority Auto | 123 |
| <i>M</i> : Manual | 125 |
| Long Time-Exposures | 128 |
| Shutter-Speed and Aperture Lock | 130 |
| Autoexposure (AE) Lock | 132 |
| Exposure Compensation | 134 |
| Bracketing | 136 |

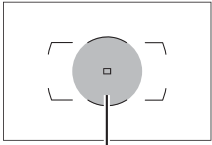

Metering

Metering determines how the camera sets exposure. The following options are available:

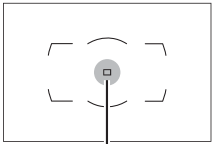
| Method | Description | |
|---|---|--|
|  3D color matrix II | Recommended in most situations. Camera meters a wide area of the frame and sets exposure according to distribution of brightness, color, distance, and composition for natural results. | |
|  Center-weighted | Camera meters entire frame but assigns greatest weight to 12-mm circle in center of viewfinder (if CPU lens is attached, area can be selected using Custom Setting b5, Center-weighted area ,  304 ¹). Classic meter for portraits. ² |  Center-weighted area³ |
|  Spot | Camera meters circle 4 mm (0.16 in.) in diameter (approximately 1.5% of frame). Circle is centered on current focus point, making it possible to meter off-center subjects (if non-CPU lens is used or if auto-area AF is in effect ( 92), camera will meter center focus point). Ensures that subject will be correctly exposed, even when background is much brighter or darker. ² |  Spot metering area³ |

1 When non-CPU lens is attached, average for entire frame will be used if **Average** is selected for Custom Setting b5; otherwise, center-weighted metering for non-CPU lenses will use 12-mm circle in center of viewfinder, regardless of setting selected for **Non-CPU lens data**.

2 For improved precision with non-CPU lenses, specify lens focal length and maximum aperture in **Non-CPU lens data** menu ( 215).

3 Metered area is not actually displayed in viewfinder.

To choose a metering method, press the metering selector lock button and rotate the metering selector until the desired mode is displayed in the viewfinder.

Metering selector

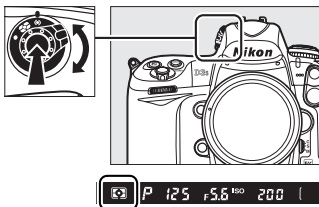



Matrix Metering

The metering method used is determined by the type of lens attached:

- **Type G and D lenses:** Range information is included when determining exposure (3D color matrix metering II).
- **Other CPU lenses:** Range information is not included when determining exposure (color matrix metering II).
- **Non-CPU lenses:** Color matrix metering is available if focal length and maximum aperture are specified using **Non-CPU lens data** item in setup menu (see page 214; center-weighted metering is used if focal length or aperture is not specified).

See Also

For information on choosing the size of the area assigned the greatest weight in center-weighted metering, see Custom Setting b5 (**Center-weighted area**,  304). For information on making separate adjustments to optimal exposure for each metering method, see Custom Setting b6 (**Fine tune optimal exposure**,  304).

Exposure Mode

Exposure mode determines how the camera sets shutter speed and aperture when adjusting exposure. Four modes are available: programmed auto (**P**), shutter-priority auto (**S**), aperture-priority auto (**A**), and manual (**M**).

| Mode | Description |
|--|--|
| P Programmed auto (☞ 120) | Camera sets shutter speed and aperture for optimal exposure. Recommended for snapshots and in other situations in which there is little time to adjust camera settings. |
| S Shutter-priority auto (☞ 122) | User chooses shutter speed; camera selects aperture for best results. Use to freeze or blur motion. |
| A Aperture-priority auto (☞ 123) | User chooses aperture; camera selects shutter speed for best results. Use to blur background for portraits or bring both foreground and background into focus for landscape shots. |
| M Manual (☞ 125) | User controls both shutter speed and aperture. Set shutter speed to “ b u l b ” for long time-exposures. |

Lens Types

When using a CPU lens equipped with an aperture ring (☞ 368), lock the aperture ring at the minimum aperture (highest f-number). Type G lenses are not equipped with an aperture ring.

Non-CPU lenses can only be used in exposure mode **A** (aperture-priority auto) and **M** (manual). In other modes, exposure mode **A** is automatically selected when a non-CPU lens is attached (☞ 366, 369). The exposure mode indicator (**P** or **S**) will blink in the top control panel and **A** will be displayed in the viewfinder.

Depth-of-Field Preview

To preview the effects of aperture, press and hold the **Pv** button. The lens will be stopped down to the aperture value selected by the camera (modes **P** and **S**) or the value chosen by the user (modes **A** and **M**), allowing depth of field to be previewed in the viewfinder.

Custom Setting e3—Modeling Flash

This setting controls whether optional flash units that support the Nikon Creative Lighting System (CLS; see page 187) will emit a modeling flash when the **Pv** button is pressed. See page 312 for more information.

Pv button

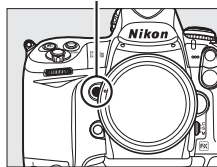

P: Programmed Auto

In this mode, the camera automatically adjusts shutter speed and aperture according to a built-in program to ensure optimal exposure in most situations. This mode is recommended for snapshots and other situations in which you want to leave the camera in charge of shutter speed and aperture. To take photographs in programmed auto:

1 Select exposure mode **P**.

Press the **MODE** button and rotate the main command dial until **P** is displayed in the viewfinder and top control panel.

MODE button

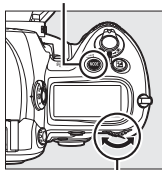

Main command dial

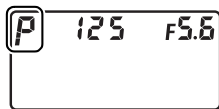

2 Frame a photograph, focus, and shoot.



Shutter speed: $\frac{1}{320}$ s; aperture: f/9

Flexible Program

In exposure mode *P*, different combinations of shutter speed and aperture can be selected by rotating the main command dial while the exposure meters are on (“flexible program”). Rotate the command dial to the right for large apertures (small f-numbers) that blur background details or fast shutter speeds that “freeze” motion. Rotate the command dial to the left for small apertures (large f-numbers) that increase depth of field or slow shutter speeds that blur motion. All combinations produce the same exposure. While flexible program is in effect, an asterisk (“*”) appears in the top control panel. To restore default shutter speed and aperture settings, rotate the command dial until the asterisk is no longer displayed, choose another mode, or turn the camera off.

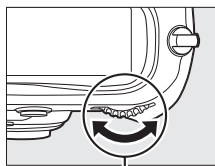

Main command dial

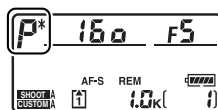

Shutter speed: $1/2,000$ s;
aperture: f/3.5



Shutter speed: $1/50$ s;
aperture: f/22

See Also

See page 397 for information on the built-in exposure program.



5: Shutter-Priority Auto

In shutter-priority auto, you choose the shutter speed while the camera automatically selects the aperture that will produce the optimal exposure. To take photographs in shutter-priority auto:

1 Select exposure mode 5.

Press the **MODE** button and rotate the main command dial until **5** is displayed in the viewfinder and top control panel.

MODE button

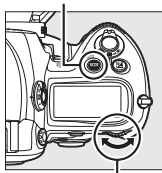

Main command dial

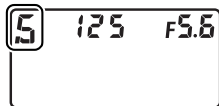

2 Choose a shutter speed.

Rotate the main command dial while the exposure meters are on to choose a shutter speed. Shutter speed can be set to "x 250" or to values between 30 s (30'') and $\frac{1}{8,000}$ s (8000). Use slow shutter speeds to suggest motion by blurring moving objects, fast shutter speeds to "freeze" motion.

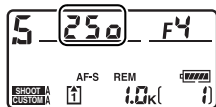

Fast shutter speed ($\frac{1}{1,600}$ s)



Slow shutter speed ($\frac{1}{6}$ s)

Shutter speed can be locked at the selected setting (130).

3 Frame a photograph, focus, and shoot.

A: Aperture-Priority Auto

In aperture-priority auto, you choose the aperture while the camera automatically selects the shutter speed that will produce the optimal exposure. To take photographs in aperture-priority auto:

1 Select exposure mode **A**.

Press the **MODE** button and rotate the main command dial until **A** is displayed in the viewfinder and top control panel.

MODE button

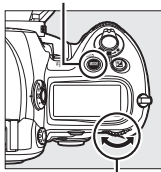

Main command dial

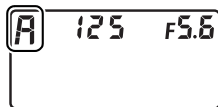

2 Choose an aperture.

Rotate the sub-command dial while the exposure meters are on to choose an aperture from values between the minimum and

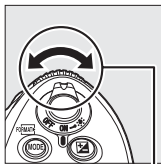

Sub-command dial

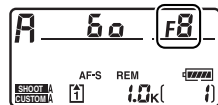

maximum for the lens. Small apertures (high f-numbers) increase depth of field (see page 119), bringing both foreground and background into focus. Large apertures (low f-numbers) soften background details in portraits or other compositions that emphasize the main subject.



Small aperture (f/36)

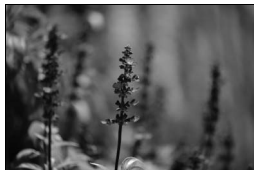

Large aperture (f/2.8)

Aperture can be locked at the selected setting (🗨 131).

3 Frame a photograph, focus, and shoot.



Non-CPU Lenses (📖 366, 369)

Use the lens aperture ring to adjust aperture. If the maximum aperture of the lens has been specified using the **Non-CPU lens data** item in setup menu (📖 215) when a non-CPU lens is attached, the current f-number will be displayed in the viewfinder and top control panel, rounded to the nearest full stop.

Otherwise the aperture displays will show only the number of stops (ΔF , with maximum aperture displayed as $\Delta F\text{0}$) and the f-number must be read from the lens aperture ring.

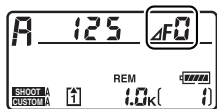

M: Manual

In manual exposure mode, you control both shutter speed and aperture. To take photographs in manual exposure mode:

1 Select exposure mode **M**.

Press the **MODE** button and rotate the main command dial until **M** is displayed in the viewfinder and top control panel.

MODE button

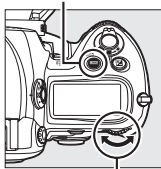

Main command dial

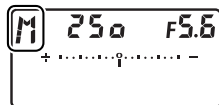

2 Choose aperture and shutter speed.

While the exposure meters are on, rotate the main command dial to choose a shutter speed, and the sub-command dial to set aperture. Shutter speed can be set to “x 250” or to values between 30 s and $1/8,000$ s, or the shutter can be held open indefinitely for a long time-exposure (bu l b, □ 128).

Aperture can be set to values between the minimum and maximum values for the lens. Check exposure in the exposure indicators, and continue to adjust shutter speed and aperture until the desired exposure is achieved.

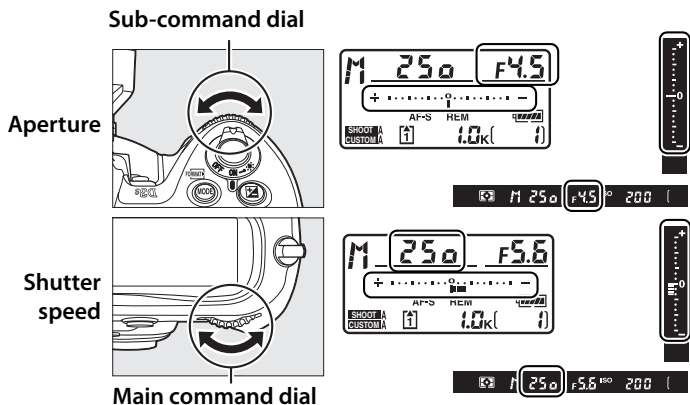

Shutter speed and aperture can be locked at the selected setting (□ 130, 131).

3 Frame a photograph, focus, and shoot.

Shutter speed: $1/250$ s;
aperture: f/8









AF Micro NIKKOR Lenses

Provided that an external exposure meter is used, the exposure ratio need only be taken into account when the lens aperture ring is used to set aperture.

Exposure Indicators

The exposure indicators in the viewfinder and top control panel show whether the photograph would be under- or over-exposed at current settings (if L or H is displayed in S or M modes, the indicators show the amount of under- or over-exposure). Depending on the option chosen for Custom Setting b2 (**EV steps for exposure ctrl.**,  302), the amount of under- or over-exposure is shown in increments of $1/3$ EV, $1/2$ EV, or 1 EV. If the limits of the exposure metering system are exceeded, the displays will flash.

| Custom Setting b2 set to 1/3 step | | | |
|-----------------------------------|---|---|---|
| | Optimal exposure | Underexposed by $1/3$ EV | Overexposed by over 3 EV |
| Top control panel |  |  |  |
| Viewfinder |  |  |  |

Reverse Indicators

Custom Setting f11 (**Reverse indicators**,  324) can be used to reverse the exposure indicator display.



Long Time-Exposures

At a shutter speed of $\frac{1}{4}$, the shutter will remain open while the shutter-release button is held down. Use for long time-exposure photographs of moving lights, the stars, night scenery, or fireworks. A tripod and optional remote cord (☐ 376) are recommended to prevent blur.

1 Ready the camera.

Mount the camera on a tripod or place it on a stable, level surface. If you are using an optional remote cord, attach it to the camera.

Long Time-Exposures

Close the viewfinder eyepiece shutter to prevent light entering via the viewfinder from appearing in the photograph or interfering with exposure. Nikon recommends using a fully-charged EN-EL4a battery or an optional EH-6 AC adapter to prevent loss of power while the shutter is open. Note that noise (randomly-spaced bright pixels or fog) may be present in long exposures; before shooting, choose **On** for the **Long exp. NR** option in the shooting menu (☐ 291).

2 Select exposure mode M.

Press the **MODE** button and rotate the main command dial until **M** is displayed in the viewfinder and top control panel.

MODE button

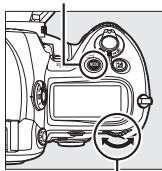

Main command dial

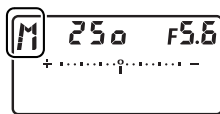

3 Choose a shutter speed.

While the exposure meters are active, rotate the main command dial until “bulb” appears in the shutter-speed displays. The exposure indicators do not appear when “bulb” is selected.

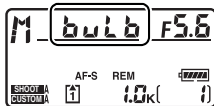

4 Press the shutter-release button all the way down.

Press the shutter-release button on the camera or remote cord all the way down. The shutter will remain open while the shutter-release button is pressed.

5 Release the shutter-release button.

Remove your finger from the shutter-release button to record the photograph.



Shutter speed: 35 s; aperture: f/25



Shutter-Speed and Aperture Lock

The **L** button can be used to lock shutter speed at the value selected in shutter-priority auto or manual exposure mode, or to lock aperture at the value selected in aperture-priority auto and manual exposure modes. Lock is not available in programmed auto.

■ ■ Shutter-Speed Lock

To lock shutter speed at the selected value, press the **L** button and rotate the main command dial until **L** icons appear in the viewfinder and the top control panel.

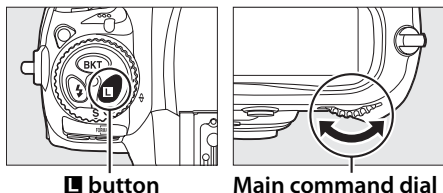

To unlock shutter speed, press the **L** button and rotate the main command dial until the **L** icons disappear from the displays.

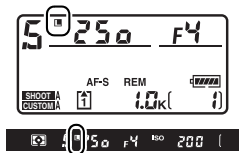

Aperture Lock

To lock aperture at the selected value, press the **L** button and rotate the sub-command dial until **L** icons appear in the viewfinder and the top control panel.

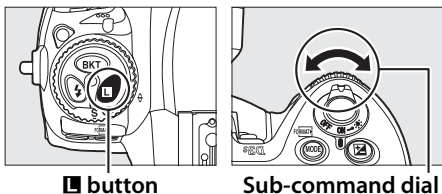

To unlock aperture, press the **L** button and rotate the sub-command dial until the **L** icons disappear from the displays.

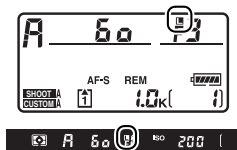

Autoexposure (AE) Lock

Use autoexposure lock to recompose photographs after metering exposure.

1 Select center-weighted or spot metering (☞ 116).

Matrix metering will not produce the desired results with autoexposure lock. If using center-weighted metering, select the center focus point with the multi selector (☞ 94).

Metering selector

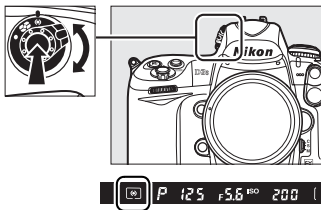

2 Lock exposure.

Position the subject in the selected focus point and press the shutter-release button halfway. With the shutter-release button pressed halfway and the subject positioned in the focus point, press the **AE-L/AF-L** button to lock exposure (and focus, except in manual focus mode). Confirm that the in-focus indicator (●) appears in the viewfinder.

While exposure lock is in effect, an **AE-L** indicator will appear in the viewfinder.

Shutter-release button

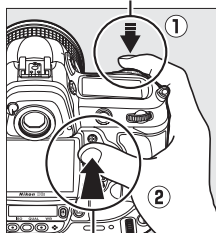

AE-L/AF-L button

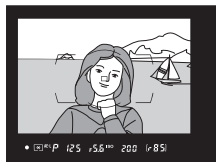

3 Recompose the photograph.

Keeping the **AE-L/AF-L** button pressed, recompose the photograph and shoot.

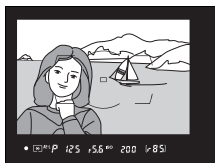

Metered Area

In spot metering, exposure will be locked at the value metered in a 4-mm (0.16 in.) circle centered on the selected focus point. In center-weighted metering, exposure will be locked at the value metered in a 12-mm circle in the center of the viewfinder.



Adjusting Shutter Speed and Aperture

While exposure lock is in effect, the following settings can be changed without altering the metered value for exposure:

| Exposure mode | Setting |
|---------------|--|
| P | Shutter speed and aperture (flexible program;  121) |
| S | Shutter speed |
| A | Aperture |

The new values can be confirmed in the viewfinder and top control panel. Note that the metering method can not be changed while exposure lock is in effect (changes to metering take effect when the lock is released).

See Also

If **On** is selected for Custom Setting c1 (**Shutter-release button AE-L**,  305), exposure will lock when the shutter-release button is pressed halfway. For information on changing the role of the **AE-L/AF-L** button, see Custom Setting f6 (**Assign AE-L/AF-L button**,  321).



Exposure Compensation

Exposure compensation is used to alter exposure from the value suggested by the camera, making pictures brighter or darker.

In exposure mode *M*, only the exposure information shown in the exposure indicator is affected; shutter speed and aperture do not change.

To choose a value for exposure compensation, press the  button and rotate the main command dial until the desired value is displayed in the viewfinder or top control panel.

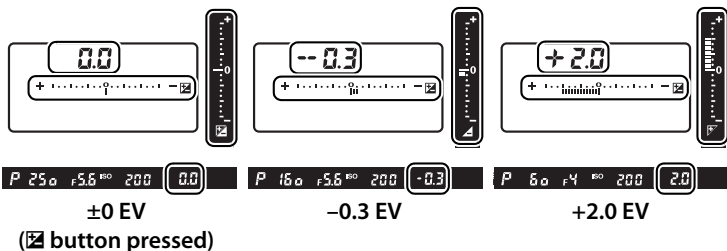
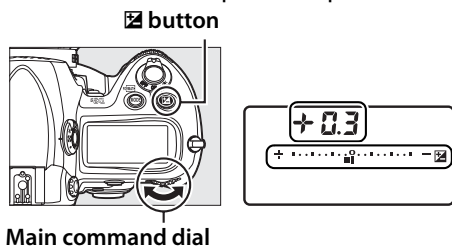

Exposure compensation can be set to values between -5 EV (underexposure) and $+5$ EV (overexposure) in increments of $\frac{1}{3}$ EV. In general, choose positive values to make the subject brighter, negative values to make it darker.



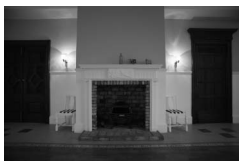

-1 EV



No exposure compensation



+1 EV

At values other than ± 0.0 , the 0 at the center of the exposure indicators will flash and a  icon will be displayed in the viewfinder and top control panel after you release the  button. The current value for exposure compensation can be confirmed in the exposure indicator by pressing the  button.

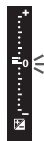
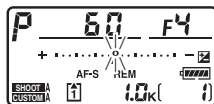



Normal exposure can be restored by setting exposure compensation to ± 0.0 . Exposure compensation is not reset when the camera is turned off.

Using a Flash

When a flash is used, exposure compensation affects both background exposure and flash level.

See Also

For information on choosing the size of the increments available for exposure compensation, see Custom Setting b3 (**EV steps for exposure comp.**,  302). For information on making adjustments to exposure compensation without pressing the  button, see Custom Setting b4 (**Easy exposure compensation**,  303). For information on automatically varying exposure, white balance, or Active D-Lighting, see page 136.

Bracketing

Bracketing automatically varies exposure, flash level, **Active D-Lighting (ADL)**, or white balance slightly with each shot, “bracketing” the current value. Choose in situations in which it is difficult to set exposure, Active D-Lighting, or white balance and there is not time to check results and adjust settings with each shot, or to experiment with different settings for the same subject.

■ Exposure and Flash Bracketing

To vary exposure and/or flash level over a series of photographs:

1 Select flash or exposure bracketing for Custom Setting e4 (Auto bracketing set) in the Custom Settings menu.

MENU button

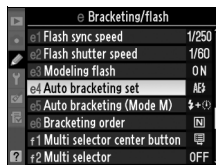
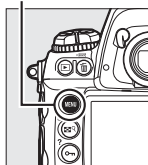

To display the menus, press the **MENU** button. Select Custom Setting e4 (**Auto bracketing set**) in the Custom Settings menu, highlight an option, and press **OK**. Choose **AE & flash** to vary both exposure and flash level, **AE only** to vary only exposure, or **Flash only** to vary only flash level.

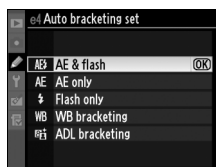

2 Choose the number of shots.

Pressing the **BKT** button, rotate the main command dial to choose the number of shots in the bracketing sequence. The number of shots is shown in the top control panel.

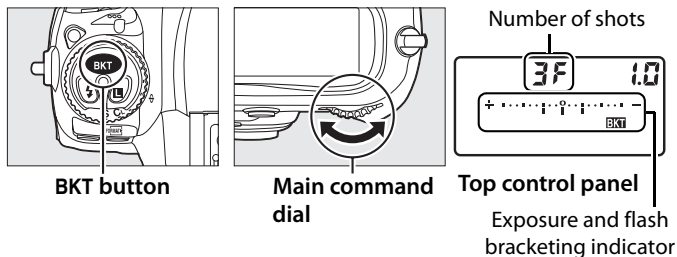

At settings other than zero, a **BKT** icon and exposure and flash bracketing indicator will be displayed in the viewfinder and top control panel.



3 Select an exposure increment.

Pressing the **BKT** button, rotate the sub-command dial to choose the exposure increment.

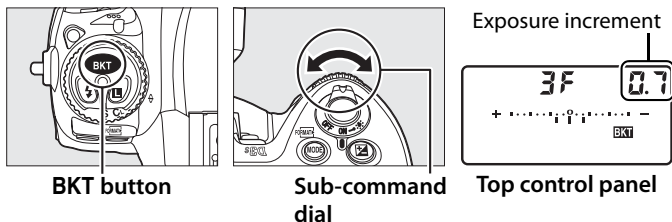

At default settings, the size of the increment can be chosen from $\frac{1}{3}$, $\frac{2}{3}$, and 1 EV. The bracketing programs with an increment of $\frac{1}{3}$ EV are listed below.

| Control panel display | No. of shots | Bracketing order (EVs) |
|-----------------------------|--------------|---|
| 0F 0.3 + 0 - | 0 | 0 |
| + 3F 0.3 + i - | 3 | +0.3/0/+0.7 |
| -- 3F 0.3 + i - | 3 | -0.3/-0.7/0 |
| + 2F 0.3 + i - | 2 | 0/+0.3 |
| -- 2F 0.3 + i - | 2 | 0/-0.3 |
| 3F 0.3 + i - | 3 | 0/-0.3/+0.3 |
| 5F 0.3 + i - | 5 | 0/-0.7/-0.3/+0.3/+0.7 |
| 7F 0.3 + i - | 7 | 0/-1.0/-0.7/-0.3/+0.3/ +0.7/+1.0 |
| 9F 0.3 + i - | 9 | 0/-1.3/-1.0/-0.7/-0.3/ +0.3/+0.7/+1.0/+1.3 |

See Also

For information on choosing the size of the exposure increment, see Custom Setting b2 (**EV steps for exposure ctrl.**, [□ 302](#)). For information on choosing the order in which bracketing is performed, see Custom Setting e6 (**Bracketing order**, [□ 313](#)). For information on choosing the role of the **BKT** button, see Custom Setting f7 (**Assign BKT button**, [□ 322](#)).

4 Frame a photograph, focus, and shoot.



The camera will vary exposure and/or flash level shot-by-shot according to the bracketing program selected. Modifications to exposure are added to those made with exposure compensation (see page 134), making it possible to achieve exposure compensation values of more than 5 EV.

While bracketing is in effect, a bracketing progress indicator will be displayed in the viewfinder and top control panel. A segment will disappear from the indicator after each shot.

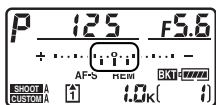

No. shots: 3; increment: 0.7

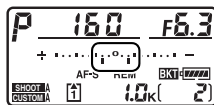

Display after first shot



Exposure modified by:
0 EV



Exposure modified by:
-1 EV



Exposure modified by:
+1 EV



■ ■ **Canceling Bracketing**

To cancel bracketing, press the **BKT** button and rotate the main command dial until the number of shots in the bracketing sequence is zero (0) and **BKT** is no longer displayed. The program last in effect will be restored the next time bracketing is activated. Bracketing can also be cancelled by performing a two-button reset (□ 200), although in this case the bracketing program will not be restored the next time bracketing is activated.

Exposure and Flash Bracketing

In continuous low speed and continuous high speed modes, shooting will pause after the number of shots specified in the bracketing program have been taken. Shooting will resume the next time the shutter-release button is pressed. In other modes, one shot will be taken each time the shutter-release button is pressed.

If the memory card fills before all shots in the sequence have been taken, shooting can be resumed from the next shot in the sequence after the memory card has been replaced or shots have been deleted to make room on the memory card. If the camera is turned off before all shots in the sequence have been taken, bracketing will resume from the next shot in the sequence when the camera is turned on.

Exposure Bracketing

The camera modifies exposure by varying shutter speed and aperture (programmed auto), aperture (shutter-priority auto), or shutter speed (aperture-priority auto, manual exposure mode). If **On** is selected for **ISO sensitivity settings > ISO sensitivity auto control** in modes **P**, **S**, and **A** and no flash is attached, the camera will automatically vary ISO sensitivity for optimum exposure when the limits of the camera exposure system are exceeded. Custom Setting e5 (**Auto bracketing (mode M)**, □ 313) can be used to change how the camera performs exposure and flash bracketing in manual exposure mode. Bracketing can be performed by varying flash level together with shutter speed and/or aperture, or by varying flash level alone.

■ White Balance Bracketing

The camera creates multiple copies of each photograph, each with a different white balance. For more information on white balance, see page 149.

1 Select white balance bracketing.

Choose **WB bracketing** for Custom Setting e4 **Auto bracketing set**.

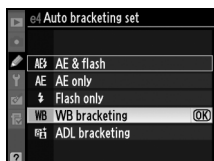

2 Choose the number of shots.

Pressing the **BKT** button, rotate the main command dial to choose the number of shots in the bracketing sequence. The number of shots is shown in the top control panel.

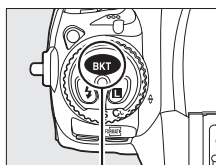

BKT button

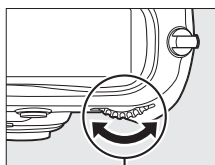

Main command dial

Number of shots

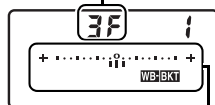

Top control panel

WB bracketing indicator

At settings other than zero, a WB bracketing indicator will appear in the top control panel and a **WB-BKT** icon will be displayed in the top and rear control panels.

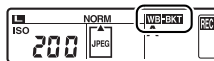

3 Select a white balance increment.

Pressing the **BKT** button, rotate the sub-command dial to choose the white balance adjustment. Each increment is roughly equivalent to 5 mired.

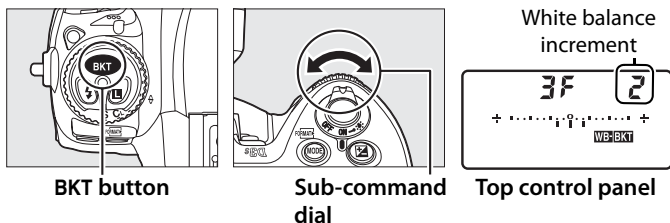

Choose from increments of 1 (5 mired), 2 (10 mired), or 3 (15 mired). Higher **B** values correspond to increased amounts of blue, higher **A** values to increased amounts of amber (□ 154). The bracketing programs with an increment of 1 are listed below.

| Control panel display | No. of shots | White balance increment | Bracketing order (EVs) |
|------------------------|--------------|-------------------------|---|
| 0F +.....o.....+ | 0 | 1 | 0 |
| b3F +.....iii.....+ | 3 | 1 B | 1 B / 0 / 2 B |
| A3F +......iii.....+ | 3 | 1 A | 1 A / 2 A / 0 |
| b2F +......ii.....+ | 2 | 1 B | 0 / 1 B |
| A2F +......ii.....+ | 2 | 1 A | 0 / 1 A |
| 3F +......iii.....+ | 3 | 1 A, 1 B | 0 / 1 A / 1 B |
| 5F +......iiii.....+ | 5 | 1 A, 1 B | 0 / 2 A / 1 A / 1 B / 2 B |
| 7F +......iiii.....+ | 7 | 1 A, 1 B | 0 / 3 A / 2 A / 1 A / 1 B / 2 B / 3 B |
| 9F +......iiii.....+ | 9 | 1 A, 1 B | 0 / 4 A / 3 A / 2 A / 1 A / 1 B / 2 B / 3 B / 4 B |

See Also

See page 155 for a definition of “mired.”

4 Frame a photograph, focus, and shoot.



Each shot will be processed to create the number of copies specified in the bracketing program, and each copy will have a different white balance. Modifications to white balance are added to the white balance adjustment made with white balance fine-tuning.

If the number of shots in the bracketing program is greater than the number of exposures remaining, **FULL** and  icon will flash in the top control panel, a flashing **FuL** icon will appear in the viewfinder as shown at right, and the shutter release will be disabled. Shooting can begin when a new memory card is inserted.

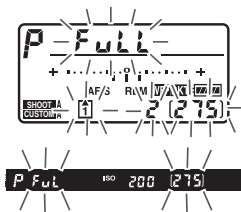

■ ■ **Canceling Bracketing**

To cancel bracketing, press the **BKT** button and rotate the main command dial until the number of shots in the bracketing sequence is zero (0 F) and **WB: BKT** is no longer displayed. The program last in effect will be restored the next time bracketing is activated. Bracketing can also be cancelled by performing a two-button reset (□ 200), although in this case the bracketing program will not be restored the next time bracketing is activated.



White Balance Bracketing

White balance bracketing is not available at an image quality of NEF (RAW). Selecting **NEF (RAW)**, **NEF (RAW)+JPEG fine**, **NEF (RAW)+JPEG normal**, or **NEF (RAW)+JPEG basic** cancels white balance bracketing.

White balance bracketing affects only color temperature (the amber-blue axis in the white balance fine-tuning display, □ 154). No adjustments are made on the green-magenta axis.

In self-timer mode (□ 106), the number of copies specified in the white-balance program will be created each time the shutter is released.

If the camera is turned off while the memory card access lamp is lit, the camera will power off only after all photographs in the sequence have been recorded.

■ ■ ADL Bracketing

The camera varies Active D-Lighting over a series of exposures. For more information on Active D-Lighting, see page 181.

1 Select ADL bracketing.

Choose **ADL bracketing** for Custom Setting e4 **Auto bracketing set**.

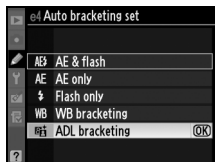

2 Choose the number of shots.

Pressing the **BKT** button, rotate the main command dial to choose the number of shots in the bracketing sequence. The number of shots is shown in the top control panel.

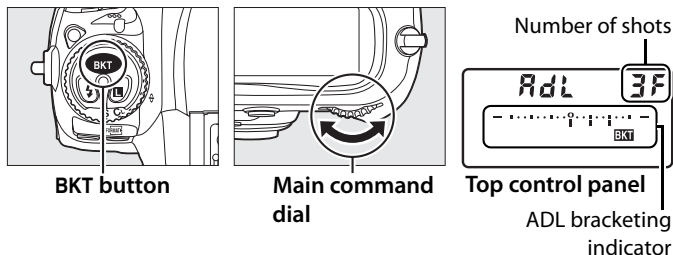

At settings other than zero, a **BKT** icon and an ADL bracketing indicator will be displayed in the top control panel. Choose two shots to take one photograph with Active D-Lighting off and another at a selected value. Choose three to five shots to take a series of photographs with Active D-Lighting set to **Off**, **Low**, and **Normal** (three shots), **Off**, **Low**, **Normal**, and **High** (four shots), or **Off**, **Low**, **Normal**, **High**, and **Extra High** (five shots). If you choose more than two shots, proceed to Step 4.

3 Select Active D-Lighting.

Pressing the **BKT** button, rotate the sub-command dial to choose Active D-Lighting.

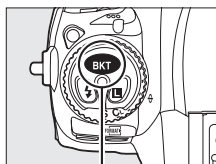

BKT button

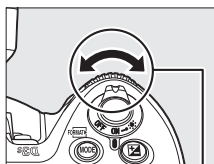

Sub-command dial

Active D-Lighting is shown in the top control panel.

| Control panel display | Active D-Lighting |
|-----------------------|-------------------|
| | Auto |
| | Low |
| | Normal |
| | High |
| | Extra high |

4 Frame a photograph, focus, and shoot.



The camera will vary Active D-Lighting shot-by-shot according to the bracketing program selected. While bracketing is in effect, a bracketing progress indicator will be displayed in the top control panel. A segment will disappear from the indicator after each shot.

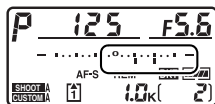
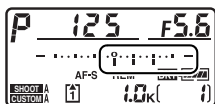

■ ■ *Canceling Bracketing*

To cancel bracketing, press the **BKT** button and rotate the main command dial until the number of shots in the bracketing sequence is zero. The program last in effect will be restored the next time bracketing is activated. Bracketing can also be cancelled by performing a two-button reset (📖 200), although in this case the bracketing program will not be restored the next time bracketing is activated.



ADL Bracketing

In continuous low speed and continuous high speed modes, shooting will pause after the number of shots specified in the bracketing program have been taken. Shooting will resume the next time the shutter-release button is pressed. In other modes, one shot will be taken each time the shutter-release button is pressed.

If the memory card fills before all shots in the sequence have been taken, shooting can be resumed from the next shot in the sequence after the memory card has been replaced or shots have been deleted to make room on the memory card. If the camera is turned off before all shots in the sequence have been taken, bracketing will resume from the next shot in the sequence when the camera is turned on.



White Balance

– *Keeping Colors True*







The color of light reflected from an object varies with the color of the light source. The human brain is able to adapt to changes in the color of the light source, with the result that white objects appear white whether seen in the shade, direct sunlight, or under incandescent lighting. Unlike the film used in film cameras, digital cameras can mimic this adjustment by processing images according to the color of the light source. This is known as “white balance.” This chapter covers white balance settings.

| | |
|---|------------|
| White Balance Options | 150 |
| Fine-Tuning White Balance | 153 |
| Choosing a Color Temperature | 157 |
| Preset Manual | 158 |



White Balance Options

For natural coloration, choose a white balance setting that matches the light source before shooting. The following options are available:

| Option | Color temp.* | Description |
|---|----------------|---|
| AUTO Auto | 3,500–8,000 K | White balance is adjusted automatically. For best results, use type G or D lens. If optional flash fires, results are adjusted appropriately. |
|  Incandescent | 3,000 K | Use under incandescent lighting. |
|  Fluorescent | | Use with: |
| Sodium-vapor lamps | 2,700 K | • Sodium-vapor lighting (found in sports venues). |
| Warm-white fluorescent | 3,000 K | • Warm-white fluorescent lights. |
| White fluorescent | 3,700 K | • White fluorescent lights. |
| Cool-white fluorescent | 4,200 K | • Cool-white fluorescent lights. |
| Day white fluorescent | 5,000 K | • Daylight white fluorescent lights. |
| Daylight fluorescent | 6,500 K | • Daylight fluorescent lights. |
| High temp. mercury-vapor | 7,200 K | • High color temperature light sources (e.g. mercury-vapor lamps). |
|  Direct sunlight | 5,200 K | Use with subjects lit by direct sunlight. |
|  Flash | 5,400 K | Use with optional flash units. |
|  Cloudy | 6,000 K | Use in daylight under overcast skies. |
|  Shade | 8,000 K | Use in daylight with subjects in the shade. |
|  Choose color temp. | 2,500–10,000 K | Choose color temperature from list of values (☞ 157). |
| PRE Preset manual | — | Use subject, light source, or existing photograph as reference for white balance (☞ 158). |

* All values are approximate. Fine-tuning set to 0.

Auto white balance is recommended with most light sources. If the desired results can not be achieved with auto white balance, choose an option from the list above or use preset white balance.

White balance can be selected by pressing the **WB** button and rotating the main command dial until the desired setting is displayed in the rear control panel.

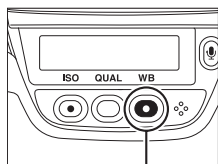

WB button

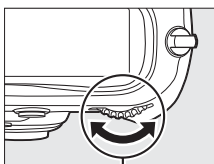

Main command dial

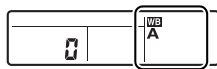



Rear control panel

The White Balance Menu

White balance can also be adjusted using the **White balance** option in the shooting menu ( 284).



(Fluorescent)

Selecting  (**Fluorescent**) with the **WB** button and main command dial selects the type of bulb chosen for the **Fluorescent** option in the white balance menu ( 284).

Studio Flash Lighting

Auto white balance may not produce the desired results with large studio flash units. Use preset white balance or set white balance to **Flash** and use fine tuning to adjust white balance.

See Also

When **WB bracketing** is selected for Custom Setting e4 (**Auto bracketing set**,  312), the camera will create several images each time the shutter is released. White balance will be varied with each image, “bracketing” the value currently selected for white balance. See page 136 for more information.



Color Temperature

The perceived color of a light source varies with the viewer and other conditions. Color temperature is an objective measure of the color of a light source, defined with reference to the temperature to which an object would have to be heated to radiate light in the same wavelengths. While light sources with a color temperature in the neighborhood of 5,000–5,500 K appear white, light sources with a lower color temperature, such as incandescent light bulbs, appear slightly yellow or red. Light sources with a higher color temperature appear tinged with blue.

Fine-Tuning White Balance

White balance can be “fine tuned” to compensate for variations in the color of the light source or to introduce a deliberate color cast into an image. White balance is fine tuned using the **White balance** option in the shooting menu or by pressing the **WB** button and rotating the sub-command dial.

■ ■ The White Balance Menu

1 Select a white balance option in the shooting menu.

To display the menus, press the **MENU** button.

Select **White balance** in

the shooting menu, then highlight a white balance option and press **▶**. If an option other than **Fluorescent**, **Choose color temp.**, or **Preset manual** is selected, proceed to Step 2. If

Fluorescent is selected, highlight a lighting type and press **▶**.

If **Choose color temp.** is selected, highlight a color

temperature and press **▶**. If **Preset manual** is selected, choose a preset as described on page 166 before proceeding.

MENU button

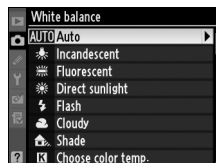
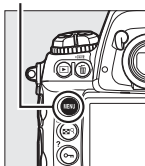

2 Fine tune white balance.

Use the multi selector to fine-tune white balance. White balance can be fine tuned on the amber (A)–blue (B) axis and the green (G)–magenta (M) axis. The horizontal (amber–blue) axis corresponds to color temperature, with each increment equivalent to about 5 mired. The vertical (green–magenta) axis has the similar effects to the corresponding color compensation (CC) filters.

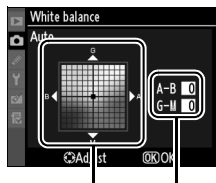

Coordinates Adjustment

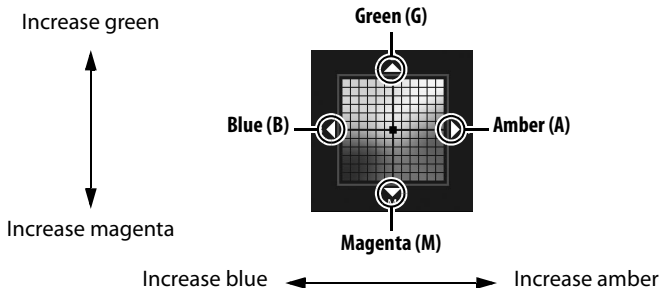

3 Press **OK**.

Press **OK** to save settings and return to the shooting menu. If white balance has been fine-tuned on the A-B axis, a **◀** icon will be displayed in the rear control panel.

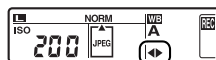

White Balance Fine Tuning

The colors on the fine-tuning axes are relative, not absolute. For example, moving the cursor to **B** (blue) when a “warm” setting such as  (**Incandescent**) is selected for white balance will make photographs slightly “colder” but will not actually make them blue.

Color Temperature Fine-Tuning

When **Choose color temp.** is selected, you can view the color temperature while fine-tuning white balance.

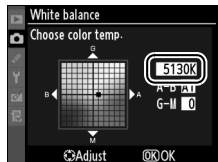

“Mired”

Any given change in color temperature produces a greater difference in color at low color temperatures than it would at higher color temperatures. For example, a change of 1000 K produces a much greater change in color at 3000 K than at 6000 K. Mired, calculated by multiplying the inverse of the color temperature by 10^6 , is a measure of color temperature that takes such variation into account, and as such is the unit used in color-temperature compensation filters. E.g.:

- 4000 K–3000 K (a difference of 1000 K)=83 mired
- 7000 K–6000 K (a difference of 1000 K)=24 mired

■ ■ The WB Button

At settings other than **☑** (**Choose color temp.**) and **PRE** (**Preset manual**), the **WB** button can be used to fine-tune white balance on the amber (A)–blue (B) axis (☐ 154; to fine-tune white balance when **☑** or **PRE** is selected, use the shooting menu as described on page 153). Six settings in both directions are available; each increment is equivalent to about 5 mired (☐ 155). Press the **WB** button and rotate the sub-command dial until the desired value is displayed in the rear control panel. Rotating the sub-command dial to the left increases the amount of amber (A). Rotating the sub-command dial to the right increases the amount of blue (B). At settings other than 0, a ◀▶ icon appears in the rear control panel.

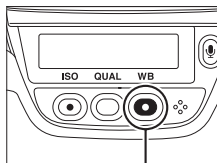

WB button

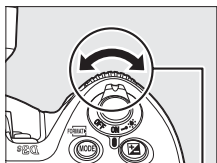

Sub-command dial

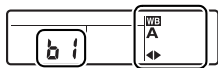

Rear control panel

Choosing a Color Temperature

When **☑ (Choose color temp.)** is selected for white balance, color temperature can be selected by pressing the **WB** button and rotating the sub-command dial. The color temperature is displayed in the rear control panel:

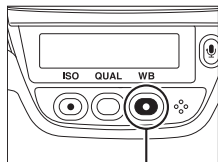

WB button

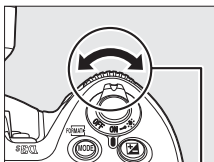

Sub-command dial



Rear control panel

☑ Choose Color Temperature

Note that the desired results will not be obtained with flash or fluorescent lighting. Choose **⚡ (Flash)** or **☀ (Fluorescent)** for these sources. With other light sources, take a test shot to determine if the selected value is appropriate.

✎ The White Balance Menu

Color temperature can also be selected in the white balance menu. Note that the color temperature with the **WB** button and the sub-command dial replaces the value selected in the white balance menu.

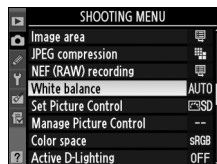

Preset Manual

Preset manual is used to record and recall custom white balance settings for shooting under mixed lighting or to compensate for light sources with a strong color cast. Two methods are available for setting preset white balance:

| Method | Description |
|--------------------------------------|--|
| Direct measurement | Neutral gray or white object is placed under lighting that will be used in final photograph and white balance is measured by camera (☞ 160). |
| Copy from existing photograph | White balance is copied from photo on memory card (☞ 164). |

The camera can store up to five values for preset white balance in presets d-0 through d-4. A descriptive comment can be added to any white balance preset (📖 168).

d-0

Stores last value measured for white balance (📖 160). This preset is overwritten when a new value is measured.

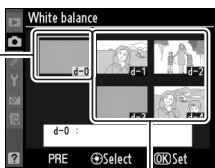

d-1-d-4

Store values copied from d-0 (📖 163).

Store values copied from images on memory card (📖 164).

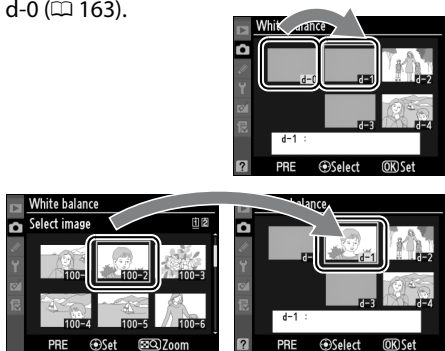

White Balance Presets

Changes to white balance presets apply to all shooting menu banks (📖 285). A confirmation dialog will be displayed if the user attempts to change a white balance preset created in another shooting menu bank (no warning is displayed for preset d-0).

■ ■ Measuring a Value for White Balance

1 Light a reference object.

Place a neutral gray or white object under the lighting that will be used in the final photograph. In studio settings, a standard gray panel can be used as a reference object. In exposure mode **M**, adjust exposure so that the exposure indicator shows ± 0 (📖 127).

2 Set white balance to PRE (Preset manual).

Press the **WB** button and rotate the main command dial until **PRE** is displayed in the rear control panel.

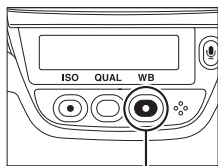

WB button

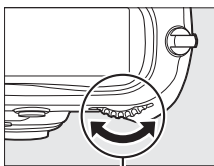

Main command dial

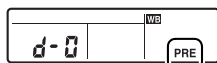

Rear control panel



3 Select direct measurement mode.

Release the **WB** button briefly and then press the button until the **PRE** icon in the rear control panel starts to flash. A flashing **P-r-E** will also appear in the top control panel and viewfinder. The displays will flash for about six seconds.

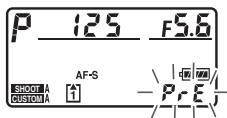

Top control panel

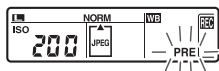

Rear control panel



Viewfinder

4 Measure white balance.



Before the indicators stop flashing, frame the reference object so that it fills the viewfinder and press the shutter-release button all the way down. The camera will measure a value for white balance and store it in preset d-0. No photograph will be recorded; white balance can be measured accurately even when the camera is not in focus.

5 Check the results.

If the camera was able to measure a value for white balance, **Good** will flash in the control panels for about six seconds, while the viewfinder will show a flashing **Gd**.



Top control panel



Rear control panel



Viewfinder



If lighting is too dark or too bright, the camera may be unable to measure white balance. A flashing **no Gd** will appear in the control panels and viewfinder for about six seconds. Press the shutter-release button halfway to return to Step 4 and measure white balance again.

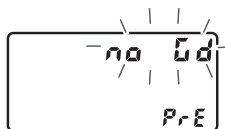

Top control panel

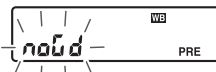

Rear control panel



Viewfinder

6 Select preset d-0.

If the new value for preset white balance will be used immediately, select preset d-0 by pressing the **WB** button and rotating the sub-command dial until d-0 is displayed in the rear control panel.

✓ Direct Measurement Mode

If no operations are performed while the displays are flashing, direct measurement mode will end in the time selected for Custom Setting c2 (**Auto meter-off delay**, 163).

✎ Preset d-0

The new value for white balance will be stored in preset d-0, automatically replacing the previous value for this preset (no confirmation dialog will be displayed). A thumbnail will be displayed in the preset white balance list (163).



To use the new value for white balance, select preset d-0 (if no value has been measured for white balance before d-0 is selected, white balance will be set to a color temperature of 5,200 K, the same as **Direct sunlight**). The new white balance value will remain in preset d-0 until white balance is measured again. By copying preset d-0 to one of the other presets before measuring a new value for white balance, up to five white balance values can be stored (163).

■ Copying White Balance from d-0 to Presets d-1–d-4

Follow the steps below to copy a measured value for white balance from d-0 to any of the other presets (d-1–d-4).

1 Select PRE (Preset manual) for White balance in the shooting menu.

Press the MENU button and select **White balance** in the shooting menu. Highlight **Preset manual** and press ►.

MENU button

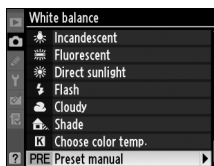
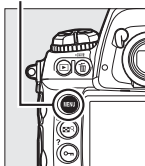

2 Select a destination.

Highlight the destination preset (d-1 to d-4) and press the center of the multi selector.

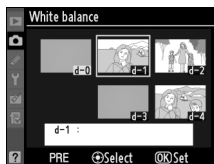

3 Copy d-0 to the selected preset.

Highlight **Copy d-0** and press **OK**. If comment has been created for d-0 (📖 168), the comment will be copied to the comment for the selected preset.

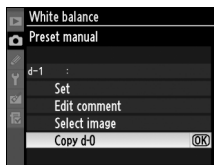

WB

■ Copying White Balance from a Photograph (d-1–d-4 Only)

Follow the steps below to copy a value for white balance from an existing photograph to a selected preset (d-1–d-4 only). Existing white balance values can not be copied to preset d-0.

1 Select PRE (Preset manual).

Highlight **Preset manual** in the white balance menu and press **▶**.

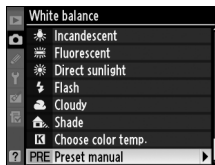

2 Select a destination.

Highlight the destination preset (d-1 to d-4) and press the center of the multi selector.



3 Choose Select image.

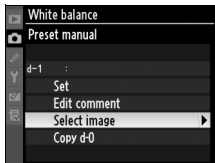

Highlight **Select image** and press **▶**.

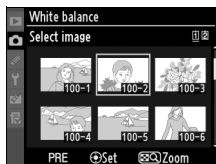

4 Highlight a source image.

Highlight the source image. To view the highlighted image full frame, press the  button.



To view images in other locations, press  while pressing  and select the desired card and folder ( 224).





5 Copy white balance.

Press the center of the multi selector to copy the white balance value for the highlighted photograph to the selected preset. If the highlighted photograph has a comment ( 331), the comment will be copied to the comment for the selected preset.



Choosing a White Balance Preset

Press  to highlight the current white balance preset (d-0–d-4) and press  to select another preset.

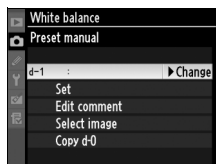

■ ■ Selecting a White Balance Preset

To set white balance to a preset value:

1 Select PRE (Preset manual).

Highlight **Preset manual** in the white balance menu and press **▶**.

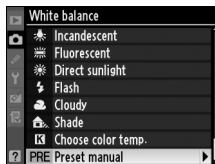

2 Select a preset.

Highlight the desired preset and press the center of the multi selector. To select the highlighted preset and display fine tuning menu (□ 154) without completing the next step, press **⊗** instead of pressing the center of the multi selector.

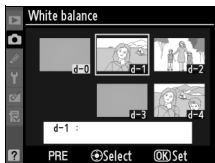

3 Select Set.

Highlight **Set** and press **▶**. Fine tuning menu for the selected white balance preset is displayed (□ 154).

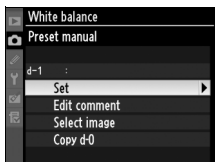

Selecting a White Balance Preset: the WB Button

At a setting of **PRE (Preset manual)**, presets can also be selected by pressing the **WB** button and rotating the sub-command dial. The current preset is displayed in the rear control panel while the **WB** button is pressed.

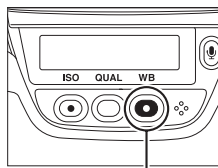

WB button

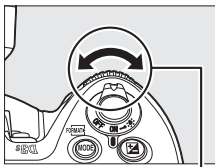

Sub-command dial

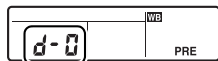

Rear control panel

■ Entering a Comment

Follow the steps below to enter a descriptive comment of up to thirty-six characters for a selected white balance preset.

1 Select PRE (Preset manual).

Highlight **Preset manual** in the white balance menu and press **▶**.

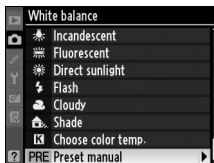

2 Select a preset.

Highlight the desired preset and press the center of the multi selector.



3 Select Edit comment.

Highlight **Edit comment** and press **▶**.

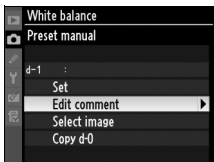

4 Edit the comment.

Edit the comment as described on page 286.

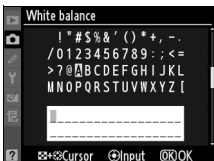



Image Enhancement

This chapter describes how to optimize sharpening, contrast, brightness, saturation and hue using Picture Controls, how to preserve detail in highlights and shadows using Active D-Lighting, and how to choose a color space.

| | |
|---|------------|
| Picture Controls | 170 |
| Selecting a Picture Control..... | 170 |
| Modifying Existing Picture Controls | 172 |
| Creating Custom Picture Controls | 176 |
| Sharing Custom Picture Controls..... | 179 |
| Active D-Lighting | 181 |
| Color Space..... | 183 |







Picture Controls

Nikon's unique Picture Control system makes it possible to share image processing settings, including sharpening, contrast, brightness, saturation, and hue, among compatible devices and software.

Selecting a Picture Control

The camera offers a choice of preset Picture Controls. Choose a Picture Control according to the subject or type of scene.

| Option | Description |
|--|---|
|  Standard | Standard processing for balanced results. Recommended for most situations. |
|  Neutral | Minimal processing for natural results. Choose for photographs that will later be extensively processed or retouched. |
|  Vivid | Pictures are enhanced for a vivid, photoprint effect. Choose for photographs that emphasize primary colors. |
|  Monochrome | Take monochrome photographs. |

1 Select Set Picture Control in the shooting menu.

To display the menus, press the **MENU** button. Highlight **Set Picture Control** in the shooting menu and press ►.

MENU button

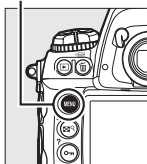

2 Select a Picture Control.

Highlight the desired Picture Control and press **OK**.



Preset Picture Controls Versus Custom Picture Controls

The Picture Controls supplied with the camera are referred to as *preset Picture Controls*. *Custom Picture Controls* are created through modifications to existing Picture Controls using the **Manage Picture Control** option in the shooting menu (□ 176). Custom Picture Controls can be saved to a memory card for sharing among other D3S cameras and compatible software (□ 179).

Optional Picture Controls

Additional optional Picture Controls are available for download from Nikon websites.

The Picture Control Indicator

The current Picture Control is shown in the information display when the **Info** button is pressed.

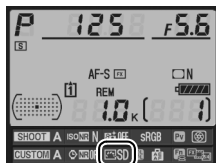

Picture Control indicator



Modifying Existing Picture Controls

Existing preset or custom Picture Controls (176) can be modified to suit the scene or the user's creative intent. Choose a balanced combination of settings using **Quick adjust**, or make manual adjustments to individual settings.



1 Select a Picture Control.

Highlight the desired Picture Control in the **Set Picture Control** menu (170) and press **▶**.



2 Adjust settings.

Press **▲** or **▼** to highlight the desired setting and press **◀** or **▶** to choose a value (173).

Repeat this step until all settings have been adjusted, or

select **Quick adjust** to choose a preset combination of settings. Default settings can be restored by pressing the **Reset** button.



3 Press **OK**.

Modifications to Original Picture Controls

Picture Controls that have been modified from default settings are indicated by an asterisk ("*****") in the **Set Picture Control** menu.



Picture Control Settings

| Option | Description | |
|--|--|---|
| Quick adjust | Choose from options between -2 and +2 to reduce or exaggerate the effect of the selected Picture Control (note that this resets all manual adjustments). For example, choosing positive values for Vivid makes pictures more vivid. Not available with Neutral , Monochrome , or custom Picture Controls. | |
| Manual adjustments (all Picture Controls) | Sharpening | Control the sharpness of outlines. Select A to adjust sharpening automatically according to the type of scene, or choose from values between 0 (no sharpening) and 9 (the higher the value, the greater the sharpening). |
| | Contrast | Select A to adjust contrast automatically according to the type of scene, or choose from values between -3 and +3 (choose lower values to prevent highlights in portrait subjects from being "washed out" in direct sunlight, higher values to preserve detail in misty landscapes and other low-contrast subjects). |
| | Brightness | Choose -1 for reduced brightness, +1 for enhanced brightness. Does not affect exposure. |
| Manual adjustments (non-monochrome only) | Saturation | Control the vividness of colors. Select A to adjust saturation automatically according to the type of scene, or choose from values between -3 and +3 (lower values reduce saturation and higher values increase it). |
| | Hue | Choose negative values (to a minimum of -3) to make reds more purple, blues more green, and greens more yellow, positive values (up to +3) to make reds more orange, greens more blue, and blues more purple. |
| Manual adjustments (monochrome only) | Filter effects | Simulate the effect of color filters on monochrome photographs. Choose from OFF , yellow, orange, red, and green (☐ 174). |
| | Toning | Choose the tint used in monochrome photographs from B&W (black-and-white), Sepia , Cyanotype (blue-tinted monochrome), Red , Yellow , Green , Blue Green , Blue , Purple Blue , Red Purple (☐ 175). |



✔ Active D-Lighting



Contrast and **Brightness** can not be adjusted when Active D-Lighting (☐181) is on. Any manual adjustments currently in effect will be lost when Active D-Lighting is turned on.

✔ "A" (Auto)

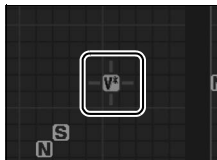
Results for auto contrast and saturation vary with exposure and the position of the subject in the frame. Use a type G or D lens for best results. The icons for Picture Controls that use auto contrast and saturation are displayed in green in the Picture Control grid, and lines appear parallel to the axes of the grid.



✍ The Picture Control Grid

Pressing the  button in Step 2 displays a Picture Control grid showing the contrast and saturation for the selected Picture Control in relation to the other Picture Controls (only contrast is displayed when **Monochrome** is selected). Release the  button to return to the Picture Control menu.



✍ Previous Settings

The line under the value display in the Picture Control setting menu indicates the previous value for the setting. Use this as a reference when adjusting settings.



✍ Filter Effects (Monochrome Only)

The options in this menu simulate the effect of color filters on monochrome photographs. The following filter effects are available:

| Option | Description |
|----------|---|
| Y Yellow | Enhances contrast. Can be used to tone down the brightness of the sky in landscape photographs. Orange produces more contrast than yellow, red more contrast than orange. |
| O Orange | |
| R Red | |
| G Green | Softens skin tones. Can be used for portraits. |

Note that the effects achieved with **Filter effects** are more pronounced than those produced by physical glass filters.

Toning (Monochrome Only)

Pressing ▼ when **Toning** is selected displays saturation options. Press ◀ or ▶ to adjust saturation. Saturation control is not available when **B&W** (black-and-white) is selected.



Custom Picture Controls

The options available with custom Picture Controls are the same as those on which the custom Picture Control was based.



Creating Custom Picture Controls

The preset Picture Controls supplied with the camera can be modified and saved as custom Picture Controls.

1 Select Manage Picture Control in the shooting menu.

To display the menus, press the **MENU** button. Highlight **Manage Picture Control** in the shooting menu and press **▶**.

MENU button

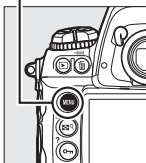

2 Select Save/edit.

Highlight **Save/edit** and press **▶**.



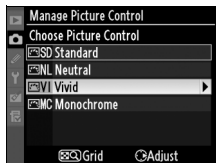

3 Select a Picture Control.

Highlight an existing Picture Control and press **▶**, or press **OK** to proceed to Step 5 to save a copy of the highlighted Picture Control without further modification.



4 Edit the selected Picture Control.

See page 173 for more information. To abandon any changes and start over from default settings, press the  button. Press  when settings are complete.



5 Select a destination.

Choose a destination for the custom Picture Control (C-1 through C-9) and press .



6 Name the Picture Control.

The text-entry dialog shown at right will be displayed. By default, new Picture

Controls are named by adding a two-digit number (assigned automatically) to the name of the existing Picture Control. This name can be edited to create a new name of up to 19 characters as described on page 286.

The new Picture Control will appear in the Picture Control list.



Keyboard area
Name area

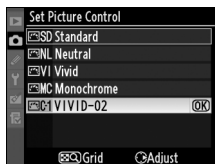

Manage Picture Control > Rename

Custom Picture Controls can be renamed at any time using the **Rename** option in the **Manage Picture Control** menu.

Manage Picture Control > Delete

The **Delete** option in the **Manage Picture Control** menu can be used to delete selected custom Picture Controls when they are no longer needed.

The Original Picture Control Icon

The original preset Picture Control on which the custom Picture Control is based is indicated by an icon in the top right corner of the edit display.

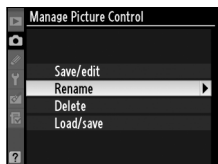

Original Picture Control icon



Sharing Custom Picture Controls

Custom Picture Controls created using the Picture Control Utility available with ViewNX or optional software such as Capture NX 2 can be copied to a memory card and loaded into the camera, or custom Picture Controls created with the camera can be copied to the memory card to be used in other D3S cameras and compatible software and then deleted when no longer needed.

To copy custom Picture Controls to or from the memory card, or to delete custom Picture Controls from the memory card, highlight **Load/Save** in the **Manage Picture Control** menu and press **▶**. The following options will be displayed:

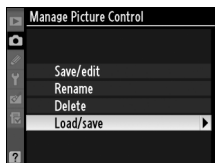

- **Copy to camera:** Copy custom Picture Controls from the memory card to custom Picture Controls C-1 through C-9 on the camera and name them as desired.

- **Delete from card:** Delete selected custom Picture Controls from the memory card. The confirmation dialog shown at right will be displayed before a Picture Control is deleted; to delete the selected Picture Control, highlight **Yes** and press **OK**.



- **Copy to card:** Copy a custom Picture Control (C-1 through C-9) from the camera to a selected destination (1 through 99) on the memory card.



Use Slot 1

Slot 1 is used when saving custom Picture Controls to a memory card or copying custom Picture Controls to the camera. Cards in slot 2 can not be used.

Saving Custom Picture Controls

Up to 99 custom Picture Controls can be stored on the memory card at any one time. The memory card can only be used to store user-created custom Picture Controls. The preset Picture Controls supplied with the camera (**Standard**, **Neutral**, **Vivid**, and **Monochrome**) can not be copied to the memory card, renamed, or deleted.



Active D-Lighting

Active D-Lighting preserves details in highlights and shadows, creating photographs with natural contrast. Use for high contrast scenes, for example when photographing brightly lit outdoor scenery through a door or window or taking pictures of shaded subjects on a sunny day.

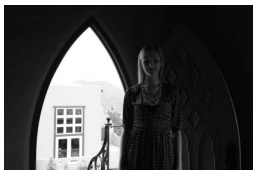

Active D-Lighting off

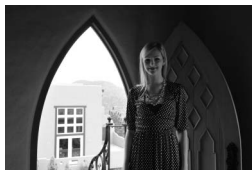

Active D-Lighting: 晒 AUTO Auto



Active D-Lighting off



Active D-Lighting: 晒 H High



“Active D-Lighting” versus “D-Lighting”

The **Active D-Lighting** option in the shooting menu adjusts exposure before shooting to optimize the dynamic range, while the **D-Lighting** option in the retouch menu optimizes dynamic range in images after shooting.

To use Active D-Lighting:

1 Select Active D-Lighting in the shooting menu.

To display the menus, press the **MENU** button. Highlight **Active D-Lighting** in the shooting menu and press **▶**.

MENU button

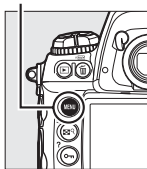

2 Choose an option.

Highlight the desired option and press **OK**. If **Auto** is selected, the camera will automatically adjust Active D-Lighting according to shooting conditions (in exposure mode **M**, however, **Auto** is equivalent to **Normal**).

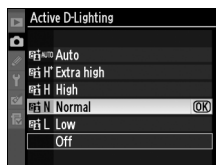

✓ Active D-Lighting

Matrix metering is recommended (☰ 116). When Active D-Lighting is on, uneven shading may be visible with some subjects, noise (randomly-spaced bright pixels, fog, or lines) may appear in photographs taken at high ISO sensitivities, the capacity of the memory buffer drops, and additional time is required to record images. Note that Active D-Lighting is not available at ISO sensitivities of Hi 0.3 or above. The **Brightness** and **Contrast** Picture Control settings (☰ 173) can not be adjusted while Active D-Lighting is in effect.

✍ See Also

When **ADL bracketing** is selected for Custom Setting e4 (**Auto bracketing set**, ☰ 312), the camera varies Active D-Lighting over a series of shots. See page 145 for more information.

Color Space

The color space determines the gamut of colors available for color reproduction. Choose a color space according to how photographs will be processed on leaving the camera.

| Option | Description |
|------------------------|---|
| sRGB sRGB | Choose for photographs that will be printed or used “as is,” with no further modification. |
| Adobe Adobe RGB | This color space is capable of expressing a wider gamut of colors than sRGB, making it the preferred choice for images that will be extensively processed or retouched. |

1 Select Color space in the shooting menu.

To display the menus, press the **MENU** button. Highlight **Color space** in the shooting menu and press **▶**.

MENU button

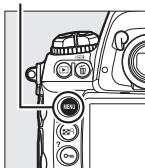

2 Select a color space.

Highlight the desired option and press **OK**.

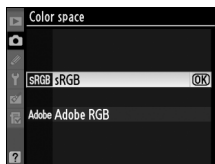

Color Space

Color spaces define the correspondence between colors and the numeric values that represent them in a digital image file. The sRGB color space is widely used, while the Adobe RGB color space is typically used in publishing and commercial printing. sRGB is recommended when taking photographs that will be printed without modification or viewed in applications that do not support color management, or when taking photographs that will be printed with ExifPrint, the direct printing option on some household printers, or kiosk printing or other commercial print services. Adobe RGB photographs can also be printed using these options, but colors will not be as vivid.

JPEG photographs taken in the Adobe RGB color space are Exif 2.21 and DCF 2.0 compliant; applications and printers that support Exif 2.21 and DCF 2.0 will select the correct color space automatically. If the application or device does not support Exif 2.21 and DCF 2.0, select the appropriate color space manually. An ICC color profile is embedded in TIFF photographs taken in the Adobe RGB color space, allowing applications that support color management to automatically select the correct color space. For more information, see the documentation provided with the application or device.

Nikon Software

ViewNX (supplied) and Capture NX 2 (available separately) automatically select the correct color space when opening photographs created with this camera.





Flash Photography

– *Using Optional Flash Units*

This chapter describes how to use the camera with optional flash units that support the Nikon Creative Lighting System (CLS).

| | |
|--|------------|
| Using a Flash | 186 |
| The Nikon Creative Lighting System (CLS) | 187 |
| Other Flash Units | 189 |
| i-TTL Flash Control..... | 192 |
| Flash Modes..... | 193 |
| FV Lock | 196 |



Using a Flash

The camera supports the Nikon Creative Lighting System (CLS) and can be used with CLS-compatible flash units. Optional flash units can be attached directly to the camera accessory shoe as described below. The accessory shoe is equipped with a safety lock for flash units with a locking pin, such as the SB-900, SB-800, SB-600, and SB-400.

1 Remove the accessory shoe cover.

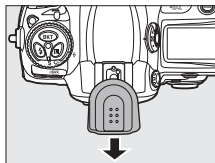

2 Mount the flash unit on the accessory shoe.

See the manual provided with the flash unit for details.

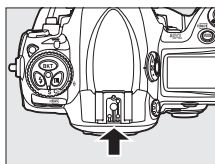

The Sync Terminal

A sync cable can be connected to the sync terminal as required. Do not connect another flash unit via a sync cable when performing rear-curtain sync flash photography with a flash unit mounted on the camera accessory shoe.

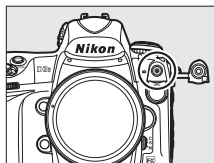

The Nikon Creative Lighting System (CLS)

Nikon's advanced Creative Lighting System (CLS) offers improved communication between the camera and compatible flash units for improved flash photography. The camera can be used with the following CLS-compatible flash units:

■ The SB-900, SB-800, SB-600, SB-400, and SB-R200:

| Flash unit | | SB-900 ¹ | SB-800 | SB-600 | SB-400 | SB-R200 ² |
|------------------------|---------|---------------------|--------|--------|--------|----------------------|
| Feature | | | | | | |
| Guide No. ³ | ISO 100 | 34/111 | 38/125 | 30/98 | 21/69 | 10/33 |
| | ISO 200 | 48/157 | 53/174 | 42/138 | 30/98 | 14/46 |

- 1 If a color filter is attached to the SB-900 when AUTO or  (flash) is selected for white balance, the camera will automatically detect the filter and adjust white balance appropriately.
- 2 Controlled remotely with optional SB-900 or SB-800 flash unit or SU-800 wireless Speedlight commander.
- 3 m/ft., 20 °C (68 °F), SB-900, SB-800, and SB-600 at 35 mm zoom head position; SB-900 with standard illumination.

■ SU-800 Wireless Speedlight Commander:

When mounted on a CLS-compatible camera, the SU-800 can be used as a commander for remote SB-900, SB-800, SB-600, or SB-R200 flash units. The SU-800 itself is not equipped with a flash.

Guide Number

To calculate the range of the flash at full power, divide the Guide Number by the aperture. For example, at ISO 100 the SB-800 has a Guide Number of 38 m or 125 ft. (35 mm zoom head position); its range at an aperture of f/5.6 is $38 \div 5.6$ or about 6.8 meters (or in feet, $125 \div 5.6 =$ approximately 23 ft. 7 in.). For each twofold increase in ISO sensitivity, multiply the Guide Number by the square root of two (approximately 1.4).



The following features are available with the SB-900, SB-800, SB-600, SB-400, and SB-R200:

| Flash unit | | Advanced Wireless Lighting | | | | | | | |
|--|---|----------------------------|----------------|------------------|------------------|---------------------|---------------------|------------------|-------------------|
| | | SB-900 SB-800 | | SB-600 SB-400 | | Commander | | Remote | |
| | | | | | | SB-900 SB-800 | SU-800 ¹ | SB-900 SB-800 | SB-600 SB-R200 |
| Flash mode/feature | | SB-900 SB-800 | SB-600 | SB-400 | SB-900 SB-800 | SU-800 ¹ | SB-900 SB-800 | SB-600 | SB-R200 |
| i-TTL | i-TTL balanced fill-flash for digital SLR | ✓ ² | ✓ ² | ✓ ³ | ✓ | ✓ | ✓ | ✓ | ✓ |
| AA | Auto aperture | ✓ ⁴ | — | — | ✓ ⁵ | ✓ ⁵ | ✓ ⁵ | — | — |
| A | Non-TTL auto | ✓ ⁶ | — | — | ✓ ⁵ | — | ✓ ⁵ | — | — |
| GN | Distance-priority manual | ✓ | — | — | — | — | — | — | — |
| M | Manual | ✓ | ✓ | — | ✓ | ✓ | ✓ | ✓ | ✓ |
| RPT | Repeating flash | ✓ | — | — | ✓ | ✓ | ✓ | ✓ | — |
| Auto FP High-Speed Sync ⁷ | | ✓ | ✓ | — | ✓ | ✓ | ✓ | ✓ | ✓ |
| FV lock | | ✓ | ✓ | ✓ | ✓ | ✓ | ✓ | ✓ | ✓ |
| AF-assist for multi-area AF ⁸ | | ✓ | ✓ | — | ✓ | ✓ | — | — | — |
| Flash Color Information Communication | | ✓ | ✓ | ✓ | ✓ | — | — | — | — |
| REAR | Rear-curtain sync | ✓ | ✓ | ✓ | ✓ | ✓ | ✓ | ✓ | ✓ |
| 👁 | Red-eye reduction | ✓ | ✓ | ✓ | ✓ | — | — | — | — |
| Power zoom | | ✓ | ✓ | — | ✓ | — | — | — | — |

- 1 Only available when SU-800 is used to control other flash units.
- 2 Standard i-TTL flash for digital SLR is used with spot metering or when selected with flash unit.
- 3 Standard i-TTL flash for digital SLR is used with spot metering.
- 4 Selected with flash unit. Non-TTL auto (A) selected automatically if non-CPU lens is attached without specifying lens data using **Non-CPU lens data**.
- 5 Auto aperture (AA) is used regardless of mode selected with flash unit. Non-TTL auto (A) selected automatically if non-CPU lens is attached without specifying lens data using **Non-CPU lens data**.
- 6 Selected with flash unit.
- 7 Select **1/250 s (Auto FP)** for Custom Setting e1 (**Flash sync speed**, 311).
- 8 CPU lens required.

Modeling Illumination

CLS-compatible flash units such as the SB-900, SB-800, and SB-600 emit a modeling flash when the camera **Pv** button is pressed. This feature can be used with Advanced Wireless Lighting to preview the total lighting effect achieved with multiple flash units. Modeling illumination can be turned off using Custom Setting e3 **Modeling flash** (📖 312).

Other Flash Units

The following flash units can be used in non-TTL auto and manual modes. If they are set to TTL, the camera shutter-release button will lock and no photographs can be taken.

| Flash unit | SB-80DX, SB-28DX, SB-28, SB-26, SB-25, SB-24 | SB-50DX | SB-30, SB-27 ¹ , SB-22S, SB-22, SB-20, SB-16B, SB-15 | SB-23, SB-29 ² , SB-21B ² , SB-29S ² |
|---|---|---------|--|---|
| A Non-TTL auto | ✓ | — | ✓ | — |
| M Manual | ✓ | ✓ | ✓ | ✓ |
|  Repeating flash | ✓ | — | — | — |
| REAR Rear-curtain sync | ✓ | ✓ | ✓ | ✓ |

1 Flash mode is automatically set to TTL and shutter-release is disabled. Set flash unit to **A** (non-TTL auto flash).

2 Autofocus is only available with AF-Micro lenses (60 mm, 105 mm, or 200 mm).



Notes on Optional Flash Units

Refer to the flash unit manual for detailed instructions. If the unit supports CLS, refer to the section on CLS-compatible digital SLR cameras. The D3S is not included in the “digital SLR” category in the SB-80DX, SB-28DX, and SB-50DX manuals.

i-TTL flash control can be used at ISO sensitivities between 200 and 12800. At values over 12800, the desired results may not be achieved at some ranges or aperture settings. If the flash-ready indicator blinks for about three seconds after a photograph is taken, the flash has fired at full power and the photograph may be underexposed. View the photograph in the monitor; if it is underexposed, adjust aperture, ISO sensitivity, or the distance to the subject and try again.

When an SC-series 17, 28, or 29 sync cable is used for off-camera flash photography, correct exposure may not be achieved in i-TTL mode. We recommend that you select standard i-TTL flash control. Take a test shot and view the results in the monitor.

In i-TTL, use the flash panel or bounce adapter provided with the flash unit. Do not use other panels such as diffusion panels, as this may produce incorrect exposure. The D3S supports power zoom with the following optional flash units: the SB-900, SB-800, and SB-600. Power zoom is not supported with other flash units.



✓ Notes on Optional Flash Units (Continued)

The SB-900, SB-800, SB-600, and SB-400 provide red-eye reduction in red-eye reduction and slow sync with red-eye reduction modes, while the SB-900, SB-800, SB-600, and SU-800 provide AF-assist illumination when the conditions for AF-assist illumination are met. When used with AF lenses with focal lengths of 17–135 mm, the SB-900 provides AF-assist illumination for all focus points; note, however, that autofocus is available only with the following focus points:

| | | | | | |
|-----------------|---|------------------|---|-------------------|---|
| 17–19 mm |  | 20–105 mm |  | 106–135 mm |  |
|-----------------|---|------------------|---|-------------------|---|

When used with AF lenses with focal lengths of 24–105 mm, the SB-800, SB-600, and SU-800 provide AF-assist illumination to assist autofocus for the following focus points:

| | | | | | |
|-----------------|---|-----------------|---|------------------|---|
| 24–34 mm |  | 35–49 mm |  | 50–105 mm |  |
|-----------------|---|-----------------|---|------------------|---|

In programmed auto, the maximum aperture (minimum f-number) is limited according to sensitivity (ISO equivalency), as shown below:

| Maximum aperture at ISO equivalent of: | | | | | | |
|--|------------|------------|-------------|-------------|-------------|--------------|
| 200 | 400 | 800 | 1600 | 3200 | 6400 | 12800 |
| 4.8 | 5.6 | 6.7 | 8 | 9.5 | 11 | 13 |

For each one-step increase in sensitivity (e.g., from 200 to 400), aperture is stopped down by half an f-stop. If the maximum aperture of the lens is smaller than given above, the maximum value for aperture will be the maximum aperture of the lens.

✓ Use Only Nikon Flash Accessories

Use only Nikon flash units. Negative voltages or voltages over 250 V applied to the accessory shoe could not only prevent normal operation, but damage the sync circuitry of the camera or flash. Before using a Nikon flash unit not listed in this section, contact a Nikon-authorized service representative for more information.



i-TTL Flash Control

When a CLS-compatible flash unit is set to TTL, the camera automatically selects one of the following types of flash control:







i-TTL balanced fill-flash for digital SLR: Flash unit emits series of nearly invisible preflashes (monitor preflashes) immediately before main flash. Preflashes reflected from objects in all areas of frame are picked up by 1,005-pixel RGB sensor and are analyzed in combination with range information from matrix metering system to adjust flash output for natural balance between main subject and ambient background lighting. If type G or D lens is used, distance information is included when calculating flash output. Precision of calculation can be increased for non-CPU lenses by providing lens data (focal length and maximum aperture; see □ 214). Not available when spot metering is used.

Standard i-TTL flash for digital SLR: Flash output adjusted to bring lighting in frame to standard level; brightness of background is not taken into account. Recommended for shots in which main subject is emphasized at expense of background details, or when exposure compensation is used. Standard i-TTL flash for digital SLR is activated automatically when spot metering is selected.



Flash Modes

The camera supports the following flash modes:

| Flash mode | Description |
|---|--|
|  Front-curtain sync | This mode is recommended for most situations. In programmed auto and aperture-priority auto modes, shutter speed will automatically be set to values between $1/250$ and $1/60$ s ($1/8,000$ to $1/60$ s with Auto FP High-Speed Sync;  311). |
|  Slow sync | Flash is combined with shutter speeds as slow as 30 s to capture both subject and background at night or under dim light. This mode is only available in programmed auto and aperture-priority auto exposure modes. Use of tripod is recommended to prevent blurring caused by camera shake. |
|  Rear-curtain sync | In shutter-priority auto or manual exposure mode, flash fires just before the shutter closes. Use to create effect of a stream of light behind moving objects. In programmed auto and aperture-priority auto, slow rear-curtain sync is used to capture both subject and background. Use of tripod is recommended to prevent blurring caused by camera shake. |
|  Red-eye reduction | In this mode (available only with SB-900, SB-800, SB-600, and SB-400), red-eye reduction pre-flash lights for approximately one second before main flash. Pupils in subject's eyes contract, reducing "red-eye" effect sometimes caused by flash. Owing to one-second shutter-release delay, this mode is not recommended with moving subjects or in other situations in which quick shutter response is required. Avoid moving camera while red-eye reduction pre-flash is lit. |
|  Red-eye reduction with slow sync | Combines red-eye reduction with slow sync. Use for portraits taken against a backdrop of night scenery. Available only with SB-900, SB-800, SB-600, and SB-400 in programmed auto and aperture-priority auto exposure modes. Use of a tripod is recommended to prevent blurring caused by camera shake. |



■ ■ Choosing a Flash Mode

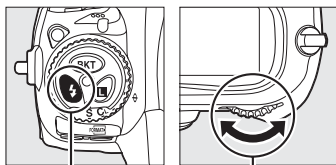

To choose the flash mode, press the  button and rotate the main command dial until the desired flash mode is selected in the top control panel:

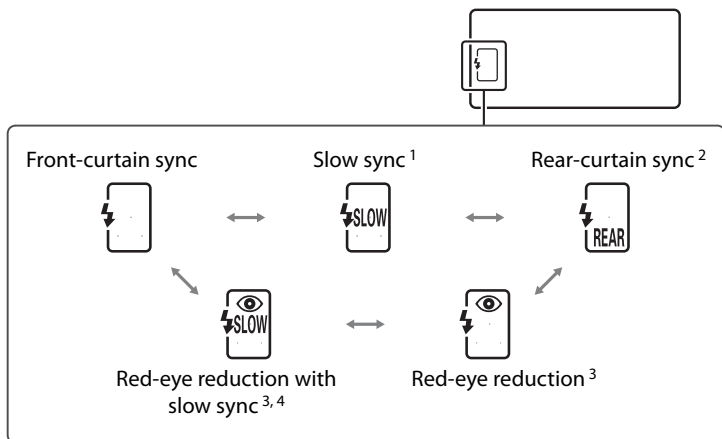

 button

Main command dial



- 1 Available only in exposure modes **P** and **A**. In modes **S** and **M**, slow sync becomes front-curtain sync.
- 2 In exposure modes **P** and **A**, flash-sync mode will be set to slow rear-curtain sync when the  button is released.
- 3  icon blinks if flash unit does not support red-eye reduction.
- 4 Red-eye reduction with slow sync is available only in exposure modes **P** and **A**. In modes **S** and **M**, red-eye reduction with slow sync becomes red-eye reduction.



Studio Flash Systems

Rear-curtain sync can not be used with studio flash systems, as the correct synchronization can not be obtained.

Shutter Speed and Aperture

Shutter speed and aperture can be set as follows when an optional flash unit is used:



| Mode | Shutter speed | Aperture | See page |
|----------|--|--|----------|
| <i>P</i> | Set automatically by camera ($1/250\text{ s}$ – $1/60\text{ s}$) ^{1,2} | Set automatically by camera | 120 |
| <i>S</i> | Value selected by user ($1/250\text{ s}$ – 30 s) ² | | 122 |
| <i>A</i> | Set automatically by camera ($1/250\text{ s}$ – $1/60\text{ s}$) ^{1,2} | Value selected by user ³ | 123 |
| <i>M</i> | Value selected by user ($1/250\text{ s}$ – 30 s , b – l , b) ² | | 125 |

1 Shutter speed may be set as slow as 30 s in slow sync, slow rear-curtain sync, and slow sync with red-eye reduction flash modes.

2 Speeds as fast as $1/8,000\text{ s}$ are available with optional SB-900, SB-800, and SB-600 flash units when **1/250 s (Auto FP)** is selected for Custom Setting e1 (**Flash sync speed**,  311).

3 Flash range varies with aperture and ISO sensitivity. When setting aperture in exposure modes *A* and *M*, consult the table of flash ranges provided with optional flash unit.

See Also

For information on choosing a flash sync speed, see Custom Setting e1 (**Flash sync speed**,  311). For information on choosing the slowest shutter speed available when using the flash, see Custom Setting e2 (**Flash shutter speed**,  312).



FV Lock

This feature is used to lock flash output, allowing photographs to be recomposed without changing the flash level and ensuring that flash output is appropriate to the subject even when the subject is not positioned in the center of the frame. Flash output is adjusted automatically for any changes in ISO sensitivity and aperture. FV lock is available with CLS compatible flash units only.

To use FV lock:

1 Assign FV lock to the Fn button.

Select **FV lock** for Custom Setting f4 (Assign Fn button > Fn button press,  316).



2 Attach a CLS-compatible flash unit.

Mount an SB-900, SB-800, SB-600, SB-400, or SU-800 on the camera accessory shoe.

3 Set the flash unit to TTL or AA mode.

 Turn the flash unit on and set the flash mode to TTL or AA. See the Speedlight instruction manual for details.

4 Focus.

Position the subject in the center of the frame and press the shutter-release button halfway to focus.

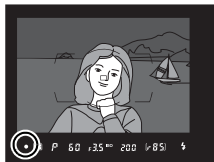

5 Lock flash level.

After confirming that the flash ready indicator (⚡) is displayed in the viewfinder, press the **Fn** button. The flash will emit a monitor preflash to determine the appropriate flash level. Flash output will be locked at this level and FV lock icons (⚡LOCK and **FV**) will appear in the top control panel and viewfinder.

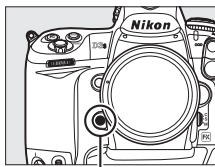

Fn button

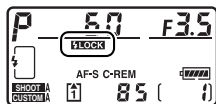

6 Recompose the photograph.

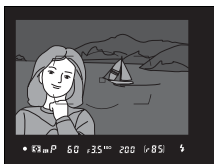

7 Take the photograph.

Press the shutter-release button the rest of the way down to shoot. If desired, additional pictures can be taken without releasing FV lock.

8 Release FV lock.



Press the **Fn** button to release FV lock. Confirm that the FV lock icons (**LOCK** and **FL**) are no longer displayed in the top control panel and viewfinder.

Metering

The metering areas for FV lock are as follows:

| Flash unit | Flash mode | Metered area |
|--|------------------|--------------------------------------|
| Stand-alone flash unit | i-TTL | 5-mm circle in center of frame |
| | AA | Area metered by flash exposure meter |
| Used with other flash units (Advanced Wireless Lighting) | i-TTL | Entire frame |
| | AA | Area metered by flash exposure meter |
| | A (master flash) | |

See Also

For information on using the **Pv** or **AE-L/AF-L** button for FV lock, see Custom Setting f5 (**Assign preview button**,  321) or Custom Setting f6 (**Assign AE-L/AF-L button**,  321).



Other Shooting Options

This chapter covers restoring default settings, making multiple exposures, interval timer photography, and using GPS units and non-CPU lenses.

| | |
|---|------------|
| Two-Button Reset: Restoring Default Settings | 200 |
| Multiple Exposure | 202 |
| Interval Timer Photography | 208 |
| Non-CPU Lenses | 214 |
| Using a GPS Unit..... | 217 |



Two-Button Reset: Restoring Default Settings

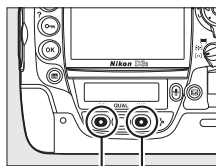

The camera settings listed below can be restored to default values by holding the **ISO** and **WB** buttons down together for more than two seconds (these buttons are marked by a green dot). The control panels turn off briefly while settings are reset.



ISO button WB button

| Option | Default |
|-----------------------|------------------|
| Focus point | Center |
| Exposure mode | Programmed auto |
| Flexible program | Off |
| Exposure compensation | Off |
| AE lock hold | Off ¹ |
| Aperture lock | Off |

| Option | Default |
|--------------------|--------------------|
| Shutter-speed lock | Off |
| Bracketing | Off ² |
| Flash mode | Front-curtain sync |
| FV lock | Off |
| Multiple exposure | Off ³ |

- 1 Custom Setting f6 (**Assign AE-L/AF-L button**,  321) is unaffected.
- 2 Number of shots is reset to zero. Bracketing increment is reset to 1EV (exposure/flash bracketing) or 1 (white balance bracketing).  **Auto** is selected for the second shot of two-shot ADL bracketing programs.
- 3 If multiple exposure is currently in progress, shooting will end and multiple exposure will be created from exposures recorded to that point. Gain and number of shots are not reset.

The following shooting-menu options will also be reset. Only settings in the bank currently selected using the **Shooting menu bank** option will be reset (☐ 285). Settings in the remaining banks are unaffected.

| Option | Default | Option | Default |
|---------------|-------------|-----------------|---------|
| Image quality | JPEG normal | White balance | Auto* |
| Image size | Large | ISO sensitivity | 200 |

* Fine-tuning off.

If the current Picture Control has been modified, existing settings for the Picture Control will also be restored.



 **See Also**

See page 392 for a list of default settings.

Multiple Exposure



Follow the steps below to record a series of two to ten exposures in a single photograph. Multiple exposures can be recorded at any image quality setting, and produce results with colors noticeably better than photographs combined in an imaging application because they make use of RAW data from the camera image sensor.

■ Creating a Multiple Exposure

Note that shooting will end and a multiple exposure will be recorded automatically if no operations are performed for 30 s.

Extended Recording Times

For an interval between exposures of more than 30 s, either:

- choose **No limit** for Custom Setting c2 (**Auto meter-off delay**,  305), or
- select **On** for **Image review** ( 281) and choose a long display time for Custom Setting c4 (**Monitor off delay**) > **Image review** ( 306). The monitor-off delay will be set to a value 30 s longer than the option selected for Custom Setting c4.

1 Select Multiple exposure in the shooting menu.

Press the **MENU** button to display the menus. Highlight **Multiple exposure** in the shooting menu and press .

MENU button

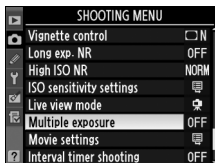
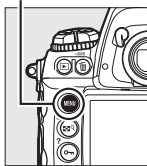

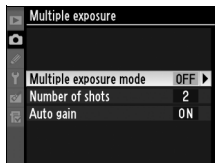

2 Select a mode.

Highlight **Multiple exposure mode** and press ►.



Highlight one of the following and press OK:

- **To take a series of multiple exposures**, select  **On (series)**. Multiple exposure shooting will continue until you select **Off** for **Multiple exposure mode**.
- **To take one multiple exposure**, select  **On (single photo)**. Normal shooting will resume automatically after you have created a single multiple exposure.
- **To exit without creating additional multiple exposures**, select **Off**.



If **On (series)** or **On (single photo)** is selected, a  icon will be displayed in the top control panel.

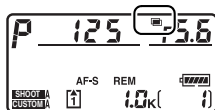

3 Choose the number of shots.

Highlight **Number of shots** and press **▶**.

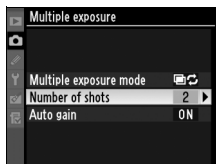

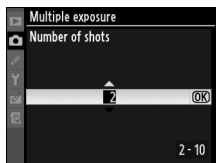

Press **▲** or **▼** to choose the number of exposures that will be combined to form a single photograph and press **OK**.



The BKT Button

If **Multiple exposure** is selected for Custom Setting f7 (**Assign BKT button;**  322), you can select the multiple exposure mode by pressing the **BKT** button and rotating the main command dial and the number of shots by pressing the **BKT** button and rotating the sub-command dial. The mode and number of shots are shown in the top control panel:

 appears when **On (series)** is selected and  when **On (single photo)** is selected; no icon appears when multiple exposure is off.

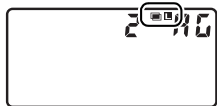

4 Adjust gain.

Highlight **Auto gain** and press

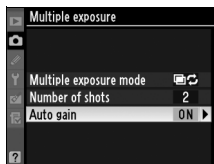

Highlight one of the following options and press .

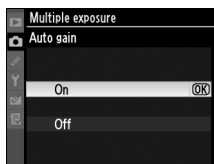



| Option | Description |
|------------|---|
| On | Gain adjusted according to number of exposures actually recorded (gain for each exposure is set to $1/2$ for 2 exposures, $1/3$ for 3 exposures, etc.). |
| Off | Gain is not adjusted when recording multiple exposure. Recommended if background is dark. |

5 Frame a photograph, focus, and shoot.

In continuous high-speed and continuous low-speed release modes ( 102), the camera records all exposures in a single burst. If **On (series)** is selected, the camera will continue to record multiple exposures while the shutter-release button is pressed; if **On (single photo)** is selected, multiple exposure shooting will end after the first photograph. In other release modes, one photograph will be taken each time the shutter-release button is pressed; continue shooting until all exposures have been recorded (for information on interrupting a multiple exposure before all photographs are recorded, see page 206).



The  icon will blink until shooting ends. If **On (single photo)** is selected, multiple exposure shooting ends automatically when the multiple exposure is complete; if **On (series)** is selected, multiple exposure shooting will only end when **Off** is selected for multiple exposure mode. The  icon clears from the display when multiple exposure shooting ends.

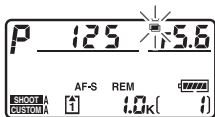

■ Interrupting Multiple Exposures

To interrupt a multiple exposure before the specified number of exposures have been taken, select **Off** for multiple exposure mode. If shooting ends before the specified number of exposures have been taken, a multiple exposure will be created from the exposures that have been recorded to that point. If **Auto gain** is on, gain will be adjusted to reflect the number of exposures actually recorded. Note that shooting will end automatically if:

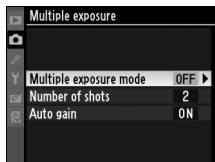

- A two-button reset is performed (📖 200)
- The camera is turned off
- The battery is exhausted
- Pictures are deleted



Multiple Exposure

Do not remove or replace the memory card while recording a multiple exposure.

Multiple exposures can not be recorded in live view (☐ 404). Taking photographs in live view resets **Multiple exposure mode** to **Off**.

The information listed in the playback photo information display (including date of recording and camera orientation) is for the first shot in the multiple exposure.

If no operations are performed for 30 s after the monitor has turned off during playback or menu operations, shooting will end and a multiple exposure will be created from the exposures that have been recorded to that point.

Voice Memos

The camera stores only the last voice memo created during a multiple exposure.

Interval Timer Photography

If interval timer photography is activated before the first exposure is taken, the camera will record exposures at the selected interval until the number of exposures specified in the multiple exposure menu have been taken. The number of shots listed in the interval timer shooting menu is ignored; to prevent interval timer shooting from ending before all exposures are taken, either choose **No limit** for Custom Setting c2 (**Auto meter-off delay**, ☐ 305), or select **On** for **Image review** (☐ 281) and choose a long display time for Custom Setting c4 (**Monitor off delay**) > **Image review** (☐ 306) to extend the monitor-off delay to a value 30 s longer than that selected for Custom Setting c4. These exposures will then be recorded as a single photograph and interval timer shooting will end (if **On (single photo)** is selected for multiple exposure mode, multiple exposure shooting will also end automatically). Cancelling multiple exposure cancels interval timer shooting.

Other Settings

While a multiple exposure is being shot, memory cards can not be formatted and some menu items are grayed out and can not be changed.



Interval Timer Photography

The camera is equipped to take photographs automatically at preset intervals.

✓ Before Shooting

Select a release mode other than self-timer (☺) or mirror up (MUP) when using the interval timer. Before beginning interval timer photography, take a test shot at current settings and view the results in the monitor. Remember that the camera will focus before each shot—no shots will be taken if the camera is unable to focus in single-servo AF.

Before choosing a starting time, select **Time zone and date** in the setup menu and make sure that the camera clock is set to the correct time and date (☞ 34).

Use of a tripod is recommended. Mount the camera on a tripod before shooting begins. To ensure that shooting is not interrupted, be sure the battery is fully charged.

1 Select Interval timer shooting in the shooting menu.

Press the MENU button to display the menus. Highlight **Interval timer shooting** in the shooting menu and press ►.

MENU button

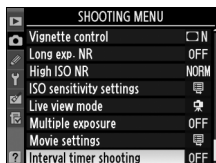
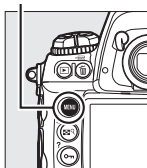

2 Select a starting trigger.

Highlight one of the following and press ►:

- To start shooting about 3 s after settings are completed, select **Now** and proceed to Step 4.
- To choose a starting time, select **Start time** and proceed to Step 3.

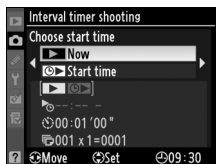

3 Choose a start time.

Press ◀ or ▶ to highlight hours or minutes; press ▲ or ▼ to change. The starting time is not displayed if **Now** is selected for **Choose start time**. Press ▶ to continue.

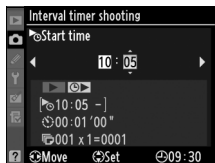

4 Choose an interval.

Press ◀ or ▶ to highlight hours, minutes, or seconds; press ▲ or ▼ to change. Choose an interval longer than the slowest anticipated shutter speed. Press ▶ to continue.

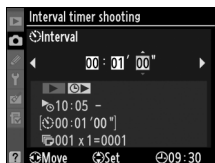

5 Choose the number of intervals and number of shots per interval.

Press ◀ or ▶ to highlight number of intervals or number of shots; press ▲ or ▼ to change. Press ▶ to continue.

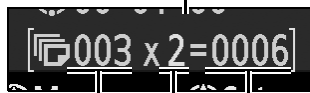
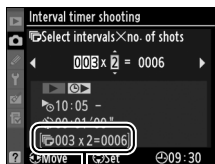

Number of intervals

Number of shots/
interval

Total number of
shots



6 Start shooting.

Highlight **Start > On** and press **OK** (to return to the shooting menu without starting the interval timer, highlight **Start > Off** and press **OK**). The

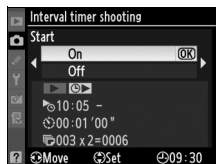

first series of shots will be taken at the specified starting time, or after about 3 s if **Now** was selected for **Choose start time** in Step 2. Shooting will continue at the selected interval until all shots have been taken. Note that because shutter speed and the time needed to record the image to the memory card may vary from shot to shot, the interval between a shot being recorded and the start of the next shot may vary. If shooting can not proceed at current settings (for example, if a shutter speed of **1/4000** is currently selected in manual exposure mode or the start time is in less than a minute), a warning will be displayed in the monitor.

Close the Viewfinder Eyepiece Shutter

When taking photos without your eye to the viewfinder, close the viewfinder eyepiece shutter to prevent light entering via the viewfinder from appearing in photographs or interfering with exposure.

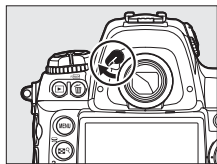

Out of Memory

If the memory card is full, the interval timer will remain active but no pictures will be taken. Resume shooting ([212](#)) after deleting some pictures or turning the camera off and inserting another memory card.

Bracketing

Adjust bracketing settings before starting interval timer photography. If exposure, flash, or ADL bracketing is active while interval timer photography is in effect, the camera will take the number of shots in the bracketing program at each interval, regardless of the number of shots specified in the interval timer menu. If white balance bracketing is active while interval timer photography is in effect, the camera will take one shot at each interval and process it to create the number of copies specified in the bracketing program.

During Shooting

During interval timer photography, the **INTERVAL** icon will blink in the top control panel. Immediately before the next shooting interval begins, the shutter speed display will show the number of intervals remaining, and the aperture display will show the number of shots remaining in the current interval. At other times, the number of intervals remaining and the number of shots in each interval can be viewed by pressing the shutter-release button halfway (once the button is released, the shutter speed and aperture will be displayed until the exposure meters turn off).

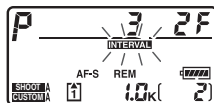

To view current interval timer settings, select **Interval timer shooting** between shots. While interval timer photography is in progress, the interval timer menu will show the starting time, the shooting interval, and the number of intervals and shots remaining. None of these items can be changed while interval timer photography is in progress.

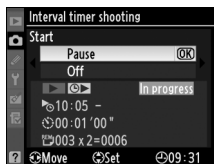

Using the Monitor

Pictures can be played back and shooting and menu settings can be adjusted freely while interval timer photography is in progress. The monitor will turn off automatically about four seconds before each interval.



■ Pausing Interval Timer Photography

Interval time photography can be paused by:

- Pressing the **OK** button between intervals
- Highlighting **Start > Pause** in the interval timer menu and pressing **OK**
- Turning the camera off and then on again (if desired, the memory card can be replaced while the camera is off)
- Selecting self-timer (☺) or mirror-up (**MUP**) release modes
- Pressing the **Lv** button

To resume shooting:

1 Choose a new starting trigger.

Choose a new starting trigger and start time as described on page 208.

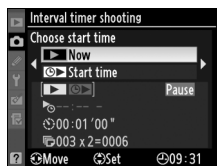

2 Resume shooting.

Highlight **Start > Restart** and press **OK**. Note that if interval timer photography was paused during shooting, any shots remaining in the current interval will be canceled.

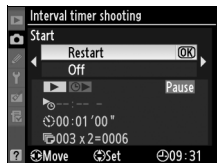

■ Interrupting Interval Timer Photography

Interval timer shooting will end automatically if the battery is exhausted. Interval timer photography can also be ended by:

- Selecting **Start** > **Off** in the interval timer menu
- Performing a two button reset (☞ 200)
- Selecting **Reset shooting menu** in the shooting menu (☞ 287)
- Changing bracketing settings (☞ 136)

Normal shooting will resume when interval timer photography ends.

■ No Photograph

Photographs will not be taken if the previous photograph has yet to be taken, the memory buffer or memory card is full, or the camera is unable to focus in single-servo AF (note that the camera focuses again before each shot).

Release Mode

Regardless of the release mode selected, the camera will take the specified number of shots at each interval. In **C** (continuous high speed) mode, photographs will be taken at a rate of up to nine shots per second, or, if **DX (24×16)** is selected for **Image area**, at the frame rate selected for Custom Setting d2 (**Shooting speed**; ☞ 307) > **Continuous high-speed**. In **S** (single frame) and **L** (continuous low-speed) modes, photographs will be taken at the rate chosen for Custom Setting d2 (**Shooting speed**, ☞ 307) > **Continuous low-speed**; in mode **Q**, camera noise will be reduced.

Shooting Menu Banks

Changes to interval timer settings apply to all shooting menu banks (☞ 285). If shooting menu settings are reset using the **Reset shooting menu** item in the shooting menu (☞ 287), interval timer settings will be reset as follows:

- Choose start time: Now
- Interval: 00:01:00"
- Number of intervals: 1
- Number of shots: 1
- Start shooting: Off



Non-CPU Lenses

By specifying lens data (lens focal length and maximum aperture), the user can gain access to a variety of CPU lens functions when using a non-CPU lens. If the focal length of the lens is known:

- Power zoom can be used with SB-900, SB-800, and SB-600 flash units (available separately)
- Lens focal length is listed (with an asterisk) in the playback photo info display

When the maximum aperture of the lens is known:

- The aperture value is displayed in the top control panel and viewfinder
- Flash level is adjusted for changes in aperture
- Aperture is listed (with an asterisk) in the playback photo info display

Specifying both the focal length and maximum aperture of the lens:

- Enables color matrix metering (note that it may be necessary to use center-weighted or spot metering to achieve accurate results with some lenses, including Reflex-NIKKOR lenses)
- Improves the precision of center-weighted and spot metering and i-TTL balanced fill-flash for digital SLR



Focal Length Not Listed

If the correct focal length is not listed, choose the closest value greater than the actual focal length of the lens.

Zoom Lenses

Lens data are not adjusted when non-CPU lenses are zoomed in or out. After changing the zoom position, select new values for lens focal length and maximum aperture.

■ The Non-CPU Lens Data Menu

1 Select Non-CPU lens data in the setup menu.

Press the **MENU** button to display the menus.

Highlight **Non-CPU lens data** in the setup menu and press **▶**.

MENU button

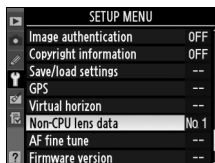
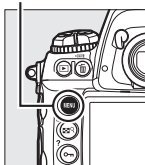

2 Select a lens number.

Highlight **Lens number** and press **◀** or **▶** to choose a lens number between 1 and 9.

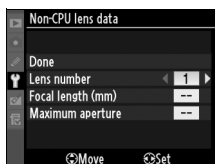

3 Select a focal length.

Highlight **Focal length (mm)** and press **◀** or **▶** to choose a focal length between 6 and 4,000 mm.

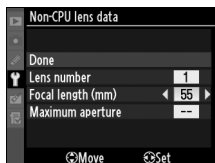

4 Select a maximum aperture.

Highlight **Maximum aperture** and press **◀** or **▶** to choose a maximum aperture between $f/1.2$ and $f/22$. The maximum aperture for teleconverters is the combined maximum aperture of the teleconverter and lens.

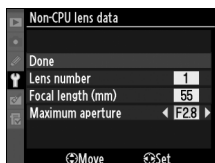

5 Select Done.

Highlight **Done** and press . The specified focal length and aperture will be stored under the chosen lens number. This combination of focal length and aperture can be recalled at any time by selecting the lens number using camera controls as described below.

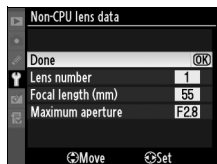

Choosing a Lens Number Using Camera Controls

1 Assign non-CPU lens number selection to a camera control.

Select **Choose non-CPU lens number** as the “+command dials” option for a camera control in the Custom Settings menu (□ 319). Non-CPU lens number selection can be assigned to the **Fn** button (Custom Setting f4, **Assign Fn button**, □ 316), the **Pv** button (Custom Setting f5, **Assign preview button**, □ 321), or the **AE-L/AF-L** button (Custom Setting f6, **Assign AE-L/AF-L button**, □ 321).

2 Use the selected control to choose a lens number.

Press the selected button and rotate the main command dial until the desired lens number is displayed in the top control panel.

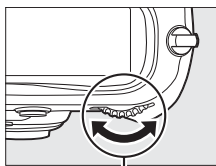

Main command dial

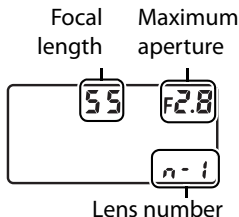

Using a GPS Unit

A GPS unit can be connected to the ten-pin remote terminal, allowing the current latitude, longitude, altitude, Coordinated Universal Time (UTC), and heading to be recorded with each photograph taken. The camera can be used with an optional GP-1 GPS unit (see below; note that the GP-1 does not provide the compass heading), or with third-party units connected via an optional MC-35 GPS adapter cord (📄 218).

■ ■ *The GP-1 GPS Unit*

The GP-1 is an optional GPS unit designed for use with Nikon digital cameras. For information on connecting the unit, see the manual provided with the GP-1.



■ Other GPS Units

Garmin GPS units that conform to version 2.01 or 3.01 of the National Marine Electronics Association NMEA0183 data format can be connected to the camera's ten-pin remote terminal using an MC-35 GPS adapter cord (available separately; □ 376). Operation has been confirmed with Garmin eTrex and Garmin geko series devices equipped with a PC interface cable connector. These devices connect to the MC-35 using a cable with a D-sub 9-pin connector provided by the manufacturer of the GPS device. See the MC-35 instruction manual for details. Before turning the camera on, set the GPS device to NMEA mode (4800 baud).

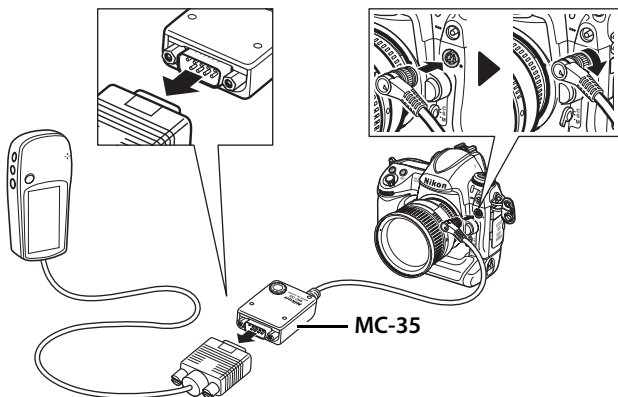

■ ■ The GPS Icon

When the camera establishes communication with a GPS device, a GPS icon will be displayed in the top control panel.

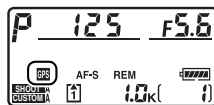
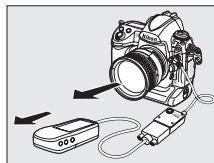

Photo information for pictures taken while the GPS icon is displayed will include a page of GPS data (233). GPS data are only recorded when the GPS icon is displayed; confirm that the GPS icon is displayed before shooting (a flashing GPS icon indicates that the GPS device is searching for a signal; pictures taken while the GPS icon is flashing will not include GPS data). If no data are received from the GPS unit for two seconds, the GPS icon will clear from the display and the camera will stop recording GPS information.

Heading

The heading is only recorded if the GPS device is equipped with a digital compass (note that the GP-1 is not equipped with a compass). Keep the GPS device pointing in the same direction as the lens and at least 20cm (8 in.) from the camera.



Coordinated Universal Time (UTC)

UTC data is provided by the GPS device and is independent of the camera clock.

■ Setup Menu Options

The **GPS** item in the setup menu contains the options listed below.

- **Auto meter off:** Choose whether or not the exposure meters will turn off automatically when a GPS unit is attached.

| Option | Description |
|---------|--|
| Enable | Exposure meters will turn off automatically if no operations are performed for the period specified in Custom Setting c2 (Auto meter-off delay ; to allow the camera time to acquire GPS data, the delay is extended by up to one minute after exposure meters are activated or the camera is turned on). This reduces the drain on the battery. |
| Disable | Exposure meters will not turn off while a GPS unit is connected; GPS data will always be recorded. |

- **Position:** This item is only available if a GPS device is connected, when it displays the current latitude, longitude, altitude, Coordinated Universal Time (UTC), and heading (if supported) as reported by the GPS device.

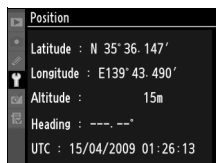

- **Use GPS to set camera clock:** Select **No** to set the camera clock independently of the GPS device. Note that when **Yes** is selected, the time will automatically be adjusted according to the date format, time zone, and daylight savings time options selected in the **Time zone and date** menu (📖 34, 330).





More About Playback

– *Playback Options*

This chapter describes how to play back photographs and details the operations that can be performed during playback.

| | |
|--|-----|
| Full-Frame Playback | 222 |
| Photo Information | 225 |
| Viewing Multiple Images: Thumbnail Playback | 235 |
| Taking a Closer Look: Playback Zoom | 237 |
| Protecting Photographs from Deletion | 238 |
| Deleting Photographs | 240 |



Full-Frame Playback

To play photographs back, press the  button. The most recent photograph will be displayed in the monitor.

 button

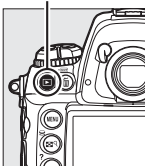

 button

 button

MENU button

 button

 button

 button

 button

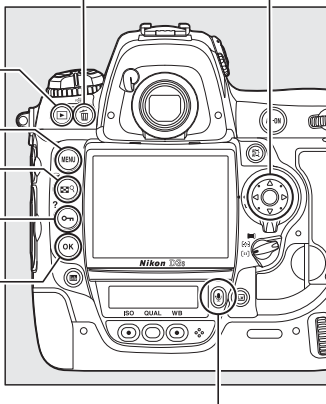

Multi selector

Sub-command dial

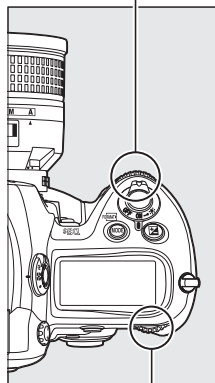









Main command dial



Rotate Tall

To display “tall” (portrait-orientation) photographs in tall orientation, select **On** for the **Rotate tall** option in the playback menu (☞ 282). Note that because the camera itself is already in the appropriate orientation during shooting, images are not rotated automatically during image review (☞ 224).



| To | Use | Description |
|--------------------------------|--|---|
| View additional photographs |  | Press ► to view photographs in order recorded, ◀ to view photographs in reverse order. |
| View photo information |  | Press ▲ or ▼ to view information about current photograph (☞ 225). |
| View thumbnails |  | See page 235 for more information on the thumbnail display. |
| Zoom in on photograph |  | See page 237 for more information on playback zoom. |
| Delete images |  | Confirmation dialog will be displayed. Press ☒ again to delete photo (☞ 240). |
| Record/play voice memo |  | If voice memo has not been recorded, voice memo will be recorded while ☒ button is pressed. If voice memo has been recorded, pressing ☒ button will start playback (☞ 246). |
| Change protect status |  | To protect image, or to remove protection from protected image, press ☒ button (☞ 238). |
| View images in other locations |  | Choose card and folder from which pictures are played back (☞ 224). |
| Return to shooting mode |  | Monitor will turn off. Photographs can be taken immediately. |
| Display menus | MENU | See page 273 for more information. |







| To | Use | Description |
|------------|---|---|
| Play movie |  | If current picture is marked with  icon to show that it is a movie, pressing center of multi selector starts movie playback (☞ 73). |
| Edit movie |  | Create edited copy of current movie (☞ 74). |

Image Review

When **On** is selected for **Image review** in the playback menu (☞ 281), photographs are automatically displayed in the monitor after shooting (because the camera is already in the correct orientation, images are not rotated automatically during image review). In single-frame, quiet shutter-release, self-timer, and mirror-up release modes, photographs are displayed one at a time as they are taken. In continuous release mode, display begins when shooting ends, with the first photograph in the current series displayed.

Two Memory Cards

Holding the  button and pressing  in full-frame or thumbnail playback displays the menu shown at right. Highlight the desired slot and press  to display a list of folders, then highlight a folder and press  to view the pictures in the selected folder. The same method can be used to choose a slot when selecting images for operations in the playback (☞ 274) or retouch menus (☞ 341) or when choosing an image as the source for preset white balance (☞ 165).



See Also

For information on choosing how long the monitor will remain on when no operations are performed, see Custom Setting c4 (**Monitor off delay**, ☞ 306).





The roles of the multi selector buttons can be reversed, so that the  and  buttons display other images and the  and  buttons control photo information. See Custom Setting f3 (**Photo info/playback**, ☞ 315) for details.

Photo Information

Photo information is superimposed on images displayed in full-frame playback. There are up to 9 pages of information for each photo. Press ▲ or ▼ to cycle through photo information as shown below. Note that shooting data, RGB histograms, and highlights are only displayed if corresponding option is selected for **Display mode** (☞ 277; shooting data page 4 is only displayed if copyright information was recorded with the photograph as described on page 335). GPS data are only displayed if a GPS device was used when the photo was taken.



File Information

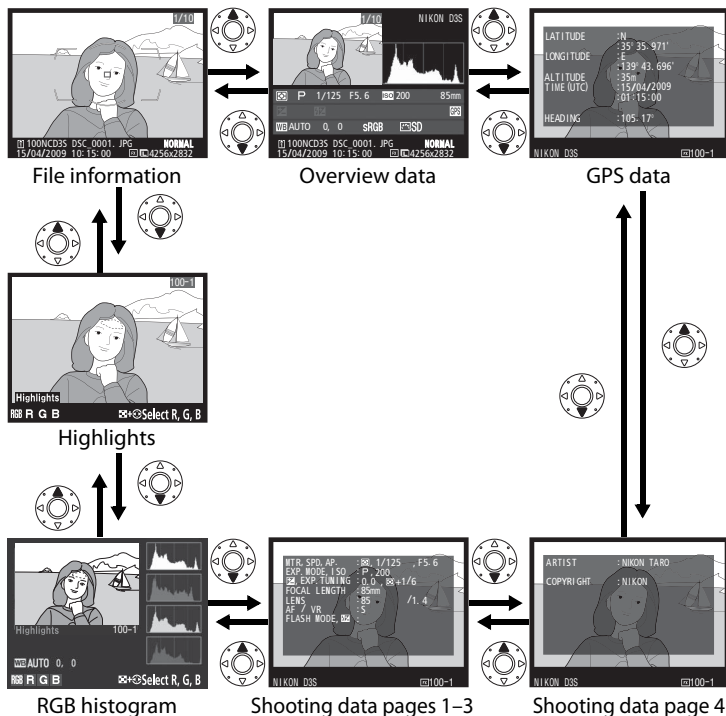
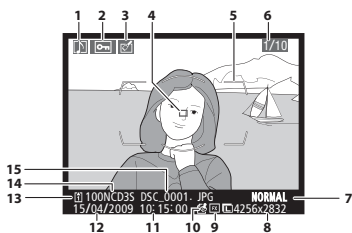

| | | |
|----|-------------------------------------|--------|
| 1 | Voice memo icon | 246 |
| 2 | Protect status | 238 |
| 3 | Retouch indicator | 341 |
| 4 | Focus point ^{1,2} | 94 |
| 5 | AF-area brackets ¹ | 41, 59 |
| 6 | Frame number/total number of frames | |
| 7 | Image quality | 83 |
| 8 | Image size | 86 |
| 9 | Image area ³ | 78 |
| 10 | Image authentication | 334 |
| 11 | Time of recording | 34 |
| 12 | Date of recording | 34 |
| 13 | Slot number | 37 |
| 14 | Folder name | 288 |
| 15 | File name | 290 |

- 1 Displayed only if **Focus point** is selected for **Display mode** (☐ 277).
- 2 If photograph was taken in focus mode **S**, display shows point where focus first locked. In focus mode **C**, focus point is only displayed if single-point or dynamic area was selected for AF-area mode and camera was able to focus.
- 3 Displayed in yellow if **1.2x (30×20)**, **DX (24×16)** or **5 : 4 (30×24)** was selected for the **Image area** option (☐ 78) in the shooting menu.



Highlights¹

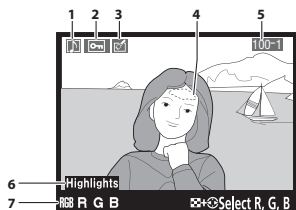

| | | |
|---|---|-----|
| 1 | Voice memo icon..... | 246 |
| 2 | Protect status | 238 |
| 3 | Retouch indicator..... | 341 |
| 4 | Image highlights ² | |
| 5 | Folder number–frame number ³ | 288 |
| 6 | Highlight display indicator | 277 |
| 7 | Current channel ² | |

- 1 Displayed only if **Highlights** is selected for **Display mode** (☐ 277).
- 2 Blinking areas indicate highlights (areas that may be overexposed) for current channel. Press ◀ or ▶ while pressing  button to cycle through channels as follows:

button

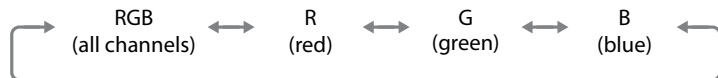
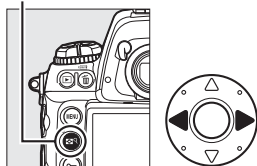

- 3 Displayed in yellow if **1.2× (30×20)**, **DX (24×16)** or **5:4 (30×24)** was selected for the **Image area** option (☐ 78) in the shooting menu.



■ RGB Histogram ¹

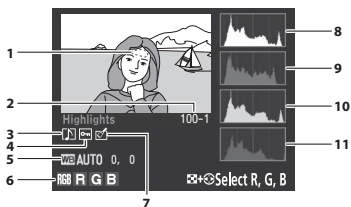

- 1** Image highlights ²
- 2** Folder number–frame number ³ 288
- 3** Voice memo icon 246
- 4** Protect status 238

- 5** White balance 150
- Color temperature 157
- White balance fine-tuning 153
- Preset manual 158
- 6** Current channel ²
- 7** Retouch indicator 341
- 8** Histogram (RGB channel) ⁴. In all histograms, horizontal axis gives pixel brightness, vertical axis number of pixels.
- 9** Histogram (red channel) ⁴
- 10** Histogram (green channel) ⁴
- 11** Histogram (blue channel) ⁴

- 1 Displayed only if **RGB histogram** is selected for **Display mode** (☐ 277).
- 2 Blinking areas indicate highlights (areas that may be overexposed) for current channel. Press ◀ or ▶ while pressing  button to cycle through channels as follows:

 button

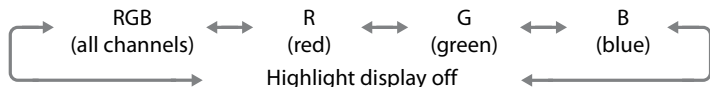
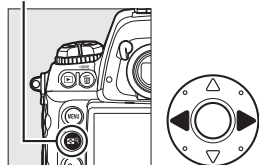

- 3 Displayed in yellow if **1.2x (30×20)**, **DX (24×16)** or **5 : 4 (30×24)** was selected for the **Image area** option (☐ 78) in the shooting menu.

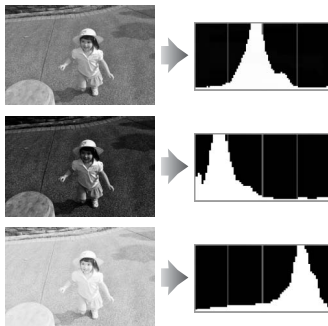

4 Some sample histograms are shown below:

- If the image contains objects with a wide range of brightnesses, the distribution of tones will be relatively even.
- If the image is dark, tone distribution will be shifted to the left.
- If the image is bright, tone distribution will be shifted to the right.



Increasing exposure compensation shifts the distribution of tones to the right, while decreasing exposure compensation shifts the distribution to the left. Histograms can provide a rough idea of overall exposure when bright ambient lighting makes it difficult to see photographs in the monitor.

Playback Zoom

To display an RGB histogram for the area visible in the monitor, press the  button, rotate the main command dial to the right, and then release the  button. Use the multi selector to view other areas of the image; to zoom out, press the  button and rotate the main command dial to the left.



Histograms

Camera histograms are intended as a guide only and may differ from those displayed in imaging applications.

Shooting Data Page 1¹

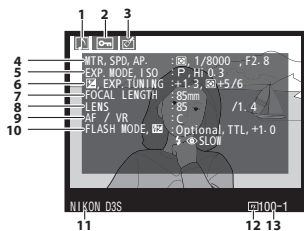

| | | |
|---|-------------------|----------|
| 1 | Voice memo icon | 246 |
| 2 | Protect status | 238 |
| 3 | Retouch indicator | 341 |
| 4 | Metering method | 116 |
| | Shutter speed | 122, 126 |
| | Aperture | 123, 126 |

| | | |
|----|--|-----|
| 5 | Exposure mode | 118 |
| | ISO sensitivity ² | 110 |
| 6 | Exposure compensation | 134 |
| | Optimal exposure tuning ³ | 304 |
| 7 | Focal length | 370 |
| 8 | Lens data | 214 |
| 9 | Focus mode | 90 |
| | Lens VR (vibration reduction) ⁴ | 366 |
| 10 | Flash mode | 193 |
| | Flash compensation | |
| | Commander mode ⁵ | |
| 11 | Camera name | |
| 12 | Image area ⁶ | 78 |
| 13 | Folder number–frame number ⁶ | 288 |

- 1 Displayed only if **Data** is selected for **Display mode** (□ 277).
- 2 Displayed in red if photo was taken with ISO sensitivity auto control on.
- 3 Displayed if Custom Setting b6 (**Fine tune optimal exposure**, □ 304) has been set to a value other than zero for any metering method.
- 4 Displayed only if VR lens is attached.
- 5 Displayed only if optional flash unit (SB-900, SB-800, SB-600, or SB-R200) is used.
- 6 Displayed in yellow if **1.2x (30×20)**, **DX (24×16)** or **5 : 4 (30×24)** was selected for the **Image area** option (□ 78) in the shooting menu.

Shooting Data Page 2¹

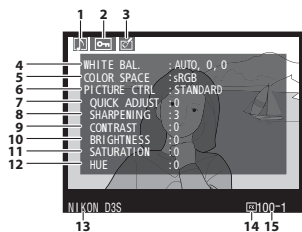

| | | |
|----|---|-----|
| 1 | Voice memo icon | 246 |
| 2 | Protect status | 238 |
| 3 | Retouch indicator | 341 |
| 4 | White balance | 150 |
| | Color temperature | 157 |
| | White balance fine-tuning | 153 |
| | Preset manual | 158 |
| 5 | Color space | 183 |
| 6 | Picture Control | 170 |
| 7 | Quick adjust ² | 173 |
| | Original Picture Control ³ | 170 |
| 8 | Sharpening | 173 |
| 9 | Contrast | 173 |
| 10 | Brightness | 173 |
| 11 | Saturation ⁴ | 173 |
| | Filter effects ⁵ | 173 |
| 12 | Hue ⁴ | 173 |
| | Toning ⁵ | 173 |
| 13 | Camera name | |
| 14 | Image area ⁶ | 78 |
| 15 | Folder number–frame number ⁶ | 288 |

- 1 Displayed only if **Data** is selected for **Display mode** (☐ 277).
- 2 **Standard** and **Vivid** Picture Controls only.
- 3 **Neutral**, **Monochrome**, and custom Picture Controls.
- 4 Not displayed with monochrome Picture Controls.
- 5 Monochrome Picture Controls only.
- 6 Displayed in yellow if **1.2x (30x20)**, **DX (24x16)** or **5:4 (30x24)** was selected for the **Image area** option (☐ 78) in the shooting menu.



Shooting Data Page 3¹

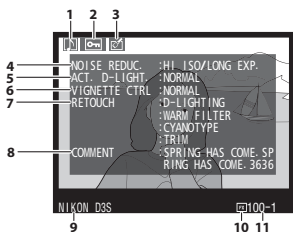

- 1 Voice memo icon 246
- 2 Protect status 238

- 3 Retouch indicator 341
- 4 High ISO noise reduction 291
- Long exposure noise reduction 291
- 5 Active D-Lighting 181
- 6 Vignette control 290
- 7 Retouch history 341
- 8 Image comment 331
- 9 Camera name
- 10 Image area² 78
- 11 Folder number–frame number² 288

- 1 Displayed only if **Data** is selected for **Display mode** (□ 277).
- 2 Displayed in yellow if **1.2x (30×20)**, **DX (24×16)** or **5 : 4 (30×24)** was selected for the **Image area** option (□ 78) in the shooting menu.

Shooting Data Page 4¹

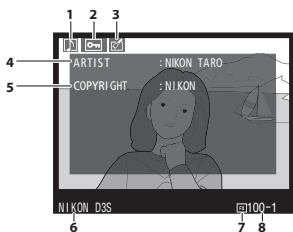

- 1 Voice memo icon 246
- 2 Protect status 238
- 3 Retouch indicator 341
- 4 Name of photographer 335
- 5 Copyright holder 335
- 6 Camera name
- 7 Image area² 78
- 8 Folder number–frame number² 288

- 1 Displayed only if **Data** is selected for **Display mode** (□ 277) and copyright information was appended to photograph (□ 335).
- 2 Displayed in yellow if **1.2x (30×20)**, **DX (24×16)** or **5 : 4 (30×24)** was selected for the **Image area** option (□ 78) in the shooting menu.

■ ■ GPS Data¹

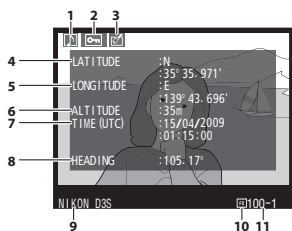

| | | |
|----|---|-----|
| 1 | Voice memo icon | 246 |
| 2 | Protect status | 238 |
| 3 | Retouch indicator | 341 |
| 4 | Latitude | |
| 5 | Longitude | |
| 6 | Altitude | |
| 7 | Coordinated Universal Time (UTC) | |
| 8 | Heading ² | |
| 9 | Camera name | |
| 10 | Image area ³ | 78 |
| 11 | Folder number–frame number ³ | 288 |

- 1 Displayed only if GPS device was used when photo was taken (□ 217).
- 2 Displayed only if GPS device is equipped with electronic compass.
- 3 Displayed in yellow if **1.2x (30×20)**, **DX (24×16)** or **5 : 4 (30×24)** was selected for the **Image area** option (□ 78) in the shooting menu.



Overview Data

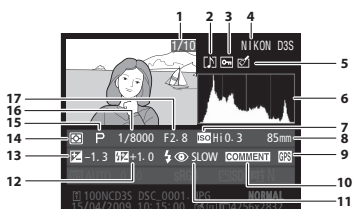

| | | |
|---|-------------------------------------|-----|
| 1 | Frame number/total number of frames | |
| 2 | Voice memo icon | 246 |
| 3 | Protect status | 238 |
| 4 | Camera name | |
| 5 | Retouch indicator | 341 |

| | | |
|----|--|----------|
| 6 | Histogram showing the distribution of tones in the image (□ 229). Horizontal axis corresponds to pixel brightness, vertical axis shows number of pixels of each brightness in image. | |
| 7 | ISO sensitivity ¹ | 110 |
| 8 | Focal length | 370 |
| 9 | GPS data indicator | 217 |
| 10 | Image comment indicator | 331 |
| 11 | Flash mode | 193 |
| 12 | Flash compensation | |
| 13 | Exposure compensation | 134 |
| 14 | Metering method | 116 |
| 15 | Exposure mode | 118 |
| 16 | Shutter speed | 122, 126 |
| 17 | Aperture | 123, 126 |

1 Displayed in red if photo was taken with ISO sensitivity auto control on.

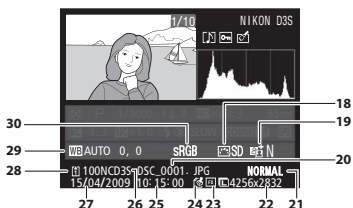

| | | |
|----|------------------------------|-----|
| 18 | Picture Control ² | 170 |
| 19 | Active D-Lighting | 181 |
| 20 | File name | 290 |

| | | |
|----|--------------------------------|-----|
| 21 | Image quality | 83 |
| 22 | Image size | 86 |
| 23 | Image area ³ | 78 |
| 24 | Image authentication indicator | 334 |
| 25 | Time of recording | 34 |
| 26 | Folder name | 288 |
| 27 | Date of recording | 34 |
| 28 | Slot number | 37 |
| 29 | White balance | 150 |
| | Color temperature | 157 |
| | White balance fine-tuning | 153 |
| | Preset manual | 158 |
| 30 | Color space | 183 |

2 -- is displayed if photo was taken using optional Picture Control (□ 171) that is no longer stored in camera.

3 Displayed in yellow if **1.2x (30×20)**, **DX (24×16)** or **5:4 (30×24)** was selected for the **Image area** option (□ 78) in the shooting menu.

Viewing Multiple Images: Thumbnail Playback

To display images in “contact sheets” of four, nine, or 72 images, press the  button and rotate the main command dial.

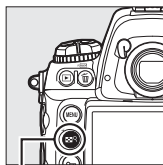



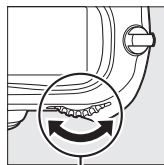



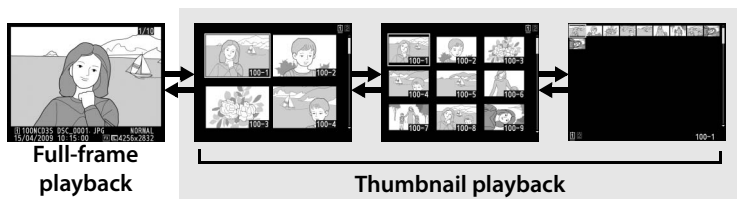



 button













Main command dial



The following operations can be performed:

| To | Use | Description |
|----------------------------|---|---|
| Display more images |  +  | Press  button and rotate main command dial to left to increase number of images displayed. |
| Display fewer images |  +  | Press  button and rotate main command dial to right to reduce number of images displayed. If four images are displayed, highlighted image will be displayed full frame. |
| Toggle full frame playback |  | Press center of multi selector to switch back and forth between full frame and thumbnail playback. |
| Highlight images |  | Use multi selector to highlight images for full-frame playback, playback zoom ( 237), or deletion ( 240). |

| To | Use | Description |
|--|---|---|
| Page through images |  +  | Press  button and rotate sub-command dial to scroll through images a page at a time. |
| Delete highlighted photo |  | See page 240 for more information. |
| Record/play voice memo |  | See page 246 for more information. |
| Change protect status of highlighted photo |  | See page 238 for more information. |
| View images in other locations |  +  | Choose card and folder from which pictures are played back ( 224). |
| Return to shooting mode |  /  | Monitor will turn off. Photographs can be taken immediately. |
| Display menus | MENU | See page 273 for more information. |













See Also

For information on choosing the role played by the center of the multi selector, see Custom Setting f1 (**Multi selector center button**,  314).

Taking a Closer Look: Playback Zoom



Press the  button and rotate the main command dial right to zoom in on the image displayed in full-frame playback or on the image currently highlighted in thumbnail playback.

The following operations can be performed while zoom is in effect:

| To | Use | Description |
|---------------------------|---|---|
| Zoom in or out |  +  | Press  button to display frame showing area currently zoomed in. While  button is pressed, main command dial can be used to control size of frame—rotate dial left to zoom out, right to zoom 36×24 (3 : 2) format images in up to 27 × (large images), 20 × (medium images) or 13 × (small images). Release  button to magnify selected area to fill monitor. |
| |  +  | |
| View other areas of image |  +  | Use multi selector to view area not visible in monitor. Keep multi selector pressed to scroll rapidly to other areas of frame. |
| View other images |  | Rotate main command dial to view same location in other images at current zoom ratio. |
| Change protect status |  | See page 238 for more information. |
| Return to shooting mode |  /  | Monitor will turn off. Photographs can be taken immediately. |
| Display menus | MENU | See page 273 for more information. |



Protecting Photographs from Deletion

In full-frame, zoom, and thumbnail playback, the  button can be used to protect photographs from accidental deletion. Protected files can not be deleted using the  button or the **Delete** option in the playback menu. Note that protected images *will* be deleted when the memory card is formatted (📖 39, 326).



To protect a photograph:

1 Select an image.

Display the image in full-frame playback or playback zoom or highlight it in the thumbnail list.



2 Press the button.

The photograph will be marked with a  icon. To remove protection from the photograph so that it can be deleted, display the photograph or highlight it in the thumbnail list and then press the  button.

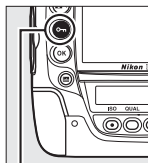



 button



Voice Memos

Changes to the protect status of images also apply to any voice memos that may have been recorded with the images. Voice memo overwrite status can not be set separately.

Removing Protection from All Images

To remove protection from all images in the folder or folders currently selected in the **Playback folder** menu, press the  and  buttons together for about two seconds.



Deleting Photographs

To delete the photograph displayed in full-frame playback or highlighted in the thumbnail list, press the  button. To delete multiple selected photographs or all photographs in the current playback folder, use the **Delete** option in the playback menu. Once deleted, photographs can not be recovered. Note that pictures that are protected or hidden can not be deleted.

Full-Frame and Thumbnail Playback

Press the  button to delete the current photograph.



1 Select an image.

Display the image or highlight it in the thumbnail list.

2 Press the button.

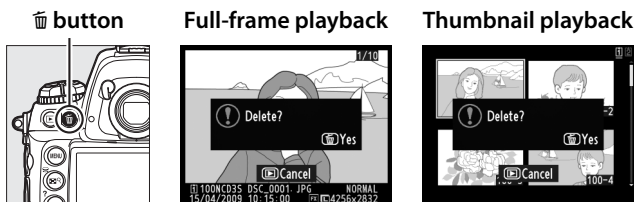
A confirmation dialog will be displayed.



To delete the photograph, press the  button again. To exit without deleting the photograph, press the  button.

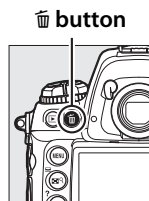

See Also

The **After delete** option in the playback menu determines whether the next image or the previous image is displayed after an image is deleted (📖 281).

Voice Memos

If a voice memo has been recorded with the selected image, the confirmation dialog shown at right will be displayed when the 🗑️ button is pressed.

- **Image/sound:** Select this option and press the 🗑️ button to delete both photo and voice memo.
- **Sound only:** Select this option and press the 🗑️ button to delete only the voice memo.

To exit without deleting either voice memo or photo, press 📄.



The Playback Menu

Select **Delete** in the playback menu to delete pictures and their associated voice memos. Note that depending on the number of images, some time may be required for deletion.

| Option | Description |
|--|--|
|  Selected | Delete selected pictures. |
| ALL All | Delete all pictures in the folder currently selected for playback (📖 275). If two cards are inserted, you can select the card from which pictures will be deleted. |

■ Selected: Deleting Selected Photographs

1 Choose Selected for the Delete option in the playback menu.

Press the **MENU** button and select **Delete** in the playback menu. Highlight **Selected** and press ►.

MENU button

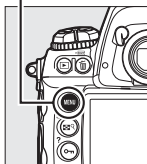

2 Highlight a picture.

Use the multi selector to highlight a picture (to view the highlighted picture full screen, press and hold the  button; to view images in other

locations, press ▲ while pressing the  button and select the desired card and folder as described on page 224).

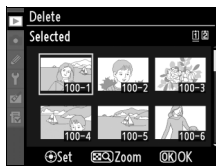

3 Select the highlighted picture.

Press the center of the multi selector to select the highlighted picture. Selected pictures are marked by a  icon. Repeat steps 2 and 3 to select additional pictures; to deselect a picture, highlight it and press the center of the multi selector.

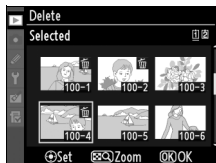

4 Press to complete the operation.

A confirmation dialog will be displayed; highlight **Yes** and press .

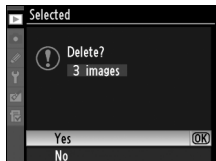





Voice Memos

– *Recording and Playback*

The camera is equipped with a built-in microphone, allowing voice memos to be added to photographs. Voice memos can be played back over the camera's built-in speaker.

| | |
|------------------------------------|------------|
| Recording Voice Memos | 246 |
| Playing Voice Memos..... | 251 |



Recording Voice Memos

Voice memos up to sixty seconds long can be added to photographs using the built-in microphone.





Readying the Camera for Recording

Before recording voice memos, adjust settings using the **Voice memo options** item in the setup menu.

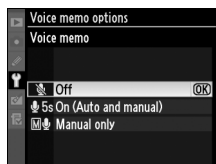
■ ■ Voice Memo

This option controls whether voice memos are recorded automatically or manually. The following options are available:



| Option | Description |
|--|--|
|  Off | Voice memos can not be recorded in shooting mode. |
|  On (Auto and manual) | Selecting this option displays menu shown at right; select maximum recording time from 5, 10, 20, 30, 45, or 60 s. Unless On is selected for Image review in playback menu (📖 281), recording will begin when shutter-release button is released after shooting. Recording ends when  button is pressed or after specified recording time has ended. |
|  Manual only | Memo can be recorded for most recent photograph by pressing and holding  button (📖 248). |

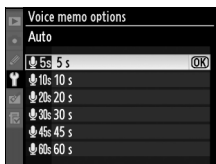

■ Voice Memo Overwrite

This option controls whether the voice memo for the most recent photograph can be overwritten in shooting mode. The following options are available:

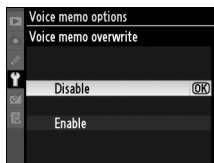



| Option | Description |
|----------------|---|
| Disable | Voice memo can not be recorded in shooting mode if one already exists for most recent image. |
| Enable | Voice memo can be recorded in shooting mode even if one already exists for most recent image (📖 248). Existing memo will be deleted and replaced by new memo. |

■ Voice Memo Button

This option controls manual recording. The following options are available:



| Option | Description |
|--|---|
|  Press and hold | Voice memo is recorded while 🎤 button is held down. Recording will end automatically after 60 s. |
|  Press to start/stop | Recording begins when 🎤 button is pressed and ends when 🎤 button is pressed again. Recording will end automatically after 60 s. |

Voice Memo

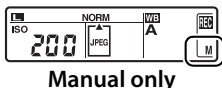
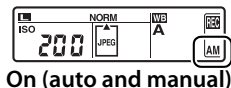

The option selected for **Voice memo** is indicated by an icon in the rear control panel.



Automatic Recording (Shooting Mode)

If **On (Auto and manual)** is selected for **Voice memo** (☞ 246), a voice memo will be added to the most recent photograph when shooting ends. Recording will end when the  button is pressed or after the specified recording time has ended.

Manual Recording (Shooting Mode)

If **On (Auto and manual)** or **Manual only** is selected for **Voice memo** (☞ 246), a voice memo can be recorded for the most recent photograph by pressing and holding the  button. A voice memo will be recorded while the button is held down (note that no voice memo will be recorded if the  button is not held down for at least one second).

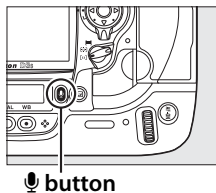

Automatic Recording

Voice memos will not be recorded automatically if **On** is selected for the **Image review** option (☞ 281) in the playback menu. A voice memo can however be added to the photograph displayed during image review even if **Off** is selected for **Voice memo**.

Slot 2

If two memory cards are inserted and **Backup** or **RAW Slot 1 - JPEG Slot 2** is selected for the **Slot 2** option (☞ 88) in the shooting menu, voice memos will be associated with the images recorded to the memory card in slot 1.

Playback Mode



To add a voice memo to the photograph currently displayed in full-frame playback or highlighted in the thumbnail list (222, 235):

1 Choose a photograph.

Display or highlight the photograph. Only one voice memo can be recorded per image; additional voice memos can not be recorded for images already marked with a  icon.



2 Press and hold the button.

A voice memo will be recorded while the  button is held down (note that no voice memo will be recorded if the  button is not held down for at least one second).

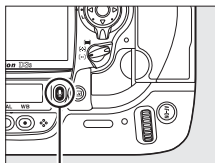

 button

During Recording

During recording, the  icons in the rear control panel will blink. A countdown timer in the rear control panel shows the length of the voice memo that can be recorded (in seconds).

In playback mode, a  icon is displayed in the monitor during recording.

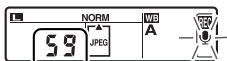

Rear control panel



Interrupting Recording

Recording will end automatically if:

- The **MENU** button is pressed to display the menus
- The  button is pressed
- The shutter-release button is pressed halfway
- The camera is turned off

During interval timer photography, recording will end automatically about two seconds before the next photograph is taken.

After Recording

If a voice memo has been recorded for the most recent photograph, a  icon will be displayed in the rear control panel.

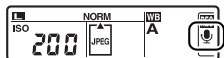

Rear control panel

If a voice memo exists for the photograph currently selected in playback mode, a  icon will be displayed in the monitor.



Voice Memo File Names









Voice memos are stored as WAV files with names of the form "xxxxnnnn.WAV," where "xxxxnnnn" is a file name copied from the image with which the voice memo is associated. For example, the voice memo for the image "DSC_0002.JPG" would have the file name "DSC_0002.WAV." Voice memo file names can be viewed on a computer.



Playing Voice Memos

Voice memos can be played back over the camera's built-in speaker when the associated image is viewed in full-frame playback or highlighted in the thumbnail list (222, 235). The presence of a voice memo is indicated by an  icon.



| To | Press | Description |
|--------------------|---|--|
| Start/end playback |  | Press  to start playback. Playback will end when  button is pressed again or entire memo has been played back. |
| Delete voice memo |  | Confirmation dialog will be displayed. Press  or  to highlight option, press  to select. <ul style="list-style-type: none">Image/sound: Delete both photo and voice memo.Sound only: Delete voice memo only. To exit without deleting image or voice memo, press the  button. |



Interrupting Playback

Playback will end automatically if:





- The MENU button is pressed to display the menus
- The monitor is turned off by pressing the  button or by pressing the shutter-release button halfway
- The camera is turned off
- Another image is selected

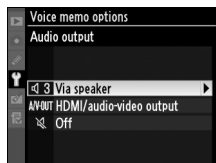

Voice Memo Playback Options

The **Voice memo options** > **Audio output** item in the setup menu controls whether voice memos are played back over the camera's built-in speaker or by a device to which the camera is connected via an HDMI or audio/video cable. When sound is played back over the built-in speaker, the **Audio output** option also controls playback volume.



| Option | Description |
|--|---|
|  Via speaker | Voice memos are played back over built-in speaker. Selecting this option displays menu shown at right. Press ▲ or ▼ to change volume. Beep will sound when option is selected. Press Ⓞ to make selection and return to setup menu.  |
| A/V-OUT HDMI/audio-video output | Audio signal output to HDMI or A/V-OUT terminal. |
|  Off | Voice memos are not played back.  icon is displayed when photo for which voice memo exists is viewed in monitor. |





Connections

– *Connecting to External Devices*

This chapter describes how to copy photographs to a computer, how to print pictures, and how to view them on a television set.

| | |
|---|------------|
| Connecting to a Computer | 254 |
| Direct USB Connection | 255 |
| Wireless and Ethernet Networks | 257 |
| Printing Photographs | 258 |
| Connecting the Printer | 259 |
| Printing Pictures One at a Time | 260 |
| Printing Multiple Pictures | 263 |
| Creating a DPOF Print Order: Print Set..... | 267 |
| Viewing Photographs on TV | 269 |
| Standard Definition Devices | 269 |
| High-Definition Devices | 271 |



Connecting to a Computer

This section describes how to use the supplied UC-E4 USB cable to connect the camera to a computer. Before connecting the camera, install Nikon Transfer and ViewNX from the supplied Software Suite CD (see the *Software Installation Guide* for more information). Nikon Transfer starts automatically when the camera is connected and is used to copy photographs to the computer, where they can be viewed using ViewNX (Nikon Transfer can also be used to back up photographs and embed information in photographs as they are transferred, while ViewNX can be used to sort photographs, convert images to different file formats, process NEF/RAW photographs, and modify NEF/RAW, TIFF, and JPEG images). To ensure that data transfer is not interrupted, be sure the camera battery is fully charged. If in doubt, charge the battery before use or use an EH-6 AC adapter (available separately).

■ ■ *Supported Operating Systems*

The supplied software can be used with computers running the following operating systems:

- **Windows:** Windows Vista Service Pack 2 (Home Basic/Home Premium/Business/Enterprise/Ultimate; runs in 32-bit emulation mode under 64-bit versions) and Windows XP Service Pack 3 (Home Edition/Professional)
- **Macintosh:** Mac OS X (version 10.3.9, 10.4.11, or 10.5.7)

See the websites listed on page xxiv for the latest information on supported operating systems.



✓ **Connecting Cables**

Be sure the camera is off when connecting or disconnecting interface cables. Do not use force or attempt to insert the connectors at an angle.

Direct USB Connection

Connect the camera using the supplied UC-E4 USB cable.

1 Turn the camera off.

2 Turn the computer on.

Turn the computer on and wait for it to start up.

3 Connect the USB cable.

Connect the USB cable as shown. Do not use force or attempt to insert the connectors at an angle.

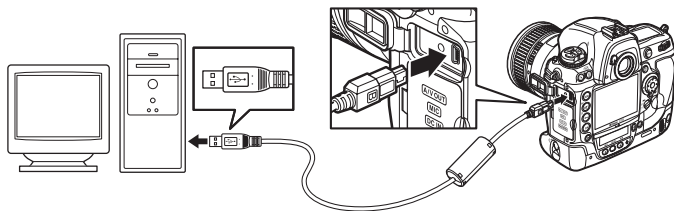

USB Hubs

Connect the camera directly to the computer; do not connect the cable via a USB hub or keyboard.

The USB Cable Clip

To prevent cable from being disconnected, attach the clip as shown.

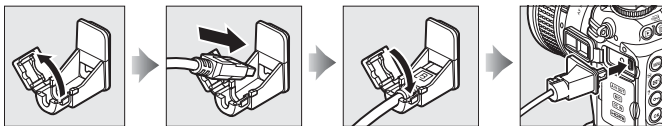

4 Turn the camera on.

5 Transfer photographs.

Nikon Transfer will start automatically; click the **Start Transfer** button to transfer photographs (for more information on using Nikon Transfer, select **Nikon Transfer help** from the Nikon Transfer **Help** menu).



Start Transfer button

6 Turn the camera off.

Turn the camera off and disconnect the USB cable when transfer is complete.

During Transfer

Do not turn the camera off or disconnect the USB cable while transfer is in progress.

Close the Connector Cover

Close the connector cover when the connectors are not in use. Foreign matter in the connectors can interfere with data transfer.



Wireless and Ethernet Networks

If the optional WT-4 wireless transmitter (☐ 372) is attached, photographs can be transferred or printed over wireless or Ethernet networks and the camera can also be controlled from network computers running Camera Control Pro 2 (available separately). The WT-4 can be used in any of the following modes:

| Mode | Function |
|-----------------------|---|
| Transfer mode | Upload new or existing photographs to computer or ftp server. |
| Thumbnail select mode | Preview photographs on computer monitor before upload. |
| PC mode | Control camera from computer using Camera Control Pro 2 (available separately). |
| Print mode | Print JPEG photographs on printer connected to network computer. |

For more information, see the WT-4 user's manual. Be sure to update to the latest versions of the WT-4 firmware and supplied software.

Camera Control Pro 2

Camera Control Pro 2 (available separately; ☐ 375) can be used to control the camera from a computer. When Camera Control Pro 2 is running, "P" will be displayed and the exposure indicator will blink in the top control panel.

Movies

The WT-4 can be used to upload movies in transfer mode if **Auto send** or **Send folder** is not selected for **Transfer settings**. Movies can not be uploaded in thumbnail select mode.

WT-4A/B/C/D/E

The principal difference between the WT-4 and WT-4A/B/C/D/E is in the number of channels supported; unless otherwise stated, all references to the WT-4 also apply to the WT-4A/B/C/D/E.



Printing Photographs

To print selected JPEG pictures on a PictBridge printer via direct USB connection, follow the steps below.

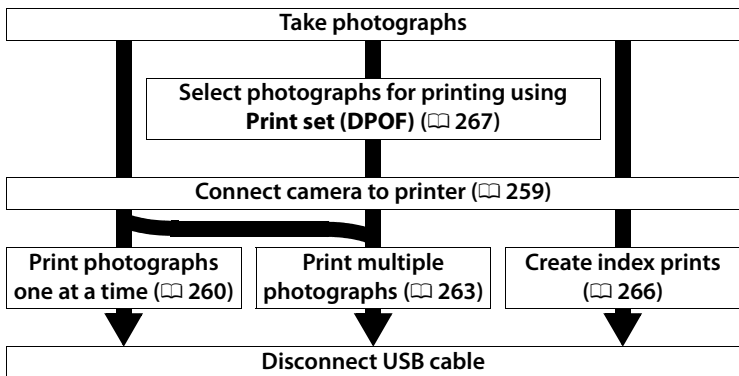

✓ Selecting Photographs for Printing

Images created at image quality settings of NEF (RAW) or TIFF (RGB) (p. 83) can not be selected for printing. JPEG copies of NEF (RAW) images can be created using the **NEF (RAW) processing** option in the retouch menu (p. 353).

✍ Printing Via Direct USB Connection

Be sure the battery is fully charged or use an optional EH-6 AC adapter. When taking photographs to be printed via direct USB connection, set **Color space** to **sRGB** (p. 183).

✍ See Also

See page 407 for information on what to do if an error occurs during printing.

Connecting the Printer

Connect the camera using the supplied UC-E4 USB cable.

1 Turn the camera off.

2 Connect the USB cable.

Turn the printer on and connect the USB cable as shown. Do not use force or attempt to insert the connectors at an angle.

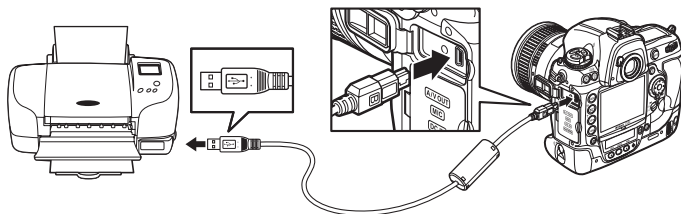

USB Hubs

Connect the camera directly to the printer; do not connect the cable via a USB hub or keyboard.

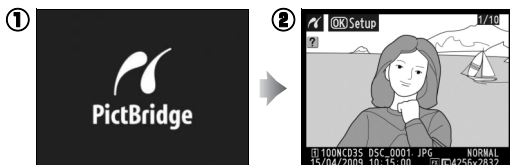

3 Turn the camera on.

A welcome screen will be displayed in the monitor, followed by a PictBridge playback display.



Printing Pictures One at a Time

1 Select a picture.

Press ◀ or ▶ to view additional pictures. Press ▲ or ▼ to view photo information (📖 225), or press the  button and rotate the main command dial right to zoom in on the current frame (📖 237). Press  to return to full-frame playback. To view six pictures at a time, press the center of the multi selector. Use the multi selector to highlight pictures, or press the center of the multi selector again to display the highlighted picture full frame. To view images in other locations, press ▲ while pressing  and select the desired card and folder as described on page 224.

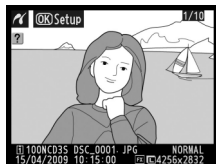

2 Display printing options.

Press  to display PictBridge printing options.

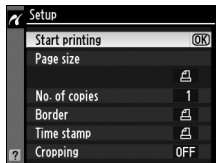

3 Adjust printing options.

Press ▲ or ▼ to highlight an option and press ► to select.

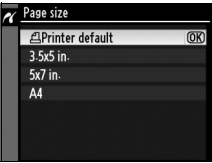
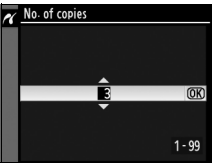
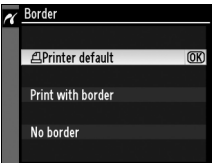
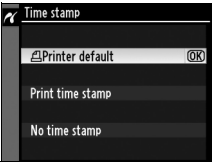
| Option | Description | |
|----------------------|--|--|
| Page size | Menu shown at right will be displayed. Press ▲ or ▼ to choose page size (to print at default page size for current printer, select Printer default), then press OK to select and return to previous menu. |  |
| No. of copies | Menu shown at right will be displayed. Press ▲ or ▼ to choose number of copies (maximum 99), then press OK to select and return to previous menu. |  |
| Border | Menu shown at right will be displayed. Press ▲ or ▼ to choose print style from Printer default (default for current printer), Print with border (print photo with white border), or No border , then press OK to select and return to previous menu. |  |
| Time stamp | Menu shown at right will be displayed. Press ▲ or ▼ to choose Printer default (default for current printer), Print time stamp (print time and date of recording on photo), or No time stamp , then press OK to select and return to previous menu. |  |



| Option | Description |
|------------------------|--|
| <p>Cropping</p> | <p>Menu shown at right will be displayed. To exit without cropping picture, highlight No cropping and press OK. To crop picture, highlight Crop and press ▶.</p> <p>If Crop is selected, dialog shown at right will be displayed. Rotate main command dial to left to increase size of crop, right to decrease. Choose position of crop using multi selector and press OK.</p> |

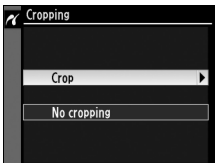

Page Size, Border, Time Stamp, and Cropping

Choose printer default to print at current printer settings. Only options supported by the current printer can be selected. Note that print quality may drop if small crops are printed at large sizes.

4 Start printing.

Select **Start printing** and press **OK** to start printing. To cancel before all copies have been printed, press **OK**.



Printing Multiple Pictures

1 Display the PictBridge menu.

Press the **MENU** button in the PictBridge playback display (see Step 3 on page 259).



MENU button

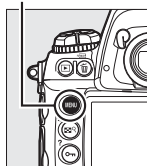

2 Choose Print select or Print (DPOF).

Highlight one of the following options and press ►.



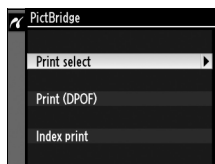

- **Print select:** Select pictures for printing.
- **Print (DPOF):** Print an existing print order created with the **Print set (DPOF)** option in the playback menu (📖 267). The current print order will be displayed in Step 3.



To create an index print of all JPEG pictures on the memory card, select **Index print**. See page 266 for more information.



3 Select pictures.

Use the multi selector to scroll through the pictures on the memory card (to view images in other locations, press ▲ while pressing  and select the desired card and folder as described on page 224). To display the current picture full screen, press and hold the . To select the current picture for printing, press the  button and press ▲. The picture will be marked with a  icon and the number of prints will be set to 1. Keeping the  button pressed, press ▲ or ▼ to specify the number of prints (up to 99; to deselect the picture, press ▼ when the number of prints is 1). Continue until all the desired pictures have been selected.

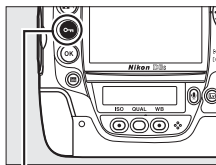

 button

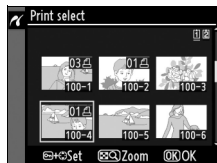

4 Display printing options.

Press  to display PictBridge printing options.

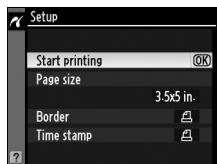

5 Adjust printing options.

Press ▲ or ▼ to highlight an option and press ► to select.

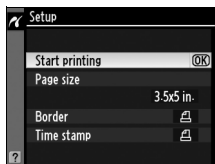

| Option | Description |
|-------------------|--|
| Page size | Menu of page size options will be displayed (☰ 261). Press ▲ or ▼ to choose page size (to print at default page size for current printer, select Printer default), then press OK to select and return to previous menu. |
| Border | Menu of border options will be displayed (☰ 261). Press ▲ or ▼ to choose print style from Printer default (default for current printer), Print with border (print photo with white border), or No border , then press OK to select and return to previous menu. |
| Time stamp | Menu of time stamp options will be displayed (☰ 261). Press ▲ or ▼ to choose Printer default (default for current printer), Print time stamp (print time and date of recording on photo), or No time stamp , then press OK to select and return to previous menu. |

6 Start printing.

Select **Start printing** and press OK to start printing. To cancel before all copies have been printed, press OK.



■ Creating Index Prints

To create an index print of all JPEG pictures on the memory card, select **Index print** in Step 2 of “Printing Multiple Pictures” (☞ 263). Note that if the memory card contains more than 256 pictures, only the first 256 images will be printed.

1 Select Index print.

Highlight **Index print** in the PictBridge menu (☞ 263) and press **▶**.

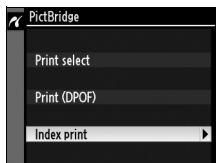

The confirmation dialog shown at right will be displayed.

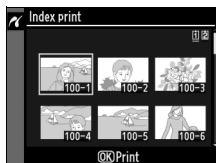

2 Display printing options.

Press **OK** to display PictBridge printing options.

3 Adjust printing options.

Choose page size, border, and time stamp options as described on page 265 (a warning will be displayed if the selected page size is too small).

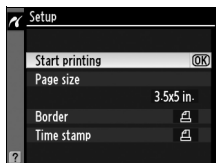

4 Start printing.

Highlight **Start printing** and press **OK** to start printing. To cancel before printing is complete, press **OK**.



Creating a DPOF Print Order: Print Set

The **Print set (DPOF)** option in the playback menu is used to create digital “print orders” for PictBridge-compatible printers and devices that support DPOF.

1 Choose **Select/set** for the **Print set (DPOF)** item in the playback menu.

Press the **MENU** button and select **Print set (DPOF)** in the playback menu. Highlight **Select/set** and press **▶** (to remove all photographs from the print order, select **Deselect all?**).

MENU button



2 Select pictures.

Use the multi selector to scroll through the pictures on the memory card (to view images in other locations, press **▲** while pressing **⏏** and select the desired card and folder as described on page 224). To display the current picture in full screen, press and hold the **⏏** button. To select the current picture for printing, press the **⏏** button and press **▲**. The picture will be marked with a  icon and the number of prints will be set to 1. Keeping the **⏏** button pressed, press **▲** or **▼** to specify the number of prints (up to 99; to deselect the picture, press **▼** when the number of prints is 1). Press **OK** when all the desired pictures have been selected.

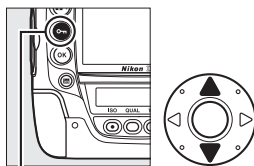

⏏ button

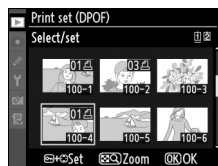

3 Select imprint options.

Highlight the following options and press **▶** to toggle the highlighted option on or off (to complete the print order without including this information, proceed to Step 4).

- **Data imprint:** Print shutter speed and aperture on all pictures in print order.
- **Imprint date:** Print date of recording on all pictures in print order.

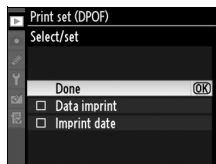

4 Complete the print order.

Highlight **Done** and press **OK** to complete the print order.

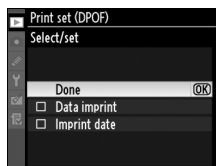

Print Set

To print the current print order when the camera is connected to a PictBridge printer, select **Print (DPOF)** in the PictBridge menu and follow the steps in “Printing Multiple Pictures” to modify and print the current order (☞ 263). DPOF date and data imprint options are not supported when printing via direct USB connection; to print the date of recording on photographs in the current print order, use the PictBridge **Time stamp** option.

The Print Set option can not be used if there is not enough space on the memory card to store the print order.

Images created at image quality settings of NEF (RAW; ☞ 83) can not be selected for printing using this option.

Print orders may not print correctly if images are deleted using a computer or other device after the print order is created.

Viewing Photographs on TV

The supplied EG-D2 audio/video (A/V) cable can be used to connect the D3S to a television or VCR for playback or recording. A type C mini-pin High-Definition Multimedia Interface (HDMI) cable (available separately from commercial sources) can be used to connect the camera to high-definition video devices.

Standard Definition Devices

To connect the camera to a standard television:

1 Turn the camera off.

Always turn the camera off before connecting or disconnecting the A/V cable.

2 Connect the supplied A/V cable as shown.

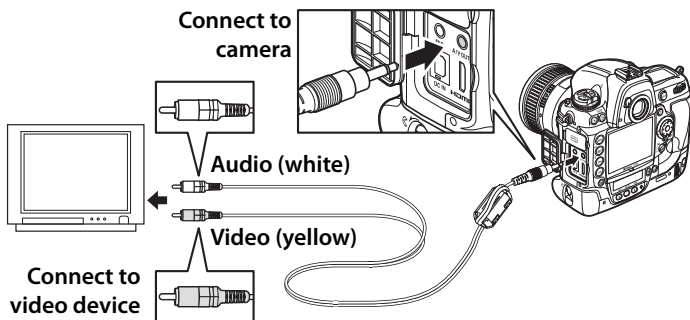

3 Tune the television to the video channel.



4 Turn the camera on and press button.

During playback, images will be displayed both on the television screen and in the camera monitor.

Video Mode

If no image is displayed, check that camera is correctly connected and that the option selected for **Video mode** (📖 329) matches the video standard used in the TV.

Television Playback

Use of an EH-6 AC adapter (available separately) is recommended for extended playback. When the EH-6 is connected, the camera monitor-off delay will be fixed at ten minutes and the exposure meters will no longer turn off automatically. Note that the edges may not be visible when photographs are viewed on a television screen.

Voice Memo Options > Audio Output (📖 252)

Set **HDMI/audio-video output** to play back or record voice memos on the video device.

Slide Shows

The **Slide show** option in the playback menu can be used for automated playback (📖 282).

Audio

When a movie with sound recorded in stereo using an external microphone is viewed on a television connected to the camera via an A/V cable, the audio output is monaural. HDMI connections support stereo output. Volume can be adjusted using television controls; the camera controls can not be used.

High-Definition Devices

The camera can be connected to HDMI devices using a type C mini-pin HDMI cable (available separately from commercial sources).

1 Turn the camera off.

Always turn the camera off before connecting or disconnecting an HDMI cable.

2 Connect the HDMI cable as shown.

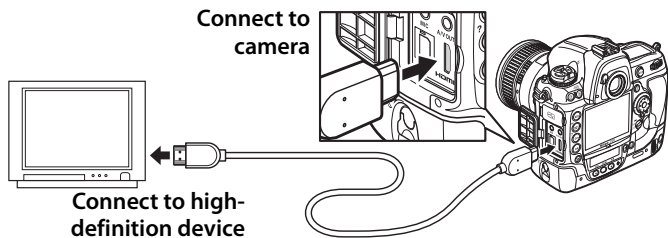

3 Tune the device to the HDMI channel.



4 Turn the camera on and press button.

During playback, images will be displayed on the high-definition television or monitor screen; the camera monitor will remain off.

Movies

To display or hide a guide in the monitor when viewing movies on an HDMI device, press the  button.







HDMI

At the default setting of **Auto**, the camera automatically selects the appropriate HDMI format for the high-definition device. The HDMI format can be chosen using the **HDMI** option in the setup menu ( 329).



Menu Guide

This chapter describes the options available in the camera menus.

| | |
|--|-----|
|  The Playback Menu: Managing Images | 274 |
|  The Shooting Menu: Shooting Options | 284 |
|  Custom Settings: Fine-Tuning Camera Settings | 292 |
|  The Setup Menu: Camera Setup | 325 |
|  The Retouch Menu: Creating Retouched Copies | 341 |
|  My Menu: Creating a Custom Menu | 359 |



▶ The Playback Menu: *Managing Images*

To display the playback menu, press **MENU** and select the ▶ (playback menu) tab.

MENU button



| Option | |
|------------------|-----|
| Delete | 242 |
| Playback folder | 275 |
| Hide image | 275 |
| Display mode | 277 |
| Copy image(s) | 278 |
| Image review | 281 |
| After delete | 281 |
| Rotate tall | 282 |
| Slide show | 282 |
| Print set (DPOF) | 267 |

See Also

Menu defaults are listed on page 392.

Playback Folder

MENU button →  playback menu

Choose a folder for playback.

| Option | Description |
|----------------|---|
| NCD3S | Pictures in all folders created with the D3S will be visible during playback. |
| All | Pictures in all folders will be visible during playback. |
| Current | Only pictures in the current folder will be visible during playback. |

Hide Image

MENU button →  playback menu

Hide or reveal selected pictures as described below. Hidden pictures are visible only in the **Hide image** menu and can only be deleted by formatting the memory card.

Protected and Hidden Images

Revealing a protected image will also remove protection from the image.



1 Choose Select/set.

Highlight **Select/set** and press **▶** (to skip the remaining steps and reveal all pictures, highlight **Deselect all?** and press **▶**).



2 Select pictures.

Use the multi selector to scroll through the pictures on the memory card (to view the highlighted picture full screen, press and hold the  button;

to view images in other locations, press  while pressing  and select the desired card and folder as described on page 224) and press the center of the multi selector to select the current picture. Selected pictures are marked by a  icon; to deselect a picture, highlight it and press the center of the multi selector.



3 Press .

Press  to complete the operation.



Choose the information available in the playback photo information display (225).

1 Select options.

Press ▲ or ▼ to highlight an option, then press ► to select the option for the photo information display. A ✓ appears next to selected items; to deselect, highlight and press ►.

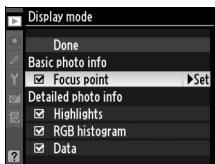

2 Save changes and exit.

To return to the playback menu, highlight **Done** and press .

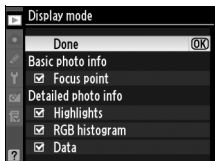

Copy photographs from the memory card in slot 1 to the memory card in slot 2.

| Option | Description |
|--------------------------------------|---|
| [1] Select image(s) | Select photographs from memory card in slot 1. |
| [2] Select destination folder | Select destination folder on memory card in slot 2. |
| Copy image(s)? | Copy selected photographs to specified destination. |

1 Choose **Select image(s)**.

Highlight **Select image(s)** and press ►.

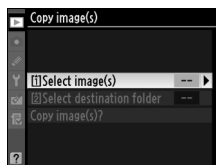

2 Select the source folder.

Highlight the folder containing the images to be copied and press ►.

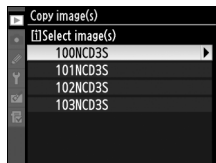

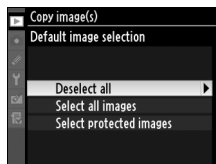

3 Make the initial selection.

Before going on select or deselect individual images, you can mark all or all protected images in the folder for copying by choosing **Select all images** or **Select protected images**. To mark only individually selected images for copying, choose **Deselect all** before proceeding.



4 Select additional images.

Highlight pictures and press the center of the multi selector to select or deselect (to view the highlighted picture full screen, press and hold the  button). Selected images are marked with a ✓. Press  to proceed to Step 5 when your selection is complete.

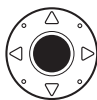

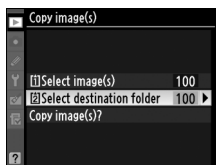

5 Choose Select destination folder.

Highlight **Select destination folder** and press .



6 Select a destination folder.

To enter a folder number, choose **Select folder by number**, enter the number ( 288), and press .

To choose from a list of existing folders, choose **Select folder from list**, highlight a folder, and press .

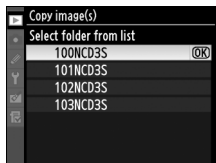

7 Copy the images.

Highlight **Copy image(s)?** and press **▶**.

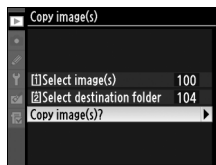

A confirmation dialog will be displayed; highlight **Yes** and press **OK**. Press **OK** again to exit when copying is complete.

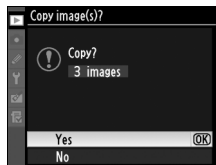

Copying Images

Images will not be copied if there is insufficient space on the destination card. Be sure the battery is fully charged before copying movies.

If the destination folder contains an image with the same name as one of the images to be copied, a confirmation dialog will be displayed.

Select **Replace existing image** to replace the image with the image to be copied, or select **Replace all** to replace all existing images with the same names without further prompting. To continue without replacing the image, select **Skip**, or select **Cancel** to exit without copying any further images. Hidden or protected files in the destination folder will not be replaced.

Protect status is copied with the images but print marking (📄 267) is not. Voice memos will be copied with their associated images. Hidden images can not be copied.



Image Review

MENU button →  playback menu



Choose whether pictures are automatically displayed in the monitor immediately after shooting. If **Off** is selected, pictures can only be displayed by pressing the  button.



After Delete

MENU button →  playback menu

Choose the picture displayed after an image is deleted.

| Option | Description |
|---|---|
|  Show next | Display following picture. If deleted picture was last frame, previous picture will be displayed. |
|  Show previous | Display previous picture. If deleted picture was first frame, following picture will be displayed. |
|  Continue as before | If user was scrolling through pictures in order recorded, following picture will be displayed as described for Show next . If user was scrolling through pictures in reverse order, previous picture will be displayed as described for Show previous . |



Rotate Tall

MENU button → playback menu

Choose whether to rotate “tall” (portrait-orientation) pictures for display during playback. Note that because the camera itself is already in the appropriate orientation during shooting, images are not rotated automatically during image review.

| Option | Description |
|--------|--|
| On | “Tall” (portrait-orientation) pictures are automatically rotated for display in the camera monitor. Pictures taken with Off selected for Auto image rotation (332) will be displayed in “wide” (landscape) orientation. |
| Off | “Tall” (portrait-orientation) pictures are displayed in “wide” (landscape) orientation. |

Slide Show





MENU button → playback menu

Create a slide show of the pictures in the current playback folder (275). Hidden images (275) are not displayed.

| Option | Description |
|-----------------------|---|
| Start | Start slide show. |
| Frame interval | Choose how long each picture will be displayed. |
| Audio playback | Display menu of voice memo playback options (283). |

To start the slide show, highlight **Start** and press . The following operations can be performed while the slide show is in progress:



| To | Press | Description |
|----------------------------|---|--|
| Skip back/skip ahead |  | Press ◀ to return to previous frame, ▶ to skip to next frame. |
| View additional photo info |  | Change photo info displayed (☞ 225). |
| Pause/resume |  | Pause or resume slide show. Voice memo playback may continue after OK button has been pressed. |
| Exit to playback menu | MENU | End slide show and return to playback menu. |
| Exit to playback mode |  | End slide show and exit to full-frame (☞ 222) or thumbnail playback (☞ 235). |
| Exit to shooting mode |  | Press shutter-release button halfway to return to shooting mode. |

The dialog shown at right is displayed when the show ends. Select **Restart** to restart or **Exit** to return to the playback menu.



■ ■ Audio Playback

Choose **On** to play voice memos during slide shows. The following options will be displayed:

| Option | Description |
|-----------------------------|---|
| Frame interval | Playback ends when next frame is displayed, even if entire memo has not been played. |
| Length of voice memo | Next frame is not displayed until entire memo has been played, even if frame interval is shorter than voice memo. |

Choose **Off** to disable voice memo playback during slide shows.





The Shooting Menu: *Shooting Options*

To display the shooting menu, press **MENU** and select the  (shooting menu) tab.

MENU button



| Option |  |
|----------------------------|---|
| Shooting menu bank | 285 |
| Reset shooting menu | 287 |
| Extended menu banks | 287 |
| Active folder | 288 |
| File naming | 290 |
| Slot 2 | 88 |
| Image quality | 83 |
| Image size | 86 |
| Image area | 78 |
| JPEG compression | 85 |
| NEF (RAW) recording | 85 |
| White balance | 150 |

| Option |  |
|---------------------------------|---|
| Set Picture Control | 170 |
| Manage Picture Control | 176 |
| Color space | 183 |
| Active D-Lighting | 181 |
| Vignette control | 290 |
| Long exp. NR | 291 |
| High ISO NR | 291 |
| ISO sensitivity settings | 110 |
| Live view mode | 55, 59 |
| Multiple exposure | 202 |
| Movie settings | 70 |
| Interval timer shooting | 208 |



See Also

Menu defaults are listed on page 392.

Shooting menu options are stored in one of four banks. With the exceptions of **Extended menu banks**, **Interval timer shooting**, **Multiple exposure**, and modifications to Picture Controls (quick adjust and other manual adjustments), changes to settings in one bank have no effect on the others. To store a particular combination of frequently-used settings, select one of the four banks and set the camera to these settings. The new settings will be stored in the bank even when the camera is turned off, and will be restored the next time the bank is selected. Different combinations of settings can be stored in the other banks, allowing the user to switch instantly from one combination to another by selecting the appropriate bank from the bank menu.



The default names for the four shooting menu banks are A, B, C, and D. A descriptive caption can be added using the **Rename** option ( 286).

Shooting Menu Bank

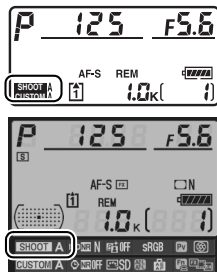
The top control panel and information displays show the current shooting menu bank.



See Also

Exposure mode, shutter speed, and aperture can be included in shooting menu banks using the **Extended menu banks** option in the shooting menu ( 287). For information on using the controls on the camera body to select the shooting menu bank, see Custom Setting f4 (**Assign Fn button**) > **Fn button + command dials** ( 318).

■ Renaming Shooting Menu Banks

Selecting **Rename** in the **Shooting menu bank** menu displays the list of shooting menu banks shown in Step 1.

1 Select a bank.

Highlight the desired bank and press **▶**.

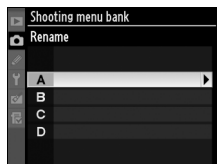

2 Enter a name.

To move the cursor in the name area, press the **Q** button and press **◀** or **▶**. To enter a new letter at the current cursor position, use the multi selector to highlight the desired character in the keyboard area and press the center of the multi selector. To delete the character at the current cursor position, press the **⏏** button. To return to the shooting menu without changing the bank name, press the **MENU** button.

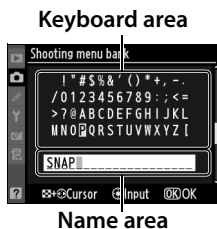

3 Save changes and exit.

After editing the name, press **OK** to save changes and exit. The **Shooting menu bank** menu will be displayed.

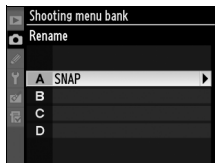

Reset Shooting Menu

MENU button →  shooting menu

Select **Yes** to restore default settings for the current shooting menu bank. See page 392 for a list of default settings.

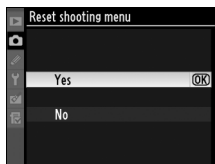

Extended Menu Banks

MENU button →  shooting menu

Select **On** to include exposure mode, shutter speed (modes **S** and **M** only), and aperture (modes **A** and **M** only) in the information recorded in each of the four shooting menu banks, to be recalled whenever the bank is selected. Selecting **Off** restores the values in effect before **On** was selected.

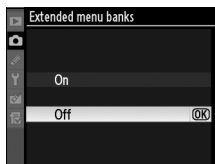

Select the folder in which subsequent images will be stored.



■ Select Folder by Number



1 Select Select folder by number.

Highlight **Select folder by number** and press ►. The dialog shown at right will be displayed, with the current slot underlined. The current slot varies with the option selected for **Slot 2** (☞ 88).



2 Choose a folder number.

Press ◀ or ▶ to highlight a digit, press ▲ or ▼ to change. If a folder with the selected number already exists, a , , or  icon will be displayed to the left of the folder number:

-  : Folder is empty.
-  : Folder is partially full.
-  : Folder contains 999 pictures or a picture numbered 9999. No further pictures can be stored in this folder.

3 Save changes and exit.

Press OK to complete the operation and return to the shooting menu (to exit without changing the active folder, press the MENU button). If a folder with the specified number does not already exist, a new folder will be created. Subsequent photographs will be stored in the selected folder unless it is already full.



■ Select Folder from List

1 Choose **Select folder from list**.

Highlight **Select folder from list** and press **▶**.

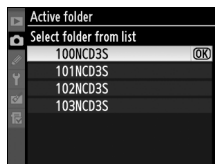

2 Highlight a folder.

Press **▲** or **▼** to highlight a folder.

3 Select the highlighted folder.

Press **OK** to select the highlighted folder and return to the shooting menu (to exit without changing the active folder, press the **MENU** button). Subsequent photographs will be stored in the selected folder.

✓ Folder and File Numbers

If the current folder is numbered 999 and contains 999 pictures or a picture numbered 9999, the shutter-release will be disabled and no further photographs can be taken. To continue shooting, create a folder with a number less than 999, or select an existing folder with a number less than 999 and less than 999 images.

✍ Number of Folders

Additional time may be required for camera startup if the memory card contains a very large number of folders.



Photographs are saved using file names consisting of “DSC_” or, in the case of images that use the Adobe RGB color space, “_DSC”, followed by a four-digit number and a three-letter extension (e.g., “DSC_0001.JPG”). The **File naming** option is used to select three letters to replace the “DSC” portion of the file name. For information on editing file names, see steps 2 and 3 of “Renaming Shooting Menu Banks” (📖 286). Note that the portion of the name that can be edited is a maximum of three characters long.

Extensions

The following extensions are used: “.NEF” for NEF (RAW) images, “.TIF” for TIFF (RGB) images, “.JPG” for JPEG images, “.AVI” for movies, and “.NDF” for dust off reference data. In each pair of photographs recorded at image-quality settings of NEF (RAW)+JPEG, the NEF and JPEG images have the same file names but different extensions.

Vignette Control

“Vignetting” is a drop in brightness at the edges of a photograph. **Vignette control** reduces vignetting for type G and D lenses (DX and PC lenses excluded). Its effects vary from lens to lens and are most noticeable at maximum aperture. Choose from **High**, **Normal**, **Low**, and **Off**.

Vignette Control

Depending on the scene, shooting conditions, and type of lens, TIFF and JPEG images may exhibit noise (fog) or variations in peripheral brightness, while custom Picture Controls and preset Picture Controls that have been modified from default settings may not produce the desired effect. Take test shots and view the results in the monitor. Vignette control does not apply to multiple exposures (📖 202), DX-format images (📖 78), or images created with **Image overlay** (📖 349). Vignette control does not apply to movies and its effects can not be previewed in live view (📖 54).

Long Exp. NR (Long Exposure Noise Reduction)

MENU button →  shooting menu

If **On** is selected, photographs taken at shutter speeds slower than 1 s will be processed to reduce noise (randomly-spaced bright pixels or fog). The time required for processing is roughly equal to the current shutter speed; during processing, “**Job nr**” will blink in the shutter speed/aperture

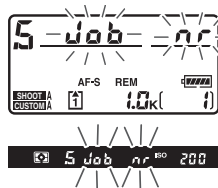

displays and pictures can not be taken (if the camera is turned off before processing is complete, the picture will be saved but noise reduction will not be performed). In continuous release mode, frame rates will slow and while photographs are being processed, the capacity of the memory buffer will drop.

High ISO NR

MENU button →  shooting menu

Photographs taken at high ISO sensitivities can be processed to reduce noise.

| Option | Description |
|--------------------|---|
| HIGH High | Noise reduction is performed at ISO sensitivities over ISO 3200. While photographs are being processed, the capacity of the memory buffer will drop. Choose the amount of noise reduction performed from High , Normal , and Low . |
| NORM Normal | |
| LOW Low | |
| Off | Noise reduction is only performed at sensitivities of Hi 0.3 and higher. The amount of noise reduction is less than the amount performed when Low is selected for High ISO NR . |

High ISO NR has no effect on movies.



Custom Settings: Fine-Tuning Camera Settings

To display the Custom Settings menu, press **MENU** and select the  (Custom Settings menu) tab.

MENU button

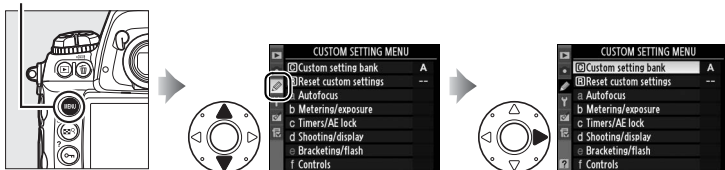

Custom Settings are used to customize camera settings to suit individual preferences.

Main menu

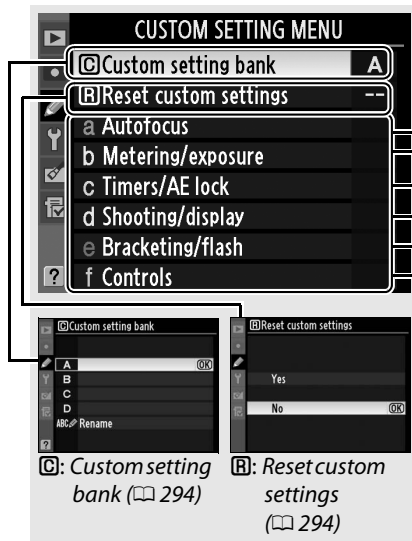

Custom Setting groups

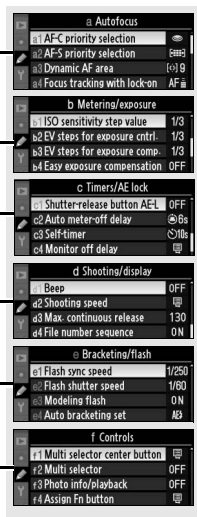

The following Custom Settings are available:

| Custom Setting | | | Custom Setting | | |
|----------------|------------------------------|--|----------------|----------|------------------------------|
| C | Custom setting bank | | 294 | d | Shooting/display |
| R | Reset custom settings | | 294 | d3 | Max. continuous release |
| a | Autofocus | | | d4 | File number sequence |
| a1 | AF-C priority selection | | 295 | d5 | Control panel/viewfinder |
| a2 | AF-S priority selection | | 296 | d6 | Information display |
| a3 | Dynamic AF area | | 296 | d7 | Screen tips |
| a4 | Focus tracking with lock-on | | 298 | d8 | LCD illumination |
| a5 | AF activation | | 298 | d9 | Exposure delay mode |
| a6 | Focus point illumination | | 299 | e | Bracketing/flash |
| a7 | Focus point wrap-around | | 299 | e1 | Flash sync speed |
| a8 | AF point selection | | 300 | e2 | Flash shutter speed |
| a9 | AF-ON button | | 300 | e3 | Modeling flash |
| a10 | Vertical AF-ON button | | 301 | e4 | Auto bracketing set |
| b | Metering/exposure | | | e5 | Auto bracketing (Mode M) |
| b1 | ISO sensitivity step value | | 302 | e6 | Bracketing order |
| b2 | EV steps for exposure cntrl. | | 302 | f | Controls |
| b3 | EV steps for exposure comp. | | 302 | f1 | Multi selector center button |
| b4 | Easy exposure compensation | | 303 | f2 | Multi selector |
| b5 | Center-weighted area | | 304 | f3 | Photo info/playback |
| b6 | Fine tune optimal exposure | | 304 | f4 | Assign Fn button |
| c | Timers/AE lock | | | f5 | Assign preview button |
| c1 | Shutter-release button AE-L | | 305 | f6 | Assign AE-L/AF-L button |
| c2 | Auto meter-off delay | | 305 | f7 | Assign BKT button |
| c3 | Self-timer | | 305 | f8 | Customize command dials |
| c4 | Monitor off delay | | 306 | f9 | Release button to use dial |
| d | Shooting/display | | | f10 | No memory card? |
| d1 | Beep | | 306 | f11 | Reverse indicators |
| d2 | Shooting speed | | 307 | | |

See Also

Menu defaults are listed on page 392. If settings in the current bank have been modified from default values, an asterisk will be displayed adjacent to the altered settings in the second level of the Custom Settings menu.

C: Custom Setting Bank

MENU button → Custom Settings menu

Custom Settings are stored in one of four banks. Changes to settings in one bank have no effect on the others. To store a particular combination of frequently-used settings, select one of the four banks and set the camera to these settings. The new settings will be stored in the bank even when the camera is turned off, and will be restored the next time the bank is selected. Different combinations of settings can be stored in the other banks, allowing the user to switch instantly from one combination to another by selecting the appropriate bank from the bank menu.

The default names for the four Custom Settings banks are A, B, C, and D. A descriptive caption can be added using the **Rename** option as described on page 286.

Custom Settings Bank

The bank letter appears in the top control panel and information displays.

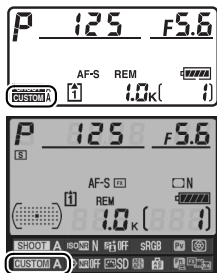

R: Reset Custom Settings

MENU button → Custom Settings menu

Select **Yes** to restore default settings for the current Custom Settings bank. See page 393 for a list of default settings. Custom settings are not reset when a two-button reset is performed.

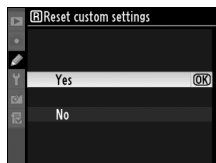

a: Autofocus



a1: AF-C Priority Selection

MENU button →  Custom Settings menu

This option controls whether photographs can be taken whenever the shutter-release button is pressed (*release priority*) or only when the camera is in focus (*focus priority*) in continuous-servo AF. To select continuous-servo AF, rotate the focus mode selector to **C**.

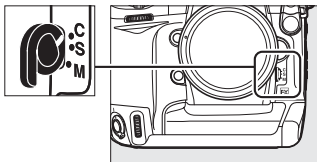
Focus mode selector



| Option | Description |
|--|---|
|  Release | Photos can be taken whenever the shutter-release button is pressed. |
|  Release + focus | Photos can be taken even when the camera is not in focus. In continuous mode, frame rate slows for improved focus if the subject is dark or low contrast. |
|  Focus | Photos can only be taken when the in-focus indicator (●) is displayed. |

Regardless of the option selected, focus will not lock when the in-focus indicator (●) is displayed. The camera will continue to adjust focus until the shutter is released.





a2: AF-S Priority Selection

MENU button →  Custom Settings menu

This option controls whether photographs can be taken only when the camera is in focus (*focus priority*) or whenever the shutter-release button is pressed (*release priority*) in single-servo AF. To select single-servo AF, rotate the focus mode selector to **S**.

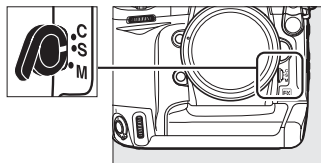
Focus mode selector







| Option | Description |
|--|--|
|  Release | Photos can be taken whenever the shutter-release button is pressed. |
|  Focus | Photos can only be taken when the in-focus indicator (●) is displayed. |

Regardless of the option selected, if the in-focus indicator (●) is displayed focus will lock while the shutter-release button is pressed halfway. Focus lock continues until the shutter is released.

a3: Dynamic AF Area

MENU button →  Custom Settings menu

If the subject leaves the selected focus point when dynamic-area AF (;  92) is selected in continuous-servo AF (focus mode **C**;  90), the camera will focus based on information from surrounding focus points. Choose the number of focus points from 9, 21, and 51 based on subject movement (note that only active focus point is displayed in the viewfinder; the remaining focus points provide information to assist focus operation).

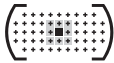
| Option | Description |
|--|---|
|  9 points  | If the subject leaves the selected focus point, the camera will focus based on information from the surrounding eight focus points. Choose when there is time to compose the photograph or when photographing subjects that are moving predictably (e.g., runners or race cars on a track). |

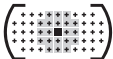
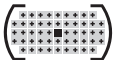
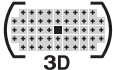
| Option | Description |
|--|--|
| [AF-ON] 21 points  | If the subject leaves the selected focus point, the camera will focus based on information from the surrounding 20 focus points. Choose when photographing subjects that are moving unpredictably (e.g., players at a football game). |
| [AF-ON] 51 points  | If the subject leaves the selected focus point, the camera will focus based on information from the surrounding 50 focus points. Choose when photographing subjects that are moving quickly and can not be easily framed in the viewfinder (e.g., birds). |
| [AF-ON] 3D 51 points (3D-tracking)  | If the subject leaves the selected focus point, the camera will use 3D-tracking to track the subject and select a new focus point as required. Use to quickly compose pictures with subjects that are moving erratically from side to side (e.g., tennis players). If the subject leaves the viewfinder, remove your finger from the shutter-release button and recompose the photograph with the subject in the selected focus point. |

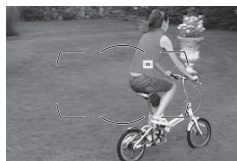
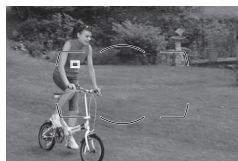

3D-tracking

When the shutter-release button is pressed halfway, the colors in the area surrounding the focus point are stored in the camera.

Consequently 3D-tracking may not produce the desired results with subjects that are the same color as the background or that occupy a very small area of the frame.

See Also

For information on using the **Fn** button and command dials to select the number of focus points for dynamic-area AF, see Custom Setting f4 (**Assign Fn button**) > **Fn button + command dials** > **Dynamic AF area** (☞ 319).



a4: Focus Tracking with Lock-On MENU button → Custom Settings menu

This option controls how autofocus adjusts to sudden large changes in the distance to the subject during continuous-servo AF.

| Option | Description |
|----------------|--|
| AF 5 (Long) | When the distance to the subject changes abruptly, the camera waits for the specified period before adjusting the distance to the subject. This prevents the camera from refocusing when the subject is briefly obscured by objects passing through the frame. |
| AF 4 | |
| AF 3 (Normal) | |
| AF 2 | |
| AF 1 (Short) | |
| Off | The camera immediately adjusts focus when the distance to the subject changes. Use when photographing a series of subjects at varying distances in quick succession. |

a5: AF Activation MENU button → Custom Settings menu

If **Shutter/AF-ON** is selected, both the shutter-release button and the **AF-ON** button can be used to initiate autofocus. If **AF-ON only** is selected, autofocus is only initiated when the **AF-ON** button is pressed.

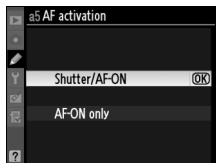

a6: Focus point Illumination

MENU button →  Custom Settings menu

The options in this menu control whether or not the focus points are illuminated.

| Option | Description |
|-------------------------------|--|
| Manual focus mode | Choose On to display the active focus point in manual focus mode. |
| Continuous mode | Choose On to display the active focus point in CH (continuous high-speed) and CL (continuous low-speed) modes. |
| Focus point brightness | Choose the brightness of the focus point display in the viewfinder from Extra high , High , Normal , and Low . |

a7: Focus Point Wrap-Around

MENU button →  Custom Settings menu

Choose whether focus-point selection “wraps around” from one edge of the viewfinder to another.

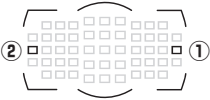
| Option | Description |
|----------------|---|
| Wrap | Focus-point selection “wraps around” from top to bottom, bottom to top, right to left, and left to right, so that, for example, pressing ▶ when a focus point at the right edge of the viewfinder display is highlighted (①) selects the corresponding focus point at the left edge of the display (②).  |
| No wrap | The focus-point display is bounded by the outermost focus points so that, for example, pressing ▶ when a focus point at the right edge of the display is selected has no effect. |



a8: AF Point Selection

MENU button →  Custom Settings menu

Choose the number of focus points available for manual focus-point selection.

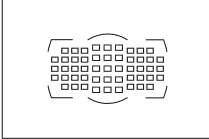
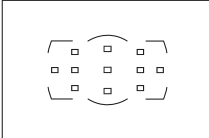



| Option | Description | |
|----------------|--|---|
| AF51 51 points | Choose from the 51 focus points shown at right. |  |
| AF11 11 points | Choose from the 11 focus points shown at right. Use for quick focus-point selection. |  |

a9: AF-ON Button

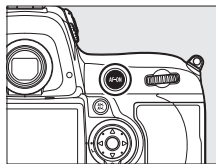

MENU button →  Custom Settings menu

Choose the function performed when the AF-ON button is pressed.



| Option | Description |
|---|--|
|  AF-ON | Pressing the AF-ON button initiates autofocus. |
|  AE/AF lock | Focus and exposure lock while the AF-ON button is pressed. |
|  AE lock only | Exposure locks while the AF-ON button is pressed. |
|  AE lock (Reset on release) | Exposure locks when the AF-ON button is pressed, and remains locked until the button is pressed a second time, the shutter is released, or the exposure meters turn off. |









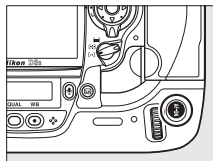

| Option | Description |
|---|---|
|  AE lock (Hold) | Exposure locks when the AF-ON button is pressed, and remains locked until the button is pressed a second time or the exposure meters turn off. |
|  AF lock only | Focus locks while the AF-ON button is pressed. |

a10: Vertical AF-ON Button

MENU button →  Custom Settings menu

Choose the function assigned to the **AF-ON** button for vertical shooting.



| Option | Description |
|---|--|
|  Same as AF-ON | Both AF-ON buttons perform the function selected for Custom Setting a9. |
|  AF-ON | Pressing the vertical AF-ON button initiates autofocus. |
|  AE/AF lock | Focus and exposure lock while the vertical AF-ON button is pressed. |
|  AE lock only | Exposure locks while the vertical AF-ON button is pressed. |
|  AE lock (Reset on release) | Exposure locks when the vertical AF-ON button is pressed, and remains locked until the button is pressed a second time, the shutter is released, or the exposure meters turn off. |
|  AE lock (Hold) | Exposure locks when the vertical AF-ON button is pressed, and remains locked until the button is pressed a second time or the exposure meters turn off. |
|  AF lock only | Focus locks while the vertical AF-ON button is pressed. |



b: Metering/Exposure

b1: ISO Sensitivity Step Value

MENU button →  Custom Settings menu

Select the increments used when making adjustments to ISO sensitivity (📖 110). If possible, the current ISO sensitivity setting is maintained when the step value is changed. If the current ISO sensitivity setting is not available at the new step value, ISO sensitivity will be rounded to the nearest available setting.

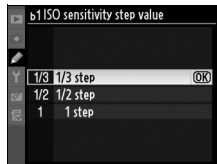

b2: EV Steps for Exposure Cntrl.

MENU button →  Custom Settings menu

Select the increments used when making adjustments to shutter speed, aperture, and bracketing.

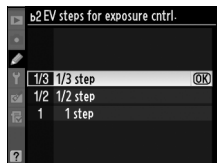

b3: EV Steps for Exposure Comp.

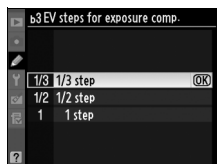

MENU button →  Custom Settings menu

Select the increments used when making adjustments to exposure compensation.



b4: Easy Exposure Compensation MENU button → Custom Settings menu

This option controls whether the  button is needed to set exposure compensation (☞ 134). If **On (Auto reset)** or **On** is selected, the 0 at the center of the exposure display will blink even when exposure compensation is set to ± 0 .

| Option | Description |
|------------------------------|--|
| RESET On (Auto reset) | Exposure compensation is set by rotating one of the command dials (see note below). The setting selected using the command dial is reset when the camera or exposure meters turn off (exposure compensation settings selected using the  button are not reset). |
| On | As above, except that the exposure compensation value selected using the command dial is not reset when the camera or exposure meters turn off. |
| Off | Exposure compensation is set by pressing the  button and rotating the main command dial. |

Change Main/Sub

The dial used to set exposure compensation when **On (Auto reset)** or **On** is selected for Custom Setting b4 (**Easy exposure compensation**) depends on the option selected for Custom Setting f8 (**Customize command dials**) > **Change main/sub** (☞ 322).

| | | Customize command dials > Change main/sub | |
|---------------|---|---|-------------------|
| | | Off | On |
| Exposure mode | P | Sub-command dial | Sub-command dial |
| | S | Sub-command dial | Main command dial |
| | A | Main command dial | Sub-command dial |
| | M | N/A | |



b5: Center-Weighted Area

MENU button →  Custom Settings menu

When calculating exposure, center-weighted metering assigns the greatest weight to a circle in the center of the frame. The diameter (ϕ) of this circle can be set to 8, 12, 15, or 20 mm or to the average of the entire frame.

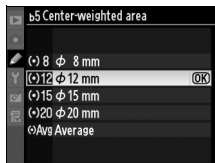

Note that unless **Average** is selected, the diameter is fixed at 12 mm when a non-CPU lens is used, regardless of the setting selected for **Non-CPU lens data** in the setup menu (📖 214). When **Average** is selected, the average of the entire frame will be used for both CPU and non-CPU lenses.

b6: Fine Tune Optimal Exposure

MENU button →  Custom Settings menu

Use this option to fine-tune the exposure value selected by the camera. Exposure can be fine tuned separately for each metering method by from +1 to -1 EV in steps of $\frac{1}{6}$ EV.

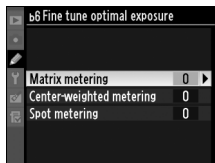

Fine-Tuning Exposure

Exposure can be fine-tuned separately for each Custom Settings bank and is not affected by two-button resets. Note that as the exposure compensation () icon is not displayed, the only way to determine how much exposure has been altered is to view the amount in the fine-tuning menu. Exposure compensation (📖 134) is preferred in most situations.



c: Timers/AE Lock

c1: Shutter-Release Button AE-L MENU button → Custom Settings menu

If **Off** is selected, exposure only locks when the **AE-L/AF-L** button is pressed. If **On** is selected, exposure will also lock when the shutter-release button is pressed halfway.

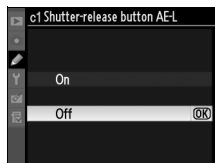

c2: Auto Meter-off Delay

MENU button →  Custom Settings menu

Choose how long the camera continues to meter exposure when no operations are performed. The shutter-speed and aperture displays in the top control panel and viewfinder turn off automatically when the exposure meters turn off.

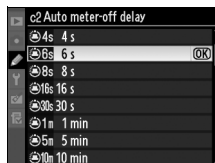

Choose a shorter meter-off delay for longer battery life.

c3: Self-Timer

MENU button →  Custom Settings menu

Choose the length of the shutter release delay in self-timer mode.

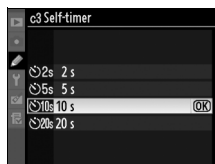

c4: Monitor off Delay

MENU button → Custom Settings menu

Choose how long the monitor remains on when no operations are performed during playback (**Playback**; defaults to 10 s) and image review (**Image review**; defaults to 4 s) or when menus (**Menus**; defaults to 20 s) or information (**Information display**; defaults to 10 s) are displayed. Choose a shorter monitor-off delay for longer battery life. Except when image review is on, the monitor will remain on for about ten minutes if no operations are performed when the camera is powered by an optional EH-6 AC adapter.

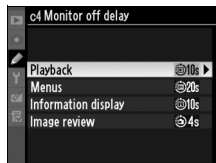

d: Shooting/Display

d1: Beep

MENU button → Custom Settings menu

If **High** (high pitch) or **Low** (low pitch) is selected, a beep will sound at the selected pitch while the self-timer is active or when the camera focuses using single-servo AF. Note that a beep will not sound when the camera focuses during movie recording or in quiet-shutter release mode (mode **Q**) or if **Release** is selected for Custom Setting a2 (**AF-S priority selection**, 296).

appears in the top control panel and information display when the beep is on.

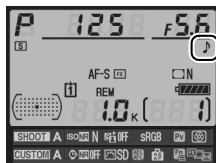
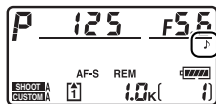

d2: Shooting Speed

MENU button →  Custom Settings menu

Choose the maximum frame advance rate for **CH** (continuous high-speed) and **CL** (continuous low-speed) modes. Note that the frame advance rate may drop below the selected value at slow shutter speeds, if auto ISO sensitivity control is on, or when VR (vibration reduction) mode is used with VR lenses.

| Option | Description |
|------------------------------|---|
| Continuous high-speed | In CH (continuous high-speed) mode, the frame advance rate for DX format ( 79) can be selected from 9, 10, and 11 frames per second (fps). Regardless of the setting chosen, the maximum frame rate for other formats is fixed at 9 fps. Note that at very small apertures (high f-numbers), the camera may be unable to record at 11 fps. |
| Continuous low-speed | Choose the frame advance rate for CL (continuous low-speed) mode from values between 1 and 9 fps. |

d3: Max. Continuous Release

MENU button →  Custom Settings menu

The maximum number of shots that can be taken in a single burst in continuous mode can be set to any value between 1 and 130.

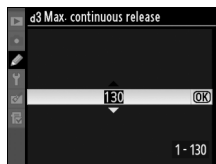

The Memory Buffer

Regardless of the option selected for Custom Setting d3, shooting will slow when the memory buffer fills. See page 420 for more information on the capacity of the memory buffer.



When a photograph is taken, the camera names the file by adding one to the last file number used. This option controls whether file numbering continues from the last number used when a new folder is created, the memory card is formatted, or a new memory card is inserted in the camera.

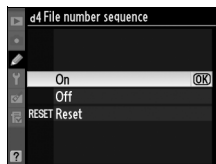

| Option | Description |
|--------------------|--|
| On | When a new folder is created, the memory card formatted, or a new memory card inserted in the camera, file numbering continues from the last number used or from the largest file number in the current folder, whichever is higher. If a photograph is taken when the current folder contains a photograph numbered 9999, a new folder will be created automatically and file numbering will begin again from 0001. |
| Off | File numbering is reset when a new folder is created, the memory card is formatted, or a new memory card is inserted in the camera. Note that a new folder is created automatically if a photograph is taken when the current folder contains 999 photographs or a file numbered 9999. |
| RESET Reset | Same as for On , except that the next photograph taken is assigned a file number by adding one to the largest file number in the current folder. If the folder is empty, file numbering is reset to 0001. |

File Number Sequence

If the current folder is numbered 999 and contains either 999 photographs or a photograph numbered 9999, the shutter-release button will be disabled and no further photographs can be taken. Choose **Reset** for Custom Setting d4 (**File number sequence**) and then either format the current memory card or insert a new memory card.



d5: Control Panel/Viewfinder

MENU button →  Custom Settings menu

Choose the information displayed in the viewfinder and rear control panel.

| Option | Description |
|--------------------|--|
| Rear control panel | Choose from ISO sensitivity (ISO) and Exposures remaining (REM). If Exposures remaining is selected, ISO sensitivity will only be displayed while the ISO button is pressed. |
| Viewfinder display | Choose from Frame count (F) and Exposures remaining (REM). Note that regardless of the option selected, memory buffer capacity will be shown while the shutter-release button is pressed. |

d6: Information Display

MENU button →  Custom Settings menu

If **Auto (AUTO)** is selected, the color of the lettering in the information display (14) will automatically change from black to white or white to black to maintain contrast with the background. To always use the same color lettering, select **Manual** and choose **Dark on light (B; black lettering)** or **Light on dark (W; white lettering)**. Monitor brightness will automatically be adjusted for maximum contrast with the selected text color.

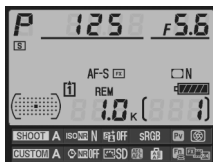

Dark on light



Light on dark



d7: Screen Tips

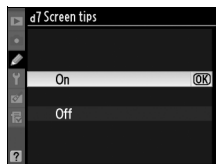

MENU button →  Custom Settings menu

Choose **On** to display tool tips for items selected in the information display ( 17).



d8: LCD Illumination

MENU button →  Custom Settings menu

If **Off** is selected, the control panel backlights (LCD illuminators) will only light while the power switch is rotated toward . If **On** is selected, the control panels will be illuminated while the exposure meters are active ( 45). Select **Off** for increased battery life.

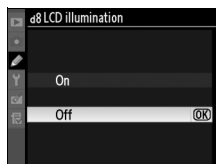

d9: Exposure Delay Mode

MENU button →  Custom Settings menu

If **Off** is selected, shutter is released when the shutter-release button is pressed. When shooting with **Tripod** selected in live view mode ( 55) or in situations where the slightest camera movement can blur pictures, **On** can be selected to delay shutter release until about 1 s after the shutter-release button is pressed and the mirror is raised.

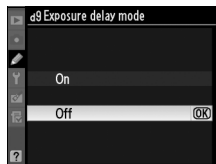

e: Bracketing/Flash

e1: Flash Sync Speed

MENU button →  Custom Settings menu

This option controls flash sync speed.

| Option | Description |
|------------------------------|--|
| 1/250 s (Auto FP) | Use auto FP high-speed sync with SB-900, SB-800, SB-600, and SB-R200 flash units. If other flash units are used, shutter speed is set to $1/250$ s. When the camera shows a shutter speed of $1/250$ s in exposure mode P or A , auto FP high-speed sync will be activated if the actual shutter speed is faster than $1/250$ s. |
| 1/250 s–1/60 s | Flash sync speed set to selected value. |

Fixing Shutter Speed at the Flash Sync Speed Limit

To fix shutter speed at the sync speed limit in shutter-priority auto or manual exposure modes, select the next shutter speed after the slowest possible shutter speed (30 s or bulb). An X (flash sync indicator) will be displayed in the viewfinder and top control panel.

Auto FP High-Speed Sync

Allows the flash to be used at the highest shutter speed supported by the camera, making it possible to choose the maximum aperture for reduced depth of field even when the subject is backlit in bright sunlight. The information display flash mode indicator shows “FP” when auto FP high-speed sync is active.



e2: Flash Shutter Speed

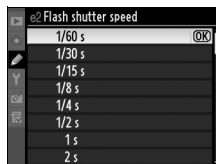

MENU button →  Custom Settings menu

This option determines the slowest shutter speed available when using front- or rear-curtain sync or red-eye reduction in programmed auto or aperture-priority auto exposure modes (regardless of the setting chosen, shutter speeds can be as slow as 30 s in shutter-priority auto and manual exposure modes or at flash settings of slow sync, slow rear-curtain sync, or red-eye reduction with slow sync). Options range from $\frac{1}{60}$ s (**1/60 s**) to 30 s (**30 s**).



e3: Modeling Flash

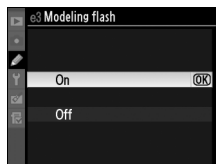

MENU button →  Custom Settings menu

If **On** is selected when the camera is being used with an optional flash unit that supports the Nikon Creative Lighting System (CLS;  187), the flash unit mounted on the camera and any CLS-compatible remote flash units will emit a modeling flash when the camera **Pv** button is pressed ( 119). No modeling flash is emitted if **Off** is selected.



e4: Auto Bracketing Set

MENU button →  Custom Settings menu









Choose the setting or settings bracketed when auto bracketing ( 136) is in effect. Choose **AE & flash** (**AE**) to perform both exposure and flash-level bracketing, **AE only** (**AE**) to bracket only exposure, **Flash only** (**⚡**) to perform only flash-level bracketing, **WB bracketing** (**WB**) to perform white balance bracketing ( 141), or **ADL bracketing** to perform bracketing using Active D-Lighting ( 145). Note that white balance bracketing is not available at image quality settings of NEF (RAW) or NEF (RAW) + JPEG.



e5: Auto Bracketing (Mode M)

MENU button →  Custom Settings menu

This option determines which settings are affected when **AE & flash** or **AE only** is selected for Custom Setting e4 in manual exposure mode.

| Option | Description |
|---|--|
|   Flash/speed | Camera varies shutter speed (Custom Setting e4 set to AE only) or shutter speed and flash level (Custom Setting e4 set to AE & flash). |
|    Flash/speed/aperture | Camera varies shutter speed and aperture (Custom Setting e4 set to AE only) or shutter speed, aperture, and flash level (Custom Setting e4 set to AE & flash). |
|    Flash/aperture | Camera varies aperture (Custom Setting e4 set to AE only) or aperture and flash level (Custom Setting e4 set to AE & flash). |
|  Flash only | Camera varies flash level only (Custom Setting e4 set to AE & flash). |

Flash bracketing is performed only with i-TTL or AA flash control. If a setting other than **Flash only** is selected and the flash is not used, ISO sensitivity will be fixed at the value for the first shot, regardless of the setting selected for ISO sensitivity auto control (☐ 112).

e6: Bracketing Order

MENU button →  Custom Settings menu

At the default setting of **MTR>under>over** (N), exposure, flash, and white balance bracketing are performed in the order described on pages 138 and 142. If **Under>MTR>over** (→+) is selected, shooting will proceed in order from the lowest to the highest value. This setting has no effect on ADL bracketing.



f: Controls



f1: Multi Selector Center Button MENU button → Custom Settings menu

This option determines the role assigned to the center of the multi selector in shooting and playback modes (regardless of the option selected, pressing the center of the multi selector when a movie is displayed full frame starts movie playback).

■ Shooting Mode

| Option | Role assigned to center of multi selector |
|---------------------------------|---|
| RESET Select center focus point | Select center focus point. |
| Not used | None. |

■ Playback Mode

| Option | Role assigned to center of multi selector |
|---|--|
|  Thumbnail on/off | Toggle between full-frame and thumbnail playback. |
|  View histograms | In both full-frame and thumbnail playback, a histogram is displayed while the center of the multi selector is pressed. |
|  Zoom on/off | Toggle between full-frame or thumbnail playback and playback zoom. Choose the initial zoom setting from Low magnification , Medium magnification , and High magnification . The zoom display will center on the active focus point. |



Live View

| Option | Role assigned to center of multi selector |
|----------|---|
| RESET | Select center focus point Pressing the center of the multi selector in live view selects the center focus point. |
| 🔍 | Zoom on/off Press the center of the multi selector to toggle zoom on and off. Choose the initial zoom setting from Low magnification , Medium magnification , and High magnification . The zoom display will center on the active focus point. |
| ●REC | Start movie recording Pressing the center of the multi selector in live view starts movie recording. |
| Not used | Pressing the center of the multi selector has no effect in live view. |

f2: Multi Selector

MENU button →  Custom Settings menu

If **Reset meter-off delay** is selected, operating the multi selector when the exposure meters are off (🔒 45) will activate the exposure meters. If **Do nothing** is selected, the exposure meters will not be activated when the multi selector is pressed.

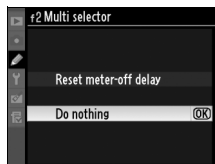

f3: Photo Info/Playback

MENU button →  Custom Settings menu

If **Info▲▼/Playback◀▶** is selected, pressing ▲ or ▼ in full-frame playback changes the photo information displayed, while pressing ◀ or ▶ displays additional images. To reverse the role of the multi selector buttons so that pressing ▲ or ▼ displays additional images and pressing ◀ or ▶ changes the photo information displayed, select **Info◀▶/Playback▲▼**.





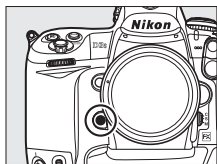















Choose the role played by the **Fn** button, either by itself (**Fn button press**) or when used in combination with the command dials (**Fn button + command dials**).



■ ■ Fn Button Press

Selecting **Fn button press** for Custom Setting f4 displays the following options:

| Option | Description |
|---|--|
|  Preview* | Press the Fn button to preview depth of field ( 119). |
|  FV lock* | Press the Fn button to lock flash value (SB-900, SB-800, SB-600, SB-400, and SB-R200 flash units only,  196). Press again to cancel FV lock. |
|  AE/AF lock | Focus and exposure lock while the Fn button is pressed. |
|  AE lock only | Exposure locks while the Fn button is pressed. |
|  AE lock (Reset on release)* | Exposure locks when the Fn button is pressed, and remains locked until the button is pressed a second time, the shutter is released, or the exposure meters turn off. |
|  AE lock (Hold)* | Exposure locks when the Fn button is pressed, and remains locked until the button is pressed a second time or the exposure meters turn off. |
|  AF lock only | Focus locks while the Fn button is pressed. |
|  Flash off | The flash will not fire in photos taken while the Fn button is pressed. |

| Option | Description |
|--|--|
| BKT Bracketing burst | If the Fn button is pressed while exposure, flash, or ADL bracketing is active in single frame or quiet shutter-release mode, all shots in the current bracketing program will be taken each time the shutter-release button is pressed. If white balance bracketing is active or continuous release mode (mode CN or CL) is selected, the camera will repeat the bracketing burst while the shutter-release button is held down (in single frame release mode, photographs will be taken at about 8 fps). |
|  Matrix metering | Matrix metering is activated while the Fn button is pressed. |
|  Center-weighted metering | Center-weighted metering is activated while the Fn button is pressed. |
|  Spot metering | Spot metering is activated while the Fn button is pressed. |
|  Virtual horizon* | The exposure indicators act as a tilt meter (□ 318). Press the Fn button to toggle between exposure and tilt meter displays. |
|  Playback* | Fn button performs same function as  button. Select when using a telephoto lens or in other circumstances in which it is difficult to operate the  button with your left hand. |
|  Access top item in MY MENU* | Press the Fn button to jump to the top item in "MY MENU." Select this option for quick access to a frequently-used menu item. |
| None | No operation is performed when the Fn button is pressed. |







* This option can not be used in combination with **Fn button + command dials** (□ 318). Selecting this option displays a message and sets **Fn button + command dials** to **None**. If another option is selected for **Fn button + command dials** while this setting is active, **Fn button press** will be set to **None**.

Note that none of these options can be combined with **Fn button + command dials > Dynamic AF area**; see page 319.



Virtual Horizon

When **Virtual horizon** is selected for **Fn button press**, the exposure indicators in the viewfinder and top control panel can be used as a horizontal level. Press the **Fn** button to toggle between exposure and tilt meter displays.

| | Camera tilted right | Camera level | Camera tilted left |
|----------------------|---|---|---|
| Control panel |  |  |  |
| Viewfinder |  |  |  |







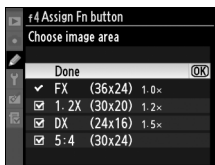

Note that the display may not be accurate when the camera is tilted at a sharp angle forward or back.

Fn button + command dials

Selecting **Fn button + command dials** for Custom Setting f4 displays the following options:

| Option | Description |
|---|---|
|  Choose image area | Press the Fn button and rotate the main command dial to highlight the desired image area (📖 78); press ▶ to select or deselect. Highlight Done and press OK when settings are complete. |



| Option | Description |
|--|--|
|  1 step spd/aperture | If the Fn button is pressed when the command dials are rotated, changes to shutter speed (exposure modes S and M) and aperture (exposure modes A and M) are made in increments of 1 EV, regardless of the option selected for Custom Setting b2 (EV steps for exposure cntrl. ,  302). |
| Non-CPU CPU lens number | Press the Fn button and rotate a command dial to choose a lens number specified using the Non-CPU lens data option ( 214). |
|  Focus point-selection | Press the Fn button and rotate the command dials for vertical shooting to choose a focus point. |
| SHOOT Shooting menu bank | If this option is selected, the shooting menu bank can be selected by pressing the Fn button and rotating a command dial. |
|  Dynamic AF area | If continuous-servo AF (focus mode C ;  90) is selected when dynamic-area AF () is chosen for AF-area mode ( 92), the number of focus points can be selected by pressing the Fn button and rotating a command dial ( 296). The focus points used for dynamic-area AF are displayed in the viewfinder while the Fn button is pressed; if 51 points (3D-tracking) is selected, “3D” will be displayed in the viewfinder. |
| None | No operation is performed when the command dials are rotated while the Fn button is pressed. |

■ Portrait (Tall-Orientation) Photographs

To use the command dials to select the focus point when framing shots in portrait (“tall”) orientation:

1 Choose Focus point-selection.

Select **Focus point-selection** for Custom Setting f4 (**Assign Fn button**) > **Fn button + command dials**.

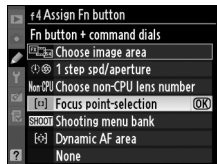

2 Unlock the shutter-release button for vertical shooting.

Vertical shutter-release button lock

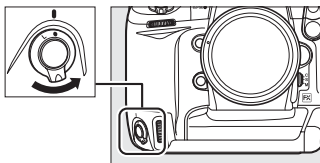

3 Select the focus point.

With the camera in portrait (“tall”) orientation, select a focus point by pressing the **Fn** button and rotating the command dials for vertical shooting. Use the main command dial to move the focus point selection left or right, the sub-command dial to move it up or down.

Main command dial for vertical shooting

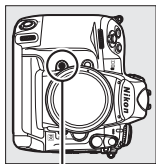

Fn button

+

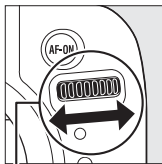

Main command dial for vertical shooting

Sub-command dial for vertical shooting

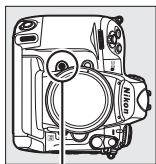

Fn button

+

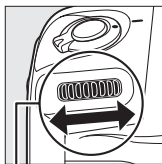

Sub-command dial for vertical shooting

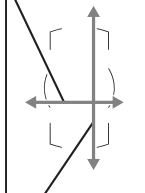

f5: Assign Preview Button

MENU button →  Custom Settings menu

Choose the role played by the **Pv** button, either by itself (**Preview button press**) or when used in combination with the command dials (**Preview + command dials**). The options available are the same as for **Fn button press** (□ 316) and **Fn button + command dials** (□ 318), except that the default option for **Preview button press** is **Preview** and that **Preview + command dials** lacks a **Focus point-selection** option (the default setting for **Preview + command dials** is **None**).

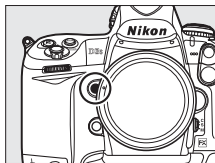

f6: Assign AE-L/AF-L Button

MENU button →  Custom Settings menu

Choose the role played by the **AE-L/AF-L** button, either by itself (**AE-L/AF-L button press**) or when used in combination with the command dials (**AE-L/AF-L + command dials**). The options available for **AE-L/AF-L button press** are the same as for **Fn button press** (□ 316), except that **AE-L/AF-L button press** defaults to **AE/AF lock** and has an additional **AF-ON** option (if this option is selected, pressing the **AE-L/AF-L** button has the same effect as pressing the **AF-ON** button to initiate autofocus; this option can not be used in combination with **AE-L/AF-L + command dials**). The options available for **AE-L/AF-L + command dials** are the same as for **Fn button + command dials** (□ 318), except that **AE-L/AF-L + command dials** defaults to **None** and lacks **1 step spd/aperture** and **Focus-point selection** options.

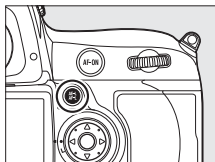



f7: Assign BKT Button

MENU button →  Custom Settings menu

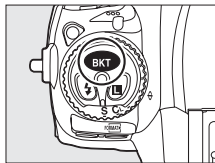
Choose the role played by the **BKT** button.





| Option | Description |
|---|--|
|  Auto bracketing | Press the BKT button and rotate a command dial to choose the bracketing increment and number of shots in the bracketing sequence (📖 136). |
|  Multiple exposure | Press the BKT button and rotate a command dial to choose the mode and number of shots for multiple exposures (📖 204). |

f8: Customize Command Dials

MENU button →  Custom Settings menu

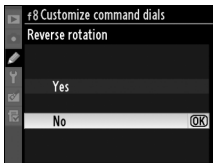
This option controls the operation of the main and sub-command dials.

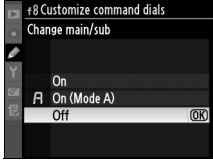
| Option | Description | |
|---|---|---|
|  Reverse rotation | Controls the direction of the command dials. Choose No for normal command dial operation, Yes to reverse the rotation of the command dials. This setting also applies to the command dials for vertical shooting. |  |
|  Change main/sub | If Off is selected, the main command dial controls shutter speed and the sub-command dial controls aperture. If On is selected, the main command dial will control aperture and the sub-command dial shutter speed. If On (Mode A) is selected, the main command dial will be used to set aperture in exposure mode A only. This setting also applies to the command dials for vertical shooting. |  |

| Option | Description |
|---------------------------|---|
| Aperture setting | If Sub-command dial is selected, aperture can only be adjusted with the sub-command dial (or with the main command dial if On is selected for Change main/sub). If Aperture ring is selected, aperture can only be adjusted with the lens aperture ring and the camera aperture display will show aperture in increments of 1 EV (aperture for type G lenses is still set using the sub-command dial). Live view is not available when Aperture ring is selected and a CPU lens with an aperture ring is attached. Note that regardless of the setting chosen, the aperture ring must be used to adjust aperture when a non-CPU lens is attached. |
| Menus and playback | If Off is selected, the multi selector is used to choose the picture displayed during full-frame playback, highlight thumbnails, and navigate menus. If On is selected, the main command dial can be used to choose the picture displayed during full-frame playback, move the cursor left or right during thumbnail playback, and move the menu highlight bar up or down. The sub-command dial is used to display additional photo information in full-frame playback and to move the cursor up or down during thumbnail playback. While menus are displayed, rotating the sub-command dial right displays the sub-menu for the selected option, while rotating it left displays the previous menu. To make a selection, press ►, the center of the multi selector, or OK . |



 **Live View**

When using a CPU lens equipped with an aperture ring in live view, select **Sub-command dial** for **Aperture setting**.



f9: Release Button to Use Dial

MENU button →  Custom Settings menu

Selecting **Yes** allows adjustments that are normally made by holding the **MODE**, , **BKT**, , **ISO**, **QUAL**, or **WB** button and rotating a command dial to be made by rotating the command dial after the button is released. Setting ends when any of the affected buttons is pressed again or the shutter-release button is pressed halfway. Except when **No limit** is selected for Custom Setting c2 **Auto meter-off delay**, setting will also end when the exposure meters turn off.



f10: No Memory Card?

MENU button →  Custom Settings menu

Selecting **Enable release** allows the shutter to be released when no memory card is inserted, although no pictures will be recorded (they will however be displayed in the monitor in demo mode). If **Release locked** is selected, the shutter-release button is only enabled when a memory card is inserted in the camera.

f11: Reverse Indicators

MENU button →  Custom Settings menu

If  (+0-) is selected, the exposure indicators in the top control panel and information display are displayed with positive values on the left and negative values on the right. Select  (-0+) to display negative values on the left and positive values on the right.



Y The Setup Menu: *Camera Setup*

To display the setup menu, press **MENU** and select the **Y** (setup menu) tab.

MENU button



| Option | |
|------------------------------|-----|
| Format memory card | 326 |
| LCD brightness | 326 |
| Clean image sensor | 378 |
| Lock mirror up for cleaning* | 381 |
| Image Dust Off ref photo | 327 |
| Video mode | 329 |
| HDMI | 329 |
| Flicker reduction | 330 |
| Time zone and date | 330 |
| Language | 331 |
| Image comment | 331 |
| Auto image rotation | 332 |

| Option | |
|-----------------------|-----|
| Voice memo options | 246 |
| Battery info | 333 |
| Wireless transmitter | 257 |
| Image authentication | 334 |
| Copyright information | 335 |
| Save/load settings | 336 |
| GPS | 220 |
| Virtual horizon | 338 |
| Non-CPU lens data | 215 |
| AF fine tune | 339 |
| Firmware version | 340 |

* Not available when battery is low.

See Also

Menu defaults are listed on page 392.



Format Memory Card

MENU button → Y setup menu

To begin formatting, choose a memory card slot and select **Yes**. *Note that formatting permanently deletes all pictures and other data on the card in the selected slot.* Before formatting, be sure to make backup copies as required.

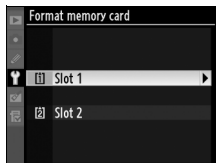

During Formatting

Do not turn the camera off or remove memory cards during formatting.

Two-Button Format

Memory cards can also be formatted by pressing the **FORMAT** (🗑️) and **MODE** (📖 39) buttons for more than two seconds.

LCD Brightness

MENU button → Y setup menu

Press ▲ or ▼ to choose monitor brightness. Choose higher values for increased brightness, lower values for reduced brightness.

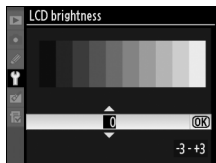

See Also

For information on adjusting monitor brightness in live view, see page 63.



Acquire reference data for the Image Dust Off option in Capture NX 2 (available separately; for more information, see the Capture NX 2 manual).

Image Dust Off ref photo is available only when a CPU lens is mounted on the camera. A non-DX lens with a focal length of at least 50 mm is recommended. When using a zoom lens, zoom all the way in.

1 Choose a start option.

Highlight one of the following options and press **OK**. To exit without acquiring image dust off data, press **MENU**.



- **Start:** The message shown at right will be displayed and “rEF” will appear in the viewfinder and top control panel displays.
- **Clean sensor and then start:** Select this option to clean the image sensor before starting. The message shown at right will be displayed and “rEF” will appear in the viewfinder and top control panel displays when cleaning is complete.

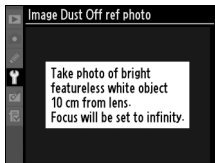

Image Sensor Cleaning

Dust off reference data recorded before image sensor cleaning is performed can not be used with photographs taken after image sensor cleaning is performed. Select **Clean image sensor and then start** only if the dust off reference data will not be used with existing photographs.



2 Frame a featureless white object in the viewfinder.

With the lens about ten centimeters (four inches) from a well-lit, featureless white object, frame the object so that it fills the viewfinder and then press the shutter-release button halfway.

In autofocus mode, focus will automatically be set to infinity; in manual focus mode, set focus to infinity manually.

3 Acquire dust off reference data.

Press the shutter-release button the rest of the way down to acquire Image Dust Off reference data. The monitor turns off when the shutter-release button is pressed.

If the reference object is too bright or too dark, the camera may be unable to acquire Image Dust Off reference data and the message shown at right will be displayed. Choose another reference object and repeat the process from Step 1.



Image Dust Off Reference Data

The same reference data can be used for photographs taken with different lenses or at different apertures. Reference images can not be viewed using computer imaging software. A grid pattern is displayed when reference images are viewed on the camera.



Video Mode

MENU button →  setup menu

When connecting the camera to a television or VCR via the audio/video (A/V OUT) connector, be sure the camera video mode matches the device video standard (NTSC or PAL).

HDMI

MENU button →  setup menu

The camera is equipped with an HDMI (High-Definition Multimedia Interface) connector, allowing pictures to be played back on high-definition televisions or monitors using a cable with a type C mini-pin connector (available separately from commercial suppliers). Before connecting the camera to high-definition device, choose the HDMI format from the options below.

| Option | Description |
|---------------------------------|---|
| AUTO Auto | The camera automatically selects the appropriate format. |
| 480P 480p (progressive) | 640 × 480 (progressive) format |
| 576P 576p (progressive) | 720 × 576 (progressive) format |
| 720P 720p (progressive) | 1,280 × 720 (progressive) format |
| 1080i 1080i (interlaced) | Photographs are displayed in 1,920 × 1,080 (interlaced) format; movies and live view are displayed in 1,280 × 720 format. |

The camera monitor turns off automatically when an HDMI device is connected.



Flicker Reduction

MENU button → Y setup menu

Reduce flicker and banding when shooting under fluorescent or mercury-vapor lighting during live view or movie recording. Choose a frequency which matches that of the local AC power supply.

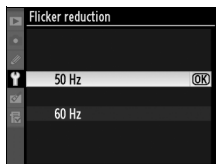

Flicker Reduction

If you are unsure as to the frequency of the local power supply, test both options and choose the one that produces the best results. Flicker reduction may not produce the desired results if the subject is very bright, in which case you should try choosing a smaller aperture (larger f-number). The desired results may also not be achieved in high-sensitivity movie mode or, due to the fact the selected shutter speed is not always used, during exposure preview (□ 57). To prevent flicker during exposure preview, select mode **M** and choose a shutter speed adapted to the frequency of the local power supply: $1/125$ s, $1/60$ s, or $1/30$ s for 60 Hz; $1/100$ s, $1/50$ s, or $1/25$ s for 50 Hz.

Time Zone and Date

MENU button → Y setup menu

Change time zones, set the camera clock, choose the date display order, and turn daylight saving time on or off.

| Option | Description |
|-----------------------------|--|
| Time zone | Choose a time zone. The camera clock is automatically set to the time in the new time zone. |
| Date and time | Set the camera clock (□ 34). |
| Date format | Choose the order in which the day, month, and year are displayed. |
| Daylight saving time | Turn daylight saving time on or off. The camera clock will automatically be advanced or set back one hour. The default setting is Off . |

 **CLOCK** blinks in the top control panel when the clock is not set.

Choose a language for camera menus and messages. The following options are available.

| | | | | | |
|----|------------|------------|----|-----------|---------------------|
| Cz | Čeština | Czech | Pl | Polski | Polish |
| Dk | Dansk | Danish | Pt | Português | Portuguese |
| De | Deutsch | German | Ru | Русский | Russian |
| En | English | English | Fi | Suomi | Finnish |
| Es | Español | Spanish | Sv | Svenska | Swedish |
| Fr | Français | French | Tr | Türkçe | Turkish |
| Id | Indonesia | Indonesian | 繁 | 中文(繁體) | Traditional Chinese |
| It | Italiano | Italian | 简 | 中文(简体) | Simplified Chinese |
| Nl | Nederlands | Dutch | 日 | 日本語 | Japanese |
| No | Norsk | Norwegian | 한 | 한글 | Korean |

Image Comment

Add a comment to new photographs as they are taken. Comments can be viewed as metadata in ViewNX (supplied) or Capture NX 2 (available separately; □ 375). The comment is also visible on the third shooting data page in the photo information display (□ 232).

- **Done:** Save changes and return to the setup menu.
- **Input comment:** Input a comment as described on page 286. Comments can be up to 36 characters long.
- **Attach comment:** Select this option to attach the comment to all subsequent photographs. **Attach comment** can be turned on and off by highlighting it and pressing ►.

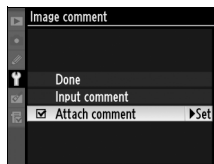

Photographs taken while **On** is selected contain information on camera orientation, allowing them to be rotated automatically during playback (☞ 282) or when viewed in ViewNX (supplied) or in Capture NX 2 (available separately; ☞ 375). The following orientations are recorded:



Landscape (wide)
orientation

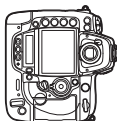

Camera rotated 90°
clockwise



Camera rotated 90°
counter-clockwise

Camera orientation is not recorded when **Off** is selected. Choose this option when panning or taking photographs with the lens pointing up or down.

Rotate Tall

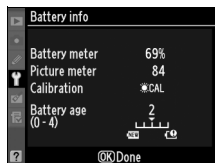

To automatically rotate “tall” (portrait-orientation) photographs for display during playback, select **On** for the **Rotate tall** option in the playback menu (☞ 282). Note that because the camera itself is already in the appropriate orientation during shooting, images are not rotated automatically during image review (☞ 224).

View information on the battery currently inserted in the camera.



| Item | Description |
|----------------------|---|
| Battery meter | The current battery level expressed as a percentage. |
| Picture meter | The number of times the shutter has been released with the current battery since the battery was last charged. Note that the camera may sometimes release the shutter without recording a photograph, for example when measuring preset white balance. |
| Calibration | <ul style="list-style-type: none"> ☼CAL: Due to repeated use and recharging, calibration is required to ensure that battery level can be measured accurately; recalibrate battery before charging (☐ 417). —: Calibration not required. |
| Battery age | A five-level display showing battery age. 0 (NEW) indicates that battery performance is unimpaired, 4 (☼) that the battery has reached the end of its charging life and should be replaced. Note that fresh batteries charged at temperatures under about 5 °C (41 °F) may show a temporary drop in charging life; the battery age display will however return to normal once the battery has been recharged at a temperature of about 20 °C (68 °F) or higher. |



Choose  **On** to embed image authentication information in new photographs as they are taken, allowing alterations to be detected using Nikon's optional Image Authentication software. Image authentication information can not be embedded in existing photographs. Photographs taken with image authentication on are marked with a  icon on the file information and overview pages of the photo information display (📖 226, 234).

Camera Control Pro 2

Image authentication information is not embedded in TIFF (RGB) photographs recorded directly to a computer using Camera Control Pro 2 (available separately).

Copies

Image authentication information is not embedded in copies created using the options in the retouch menu (📖 341).



Add copyright information to new photographs as they are taken. Copyright information is visible on the fourth shooting data page in the photo information display (□ 232) and can be viewed as metadata in ViewNX (supplied) or in Capture NX 2 (available separately; □ 375).

- **Done:** Save changes and return to the setup menu.
- **Artist:** Enter a photographer name as described on page 286. Photographer names can be up to 36 characters long.
- **Copyright:** Enter the name of the copyright holder as described on page 286. Copyright holder names can be up to 54 characters long.
- **Attach copyright information:** Select this option to attach copyright information to all subsequent photographs. **Attach copyright information** can be turned on and off by highlighting it and pressing ►.



Copyright Information

To prevent unauthorized use of the artist or copyright holder names, make sure that **Attach copyright information** is not selected and that the **Artist** and **Copyright** fields are blank before lending or transferring the camera to another person. Nikon does not accept liability for any damages or disputes arising from the use of the **Copyright information** option.

Select **Save settings** to save the following settings to the memory card in slot 1 (if the memory card is full, an error will be displayed; □ 405). Use this option to share settings among D3S cameras.

| Menu | Option |
|--------------------------------|---|
| Playback | Display mode |
| | Image review |
| | After delete |
| | Rotate tall |
| Shooting (all banks) | Shooting menu bank |
| | Extended menu banks |
| | File naming |
| | Slot 2 |
| | Image quality |
| | Image size |
| | Image area |
| | JPEG compression |
| | NEF (RAW) recording |
| | White balance (with fine tuning and presets d-0–d-4) |
| | Set Picture Control |
| | Color space |
| | Active D-Lighting |
| | Vignette control |
| | Long exp. NR |
| | High ISO NR |
| ISO sensitivity settings | |
| Live view mode | |
| Movie settings | |
| Custom settings (all banks) | All Custom Settings except Reset custom settings |



| Menu | Option |
|-----------------------------|--|
| Setup | Clean image sensor |
| | Video mode |
| | HDMI |
| | Flicker reduction |
| | Time zone and date (excepting date and time) |
| | Language |
| | Image comment |
| | Auto image rotation |
| | Voice memo options |
| | Image authentication |
| | Copyright information |
| | GPS |
| | Non-CPU lens data |
| My Menu/ Recent Settings | All My Menu items |
| | All recent settings |
| | Choose tab |

Settings saved using the D3S can be restored by selecting **Load settings**. Note that **Save/load settings** is only available when a memory card is inserted in slot 1, and that the **Load settings** option is only available if the card in slot 1 contains saved settings (the memory card in slot 2 can not be used to save or load settings).

Saved Settings

Settings are saved in a file named NCSETUP6. The camera will not be able to load settings if the file name is changed.



Display a virtual horizon based on information from the camera image sensor. If the camera is level, the reference line will be displayed in green.

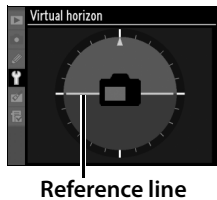



Tilting the Camera

The virtual horizon display is not accurate when the camera is tilted at a sharp angle forward or back. If the camera is unable to measure tilt, the amount of tilt will not be displayed.

See Also

For information on using the exposure indicators as a tilt meter, see Custom Setting f4 (**Assign Fn button** > **Fn button press**;  316, 318). For information on displaying a virtual horizon in live view, see page 62.

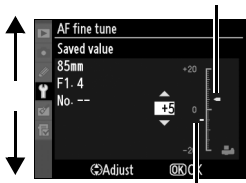
Fine-tune focus for up to 20 lens types. AF tuning is not recommended in most situations and may interfere with normal focus; use only when required.

| Option | Description | |
|------------------------------|--|---|
| AF fine tune (On/Off) | <ul style="list-style-type: none"> • On: Turn AF tuning on. • Off: Turn AF tuning off. | |
| Saved value | Tune AF for the current lens (CPU lenses only). Press ▲ or ▼ to choose a value between +20 and -20. Values for up to 20 lens types can be stored. Only one value can be stored for each type of lens. | Move focal point away from camera. Current value  |
| Default | Choose the AF tuning value used when no previously saved value exists for the current lens (CPU lenses only). | Move focal point toward camera. Previous value |
| List saved values | List previously saved AF tuning values. If a value exists for the current lens, it will be shown with a ■ icon. To delete a lens from the list, highlight the desired lens and press  . To change a lens identifier (for example, to choose an identifier that is the same as the last two digits of the lens serial number to distinguish it from other lenses of the same type in light of the fact that Saved value can be used with only one lens of each type), highlight the desired lens and press ►. The menu shown at right will be displayed; press ▲ or ▼ to choose an identifier and press  to save changes and exit. | |



AF Tuning

The camera may be unable to focus at minimum range or at infinity when AF tuning is applied.

Live View (Tripod) Mode

Tuning is not applied to contrast-detect autofocus when **Tripod** is selected in live view mode (📖 55).

Saved Value

Only one value can be stored for each type of lens. If a teleconverter is used, separate values can be stored for each combination of lens and teleconverter.

Firmware Version

MENU button →  setup menu

View the current camera firmware version.













The Retouch Menu: *Creating Retouched Copies*

To display the retouch menu, press **MENU** and select the  (retouch menu) tab.

MENU button



The options in the retouch menu are used to create trimmed, or retouched copies of existing pictures. The retouch menu is only displayed when a memory card containing photographs is inserted in the camera.

| Option |  |
|--|---|
|  D-Lighting * | 344 |
|  Red-eye correction * | 345 |
|  Trim | 346 |
|  Monochrome * | 347 |
|  Filter effects * | 348 |
|  Color balance * | 348 |
|  Image overlay | 349 |
|  NEF (RAW) processing | 353 |
|  Resize | 355 |
|  Side-by-side comparison | 357 |
|  Edit movie | 74 |

* Not available with photographs taken with **Monochrome** selected for **Set Picture Control** ( 170).



Creating Retouched Copies

To create a retouched copy:

1 Select an item in the retouch menu.

Press ▲ or ▼ to highlight an item, ► to select. Depending on the option selected, a menu may be displayed; highlight an option and press ►.

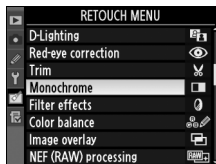

2 Select a picture.

The pictures on the memory card will be displayed. Use the multi selector to highlight a picture (to view the highlighted picture full screen, press and hold the  button).

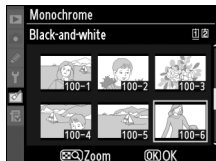

To view images in other locations, press ▲ while pressing  and select the desired card and folder as described on page 224.



Retouch

The camera may not be able to display or retouch images created with other devices.



3 Display retouch options.

Press **OK** to display retouch options (see the section for the selected option for details). To exit without creating a retouched copy, press **MENU**.



Monitor off Delay

The monitor will turn off automatically if no operations are performed for 20 s. Any unsaved changes will be lost. To increase the time the monitor remains on, choose a longer menu display time for Custom Setting c4 (**Monitor off delay**,  306).

4 Create a retouched copy.

Press **OK** to create a retouched copy. Retouched copies are indicated by a  icon.



Retouching Copies

Most options can be applied to copies created using other retouch options, although with the exceptions of **Image overlay** and **Edit movie > Choose start point/Choose end point** each option can only be applied once (note that multiple edits may result in loss of detail). Copies created with **Trim**, **Resize**, or **Save selected frame** can not be further modified. D-Lighting, red-eye correction, filter effects, and color balance can not be applied to monochrome copies.

Image Quality

Except in the case of copies created with **Trim**, **Image overlay**, **NEF (RAW) processing**, and **Resize**, copies created from JPEG images are the same size and quality as the original, copies created from NEF (RAW) photos are saved as large fine-quality JPEG images, and copies created from TIFF (RGB) photos are saved as fine-quality JPEG images of the same size as the original. Size-priority compression is used when copies are saved in JPEG format.



D-Lighting brightens shadows, making it ideal for dark or backlit photographs.

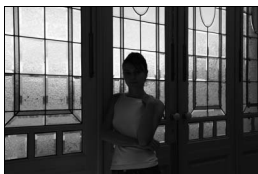

Before

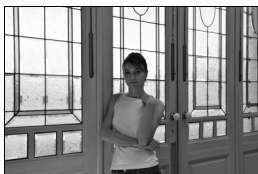

After

Press ▲ or ▼ to choose the amount of correction performed. The effect can be previewed in the edit display. Press OK to copy the photograph.

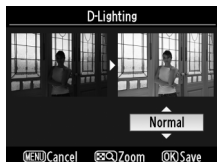

This option is used to correct “red-eye” caused by the flash and is available only with photographs taken using a flash. The photograph selected for red-eye correction is previewed as shown at right. Confirm the effects of red-eye correction and create a copy as described in the following table. Note that red-eye correction may not always produce the expected results and may in very rare circumstances be applied to portions of the image that are not affected by red-eye; check the preview thoroughly before proceeding.









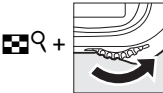

| To | Use | Description |
|----------------------------------|-----|--|
| Zoom in | | Press button and rotate main command dial right to zoom in, left to zoom out. While photo is zoomed in, press and use multi selector to view areas of image not visible in monitor. Keep multi selector pressed to scroll rapidly to other areas of frame. While button is pressed, area currently visible in monitor is indicated by yellow border. Press to cancel zoom. |
| Zoom out | | |
| View other areas of image | | |
| Cancel zoom | | |
| Create copy | | |

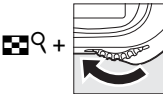

Create a cropped copy of the selected photograph. The selected photograph is displayed with the selected crop shown in yellow; create a cropped copy as described in the following table.



| To | Use | Description |
|--------------------------|---|--|
| Reduce size of crop |  | Press  button and rotate main command dial right to reduce the size of the crop. |
| Increase size of crop |  | Press  button and rotate main command dial left to increase the size of the crop. |
| Change crop aspect ratio |  | Rotate the main command dial to switch between aspect ratios of 3 : 2, 4 : 3, 5 : 4, 1 : 1, and 16 : 9. |
| Move crop |  | Use multi selector to move the crop to other areas of the image. |
| Preview crop |  | Press center of multi selector to preview cropped image. |
| Create copy |  | Save the current crop as a separate file. |

Trim: Image Quality and Size

Copies created from NEF (RAW), NEF (RAW) + JPEG, or TIFF (RGB) photos have an image quality (📖 83) of JPEG fine; cropped copies created from JPEG photos have the same image quality as the original. The size of the copy varies with crop size and aspect ratio.

| Aspect ratio | Possible sizes |
|--------------|--|
| 3 : 2 | 3,424 × 2,280, 2,560 × 1,704, 1,920 × 1,280, 1,280 × 856, 960 × 640, 640 × 424 |
| 4 : 3 | 3,424 × 2,568, 2,560 × 1,920, 1,920 × 1,440, 1,280 × 960, 960 × 720, 640 × 480 |
| 5 : 4 | 3,216 × 2,568, 2,400 × 1,920, 1,808 × 1,440, 1,200 × 960, 896 × 720, 608 × 480 |
| 1 : 1 | 2,560 × 2,560, 1,920 × 1,920, 1,440 × 1,440, 960 × 960, 720 × 720, 480 × 480 |
| 16 : 9 | 3,424 × 1,920, 2,560 × 1,440, 1,920 × 1,080, 1,280 × 720, 960 × 536, 640 × 360 |

Viewing Cropped Copies

Playback zoom may not be available when cropped copies are displayed.

Monochrome

MENU button →  retouch menu

Copy photographs in **Black-and-white**, **Sepia**, or **Cyanotype** (blue and white monochrome).

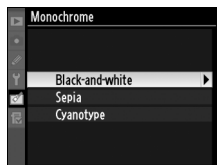

Selecting **Sepia** or **Cyanotype** displays a preview of the selected image; press ▲ to increase color saturation, ▼ to decrease. Press  to create a monochrome copy.

Increase saturation



Decrease saturation

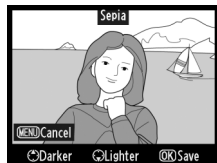

Filter Effects

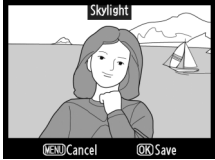

MENU button →  retouch menu

Choose from the following color filter effects. After adjusting filter effects as described below, press  to copy the photograph.

| Option | Description |
|--------------------|---|
| Skylight | Creates the effect of a skylight filter, making the picture less blue. The effect can be previewed in the monitor as shown at right.  |
| Warm filter | Creates a copy with warm tone filter effects, giving the copy a “warm” red cast. The effect can be previewed in the monitor. |

Color Balance

MENU button →  retouch menu

Use the multi selector to create a copy with modified color balance as shown below. The effect is displayed in the monitor together with red, green, and blue histograms ( 228) giving the distribution of tones in the copy. Press  to copy the photograph.

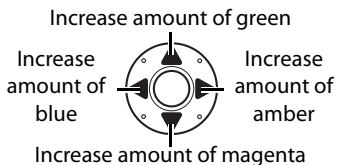

Zoom





To zoom in on the image displayed in the monitor, press , rotate the main command dial to the right, and then release the  button. The histogram will be updated to show data only for the portion of the image displayed in the monitor. To choose the area displayed using zoom, press  and use the multi selector. To exit zoom, press the  button and rotate the main command dial to the left.



Image Overlay

MENU button →  retouch menu

Image overlay combines two existing NEF (RAW) photographs to create a single picture that is saved separately from the originals; the results, which make use of RAW data from the camera image sensor, are noticeably better than photographs combined in an imaging application. The new picture is saved at current image quality and size settings; before creating an overlay, set image quality and size ( 83, 86; all options are available). To create a NEF (RAW) copy, choose an image quality of **NEF (RAW)**.

1 Select Image overlay.

Highlight **Image overlay** and press . The dialog shown at right will be displayed, with **Image 1** highlighted.



2 Display NEF (RAW) images.

Press **OK** to display a picture selection dialog listing only NEF (RAW) images created with this camera.

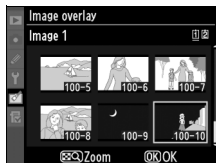

3 Select a photograph.

Highlight the first photograph in the overlay. To view the highlighted photograph full frame, press and hold the **Q** button. Press **OK** to select the highlighted photograph and return to the preview display.

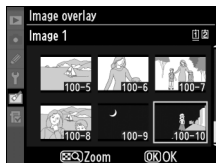

4 Select the second photograph.

The selected image will appear as **Image 1**. Press **▶** to highlight **Image 2** and repeat steps 2–3 to select the second photo.



5 Set gain.

Highlight **Image 1** or **Image 2** and optimize exposure for the overlay by pressing ▲ or ▼ to select the gain for image 1 from values between 0.1 and 2.0. Repeat for the second image. The default value is 1.0; selecting 0.5 cuts gain in half, while selecting 2.0 doubles gain. The effects of gain are visible in the **Preview** column.

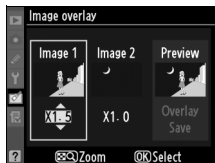

6 Highlight the Preview column.

Press ◀ or ▶ to highlight the **Preview** column.



7 Preview the overlay.

Press ▲ or ▼ to highlight **Overlay** and press Ⓞ (to save the overlay without displaying a preview, highlight **Save** and press Ⓞ). To return to Step 5 and select new photos or adjust gain, press Ⓞ.



8 Save the overlay.

Press **OK** while the preview is displayed to save the overlay. After an overlay is created, the resulting image will be displayed full-frame in the monitor.

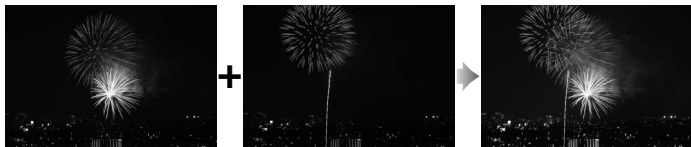

Image Overlay

Only NEF (RAW) photographs created with the D3S can be selected for image overlay. Other images are not displayed in the selection dialog. Only NEF (RAW) photographs with the same image area and bit-depth can be combined.

The overlay has the same photo info (including date of recording, metering, shutter speed, aperture, exposure mode, exposure compensation, focal length, and image orientation) and values for white balance and picture control as the photograph selected for **Image 1**. The current image comment is appended to the overlay when it is saved; copyright information, however, is not copied. Overlays saved in NEF (RAW) format use the compression selected for **Type** in the **NEF (RAW) recording** menu and have the same bit depth as the original images; JPEG overlays are saved using size-priority compression.



Create JPEG copies of NEF (RAW) photographs.

1 Select NEF (RAW) processing.

Highlight **NEF (RAW) processing** and press  to display a picture selection dialog listing only NEF (RAW) images created with this camera.

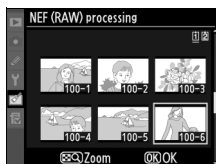

2 Select a photograph.

Use the multi selector to highlight a photograph (to view the highlighted photograph full frame, press and hold the  button). Press  to select the highlighted photograph and proceed to the next step.

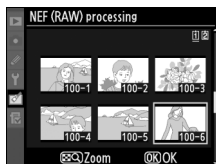

3 Adjust NEF (RAW) processing settings.

Choose image quality (☐ 83), image size (☐ 86), white balance (☐ 150), exposure compensation (☐ 134), a Picture Control (☐ 170; note that the Picture Control grid can not be displayed), high ISO noise reduction (☐ 291), color space (☐ 183), and vignette control (☐ 290) for the JPEG copy. Note that white balance and vignette control are not available with multiple exposures or pictures created with image overlay and that exposure compensation increments differ from those used in shooting mode.

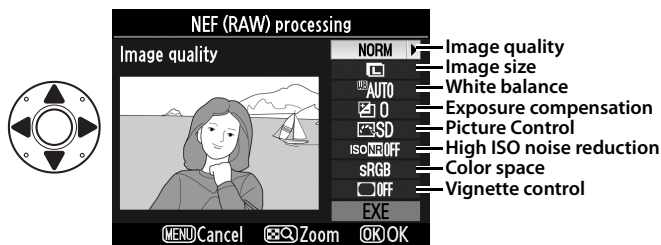

4 Copy the photograph.

Highlight **EXE** and press **OK** to create a JPEG copy of the selected photograph. To exit without copying the photograph, press the **MENU** button.



Create small copies of selected photographs.

1 Select Resize.

Highlight **Resize** and press **▶**.
The dialog shown at right will be displayed.

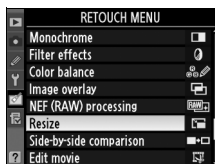

2 Choose a size.

Highlight **Choose size** and press **▶**.



The following options will be displayed; highlight an option and press **OK**.

| Option | Size (pixels) | Option | Size (pixels) |
|--------------|---------------|--------------|---------------|
| 2.5 M | 1920 × 1280 | 0.6 M | 960 × 640 |
| 1.1 M | 1280 × 856 | 0.3 M | 640 × 424 |

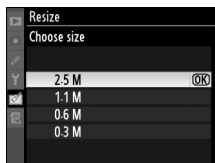

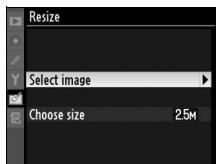

3 Choose pictures.

Highlight **Select image** and press **▶**.



The dialog shown at right will be displayed; highlight pictures using the multi selector and press the center of the multi selector to select or deselect (to view the



highlighted picture full screen, press and hold the  button). Selected pictures are marked by a  icon. Press **OK** when the selection is complete. Note that photographs taken at an image-area setting of 5 : 4 ( 79) can not be resized.

4 Save the resized copies.

A confirmation dialog will be displayed. Highlight **Yes** and press **OK** to save the resized copies.

Viewing Resized Copies

Playback zoom may not be available when resized copies are displayed.

Image Quality

Copies created from NEF (RAW), NEF (RAW) + JPEG, or TIFF (RGB) photos have an image quality ( 83) of JPEG fine; copies created from JPEG photos have the same image quality as the original.



Compare retouched copies to the original photographs.



■ Making a Side-by-Side Comparison

1 Select Side-by-side comparison.

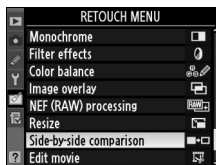
Highlight **Side-by-side comparison** and press  to display a picture selection dialog.



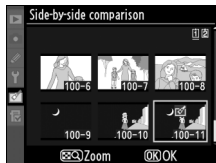

2 Select a picture.

Use the multi selector to highlight a picture and press . Only retouched copies (shown by a  icon) or photographs that have been retouched can be selected. To view the highlighted photograph full frame, press and hold the  button.



3 Compare the copy with the original.

The source image is displayed on the left, the retouched copy on the right, with the options used to create the copy listed at the top of the display. Press ◀ or ▶ to switch between the source image and the retouched copy. To view the highlighted picture full frame, press and hold the  button. If the copy was created from two images using **Image overlay**, press ▲ or ▼ to view the other source image. To exit to retouch menu, press the MENU button. To return to Step 2 with the highlighted image selected, press .



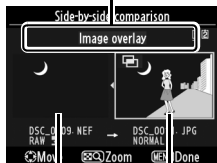

Options used to create copy



Source image Retouched copy

Side-by-Side Comparison

The source image will not be displayed if the copy was created from a photograph that was protected ( 238), has since been deleted or hidden ( 275), is on a card that is now in a different slot, or contains embedded image authentication information ( 334).



My Menu: *Creating a Custom Menu*

To display My Menu, press **MENU** and select the  (My Menu) tab.

MENU button





The **My Menu** option can be used to create and edit a customized list of options from the playback, shooting, Custom Settings, setup, and retouch menus for quick access (up to 20 items). If desired, recent settings can be displayed in place of My Menu ( 363).

Options can be added, deleted, and reordered as described below.

Adding Options to My Menu

1 Select Add items.

In My Menu () , highlight **Add items** and press .



2 Select a menu.

Highlight the name of the menu containing the option you wish to add and press .

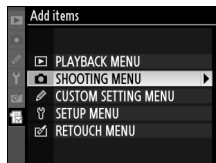

3 Select an item.

Highlight the desired menu item and press **OK**.

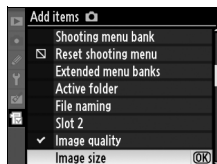

4 Position the new item.

Press **▲** or **▼** to move the new item up or down in My Menu. Press **OK** to add the new item.



5 Add more items.

The items currently displayed in My Menu are indicated by a check mark. Items indicated by a icon can not be selected. Repeat steps 1–4 to select additional items.

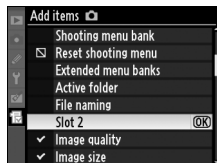

Deleting Options from My Menu

1 Select Remove items.

In My Menu (☰), highlight **Remove items** and press ►.

2 Select items.

Highlight items and press ► to select or deselect. Selected items are indicated by a check mark.

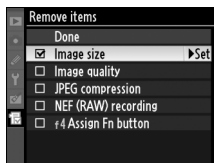

3 Select Done.

Highlight **Done** and press **OK**. A confirmation dialog will be displayed.

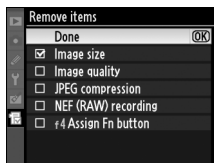



4 Delete the selected items.

Press **OK** to delete the selected items.



Deleting Items in My Menu

To delete the item currently highlighted in My Menu, press the  button. A confirmation dialog will be displayed; press  again to remove the selected item from My Menu.



Reordering Options in My Menu

1 Select Rank items.

In My Menu (MENU), highlight **Rank items** and press ►.

2 Select an item.

Highlight the item you wish to move and press OK.





3 Position the item.

Press ▲ or ▼ to move the item up or down in My Menu and press OK. Repeat Steps 2–3 to reposition additional items.





Reordering Items in My Menu



The item currently highlighted in My Menu can be moved up or down by pressing the  button and pressing ▲ or ▼. Release the  button when the operation is complete.



Displaying Recent Settings



To display the twenty most recently used settings, select  **Recent settings** for  **My Menu** > **Choose tab**.

1 Select Choose tab.

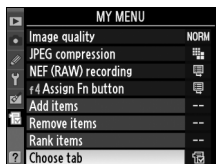

In My Menu () , highlight **Choose tab** and press .



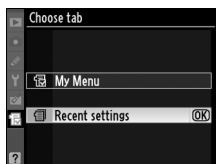

2 Select Recent settings.

Highlight  **Recent settings** and press . The name of the menu will change from “MY MENU” to “RECENT SETTINGS.”



Menu items will be added to the top of the recent settings menu as they are used. To view My Menu again, select  **My Menu** for  **Recent settings** > **Choose tab**.

Removing Items from the Recent Settings Menu

To remove an item from the recent settings menu, highlight it and press the  button. A confirmation dialog will be displayed; press  again to delete the selected item.







Technical Notes



– *Camera Care, Options, and Resources*

Read this chapter for information on compatible accessories, cleaning and storing the camera, and what to do if an error message is displayed or you encounter problems using the camera.

| | |
|--|------------|
| Compatible Lenses | 366 |
| Other Accessories | 372 |
| Caring for the Camera | 377 |
| Storage | 377 |
| Cleaning..... | 377 |
| The Low-Pass Filter..... | 378 |
| Replacing the Focusing Screen | 384 |
| Replacing the Clock Battery..... | 386 |
| Caring for the Camera and Battery: Cautions | 388 |
| Defaults | 392 |
| Exposure Program | 397 |
| Troubleshooting | 398 |
| Error Messages | 403 |
| Specifications | 408 |
| Calibrating Batteries | 417 |
| Approved Memory Cards | 419 |
| Memory Card Capacity | 420 |
| Battery Life | 423 |



Compatible Lenses

| Camera setting Lens/accessory | | Focus mode | | | Exposure mode | | Metering system | | |
|--|--|----------------|---------------------------------------|---|-----------------|-----------------|---|-----------------|---|
| | | S C | M (with electronic rangefinder) | M | P S | A M |  | |  |
| | | | | | | | 3D | Color | |
| CPU lenses ¹¹ | Type G or D AF NIKKOR ² AF-S, AF-I NIKKOR | ✓ | ✓ | ✓ | ✓ | ✓ | ✓ | — | ✓ ³ |
| | PC-E NIKKOR series | — | ✓ ⁵ | ✓ | ✓ ⁵ | ✓ ⁵ | ✓ ⁵ | — | ✓ ^{3,5} |
| | PC Micro 85mm f/2.8D ⁴ | — | ✓ ⁵ | ✓ | — | ✓ ⁶ | ✓ | — | ✓ ^{3,5} |
| | AF-S / AF-I Teleconverter ⁷ | ✓ ⁸ | ✓ ⁸ | ✓ | ✓ | ✓ | ✓ | — | ✓ ³ |
| | Other AF NIKKOR (except lenses for F3AF) | ✓ ⁹ | ✓ ⁹ | ✓ | ✓ | ✓ | — | ✓ | ✓ ³ |
| | AI-P NIKKOR | — | ✓ ¹⁰ | ✓ | ✓ | ✓ | — | ✓ | ✓ ³ |
| Non-CPU lenses ¹¹ | AI-, AI-modified, NIKKOR or Nikon Series E lenses ¹² | — | ✓ ¹⁰ | ✓ | — | ✓ ¹³ | — | ✓ ¹⁴ | ✓ ¹⁵ |
| | Medical-NIKKOR 120mm f/4 | — | ✓ | ✓ | — | ✓ ¹⁶ | — | — | — |
| | Reflex-NIKKOR | — | — | ✓ | — | ✓ ¹³ | — | — | ✓ ¹⁵ |
| | PC-NIKKOR | — | ✓ ⁵ | ✓ | — | ✓ ¹⁷ | — | — | ✓ |
| | AI-type Teleconverter ¹⁸ | — | ✓ ⁸ | ✓ | — | ✓ ¹³ | — | ✓ ¹⁴ | ✓ ¹⁵ |
| | PB-6 Bellows Focusing Attachment ¹⁹ | — | ✓ ⁸ | ✓ | — | ✓ ²⁰ | — | — | ✓ |
| Auto extension rings (PK-series 11A, 12, or 13; PN-11) | — | ✓ ⁸ | ✓ | — | ✓ ¹³ | — | — | ✓ | |

- IX-NIKKOR lenses can not be used.
- Vibration Reduction (VR) supported with VR lenses.
- Spot metering meters selected focus point (□ 116).
- The camera's exposure metering and flash control systems do not work properly when shifting and/or tilting the lens, or when an aperture other than the maximum aperture is used.
- Can not be used with shifting or tilting.
- Manual exposure mode only.
- Can be used with AF-S and AF-I lenses only (□ 368).
- With maximum effective aperture of f/5.6 or faster.

- 9 When focusing at minimum focus distance with AF 80–200mm f/2.8, AF 35–70mm f/2.8, AF 28–85mm f/3.5–4.5 <New>, or AF 28–85mm f/3.5–4.5 lens at maximum zoom, in-focus indicator may be displayed when image on matte screen in viewfinder is not in focus. Adjust focus manually until image in viewfinder is in focus.
 - 10 With maximum aperture of f/5.6 or faster.
 - 11 Some lenses can not be used (see page 369).
 - 12 Range of rotation for AI 80–200mm f/2.8 ED tripod mount is limited by camera body. Filters can not be exchanged while AI 200–400mm f/4 ED is mounted on camera.
 - 13 If maximum aperture is specified using **Non-CPU lens data** (□ 214), aperture value will be displayed in viewfinder and top control panel.
 - 14 Can be used only if lens focal length and maximum aperture are specified using **Non-CPU lens data** (□ 214). Use spot or center-weighted metering if desired results are not achieved.
 - 15 For improved precision, specify lens focal length and maximum aperture using **Non-CPU lens data** (□ 214).
 - 16 Can be used in manual exposure modes at shutter speeds slower than flash sync speed by one step or more.
 - 17 Exposure determined by presetting lens aperture. In aperture-priority auto exposure mode, preset aperture using lens aperture ring before performing AE lock and shifting lens. In manual exposure mode, preset aperture using lens aperture ring and determine exposure before shifting lens.
 - 18 Exposure compensation required when used with AI 28–85mm f/3.5–4.5, AI 35–105mm f/3.5–4.5, AI 35–135mm f/3.5–4.5, or AF-S 80–200mm f/2.8D. See teleconverter manual for details.
 - 19 Requires PK-12 or PK-13 auto extension ring. PB-6D may be required depending on camera orientation.
 - 20 Use preset aperture. In aperture-priority auto exposure mode, set aperture using focusing attachment before determining exposure and taking photograph.
- PF-4 Reprocopy Outfit requires PA-4 Camera Holder.



Recognizing CPU and Type G and D Lenses

CPU lenses can be identified by the presence of CPU contacts, type G and D lenses by a letter on the lens barrel. Type G lenses are not equipped with a lens aperture ring.

CPU contacts

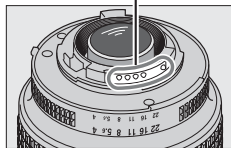

CPU lens

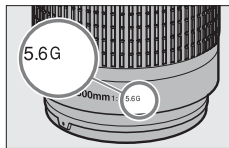

Type G lens

Aperture ring

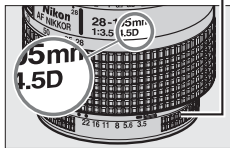

Type D lens

The AF-S/AF-I Teleconverter

The AF-S/AF-I teleconverter can be used with the following AF-S and AF-I lenses:

- AF-S VR Micro 105mm f/2.8G ED¹
- AF-S VR 200mm f/2G ED
- AF-S VR 300mm f/2.8G ED
- AF-S 300mm f/2.8D ED II
- AF-S 300mm f/2.8D ED
- AF-I 300mm f/2.8D ED
- AF-S 300mm f/4D ED²
- AF-S 400mm f/2.8D ED II
- AF-S 400mm f/2.8D ED
- AF-I 400mm f/2.8D ED
- AF-S 500mm f/4D ED II²
- AF-S 500mm f/4D ED²
- AF-I 500mm f/4D ED²
- AF-S 600mm f/4D ED II²
- AF-S 600mm f/4D ED²
- AF-I 600mm f/4D ED²
- AF-S NIKKOR 70–200mm f/2.8G ED VR II
- AF-S VR 70–200mm f/2.8G ED
- AF-S 80–200mm f/2.8D ED
- AF-S VR 200–400mm f/4G ED²
- AF-S NIKKOR 400mm f/2.8G ED VR
- AF-S NIKKOR 500mm f/4G ED VR²
- AF-S NIKKOR 600mm f/4G ED VR²

1 Autofocus not supported.

2 Autofocus not supported when used with AF-S Teleconverter TC-17E II/TC-20E II.

Lens f-number

The f-number given in lens names is the maximum aperture of the lens.



Compatible Non-CPU Lenses

If lens data are specified using **Non-CPU lens data** (☐ 214), many of the features available with CPU lenses can also be used with non-CPU lenses. If lens data are not specified, color matrix metering can not be used, and center-weighted metering is used when matrix metering is selected.

Non-CPU lenses can only be used in exposure modes **A** and **M**, when aperture must be set using the lens aperture ring. If the maximum aperture has not been specified using **Non-CPU lens data**, the camera aperture display will show the number of stops from maximum aperture; the actual aperture value must be read off the lens aperture ring. Aperture-priority auto will be selected automatically in exposure modes **P** and **S**. The exposure-mode indicator (**P** or **S**) in the top control panel will blink, and **A** will be displayed in the viewfinder.

Incompatible Accessories and Non-CPU Lenses

The following can NOT be used with the D3S:

- TC-16AS AF teleconverter
- Non-AI lenses
- Lenses that require the AU-1 focusing unit (400mm f/4.5, 600mm f/5.6, 800mm f/8, 1200mm f/11)
- Fisheye (6mm f/5.6, 7.5mm f/5.6, 8mm f/8, OP 10mm f/5.6)
- 2.1cm f/4
- Extension Ring K2
- 180–600mm f/8 ED (serial numbers 174041–174180)
- 360–1200mm f/11 ED (serial numbers 174031–174127)
- 200–600mm f/9.5 (serial numbers 280001–300490)
- AF lenses for the F3AF (AF 80mm f/2.8, AF 200mm f/3.5 ED, AF Teleconverter TC-16)
- PC 28mm f/4 (serial number 180900 or earlier)
- PC 35mm f/2.8 (serial numbers 851001–906200)
- PC 35mm f/3.5 (old type)
- Reflex 1000mm f/6.3 (old type)
- Reflex 1000mm f/11 (serial numbers 142361–143000)
- Reflex 2000mm f/11 (serial numbers 200111–200310)



Picture Angle and Focal Length

The D3S can be used with Nikon lenses for 35mm (135) format cameras. If **Auto DX crop** is on and a 35mm format lens is attached, the picture angle will be the same as a frame of 35mm film (36.0×23.9 mm); if a DX lens is attached, the picture angle will automatically be adjusted to 23.5×15.6 mm (DX format).

To choose a picture angle different from that of the current lens, turn **Auto DX crop** off and select from **FX (36×24)**, **1.2x (30×20)**, **DX (24×16)**, and **5 : 4 (30×24)**. If a 35mm format lens is attached, the picture angle could be reduced by 1.5x by selecting **DX (24×16)** or by 1.2x by selecting **1.2x (30×20)**, to expose a smaller area, or the aspect ratio could be changed by selecting **5 : 4 (30×24)**.

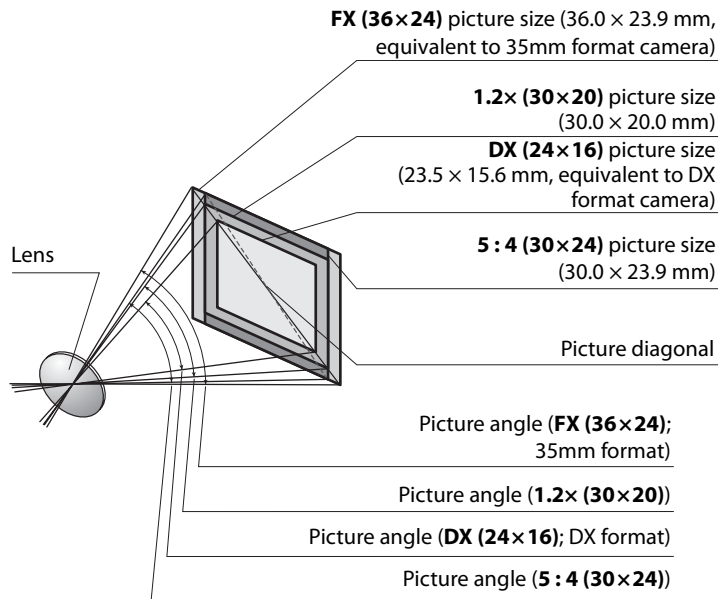

Picture Angle and Focal Length (Continued)

The **DX (24×16)** picture angle is about 1.5 times smaller than the 35mm format picture angle, while the **1.2× (30×20)** picture angle is about 1.2 times smaller and the **5 : 4 (30×24)** picture angle is about 1.1 times smaller. To calculate the focal length of lenses in 35mm format when **DX (24×16)** is selected, multiply the focal length of the lens by about 1.5, by about 1.2 when is **1.2× (30×20)** selected, or by about 1.1 when **5 : 4 (30×24)** is selected (for example, the effective focal length of a 50mm lens in 35mm format would be 75 mm when **DX (24×16)** is selected, 60 mm when **1.2× (30×20)** is selected, or 55 mm when **5 : 4 (30×24)** is selected).



Other Accessories

At the time of writing, the following accessories were available for the D3S.

| | |
|------------------------------|--|
| Power sources | <ul style="list-style-type: none">• EN-EL4a and EN-EL4 Rechargeable Li-ion Batteries (□ 26, 28): Additional EN-EL4a/EN-EL4 batteries are available from local retailers and Nikon service representatives. These batteries can be recharged and calibrated using an MH-22 or MH-21 quick charger.• MH-22 and MH-21 Quick Chargers (□ 26, 417): The MH-22, MH-21 can be used to recharge EN-EL4a and EN-EL4 batteries.• AC Adapter EH-6: This AC adapter can be used to power the camera for extended periods. |
| Wireless LAN adapters | <ul style="list-style-type: none">• Wireless Transmitter WT-4: Connects the camera to wireless and Ethernet networks. The photographs on the camera memory card can be viewed by computers on the same network or copied to a computer for long-term storage. The camera can also be controlled from any computer on the network using Camera Control Pro 2 (available separately). Note that the WT-4 requires an independent power source in the form of an optional EH-6 AC adapter or EN-EL3e battery. See the WT-4 manual for details. |

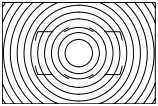
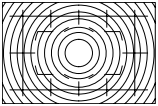

- **Focusing Screens** (☞ 384): The focusing screens available for the D3S are listed below.

| | | |
|--|---|--|
| Type B Brite View clear- matte VI focusing screen |  | A type B focusing screen is supplied with the camera. |
| Type E clear-matte VI focusing screen |  | Type E focusing screens are etched with a grid, making them suitable for copying and architectural photography. Best results are achieved with PC-NIKKOR lenses. |

- **Rubber Eyepiece Cup DK-19:** The DK-19 makes the image in the viewfinder easier to see, preventing eye fatigue.
- **Diopter-Adjustment Viewfinder Lens DK-17C:** To accommodate individual differences in vision, viewfinder lenses are available with diopters of -3 , -2 , 0 , $+1$, and $+2$ m^{-1} . Use diopter adjustment lenses only if the desired focus can not be achieved with the built-in diopter adjustment control (-3 to $+1$ m^{-1}). Test diopter adjustment lenses before purchase to ensure that the desired focus can be achieved. The DK-17C is equipped with a safety lock.
- **Magnifying Eyepiece DK-17M:** The DK-17M magnifies the view through the viewfinder by approximately $1.2\times$ for greater precision when framing. The DK-17M is equipped with a safety lock.
- **Magnifier DG-2:** The DG-2 magnifies the scene displayed in the viewfinder. Use for close-up photography, copying, telephoto lenses, and other tasks that call for added precision. DK-18 eyepiece adapter (available separately) required.
- **Eyepiece Adapter DK-18:** The DK-18 is used when attaching the DG-2 magnifier or DR-3 right-angle viewing attachment to the D3S.



| | |
|--|--|
| Viewfinder eyepiece accessories | <ul style="list-style-type: none"> • DK-14 and DK-17A Antifog Finder Eyepieces: These viewfinder eyepieces prevent fogging in humid or cold conditions. The DK-17A is equipped with a safety lock. • DR-5 and DR-4 Right-Angle Viewing Attachments: The DR-5 and DR-4 attach to the viewfinder eyepiece at a right angle, allowing the image in the viewfinder to be viewed from above when the camera is in the horizontal shooting position. The DR-5 can also magnify the view through the viewfinder by 2 × for greater precision when framing (note that the edges of the frame will not be visible when the view is magnified). |
| Filters | <ul style="list-style-type: none"> • Nikon filters can be divided into three types: screw-on, slip-in, and rear-interchange. Use Nikon filters; filters manufactured by other makers may interfere with autofocus or electronic range finding. • The D3S can not be used with linear polarizing filters. Use the C-PL circular polarizing filter instead. • Use NC filters to protect the lens. • To prevent ghosting, use of a filter is not recommended when the subject is framed against a bright light, or when a bright light source is in the frame. • Center-weighted metering is recommended with filters with exposure factors (filter factors) over 1 × (Y44, Y48, Y52, O56, R60, X0, X1, C-PL, ND2S, ND4, ND4S, ND8, ND8S, ND400, A2, A12, B2, B8, B12). See the filter manual for details. |
| Optional flash units | <ul style="list-style-type: none"> • Nikon SB-900, SB-800, SB-600, and SB-400 Speedlights • Nikon Wireless Remote Speedlight SB-R200 controlled remotely using the SB-900, SB-800 flash unit or SU-800 wireless Speedlight commander. • Wireless Speedlight Commander SU-800 See page 187 for more information. |
| Water guards | <ul style="list-style-type: none"> • Water Guard WG-AS1: The optional WG-AS1 is a water guard that covers the base of SB-900 flash units mounted on the D3S, increasing the SB-900's splash resistance by protecting the accessory shoe contacts from rain and spray. |



| | |
|-------------------------|--|
| PC card adapters | <ul style="list-style-type: none"> • EC-AD1 PC Card Adapter: The EC-AD1 PC card adapter allows Type I CompactFlash memory cards to be inserted in PCMCIA card slots. |
| Software | <ul style="list-style-type: none"> • Capture NX 2: A complete photo editing package with such advanced editing features as selection control points and an auto retouch brush. • Camera Control Pro 2: Control the camera remotely from a computer and save photographs directly to the computer hard disk. • Image Authentication: Determine whether photographs taken with image authentication (📄 334) on have been modified after shooting. <p>Note: Use the latest versions of Nikon software. Most Nikon software offers an auto update feature when the computer is connected to the Internet. See the websites listed on page xxiv for the latest information on supported operating systems.</p> |
| Body cap | <ul style="list-style-type: none"> • BF-1B and BF-1A Body Caps: The body cap keeps the mirror, viewfinder screen, and low-pass filter free of dust when a lens is not in place. |



Remote terminal accessories

The D3S is equipped with a ten-pin remote terminal for remote control and automatic photography. The terminal is provided with a cap, which protects the contacts when the terminal is not in use. The following accessories can be used (all lengths are approximate):

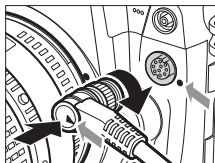

- **Remote Cord MC-22:** Remote shutter release with blue, yellow, and black terminals for connection to a remote shutter-triggering device, allowing control via sound or electronic signals (length 1 m/3 ft. 3 in.).
- **Remote Cord MC-30:** Remote shutter release; can be used to reduce camera shake (length 80 cm/2 ft. 7 in.).
- **Remote Cord MC-36:** Remote shutter release; can be used for interval timer photography or to reduce camera shake or keep the shutter open during a time exposure (length 85 cm/2 ft. 9 in.).
- **Extension Cord MC-21:** Can be connected to ML-3 or MC-series 20, 22, 23, 25, 30, or 36. Only one MC-21 can be used at a time (length 3 m/9 ft. 10 in.).
- **Connecting Cord MC-23:** Connects two cameras for simultaneous operation (length 40 cm/1 ft. 4 in.).
- **Adapter Cord MC-25:** Ten-pin to two-pin adapter cord for connection to devices with two-pin terminals, including the MW-2 radio control set, MT-2 intervalometer, and ML-2 modulite control set (length 20 cm/8 in.).
- **GPS Unit GP-1** (□ 217): Record latitude, longitude, altitude, and UTC time with pictures.
- **GPS Adapter Cord MC-35** (□ 217): Connects GPS devices to D3S via PC cable supplied by manufacturer of GPS device (length 35 cm/1 ft. 2 in.).
- **Modulite Remote Control Set ML-3:** Allows infrared remote control at ranges of up to 8 m (26 ft. 3 in.).



Caring for the Camera

Storage

When the camera will not be used for an extended period, remove the battery and store it in a cool, dry area with the terminal cover in place. To prevent mold or mildew, store the camera in a dry, well-ventilated area. Do not store your camera with naphtha or camphor moth balls or in locations that:

- are poorly ventilated or subject to humidities of over 60%
- are next to equipment that produces strong electromagnetic fields, such as televisions or radios
- are exposed to temperatures above 50 °C (122 °F) or below -10 °C (14 °F)

Cleaning

| | |
|-------------------------------------|--|
| Camera body | Use a blower to remove dust and lint, then wipe gently with a soft, dry cloth. After using the camera at the beach or seaside, wipe off sand or salt with a cloth lightly dampened in distilled water and dry thoroughly. Important: <i>Dust or other foreign matter inside the camera may cause damage not covered under warranty.</i> |
| Lens, mirror, and viewfinder | These glass elements are easily damaged. Remove dust and lint with a blower. If using an aerosol blower, keep the can vertical to prevent the discharge of liquid. To remove fingerprints and other stains, apply a small amount of lens cleaner to a soft cloth and clean with care. |
| Monitor | Remove dust and lint with a blower. When removing fingerprints and other stains, wipe the surface lightly with a soft cloth or chamois leather. Do not apply pressure, as this could result in damage or malfunction. |

Do not use alcohol, thinner, or other volatile chemicals.



The Low-Pass Filter

The image sensor that acts as the camera's picture element is fitted with a low-pass filter to prevent moiré. If you suspect that dirt or dust on the filter is appearing in photographs, you can clean the filter using the **Clean image sensor** option in the setup menu. The filter can be cleaned at any time using the **Clean now** option, or cleaning can be performed automatically when the camera is turned on or off.

■ "Clean Now"

1 Place the camera base down.

Image sensor cleaning is most effective when the camera is placed base down as shown at right.

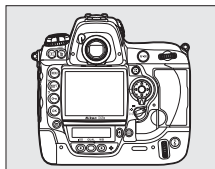

2 Select **Clean image sensor** in the setup menu.

Press **MENU** to display the menus. Highlight **Clean image sensor** in the setup menu and press ►.

MENU button

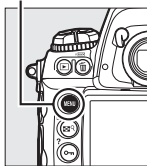

3 Select **Clean now**.

Highlight **Clean now** and press

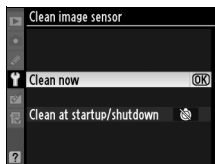

The message shown at right will be displayed while cleaning is in progress.



The message shown at right will be displayed when cleaning is complete.



■ *"Clean at Startup/Shutdown"*

1 Select **Clean at startup/shutdown**.

Display the **Clean image sensor** menu as described in Step 2 on the previous page. Highlight **Clean at startup/shutdown** and press



2 Select an option.

Highlight one of the following options and press **OK**.

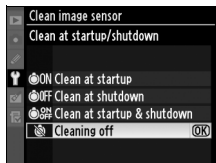

| Option | Description |
|--|---|
| Clean at startup | The image sensor is automatically cleaned each time the camera is turned on. |
| Clean at shutdown | The image sensor is automatically cleaned during shutdown each time the camera is turned off. |
| Clean at startup & shutdown | The image sensor is cleaned automatically at startup and at shutdown. |
| Cleaning off | Automatic image sensor cleaning off. |

Image Sensor Cleaning

Using camera controls interrupts image sensor cleaning.

Cleaning is performed by vibrating the low-pass filter. If dust can not be fully removed using the options in the **Clean image sensor** menu, clean the image sensor manually (📖 381) or consult a Nikon-authorized service representative.

If image sensor cleaning is performed several times in succession, image sensor cleaning may be temporarily disabled to protect the camera's internal circuitry. Cleaning can be performed again after a short wait.

Manual Cleaning

If foreign matter can not be removed from the low-pass filter using the **Clean image sensor** (☐ 378) option in the setup menu, the filter can be cleaned manually as described below. Note, however, that the filter is extremely delicate and easily damaged. Nikon recommends that the filter be cleaned only by Nikon-authorized service personnel.

1 Charge the battery or connect an AC adapter.

A reliable power source is required when inspecting or cleaning the low-pass filter. If the battery level is below  (60%), turn the camera off and insert a fully-charged EN-EL4a battery or connect an optional EH-6 AC adapter.

2 Select Lock mirror up for cleaning.

Remove the lens and turn the camera on. Highlight **Lock mirror up for cleaning** in the setup menu and press **▶** (note that this option is not available at battery levels of  or below).



3 Press **OK**.

The message shown at right will be displayed in the monitor and a row of dashes will appear in the top control panel and viewfinder. To restore normal operation without inspecting the low-pass filter, turn the camera off.

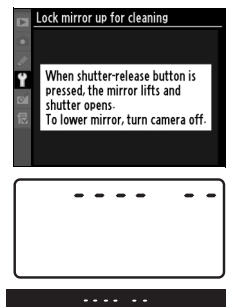

4 Raise the mirror.

Press the shutter-release button all the way down. The mirror will be raised and the shutter curtain will open, revealing the low-pass filter. The display in the viewfinder will turn off and the row of dashes in the top control panel will blink.



5 Examine the low-pass filter.

Holding the camera so that light falls on the low-pass filter, examine the filter for dust or lint. If no foreign objects are present, proceed to Step 7.

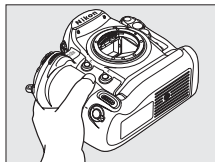

6 Clean the filter.

Remove any dust and lint from the filter with a blower. Do not use a blower-brush, as the bristles could damage the filter. Dirt that can not be removed with a blower can only be removed by Nikon-authorized service personnel. Under no circumstances should you touch or wipe the filter.

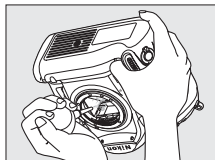

7 Turn the camera off.

The mirror will return to the down position and the shutter curtain will close. Replace the lens or body cap.



Use a Reliable Power Source

The shutter curtain is delicate and easily damaged. If the camera powers off while the mirror is raised, the curtain will close automatically. To prevent damage to the curtain, observe the following precautions:

- Do not turn the camera off or remove or disconnect the power source while the mirror is raised.
- If the battery runs low while the mirror is raised, a beep will sound and the self-timer lamp will blink to warn that the shutter curtain will close and the mirror will be lowered after about two minutes. End cleaning or inspection immediately.

Foreign Matter on the Low-Pass Filter

Nikon takes every possible precaution to prevent foreign matter from coming into contact with the low-pass filter during production and shipping. The D3S, however, is designed to be used with interchangeable lenses, and foreign matter may enter the camera when lenses are removed or exchanged. Once inside the camera, this foreign matter may adhere to the low-pass filter, where it may appear in photographs taken under certain conditions. To protect the camera when no lens is in place, be sure to replace the body cap provided with the camera, being careful to first remove all dust and other foreign matter that may be adhering to the body cap.

Should foreign matter find its way onto the low-pass filter, clean the filter as described above, or have the filter cleaned by authorized Nikon service personnel. Photographs affected by the presence of foreign matter on the filter can be retouched using Capture NX 2 (available separately; □ 375) or the clean image options available in some third-party imaging applications.

Servicing the Camera and Accessories

The camera is a precision device and requires regular servicing. Nikon recommends that the camera be inspected by the original retailer or Nikon service representative once every one to two years, and that it be serviced once every three to five years (note that fees apply to these services). Frequent inspection and servicing are particularly recommended if the camera is used professionally. Any accessories regularly used with the camera, such as lenses or optional flash units, should be included when the camera is inspected or serviced.



Replacing the Focusing Screen

A type B clear-matte VI focusing screen is inserted in the camera at shipment. To insert an optional type E clear-matte VI focusing screen for D3S cameras (☐ 373):

1 Remove the lens.

Turn the camera off and remove the lens.

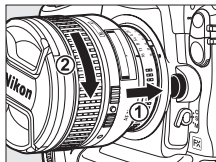

2 Unlatch the screen holder.

Using the tweezers supplied with the focusing screen, pull the focusing screen latch towards you. The screen holder will spring open.

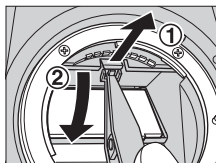

3 Remove the existing screen.

Remove the existing screen, using the supplied tweezers and being careful to handle the screen by the tab to avoid scratches.

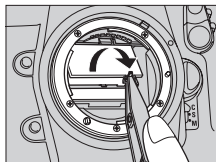

4 Insert the replacement screen.

Using the tweezers and handling the screen by the tab, set the replacement screen in the holder.

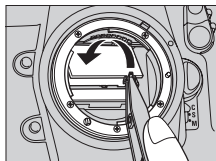

5 Latch the screen holder.

Push the front edge of holder upward until it clicks into place.

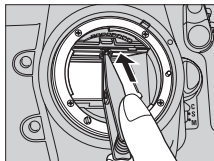

Replacing Focusing Screens

Do not touch the surface of the mirror or focusing screens.

Framing Grids

The display in type E focusing screens may be slightly out of position depending on how the focusing screen is placed.



Replacing the Clock Battery

The camera clock is powered by a CR1616 lithium battery with a life of about four years. If the **CLOCK** icon is displayed in the top control panel while the exposure meters are on, the battery is running low and needs to be replaced. When the battery is exhausted, the **CLOCK** icon will blink while the exposure meters are on. Photographs can still be taken but will not be stamped with the correct time and date, and interval timer photography will not function correctly. Replace the battery as described below.

1 Remove the main battery.

The clock battery chamber is located on the roof of the main battery chamber. Turn the camera off and remove the EN-EL4a battery.

2 Open the clock battery chamber.

Slide the clock battery chamber cover toward the front of the main battery chamber.

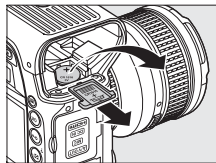

3 Remove the clock battery.

4 Insert the replacement battery.

Insert a new CR1616 lithium battery so that the positive side (the side marked with “+” and the battery name) is visible.

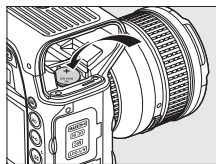

5 Close the clock battery chamber.

Slide the clock battery chamber cover towards the back of the main battery chamber until it clicks into place.

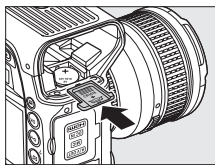

6 Replace the main battery.

Reinsert the EN-EL4a.

7 Set the camera clock.

Set the camera to the current date and time (📖 34). Until the date and time have been set, the **CLOCK** icon will flash in the top control panel.

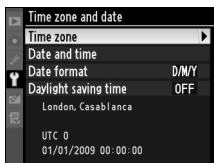

CAUTION

Use only CR1616 lithium batteries. Using another type of battery could cause an explosion. Dispose of used batteries as directed.

Inserting the Clock Battery

Insert the clock battery in the correct orientation. Inserting the battery incorrectly could not only prevent the clock from functioning but could damage the camera.



Caring for the Camera and Battery: Cautions

Do not drop: The product may malfunction if subjected to strong shocks or vibration.

Keep dry: This product is not waterproof, and may malfunction if immersed in water or exposed to high levels of humidity. Rusting of the internal mechanism can cause irreparable damage.

Avoid sudden changes in temperature: Sudden changes in temperature, such as occur when entering or leaving a heated building on a cold day, can cause condensation inside the device. To prevent condensation, place the device in a carrying case or plastic bag before exposing it to sudden changes in temperature.

Keep away from strong magnetic fields: Do not use or store this device in the vicinity of equipment that generates strong electromagnetic radiation or magnetic fields. Strong static charges or the magnetic fields produced by equipment such as radio transmitters could interfere with the monitor, damage data stored on the memory card, or affect the product's internal circuitry.

Do not leave the lens pointed at the sun: Do not leave the lens pointed at the sun or other strong light source for an extended period. Intense light may cause the image sensor to deteriorate or produce a white blur effect in photographs.



Cleaning: When cleaning the camera body, use a blower to gently remove dust and lint, then wipe gently with a soft, dry cloth. After using the camera at the beach or seaside, wipe off any sand or salt using a cloth lightly dampened in pure water and then dry the camera thoroughly. In rare instances, static electricity may cause the LCD displays to light up or go dark. This does not indicate a malfunction, and the display will soon return to normal.

The lens and mirror are easily damaged. Dust and lint should be gently removed with a blower. When using an aerosol blower, keep the can vertical to prevent discharge of liquid. To remove fingerprints and other stains from the lens, apply a small amount of lens cleaner to a soft cloth and wipe the lens carefully.

See “The Low-Pass Filter” (□ 378) for information on cleaning the low-pass filter.

Lens contacts: Keep the lens contacts clean.

Do not touch the shutter curtain: The shutter curtain is extremely thin and easily damaged. Under no circumstances should you exert pressure on the curtain, poke it with cleaning tools, or subject it to powerful air currents from a blower. These actions could scratch, deform, or tear the curtain.

The shutter curtain may appear to be unevenly colored, but this has no affect on pictures and does not indicate a malfunction.

Storage: To prevent mold or mildew, store the camera in a dry, well-ventilated area. If you are using an AC adapter, unplug the adapter to prevent fire. If the product will not be used for an extended period, remove the battery to prevent leakage and store the camera in a plastic bag containing a desiccant. Do not, however, store the camera case in a plastic bag, as this may cause the material to deteriorate. Note that desiccant gradually loses its capacity to absorb moisture and should be replaced at regular intervals.

To prevent mold or mildew, take the camera out of storage at least once a month. Turn the camera on and release the shutter a few times before putting it away.

Store the battery in a cool, dry place. Replace the terminal cover before putting the battery away.



Turn the product off before removing or disconnecting the power source: Do not unplug the product or remove the battery while the product is on or while images are being recorded or deleted. Forcibly cutting power in these circumstances could result in loss of data or in damage to product memory or internal circuitry. To prevent an accidental interruption of power, avoid carrying the product from one location to another while the AC adapter is connected.

Dry the accessory shoe cover: If the camera is used in the rain, water may penetrate the supplied BS-2 accessory shoe cover. Remove and dry the accessory shoe cover after using the camera in the rain.

Notes on the monitor: The monitor may contain a few pixels that are always lit or that do not light. This is common to all TFT LCD monitors and does not indicate a malfunction. Images recorded with the product are unaffected.

Images in the monitor may be difficult to see in a bright light.

Do not apply pressure to the monitor, as this could cause damage or malfunction. Dust or lint on the monitor can be removed with a blower. Stains can be removed by wiping lightly with a soft cloth or chamois leather. Should the monitor break, care should be taken to avoid injury from broken glass and to prevent liquid crystal from the monitor touching the skin or entering the eyes and mouth.



Batteries: Dirt on the battery terminals can prevent the camera from functioning and should be removed with a soft, dry cloth before use.

Batteries may leak or explode if improperly handled. Observe the following precautions when handling batteries:

Turn the product off before replacing the battery.

The battery may become hot when used for extended periods. Observe due caution when handling the battery.

Use only batteries approved for use in this equipment.

Do not expose the battery to flame or excessive heat.

After removing the battery from the camera, be sure to replace the terminal cover.

Charge the battery before use. When taking photographs on important occasions, ready a spare battery and keep it fully charged. Depending on your location, it may be difficult to purchase replacement batteries on short notice.

On cold days, the capacity of batteries tends to decrease. Be sure the battery is fully charged before taking photographs outside in cold weather. Keep a spare battery in a warm place and exchange the two as necessary. Once warmed, a cold battery may recover some of its charge.

Continuing to charge the battery after it is fully charged can impair battery performance.

Used batteries are a valuable resource. Please recycle used batteries in accord with local regulations.



Defaults

The default settings for the options in the camera menus are listed below. For information on two-button reset, see page 200.

■ Playback Menu Defaults

| Option | Default |
|-------------------------|-----------|
| Playback folder (☞ 275) | NCD3S |
| Image review (☞ 281) | Off |
| After delete (☞ 281) | Show next |
| Rotate tall (☞ 282) | Off |
| Slide show (☞ 282) | |
| Frame interval (☞ 282) | 2 s |
| Audio Playback (☞ 283) | Off |

■ Shooting Menu Defaults ¹

| Option | Default |
|-----------------------------|---------------------|
| Extended menu banks (☞ 287) | Off |
| File naming (☞ 290) | DSC |
| Slot 2 (☞ 88) | Overflow |
| Image quality (☞ 83) | JPEG normal |
| Image size (☞ 86) | Large |
| Image area (☞ 78) | |
| Auto DX crop (☞ 78) | On |
| Choose image area (☞ 79) | FX (36×24) |
| JPEG compression (☞ 85) | Size priority |
| NEF (RAW) recording (☞ 85) | |
| Type | Lossless compressed |
| NEF (RAW) bit depth | 12-bit |
| White balance (☞ 149) | Auto |
| Fine tuning (☞ 153) | Off |
| Choose color temp. (☞ 157) | 5000 K |
| Set Picture Control (☞ 170) | Standard |
| Color space (☞ 183) | sRGB |
| Active D-Lighting (☞ 181) | Off |
| Vignette control (☞ 290) | Normal |

| | |
|--|----------------------|
| Long exp. NR (☐ 291) | Off |
| High ISO NR (☐ 291) | Normal |
| ISO sensitivity settings (☐ 109) | |
| ISO sensitivity (☐ 110) | 200 |
| ISO sensitivity auto control (☐ 112) | Off |
| Live view mode (☐ 55, 59) | Tripod |
| Multiple exposure (☐ 202) ² | |
| Multiple exposure mode (☐ 203) | Off |
| Number of shots (☐ 204) | 2 |
| Auto gain (☐ 205) | On |
| Movie settings (☐ 70) | |
| Quality (☐ 70) | 640 × 424 (3 : 2) |
| Microphone (☐ 71) | Auto sensitivity (A) |
| Destination (☐ 71) | Slot 1 |
| High-sensitivity movie mode (☐ 72) | Off |
| Interval timer shooting (☐ 208) | Reset ³ |

- 1 Default settings can be restored using **Reset shooting menu** (☐ 287).
With the exception of **Multiple exposure** and **Interval timer shooting**, only settings in the current shooting menu bank will be reset.
- 2 Applies to all banks. **Reset shooting menu** can not be selected while shooting is in progress.
- 3 Applies to all banks. Shooting ends when reset is performed.

■ Custom Settings Menu Defaults*

| | Option | Default |
|----|-------------------------------------|---------------|
| a1 | AF-C priority selection (☐ 295) | Release |
| a2 | AF-S priority selection (☐ 296) | Focus |
| a3 | Dynamic AF area (☐ 296) | 9 points |
| a4 | Focus tracking with lock-on (☐ 298) | 3 (Normal) |
| a5 | AF activation (☐ 298) | Shutter/AF-ON |
| a6 | Focus point illumination (☐ 299) | |
| | Manual focus mode | On |
| | Continuous mode | On |
| | Focus point brightness | Normal |



| | Option | Default |
|-----|--------------------------------------|-----------------|
| a7 | Focus point wrap-around (☞ 299) | No wrap |
| a8 | AF point selection (☞ 300) | 51 points |
| a9 | AF-ON button (☞ 300) | AF-ON |
| a10 | Vertical AF-ON button (☞ 301) | AF-ON |
| b1 | ISO sensitivity step value (☞ 302) | 1/3 step |
| b2 | EV steps for exposure cntrl. (☞ 302) | 1/3 step |
| b3 | EV steps for exposure comp. (☞ 302) | 1/3 step |
| b4 | Easy exposure compensation (☞ 303) | Off |
| b5 | Center-weighted area (☞ 304) | ∅ 12 mm |
| b6 | Fine tune optimal exposure (☞ 304) | |
| | Matrix metering | 0 |
| | Center-weighted metering | 0 |
| | Spot metering | 0 |
| c1 | Shutter-release button AE-L (☞ 305) | Off |
| c2 | Auto meter-off delay (☞ 305) | 6 s |
| c3 | Self-timer (☞ 305) | 10 s |
| c4 | Monitor off delay (☞ 306) | |
| | Playback | 10 s |
| | Menus | 20 s |
| | Information display | 10 s |
| | Image review | 4 s |
| d1 | Beep (☞ 306) | Off |
| d2 | Shooting speed (☞ 307) | |
| | Continuous high-speed | 9 fps |
| | Continuous low-speed | 5 fps |
| d3 | Max. continuous release (☞ 307) | 130 |
| d4 | File number sequence (☞ 308) | On |
| d5 | Control panel/viewfinder (☞ 309) | |
| | Rear control panel | ISO sensitivity |
| | Viewfinder display | Frame count |
| d6 | Information display (☞ 309) | Auto |
| d7 | Screen tips (☞ 310) | On |
| d8 | LCD illumination (☞ 310) | Off |
| d9 | Exposure delay mode (☞ 310) | Off |

| | Option | Default |
|-----|--------------------------------------|---|
| e1 | Flash sync speed (📖 311) | 1/250 s |
| e2 | Flash shutter speed (📖 312) | 1/60 s |
| e3 | Modeling flash (📖 312) | On |
| e4 | Auto bracketing set (📖 312) | AE & flash |
| e5 | Auto bracketing (Mode M) (📖 313) | Flash/speed |
| e6 | Bracketing order (📖 313) | MTR > under > over |
| f1 | Multi selector center button (📖 314) | |
| | Shooting mode | Select center focus point |
| | Playback mode | Thumbnail on/off |
| | Live view | Start movie recording |
| f2 | Multi selector (📖 315) | Do nothing |
| f3 | Photo info/playback (📖 315) | Info 🌐/Playback 🌐 |
| f4 | Assign Fn button (📖 316) | |
| | Fn button press (📖 316) | None |
| | Fn button + command dials (📖 318) | Choose image area |
| f5 | Assign preview button (📖 321) | |
| | Preview button press | Preview |
| | Preview + command dials | None |
| f6 | Assign AE-L/AF-L button (📖 321) | |
| | AE-L/AF-L button press | AE/AF lock |
| | AE-L/AF-L + command dials | None |
| f7 | Assign BKT button (📖 322) | Auto bracketing |
| f8 | Customize command dials (📖 322) | |
| | Reverse rotation | No |
| | Change main/sub | Off |
| | Aperture setting | Sub-command dial |
| | Menus and playback | Off |
| f9 | Release button to use dial (📖 324) | No |
| f10 | No memory card? (📖 324) | Enable release |
| f11 | Reverse indicators (📖 324) |  |

* Defaults for the current Custom Settings bank can be restored using **Reset custom settings** (📖 294).



■ ■ Setup Menu Defaults

| Option | Default |
|------------------------------|----------------|
| LCD brightness (☞ 326) | 0 |
| Clean image sensor | |
| Clean at startup/shutdown | Cleaning off |
| HDMI (☞ 329) | Auto |
| Time zone and date (☞ 330) | |
| Daylight saving time | Off |
| Auto image rotation (☞ 332) | On |
| Voice memo options (☞ 246) | |
| Voice memo | Off |
| Voice memo overwrite | Disable |
| Voice memo button | Press and hold |
| Audio output | Via speaker |
| Image authentication (☞ 334) | Off |
| GPS (☞ 220) | |
| Auto meter off | Enable |
| Use GPS to set camera clock | Yes |



Exposure Program

The exposure program for programmed auto is shown in the following graph:

— ISO 200; lens with maximum aperture of f/1.4 and minimum aperture of f/16 (e.g., AF 50mm f/1.4 D)

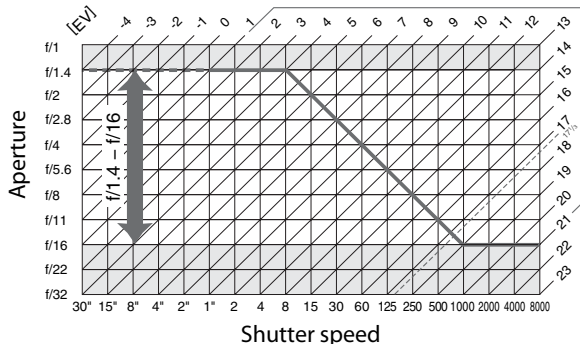

The maximum and minimum values for EV vary with ISO sensitivity; the above graph assumes an ISO sensitivity of ISO 200 equivalent. When matrix metering is used, values over $17 \frac{1}{3}$ EV are reduced to $17 \frac{1}{3}$ EV.



Troubleshooting

If the camera fails to function as expected, check the list of common problems below before consulting your retailer or Nikon representative.

■ ■ Display

Viewfinder is out of focus: Adjust viewfinder focus or use optional diopter adjustment lenses (☞ 41, 373).

Viewfinder is dark: Insert a fully-charged battery (☞ 26, 43).

Displays turn off without warning: Choose longer delays for Custom Setting c2 (**Auto meter-off delay**) or c4 (**Monitor off delay**) (☞ 305, 306).

Unusual characters displayed in top control panel: See “A Note on Electronically-Controlled Cameras,” below.

Displays in control panels or viewfinder are unresponsive and dim: The response times and brightness of these displays varies with temperature.

A Note on Electronically-Controlled Cameras

In extremely rare instances, unusual characters may appear in the monitor or top control panel and the camera may stop functioning. In most cases, this phenomenon is caused by a strong external static charge. Turn the camera off, remove and replace the battery, and turn the camera on again, or, if you are using an AC adapter (available separately), disconnect and reconnect the adapter and turn the camera on again. In the event of continued malfunction, contact your retailer or Nikon-authorized service representative. Note that disconnecting the power source as described above may result in loss of any data not recorded to the memory card at the time the problem occurred. Data already recorded to the card will not be affected.

■ Shooting

Camera takes time to turn on: Delete files or folders.

Shutter-release disabled:

- Memory card is full or not inserted (☐ 36, 44).
- CPU lens with aperture ring attached but aperture not locked at highest f-number. If **fE E** is displayed in the top control panel, select **Aperture ring** for Custom Setting f8 (**Customize command dials**) > **Aperture setting** to use lens aperture ring to adjust aperture (☐ 323).
- Exposure mode **S** selected with **bW L b** selected for shutter speed (☐ 404).

Camera is slow to respond to shutter-release button: Select **Off** for Custom Setting d9 (**Exposure delay mode**; ☐ 310).

Photos are out of focus:

- Rotate focus-mode selector to **S** or **C** (☐ 90).
- Camera unable to focus using autofocus: use manual focus or focus lock (☐ 96, 99).
- **Tripod** selected in live view: camera will not focus when shutter-release button is pressed halfway. Use **AF-ON** button (☐ 56).

Full range of shutter speeds not available: Flash in use. Flash sync speed can be selected using Custom Setting e1 (**Flash sync speed**); when using optional SB-900, SB-800, SB-600, or SB-R200 flash unit, choose **1/250 s (Auto FP)** for full range of shutter speeds (☐ 311).

Focus does not lock when shutter-release button is pressed halfway: Camera is in focus mode **C**: use **AE-L/AF-L** button to lock focus (☐ 97).

Can not select focus point:

- Unlock focus selector lock (☐ 94).
- Auto-area AF selected for AF-area mode: choose another mode (☐ 92).
- Camera is in playback mode (☐ 221).
- Menus are in use (☐ 273).
- Press shutter-release button halfway to activate exposure meters (☐ 45).

Image size can not be changed: **Image quality** set to **NEF (RAW)** (☐ 83).

Camera is slow to record photos: Turn long exposure noise reduction off (☐ 291).



Photos not recorded in live view mode:

- Sound of mirror clicking down when shutter-release button was pressed halfway in hand-held mode was mistaken for sound of shutter (☞ 63).
- Unless **Release** is chosen for Custom Setting a2 (**AF-S priority selection**), shutter release is disabled if camera is unable to focus when focus mode **S** is selected in hand-held mode (☞ 63, 296).

Flicker or banding appear during live view or movie recording: Choose an option for **Flicker reduction** that matches the frequency of the local AC power supply (☞ 330).

Bright bands appear during live view or movie recording: A flash or other light source with brief duration was used during live view or movie recording.

Highlights are “washed out” in movies or the live view display: Select **Off** for **High-sensitivity movie mode** (☞ 72).

Noise (randomly-spaced bright pixels, fog, or lines) appears in photos:

- Choose lower ISO sensitivity or use high ISO noise reduction (☞ 110, 291).
- Shutter speed is slower than 1 s: use long exposure noise reduction (☞ 291).
- Reddish areas or other artifacts appear in long time-exposures: turn long exposure noise reduction on when shooting at a shutter speed of “**1/2**” (☞ 291).

Photos are blotched or smeared:

- Clean lens.
- Clean low-pass filter (☞ 378).

Colors are unnatural:

- Adjust white balance to match light source (☞ 150).
- Adjust **Set Picture Control** settings (☞ 170).

Can not measure white balance: Subject is too dark or too bright (☞ 160).

Image can not be selected as source for preset white balance: Image was not created with D3S (☞ 164).

White balance bracketing unavailable:

- NEF (RAW) or NEF+JPEG image quality option selected for image quality (☞ 83).
 - Multiple exposure mode is in effect (☞ 207).
-



Effects of Picture Control differ from image to image: A (auto) is selected for sharpening, contrast, or saturation. For consistent results over a series of photographs, choose a setting other than A (auto) (☞ 174).

Can not adjust Picture Control contrast or brightness: Contrast and brightness can not be adjusted when Active D-Lighting is on. Turn Active D-Lighting off (☞ 174, 182).

Metering can not be changed: Live view is in progress, autoexposure lock is in effect, or movie is being recorded (☞ 61, 69, 133).

Exposure compensation can not be used: Choose exposure mode *P*, *S*, or *A* (☞ 134).

Sound is not recorded with movies:

- **Microphone off** is selected for **Movie settings > Microphone** (☞ 71).
- External microphone is disconnected during recording.

■■ Playback

Flashing areas, shooting data, or graphs appear on images: Press ▲ or ▼ to choose photo information displayed, or change settings for **Display mode** (☞ 225, 277).

NEF (RAW) image is not played back: Photo was taken at image quality of NEF + JPEG (☞ 84).

Can not view pictures recorded with other cameras: Pictures recorded with other makes of camera may not be displayed correctly.

Some photos are not displayed during playback: Select **All** for **Playback folder** (☞ 275).

“Tall” (portrait) orientation photos are displayed in “wide” (landscape) orientation:

- Select **On** for **Rotate tall** (☞ 282).
- Photo was taken with **Off** selected for **Auto image rotation** (☞ 332).
- Photo is displayed in image review (☞ 224).
- Camera was pointed up or down when photo was taken (☞ 332).

Can not delete photo: Photo is protected. Remove protection (☞ 238).

Can not retouch picture: Picture was not created with D3S (☞ 342).

Message is displayed stating that no images are available for playback: Select **All** for **Playback folder** (☞ 275).



Can not change print order: Memory card is full: delete photos (☐ 44, 240).

Can not select photo for printing: Photo is in NEF (RAW) format. Create JPEG copy using **NEF (RAW) processing** (☐ 353) or transfer to computer and print using ViewNX (supplied) or Capture NX 2 (available separately; ☐ 375).

Can not print photos: NEF (RAW) and TIFF photos can not be printed by direct USB connection. Use DPOF print service (TIFF images only), create JPEG copy using **NEF (RAW) processing** (☐ 353), or transfer to computer and print using ViewNX (supplied) or Capture NX 2 (available separately; ☐ 375).

Photo is not displayed on TV: Choose correct video mode (☐ 329).

Photo is not displayed on high-definition video device: Confirm that HDMI cable (available separately) is connected (☐ 271).

NEF (RAW) photos not displayed in Capture NX: Update to Capture NX 2 (☐ 375).

Image Dust Off option in Capture NX 2 does not have desired effect: Image sensor cleaning changes the position of dust on the low-pass filter. Dust off reference data recorded before image sensor cleaning is performed can not be used with photographs taken after image sensor cleaning is performed. Dust off reference data recorded after image sensor cleaning is performed can not be used with photographs taken before image sensor cleaning is performed (☐ 327).

Computer displays NEF (RAW) images differently from camera: Third-party software does not display effects of Picture Controls, Active D-Lighting, or vignette control. Use ViewNX (supplied) or optional Nikon software such as Capture NX 2 (available separately).

Can not copy pictures to computer using Nikon Transfer: Operating system is not supported (☐ 254). Transfer pictures from the memory card using a card reader or card slot.

■ ■ Miscellaneous







Date of recording is not correct: Set camera clock (☐ 34).

Menu item can not be selected: Some options are not available at certain combinations of settings or when no memory card is inserted. Note that **Battery info** option is not available when camera is powered by an optional AC adapter (☐ 333).





Error Messages



This section lists the indicators and error messages that appear in the viewfinder, top control panel, and monitor.

| Indicator | | Problem | Solution |  |
|---|---|--|---|---|
| Control panel | Viewfinder | | | |
| FE E (blinks) | | Lens aperture ring is not set to minimum aperture. | Set ring to minimum aperture (largest f-number). | 32 |
|  |  | Low battery. | Ready a fully-charged spare battery. | 43 |
|  (blinks) |  (blinks) | <ul style="list-style-type: none"> • Battery exhausted. • Battery can not be used. • An extremely exhausted rechargeable Li-ion battery or a third-party battery is inserted in the camera. | <ul style="list-style-type: none"> • Recharge or replace battery. • Contact Nikon-authorized service representative. • Replace the battery, or recharge the battery if the rechargeable Li-ion battery is exhausted. | xxiv, 26, 28 |
|  (blinks) | — | Camera clock is not set. | Set camera clock. | 34 |
| ΔF | | No lens attached, or non-CPU lens attached without specifying maximum aperture. Aperture shown in stops from maximum aperture. | Aperture value will be displayed if maximum aperture is specified. | 214 |





| Indicator | | Problem | Solution | 📖 |
|--|---|--|---|----------|
| Control panel | Viewfinder | | | |
| — | ▶ ◀ (blinks) | Camera unable to focus using autofocus. | Focus manually. | 99 |
| M f | | Subject too bright; photo will be overexposed. | • Use a lower ISO sensitivity | 110 |
| | | | • Use optional ND filter. | 374 |
| | | | In exposure mode: S Increase shutter speed | 122 |
| | | | A Choose a smaller aperture (larger f-number) | 123 |
| L a | | Subject too dark; photo will be underexposed. | • Use a higher ISO sensitivity | 110 |
| | | | • Use optional flash. In exposure mode: | 187 |
| | | | S Lower shutter speed | 122 |
| | | | A Choose a larger aperture (smaller f-number) | 123 |
| bulb (blinks) | | bulb selected in exposure mode S. | Change shutter speed or select manual exposure mode. | 122, 125 |
| busy (blinks) | busy (blinks) | [Lv] button pressed before multiple exposure is complete. | Live view is not available while multiple exposures are being shot. | 207 |
|  (blinks) |  (blinks) | Optional flash unit that does not support i-TTL flash control attached and set to TTL. | Change flash mode setting on optional flash unit. | 189 |



| Indicator | | Problem | Solution | 📖 |
|---|---|--|--|-----------------------------|
| Control panel | Viewfinder | | | |
| — |  (blinks) | If indicator blinks for 3s after flash fires, photo may be underexposed. | Check photo in monitor; if underexposed, adjust settings and try again. | 190 |
|  (blinks) | — | Flash unit that does not support red-eye reduction attached and flash sync mode set to red-eye reduction. | Change flash sync mode or use flash unit that supports red-eye reduction. | 188 |
| F u l l (blinks) | F u l (blinks) | Memory insufficient to record further photos at current settings, or camera has run out of file or folder numbers. | <ul style="list-style-type: none"> • Reduce quality or size. • Delete photographs after copying important images to computer or other device. • Insert new memory card. | 83, 86 240 36 |
| E r r (blinks) | | Camera malfunction. | Release shutter. If error persists or appears frequently, consult Nikon-authorized service representative. | — |



| Indicator | | Problem | Solution |  |
|---|-----------------------|--|--|---|
| Monitor | Control panel | | | |
| No memory card. | [- E -] | Camera cannot detect memory card. | Turn camera off and confirm that card is correctly inserted. | 36 |
| This memory card cannot be used. Card may be damaged. Insert another card. | [E H H] (blinks) | <ul style="list-style-type: none"> • Error accessing memory card. • Unable to create new folder. | <ul style="list-style-type: none"> • Use Nikon-approved card. • Check that contacts are clean. If card is damaged, contact retailer or Nikon representative. • Delete files or insert new memory card after copying important images to computer or other device. | 419 — 36, 240 |
| This card is not formatted. Format the card. | [F a r] (blinks) | Memory card has not been formatted for use in camera. | Format memory card or insert new memory card. | 36, 39 |
| Failed to update flash unit firmware. Flash cannot be used. Contact a Nikon-authorized service representative. | — | Firmware for flash unit mounted on camera was not updated correctly. | Contact a Nikon-authorized service representative. | — |
| Folder contains no images. | — | No images on memory card or in folder(s) selected for playback. | Select folder containing images from Playback folder menu or insert memory card containing images. | 36, 275 |

| Indicator | | Problem | Solution |  |
|--|---------------|---|--|---|
| Monitor | Control panel | | | |
| All images are hidden. | — | All photos in current folder are hidden. | No images can be played back until another folder has been selected or Hide image used to allow at least one image to be displayed. | 275 |
| File does not contain image data. | — | File has been created or modified using a computer or different make of camera, or file is corrupt. | File can not be played back on camera. | — |
| Cannot select this file. | — | Selected image can not be retouched. | Images created with other devices can not be retouched. | 342 |
| Check printer. | — | Printer error. | Check printer. To resume, select Continue (if available). | 259 * |
| Check paper. | — | Paper in printer is not of selected size. | Insert paper of correct size and select Continue . | 259 * |
| Paper jam. | — | Paper is jammed in printer. | Clear jam and select Continue . | 259 * |
| Out of paper. | — | Printer is out of paper. | Insert paper of selected size and select Continue . | 259 * |
| Check ink supply. | — | Ink error. | Check ink. To resume, select Continue . | 259 * |
| Out of ink. | — | Printer is out of ink. | Replace ink and select Continue . | 259 * |

* See printer manual for more information.



Specifications

■ Nikon D3S Digital Camera

| Type | |
|-----------------------|--|
| Type | Single-lens reflex digital camera |
| Lens mount | Nikon F mount (with AF coupling and AF contacts) |
| Effective pixels | |
| Effective pixels | 12.1 million |
| Image sensor | |
| Image sensor | 36.0 × 23.9 mm CMOS sensor (Nikon FX format) |
| Total pixels | 12.87 million |
| Dust-reduction System | Image sensor cleaning, Image Dust Off reference data (requires optional Capture NX 2 software) |
| Storage | |
| Image size (pixels) | <ul style="list-style-type: none">• FX (36×24) image area 4,256 × 2,832 (L) 3,184 × 2,120 (M) 2,128 × 1,416 (S)• 1.2× (30×20) image area 3,552 × 2,368 (L) 2,656 × 1,776 (M) 1,776 × 1,184 (S)• DX (24×16) image area 2,784 × 1,848 (L) 2,080 × 1,384 (M) 1,392 × 920 (S)• 5 : 4 (30×24) image area 3,552 × 2,832 (L) 2,656 × 2,120 (M) 1,776 × 1,416 (S) |
| File format | <ul style="list-style-type: none">• NEF (RAW): 12 or 14 bit, lossless compressed, compressed, or uncompressed• TIFF (RGB)• JPEG: JPEG-Baseline compliant with fine (approx. 1 : 4), normal (approx. 1 : 8), or basic (approx. 1 : 16) compression (Size priority); Optimal quality compression available• NEF (RAW)+JPEG: Single photograph recorded in both NEF (RAW) and JPEG formats |



| Storage | |
|-------------------------------|---|
| Picture Control System | Can be selected from Standard, Neutral, Vivid, Monochrome; selected Picture Control can be modified; storage for custom Picture Controls |
| Media | Type I CompactFlash memory cards (UDMA compliant) |
| Double slot | Slot 2 can be used for overflow or backup storage or for separate storage of NEF (RAW) and JPEG images; pictures can be copied between cards. |
| File system | DCF (Design Rule for Camera File System) 2.0, DPOF (Digital Print Order Format), Exif 2.21 (Exchangeable Image File Format for Digital Still Cameras), PictBridge |

| Viewfinder | |
|-------------------------------|--|
| Viewfinder | Eye-level pentaprism single-lens reflex viewfinder |
| Frame coverage | <ul style="list-style-type: none"> • FX (36×24): Approx. 100% horizontal and 100% vertical • 1.2× (30×20): Approx. 97% horizontal and 97% vertical • DX (24×16): Approx. 97% horizontal and 97% vertical • 5:4 (30×24): Approx. 97% horizontal and 100% vertical |
| Magnification | Approx. $0.7 \times$ (50 mm f/1.4 lens at infinity, -1.0 m^{-1}) |
| Eyepoint | 18 mm (-1.0 m^{-1}) |
| Diopter adjustment | -3 – $+1 \text{ m}^{-1}$ |
| Focusing screen | Ships with type B BriteView Clear Matte Mark VI screen with AF area brackets |
| Reflex mirror | Quick return |
| Depth-of-field preview | When Pv button is pressed, lens aperture is stopped down to value selected by user (F and M modes) or by camera (P and S modes) |
| Lens aperture | Instant return, electronically controlled |



Lens

| | |
|--------------------------|---|
| Compatible lenses | <ul style="list-style-type: none">• DX AF NIKKOR: All functions supported• Type G or D AF NIKKOR: All functions supported (PC Micro-NIKKOR does not support some functions). IX NIKKOR lenses not supported.• Other AF NIKKOR: All functions supported except 3D color matrix metering II. Lenses for F3AF not supported.• AI-P NIKKOR: All functions supported except 3D color matrix metering II• Non-CPU: Can be used in exposure modes A and M; color matrix metering and aperture value display supported if user provides lens data (AI lenses only) <p>Electronic rangefinder can be used if maximum aperture is f/5.6 or faster.</p> |
|--------------------------|---|

Shutter

| | |
|-------------------------|---|
| Type | Electronically-controlled vertical-travel focal-plane shutter |
| Speed | $1/8000$ – 30 s in steps of $1/3$, $1/2$, or 1 EV, bulb, X250 |
| Flash sync speed | X = $1/250$ s; synchronizes with shutter at $1/250$ s or slower |

Release

| | |
|---------------------------------------|---|
| Release mode | S (single frame), CL (continuous low speed), CH (continuous high speed), Q (quiet shutter-release), ⌚ (self-timer), MUP (mirror up) |
| Approximate frame advance rate | <ul style="list-style-type: none">• DX (24×16): Up to 9 fps (CL) or 9–11 fps (CH)• Other image areas: Up to 9 fps |
| Self-timer | Can be selected from 2, 5, 10, and 20 s duration |



| Exposure | |
|---|--|
| Metering | TTL exposure metering using 1,005-pixel RGB sensor |
| Metering method | <ul style="list-style-type: none"> • Matrix: 3D color matrix metering II (type G and D lenses); color matrix metering II (other CPU lenses); color matrix metering available with non-CPU lenses if user provides lens data • Center-weighted: Weight of 75% given to 12 mm circle in center of frame. Diameter of circle can be changed to 8, 15, or 20 mm, or weighting can be based on average of entire frame (non-CPU lenses use 12-mm circle or average of entire frame) • Spot: Meters 4 mm circle (about 1.5% of frame) centered on selected focus point (on center focus point when non-CPU lens is used) |
| Range (ISO 100, f/1.4 lens, 20 °C/68 °F) | <ul style="list-style-type: none"> • Matrix or center-weighted metering: 0–20 EV • Spot metering: 2–20 EV |
| Exposure meter coupling | Combined CPU and AI |
| Exposure mode | Programmed auto with flexible program (P); shutter-priority auto (S); aperture-priority auto (A); manual (M) |
| Exposure compensation | –5 – +5 EV in increments of $\frac{1}{3}$, $\frac{1}{2}$, or 1 EV |
| Exposure bracketing | 2–9 frames in steps of $\frac{1}{3}$, $\frac{1}{2}$, $\frac{2}{3}$, or 1 EV |
| Flash bracketing | 2–9 frames in steps of $\frac{1}{3}$, $\frac{1}{2}$, $\frac{2}{3}$, or 1 EV |
| White balance bracketing | 2–9 frames in steps of 1, 2, or 3 |
| ADL bracketing | 2 frames using selected value for one frame or 3–5 frames using preset values for all frames |
| Exposure lock | Luminosity locked at detected value with AE-L/AF-L button |
| ISO sensitivity (Recommended Exposure Index) | ISO 200 – 12800 in steps of $\frac{1}{3}$, $\frac{1}{2}$, or 1 EV. Can also be set to approx. 0.3, 0.5, 0.7, or 1 EV (ISO 100 equivalent) below ISO 200 or to approx. 0.3, 0.5, 0.7, 1, 2, or 3 EV (ISO 102400 equivalent) above ISO 12800; auto ISO sensitivity control available |
| Active D-Lighting | Can be selected from Auto, Extra high, High, Normal, Low, or Off |



| Focus | |
|------------------------|--|
| Autofocus | Nikon Multi-CAM 3500FX autofocus sensor module with TTL phase detection, fine-tuning, and 51 focus points (including 15 cross-type sensors) |
| Detection range | -1 – +19 EV (ISO 100, 20 °C/68 °F) |
| Lens servo | <ul style="list-style-type: none"> • Autofocus (AF): Single-servo AF (S); continuous-servo AF (C); predictive focus tracking automatically activated according to subject status • Manual (MF): Electronic range finding supported |
| Focus point | Can be selected from 51 or 11 focus points |
| AF-area mode | Single-point AF, dynamic-area AF, auto-area AF |
| Focus lock | Focus can be locked by pressing shutter-release button halfway (single-servo AF) or by pressing AE-L/AF-L button |

| Flash | |
|------------------------------|--|
| Flash control | <ul style="list-style-type: none"> • TTL: i-TTL balanced fill-flash and standard i-TTL flash for digital SLR using 1,005-pixel RGB sensor are available with SB-900, SB-800, SB-600, or SB-400 • Auto aperture: Available with SB-900 or SB-800 and CPU lens • Non-TTL auto: Supported flash units include SB-900, SB-800, SB-28, SB-27, and SB-22S • Distance-priority manual: Available with SB-900 and SB-800 |
| Flash mode | Front curtain sync, slow sync, rear-curtain sync, red-eye reduction, red-eye reduction with slow sync |
| Flash-ready indicator | Lights when optional flash unit such as SB-900, SB-800, SB-600, SB-400, SB-80DX, SB-28DX, or SB-50DX is fully charged; blinks after flash is fired at full output |
| Accessory shoe | ISO 518 hot-shoe with sync and data contacts and safety lock |



| Flash | |
|---|--|
| Nikon Creative Lighting System (CLS) | Advanced Wireless Lighting supported with SB-900, SB-800, or SU-800 as commander and SB-900, SB-800, SB-600, or SB-R200 as remotes; Auto FP High-Speed Sync and modeling illumination supported with all CLS-compatible flash units except SB-400; Flash Color Information Communication and FV lock supported with all CLS-compatible flash units |
| Sync terminal | ISO 519 sync terminal with locking thread |
| White balance | |
| White balance | Auto, incandescent, fluorescent (7 types), direct sunlight, flash, cloudy, shade, preset manual (up to 5 values can be stored), choose color temperature (2500 K–10000 K), all with fine tuning. |
| Live view | |
| Modes | Tripod, hand-held |
| Autofocus | <ul style="list-style-type: none"> • Tripod: Contrast-detect AF anywhere in frame • Hand-held: Phase-detection TTL AF with 51 focus points (including 15 cross-type sensors) |
| Flicker reduction | 50 Hz and 60 Hz |
| Movie | |
| Frame size (pixels) | <ul style="list-style-type: none"> • 1,280 × 720/24 fps • 640 × 424/24 fps • 320 × 216/24 fps |
| File format | AVI |
| Compression | Motion-JPEG |
| Audio | Microphone sensitivity can be adjusted |
| ISO sensitivity | ISO 200–12800 (ISO 6400–Hi 3 in high-sensitivity movie mode) |



| Monitor | |
|--------------------------------|---|
| Monitor | 3-in., 921k-dot (VGA), low-temperature polysilicon TFT LCD with 170 ° viewing angle, 100% frame coverage, and brightness adjustment |
| Playback | |
| Playback | Full-frame and thumbnail (4, 9, or 72 images) playback with playback zoom, movie playback, slide show, highlights, histogram display, auto image rotation, image comment (up to 36 characters), and voice memo input and playback |
| Interface | |
| USB | Hi-Speed USB |
| Video output | Can be selected from NTSC and PAL; images can be displayed on external device while camera monitor is on |
| HDMI output | Type C mini-pin HDMI connector; camera monitor turns off when HDMI cable is connected |
| Audio input | Stereo mini-pin jack (3.5 mm diameter) |
| Ten-pin remote terminal | Can be used to connect optional remote control, GP-1 GPS unit, or GPS device compliant with NMEA0183 version 2.01 or 3.01 (requires optional MC-35 GPS adapter cord and cable with D-sub 9-pin connector) |
| Supported languages | |
| Supported languages | Chinese (Simplified and Traditional), Czech, Danish, Dutch, English, Finnish, French, German, Indonesian, Italian, Japanese, Korean, Norwegian, Polish, Portuguese, Russian, Spanish, Swedish, Turkish |
| Power source | |
| Battery | One rechargeable Li-ion EN-EL4a battery |
| AC adapter | EH-6 AC adapter (available separately) |
| Tripod socket | |
| Tripod socket | 1/4 in. (ISO 1222) |



| Dimensions/weight | |
|-------------------------------|--|
| Dimensions (W × H × D) | Approx. 159.5 × 157 × 87.5 mm (6.3 × 6.2 × 3.4 in.) |
| Weight | Approx. 1,240 g (2 lb. 12 oz.) without battery, memory card, body cap, or accessory shoe cover |

| Operating environment | |
|------------------------------|---------------------------------|
| Temperature | 0–40 °C (+32–104 °F) |
| Humidity | Less than 85% (no condensation) |

- Unless otherwise stated, all figures are for a camera with a fully-charged battery operating at an ambient temperature of 20 °C (68 °F).
- Nikon reserves the right to change the specifications of the hardware and software described in this manual at any time and without prior notice. Nikon will not be held liable for damages that may result from any mistakes that this manual may contain.

| MH-22 quick charger | |
|----------------------------------|---|
| Rated input | AC 100–240 V (50/60 Hz) |
| Rated output | DC 12.6 V/1,200 mA |
| Supported batteries | Nikon EN-EL4a/EN-EL4 rechargeable Li-ion batteries |
| Charging time per battery | Approx. 2 hours and 25 minutes (EN-EL4a) or 1 hour and 40 minutes (EN-EL4) when battery is fully discharged |
| Operating temperature | 0–40 °C (+32–104 °F) |
| Dimensions (W × H × D) | Approx. 160 × 85 × 50.5 mm (6.3 × 3.3 × 2.0 in.) |
| Length of cord | Approx. 1800 mm (5 ft. 11 in.) |
| Weight | Approx. 260 g (9.1 oz.), excluding power cable |

| EN-EL4a rechargeable Li-ion battery | |
|--|---|
| Type | Rechargeable lithium-ion battery |
| Rated capacity | 11.1 V/2,500 mAh |
| Dimensions (W × H × D) | Approx. 56.5 × 27 × 82.5 mm (2.2 × 1.1 × 3.2 in.) |
| Weight | Approx. 180 g (6.3 oz.), excluding terminal cover |



Supported Standards

- **DCF Version 2.0:** The Design Rule for Camera File System (DCF) is a standard widely used in the digital camera industry to ensure compatibility among different makes of camera.
- **DPOF:** Digital Print Order Format (DPOF) is an industry-wide standard that allows pictures to be printed from print orders stored on the memory card.
- **Exif version 2.21:** The camera supports Exif (**Exchangeable Image File Format for Digital Still Cameras**) version 2.21, a standard in which information stored with photographs is used for optimal color reproduction when the images are output on Exif-compliant printers.
- **PictBridge:** A standard developed through cooperation with the digital camera and printer industries, allowing photographs to be output directly to a printer without first transferring them to a computer.
- **HDMI:** **H**igh-**D**efinition **M**ultimedia **I**nterface is a standard for multimedia interfaces used in consumer electronics and AV devices capable of transmitting audiovisual data and control signals to HDMI-compliant devices via a single cable connection.



Calibrating Batteries

The MH-22 quick charger is equipped with a battery calibration feature. Calibrate the battery as required to ensure the accuracy of the camera and charger battery level displays.

If the calibration lamp for the current battery chamber blinks when a battery is inserted, the battery needs to be calibrated. To begin calibration, press the calibration button for the current chamber for about a second. The time needed to calibrate the battery is shown by the charge and calibration lamps:

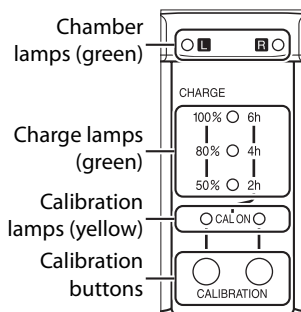

| Approximate time needed to recalibrate battery | Calibration lamp | Charge lamps | | |
|--|------------------|--------------|-----------|-----------|
| | | 2 h | 4 h | 6 h |
| Over 6 hours | ○ (glows) | ○ (glows) | ○ (glows) | ○ (glows) |
| 4 – 6 hours | ○ (glows) | ○ (glows) | ○ (glows) | ● (off) |
| 2 – 4 hours | ○ (glows) | ○ (glows) | ● (off) | ● (off) |
| Under 2 hours | ○ (glows) | ● (off) | ● (off) | ● (off) |

When calibration is complete, the calibration and charge lamps will turn off and charging will begin immediately.

Although calibration is recommended for accurate measurement of battery charge state, calibration need not be performed when the calibration lamp blinks. Once begun, calibration can be interrupted as desired.

- If the calibration button is not pressed while the calibration lamp is blinking, normal charging will begin after about ten seconds.
- To interrupt calibration, press the calibration button again. Calibration will end and charging will begin.



 **Battery Warning**

If the chamber and calibration lamps flash on and off in sequence when no battery is inserted, there is a problem with the charger. If the chamber and calibration lamps flash on and off in sequence when a battery is inserted, a problem has occurred with the battery or charger during charging. Remove the battery, unplug the charger, and take the battery and charger to a Nikon-authorized service representative for inspection.

 **Charging and Calibrating Two Batteries**

The MH-22 charges only one battery at a time. If batteries are inserted in both chambers, they will be charged in the order inserted. If the calibration button for the first battery is pressed, the second battery can not be calibrated or charged until calibration and charging of the first battery are complete.



Approved Memory Cards

The following Type I CompactFlash memory cards have been tested and approved for use in the D3S. Type II cards and microdrives can not be used.

| | | | |
|----------------|-------------------|--------|-------------------------------|
| SanDisk | Extreme Pro | SDCFXP | 16 GB, 32 GB, 64 GB |
| | Extreme | SDCFX | 8 GB, 16 GB, 32 GB |
| | Extreme IV | SDCFX4 | 2 GB, 4 GB, 8 GB, 16 GB |
| | Extreme III | SDCFX3 | 1 GB, 2 GB, 4 GB, 8 GB, 16 GB |
| | Ultra II | SDCFH | 1 GB, 2 GB, 4 GB, 8 GB |
| | Standard | SDCFB | 1 GB, 2 GB, 4 GB |
| Lexar Media | Professional UDMA | 300 × | 2 GB, 4 GB, 8 GB, 16 GB |
| | Professional | 233 × | 2 GB, 4 GB, 8 GB |
| | | 133 × | 1 GB, 2 GB, 4 GB |
| | Platinum II | 80 × | 1 GB, 2 GB, 4 GB, 8 GB, 16 GB |
| | | 60 × | 4 GB |

Other cards have not been tested. For more details on the above cards, please contact the manufacturer.



Memory Card Capacity

The following table shows the approximate number of pictures that can be stored on a 4 GB SanDisk Extreme IV (SDCFX4) card at different image quality, image size, and image area settings.

■ FX (36×24) Image Area*

| Image quality | Image size | File size ¹ | No. of images ¹ | Buffer capacity ² |
|--|------------|------------------------|----------------------------|------------------------------|
| NEF (RAW), Lossless compressed, 12-bit | — | 11.3 MB | 202 | 42 |
| NEF (RAW), Lossless compressed, 14-bit | — | 14.3 MB | 155 | 36 |
| NEF (RAW), Compressed, 12-bit | — | 10.1 MB | 277 | 43 |
| NEF (RAW), Compressed, 14-bit | — | 12.6 MB | 229 | 36 |
| NEF (RAW), Uncompressed, 12-bit | — | 19.1 MB | 202 | 38 |
| NEF (RAW), Uncompressed, 14-bit | — | 24.9 MB | 155 | 35 |
| TIFF (RGB) | L | 36.1 MB | 107 | 36 |
| | M | 20.3 MB | 191 | 42 |
| | S | 9.1 MB | 423 | 59 |
| JPEG fine ³ | L | 5.9 MB | 559 | 82 |
| | M | 3.3 MB | 995 | 130 |
| | S | 1.5 MB | 2.1 K | 130 |
| JPEG normal ³ | L | 2.9 MB | 1.0 K | 122 |
| | M | 1.7 MB | 1.9 K | 130 |
| | S | 0.8 MB | 4.1 K | 130 |
| JPEG basic ³ | L | 1.5 MB | 2.1 K | 124 |
| | M | 0.9 MB | 3.6 K | 130 |
| | S | 0.4 MB | 7.8 K | 130 |

* Includes images taken with non-DX lenses when **On** is selected for **Auto DX crop**.



■ ■ DX (24×16) Image Area *

| Image quality | Image size | File size ¹ | No. of images ¹ | Buffer capacity ² |
|--|------------|------------------------|----------------------------|------------------------------|
| NEF (RAW), Lossless compressed, 12-bit | — | 5.2 MB | 460 | 62 |
| NEF (RAW), Lossless compressed, 14-bit | — | 6.4 MB | 356 | 54 |
| NEF (RAW), Compressed, 12-bit | — | 4.5 MB | 626 | 78 |
| NEF (RAW), Compressed, 14-bit | — | 5.6 MB | 522 | 59 |
| NEF (RAW), Uncompressed, 12-bit | — | 8.3 MB | 460 | 58 |
| NEF (RAW), Uncompressed, 14-bit | — | 10.8 MB | 356 | 52 |
| TIFF (RGB) | L | 15.5 MB | 249 | 46 |
| | M | 8.7 MB | 441 | 57 |
| | S | 4.0 MB | 964 | 95 |
| JPEG fine ³ | L | 2.5 MB | 1.2 K | 130 |
| | M | 1.4 MB | 2.2 K | 130 |
| | S | 0.7 MB | 4.8 K | 130 |
| JPEG normal ³ | L | 1.3 MB | 2.5 K | 130 |
| | M | 0.7 MB | 4.1 K | 130 |
| | S | 0.4 MB | 8.9 K | 130 |
| JPEG basic ³ | L | 0.7 MB | 4.8 K | 130 |
| | M | 0.4 MB | 7.8 K | 130 |
| | S | 0.2 MB | 15.6 K | 130 |

* Includes images taken with DX lenses when **On** is selected for **Auto DX crop**.



- 1 All figures are approximate. File size varies with scene recorded.
- 2 Maximum number of exposures that can be stored in memory buffer at ISO 200. Drops if **Optimal quality** is selected for **JPEG compression**, ISO sensitivity is set to Hi 0.3 or higher, **High ISO NR** is on when auto ISO sensitivity control is on or ISO sensitivity is over ISO 3200, or long exposure noise reduction, Active D-Lighting, or image authentication is on.
- 3 Figures assume **JPEG compression** is set to **Size priority**. Selecting **Optimal quality** increases the file size of JPEG images; number of images and buffer capacity drop accordingly.

 **d3—Max. Continuous Release (📖 307)**

The maximum number of photographs that can be taken in a single burst can be set to any amount between 1 and 130.

Battery Life

The number of shots that can be taken with a fully-charged EN-EL4a battery (2,500 mAh) varies with the condition of the battery, temperature, and how the camera is used. Sample figures are given below.

- **CIPA standard:** Approximately 4,200 shots. Measured at 23 °C/ 73.4 °F (± 2 °C/3.6 °F) with an AF-S NIKKOR 24–70mm f/2.8G ED lens under the following test conditions: lens cycled from infinity to minimum range and one photograph taken at default settings once every 30 s. Live view not used.
- **Nikon standard:** Approximately 4,700 shots. Measured at 20 °C/ 68 °F with an AF-S VR 70–200mm f/2.8G ED lens under the following test conditions: vibration reduction off, image quality set to JPEG normal, image size set to L (large), shutter speed 1/250 s, shutter-release button pressed halfway for three seconds and focus cycled from infinity to minimum range three times; six shots are then taken in succession and monitor turned on for five seconds and then turned off; cycle repeated once exposure meters have turned off.



The following can reduce battery life:

- Using the monitor
- Keeping the shutter-release button pressed halfway
- Repeated autofocus operations
- Taking NEF (RAW) or TIFF (RGB) photographs
- Slow shutter speeds
- Using the optional WT-4 wireless transmitter
- Using the optional GP-1 GPS unit
- Using VR (vibration reduction) mode with VR lenses

To ensure that you get the most from rechargeable Nikon EN-EL4a batteries:

- Keep the battery contacts clean. Soiled contacts can reduce battery performance.
- Use batteries immediately after charging. Batteries will lose their charge if left unused.
- Check the condition of the battery regularly using the **Battery info** option in the setup menu (📖 333). If 🔋CAL is displayed for **Calibration**, calibrate the battery using the MH-22 quick charger (if the battery has not been used for more than six months, recharge the battery when calibration is complete).



Index

Symbols

| | |
|---|------------------|
| [] (Single-point AF) | 92, 93 |
| [] (Dynamic-area AF) | 92, 93, 296 |
| [] (Auto-area AF) | 92, 93 |
| S | 90, 96, 102, 296 |
| C | 90, 97, 295, 296 |
| M | 60, 90, 99 |
| CL | 102, 104, 307 |
| CH | 102, 104, 307 |
| Q | 102 |
| (Self-timer) | 102, 106 |
| MUP | 102, 108 |
| [] (Matrix) | 116 |
| [] (Center-weighted) | 116, 304 |
| [] (Spot) | 116 |
| P (Programmed auto) | 120 |
| S (Shutter-priority auto) | 122 |
| A (Aperture-priority auto) | 123 |
| M (Manual) | 125 |
| ? (Help) | 22, 25 |
| (Memory buffer) | 49, 105 |
| PRE (Preset manual) | 150, 158 |
| [] (Info) button | 14, 17 |
| [] (Live view) button | 54, 66 |
| switch | 10, 310 |

Numerics

| | |
|-----------------------------------|-------------|
| 1,005-pixel RGB sensor | 192 |
| 1.2× (30 × 20) | 79 |
| 12-bit | 85 |
| 14-bit | 85 |
| 3D color matrix metering II | 116, 117 |
| 3D-tracking | 92, 93, 297 |
| 5 : 4 (30 × 24) | 79 |
| 51 points (3D-tracking) | 297 |

A

| | |
|-------------------------|----------|
| A/V cable | i, 269 |
| AC adapter | 372 |
| Accessories | 372 |
| Active D-Lighting | 145, 181 |

| | |
|---|-------------------------|
| Active folder | 288 |
| Add items (My Menu) | 359 |
| ADL bracketing | 145, 312 |
| Adobe RGB | 183 |
| AE & flash (Auto bracketing set) | 136, 312 |
| AE only (Auto bracketing set) | 136, 312 |
| AE-L | 97, 132, 321 |
| AF | 90, 92, 94, 98, 295–301 |
| AF activation | 298 |
| AF area brackets | 12, 41, 62 |
| AF assist | 191 |
| AF fine tune | 339 |
| AF point selection | 300 |
| AF-area mode | 92 |
| AF-C priority selection | 295 |
| AF-ON button | 91, 300 |
| AF-ON button for vertical shooting ... | 91, 301 |
| AF-S priority selection | 296 |
| After delete | 281 |
| Amber | 154, 348 |
| Aperture | 123–126, 131 |
| Aperture Lock | 131 |
| Aperture-priority auto | 123 |
| Approved memory cards | 419 |
| Aspect ratio | 347 |
| Assign AE-L/AF-L button | 321 |
| Assign BKT button | 322 |
| Assign Fn button | 316 |
| Assign preview button | 321 |
| Attaching the lens | 31 |
| Audio | 252, 282, 283 |
| Audio output | 252 |
| Audio/video cable | i, 269 |
| Auto (White balance) | 150 |
| Auto bracketing | 136, 312, 313 |
| Auto bracketing (Mode M) | 313 |
| Auto bracketing set | 312 |
| Auto DX crop | 78, 81 |
| Auto FP high-speed sync | 311 |

Auto image rotation 332
Auto meter off 45, 305
Auto meter-off delay 305
Auto-area AF 92, 93
Autofocus 90, 92, 94, 98, 295–301

B

Backlight 10, 310
Backup (Slot 2) 88
Battery 26, 28–30, 43, 333
Battery info 333
Beep 306
BKT button 137, 141, 145, 204, 322
Black-and-white (Monochrome) 347
Body cap 4, 31, 375
Border 261, 265
Bracketing 136, 312, 313
Bracketing order 313
Bulb 126, 128
Burst 307, 317

C

Calibrating 417–418
Camera Control Pro 2 257, 375
Capture NX 2 84, 327, 375
Center-weighted 116, 304
Center-weighted area 304
Center-weighted metering 116, 304
Charging the battery 26–27
Choose color temp. (White balance)
150, 157
Choose image area 79, 81
Clean image sensor 378
Clock 34, 330
Clock battery 35, 386
Cloudy (White balance) 150
CLS 187
Color balance 348
Color space 183
Color temperature 150, 152, 157
CompactFlash 36, 419
Compatible lenses 366
Compressed (Type) 85
Computer 254

Connector for external microphone. 4,
71
Continuous high speed .. 102, 104, 307
Continuous low speed 102, 104, 307
Continuous release mode 102, 104
Continuous-servo AF.. 90, 97, 295, 296
Contrast-detect autofocus ... 54, 56, 58
Control panel 8–11
Copy image(s) 278
Copyright 232, 335
Copyright information 335
CPU contacts 368
CPU lens 32, 366
Creative Lighting System 186, 187
Cropping (PictBridge [Setup] menu)
262
Custom setting bank 294
Custom Settings 292
Customize command dials 322
Cyanotype (Monochrome) 347

D

Date and time 34, 330
Date format 35, 330
Daylight saving time 34, 330
DCF version 2.0 184, 416
Default settings 200, 287, 294, 392
Delete 52, 240
Delete all images 242
Delete current image 52, 240
Depth-of-field 119
Depth-of-field preview button 119,
312, 321
Digital Print Order Format (DPOF) 258,
263, 267, 416
Diopter 373
Direct sunlight (White balance) 150
Display mode 277
D-Lighting 344
DPOF 258, 263, 267, 416
Dust off ref photo 327
DX (24 × 16) 79
Dynamic AF area 296
Dynamic-area AF 92, 93, 296

E

| | |
|-----------------------------------|-------------------------|
| Easy exposure compensation..... | 303 |
| Electronic rangefinder..... | 100 |
| Ethernet..... | 257, 372 |
| EV steps for exposure cntrl. | 302 |
| Exif version 2.21 | 184, 416 |
| Exposure..... | 115, 116, 118, 132, 134 |
| Exposure bracketing | 136, 312, 313 |
| Exposure compensation..... | 134 |
| Exposure delay mode | 310 |
| Exposure indicator..... | 127 |
| Exposure lock | 132 |
| Exposure meters..... | 45, 116, 305 |
| Exposure mode..... | 118 |
| Exposure program | 397 |
| Extended menu banks | 287 |
| External microphone | 71 |

F

| | |
|---|--------------------|
| File information | 226 |
| File naming..... | 290 |
| File number sequence..... | 308 |
| Filter effects..... | 348 |
| Filter effects (Set Picture Control). 173, 174 | |
| Fine tune optimal exposure | 304 |
| Firmware version..... | 340 |
| Flash | 186, 187, 193, 196 |
| Flash (White balance) | 150 |
| Flash bracketing | 136, 312, 313 |
| Flash control..... | 192 |
| Flash mode | 193 |
| Flash only (Auto bracketing set)... 136, 312 | |
| Flash range | 195 |
| Flash ready indicator 13, 190, 197, 412 | |
| Flash shutter speed | 312 |
| Flash sync speed..... | 311 |
| Flash sync terminal..... | 186 |
| Flexible program | 121 |
| Flicker reduction..... | 54, 68, 330 |
| Fluorescent (White balance) | 150 |
| Fn button | 82, 197, 316 |
| f-number | 123, 124, 368 |

| | |
|----------------------------------|------------------------|
| Focal length | 214, 370–371 |
| Focal plane mark..... | 100 |
| Focus | 89, 90, 92, 94, 96, 99 |
| Focus indicator | 49, 100 |
| Focus lock | 96 |
| Focus mode | 90 |
| Focus mode switch | 32 |
| Focus point | 56, 92, 94, 296, 300 |
| Focus point wrap-around | 299 |
| Focus tracking..... | 91, 297, 298 |
| Focus tracking with lock-on..... | 298 |
| Focusing screen..... | 373, 384, 409 |
| Format | 39, 326 |
| Format memory card..... | 326 |
| Frame interval (Slide show)..... | 282 |
| Front-curtain sync | 193 |
| Full-frame playback..... | 222 |
| FV lock..... | 196 |
| FX (36 × 24) | 79 |

G

| | |
|---------------|----------|
| GPS..... | 217, 233 |
| GPS data..... | 233 |
| GPS unit..... | 217 |

H

| | |
|-----------------------------------|---------------|
| Hand-held..... | 59 |
| HDMI | 271, 329, 416 |
| HDMI mini-pin connector..... | 4 |
| Help | 22, 25 |
| Hi..... | 111 |
| Hide image..... | 275 |
| High definition..... | 271, 329, 416 |
| High ISO NR | 291 |
| Highlights..... | 227 |
| High-sensitivity movie mode | 72 |
| Histogram..... | 228, 229 |

I

| | |
|-------------------------------|----------------|
| Image area..... | 32, 78, 81, 86 |
| Image authentication..... | 334 |
| Image comment..... | 331 |
| Image Dust Off ref photo..... | 327 |
| Image file | 416 |
| Image overlay..... | 349 |

| | |
|---|---------------|
| Image quality | 83 |
| Image review | 224, 281 |
| Image size | 86 |
| Incandescent (White balance) | 150 |
| Index print | 266 |
| In-focus indicator | 49, 90 |
| Information | 225, 277 |
| Information display | 14, 309 |
| Interval timer shooting | 208 |
| ISO sensitivity | 109, 110, 112 |
| ISO sensitivity auto control | 112 |
| ISO sensitivity step value | 302 |
| i-TTL | 192 |
| i-TTL balanced-fill flash for digital SLR.. | 192 |

J

| | |
|------------------|--------|
| JPEG | 83, 88 |
| JPEG basic | 83 |
| JPEG compression | 85 |
| JPEG fine | 83 |
| JPEG normal | 83 |

L

| | |
|-----------------------------|----------------------|
| L (large) | 86 |
| LAN | 372 |
| Language | 33, 331 |
| LCD | 10, 310, 326 |
| LCD brightness | 326 |
| LCD illumination | 310 |
| Lens | 31–32, 214, 339, 366 |
| Lens cap | 31 |
| Lens distance information | 192 |
| Lens focus ring | 31, 99 |
| Lens mount | 5, 32 |
| Lens mounting index | 31 |
| Live view | 53–63, 66–69 |
| Live view mode | 55, 59 |
| Lo | 111 |
| Lock mirror up for cleaning | 381 |
| Long exp. NR | 291 |
| Lossless compressed (Type) | 85 |

M

| | |
|------------|----|
| M (medium) | 86 |
|------------|----|

| | |
|----------------------------------|----------------------|
| Magenta | 154, 348 |
| Manage Picture Control | 176 |
| Manual (Exposure mode) | 125 |
| Manual (Focus mode) | 60, 90, 99 |
| Manual focus | 60, 90, 99 |
| Matrix | 116 |
| Matrix metering | 117 |
| Max. continuous release | 307 |
| Maximum aperture | 100, 214 |
| Maximum sensitivity | 113 |
| Memory buffer | 49, 102, 105 |
| Memory card | 36, 39, 326, 419 |
| Memory card capacity | 420 |
| Memory card slot | 37 |
| Metering | 116 |
| Metering selector | 48, 117 |
| Microphone | 4, 5, 6, 71 |
| Minimum aperture | 32, 118 |
| Minimum shutter speed | 113 |
| Mired | 155 |
| Mirror | 55, 108, 381 |
| Mirror up | 108 |
| Mirror up mode | 102, 108 |
| Modeling flash | 119, 312 |
| Monitor | 14, 51, 54, 222, 326 |
| Monitor off delay | 306 |
| Monochrome | 347 |
| Monochrome (Set Picture Control) | 170 |
| Mounting index | 5, 31 |
| Movie settings | 70 |
| Movies | 66 |
| Multi selector | 23, 315 |
| Multiple exposure | 202 |
| My Menu | 359 |

N

| | |
|-------------------------------|------------|
| NEF | 83, 84, 85 |
| NEF (RAW) | 83, 84, 85 |
| NEF (RAW) bit depth | 85 |
| NEF (RAW) processing | 353 |
| NEF (RAW) recording | 85 |
| Neutral (Set Picture Control) | 170 |
| Nikon Transfer | 254 |
| No memory card? | 324 |

| | |
|--|----------|
| No. of copies (PictBridge [Setup] menu) 261 | |
| Non-CPU lens | 214 |
| Non-CPU lens data..... | 214, 215 |

O

| | |
|------------------------------------|-----|
| Optimal quality (JPEG compression) | 85 |
| Overflow (Slot 2)..... | 88 |
| Overview data | 234 |

P

| | |
|-------------------------------------|-------------|
| Page size..... | 261, 265 |
| Phase-detection autofocus | 54 |
| Photo info | 225, 277 |
| Photo info/playback..... | 315 |
| PictBridge..... | 258, 416 |
| Picture angle..... | 78, 370–371 |
| Picture Controls | 170 |
| Playback | 51, 221 |
| Playback folder..... | 275 |
| Playback information..... | 225, 277 |
| Playback menu..... | 274 |
| Playback zoom | 237 |
| Predictive focus tracking | 90, 91 |
| Preset manual (White balance) | 150, 158 |

Press the shutter-release button all the way down

50

Press the shutter-release button

halfway

49, 50, 96, 132

Print (DPOF).....

263

Print options (PictBridge [Setup] menu)

261

Print select.....

263

Print set (DPOF).....

267

Printing

258

Programmed auto.....

120

Protecting photographs

238

Pv button

67, 119, 312, 321

Q

| | |
|-------------------------------|----|
| Quality (Movie settings)..... | 70 |
|-------------------------------|----|

R

| | |
|---------------------------|-----|
| Rank items (My Menu)..... | 362 |
|---------------------------|-----|

| | |
|---|--------------------|
| RAW Slot 1 - JPEG Slot 2 (Slot 2) | 88 |
| Rear control panel | 10–11 |
| Rear-curtain sync | 193 |
| Recent settings | 363 |
| Rechargeable Li-ion battery | i, 26 |
| Red-eye correction | 345 |
| Red-eye reduction..... | 193 |
| Release button to use dial | 324 |
| Release mode..... | 101 |
| Release mode dial | 103 |
| Release mode dial lock release | 103 |
| Remote cord | 58, 128, 376 |
| Remove items (My Menu)..... | 361 |
| Removing the lens from the camera | 32 |
| Reset..... | 200, 287, 294 |
| Reset custom settings | 294 |
| Reset shooting menu | 287 |
| Resize | 355 |
| Restoring default settings | 200, 287, 294, 392 |
| Retouch menu | 341 |
| Reverse indicators | 324 |
| RGB..... | 83, 183, 228 |
| RGB Histogram | 228 |
| Rotate tall | 282 |

S

| | |
|-----------------------------|-------------------|
| S (small)..... | 86 |
| Save/load settings | 336 |
| Saving camera settings..... | 336 |
| Screen tips..... | 310 |
| Self-timer | 102, 106, 305 |
| Sensitivity | 109, 110, 112 |
| Sepia (Monochrome)..... | 347 |
| Set Picture Control | 170 |
| Setup menu | 325 |
| Shade (White balance)..... | 150 |
| Shooting data | 230, 231, 232 |
| Shooting menu..... | 284 |
| Shooting menu bank..... | 285 |
| Shutter speed..... | 122, 125–126, 130 |
| Shutter speed lock | 130 |
| Shutter-priority auto..... | 122 |

Shutter-release button 49, 50, 96, 132, 305
Shutter-release button AE-L..... 305
Side-by-side comparison..... 357
Single-frame..... 102
Single-point AF 92, 93
Single-servo AF 90, 96, 296
Size 70, 86
Size priority (JPEG compression) 85
Skylight 348
Slide show 282
Slot..... 36
Slot 1 37, 39
Slot 2 37, 88
Slot selection 224
Slow sync..... 193
Speaker 73, 251
Speedlights..... 186
Spot 116
Spot metering 116
sRGB 183
Standard (Set Picture Control)..... 170
Standard i-TTL flash for digital SLR 192
Start printing..... 262, 265

T

Television..... 269, 329
Ten-pin remote terminal..... 217, 376
Thumbnail..... 235
Thumbnail playback..... 235
TIFF (RGB) 83
Time 34, 330
Time stamp..... 261, 265
Time zone..... 34, 330
Time zone and date..... 34, 330
Timer 106, 208
Toning (Set Picture Control) ... 173, 175
Top control panel 8–9
Trim 346
Tripod 55
Two-button reset..... 200
Type D lens 368
Type G lens 368

U

Uncompressed (Type) 85
USB 255, 259
USB cable i, 255, 259
Use GPS to set camera clock 220
UTC 34, 219, 233

V

Vertical shutter-release button lock 320
Video mode..... 329
Viewfinder 12, 41, 409
Viewfinder eyepiece 106, 210
Viewfinder focus..... 41, 42, 373
ViewNX 84, 184
Vignette Control 290
Virtual horizon 62, 318, 338
Vivid (Set Picture Control)..... 170
Voice memo 223, 245–252
Voice memo button 247
Voice memo overwrite..... 247

W

Warm filter 348
WB 141, 150
WB bracketing (Auto bracketing set)....
141, 312
White balance 141, 150
White balance bracketing..... 141
Wireless..... 257, 372
Wireless network..... 257, 372
Wireless transmitter 257, 372
WT-4..... 257, 372



A series of 18 horizontal lines spaced evenly down the page, intended for handwriting practice.

Nikon

No reproduction in any form of this manual, in whole or in part (except for brief quotation in critical articles or reviews), may be made without written authorization from NIKON CORPORATION.



NIKON CORPORATION

Printed in Europe

© 2009 Nikon Corporation

SB0C02(11)
6MB07511-02