

***Nikon***

DIGITAL CAMERA

**D3300**

---

Reference Manual

En

To get the most from your camera, please be sure to read all instructions thoroughly and keep them where they will be read by all who use the product.

### Symbols and Conventions

To make it easier to find the information you need, the following symbols and conventions are used:



This icon marks cautions; information that should be read before use to prevent damage to the camera.



This icon marks notes; information that should be read before using the camera.



This icon marks references to other pages in this manual.

Menu items, options, and messages displayed in the camera monitor are shown in **bold**.

### Camera Settings

The explanations in this manual assume that default settings are used.

### Help

Use the camera's on-board help feature for help on menu items and other topics. See page 11 for details.

#### For Your Safety

Before using the camera for the first time, read the safety instructions in "For Your Safety" (📖 x-xiii).







# Table of Contents

For Your Safety .....	x
Notices.....	xiv
<b>Introduction</b> .....	<b>1</b>
<hr/>	
<b>Getting to Know the Camera</b> .....	<b>1</b>
The Camera Body.....	1
The Mode Dial.....	4
The Viewfinder.....	6
The Information Display.....	7
<b>Camera Menus: An Overview</b> .....	<b>10</b>
<b>First Steps</b> .....	<b>14</b>
<b>“Point-and-Shoot” Modes</b> (AUTO and  ) .....	<b>25</b>
<hr/>	
<b>Framing Photos in the Viewfinder</b> .....	<b>26</b>
Viewing Photographs .....	29
Deleting Unwanted Pictures .....	30
<b>Framing Photos in the Monitor</b> .....	<b>32</b>
Viewing Photographs .....	35
Deleting Unwanted Pictures .....	36
<b>Recording Movies</b> .....	<b>37</b>
Viewing Movies .....	39
Deleting Unwanted Movies .....	40
<b>Guide Mode</b> .....	<b>41</b>
<hr/>	
<b>The Guide</b> .....	<b>41</b>
Guide Mode Menus.....	42
Using the Guide.....	45

## Matching Settings to the Subject or Situation (Scene Mode)

47













---

 Portrait.....	47
 Landscape .....	47
 Child .....	48
 Sports .....	48
 Close up .....	48
 Night Portrait .....	49

## Special Effects

50

---

 Night Vision .....	51
<b>VI</b> Super Vivid .....	51
<b>POP</b> Pop.....	51
 Photo Illustration .....	52
 Color Sketch .....	52
 Toy Camera Effect.....	52
 Miniature Effect.....	53
 Selective Color .....	53
 Silhouette .....	54
 High Key.....	54
 Low Key .....	54
 HDR Painting .....	55
 Easy Panorama.....	55
Options Available in Live View .....	56
 Easy Panorama .....	63



---

<b>Choosing a Release Mode</b> .....	<b>67</b>
<b>Continuous Shooting (Burst Mode)</b> .....	<b>68</b>
<b>Quiet Shutter Release</b> .....	<b>70</b>
<b>Self-Timer Mode</b> .....	<b>71</b>
<b>Focus (Viewfinder Photography)</b> .....	<b>74</b>
Choosing How the Camera Focuses: Focus Mode.....	74
Choosing How the Focus Point Is Selected:	
AF-Area Mode.....	78
Focus Point Selection .....	80
Focus Lock.....	81
Manual Focus .....	83
<b>Image Quality and Size</b> .....	<b>85</b>
Image Quality .....	85
Image Size .....	87
<b>Using the Built-in Flash</b> .....	<b>89</b>
Auto Pop-up Modes.....	89
Manual Pop-up Modes .....	91
<b>ISO Sensitivity</b> .....	<b>95</b>
<b>Remote Control Photography</b> .....	<b>97</b>
Using an Optional ML-L3 Remote Control .....	97

---



<b>Shutter Speed and Aperture .....</b>	<b>100</b>
Mode <b>P</b> (Programmed Auto).....	102
Mode <b>S</b> (Shutter-Priority Auto).....	104
Mode <b>A</b> (Aperture-Priority Auto).....	106
Mode <b>M</b> (Manual).....	108
Long Time-Exposures (M Mode Only) .....	110
<b>Exposure.....</b>	<b>114</b>
Metering.....	114
Autoexposure Lock.....	116
Exposure Compensation .....	118
Flash Compensation .....	120
<b>Preserving Detail in Highlights and Shadows.....</b>	<b>122</b>
Active D-Lighting .....	122
<b>White Balance.....</b>	<b>124</b>
Fine-Tuning White Balance .....	127
Preset Manual.....	129
<b>Picture Controls .....</b>	<b>135</b>
Selecting a Picture Control .....	135
Modifying Picture Controls.....	137

**Live View****142**



---

<b>Framing Photographs in the Monitor.....</b>	<b>142</b>
Focusing in Live View .....	144
The Live View Display .....	148

<b>Recording and Viewing Movies</b>	<b>155</b>
<b>Recording Movies</b> .....	<b>155</b>
Movie Settings .....	158
<b>Viewing Movies</b> .....	<b>162</b>
<b>Editing Movies</b> .....	<b>164</b>
Trimming Movies .....	164
Saving Selected Frames .....	168
<b>Playback and Deletion</b>	<b>170</b>
<b>Full-Frame Playback</b> .....	<b>170</b>
Photo Information .....	172
<b>Thumbnail Playback</b> .....	<b>180</b>
<b>Calendar Playback</b> .....	<b>181</b>
<b>Taking a Closer Look: Playback Zoom</b> .....	<b>182</b>
<b>Protecting Photographs from Deletion</b> .....	<b>184</b>
<b>Rating Pictures</b> .....	<b>186</b>
Rating Individual Pictures .....	186
Rating Multiple Pictures .....	187
<b>Selecting Pictures for Upload</b> .....	<b>189</b>
Selecting Individual Pictures for Upload .....	189
Selecting Multiple Pictures for Upload .....	190
<b>Deleting Photographs</b> .....	<b>192</b>
Full-Frame, Thumbnail, and Calendar Playback .....	192
The Playback Menu .....	193
<b>Slide Shows</b> .....	<b>198</b>
Slide Show Options .....	200

<b>Connections</b>	<b>201</b>
Installing ViewNX 2 .....	201
Using ViewNX 2.....	204
Copy Pictures to the Computer .....	204
View Pictures.....	206
<b>Printing Photographs</b> .....	<b>208</b>
Connecting the Printer.....	208
Printing Pictures One at a Time.....	209
Printing Multiple Pictures.....	211
Creating a DPOF Print Order: Print Set.....	213
<b>Viewing Pictures on TV</b> .....	<b>215</b>
Standard Definition Devices .....	215
High-Definition Devices.....	217
<b>Camera Menus</b>	<b>219</b>
 <b>The Playback Menu: <i>Managing Images</i></b> .....	<b>219</b>
Playback Folder .....	220
Playback Display Options .....	220
Image Review .....	221
Rotate Tall.....	221
 <b>The Shooting Menu: <i>Shooting Options</i></b> .....	<b>222</b>
Reset Shooting Menu.....	224
Auto Distortion Control.....	225
Color Space .....	225
Noise Reduction .....	226
ISO Sensitivity Settings.....	226
Built-in AF-assist Illuminator.....	228
Flash Cntrl for Built-in Flash .....	229
Optical VR.....	230

<b>Y The Setup Menu: <i>Camera Setup</i></b> .....	<b>231</b>
Reset Setup Options .....	233
Format Memory Card .....	234
Monitor Brightness .....	235
Info Display Format .....	236
Auto Info Display.....	238
Image Dust Off Ref Photo.....	239
Flicker Reduction.....	241
Time Zone and Date.....	242
Language .....	243
Auto Image Rotation.....	243
Image Comment .....	244
Auto off Timers .....	245
Self-Timer .....	246
Remote on Duration (ML-L3) .....	247
Beep .....	247
Rangefinder.....	248
File Number Sequence.....	249
Buttons.....	251
Slot Empty Release Lock.....	253
Print Date .....	254
Storage Folder.....	257
Accessory Terminal.....	258
Video Mode .....	260
Wireless Mobile Adapter .....	260
Eye-Fi Upload.....	261
Firmware Version .....	262

 <b>The Retouch Menu: <i>Creating Retouched Copies</i></b> .....	<b>263</b>
Creating Retouched Copies.....	264
D-Lighting .....	266
Red-Eye Correction .....	267
Trim.....	268
Monochrome .....	269
Filter Effects .....	270
Color Balance .....	271
Image Overlay.....	272
NEF (RAW) Processing.....	275
Resize .....	277
Quick Retouch.....	279
Straighten.....	279
Distortion Control.....	280
Fisheye.....	280
Color Outline .....	281
Photo Illustration .....	281
Color Sketch.....	282
Perspective Control .....	282
Miniature Effect .....	283
Selective Color .....	284
Side-by-side Comparison.....	286
 <b>Recent Settings</b> .....	<b>288</b>
<b>Technical Notes</b> .....	<b>289</b>
<hr/>	
<b>Compatible Lenses</b> .....	<b>289</b>
Compatible CPU Lenses.....	289
Compatible Non-CPU Lenses.....	292
<b>Optional Flash Units (Speedlights)</b> .....	<b>299</b>
Flash Units Compatible with the Creative Lighting System (CLS).....	299

<b>Other Accessories</b> .....	<b>306</b>
Approved Memory Cards.....	310
Attaching a Power Connector and AC Adapter.....	311
<b>Caring for the Camera</b> .....	<b>313</b>
Storage .....	313
Cleaning .....	313
Image Sensor Cleaning.....	314
<b>Caring for the Camera and Battery: Cautions</b> .....	<b>321</b>
Caring for the Camera.....	321
Caring for the Battery.....	324
<b>Available Settings</b> .....	<b>326</b>
<b>Troubleshooting</b> .....	<b>329</b>
Battery/Display .....	329
Shooting (All Modes).....	330
Shooting ( <b>P, S, A, M</b> ) .....	333
Playback .....	334
Miscellaneous .....	335
<b>Error Messages</b> .....	<b>336</b>
<b>Specifications</b> .....	<b>342</b>
<b>Lens Kits</b> .....	<b>354</b>
AF-P DX NIKKOR 18–55mm f/3.5–5.6G VR and AF-P DX NIKKOR 18–55mm f/3.5–5.6G.....	354
AF-S DX NIKKOR 18–55mm f/3.5–5.6G VR II.....	360
<b>Memory Card Capacity</b> .....	<b>367</b>
<b>Battery Life</b> .....	<b>368</b>
<b>Index</b> .....	<b>370</b>

## For Your Safety

To prevent damage to your Nikon product or injury to yourself or to others, read the following safety precautions in their entirety before using this equipment. Keep these safety instructions where all those who use the product will read them.

The consequences that could result from failure to observe the precautions listed in this section are indicated by the following symbol:



This icon marks warnings. To prevent possible injury, read all warnings before using this Nikon product.

### ■ ■ WARNINGS

#### **Keep the sun out of the frame**

Keep the sun well out of the frame when shooting backlit subjects. Sunlight focused into the camera when the sun is in or close to the frame could cause a fire.

#### **Do not look at the sun through the viewfinder**

Viewing the sun or other strong light source through the viewfinder could cause permanent visual impairment.

#### **Using the viewfinder diopter adjustment control**

When operating the viewfinder diopter adjustment control with your eye to the viewfinder, care should be taken not to put your finger in your eye accidentally.

#### **Turn off immediately in the event of malfunction**

Should you notice smoke or an unusual smell coming from the equipment or AC adapter (available separately), unplug the AC adapter and remove the battery immediately, taking care to avoid burns. Continued operation could result in injury. After removing the battery, take the equipment to a Nikon-authorized service center for inspection.

#### **Do not use in the presence of flammable gas**

Do not use electronic equipment in the presence of flammable gas, as this could result in explosion or fire.

#### **Keep out of reach of children**

Failure to observe this precaution could result in injury. In addition, note that small parts constitute a choking hazard. Should a child swallow any part of this equipment, consult a physician immediately.



**⚠ Do not disassemble**

Touching the product's internal parts could result in injury. In the event of malfunction, the product should be repaired only by a qualified technician. Should the product break open as the result of a fall or other accident, remove the battery and/or AC adapter and then take the product to a Nikon-authorized service center for inspection.

**⚠ Do not place the strap around the neck of an infant or child**

Placing the camera strap around the neck of an infant or child could result in strangulation.

**⚠ Do not remain in contact with the camera, battery, or charger for extended periods while the devices are on or in use**

Parts of the device become hot. Leaving the device in direct contact with the skin for extended periods may result in low-temperature burns.

**⚠ Do not leave the product where it will be exposed to extremely high temperatures, such as in an enclosed automobile or in direct sunlight**

Failure to observe this precaution could cause damage or fire.

**⚠ Do not aim a flash at the operator of a motor vehicle**

Failure to observe this precaution could result in accidents.

**⚠ Observe caution when using the flash**

- Using the camera with the flash in close contact with the skin or other objects could cause burns.
- Using the flash close to the subject's eyes could cause temporary visual impairment. The flash should be no less than one meter (3 ft 4 in.) from the subject. Particular care should be observed when photographing infants.

**⚠ Avoid contact with liquid crystal**

Should the monitor break, care should be taken to avoid injury due to broken glass and to prevent the liquid crystal from the monitor touching the skin or entering the eyes or mouth.

**⚠ Do not carry tripods with a lens or camera attached**

You could trip or accidentally strike others, resulting in injury.

**⚠ Observe proper precautions when handling batteries**

Batteries may leak, overheat, rupture, or catch fire if improperly handled. Observe the following precautions when handling batteries for use in this product:

- Use only batteries approved for use in this equipment.
- Do not short or disassemble the battery.
- Do not expose the battery or the camera in which it is inserted to powerful physical shocks.
- Be sure the product is off before replacing the battery. If you are using an AC adapter, be sure it is unplugged.
- Do not attempt to insert the battery upside down or backwards.
- Do not expose the battery to flame or to excessive heat.
- Do not immerse in or expose to water.
- Replace the terminal cover when transporting the battery. Do not transport or store the battery with metal objects such as necklaces or hairpins.
- Batteries are prone to leakage when fully discharged. To avoid damage to the product, be sure to remove the battery when no charge remains.
- When the battery is not in use, attach the terminal cover and store in a cool, dry place.

- The battery may be hot immediately after use or when the product has been used on battery power for an extended period. Before removing the battery turn the camera off and allow the battery to cool.
- Discontinue use immediately should you notice any changes in the battery, such as discoloration or deformation.

**⚠ Observe proper precautions when handling the charger**

- Keep dry. Failure to observe this precaution could result in injury or product malfunction due to fire or electric shock.
- Do not short the charger terminals. Failure to observe this precaution could result in overheating and damage to the charger.
- Dust on or near the metal parts of the plug should be removed with a dry cloth. Continued use could result in fire.
- Do not go near the charger during thunderstorms. Failure to observe this precaution could result in electric shock.
- Do not handle the plug or charger with wet hands. Failure to observe this precaution could result in injury or product malfunction due to fire or electric shock.
- Do not use with travel converters or adapters designed to convert from one voltage to another or with DC-to-AC inverters. Failure to observe this precaution could damage the product or cause overheating or fire.

**⚠ Use appropriate cables**

When connecting cables to the input and output jacks, use only the cables provided or sold by Nikon for the purpose to maintain compliance with product regulations.

**⚠ CD-ROMs**

CD-ROMs containing software or manuals should not be played back on audio CD equipment. Playing CD-ROMs on an audio CD player could cause hearing loss or damage the equipment.

**⚠ Follow the directions of airline and hospital personnel**

This camera transmits radio frequencies that could interfere with medical equipment or aircraft navigation. Disable the wireless network feature and remove all wireless accessories from the camera before boarding an aircraft, and turn the camera off during take off and landing. In medical facilities, follow staff instructions regarding the use of wireless devices.

## Notices

- No part of the manuals included with this product may be reproduced, transmitted, transcribed, stored in a retrieval system, or translated into any language in any form, by any means, without Nikon's prior written permission.
- Nikon reserves the right to change the appearance and specifications of the hardware and software described in these manuals at any time and without prior notice.
- Nikon will not be held liable for any damages resulting from the use of this product.
- While every effort has been made to ensure that the information in these manuals is accurate and complete, we would appreciate it were you to bring any errors or omissions to the attention of the Nikon representative in your area (address provided separately).

### **Notice for Customers in Canada**

CAN ICES-3 B / NMB-3 B

### **Notices for Customers in Europe**

**CAUTION: RISK OF EXPLOSION IF BATTERY IS REPLACED BY AN INCORRECT TYPE. DISPOSE OF USED BATTERIES ACCORDING TO THE INSTRUCTIONS.**

This symbol indicates that electrical and electronic equipment is to be collected separately.



This symbol on the battery indicates that the battery is to be collected separately.



The following apply only to users in European countries:

- This product is designated for separate collection at an appropriate collection point. Do not dispose of as household waste.
- Separate collection and recycling helps conserve natural resources and prevent negative consequences for human health and the environment that might result from incorrect disposal.
- For more information, contact the retailer or the local authorities in charge of waste management.

The following apply only to users in European countries:

- All batteries, whether marked with this symbol or not, are designated for separate collection at an appropriate collection point. Do not dispose of as household waste.
- For more information, contact the retailer or the local authorities in charge of waste management.

## Notices for Customers in the U.S.A.

### The Battery Charger

## IMPORTANT SAFETY INSTRUCTIONS—SAVE THESE INSTRUCTIONS

## DANGER—TO REDUCE THE RISK OF FIRE OR ELECTRIC SHOCK, CAREFULLY FOLLOW THESE INSTRUCTIONS

For connection to a supply not in the U.S.A., use an attachment plug adapter of the proper configuration for the power outlet if needed. This power unit is intended to be correctly oriented in a vertical or floor mount position.

### Federal Communications Commission (FCC) Radio Frequency Interference Statement

This equipment has been tested and found to comply with the limits for a Class B digital device, pursuant to Part 15 of the FCC rules. These limits are designed to provide reasonable protection against harmful interference in a residential installation. This equipment generates, uses, and can radiate radio frequency energy and, if not installed and used in accordance with the instructions, may cause harmful interference to radio communications. However, there is no guarantee that interference will not occur in a particular installation. If this equipment does cause harmful interference to radio or television reception, which can be determined by turning the equipment off and on, the user is encouraged to try to correct the interference by one or more of the following measures:

- Reorient or relocate the receiving antenna.
- Increase the separation between the equipment and receiver.
- Connect the equipment into an outlet on a circuit different from that to which the receiver is connected.
- Consult the dealer or an experienced radio/television technician for help.



**Nikon**  
D3300

### CAUTIONS

#### *Modifications*

The FCC requires the user be notified that any changes or modifications made to this device that are not expressly approved by Nikon Corporation may void the user's authority to operate the equipment.

#### *Interface Cables*

Use the interface cables sold or provided by Nikon for your equipment. Using other interface cables may exceed the limits of Class B Part 15 of the FCC rules.

#### *Notice for Customers in the State of California*

**WARNING:** Handling the cord on this product may expose you to lead, a chemical known to the State of California to cause birth defects or other reproductive harm. *Wash hands after handling.*

Nikon Inc., 1300 Walt Whitman Road, Melville, New York 11747-3064, U.S.A. Tel.: 631-547-4200

## **Notice Concerning Prohibition of Copying or Reproduction**

Note that simply being in possession of material that has been digitally copied or reproduced by means of a scanner, digital camera, or other device may be punishable by law.

- **Items prohibited by law from being copied or reproduced**

Do not copy or reproduce paper money, coins, securities, government bonds, or local government bonds, even if such copies or reproductions are stamped “Sample.”

The copying or reproduction of paper money, coins, or securities which are circulated in a foreign country is prohibited.

Unless the prior permission of the government has been obtained, the copying or reproduction of unused postage stamps or post cards issued by the government is prohibited.

The copying or reproduction of stamps issued by the government and of certified documents stipulated by law is prohibited.

- **Cautions on certain copies and reproductions**

The government has issued cautions on copies or reproductions of securities issued by private companies (shares, bills, checks, gift certificates, etc.), commuter passes, or coupon tickets, except when a minimum of necessary copies are to be provided for business use by a company. Also, do not copy or reproduce passports issued by the government, licenses issued by public agencies and private groups, ID cards, and tickets, such as passes and meal coupons.

- **Comply with copyright notices**

The copying or reproduction of copyrighted creative works such as books, music, paintings, woodcuts, prints, maps, drawings, movies, and photographs is governed by national and international copyright laws. Do not use this product for the purpose of making illegal copies or to infringe copyright laws.

## **Disposing of Data Storage Devices**

Please note that deleting images or formatting memory cards or other data storage devices does not completely erase the original image data. Deleted files can sometimes be recovered from discarded storage devices using commercially available software, potentially resulting in the malicious use of personal image data. Ensuring the privacy of such data is the user's responsibility.

Before discarding a data storage device or transferring ownership to another person, erase all data using commercial deletion software, or format the device and then completely refill it with images containing no private information (for example, pictures of empty sky). Be sure to also replace any pictures selected for preset manual (□ 129). Care should be taken to avoid injury when physically destroying data storage devices.

## **AVC Patent Portfolio License**

THIS PRODUCT IS LICENSED UNDER THE AVC PATENT PORTFOLIO LICENSE FOR THE PERSONAL AND NON-COMMERCIAL USE OF A CONSUMER TO (i) ENCODE VIDEO IN COMPLIANCE WITH THE AVC STANDARD ("AVC VIDEO") AND/OR (ii) DECODE AVC VIDEO THAT WAS ENCODED BY A CONSUMER ENGAGED IN A PERSONAL AND NON-COMMERCIAL ACTIVITY AND/OR WAS OBTAINED FROM A VIDEO PROVIDER LICENSED TO PROVIDE AVC VIDEO. NO LICENSE IS GRANTED OR SHALL BE IMPLIED FOR ANY OTHER USE. ADDITIONAL INFORMATION MAY BE OBTAINED FROM MPEG LA, L.L.C. SEE <http://www.mpegla.com>

## **Use Only Nikon Brand Electronic Accessories**

Nikon cameras are designed to the highest standards and include complex electronic circuitry. Only Nikon brand electronic accessories (including chargers, batteries, AC adapters, and flash accessories) certified by Nikon specifically for use with this Nikon digital camera are engineered and proven to operate within the operational and safety requirements of this electronic circuitry.

The use of non-Nikon electronic accessories could damage the camera and may void your Nikon warranty. The use of third-party rechargeable Li-ion batteries not bearing the Nikon holographic seal shown at right could interfere with normal operation of the camera or result in the batteries overheating, igniting, rupturing, or leaking.

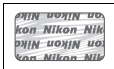

For more information about Nikon brand accessories, contact a local authorized Nikon dealer.

### **Use Only Nikon Brand Accessories**

Only Nikon brand accessories certified by Nikon specifically for use with your Nikon digital camera are engineered and proven to operate within its operational and safety requirements. THE USE OF NON-NIKON ACCESSORIES COULD DAMAGE YOUR CAMERA AND MAY VOID YOUR NIKON WARRANTY.

### **Before Taking Important Pictures**

Before taking pictures on important occasions (such as at weddings or before taking the camera on a trip), take a test shot to ensure that the camera is functioning normally. Nikon will not be held liable for damages or lost profits that may result from product malfunction.

### **Life-Long Learning**

As part of Nikon's "Life-Long Learning" commitment to ongoing product support and education, continually-updated information is available on-line at the following sites:

- **For users in the U.S.A.:** <http://www.nikonusa.com/>
- **For users in Europe and Africa:** <http://www.europe-nikon.com/support/>
- **For users in Asia, Oceania, and the Middle East:** <http://www.nikon-asia.com/>

Visit these sites to keep up-to-date with the latest product information, tips, answers to frequently-asked questions (FAQs), and general advice on digital imaging and photography. Additional information may be available from the Nikon representative in your area. See the following URL for contact information: <http://imaging.nikon.com/>



# Introduction

## Getting to Know the Camera

Take a few moments to familiarize yourself with camera controls and displays. You may find it helpful to bookmark this section and refer to it as you read through the rest of the manual.

### The Camera Body

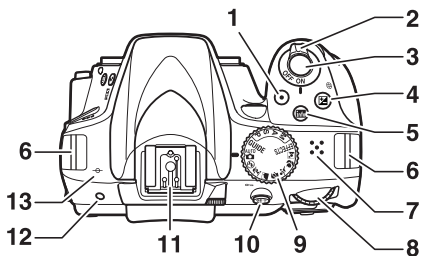



1	Movie-record button .....	38, 156	8	Command dial	
2	Power switch.....	17	9	Mode dial.....	4
3	Shutter-release button.....	27, 28	10	AF-L/AF-ON button .....	81, 184, 252
4	AF/AF-L button.....	109, 118, 120	11	Accessory shoe (for optional flash units) .....	299
5	Info (information) button.....	7, 150	12	Infrared receiver for ML-L3 remote control (rear) .....	98
6	Eyelets for camera strap .....	14	13	Focal plane mark (⊖) .....	84
7	Speaker				

#### The Speaker

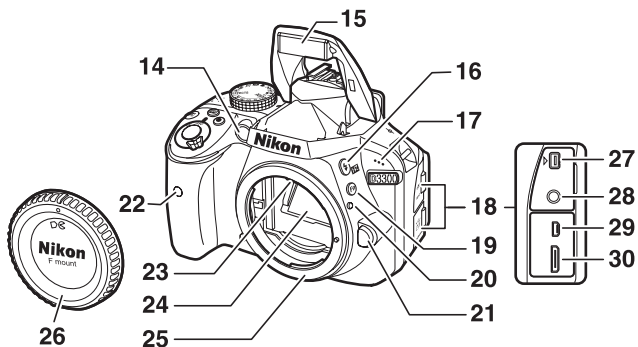
Do not place the speaker in close proximity to magnetic devices. Failure to observe this precaution could affect the data recorded on the magnetic devices.



<b>14</b> AF-assist illuminator .....77, 228	<b>23</b> CPU contacts
Self-timer lamp .....72	<b>24</b> Mirror..... 318
Red-eye reduction lamp ..... 90, 92	<b>25</b> Lens mount ..... 16, 84
<b>15</b> Built-in flash.....89	<b>26</b> Body cap
<b>16</b>  /  button..... 89, 91, 120	<b>27</b> Accessory terminal..... 309
<b>17</b> Microphone ..... 158	<b>28</b> Connector for external microphone ..... 161
<b>18</b> Connector cover	<b>29</b> USB and A/V connector
<b>19</b> Fn button ..... 251	..... 204, 208, 215
<b>20</b> Mounting mark .....16	<b>30</b> HDMI mini-pin connector ..... 217
<b>21</b> Lens release button.....24	
<b>22</b> Infrared receiver for ML-L3 remote control (front).....98	

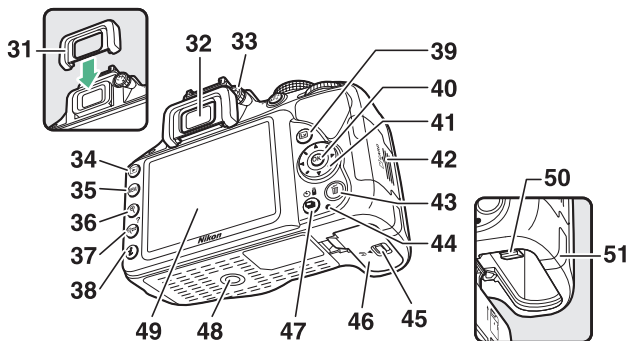

<b>31</b>	Rubber eyecup .....	73	<b>43</b>	☒ button .....	30, 192
<b>32</b>	Viewfinder eyepiece.....	6, 20, 73	<b>44</b>	Memory card access lamp .....	28, 143
<b>33</b>	Diopter adjustment control .....	20	<b>45</b>	Battery-chamber cover latch .....	15, 22
<b>34</b>	▶ button.....	29, 170	<b>46</b>	Battery-chamber cover .....	15, 22
<b>35</b>	MENU button .....	10, 219	<b>47</b>	☐/☺/☒ button....	67, 68, 70, 71, 97
<b>36</b>	Ⓚ button .....	182	<b>48</b>	Tripod socket	
<b>37</b>	☒/? button .....	11, 180, 182	<b>49</b>	Monitor .....	7, 29, 32, 142, 170
<b>38</b>	ⓘ button .....	9, 171	<b>50</b>	Battery latch.....	15, 22
<b>39</b>	☺ button.....	32, 37, 142, 155	<b>51</b>	Power connector cover for optional power connector .....	311
<b>40</b>	Ⓞ (OK) button.....	11			
<b>41</b>	Multi selector .....	11			
<b>42</b>	Memory card slot cover.....	15, 23			

## The Mode Dial

The camera offers a choice of the following shooting modes and **GUIDE** mode:

### P, S, A, and M Modes

Select these modes for full control over camera settings.

- **P**—**Programmed auto** (□ 102)
- **S**—**Shutter-priority auto** (□ 104)
- **A**—**Aperture-priority auto** (□ 106)
- **M**—**Manual** (□ 108)

### GUIDE Mode (□ 41)

Take, view, and edit pictures and adjust settings with the help of an on-screen guide.

### Auto Modes





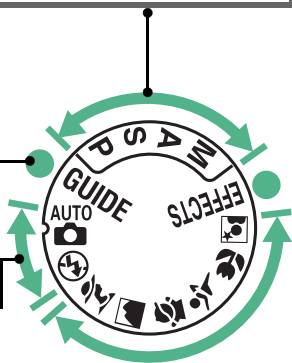







Select these modes for simple, point-and-shoot photography.

-  **Auto** (□ 25)
-  **Auto (flash off)** (□ 25)



## Special Effects Modes

Use special effects during shooting.

-  **Night vision** (□ 51)
-  **VI Super vivid** (□ 51)
- **POP Pop** (□ 51)
-  **Photo illustration** (□ 52, 56)
-  **Color sketch** (□ 52, 57)
-  **Toy camera effect** (□ 52, 58)
-  **Miniature effect** (□ 53, 59)
-  **Selective color** (□ 53, 61)
-  **Silhouette** (□ 54)
-  **High key** (□ 54)
-  **Low key** (□ 54)
-  **HDR painting** (□ 55)
-  **Easy panorama** (□ 55, 63)

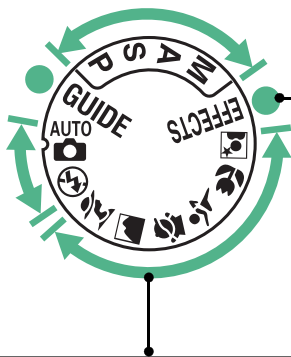

## Scene Modes

The camera automatically optimizes settings to suit the scene selected with the mode dial. Match your selection to the scene being photographed.

-  **Portrait** (□ 47)
-  **Landscape** (□ 47)
-  **Child** (□ 48)
-  **Sports** (□ 48)
-  **Close up** (□ 48)
-  **Night portrait** (□ 49)

# The Viewfinder

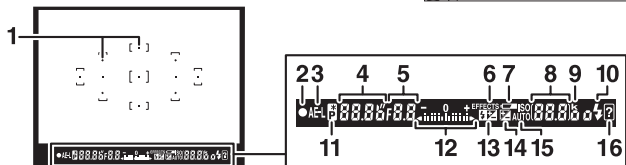
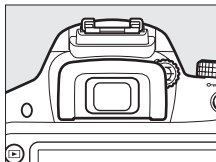

<p><b>1</b> Focus points..... 20, 27, 80</p> <p><b>2</b> Focus indicator.....27, 84</p> <p><b>3</b> Autoexposure (AE) lock indicator ..... 116</p> <p><b>4</b> Shutter speed ..... 101</p> <p><b>5</b> Aperture (f-number) ..... 101</p> <p><b>6</b> Special effects mode indicator...50</p> <p><b>7</b> Low battery warning .....21</p> <p><b>8</b> Number of exposures remaining .....19 Number of shots remaining before memory buffer fills .....69 White balance recording indicator ..... 129 Exposure compensation value ..... 118 Flash compensation value..... 120 ISO sensitivity .....95, 226</p>	<p><b>9</b> “k” (appears when memory remains for over 1000 exposures) .....19</p> <p><b>10</b> Flash-ready indicator.....31</p> <p><b>11</b> Flexible program indicator..... 103</p> <p><b>12</b> Exposure indicator ..... 109 Exposure compensation display ..... 118 Electronic rangefinder ..... 248</p> <p><b>13</b> Flash compensation indicator ..... 120</p> <p><b>14</b> Exposure compensation indicator ..... 118</p> <p><b>15</b> Auto ISO sensitivity indicator ..... 227</p> <p><b>16</b> Warning indicator ..... 336</p>
--	---

**Note:** Display shown with all indicators lit for illustrative purposes.

## The Information Display

**Viewing settings:** To view the information display, press the **Info** button.

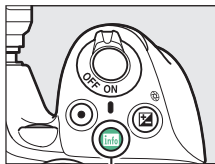

**Info** button



### 1 Shooting mode

**Auto** auto/

**Auto** (flash off) ..... 25

Scene modes ..... 47

Special effects mode ..... 50

**P, S, A, and M** modes ..... 100

### 2 Eye-Fi connection indicator ..... 261

### 3 Satellite signal indicator ..... 260

### 4 Print date indicator ..... 254

### 5 Vibration reduction indicator

..... 23, 230

### 6 Flash control indicator ..... 229

Flash compensation indicator for optional flash units ..... 304

### 7 Active D-Lighting ..... 122

### 8 Picture Control ..... 135

### 9 Release mode ..... 67

### 10 "Beep" indicator ..... 247

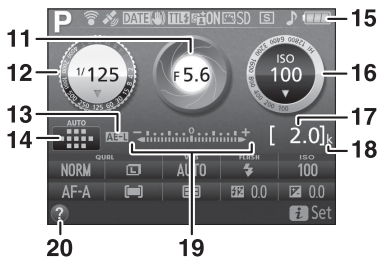

<p><b>11</b> Aperture (f-number) ..... 101 Aperture display ..... 101</p> <p><b>12</b> Shutter speed ..... 101 Shutter-speed display ..... 101</p> <p><b>13</b> Autoexposure (AE) lock indicator ..... 116</p> <p><b>14</b> Auto-area AF indicator .....78 3D-tracking indicator .....78 Focus point.....80</p> <p><b>15</b> Battery indicator .....21</p> <p><b>16</b> ISO sensitivity .....95 ISO sensitivity display .....95, 228 Auto ISO sensitivity indicator ..... 227</p>	<p><b>17</b> Number of exposures remaining ..... 19 White balance recording indicator ..... 129</p> <p><b>18</b> "k" (appears when memory remains for over 1000 exposures) ..... 19</p> <p><b>19</b> Exposure indicator ..... 109 Exposure compensation indicator ..... 118</p> <p><b>20</b> Help icon ..... 336</p>
---	--

**Note:** Display shown with all indicators lit for illustrative purposes.

### **Turning the Monitor Off**

To clear shooting information from the monitor, press the button or press the shutter-release button halfway. The monitor will turn off automatically if no operations are performed for about 8 seconds (for information on choosing how long the monitor stays on, see **Auto off timers** on page 245).



**Changing settings:** To change the settings at the bottom of the display, press the **i** button, then highlight items using the multi selector and press **OK** to view options for the highlighted item.

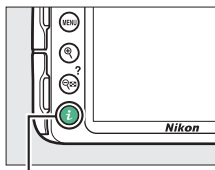

**i** button

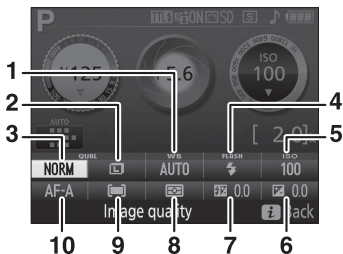

1	White balance.....	124	6	Exposure compensation .....	118
2	Image size .....	87	7	Flash compensation.....	120
3	Image quality.....	85	8	Metering .....	114
4	Flash mode .....	90, 92	9	AF-area mode .....	78, 145
5	ISO sensitivity .....	95	10	Focus mode.....	74, 144

## Camera Menu: An Overview

Most shooting, playback, and setup options can be accessed from the camera menu. To view the menus, press the **MENU** button.

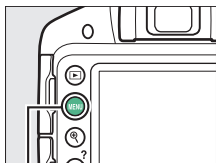

MENU button

### Tabs

Choose from the following menus:

- : **Playback** (📖 219)
- : **Shooting** (📖 222)
- : **Setup** (📖 231)
- : **Retouch** (📖 263)
- : **Recent settings** (📖 288)

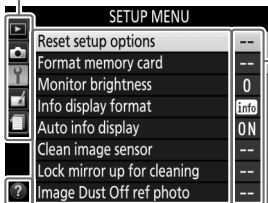

Current settings are shown by icons.

### Menu options

Options in current menu.

**Help icon** (📖 11)

## ■ Using Camera Menus

The multi selector and  button are used to navigate the camera menus.

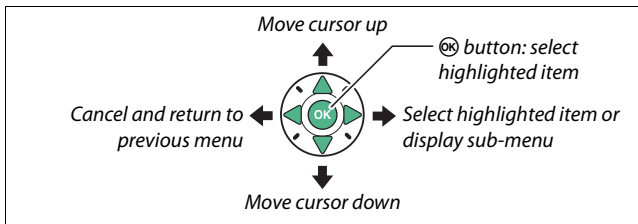

Follow the steps below to navigate the menus.



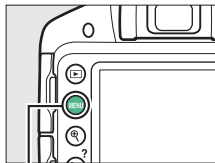

### 1 Display the menus.

Press the MENU button to display the menus.



MENU button

### The (Help) Icon

If a  icon is displayed at the bottom left corner of the monitor, help can be displayed by pressing the  (?). A description of the currently selected option or menu will be displayed while the button is pressed. Press  or  to scroll through the display.

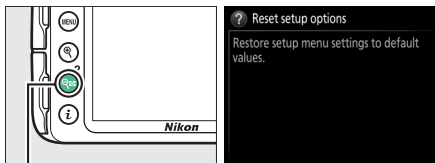

 (?) button

## 2 Highlight the icon for the current menu.

Press ◀ to highlight the icon for the current menu.



## 3 Select a menu.

Press ▲ or ▼ to select the desired menu.

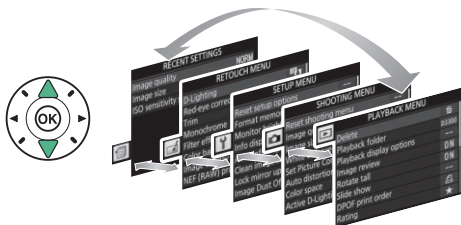

## 4 Position the cursor in the selected menu.

Press ▶ to position the cursor in the selected menu.

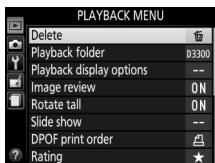

## 5 Highlight a menu item.

Press ▲ or ▼ to highlight a menu item.

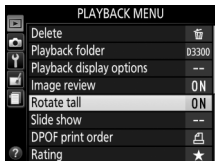

## 6 Display options.

Press ► to display options for the selected menu item.

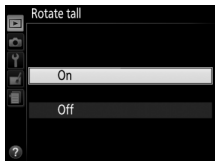

## 7 Highlight an option.

Press ▲ or ▼ to highlight an option.

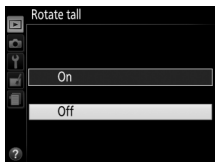

## 8 Select the highlighted item.

Press OK to select the highlighted item. To exit without making a selection, press the MENU button.



Note the following:

- Menu items that are displayed in gray are not currently available.
- While pressing ► generally has the same effect as pressing OK, there are some cases in which selection can only be made by pressing OK.
- To exit the menus and return to shooting mode, press the shutter-release button halfway (📖 28).

## First Steps

Always turn the camera off before inserting or removing batteries or memory cards.

### 1 Attach the strap.

Attach the strap as shown. Repeat for the second eyelet.

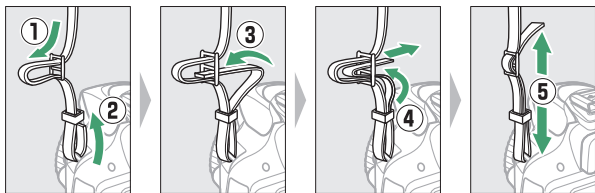

### 2 Charge the battery.

If a plug adapter is supplied, raise the wall plug and connect the plug adapter as shown below at left, making sure the plug is fully inserted. Insert the battery and plug the charger in. An exhausted battery will fully charge in about an hour and 50 minutes.

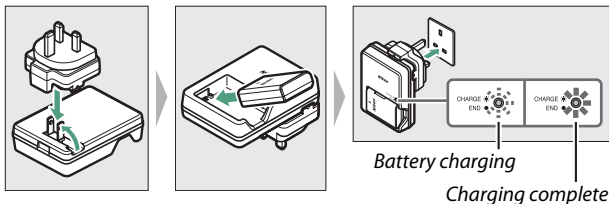

### 3 Insert the battery and memory card.

Insert the battery in the orientation shown, using the battery to keep the orange battery latch pressed to one side. The latch locks the battery in place when the battery is fully inserted.

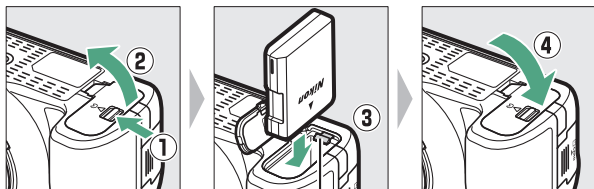

Battery latch

Slide the memory card in until it clicks into place.

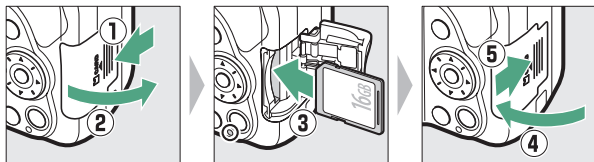

## 4 Attach a lens.

Be careful to prevent dust from entering the camera when the lens or body cap is removed.

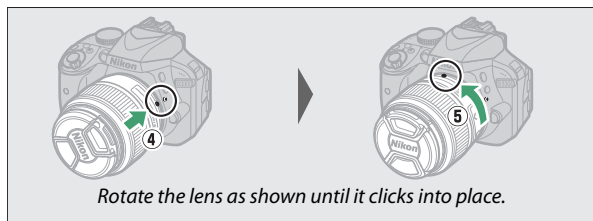
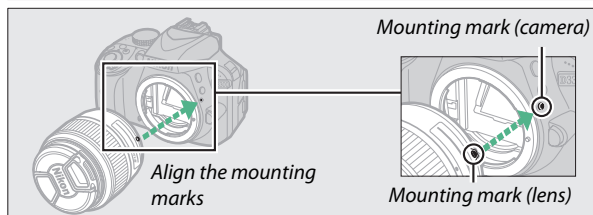
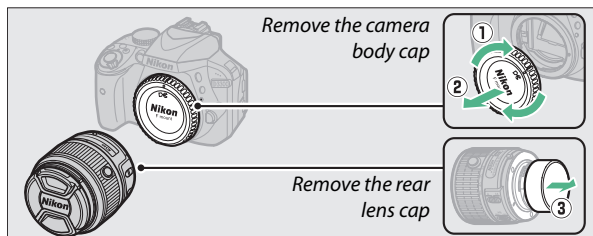

Be sure to remove the lens cap before taking pictures.

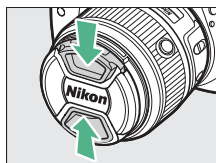



- 5 Turn the camera on.**  
A language-selection dialog will be displayed.

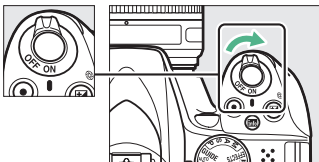

### The Power Switch

Rotate the power switch as shown to turn the camera on.

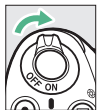

Rotate the power switch as shown to turn the camera off.

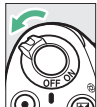

### Lenses with Retractable Lens Barrel Buttons

Before using the camera, unlock and extend the zoom ring. Keeping the retractable lens barrel button pressed (①), rotate the zoom ring as shown (②).

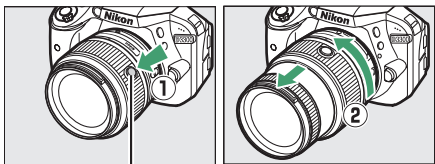

*Retractable lens barrel button*

Pictures can not be taken when the lens is retracted; if an error message is displayed as a result of the camera having been turned on with the lens retracted, rotate the zoom ring until the message is no longer displayed.



- 6** Choose a language and set the camera clock.  
Use the multi selector and **OK** button to select a language and set the camera clock.

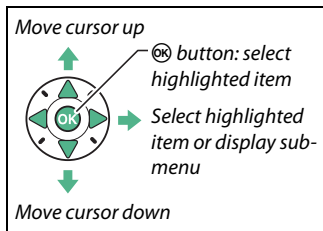

Select language



Select time zone

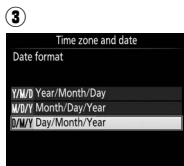

Select date format

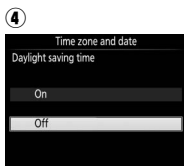

Select daylight saving time option



Set time and date  
(note that the camera uses a 24-hour clock)

## 7 Check the battery level and number of exposures remaining.

Press the **Info** button and check the battery level and number of exposures remaining. In the case of exposures remaining, values over 1000 are shown in thousands, indicated by the letter “k”.

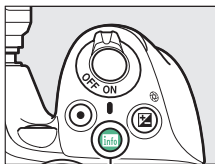

**Info** button

Battery level (🔋 21)



Number of exposures remaining

## 8 Focus the viewfinder.

After removing the lens cap, rotate the diopter adjustment control until the focus points are in sharp focus. When operating the control with your eye to the viewfinder, be careful not to put your fingers or fingernails in your eye.

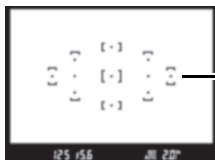
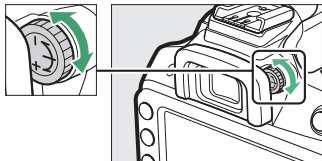

*Viewfinder not in focus*

*Focus points*

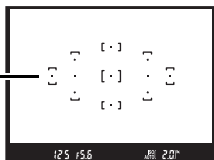

*Viewfinder in focus*

### **During Charging**

Do not move the charger or touch the battery during charging. Failure to observe this precaution could in very rare instances result in the charger showing that charging is complete when the battery is only partially charged. Remove and reinsert the battery to begin charging again.

### ✔ Charging the Battery

Read and follow the warnings and cautions on pages x–xiii and 321–325 of this manual. Charge the battery indoors at ambient temperatures of 5 °C–35 °C (41 °F–95 °F). Do not use the battery at ambient temperatures below 0 °C/32 °F or above 40 °C/104 °F; failure to observe this precaution could damage the battery or impair its performance. Capacity may be reduced and charging times may increase at battery temperatures from 0 °C/32 °F to 15 °C/59 °F and from 45 °C/113 °F to 60 °C/140 °F. The battery will not charge if its temperature is below 0 °C (32 °F) or above 60 °C (140 °F). If the **CHARGE** lamp flashes quickly (about eight times a second) during charging, confirm that the temperature is in the correct range and then unplug the charger and remove and reinsert the battery. If the problem persists, cease use immediately and take battery and charger to your retailer or a Nikon-authorized service representative.

Use the charger with compatible batteries only. Unplug when not in use.

### ✔ Battery Level

Battery level is shown in the information display (if the battery is low, a warning will also be displayed in the viewfinder). If the information display does not appear when the **info** button is pressed, the battery is exhausted and needs to be recharged.



Information display	Viewfinder	Description
	—	Battery fully charged.
	—	Battery partially discharged.
		Low battery. Ready fully-charged spare battery or prepare to charge battery.
 (flashes)	 (flashes)	Battery exhausted. Charge battery.

### Removing the Battery

To remove the battery, turn the camera off and open the battery-chamber cover. Press the battery latch in the direction shown by the arrow to release the battery and then remove the battery by hand.

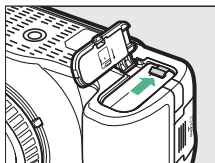

### Formatting Memory Cards

If this is the first time the memory card will be used in the camera or if the card has been formatted in another device, select **Format memory card** in the setup menu and follow the on-screen instructions to format the card (🗨 234). *Note that this permanently deletes any data the card may contain.* Be sure to copy any photographs and other data you wish to keep to a computer before proceeding.



### Memory Cards

- Memory cards may be hot after use. Observe due caution when removing memory cards from the camera.
- Turn the power off before inserting or removing memory cards. Do not remove memory cards from the camera, turn the camera off, or remove or disconnect the power source during formatting or while data are being recorded, deleted, or copied to a computer. Failure to observe these precautions could result in loss of data or in damage to the camera or card.
- Do not touch the card terminals with your fingers or metal objects.
- Do not bend, drop, or subject to strong physical shocks.
- Do not apply force to the card casing. Failure to observe this precaution could damage the card.
- Do not expose to water, heat, high levels of humidity, or direct sunlight.
- Do not format memory cards in a computer.

### Removing Memory Cards

After confirming that the memory card access lamp is off, turn the camera off, open the memory card slot cover, and press the card in to eject it (1). The card can then be removed by hand (2).

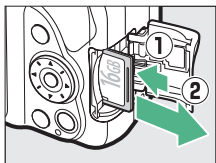

### The Write Protect Switch

SD memory cards are equipped with a write protect switch to prevent accidental loss of data. When this switch is in the “lock” position, the memory card can not be formatted and photos can not be deleted or recorded (a beep will sound if you attempt to release the shutter). To unlock the memory card, slide the switch to the “write” position.

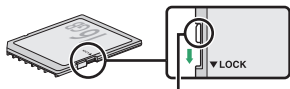

Write-protect switch

### A-M, M/A-M, and A/M-M Switches

When using autofocus with a lens equipped with an **A-M** mode switch, slide the switch to **A** (if the lens has an **M/A-M** or **A/M-M** switch, select **M/A** or **A/M**). For information on other lenses that can be used with this camera, see page 289.



### Vibration Reduction (VR)

Vibration reduction can be enabled by selecting **On** for **Optical VR** in the shooting menu (230), if the lens supports this option, or by sliding the lens vibration reduction switch to **ON**, if the lens is equipped with a vibration reduction switch. A vibration reduction indicator appears in the information display when vibration reduction is on.



### Detaching the Lens

Be sure the camera is off when removing or exchanging lenses. To remove the lens, press and hold the lens release button (①) while turning the lens clockwise (②). After removing the lens, replace the lens caps and camera body cap.

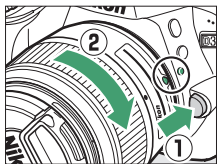

### Retracting Lenses with Retractable Lens Barrel Buttons

To retract the lens when the camera is not in use, hold the retractable lens barrel button (①) and rotate the zoom ring to the "L" (lock) position as shown (②). Retract the lens before removing it from the camera, and be careful not to press the retractable lens barrel button when attaching or removing the lens.

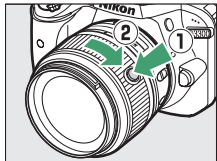

### The Camera Clock



The camera clock is less accurate than most watches and household clocks. Check the clock regularly against more accurate time pieces and reset as necessary.

### The Clock Battery



The camera clock is powered by an independent, rechargeable power source, which is charged as necessary when the main battery is installed. Three days of charging will power the clock for about a month. If a message warning that the clock is not set is displayed when the camera is turned on, the clock battery is exhausted and the clock has been reset. Set the clock to the correct time and date.



# “Point-and-Shoot” Modes (AUTO and )

This section describes how to shoot photographs and movies in  and  modes, automatic “point-and-shoot” modes in which the majority of settings are controlled by the camera in response to shooting conditions.



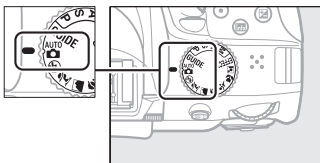

Before proceeding, turn the camera on and rotate the mode dial to  or  (the only difference between the two is that the flash will not fire in  mode).

Mode dial









## Viewfinder photography



<i>Taking photographs</i>	 26
<i>Viewing photographs</i>	 29
<i>Deleting photographs</i>	 30

## Live view



<i>Taking photographs</i>	 32
<i>Viewing photographs</i>	 35
<i>Deleting photographs</i>	 36
<i>Shooting movies</i>	 37
<i>Viewing movies</i>	 39
<i>Deleting movies</i>	 40

## Framing Photos in the Viewfinder

### 1 Ready the camera.

When framing photographs in the viewfinder, hold the handgrip in your right hand and cradle the camera body or lens with your left.

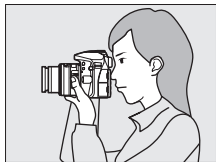

When framing photographs in portrait (tall) orientation, hold the camera as shown at right.



### Using a Zoom Lens

Before focusing, rotate the zoom ring to adjust the focal length and frame the photograph. Use the zoom ring to zoom in on the subject so that it fills a larger area of the frame, or zoom out to increase the area visible in the final photograph (select longer focal lengths on the lens focal length scale to zoom in, shorter focal lengths to zoom out). If the lens is equipped with a retractable lens barrel button (☐ 17), press and hold the button while rotating the zoom ring until the lens is released and the message shown at right is no longer displayed, and then adjust zoom using the zoom ring.

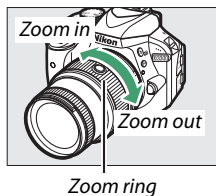

## 2 Frame the photograph.

Frame a photograph in the viewfinder with the main subject in at least one of the 11 focus points.

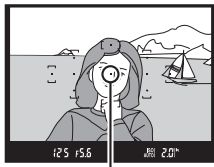

*Focus point*

## 3 Press the shutter-release button halfway.

Press the shutter-release button halfway to focus (if the subject is poorly lit, the flash may pop up and the AF-assist illuminator may flash). When the focus operation is complete, a beep will sound (a beep may not sound if the subject is moving) and the in-focus indicator (●) will appear in the viewfinder.



*In-focus indicator*

*Buffer capacity*

In-focus indicator	Description
●	Subject in focus.
● (flashes)	Camera unable to focus using autofocus. See page 76.

## 4 Shoot.

Smoothly press the shutter-release button the rest of the way down to take the photograph. The memory card access lamp will light and the photograph will be displayed in the monitor for a few seconds. *Do not eject the memory card or remove or disconnect the power source until the lamp has gone out and recording is complete.*

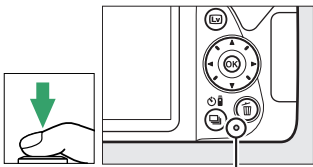

Memory card access lamp



### The Shutter-Release Button

The camera has a two-stage shutter-release button. The camera focuses when the shutter-release button is pressed halfway. To take the photograph, press the shutter-release button the rest of the way down.



Focus: press halfway



Shoot: press all the way down



Pressing the shutter-release button halfway also ends playback and readies the camera for immediate use.

## Viewing Photographs

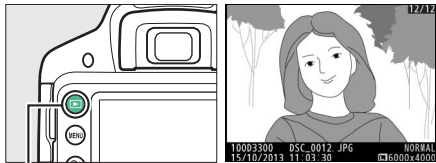
Pressing  displays a picture in the monitor.



 *button*

Press  or  to view additional pictures.



## Deleting Unwanted Pictures

Display the photograph you wish to delete.



▶ button

Press ; a confirmation dialog will be displayed.

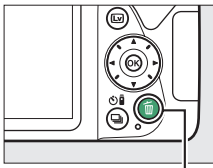

 button



Press the  button again to delete the picture.

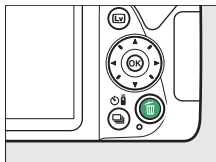

### The Standby Timer

The viewfinder and information display will turn off if no operations are performed for about eight seconds, reducing the drain on the battery. Press the shutter-release button halfway to reactivate the display. The length of time before the standby timer expires automatically can be selected using the **Auto off timers** option in the setup menu (☞ 245).





*Exposure meters off*



*Exposure meters on*

### The Built-in Flash

If additional lighting is required for correct exposure in  mode, the built-in flash will pop up automatically when the shutter-release button is pressed halfway (☞ 89). If the flash is raised, photographs can only be taken when the flash-ready indicator () is displayed. If the flash-ready indicator is not displayed, the flash is charging; remove your finger briefly from the shutter-release button and try again.

When the flash is not in use, return it to its closed position by pressing it gently downward till the latch clicks into place.

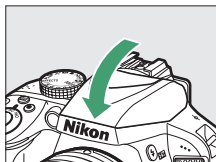
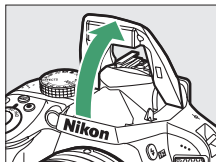

## Framing Photos in the Monitor

### 1 Press the **Lv** button.

The view through the lens will be displayed in the camera monitor (live view).

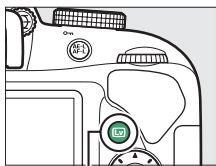

**Lv** button

### 2 Ready the camera.

Hold the handgrip in your right hand and cradle the camera body or lens with your left.

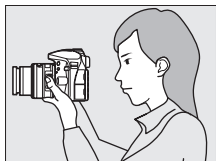

When framing photographs in portrait (tall) orientation, hold the camera as shown at right.





### 3 Focus.

Press the shutter-release button halfway. The focus point will flash green while the camera focuses. If the camera is able to focus, the focus point will be displayed in green; if the camera is unable to focus, the focus point will flash red.



Focus point

### 4 Take the picture.

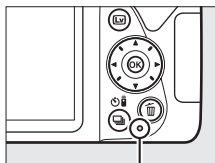

Press the shutter-release button the rest of the way down. The monitor turns off and the memory card access lamp lights during recording. *Do not eject the memory card or remove or disconnect the power source until the lamp has gone out and recording is complete.* When recording is complete, the photograph will be displayed in the monitor for a few seconds. Press the  button to exit live view.



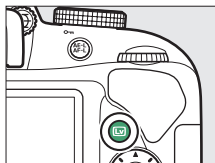







Memory card access lamp



### Automatic Scene Selection (Scene Auto Selector)

If live view is selected in  or  mode, the camera will automatically analyze the subject and select the appropriate shooting mode when autofocus is enabled. The selected mode is shown in the monitor.



	<b>Portrait</b>	Human portrait subjects
	<b>Landscape</b>	Landscapes and cityscapes
	<b>Close up</b>	Subjects close to the camera
	<b>Night portrait</b>	Portrait subjects framed against a dark background
	<b>Auto</b>	Subjects suited to  or  mode or that do not fall into the categories listed above
	<b>Auto (flash off)</b>	

### Live View



For more information on taking photographs in live view, see page 142.

## Viewing Photographs

Pressing  displays a picture in the monitor.



 button

Press  or  to view additional pictures.



## Deleting Unwanted Pictures

Display the photograph you wish to delete.



 *button*

Press ; a confirmation dialog will be displayed.

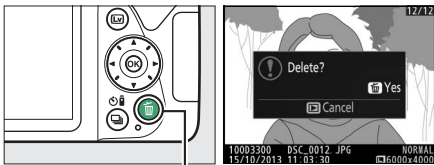

 *button*

Press the  button again to delete the picture.

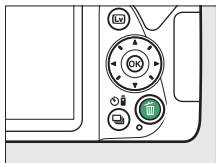

# Recording Movies

Movies can be recorded in live view mode.

## 1 Press the **Lv** button.

The view through the lens is displayed in the monitor.

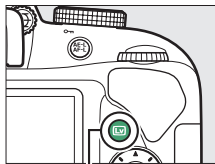

**Lv** button

## 2 Ready the camera.

Hold the handgrip in your right hand and cradle the camera body or lens with your left.

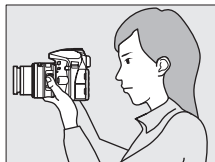

## 3 Focus.

Press the shutter-release button halfway to focus.



*Focus point*

## 4 Start recording.

Press the movie-record button to start recording. A recording indicator and the time available are displayed in the monitor.

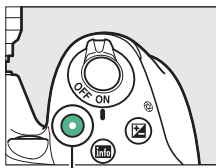

*Movie-record button*

*Recording indicator*



*Time remaining*

## 5 End recording.



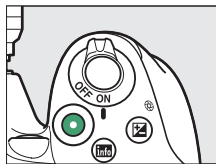

Press the movie-record button again to end recording. Press the **[Lv]** button to exit live view.



### Recording Movies

See page 155 for more information on recording movies.

## Viewing Movies

Press  to start playback and then scroll through pictures until a movie (indicated by a  icon) is displayed. Press  to start playback and press  or  to end playback. For more information, see page 162.

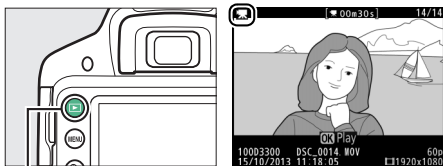

 button

## Deleting Unwanted Movies

Display the movie you wish to delete (movies are indicated by  icons).



 button

Press ; a confirmation dialog will be displayed.

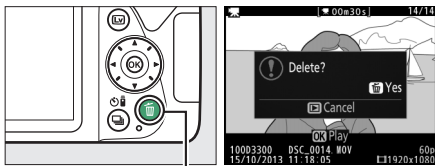

 button

Press the  button again to delete the movie.

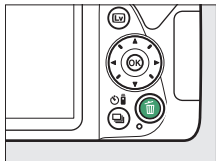





# Guide Mode

## The Guide

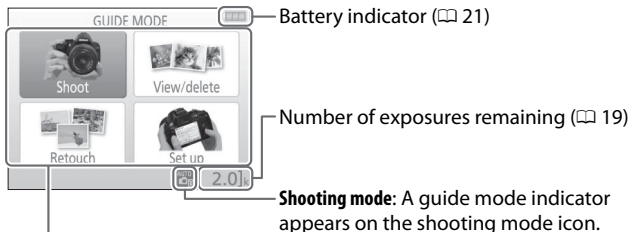
Guide mode gives access to a variety of frequently-used and useful functions. The top level of the guide is displayed when the mode dial is rotated to **GUIDE**.

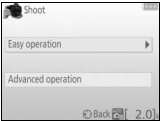
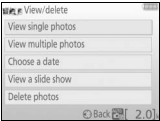

Choose from the following items:

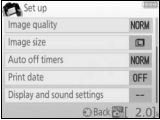
Shoot	View/delete
<p>Take pictures.</p> 	<p>View and/or delete pictures.</p> 
Retouch	Set up
<p>Retouch pictures.</p> 	<p>Change camera settings.</p> 

## Guide Mode Menus

To access these menus, highlight **Shoot**, **View/delete**, **Retouch**, or **Set up** and press **OK**.

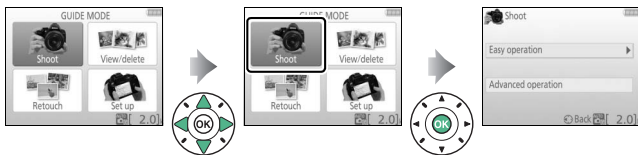

### ■ Shoot

#### Easy operation

	Auto
	No flash
	Distant subjects
	Close-ups
	Sleeping faces
	Moving subjects
	Landscapes
	Portraits
	Night portrait
	Photograph night landscapes

#### Advanced operation

	Soften backgrounds	Adjust aperture.
	Bring more into focus	
	Freeze motion (people)	Select a shutter speed.
	Freeze motion (vehicles)	
	Show water flowing	
	Capture reds in sunsets*	Adjust white balance to vividly capture the colors in sunsets.
	Take bright photos*	Adjust exposure compensation to take bright (high key) or dark (low key) photos.
	Take dark (low key) photos*	
	Reduce blur	Adjust auto ISO sensitivity control for poorly lit subjects or telephoto lenses.

\* Affects other **Advanced operation** items. To restore default settings, turn the camera off and then on again.

## “Start Shooting”

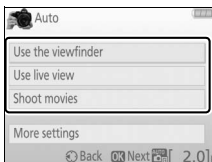

Highlight an option and press **OK**.

- Use the viewfinder
- Use live view
- Shoot movies

## “More Settings”

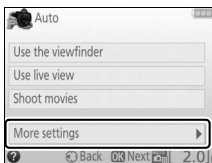

If **More settings** is displayed, you can highlight this option and press **▶** to access the following settings (the settings available vary with the shooting option selected):

- Flash settings > Flash mode
- Flash settings > Flash compensation
- Release mode
- ISO sensitivity settings > ISO sensitivity
- ISO sensitivity settings > Auto ISO sensitivity control
- Set Picture Control
- Exposure compensation
- White balance

## ■ View/Delete

---

**View single photos**

---

**View multiple photos**

---

**Choose a date**

---

---

**View a slide show**

---

**Delete photos**

---

### **Guide Mode**

Guide mode is reset to **Easy operation > Auto** when the mode dial is rotated to another setting or the camera is turned off.

## ■ ■ Retouch

Trim

Filter effects (cross screen)

Filter effects (soft)

Photo illustration

Miniature effect

Selective color

## ■ ■ Set Up

Image quality

Image size

Auto off timers

Print date

Display and sound settings

Monitor brightness

Info background color

Auto info display

Beep

Movie settings

Frame size/frame rate

Movie quality

Microphone

Wind noise reduction

Flicker reduction

Playback folder

Playback display options

DPOF print order

Clock and language

Time zone and date

Language

Format memory card

Output settings

HDMI

Video mode

Wireless mobile adapter

Eye-Fi upload \*







Slot empty release lock



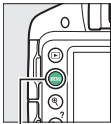

\* Only available when compatible Eye-Fi memory card is inserted (□ 261).

Changes to **Image quality**, **Image size**, **Auto off timers**, **Print date**, **Playback folder**, **Playback display options**, all **Display and sound settings** options, and all **Movie settings** options except **Flicker reduction** apply in guide mode only and are not reflected in other shooting modes.

## Using the Guide

The following operations can be performed while the guide is displayed:

To	Use	Description
Return to top level of guide		Press <b>MENU</b> to turn the monitor on or return to the top level of the guide.
Turn monitor on	<b>MENU button</b>	
Highlight a menu		Press <b>▲</b> , <b>▼</b> , <b>◀</b> , or <b>▶</b> to highlight a menu.
Highlight options		Press <b>▲</b> or <b>▼</b> to highlight options in the menus.
		Press <b>▲</b> , <b>▼</b> , <b>◀</b> , or <b>▶</b> to highlight options in displays like that shown below. 
Select highlighted menu or option		Press <b>OK</b> to select the highlighted menu or option.

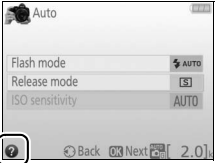
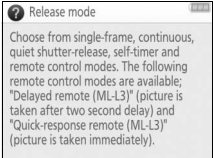
To	Use	Description
Return to previous display		Press ◀ to return to the previous display.
		<p>To cancel and return to the previous display from displays like that shown below, highlight ↶ and press Ⓞ.</p> 
View help	 <p><b>Q (?) button</b></p>	<p>If a ? icon is displayed at the bottom left corner of the monitor, help can be displayed by pressing the Q (?) button. A description of the currently selected option will be displayed while the button is pressed. Press ▲ or ▼ to scroll through the display.</p>  <p><b>? (help) icon</b></p> 

# Matching Settings to the Subject or Situation (Scene Mode)

The camera offers a choice of “scene” modes. Choosing a scene mode automatically optimizes settings to suit the selected scene, making creative photography as simple as selecting a mode, framing a picture, and shooting as described on page 25.

The following scenes can be selected with the mode dial:

Mode dial

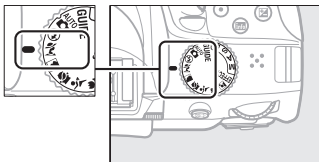

## Portrait



Use for portraits with soft, natural-looking skin tones. If the subject is far from the background or a telephoto lens is used, background details will be softened to lend the composition a sense of depth.

## Landscape

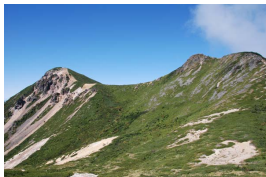

Use for vivid landscape shots in daylight.

### Note

The built-in flash and AF-assist illuminator turn off.

## **Child**

---



Use for snapshots of children. Clothing and background details are vividly rendered, while skin tones remain soft and natural.

## **Sports**

---



Fast shutter speeds freeze motion for dynamic sports shots in which the main subject stands out clearly.

### **Note**

The built-in flash and AF-assist illuminator turn off.

## **Close up**

---



Use for close-up shots of flowers, insects, and other small objects (a macro lens can be used to focus at very close ranges).



## **Night Portrait**















Use for a natural balance between the main subject and the background in portraits taken under low light.

### **Preventing Blur**

Use a tripod to prevent blur caused by camera shake at slow shutter speeds.

# Special Effects

Special effects can be used when recording images.

 Night Vision	 Selective Color
 VI Super Vivid	 Silhouette
 POP Pop	 High Key
 Photo Illustration	 Low Key
 Color Sketch	 HDR Painting
 Toy Camera Effect	 Easy Panorama
 Miniature Effect	



The following effects can be selected by rotating the mode dial to **EFFECTS** and rotating the command dial until the desired option appears in the monitor.

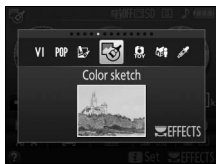
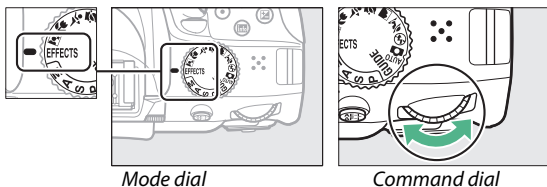

Monitor

## **Night Vision**

---

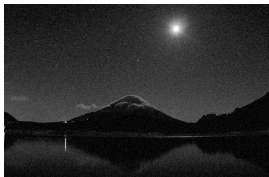

Use under conditions of darkness to record monochrome images at high ISO sensitivities.

### **Note**

Pictures may be affected by noise in the form of randomly-spaced bright pixels, fog, or lines. Autofocus is available in live view only; manual focus can be used if the camera is unable to focus. The built-in flash and AF-assist illuminator turn off.

## **VI Super Vivid**

---



Overall saturation and contrast are increased for a more vibrant image.

## **POP Pop**

---



Overall saturation is increased for a more lively image.



## **Photo Illustration**

---



Sharpen outlines and simplify coloring for a poster effect that can be adjusted in live view (📖 56).

### **Note**

The flash turns off automatically; to use the flash, choose a flash mode (📖 90) of  **AUTO** (auto) or  **AUTO** (auto + red-eye reduction). Movies shot in this mode play back like a slide show made up of a series of stills.

## **Color Sketch**

---



The camera detects and colors outlines for a color sketch effect. The effect can be adjusted in live view (📖 57).

### **Note**

Movies shot in this mode play back like a slide show made up of a series of stills.

## **Toy Camera Effect**

---

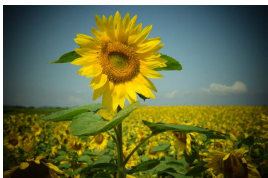

Create photos and movies that appear to have been shot with a toy camera. The effect can be adjusted in live view (📖 58).

## **Miniature Effect**

---



Create photos that appear to be pictures of dioramas. Works best when shooting from a high vantage point. Miniature effect movies play back at high speed, compressing about 45 minutes of footage shot at 1920 × 1080/30p into a movie that plays back in about three minutes. The effect can be adjusted in live view ( 59).

### **Note**

Sound is not recorded with movies. The built-in flash and AF-assist illuminator turn off.

## **Selective Color**

---



All colors other than the selected colors are recorded in black and white. The effect can be adjusted in live view ( 61).

### **Note**

The built-in flash turns off.

## **Silhouette**

---



Silhouette subjects against bright backgrounds.

### **Note**

The built-in flash turns off.

## **High Key**

---



Use with bright scenes to create bright images that seem filled with light.

### **Note**

The built-in flash turns off.

## **Low Key**

---



Use with dark scenes to create dark, low-key images with prominent highlights.

### **Note**

The built-in flash turns off.

### **Preventing Blur**

Use a tripod to prevent blur caused by camera shake at slow shutter speeds.

## **HDR Painting**



Each time a photo is taken, the camera shoots two frames at different exposures and combines them for a painterly effect that emphasizes detail and color.

### **Note**

The effect can not be previewed in live view. Note that the desired results may not be achieved if the camera or subject moves during shooting. During recording, a message is displayed and no further photos can be taken. The built-in flash turns off, continuous shooting is disabled, and movies are recorded in  mode.

## **Easy Panorama**









Shoot panoramas as described on page 63. Start live view before beginning recording; panoramas can not be shot during viewfinder photography.

### **Note**

The built-in flash turns off and movies can not be recorded.

### **NEF (RAW)**

NEF (RAW) recording is not available in , **VI**, **POP**, , , , , , and  modes. Pictures taken when an NEF (RAW) or NEF (RAW) + JPEG fine option is selected in these modes will be recorded as JPEG images. JPEG images created at these settings will be recorded as fine-quality images.

### , , and Modes

Autofocus is not available during movie recording. The live view refresh rate will drop, together with the frame rate for continuous release mode; using autofocus during live view photography will disrupt the preview.

## Options Available in Live View

### Photo Illustration

#### 1 Select live view.

Press the **Lv** button. The view through the lens will be displayed in the monitor.

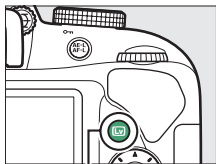

**Lv** button

#### 2 Adjust outline thickness.

Press **OK** to display the options shown at right. Press **▶** or **◀** to make outlines thicker or thinner.

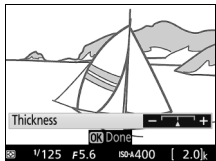

#### 3 Press **OK**.

Press **OK** to exit when settings are complete. To exit live view, press the **Lv** button. The selected settings will continue in effect and will apply to photographs taken using the viewfinder.



## 1 Select live view.

Press the **Lv** button. The view through the lens will be displayed in the monitor.

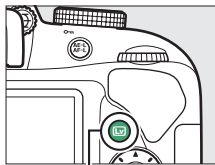

**Lv** button

## 2 Adjust options.

Press **OK** to display the options shown at right. Press **▲** or **▼** to highlight **Vividness** or **Outlines** and press **◀** or **▶** to change.

Vividness can be increased to make colors more saturated, or decreased for a washed-out,

monochromatic effect, while outlines can be made thicker or thinner. Increasing the thickness of the lines also makes colors more saturated.

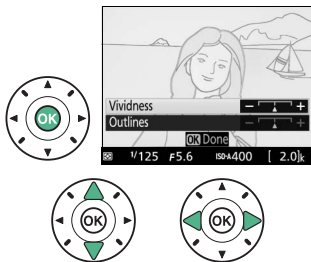

## 3 Press **OK**.

Press **OK** to exit when settings are complete. To exit live view, press the **Lv** button. The selected settings will continue in effect and will apply to photographs taken using the viewfinder.

**1 Select live view.**

Press the **Lv** button. The view through the lens will be displayed in the monitor.

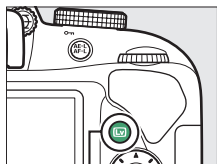

**Lv** button

**2 Adjust options.**

Press **OK** to display the options shown at right. Press **▲** or **▼** to highlight **Vividness** or **Vignetting** and press **◀** or **▶** to change. Adjust vividness to make colors more or less saturated, vignetting to control the amount of vignetting.

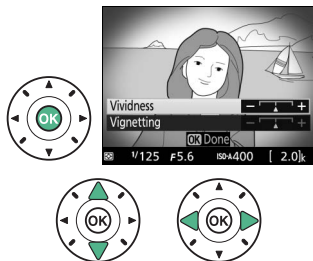

**3 Press **OK**.**

Press **OK** to exit when settings are complete. To exit live view, press the **Lv** button. The selected settings will continue in effect and will apply to photographs taken using the viewfinder.

# 1 Select live view.

Press the **Lv** button. The view through the lens will be displayed in the monitor.

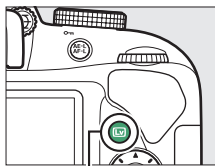

**Lv** button

# 2 Position the focus point.

Use the multi selector to position the focus point in the area that will be in focus and then press the shutter-release button halfway to focus. To temporarily clear miniature effect options from the display and enlarge the view in the monitor for precise focus, press **Q**. Press **Q** (?) to restore the miniature effect display.



# 3 Display options.

Press **OK** to display miniature effect options.

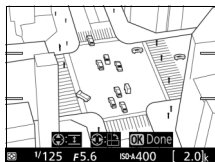

---

## 4 Adjust options.

Press ◀ or ▶ to choose the orientation of the area that will be in focus and press ▲ or ▼ to adjust its width.

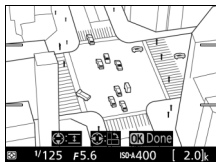

---

## 5 Press **OK**.

Press **OK** to exit when settings are complete. To exit live view, press the **Lv** button. The selected settings will continue in effect and will apply to photographs taken using the viewfinder.

**1 Select live view.**

Press the **Lv** button. The view through the lens will be displayed in the monitor.

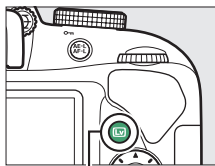

**Lv** button

**2 Display options.**

Press **OK** to display selective color options.

**3 Select a color.**

Frame an object in the white square in the center of the display and press **▲** to choose the color of the object as one that will remain in the final image (the camera may have difficulty detecting unsaturated colors; choose a saturated color). To zoom in on the center of the display for more precise color selection, press **Q**. Press **Q** (?) to zoom out.



*Selected color*



#### 4 Choose the color range.

Press ▲ or ▼ to increase or decrease the range of similar hues that will be included in the final image. Choose from values between 1 and 7; note that higher values may include hues from other colors.



Color range



#### 5 Select additional colors.

To select additional colors, rotate the command dial to highlight another of the three color boxes at the top of the display and repeat Steps 3 and 4 to select

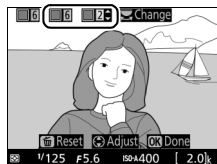

another color. Repeat for a third color if desired. To deselect the highlighted color, press (To remove all colors, press and hold . A confirmation dialog will be displayed; select **Yes**).

#### 6 Press .

Press to exit when settings are complete. During shooting, only objects of the selected hues will be recorded in color; all others will be recorded in black-and-white. To exit live view, press the button. The selected settings will continue in effect and will apply to photographs taken using the viewfinder.

## Easy Panorama

Follow the steps below to shoot panoramas.

### 1 Select live view.

Press the  button. A framing grid and the view through the lens will be displayed in the monitor.

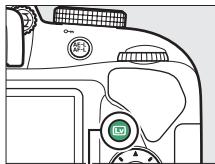



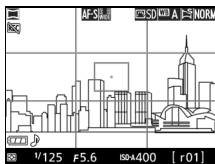

 button

### 2 Focus.

Frame the start of the panorama and press the shutter-release button halfway.



### 3 Start shooting.

Press the shutter-release button the rest of the way and then lift your finger from the button. The display will briefly go dark and then turn on with , , , and  icons indicating the possible pan directions; focus and exposure will lock.

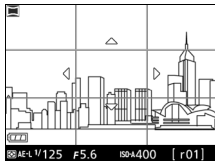
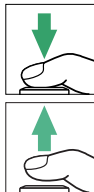

## 4 Pan the camera.

Slowly pan the camera up, down, left, or right as shown below. Shooting will start when the camera detects the pan direction and a progress indicator will appear in the display. Shooting ends automatically when the end of the panorama is reached.

*Progress indicator*

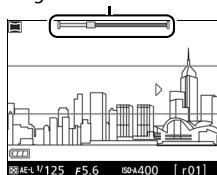

An example of how to pan the camera is shown below. Without changing your position, pan the camera in a steady curve either horizontally or vertically. Time the pan according to the option selected for **Image size** in the shooting menu: about 15 seconds are needed to complete the pan when **Normal panorama** is selected, about 30 seconds when **Wide panorama** is selected.

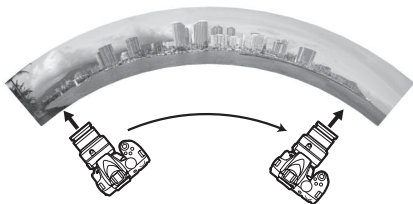



### Panoramas

Panorama size can be selected using the **Image size** item in the shooting menu; choose from **Normal panorama** and **Wide panorama** (☐ 88). An error message will be displayed if the camera is panned too quickly or unsteadily. Note that because panoramas are composed of multiple images, the joins between images may be visible and the desired results may not be achieved with moving subjects or with neon lights or other subjects that exhibit rapid changes in color or brightness, subjects that are too close to the camera, poorly-lit subjects, and subjects such as the sky or sea that are a solid color or contain simple repeating patterns.

Exposure compensation (☐ 118) can be used to adjust exposure by up to  $\pm 3$  EV in steps of  $\frac{1}{3}$  EV. Adjust exposure compensation after starting live view in Step 1.

The completed panorama will be slightly smaller than the area visible in the display during shooting. No panorama will be recorded if shooting ends before the halfway point; if shooting ends after the halfway point but before the panorama is complete, the unrecorded portion will be shown in gray. Dates can not be imprinted on panoramas (☐ 254).

## ■ Viewing Panoramas

To view a panorama, display it in full-frame playback (📖 170) and press **OK**. The start of the panorama will be displayed with the smallest dimension filling the display and the camera will then scroll through the picture in the original pan direction. Your current position is indicated by the navigation window.

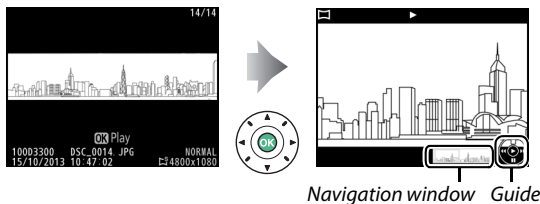





The following operations can be performed:

To	Use	Description
Pause		Pause playback.
Play	<b>OK</b>	Resume playback when the panorama is paused or during rewind/advance.
Advance/rewind		Press <b>◀</b> to rewind, <b>▶</b> to advance. If playback is paused, the panorama rewinds or advances a segment at a time; keep the button pressed for continuous rewind or advance.
Return to full-frame playback		Press <b>▲</b> or <b>▶</b> to exit to full-frame playback.

# More on Photography





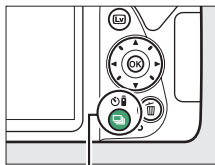

## Choosing a Release Mode

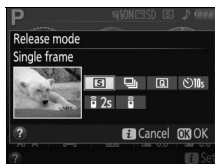
To choose how the shutter is released (release mode), press the  (/) button, then highlight the desired option and press .



 (/) button





Mode	Description
	<b>Single frame:</b> Camera takes one photograph each time shutter-release button is pressed.
	<b>Continuous:</b> The camera takes photographs while the shutter-release button is pressed ( <a href="#">□ 68</a> ).
	<b>Quiet shutter release:</b> As for single-frame, except that camera noise is reduced ( <a href="#">□ 70</a> ).
	<b>Self-timer:</b> Take pictures with the self-timer ( <a href="#">□ 71</a> ).
 2s	<b>Delayed remote (ML-L3):</b> Shutter is released 2 s after shutter-release button on optional ML-L3 remote control is pressed ( <a href="#">□ 97</a> ).
	<b>Quick-response remote (ML-L3):</b> Shutter is released when shutter-release button on optional ML-L3 remote control is pressed ( <a href="#">□ 97</a> ).

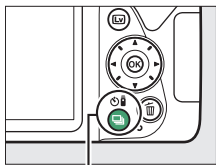

## Continuous Shooting (Burst Mode)

In  (**Continuous**) mode, the camera takes photographs continuously while the shutter-release button is pressed all the way down.

**1** Press the  (/📷) button.



 (/📷) button

**2** Choose  (**Continuous**).  
Highlight  (**Continuous**)  
and press .

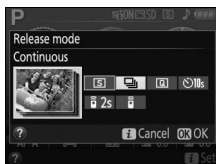

**3** Focus.  
Frame the shot and focus.



**4** Take photographs.  
The camera will take photographs  
while the shutter-release button is  
pressed all the way down.



### **The Memory Buffer**

The camera is equipped with a memory buffer for temporary storage, allowing shooting to continue while photographs are being saved to the memory card. Up to 100 photographs can be taken in succession. Depending on the battery level and the number of images in the buffer, recording may take from a few seconds to a few minutes. If the battery is exhausted while images remain in the buffer, the shutter release will be disabled and the images transferred to the memory card.

### **Frame Rate**

For information on the number of photographs that can be taken in continuous release mode, see page 344. Frame rates may drop when the memory buffer is full or the battery is low.

### **The Built-in Flash**

Continuous release mode can not be used with the built-in flash; rotate the mode dial to  (☞ 25) or turn the flash off (☞ 89).

### **Buffer Size**

The approximate number of images that can be stored in the memory buffer at current settings is shown in the viewfinder exposure-count display while the shutter-release button is pressed.





## Quiet Shutter Release

Choose this mode to keep camera noise to a minimum. A beep does not sound when the camera focuses.

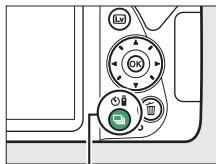
- 1 Press the  (🔇/🔇) button.



 button

- 2 Select  (Quiet shutter release).  
Highlight  (Quiet shutter release) and press .

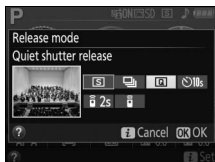

- 3 Press the shutter-release button all the way down.  
Press the shutter-release button all the way down to shoot.





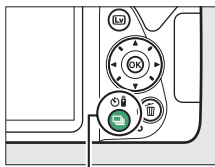

## Self-Timer Mode

The self-timer can be used for self-portraits or group shots that include the photographer. Before proceeding, mount the camera on a tripod or place it on a stable, level surface.

- 1 Press the  (🕒/⏱) button.



 (🕒/⏱) button

- 2 Select  (Self-timer) mode.  
Highlight  (Self-timer) and press .

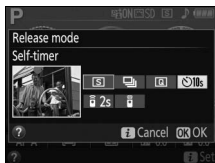

- 3 Frame the photograph.



---

#### **4 Take the photograph.**

Press the shutter-release button halfway to focus, and then press the button the rest of the way down.

The self-timer lamp will start to flash and a beep will

begin to sound. Two seconds before the photo is taken, the lamp will stop flashing and the beeping will become more rapid. The shutter will be released ten seconds after the timer starts.

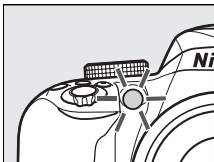

Note that the timer may not start or a photograph may not be taken if the camera is unable to focus or in other situations in which the shutter can not be released. To stop the timer without taking a photograph, turn the camera off.



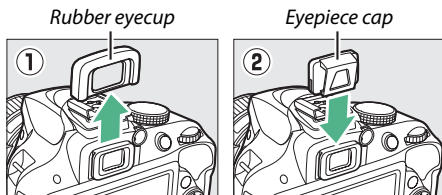

### ✔ Cover the Viewfinder

To prevent light entering via the viewfinder from appearing in the photograph or interfering with exposure, we recommend that you cover the viewfinder with your hand or other objects such as an optional eyepiece cap (☞ 307) when taking pictures without your eye to the viewfinder. To attach the cap, remove the rubber eyecup (①) and insert the cap as shown (②).



### ✔ Using the Built-in Flash

Before taking a photograph with the flash in modes that require the flash to be raised manually, press the  (☞ 31) button to raise the flash and wait for the  indicator to be displayed in the viewfinder (☞ 31). Shooting will be interrupted if the flash is raised after the self-timer has started.

### ✔ The Setup Menu Self-Timer Option

For information on choosing the duration of the self-timer and the number of shots taken, see the **Self-timer** option in the setup menu (☞ 246).

## Focus (Viewfinder Photography)

This section describes the focus options available when photographs are framed in the viewfinder. Focus can be adjusted automatically or manually (see “Choosing How the Camera Focuses: Focus Mode,” below). The user can also select the focus point for automatic or manual focus (☞ 80) or use focus lock to focus to recompose photographs after focusing (☞ 81).

### **Choosing How the Camera Focuses: Focus Mode**

Choose from the following focus modes. Note that **AF-S** and **AF-C** are available only in modes **P, S, A,** and **M**.

Option	Description
<b>AF-A Auto-servo AF</b>	Camera automatically selects single-servo autofocus if subject is stationary, continuous-servo autofocus if subject is moving. Shutter can only be released if camera is able to focus.
<b>AF-S Single-servo AF</b>	For stationary subjects. Focus locks when shutter-release button is pressed halfway. Shutter can only be released if camera is able to focus.
<b>AF-C Continuous-servo AF</b>	For moving subjects. Camera focuses continuously while shutter-release button is pressed halfway. Shutter can only be released if camera is able to focus.
<b>MF Manual focus</b>	Focus manually (☞ 83).

## 1 Display focus mode options.

Press the **i** button, then highlight the current focus mode in the information display and press **OK**.

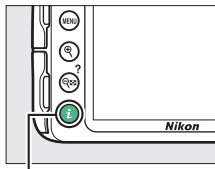

**i** button



## 2 Choose a focus mode.

Highlight a focus mode and press **OK**.



### **✓ Predictive Focus Tracking**

In **AF-C** mode or when continuous-servo autofocus is selected in **AF-A** mode, the camera will initiate predictive focus tracking if the subject moves toward the camera while the shutter-release button is pressed halfway. This allows the camera to track focus while attempting to predict where the subject will be when the shutter is released.

### **✓ Continuous-Servo Autofocus**

In **AF-C** mode or when continuous-servo autofocus is selected in **AF-A** mode, the camera gives higher priority to focus response (has a wider focus range) than in **AF-S** mode, and the shutter may be released before the in-focus indicator is displayed.

## Getting Good Results with Autofocus

Autofocus does not perform well under the conditions listed below. The shutter release may be disabled if the camera is unable to focus under these conditions, or the in-focus indicator (●) may be displayed and the camera may sound a beep, allowing the shutter to be released even when the subject is not in focus. In these cases, focus manually (☐ 83) or use focus lock (☐ 81) to focus on another subject at the same distance and then recompose the photograph.

*There is little or no contrast between the subject and the background.*

**Example:** Subject is the same color as the background.



*The focus point contains areas of sharply contrasting brightness.*

**Example:** Subject is half in the shade.

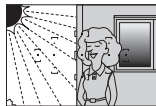

*The focus point contains objects at different distances from the camera.*

**Example:** Subject is inside a cage.



*Background objects appear larger than the subject.*

**Example:** A building is in the frame behind the subject.



*The subject is dominated by regular geometric patterns.*

**Example:** Blinds or a row of windows in a skyscraper.

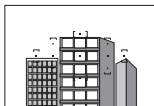

*The subject contains many fine details.*

**Example:** A field of flowers or other subjects that are small or lack variation in brightness.

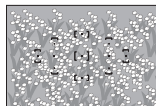

### **The AF-Assist Illuminator**

If the subject is poorly lit, the AF-assist illuminator will light automatically to assist the autofocus operation when the shutter-release button is pressed halfway (some restrictions apply; [□ 331](#)). Note that the illuminator may become hot when used multiple times in quick succession and will turn off automatically to protect the lamp after a period of continuous use. Normal function will resume after a brief pause.

*AF-assist illuminator*

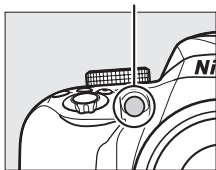

## Choosing How the Focus Point Is Selected:

### AF-Area Mode

Choose how the focus point for autofocus is selected. Note that [AF-LOCK] (**Dynamic-area AF**) and [3D] (**3D-tracking (11 points)**) AF-area modes are not available when **AF-S** is selected for focus mode.

Option	Description
[AF-LOCK] <b>Single-point AF</b>	For stationary subjects. Focus point is selected manually; camera focuses on subject in selected focus point only.
[AF-LOCK] <b>Dynamic-area AF</b>	For non-stationary subjects. <b>In AF-A and AF-C focus modes</b> , user selects focus point using multi selector (□ 80), but camera will focus based on information from surrounding focus points if subject briefly leaves selected point.
[3D] <b>3D-tracking (11 points)</b>	<b>In AF-A and AF-C focus modes</b> , user selects focus point using multi selector (□ 80). If subject moves after camera has focused, camera uses 3D-tracking to select new focus point and keep focus locked on original subject while shutter-release button is pressed halfway.
[AF-ON] <b>Auto-area AF</b>	Camera automatically detects subject and selects focus point.

# 1 Display AF-area mode options.

Press the **i** button, then highlight the current AF-area mode in the information display and press **OK**.

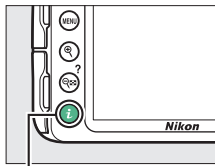

**i** button



# 2 Choose an AF-area mode.

Highlight an option and press **OK**.

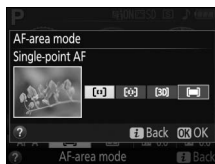

## **AF-Area Mode**

AF-area mode selections made in shooting modes other than **P**, **S**, **A**, or **M** are reset when another shooting mode is selected.

## **3D-Tracking (11 Points)**

If subject leaves the viewfinder, remove your finger from the shutter-release button and recompose the photograph with the subject in the selected focus point. Note that when the shutter-release button is pressed halfway, the colors in the area surrounding the focus point are stored in the camera. Consequently 3D-tracking may not produce the desired results with subjects that are the same color as the background.

## Focus Point Selection

In manual focus mode or when autofocus is combined with AF-area modes other than  (Auto-area AF), you can choose from 11 focus points, making it possible to compose photographs with the main subject almost anywhere in the frame.

- 1 Choose an AF-area mode other than  (Auto-area AF;  78).



- 2 Return to the shooting display. Press  to return to the shooting display.

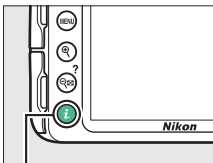

*i button*

- 3 Select the focus point. Use the multi selector to select the focus point in the viewfinder or information display while the exposure meters are on. Press  to select the center focus point.

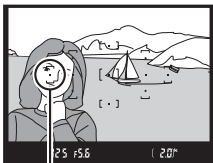

*Focus point*





## Focus Lock

Focus lock can be used to change the composition after focusing in **AF-A**, **AF-S**, and **AF-C** focus modes (☞ 74), making it possible to focus on a subject that will not be in a focus point in the final composition. If the camera is unable to focus using autofocus (☞ 76), focus lock can also be used to recompose the photograph after focusing on another object at the same distance as your original subject. Focus lock is most effective when an option other than **[ ] (Auto-area AF)** is selected for AF-area mode (☞ 78).

### 1 Focus.

Position the subject in the selected focus point and press the shutter-release button halfway to initiate focus. Check that the in-focus indicator (●) appears in the viewfinder.

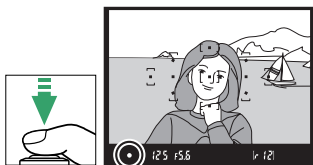

### 2 Lock focus.

**AF-A and AF-C focus modes:** With the shutter-release button pressed halfway (①), press the **AE-L/AF-L (O/n)** button (②) to lock focus. Focus will remain locked while the **AE-L/AF-L (O/n)** button is pressed, even if you later remove your finger from the shutter-release button.

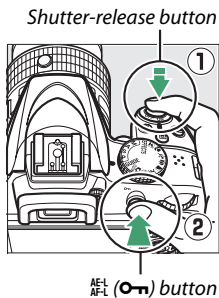

**AF-S focus mode:** Focus will lock automatically when the in-focus indicator appears, and remain locked until you remove your finger from the shutter-release button. Focus can also be locked by pressing the  $\text{AE-L/AF-L}$  ( $\text{O-n}$ ) button (see above).

### 3 Recompose the photograph and shoot.

Focus will remain locked between shots if you keep the shutter-release button pressed halfway (**AF-S**) or keep the  $\text{AE-L/AF-L}$  ( $\text{O-n}$ ) button pressed, allowing several photographs in succession to be taken at the same focus setting.

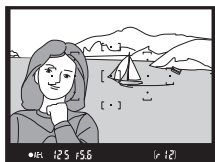

Do not change the distance between the camera and the subject while focus lock is in effect. If the subject moves, focus again at the new distance.

#### Autoexposure Lock

Pressing the  $\text{AE-L/AF-L}$  ( $\text{O-n}$ ) button in Step 2 also locks exposure ( 116).

## Manual Focus

Manual focus can be used when autofocus is not available or does not produce the desired results (📖 76).

---

### 1 Select manual focus.

If the lens is equipped with an A-M, M/A-M, or A/M-M mode switch, slide the switch to **M**.

*A-M mode switch*



*M/A-M mode switch*



If the lens is not equipped a focus-mode switch, select **MF** (manual focus) for **Focus mode** (📖 74).

---

### 2 Focus.

To focus manually, adjust the lens focus ring until the image displayed on the clear matte field in the viewfinder is in focus. Photographs can be taken at any time, even when the image is not in focus.

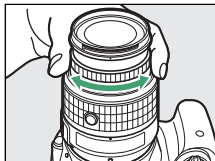

## ■ The Electronic Rangefinder

If the lens has a maximum aperture of  $f/5.6$  or faster, the viewfinder focus indicator can be used to confirm whether the subject in the selected focus point is in focus (the focus point can be selected from any of the 11 focus points). After positioning the subject in the selected focus point, press the shutter-release button halfway and rotate the lens focus ring until the in-focus indicator (●) is displayed. Note that with the subjects listed on page 76, the in-focus indicator may sometimes be displayed when the subject is not in focus; confirm focus in the viewfinder before shooting.



### ✔ Selecting Manual Focus with the Camera

If the lens supports M/A (autofocus with manual override) or A/M (autofocus with manual override/AF priority), manual focus can also be selected by setting the camera focus mode to **MF** (manual focus; □ 74). Focus can then be adjusted manually, regardless of the mode selected with the lens.

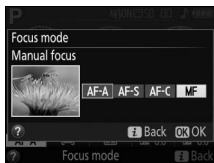

### ✔ Focal Plane Position

The position of the focal plane is indicated by the focal plane mark on the camera body. The distance between the lens mounting flange and the focal plane is 46.5 mm (1.83 in.).

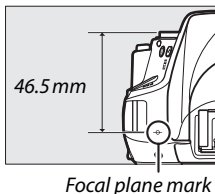

## Image Quality and Size

Together, image quality and size determine how much space each photograph occupies on the memory card. Larger, higher quality images can be printed at larger sizes but also require more memory, meaning that fewer such images can be stored on the memory card (📖 367).

### Image Quality

Choose a file format and compression ratio (image quality).

Option	File type	Description
<b>NEF (RAW) + JPEG fine</b>	NEF/JPEG	Two images are recorded: one NEF (RAW) image and one fine-quality JPEG image.
<b>NEF (RAW)</b>	NEF	Raw 12-bit data from the image sensor are saved directly to the memory card. Settings such as white balance and contrast can be adjusted after shooting.
<b>JPEG fine</b>	JPEG	Record JPEG images at a compression ratio of roughly 1 : 4 (fine quality).
<b>JPEG normal</b>		Record JPEG images at a compression ratio of roughly 1 : 8 (normal quality).
<b>JPEG basic</b>		Record JPEG images at a compression ratio of roughly 1 : 16 (basic quality).

# 1 Display image quality options.

Press the **i** button, then highlight the current image quality in the information display and press **OK**.

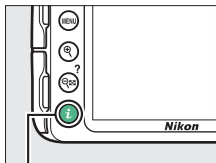

*i* button



# 2 Choose a file type.

Highlight an option and press **OK**.

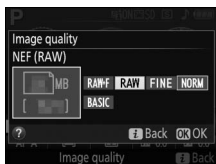

## NEF (RAW) Images

Note that the option selected for image size does not affect the size of NEF (RAW) or NEF (RAW)+JPEG images. **Print date** (☐ 254) is not available at image quality settings of NEF (RAW) or NEF (RAW)+JPEG.



NEF (RAW) images can be viewed on the camera or using software such as Capture NX 2 (available separately; ☐ 307) or ViewNX 2 (supplied). JPEG copies of NEF (RAW) images can be created using the **NEF (RAW) processing** option in the retouch menu (☐ 275).

## NEF (RAW) + JPEG

When photographs taken at **NEF (RAW) + JPEG fine** are viewed on the camera, only the JPEG image will be displayed. When photographs taken at these settings are deleted, both NEF and JPEG images will be deleted.

## Image Size

Choose a size for JPEG images:

Image size	Size (pixels)	Print size (cm/in.)*
 <b>Large</b>	6000 × 4000	50.8 × 33.9/20 × 13.3
 <b>Medium</b>	4496 × 3000	38.1 × 25.4/15.0 × 10
 <b>Small</b>	2992 × 2000	25.3 × 16.9/10 × 6.7

\* Approximate size when printed at 300 dpi. Print size in inches equals image size in pixels divided by printer resolution in dots per inch (dpi); 1 inch=approximately 2.54 cm).

### 1 Display image size options.

Press the **i** button, then highlight the current image size in the information display and press **OK**.

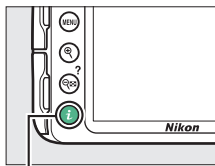

**i** button



### 2 Choose an image size.

Highlight an option and press **OK**.



### Easy Panorama

The following options are available in  mode (p. 63).

Image size	Size (pixels)*	Print size (cm/in.)†
<b>Normal panorama</b>	Camera panned horizontally: 4800 × 1080	40.6 × 9.1/16.0 × 3.6
	Camera panned vertically: 1632 × 4800	13.8 × 40.6/5.4 × 16.0
<b>Wide panorama</b>	Camera panned horizontally: 9600 × 1080	81.3 × 9.1/32.0 × 3.6
	Camera panned vertically: 1632 × 9600	13.8 × 81.3/5.4 × 32.0

\* Figures for horizontal and vertical panorama are reversed if camera is rotated 90 degrees.









† Approximate size when printed at 300 dpi. Print size in inches equals image size in pixels divided by printer resolution in dots per inch (dpi); 1 inch=approximately 2.54 cm).





## Using the Built-in Flash

The camera supports a variety of flash modes for photographing poorly lit or backlit subjects.



### Auto Pop-up Modes

In , , , , , , **VI**, **POP**, , , and  modes, the built-in flash automatically pops up and fires as required.

#### 1 Choose a flash mode.

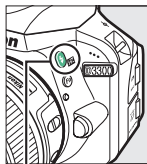
Keeping the  () button pressed, rotate the command dial until the desired flash mode appears in the information display.



 () button

+



Command dial



Information display

#### 2 Take pictures.



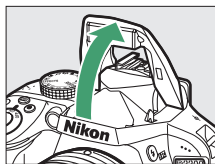

The flash will pop up as required when the shutter-release button is pressed halfway, and fire when a photograph is taken. *If the flash does not pop up*

*automatically, DO NOT attempt to raise it by hand. Failure to observe this precaution could damage the flash.*



## ■ Flash Modes

The following flash modes are available:

- **⚡ AUTO** (auto): When lighting is poor or the subject is backlit, the flash pops up automatically when the shutter-release button is pressed halfway and fires as required. Not available in  mode.
- **⚡👁️ AUTO** (auto + red-eye reduction): Use for portraits. The flash pops up and fires as required, but before it fires the red-eye reduction lamp lights to help reduce “red-eye.” Not available in  mode.
- **🚫** (flash off): The flash does not fire.
- **⚡👁️ AUTO SLOW** (auto slow sync + red-eye): As for auto with red-eye reduction, except that slow shutter speeds are used to capture background lighting. Use for portraits taken at night or under low light. Available in  mode.
- **⚡ AUTO SLOW** (auto slow sync): Slow shutter speeds are used to capture background lighting in shots taken at night or under low light. Available in  mode.

### The Information Display

Flash mode can also be selected in the information display.

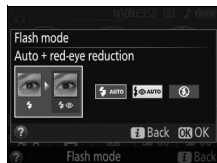



## Manual Pop-up Modes

In **P, S, A, M** modes, the flash must be raised manually. The flash will not fire if it is not raised.

### 1 Raise the flash.

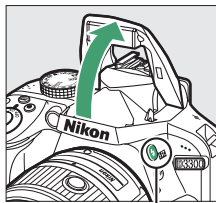
Press the  button to raise the flash.



 button

### 2 Choose a flash mode.

Keeping the  button pressed, rotate the command dial until the desired flash mode appears in the information display.

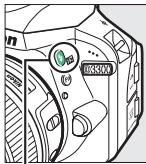

 button

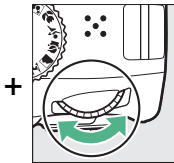

Command dial



Information display

### 3 Take pictures.

The flash will fire whenever a picture is taken.

## ■ Flash Modes

The following flash modes are available:

- **⚡** (fill flash): The flash fires with every shot.
- **⚡👁** (red-eye reduction): Use for portraits. The flash fires with every shot, but before it fires, the red-eye reduction lamp lights to help reduce “red-eye.”
- **⚡👁SLOW** (slow sync + red-eye): As for “red-eye reduction”, above, except that shutter speed slows automatically to capture background lighting at night or under low light. Use when you want to include background lighting in portraits. Not available in modes **S** and **M**.
- **⚡SLOW** (slow sync): As for “fill flash”, above, except that shutter speed slows automatically to capture background lighting at night or under low light. Use when you want to capture both subject and background. Not available in modes **S** and **M**.
- **⚡SLOW REAR** (rear curtain + slow sync): As for “rear-curtain sync”, below, except that shutter speed slows automatically to capture background lighting at night or under low light. Use when you want to capture both subject and background. Not available in modes **S** and **M**.
- **⚡REAR** (rear-curtain sync): The flash fires just before the shutter closes, creating a stream of light behind moving light sources as shown below at right. Not available in modes **P** and **A**.



*Front-curtain sync*



*Rear-curtain sync*

### Lowering the Built-in Flash

To save power when the flash is not in use, press it gently downward until the latch clicks into place.

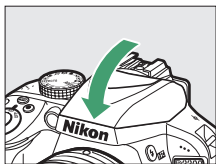

### The Built-in Flash

For information on the lenses that can be used with the built-in flash, see page 295. Remove lens hoods to prevent shadows. The flash has a minimum range of 0.6 m (2 ft) and can not be used in the macro range of zoom lenses with a macro function.

The shutter release may be briefly disabled to protect the flash after it has been used for several consecutive shots. The flash can be used again after a short pause.

### Shutter Speeds Available with the Built-in Flash

Shutter speed is restricted to the following ranges when the built-in flash is used:

Mode	Shutter speed	Mode	Shutter speed
AUTO,  ,  ,  ,  , VI, POP,  ,  ,  , P, A	$\frac{1}{200}$ – $\frac{1}{60}$ s	S	$\frac{1}{200}$ –30 s
	$\frac{1}{200}$ –1 s	M	$\frac{1}{200}$ –30 s, Bulb, Time

Shutter speeds as slow as  $\frac{1}{30}$  s are available in mode when vibration reduction is on. Shutter speeds as slow as 30 s are available in modes P and A when slow sync, rear curtain + slow sync, or slow sync + red-eye reduction is selected.





### Aperture, Sensitivity, and Flash Range

Flash range varies with sensitivity (ISO equivalency) and aperture.

Aperture at ISO equivalent of								Approximate range	
100	200	400	800	1600	3200	6400	12800	m	ft
1.4	2	2.8	4	5.6	8	11	16	1.0–8.5	3 ft 3 in.–27 ft 11 in.
2	2.8	4	5.6	8	11	16	22	0.7–6.0	2 ft 4 in.–19 ft 8 in.
2.8	4	5.6	8	11	16	22	32	0.6–4.2	2 ft–13 ft 9 in.
4	5.6	8	11	16	22	32	—	0.6–3.0	2 ft–9 ft 10 in.
5.6	8	11	16	22	32	—	—	0.6–2.1	2 ft–6 ft 11 in.
8	11	16	22	32	—	—	—	0.6–1.5	2 ft–4 ft 11 in.
11	16	22	32	—	—	—	—	0.6–1.1	2 ft–3 ft 7 in.
16	22	32	—	—	—	—	—	0.6–0.7	2 ft–2 ft 4 in.

## ISO Sensitivity

The camera's sensitivity to light can be adjusted according to the amount of light available. The higher the ISO sensitivity, the less light needed to make an exposure, allowing higher shutter speeds or smaller apertures. Noise (randomly-spaced bright pixels, fog, or lines) is however more likely at a setting of Hi 1, which is equivalent to ISO 25600). Choosing **Auto** allows the camera to set ISO sensitivity automatically in response to lighting conditions; to use auto in **P**, **S**, **A**, and **M** modes, select **Auto ISO sensitivity control** for the **ISO sensitivity settings** item in the shooting menu (☞ 227).

Mode	ISO sensitivity
AUTO,  ,  ,  , 	Auto
<b>P, S, A, M</b>	100–12800 in steps of 1 EV; Hi 1
Other shooting modes	Auto; 100–12800 in steps of 1 EV; Hi 1

### 1 Display ISO sensitivity options.

Press the **i** button, then highlight the current ISO sensitivity in the information display and press **OK**.

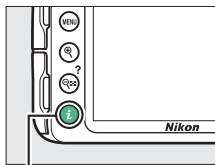

**i** button



- 
- 2 Choose an ISO sensitivity.**  
Highlight an option and  
press .

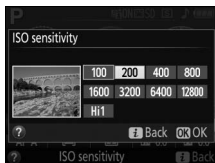





## Remote Control Photography

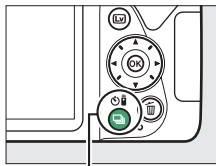

### Using an Optional ML-L3 Remote Control

The optional ML-L3 remote control (📖 308) can be used to reduce camera shake or for self-portraits. Before proceeding, mount the camera on a tripod or place it on a stable, level surface.

- 1 Press the  (🔍/📷) button.



 (🔍/📷) button

- 2 Select a remote control mode.  
Highlight  2s (**Delayed remote (ML-L3)**) or  (**Quick-response remote (ML-L3)**) and press .

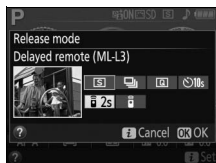

---

### 3 Frame the photograph.

Check focus by pressing the shutter-release button halfway.



---

### 4 Take the photograph.

From a distance of 5 m (16 ft) or less, aim the transmitter on the ML-L3 at either of the infrared receivers on the camera (□ 1, 2) and press the ML-L3 shutter-release button. *In delayed remote mode*, the self-timer lamp will light for about two seconds before the shutter is released. *In quick-response remote mode*, the self-timer lamp will flash after the shutter has been released.

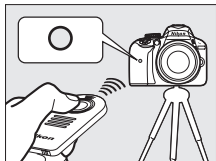

Note that the timer may not start or a photograph may not be taken if the camera is unable to focus or in other situations in which the shutter can not be released.

#### Before Using the ML-L3 Remote Control

Before using the ML-L3 for the first time, remove the clear plastic battery-insulator sheet.

#### Cover the Viewfinder

To prevent light entering via the viewfinder from appearing in the photograph or interfering with exposure, we recommend that you cover the viewfinder with your hand or other objects such as an optional eyepiece cap (□ 307) before taking pictures without your eye to the viewfinder (□ 73).



### ✔ The Camera Shutter-Release Button/Other Remote Control Devices

If an ML-L3 remote release mode is selected and the shutter is released by any means other than an ML-L3 remote control (for example, the camera shutter-release button or the shutter button on an optional remote cord or wireless remote controller), the camera will function in single-frame release mode.

### ✔ Exiting Remote Control Mode

Remote control mode is cancelled automatically if no photograph is taken before the time selected for **Remote on duration (ML-L3)** option in the setup menu (☐ 247). Remote control mode will also be cancelled if the camera is turned off or shooting options are reset using **Reset shooting menu**.

### ✔ Using the Built-in Flash

Before taking a photograph with the flash in manual pop-up modes (☐ 91), press the  button to raise the flash and wait for the  indicator to be displayed in the viewfinder (☐ 31). Shooting will be interrupted if the flash is raised after the shutter-release button on the ML-L3 is pressed. If the flash is required, the camera will only respond to the ML-L3 shutter-release button once the flash has charged. In auto pop-up modes, the flash will begin charging when a remote control mode is selected; once the flash is charged, it will automatically pop up and fire when required.

### ✔ Wireless Remote Controllers

Remote control is also available with various combinations of WR-R10, WR-T10, and WR-1 wireless remote controllers (☐ 308), when the shutter-release buttons on the wireless remote controllers perform the same functions as the camera shutter-release button. For more information, see the manual provided with the remote controllers.

# P, S, A, and M Modes

## Shutter Speed and Aperture

P, S, A, and M modes offer different degrees of control over shutter speed and aperture:



Mode		Description
<b>P</b>	Programmed auto (☞ 102)	Recommended for snapshots and in other situations in which there is little time to adjust camera settings. Camera sets shutter speed and aperture for optimal exposure.
<b>S</b>	Shutter-priority auto (☞ 104)	Use to freeze or blur motion. User chooses shutter speed; camera selects aperture for best results.
<b>A</b>	Aperture-priority auto (☞ 106)	Use to blur background or bring both foreground and background into focus. User chooses aperture; camera selects shutter speed for best results.
<b>M</b>	Manual (☞ 108)	User controls both shutter speed and aperture. Set shutter speed to “Bulb” or “Time” for long time-exposures.

## ✓ Shutter Speed and Aperture

Shutter speed and aperture are shown in the viewfinder and information display.

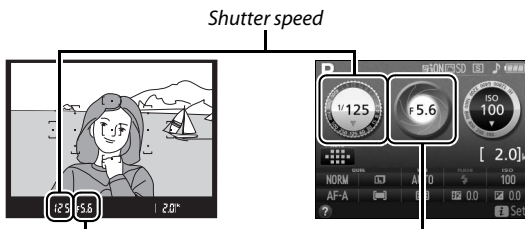

Shutter speed

Aperture



*Fast shutter speeds ( $1/1600$  s in this example) freeze motion.*

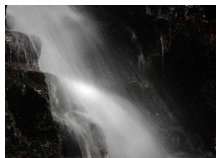

*Slow shutter speeds (here 1 s) blur motion.*



*Large apertures (such as  $f/5.6$ ; remember, the lower the  $f$ -number, the larger the aperture) blur details in front of and behind the main subject.*



*Small apertures ( $f/22$  in this case) bring both background and foreground into focus.*

## **Mode P (Programmed Auto)**

This mode is recommended for snapshots or whenever you want to leave the camera in charge of shutter speed and aperture. The camera automatically adjusts shutter speed and aperture for optimal exposure in most situations.

*Mode dial*

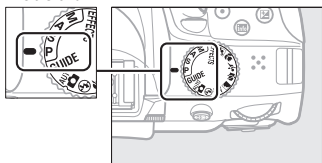

To take pictures in programmed auto mode, rotate the mode dial to **P**.

## Flexible Program

In mode **P**, different combinations of shutter speed and aperture can be selected by rotating the command dial (“flexible program”). Rotate the dial right for large apertures (low f-numbers) and fast shutter speeds, left for small apertures (high f-numbers) and slow shutter speeds. All combinations produce the same exposure.

Rotate right to blur background details or freeze motion.

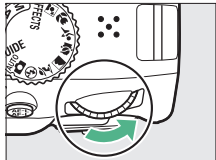

*Command dial*

Rotate left to increase depth of field or blur motion.

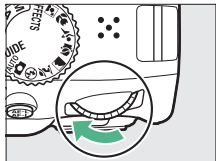

While flexible program is in effect, a **P<sup>+</sup>** indicator appears in the viewfinder and information display. To restore default shutter speed and aperture settings, rotate the command dial until the indicator is no longer displayed, choose another mode, or turn the camera off.



## **Mode S (Shutter-Priority Auto)**

This mode lets you control shutter speed: choose fast shutter speeds to “freeze” motion, slow shutter speeds to suggest motion by blurring moving objects. The camera automatically adjusts aperture for optimal exposure.



*Fast shutter speeds (e.g.,  $1/1600$  s) freeze motion.*

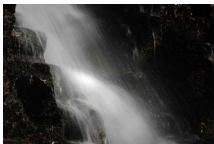

*Slow shutter speeds (e.g., 1 s) blur motion.*

To choose a shutter speed:

**1** Rotate the mode dial to **S**.

Mode dial

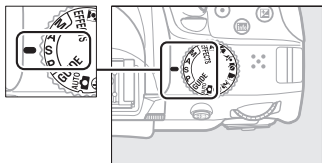



## 2 Choose a shutter speed.

Rotate the command dial to choose the desired shutter speed: rotate right for faster speeds, left for slower speeds.

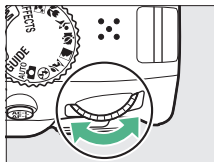

*Command dial*



## **Mode A (Aperture-Priority Auto)**

In this mode, you can adjust aperture to control depth of field (the distance in front of and behind the main subject that appears to be in focus). The camera automatically adjusts shutter speed for optimal exposure.



*Large apertures (low f-numbers, e.g. f/5.6) blur details in front of and behind the main subject.*



*Small apertures (high f-numbers, e.g. f/22) bring the foreground and background into focus.*

To choose an aperture:

**1** Rotate the mode dial to A.

Mode dial

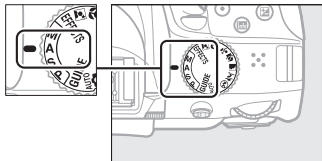

## 2 Choose an aperture.

Rotate the command dial left for larger apertures (lower f-numbers), right for smaller apertures (higher f-numbers).

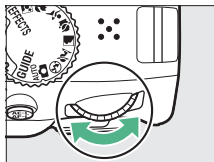

*Command dial*



## **Mode M (Manual)**



In manual mode, you control both shutter speed and aperture. Shutter speeds of “Bulb” and “Time” are available for long time-exposures of moving lights, the stars, night scenery, or fireworks (📖 110).

---

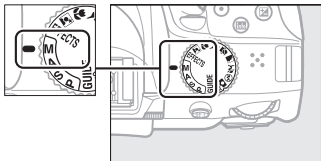
- 1** Rotate the mode dial to M. *Mode dial*



## 2 Choose aperture and shutter speed.

Checking the exposure indicator (see below), adjust shutter speed and aperture. Shutter speed is selected by rotating the command dial (right for faster speeds, left for slower). To adjust aperture, keep the  () button pressed while rotating the command dial (left for larger apertures/lower f-numbers and right for smaller apertures/higher f-numbers).

*Shutter speed*



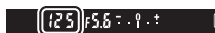

Command dial

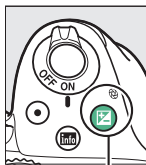

*Aperture*



 () button



Command dial



### The Exposure Indicator

If a CPU lens is attached ( 289) and a shutter speed other than “Bulb” or “Time” is selected, the exposure indicator in the viewfinder and information display shows whether the photograph would be under- or over-exposed at current settings.

Optimal exposure	Underexposed by $\frac{1}{3}$ EV	Overexposed by over 2 EV
- . 0 . +	- . 0 . +	- . 0  +

## Long Time-Exposures (M Mode Only)

Select the following shutter speeds for long time-exposures of moving lights, the stars, night scenery, or fireworks.

- **Bulb** (b, L, b): The shutter remains open while the shutter-release button is pressed all the way down. To prevent blur, use a tripod or an optional wireless remote controller (☞ 308) or remote cord (☞ 309).
- **Time** (- -): Start the exposure using the shutter-release button on the camera or on an optional remote control, remote cord, or wireless remote controller. The shutter remains open for thirty minutes or until the button is pressed a second time.



*Length of exposure: 35 s*

*Aperture: f/25*

Before proceeding, mount the camera on a tripod or place it on a stable, level surface. To prevent light entering via the viewfinder from appearing in the photograph or interfering with exposure, we recommend that you cover the viewfinder with your hand or other objects such as an optional eyepiece cap (☞ 307) before taking pictures without your eye to the viewfinder (☞ 73). To prevent loss of power before the exposure is complete, use a fully charged battery. Note that noise (bright spots, randomly-spaced bright pixels, or fog) may be present in long exposures; before shooting, choose **On** for **Noise reduction** in the shooting menu (☞ 226).

---

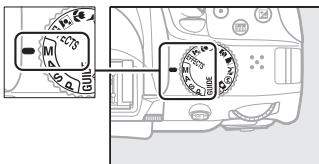
**1 Rotate the mode dial to M.** *Mode dial*

---

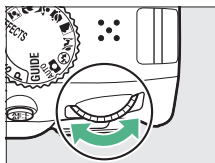
**2 Choose the shutter speed.**  
Rotate the command dial to choose a shutter speed of Bulb (**b u l b**).*Command dial*

---

**3 Take the photograph.**  
After focusing, press the shutter-release button on the camera, optional wireless remote controller or remote cord all the way down. Take your finger from the shutter-release button when the exposure is complete.

- 1** Rotate the mode dial to M. *Mode dial*

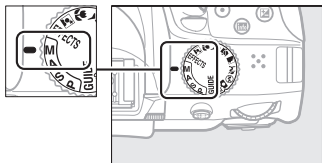

- 2** Choose the shutter speed.  
Rotate the command dial left to choose a shutter speed of "Time" (- -).

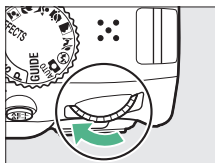

*Command dial*



- 3** Open the shutter.  
After focusing, press the shutter-release button on the camera or optional remote control, remote cord, or wireless remote controller all the way down.







---

## 4 Close the shutter.

Repeat the operation performed in Step 3 (shooting ends automatically if the button is not pressed after 30 minutes).



### ML-L3 Remote Controls

If you will be using an ML-L3 remote control, select one of the following remote control modes as described on page 97:  2s (**Delayed remote (ML-L3)**) or  (**Quick-response remote (ML-L3)**). Note that if you are using an ML-L3 remote control, pictures will be taken in “Time” mode even when “Bulb”/   is selected for shutter speed.

# Exposure

## Metering

Choose how the camera sets exposure.

Method	Description
 <b>Matrix metering</b>	Produces natural results in most situations. The camera meters a wide area of the frame and sets exposure according to tone distribution, color, composition, and distance.
 <b>Center-weighted metering</b>	Classic meter for portraits. Camera meters entire frame but assigns greatest weight to center area. Recommended when using filters with an exposure factor (filter factor) over 1x.
 <b>Spot metering</b>	Choose this mode to ensure that subject will be correctly exposed, even when background is much brighter or darker. Camera meters current focus point; use to meter off-center subjects.

# 1 Display metering options.

Press the **i** button, then highlight the current metering method in the information display and press **OK**.

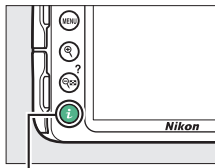

*i* button





# 2 Choose a metering method.





Highlight an option and press **OK**.



## Spot Metering

If  (**Auto-area AF**) is selected for AF-area mode during viewfinder photography ( 78), the camera will meter the center focus point.

## Autoexposure Lock

Use autoexposure lock to recompose photographs after using  (**Center-weighted metering**) and  (**Spot metering**) to meter exposure; note that autoexposure lock is not available in  or  mode.

### 1 Meter exposure.

Press the shutter-release button halfway.



### 2 Lock exposure.

With the shutter-release button pressed halfway (1) and the subject positioned in the focus point, press the  (**AE-L**) button (2) to lock exposure.

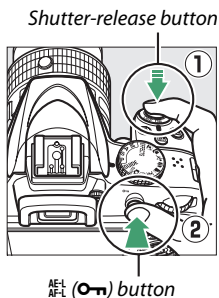

While exposure lock is in effect, an **AE-L** indicator will appear in the viewfinder.



### 3 Recompose the photograph.

Keeping the  $\text{AE-L/AF-L}$  (O) button pressed, recompose the photograph and shoot.

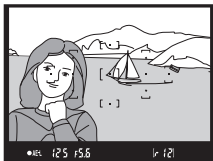



#### Adjusting Shutter Speed and Aperture

While exposure lock is in effect, the following settings can be adjusted without altering the metered value for exposure:

Mode	Setting
Programmed auto	Shutter speed and aperture (flexible program;  103)
Shutter-priority auto	Shutter speed
Aperture-priority auto	Aperture

The metering method itself can not be changed while exposure lock is in effect.

## Exposure Compensation

Exposure compensation is used to alter exposure from the value suggested by the camera, making pictures brighter or darker (📖 345). It is most effective when used with  (**Center-weighted metering**) or  (**Spot metering**) (📖 114).







*-1 EV*



*No exposure compensation*



*+1 EV*

To choose a value for exposure compensation, keep the  () button pressed and rotate the command dial until the desired value is selected in the viewfinder or information display. Normal exposure can be restored by setting exposure compensation to  $\pm 0$  (adjustments to exposure compensation in  and  modes will be reset when another mode is selected). Exposure compensation is not reset when the camera is turned off.

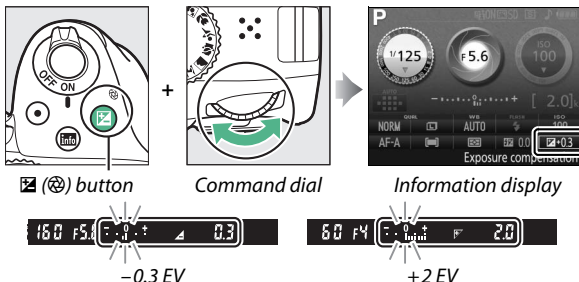

### The Information Display

Exposure compensation options can also be accessed from the information display ( 9).



### Mode M

In mode **M**, exposure compensation affects only the exposure indicator.

### Using a Flash

When a flash is used, exposure compensation affects both background exposure and flash level.

## Flash Compensation

Flash compensation is used to alter flash output from the level suggested by the camera, changing the brightness of the main subject relative to the background. Flash output can be increased to make the main subject appear brighter, or reduced to prevent unwanted highlights or reflections (📖 347).

Keep the ⚡ (📷) and 📷 (📷) buttons pressed and rotate the command dial until the desired value is selected in the viewfinder or information display. In general, positive values make the main subject seem brighter while negative values make it seem darker. Normal flash output can be restored by setting flash compensation to  $\pm 0$ . Flash compensation is not reset when the camera is turned off.

⚡ (📷) button

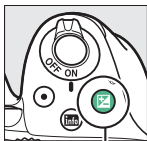
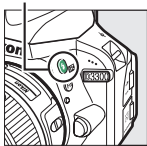

📷 (📷) button

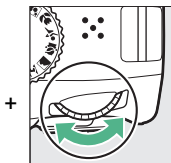

Command dial



Information display



-0.3 EV



+1 EV



### **The Information Display**

Flash compensation options can also be accessed from the information display ( 9).

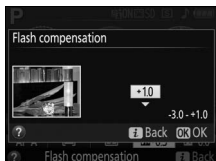



### **Optional Flash Units**

Flash compensation is also available with optional flash units that support the Nikon Creative Lighting System (CLS; see page 300). The flash compensation selected with the optional flash unit is added to the flash compensation selected with the camera.

## Preserving Detail in Highlights and Shadows

### Active D-Lighting

Active D-Lighting preserves details in highlights and shadows, creating photographs with natural contrast. Use for high contrast scenes, for example when photographing brightly lit outdoor scenery through a door or window or taking pictures of shaded subjects on a sunny day. Active D-Lighting is not recommended in mode **M**; in other modes, it is most effective when used with  (**Matrix metering**;  114).



Active D-Lighting: **Off**



Active D-Lighting: **On**

- 1 Display Active D-Lighting options.** Press the **MENU** button to display the menus. Highlight **Active D-Lighting** in the shooting menu and press **▶**.

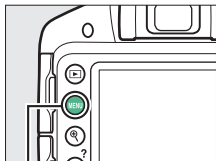

**MENU** button



- 2 Choose an option.**  
Highlight **On** or **Off** and  
press **OK** (☰ 345).

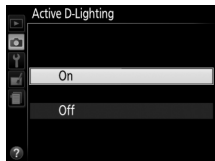

**✓ Active D-Lighting**







Noise (randomly-spaced bright pixels, fog, or lines) may appear in photographs taken with Active D-Lighting. Uneven shading may be visible with some subjects. Active D-Lighting can not be used at an ISO sensitivity of Hi 1.

**✓ “Active D-Lighting” Versus “D-Lighting”**

**Active D-Lighting** adjusts exposure before shooting to optimize the dynamic range, while the **D-Lighting** option in the retouch menu (☰ 266) brightens shadows in images after shooting.

## White Balance

White balance ensures that colors are unaffected by the color of the light source. Auto white balance is recommended for most light sources; other values can be selected if necessary according to the type of source:

Option	Description
AUTO <b>Auto</b>	Automatic white balance adjustment. Recommended in most situations.
 <b>Incandescent</b>	Use under incandescent lighting.
 <b>Fluorescent</b>	Use with the light sources listed on page 126.
 <b>Direct sunlight</b>	Use with subjects lit by direct sunlight.
 <b>Flash</b>	Use with the flash.
 <b>Cloudy</b>	Use in daylight under overcast skies.
 <b>Shade</b>	Use in daylight with subjects in the shade.
PRE <b>Preset manual</b>	Measure white balance or copy white balance from existing photo (□ 129).

# 1 Display white balance options.

Press the **i** button, then highlight the current white balance setting in the information display and press **OK**.

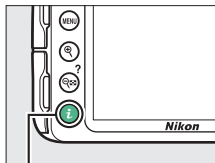

**i** button

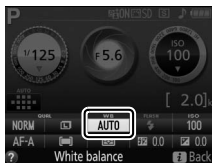

# 2 Choose a white balance option.

Highlight an option and press **OK**.

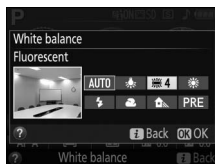

## The Shooting Menu





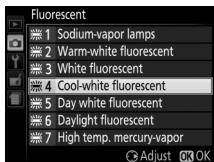
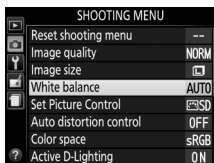







White balance can be selected using the **White balance** option in the shooting menu (☐ 222), which also can be used to fine-tune white balance (☐ 127) or measure a value for preset white balance (☐ 129).

The  **Fluorescent** option in the **White balance** menu can be used to select the light source from the bulb types shown at right.



## Color Temperature

The perceived color of a light source varies with the viewer and other conditions. Color temperature is an objective measure of the color of a light source, defined with reference to the temperature to which an object would have to be heated to radiate light in the same wavelengths. While light sources with a color temperature in the neighborhood of 5000–5500 K appear white, light sources with a lower color temperature, such as incandescent light bulbs, appear slightly yellow or red. Light sources with a higher color temperature appear tinged with blue. The camera white balance options are adapted to the following color temperatures (all figures are approximate):

-  (sodium-vapor lamps): **2700 K**
-  (incandescent)/  
•  (warm-white fluorescent): **3000 K**
-  (white fluorescent): **3700 K**
-  (cool-white fluorescent): **4200 K**
-  (day white fluorescent): **5000 K**
-  (direct sunlight): **5200 K**
-  (flash): **5400 K**
-  (cloudy): **6000 K**
-  (daylight fluorescent): **6500 K**
-  (high temp. mercury-vapor): **7200 K**
-  (shade): **8000 K**

## Fine-Tuning White Balance

White balance can be “fine-tuned” to compensate for variations in the color of the light source or to introduce a deliberate color cast into an image. White balance is fine-tuned using the **White balance** option in the shooting menu.

### 1 Select a white balance option.

Press **MENU** to display the menus, then highlight **White balance** in the shooting menu and press **▶**. Highlight the desired white balance option and press **▶** (if **Fluorescent** is selected, highlight the desired lighting type and press **▶**; note that fine-tuning is not available with **Preset manual**).

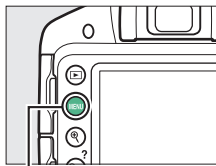

MENU button

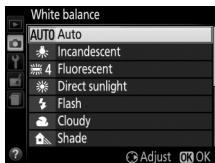

## 2 Fine-tune white balance.

Use the multi selector to fine-tune white balance.

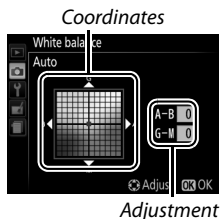
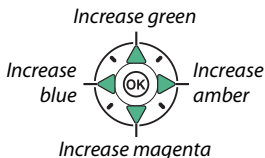

### White Balance Fine-Tuning

The colors on the fine-tuning axes are relative, not absolute. For example, moving the cursor to **B** (blue) when a “warm” setting such as  (incandescent) is selected will make photographs slightly “colder” but will not actually make them blue.

## 3 Save changes and exit.

Press .





## Preset Manual

Preset manual is used to record and recall custom white balance settings for shooting under mixed lighting or to compensate for light sources with a strong color cast. Two methods are available for setting preset white balance:

Method	Description
Measure	Neutral gray or white object is placed under lighting that will be used in final photo and white balance measured by camera (see below).
Use photo	White balance is copied from photo on memory card (☞ 133).

### ■ ■ Measuring a Value for Preset White Balance

#### 1 Light a reference object.

Place a neutral gray or white object under the lighting that will be used in the final photograph.

#### 2 Display white balance options.

To display the menus, press the **MENU** button. Highlight **White balance** in the shooting menu and press **▶** to display white balance options. Highlight **Preset manual** and press **▶**.

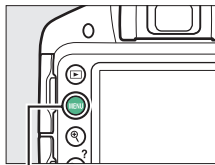

MENU button

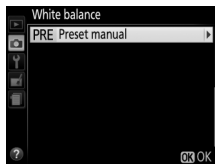

- 3 Select Measure.**  
Highlight **Measure** and press **▶**.

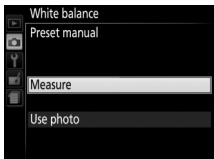

- 4 Select Yes.**  
The menu shown at right will be displayed; highlight **Yes** and press **OK**.

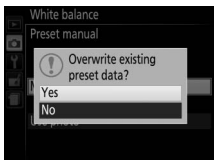

The camera will enter preset measurement mode.

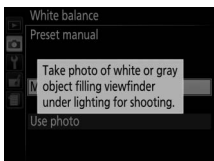

When the camera is ready to measure white balance, a flashing **P-r-E** (PRE) will appear in the viewfinder and information display.



## 5 Measure white balance.

Before the indicators stop flashing, frame the reference object so that it fills the viewfinder and press the shutter-release button all the way down. No photograph will be recorded; white balance can be measured accurately even when the camera is not in focus.



## 6 Check the results.

If the camera was able to measure a value for white balance, the message shown at right will be displayed and **∞d** will flash in the viewfinder for about eight seconds before the camera returns to shooting mode. To return to shooting mode immediately, press the shutter-release button halfway.

If lighting is too dark or too bright, the camera may be unable to measure white balance. A message will appear in the information display and a flashing **no ∞d** will appear in the viewfinder for about eight seconds. Return to Step 5 and measure white balance again.

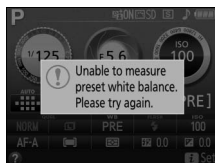

### ✔ Measuring Preset White Balance

If no operations are performed while the displays are flashing, direct measurement mode will end in the time selected for the **Auto off timers** option in the setup menu (☞ 245). The default setting is eight seconds.

### ✔ Preset White Balance

The camera can store only one value for preset white balance at a time; the existing value will be replaced when a new value is measured.

Note that exposure is automatically increased by 1 EV when measuring white balance; when shooting in mode **M**, adjust exposure so that the exposure indicator shows  $\pm 0$  (☞ 109).

### ✔ Other Methods for Measuring Preset White Balance

To enter preset measurement mode (see above) after selecting preset white balance in the information display (☞ 125), press **OK** for a few seconds. If white balance has been assigned to the **Fn** button (☞ 251), white balance preset measurement mode can be activated by keeping the **Fn** button pressed for a few seconds after selecting preset white balance with the **Fn** button and command dial.

### ✔ Gray Panels

For more precise results, measure white balance using a standard gray panel.

## ■ ■ Copying White Balance from a Photograph

Follow the steps below to copy a value for white balance from a photograph on the memory card.

### 1 Select **Preset manual**.

To display the menus, press the **MENU** button. Highlight **White balance** in the shooting menu and press **▶** to display white balance options. Highlight **Preset manual** and press **▶**.

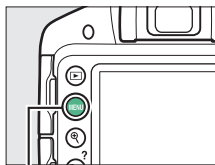

MENU button

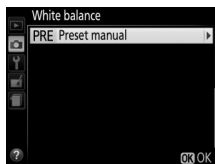

### 2 Select **Use photo**.

Highlight **Use photo** and press **▶**.

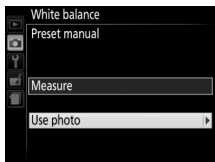



### 3 Choose **Select image**.

Highlight **Select image** and press **▶** (to skip the remaining steps and use the image last selected for preset white balance, select **This image**).

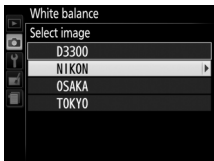

- 
- 4 Choose a folder.**  
Highlight the folder containing the source image and press ►.



- 
- 5 Highlight the source image.**  
To view the highlighted image full frame, press and hold the  button.

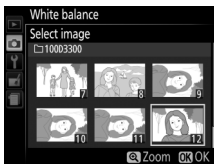

- 
- 6 Copy white balance.**  
Press  to set preset white balance to the white balance value for the highlighted photograph.









## Picture Controls

Nikon's unique Picture Control system makes it possible to share image processing settings, including sharpening, contrast, brightness, saturation, and hue, among compatible devices and software.

### Selecting a Picture Control

Choose a Picture Control according to the subject or type of scene.

Option	Description
 <b>Standard</b>	Recommended for most situations, this option uses standard processing for balanced results.
 <b>Neutral</b>	A good choice for photographs that will later be extensively processed or retouched, this option uses minimal processing for natural results.
 <b>Vivid</b>	Choose this option for photographs that emphasize primary colors. Pictures are enhanced for a vivid, photoprint effect.
 <b>Monochrome</b>	Take monochrome photographs.
 <b>Portrait</b>	Process portraits for skin with natural texture and a rounded feel.
 <b>Landscape</b>	Produces vibrant landscapes and cityscapes.

- 1 Display Picture Control options.**  
Press the **MENU** button to display the menus. Highlight **Set Picture Control** in the shooting menu and press **▶**.

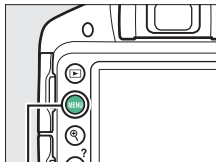

*MENU button*

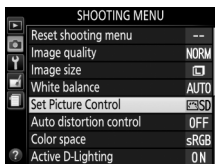

- 2 Select a Picture Control.**  
Highlight a Picture Control and press **OK**.

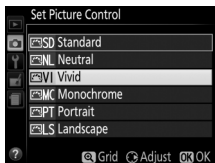



## Modifying Picture Controls

Picture Controls can be modified to suit the scene or the user's creative intent. Choose a balanced combination of settings using **Quick adjust**, or make manual adjustments to individual settings.

- 1 Select a Picture Control.**  
Press **MENU** to display the menus, then highlight **Set Picture Control** in the shooting menu and press **▶**. Highlight the desired Picture Control and press **▶**.

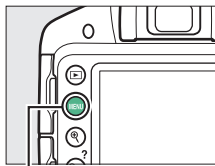

MENU button

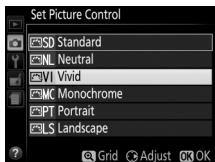

- 2 Adjust settings.**  
Press **▲** or **▼** to highlight the desired setting and press **◀** or **▶** to choose a value (see 139). Repeat this step until all settings have been adjusted, or select **Quick adjust** to choose a preset combination of settings. Default settings can be restored by pressing the **Reset** button.

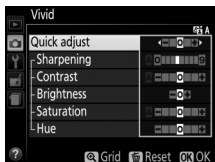

### 3 Save changes and exit.

Press **OK**.



Picture Controls that have been modified from default settings are indicated by an asterisk ("\*").

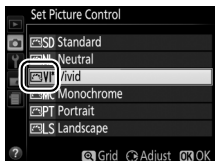

## Picture Control Settings

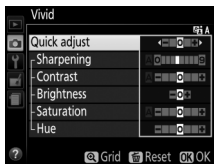

Option	Description
Quick adjust	Mute or heighten the effect of the selected Picture Control (note that this resets all manual adjustments). Not available with <b>Neutral</b> or <b>Monochrome</b> Picture Controls.
Manual adjustments (all Picture Controls)	<b>Sharpening</b> Control the sharpness of outlines. Select <b>A</b> to adjust sharpening automatically according to the type of scene.
	<b>Contrast</b> Adjust contrast manually or select <b>A</b> to let the camera adjust contrast automatically.
	<b>Brightness</b> Raise or lower brightness without loss of detail in highlights or shadows.
Manual adjustments (non-monochrome only)	<b>Saturation</b> Control the vividness of colors. Select <b>A</b> to adjust saturation automatically according to the type of scene.
	<b>Hue</b> Adjust hue.
Manual adjustments (monochrome only)	<b>Filter effects</b> Simulate the effect of color filters on monochrome photographs (141).
	<b>Toning</b> Choose the tint used in monochrome photographs (141).

### ✔ "A" (Auto)

Results for auto sharpening, contrast, and saturation vary with exposure and the position of the subject in the frame.

### ✔ The Picture Control Grid

To display a grid showing saturation (non-monochrome controls only) and contrast for the Picture Control selected in Step 2, press and hold the  button.

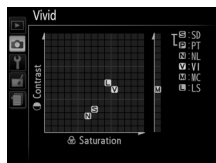

The icons for Picture Controls that use auto contrast and saturation are displayed in green in the Picture Control grid, and lines appear parallel to the axes of the grid.

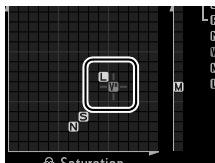

### ✔ Previous Settings

The line under the value display in the Picture Control setting menu indicates the previous value for the setting.

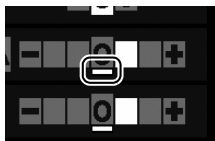

### ✔ Filter Effects (Monochrome Only)

The options in this menu simulate the effect of color filters on monochrome photographs. The following filter effects are available:

Option		Description
Y	Yellow	Enhances contrast. Can be used to tone down the brightness of the sky in landscape photographs. Orange produces more contrast than yellow, red more contrast than orange.
O	Orange	
R	Red	
G	Green	Softens skin tones. Can be used for portraits.

Note that the effects achieved with **Filter effects** are more pronounced than those produced by physical glass filters.

### ✔ Toning (Monochrome Only)

Choose from **B&W** (black-and-white), **Sepia**, **Cyanotype** (blue-tinted monochrome), **Red**, **Yellow**, **Green**, **Blue Green**, **Blue**, **Purple**, **Blue**, **Red Purple**. Pressing ▼ when **Toning** is selected displays saturation options. Press ◀ or ▶ to adjust saturation. Saturation control is not available when **B&W** (black-and-white) is selected.

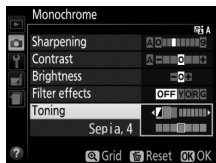

# Live View

## Framing Photographs in the Monitor

Follow the steps below to take photographs in live view.

### 1 Press the **Lv** button.

The view through the lens will be displayed in the monitor.

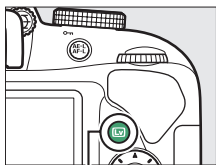

**Lv** button

### 2 Position the focus point.

Position the focus point over your subject as described on page 147.



Focus point

### 3 Focus.

Press the shutter-release button halfway. The focus point will flash green while the camera focuses. If the camera is able to focus, the focus point will be displayed in green; if the camera is unable to focus, the focus point will flash red (note that pictures can be taken even when the focus point flashes red; check focus in the monitor before shooting). Except in **AUTO** and **AF-L** modes, exposure can be locked by pressing the **AE-L/AF-L** (**OK**) button.



## 4 Take the picture.

Press the shutter-release button the rest of the way down. The monitor turns off and the memory card access lamp lights during recording. *Do not remove the battery or memory card*

*until recording is complete.* When shooting is complete, the photograph will be displayed in the monitor for a few seconds before the camera returns to live view mode. To exit, press the  button.

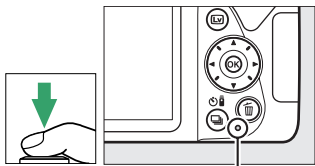





Memory card access lamp



## Focusing in Live View

Follow the steps below to choose focus and AF-area modes and position the focus point.

### ■ Choosing How the Camera Focuses (Focus Mode)

The following focus modes are available in live view (note that full-time-servo AF is not available in , , , and  modes):

Option	Description
<b>AF-S Single-servo AF</b>	For stationary subjects. Focus locks when shutter-release button is pressed halfway.
<b>AF-F Full-time-servo AF</b>	For moving subjects. Camera focuses continuously until shutter-release button is pressed. Focus locks when shutter-release button is pressed halfway.
<b>MF Manual focus</b>	Focus manually (  154).

- 1 Display focus options.**  
Press the  button, then highlight the current focus mode in the information display and press .

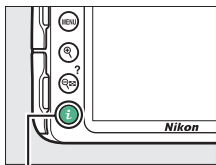

*i* button

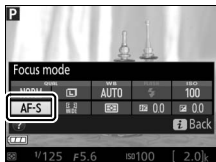





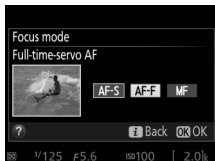

- 2 Choose a focus option.**  
Highlight an option and press **OK**.



### ■ ■ *Choosing How the Camera Picks the Area (AF-Area Mode)*

In modes other than **AUTO**, **☺**, and **☺**, the following AF-area modes can be selected in live view (note that subject-tracking AF is not available in **1/1**, **1/2**, **1/3**, **1/4**, and **1/5** modes):

Option	Description
 <b>Face-priority AF</b>	Use for portraits. The camera automatically detects and focuses on portrait subjects.
 <b>Wide-area AF</b>	Use for hand-held shots of landscapes and other non-portrait subjects. Use the multi-selector to select the focus point.
 <b>Normal-area AF</b>	Use for pin-point focus on a selected spot in the frame. A tripod is recommended.
 <b>Subject-tracking AF</b>	Use if you want focus to track a selected subject.

- 1 Display AF-area modes.**  
Press the **i** button, then highlight the current AF-area mode in the information display and press **OK**.

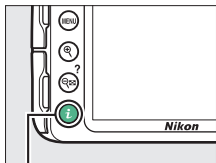

*i* button

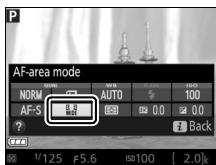

- 2 Choose an AF-area mode.**  
Highlight an option and press **OK**.

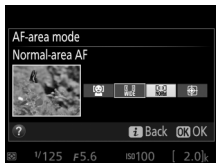

### 3 Choose the focus point.

**☺ (face-priority AF):** A double yellow border will be displayed when the camera detects a portrait subject (if multiple faces, up to a maximum of 35, are detected, the camera will focus on the closest subject; to choose a different subject, use the multi selector). If the camera can no longer detect the subject (because, for example, the subject has turned to face away from the camera), the border will no longer be displayed.



*Focus point*

**☒ (wide- and normal-area AF):** Use the multi selector to move the focus point anywhere in the frame, or press **OK** to position the focus point in the center of the frame.



*Focus point*

**☒ (subject-tracking AF):** Position the focus point over your subject and press **OK**. The focus point will track the selected subject as it moves through the frame. To end focus tracking, press **OK** a second time.



*Focus point*

## The Live View Display

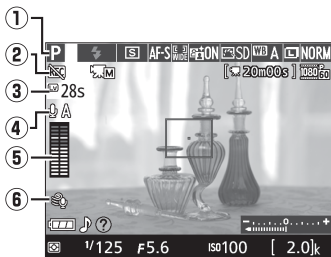

Item	Description	
① Shooting mode	The mode currently selected with the mode dial.	25, 47, 50, 100
② “No movie” icon	Indicates that movies can not be recorded.	—
③ Time remaining	The amount of time remaining before live view ends automatically. Displayed if shooting will end in 30 s or less.	152, 161
④ Microphone sensitivity	Microphone sensitivity for movie recording.	158
⑤ Sound level	Sound level for audio recording. Displayed in red if level is too high; adjust microphone sensitivity accordingly. Left (L) and right (R) channel indicators appear when optional ME-1 or other stereo microphone is used.	158
⑥ Wind noise reduction	Displayed when <b>On</b> is selected for <b>Movie settings &gt; Wind noise reduction</b> in the shooting menu.	159

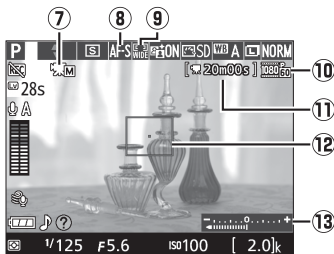

Item	Description	
⑦ <b>Manual movie settings indicator</b>	Displayed when <b>On</b> is selected for <b>Manual movie settings</b> in mode <b>M</b> .	159
⑧ <b>Focus mode</b>	The current focus mode.	144
⑨ <b>AF-area mode</b>	The current AF-area mode.	145
⑩ <b>Movie frame size</b>	The frame size of movies recorded in movie mode.	158
⑪ <b>Time remaining (movie mode)</b>	The recording time remaining in movie mode.	156
⑫ <b>Focus point</b>	The current focus point. The display varies with the option selected for AF-area mode (📖 145).	147
⑬ <b>Exposure indicator</b>	Indicates whether the photograph would be under- or over-exposed at current settings (mode <b>M</b> only).	109

**Note:** Display shown with all indicators lit for illustrative purposes.

## Live View/Movie Recording Display Options

Press the **info** button to cycle through display options as shown below (note that display options are not available in mode ). Circled areas indicate edges of movie frame crop.

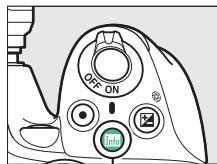

**info** button



**Show photo indicators**



**Show movie indicators**

( 155)\*

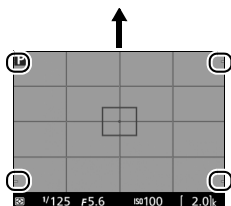

**Framing grid**

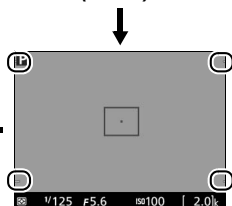

**Hide indicators**

\* A crop showing the area recorded is displayed during movie recording when frame sizes other than 640 × 424 are selected for **Movie settings > Frame size/frame rate** in the shooting menu ( 158; the area outside the movie frame crop is grayed out when movie indicators are displayed).

## Camera Settings

Except when movie indicators are displayed, you can access the following live view photography settings by pressing the **i** button: image quality (□ 85), image size (□ 87), white balance (□ 124), flash mode (□ 90, 92), ISO sensitivity (□ 95), focus mode (□ 144), AF-area mode (□ 145), metering (□ 114), flash compensation (□ 120), and exposure compensation (□ 118). When movie indicators are displayed, movie settings can be adjusted (□ 161).

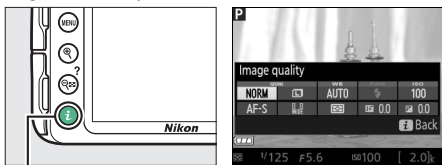

**i** button

## Exposure

Depending on the scene, exposure may differ from that which would be obtained when live view is not used. Metering in live view is adjusted to suit the live view display, producing photographs with exposure close to what is seen in the monitor (note that exposure compensation can only be previewed in the monitor at values between +3 EV and -3 EV). To prevent light entering via the viewfinder from appearing in the photograph or interfering with exposure, we recommend that you cover the viewfinder with your hand or other objects such as an optional eyepiece cap (□ 307) before taking pictures without your eye to the viewfinder (□ 73).

## HDMI

When the camera is attached to an HDMI video device, the camera monitor will remain on and the video device will display the view through the lens. If the device supports HDMI-CEC, select **Off** for the **HDMI > Device control** option in the setup menu (□ 218) before shooting in live view.

### ✔ Shooting in Live View Mode

Although it will not appear in the final picture, distortion may be visible in the monitor if the camera is panned horizontally or an object moves at high speed through frame. Bright light sources may leave after-images in the monitor when the camera is panned. Bright spots may also appear. Flicker and banding visible in the monitor under fluorescent, mercury vapor, or sodium lamps can be reduced using **Flicker reduction** (☐ 241), although they may still be visible in the final photograph at some shutter speeds. When shooting in live view mode, avoid pointing the camera at the sun or other strong light sources. Failure to observe this precaution could result in damage to the camera's internal circuitry.

Live view ends automatically if the mode dial is rotated to **GUIDE** or the mode dial is rotated from **GUIDE** to another setting.

Live view may end automatically to prevent damage to the camera's internal circuits; exit live view when the camera is not in use. Note that the temperature of the camera's internal circuits may rise and noise (bright spots, randomly-spaced bright pixels, or fog) may be displayed in the following instances (the camera may also become noticeably warm, but this does not indicate a malfunction):

- The ambient temperature is high
- The camera has been used for extended periods in live view or to record movies
- The camera has been used in continuous release mode for extended periods

If live view does not start when you attempt to start live view, wait for the internal circuits to cool and then try again.

### ✔ The Count Down Display

A count down will be displayed 30 s before live view ends automatically (☐ 148; the timer turns red 5 s before the auto off timer expires (☐ 245) or if live view is about to end to protect the internal circuits). Depending on shooting conditions, the timer may appear immediately when live view is selected.



### ✔ Using Autofocus in Live View

Autofocus is slower in live view and the monitor may brighten or darken while the camera focuses. The camera may be unable to focus in the situations listed below (note that the focus point may sometimes be displayed in green when the camera is unable to focus):





- The subject contains lines parallel to the long edge of the frame
- The subject lacks contrast
- The subject in the focus point contains areas of sharply contrasting brightness, or the subject is lit by spot lighting or by a neon sign or other light source that changes in brightness
- Flicker or banding appears under fluorescent, mercury-vapor, sodium-vapor, or similar lighting
- A cross (star) filter or other special filter is used
- The subject appears smaller than the focus point
- The subject is dominated by regular geometric patterns (e.g., blinds or a row of windows in a skyscraper)
- The subject is moving

In addition, the subject-tracking AF may be unable to track subjects if they move quickly, leave the frame or are obscured by other objects, change visibly in size, color, or brightness, or are too small, too large, too bright, too dark, or similar in color or brightness to the background.

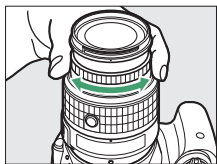
## Manual Focus

To focus in manual focus mode (📖 83), rotate the lens focus ring until the subject is in focus.



To magnify the view in the monitor up to about 8.3 × for precise focus, press the  button. While the view through the lens is zoomed in, a navigation window will appear in a gray frame at the bottom right corner of the display. Use the multi selector to scroll to areas of the frame not visible in the monitor (available only if  (**Wide-area AF**) or  (**Normal-area AF**) is selected for **AF-area mode**), or press  (?) to zoom out.

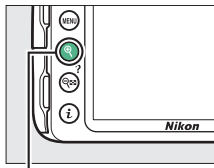

 button

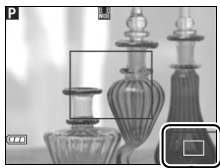

Navigation window

# Recording and Viewing Movies

## Recording Movies

Movies can be recorded in live view mode.

### 1 Press the **Lv** button.

The view through the lens will be displayed in the monitor.

#### ✓ The Icon

A  icon (□ 148) indicates that movies can not be recorded.

#### ✓ Before Recording

Set aperture before recording in mode **A** or **M** (□ 106, 108).

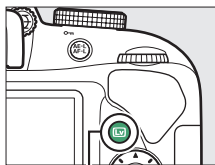









Lv button

### 2 Focus.

Frame the opening shot and focus as described in Steps 2 and 3 of “Framing Photographs in the Monitor” (□ 142; see also “Focusing in Live View” on pages 144–147). Note that the number of subjects that can be detected in face-priority AF drops during movie recording.



### 3 Start recording.

Press the movie-record button to start recording. A recording indicator and the time available are displayed in the monitor. Except in  and  modes, exposure can be locked by pressing the  (  ) button (  116 ) or ( in modes **P**, **S**, **A**, and  ) altered by up to  $\pm 3$  EV in steps of  $\frac{1}{3}$  EV by pressing the  (  ) button and rotating the command dial (  119; note that depending on the brightness of the subject, changes to exposure may have no visible effect).

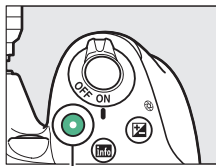

*Movie-record button*

*Recording indicator*

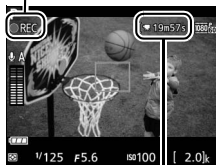

*Time remaining*

### 4 End recording.

Press the movie-record button again to end recording. Recording will end automatically when the maximum length is reached, the memory card is full, or another mode is selected.

#### **Taking Photographs During Movie Recording**

To end movie recording, take a photograph, and exit to live view, press the shutter-release button all the way down and hold it in this position until the shutter is released.

#### **Maximum Length**

The maximum length for individual movie files is 4 GB (for maximum recording times, see page 158); note that depending on memory card write speed, shooting may end before this length is reached (  310 ).

### ✔ Recording Movies

Flicker, banding, or distortion may be visible in the monitor and in the final movie under fluorescent, mercury vapor, or sodium lamps or if the camera is panned horizontally or an object moves at high speed through frame (flicker and banding can be reduced using **Flicker reduction**;  241). Bright light sources may leave after-images when the camera is panned. Jagged edges, color fringing, moiré, and bright spots may also appear. Bright bands may appear in some areas of the frame if the subject is briefly illuminated by a flash or other bright, momentary light source. When recording movies, avoid pointing the camera at the sun or other strong light sources. Failure to observe this precaution could result in damage to the camera's internal circuitry.

The camera can record both video and sound; do not cover the microphone during recording. Note that the built-in microphone may record lens noise during autofocus and vibration reduction.

Flash lighting can not be used during movie recording.

Live view may end automatically to prevent damage to the camera's internal circuits; exit live view when the camera is not in use. Note that the temperature of the camera's internal circuits may rise and noise (bright spots, randomly-spaced bright pixels, or fog) may be displayed in the following instances (the camera may also become noticeably warm, but this does not indicate a malfunction):

- The ambient temperature is high
- The camera has been used for extended periods in live view or to record movies
- The camera has been used in continuous release mode for extended periods

If live view does not start when you attempt to start live view or movie recording, wait for the internal circuits to cool and then try again.

Matrix metering is used regardless of the metering method selected. Shutter speed and ISO sensitivity are adjusted automatically unless **On** is selected for **Manual movie settings** ( 159) and the camera is in mode **M**.

## Movie Settings

The camera offers the following movie settings.

- **Frame size/frame rate, Movie quality:** Choose from the following options. The frame rate depends on the option currently selected for **Video mode** in the setup menu (□ 260):

	Frame size/frame rate		Maximum length (high movie quality ★/ normal movie quality) <sup>4</sup>
	Frame size (pixels)	Frame rate <sup>1</sup>	
$\frac{1080 \text{ P}^{\star}}{50} / \frac{1080 \text{ P}}{50}$	1920 × 1080	60p <sup>2</sup>	10 min./20 min.
$\frac{1080 \text{ P}^{\star}}{50} / \frac{1080 \text{ P}}{50}$		50p <sup>3</sup>	
$\frac{1080 \text{ P}^{\star}}{50} / \frac{1080 \text{ P}}{50}$		30p <sup>2</sup>	20 min./29 min. 59 s
$\frac{1080 \text{ P}^{\star}}{25} / \frac{1080 \text{ P}}{25}$		25p <sup>3</sup>	
$\frac{1080 \text{ P}^{\star}}{24} / \frac{1080 \text{ P}}{24}$		24p	
$\frac{720 \text{ P}^{\star}}{50} / \frac{720 \text{ P}}{50}$	60p <sup>2</sup>		
$\frac{720 \text{ P}^{\star}}{50} / \frac{720 \text{ P}}{50}$	1280 × 720	50p <sup>3</sup>	
$\frac{424 \text{ P}^{\star}}{50} / \frac{424 \text{ P}}{50}$	640 × 424	30p <sup>2</sup>	29 min. 59 s/
$\frac{424 \text{ P}^{\star}}{25} / \frac{424 \text{ P}}{25}$		25p <sup>3</sup>	29 min. 59 s

1 Listed value. Actual frame rates for 60p, 50p, 30p, 25p, and 24p are 59.94, 50, 29.97, 25, and 23.976 fps respectively.

2 Available when **NTSC** is selected for **Video mode** (□ 260).

3 Available when **PAL** is selected for **Video mode**.

4 Movies recorded in miniature effect mode are up to three minutes long when played back.

- **Microphone:** Turn the built-in or optional ME-1 stereo microphones (□ 161, 309) on or off or adjust microphone sensitivity. Choose **Auto sensitivity** to adjust sensitivity automatically, **Microphone off** to turn sound recording off; to select microphone sensitivity manually, select **Manual sensitivity** and choose a sensitivity.

- **Wind noise reduction:** Select **On** to enable the low-cut filter for the built-in microphone (optional stereo microphones are unaffected; [□ 161, 309](#)), reducing noise produced by wind blowing over the microphone (note that other sounds may also be affected). Wind-noise reduction for optional stereo microphones can be enabled or disabled using microphone controls.
- **Manual movie settings:** Choose **On** to allow manual adjustments to shutter speed and ISO sensitivity when the camera is in mode **M**. Shutter speed can be set to values as fast as  $\frac{1}{4000}$  s; the slowest speed available varies with the frame rate:  $\frac{1}{30}$  s for frame rates of 24p, 25p, and 30p,  $\frac{1}{50}$  s for 50p, and  $\frac{1}{60}$  s for 60p. ISO sensitivity can be set to values between ISO 100 and Hi 1 ([□ 95](#)). If shutter speed and ISO sensitivity are not in these ranges when live view starts, they will automatically be set to supported values, and remain at these values when live view ends. Note that ISO sensitivity is fixed at the value selected; the camera does not adjust ISO sensitivity automatically when **On** is selected for **ISO sensitivity settings > Auto ISO sensitivity control** in the shooting menu ([□ 227](#)).

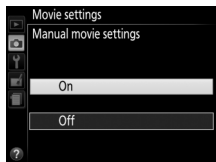

## 1 Select **Movie settings**.

Press the **MENU** button to display the menus. Highlight **Movie settings** in the shooting menu and press ►.

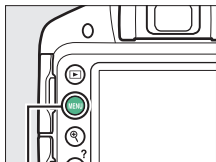

**MENU button**

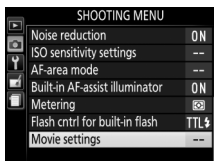

## 2 Choose movie options.

Highlight the desired item and press ►, then highlight an option and press **OK**.

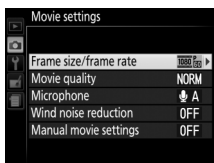

### **HDMI and Other Video Devices**

When the camera is attached to an HDMI video device, the camera monitor will remain on and the video device will display the view through the lens. If the device supports HDMI-CEC, select **Off** for the **HDMI > Device control** option in the setup menu (☰ 218) before shooting in live view.



### The Live View Display

The movie crop can be viewed during live view by pressing the **Info** button to select the “show movie indicators”, “hide indicators”, or “framing grid” display (□ 150). When movie indicators are displayed, you can access the following movie settings by pressing the **i** button: movie frame size/quality, microphone sensitivity, focus mode (□ 144), AF-area mode (□ 145), white balance (□ 124), and exposure compensation (□ 118). If **On** is selected for **Movie settings > Manual movie settings** (□ 159) in mode **M**, ISO sensitivity (□ 95) can be adjusted in place of exposure compensation.

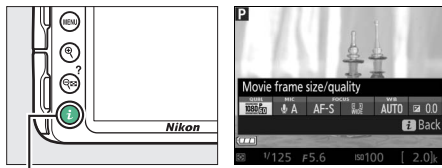

*i* button



### Using an External Microphone

The optional ME-1 stereo microphone can be used to record sound in stereo or to reduce noise caused by lens vibration being recorded during autofocus.

### The Count-Down Display







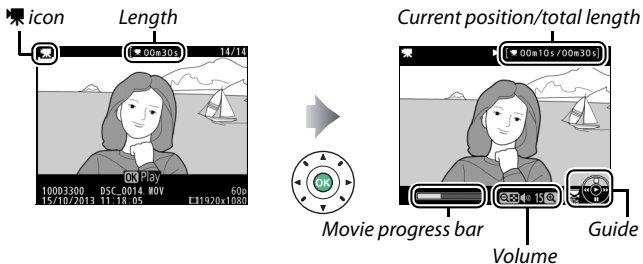







A count down will be displayed 30 s before live view ends automatically (□ 148). Depending on shooting conditions, the timer may appear immediately when movie recording begins. Note that regardless of the amount of recording time available, live view will still end automatically when the timer expires. Wait for the internal circuits to cool before resuming movie recording.

## Viewing Movies

Movies are indicated by a  icon in full-frame playback (170). Press  to start playback; your current position is indicated by the movie progress bar.





The following operations can be performed:

To	Use	Description
Pause		Pause playback.
Play		Resume playback when movie is paused or during rewind/advance.
Advance/rewind		Speed increases with each press, from 2x to 4x to 8x to 16x; keep pressed to skip to beginning or end of movie (first frame is indicated by  in top right corner of monitor, last frame by  ). If playback is paused, movie rewinds or advances one frame at a time; hold for continuous rewind or advance.
Skip 10 s		Rotate the command dial to skip ahead or back 10 s.
Adjust volume	 /  (?)	Press  to increase volume,  (?) to decrease.
Return to full-frame playback	 / 	Press  or  to exit to full-frame playback.

## Editing Movies

Trim footage to create edited copies of movies or save selected frames as JPEG stills.

Option	Description
 <b>Choose start/end point</b>	Create a copy from which the opening or closing footage has been removed.
 <b>Save selected frame</b>	Save a selected frame as a JPEG still.

## Trimming Movies

To create trimmed copies of movies:

**1** Display a movie full frame.

**2** Pause the movie on the new opening or closing frame.

Play the movie back as described on page 162, pressing **OK** to start and resume playback and **▼** to pause. Pause playback when you reach the new opening or closing frame.



*Movie progress bar*

- 3** Select **Choose start/end point**.  
Press the **i** button, then highlight **Choose start/end point** and press ►.

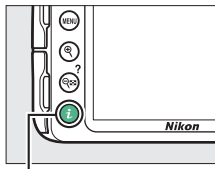

*i* button

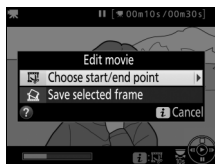

- 4** Choose the current frame as the new **start or end point**.

To create a copy that begins from the current frame, highlight **Start point** and press **OK**. The frames before the current frame will be removed when you save the copy.

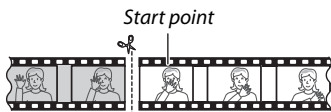
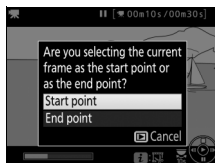

To create a copy that ends at the current frame, highlight **End point** and press **OK**. The frames after the current frame will be removed when you save the copy.

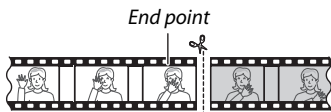

---

## 5 Confirm the new start or end point.

If the desired frame is not currently displayed, press ◀ or ▶ to advance or rewind (to skip to 10 s ahead or back, rotate the command dial).



---

## 6 Create the copy.

Once the desired frame is displayed, press ▲.



---

## 7 Preview the movie.

To preview the copy, highlight **Preview** and press OK (to interrupt the preview and return to the save options menu, press ▲). To abandon the current copy and return to Step 5, highlight **Cancel** and press OK; to save the copy, proceed to Step 8.

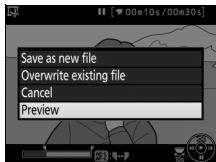

---

## 8 Save the copy.

Highlight **Save as new file** and press OK to save the copy to a new file. To replace the original movie file with the edited copy, highlight **Overwrite existing file** and press OK.

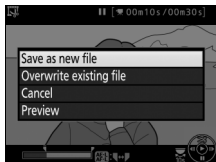

### ✔ Trimming Movies

Movies must be at least two seconds long. The copy will not be saved if there is insufficient space available on the memory card.

Copies have the same time and date of creation as the original.

### ✔ Choosing the Role of the Current Frame

To make the frame displayed in Step 5 the new end point (▮) instead of the new start point (▮) or vice versa, press the <sup>AE-L</sup><sub>AF-L</sub> (◀▶) button.

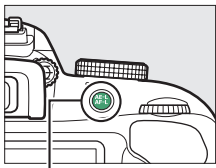

<sup>AE-L</sup><sub>AF-L</sub> (◀▶) button



## Saving Selected Frames

To save a copy of a selected frame as a JPEG still:

### 1 Pause the movie on the desired frame.

Play the movie back as described on page 162, pressing **OK** to start and resume playback and **▼** to pause. Pause the movie at the frame you intend to copy.



### 2 Choose **Save selected frame**.

Press the **i** button, then highlight **Save selected frame** and press **▶**.

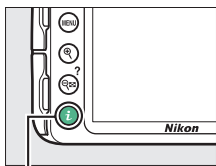

**i** button

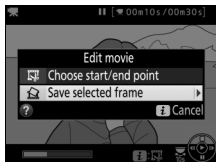



### 3 Create a still copy.

Press ▲ to create a still copy of the current frame.



### 4 Save the copy.

Highlight **Yes** and press Ⓞ to create a fine-quality (85) JPEG copy of the selected frame.

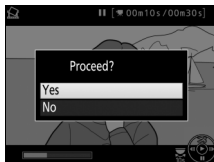

#### Save Selected Frame

JPEG movie stills created with the **Save selected frame** option can not be retouched. JPEG movie stills lack some categories of photo information (172).







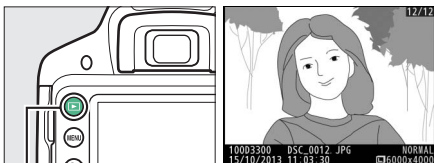



# Playback and Deletion



## Full-Frame Playback

To play photographs back, press the  button. The most recent photograph will be displayed in the monitor.



 button

To	Use	Description
View additional photographs		Press  to view photographs in order recorded,  to view photographs in reverse order.
View additional photo info		Change photo info displayed (  172).
View thumbnails		See page 180 for more information on the thumbnail display.
		
Zoom in on photograph		See page 182 for more information on playback zoom.
Delete images		Confirmation dialog will be displayed. Press  again to delete photo.

To	Use	Description
Change protect status	AE-L/AF-L (OK)	To protect image, or to remove protection from protected image, press AE-L/AF-L (OK) button (184).
View movie or panorama		If current picture is marked with  icon to show that it is a movie, pressing OK starts movie playback (162). If the current picture is a panorama, pressing OK starts panorama playback (66).

### The *i* Button

Pressing the *i* button in full-frame, thumbnail, or calendar playback displays the dialog shown at right, where you can rate pictures (186), retouch photos and edit movies (164, 263), and select pictures for transfer to a smart device when an optional wireless mobile adapter is connected (189).

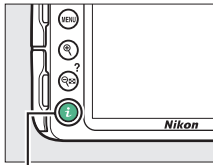

*i* button



## Photo Information

Photo information is superimposed on images displayed in full-frame playback. Press ▲ or ▼ to cycle through photo information as shown below. Note that “image only”, shooting data, RGB histograms, highlights, and overview data are only displayed if corresponding option is selected for **Playback display options** ( 220). Location data are only displayed if an optional GP-1 or GP-1A GPS unit ( 309) was used when the photo was taken ( 259).

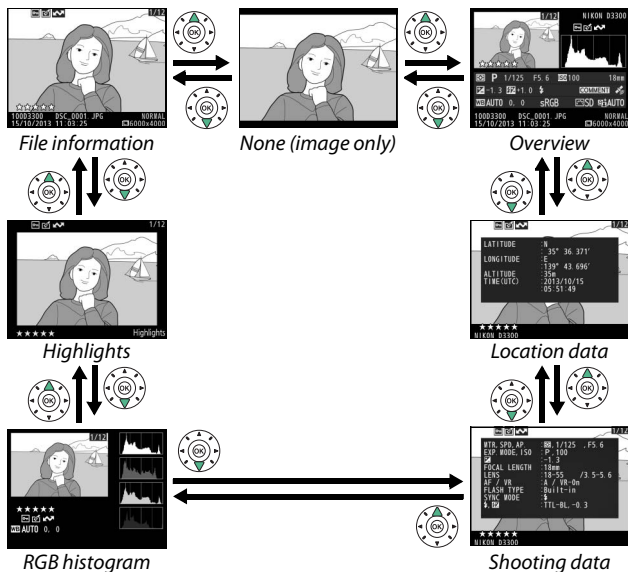

## File Information

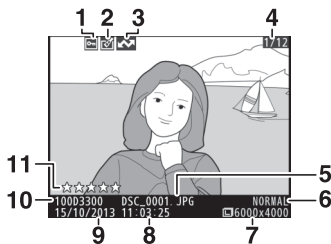

<b>1</b> Protect status.....	184	<b>6</b> Image quality .....	85
<b>2</b> Retouch indicator .....	265	<b>7</b> Image size .....	87
<b>3</b> Upload marking .....	189	<b>8</b> Time of recording .....	18, 242
<b>4</b> Frame number/total number of images		<b>9</b> Date of recording .....	18, 242
<b>5</b> File name .....	250	<b>10</b> Folder name.....	257
		<b>11</b> Rating.....	186

## Highlights\*

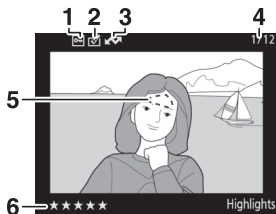

<b>1</b> Protect status.....	184	<b>4</b> Frame number/total number of images	
<b>2</b> Retouch indicator .....	265	<b>5</b> Image highlights	
<b>3</b> Upload marking .....	189	<b>6</b> Rating.....	186

\* Flashing areas indicate highlights (areas that may be overexposed).

## RGB Histogram

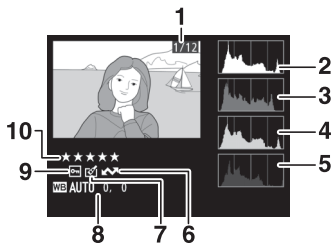

**1** Frame number/total number of images

**2** Histogram (RGB channel). In all histograms, horizontal axis gives pixel brightness, vertical axis number of pixels.

**3** Histogram (red channel)

**4** Histogram (green channel)

**5** Histogram (blue channel)

**6** Upload marking ..... 189

**7** Retouch indicator ..... 265

**8** White balance..... 124



White balance fine-tuning ..... 127

Preset manual..... 129

**9** Protect status..... 184

**10** Rating ..... 186

### Playback Zoom

To zoom in on the photograph when the histogram is displayed, press . Use the  and  buttons to zoom in and out and scroll the image with the multi selector. The histogram will be updated to show only the data for the portion of the image visible in the monitor.



## Histograms

Camera histograms are intended as a guide only and may differ from those displayed in imaging applications. Some sample histograms are shown below:

If the image contains objects with a wide range of brightnesses, the distribution of tones will be relatively even.



If the image is dark, tone distribution will be shifted to the left.



If the image is bright, tone distribution will be shifted to the right.



Increasing exposure compensation shifts the distribution of tones to the right, while decreasing exposure compensation shifts the distribution to the left. Histograms can provide a rough idea of overall exposure when bright ambient lighting makes it difficult to see photographs in the monitor.

## Shooting Data

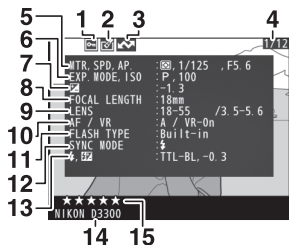

1	Protect status .....	184	11	Flash type .....	229, 299
2	Retouch indicator .....	265		Commander mode <sup>2</sup>	
3	Upload marking .....	189	12	Flash mode .....	90, 92
4	Frame number/total number of images		13	Flash control .....	229
5	Metering .....	114		Flash compensation .....	120
	Shutter speed .....	101	14	Camera name	
	Aperture .....	101	15	Rating .....	186
6	Shooting mode .....	25, 47, 50, 100			
	ISO sensitivity <sup>1</sup> .....	95			
7	Exposure compensation .....	118			
8	Focal length .....	298			
9	Lens data				
10	Focus mode .....	74, 144			
	Lens VR (vibration reduction) <sup>2</sup>				
	.....	23, 230			



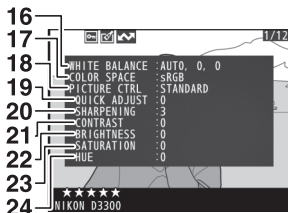

<p>16 White balance ..... 124</p> <p>White balance fine-tuning ..... 127</p> <p>Preset manual..... 129</p> <p>17 Color space..... 225</p> <p>18 Picture Control ..... 135</p> <p>19 Quick adjust<sup>3</sup> ..... 139</p> <p>Original Picture Control<sup>3</sup> ..... 135</p>	<p>20 Sharpening ..... 139</p> <p>21 Contrast ..... 139</p> <p>22 Brightness ..... 139</p> <p>23 Saturation<sup>3</sup> ..... 139</p> <p>Filter effects<sup>3</sup> ..... 139</p> <p>24 Hue<sup>3</sup> ..... 139</p> <p>Toning<sup>3</sup> ..... 139</p>
--	---

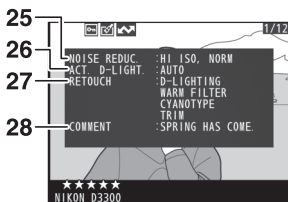

<p>25 Noise reduction..... 226</p> <p>26 Active D-Lighting<sup>4</sup> ..... 122</p>	<p>27 Retouch history..... 263</p> <p>28 Image comment ..... 244</p>
--	--

- 1 Displayed in red if photo was taken with auto ISO sensitivity control on.
- 2 Displayed only in photos taken with accessories that support this function.
- 3 May not be displayed depending on Picture Control used.
- 4 **AUTO** is displayed if photo was taken with Active D-Lighting on.

## Overview Data

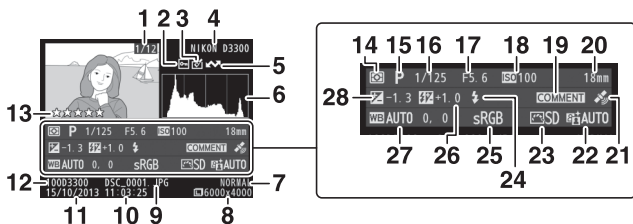

1	Frame number/total number of images	15	Shooting mode ..... 25, 47, 50, 100
2	Protect status ..... 184	16	Shutter speed ..... 101
3	Retouch indicator ..... 265	17	Aperture ..... 101
4	Camera name	18	ISO sensitivity <sup>1</sup> ..... 95
5	Upload marking ..... 189	19	Image comment indicator ..... 244
6	Histogram showing the distribution of tones in the image (□ 175).	20	Focal length ..... 298
7	Image quality ..... 85	21	Location data indicator ..... 259
8	Image size ..... 87	22	Active D-Lighting <sup>2</sup> ..... 122
9	File name ..... 250	23	Picture Control ..... 135
10	Time of recording ..... 18, 242	24	Flash mode ..... 90, 92
11	Date of recording ..... 18, 242	25	Color space ..... 225
12	Folder name ..... 257	26	Flash compensation ..... 120 Commander mode <sup>3</sup>
13	Rating ..... 186	27	White balance ..... 124 White balance fine-tuning ..... 127 Preset manual ..... 129
14	Metering ..... 114	28	Exposure compensation ..... 118

- 1 Displayed in red if photo was taken with ISO sensitivity auto control on.
- 2 **AUTO** is displayed if photo was taken with Active D-Lighting on.
- 3 Displayed only in photos taken with accessories that support this function.

## ■ Location Data

Location data are displayed only if a GP-1 or GP-1A GPS unit (📖 309) was used when the photo was taken (📖 259). In the case of movies, the data give the location at the start of recording.

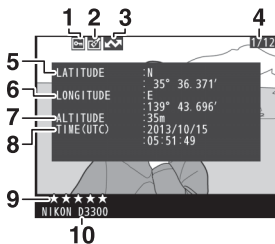







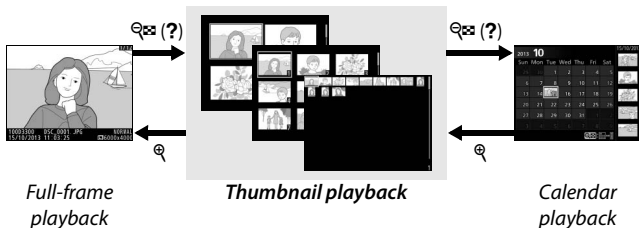

1	Protect status.....	184	6	Longitude
2	Retouch indicator .....	265	7	Altitude
3	Upload marking .....	189	8	Coordinated Universal Time (UTC)
4	Frame number/total number of images		9	Rating..... 186
5	Latitude		10	Camera name

## Thumbnail Playback

To display images in “contact sheets” of 4, 9, or 72 images, press the  (?) button.









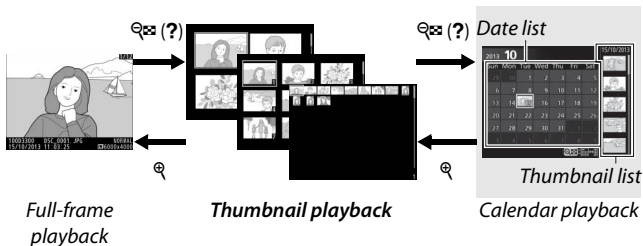





To	Use	Description
Display more images	 (?)	Press  (?) to increase the number of images displayed.
Display fewer images		Press  to reduce the number of images displayed. When four images are displayed, press to view highlighted image full frame.
Highlight images		Use multi selector or command dial to highlight pictures.
View highlighted image		Press  to display the highlighted image full frame.
Delete highlighted photo		See page 192 for more information.
Change protect status of highlighted photo	 (P)	See page 184 for more information.

## Calendar Playback

To view images taken on a selected date, press the  (?) button when 72 images are displayed.













The operations that can be performed depend on whether the cursor is in the date list or the thumbnail list:

To	Use	Description
Toggle between date list and thumbnail list	 (?)	Press  (?) or  button in date list to place cursor in thumbnail list. Press  (?) again to return to date list.
		
Exit to thumbnail playback/Zoom in on highlighted photo		<ul style="list-style-type: none"> <li>• <b>Date list:</b> Exit to 72-frame playback.</li> <li>• <b>Thumbnail list:</b> Press and hold  button to zoom in on highlighted picture.</li> </ul>
Highlight dates/Highlight images		<ul style="list-style-type: none"> <li>• <b>Date list:</b> Highlight date.</li> <li>• <b>Thumbnail list:</b> Highlight picture.</li> </ul>
Toggle full frame playback		<b>Thumbnail list:</b> View highlighted picture.
Delete highlighted photo(s)		<ul style="list-style-type: none"> <li>• <b>Date list:</b> Delete all pictures taken on selected date.</li> <li>• <b>Thumbnail list:</b> Delete highlighted picture ( 192).</li> </ul>
Change protect status of highlighted photo		See page 184 for more information.

## Taking a Closer Look: Playback Zoom

Press the  button to zoom in on the image displayed in full-frame playback or on the image currently highlighted in thumbnail or calendar playback. The following operations can be performed while zoom is in effect:

To	Use	Description
Zoom in or out	 /  (?)	Press  to zoom in to maximum of approximately 38× (large images), 28× (medium images) or 19× (small images). Press  (?) to zoom out. While photo is zoomed in, use multi selector to view areas of image not visible in monitor. Keep multi selector pressed to scroll rapidly to other areas of frame. Navigation window is displayed when zoom ratio is altered; area currently visible in monitor is indicated by yellow border.
View other areas of image		

To	Use	Description
Select/zoom in on or out from faces		Faces (up to 35) detected during zoom are indicated by white borders in navigation window. Press <b>i</b> and <b>▲</b> or <b>▼</b> to zoom in or out; press <b>i</b> and <b>◀</b> or <b>▶</b> to view other faces. 
View other images		Rotate command dial to view same location in other images at current zoom ratio. Playback zoom is cancelled when a movie is displayed.
Cancel zoom		Cancel zoom and return to full-frame playback.
Change protect status		See page 184 for more information.

## Protecting Photographs from Deletion

In full-frame, zoom, thumbnail, and calendar playback, the **AE-L/AF-L** (**OK**) button can be used to protect photographs from accidental deletion. Protected files can not be deleted using the **Trash** button or the **Delete** option in the playback menu. Note that protected images *will* be deleted when the memory card is formatted (□ 234).

To protect a photograph:

### 1 Select an image.

Display the image in full-frame playback or playback zoom or highlight it in the thumbnail list in thumbnail or calendar playback.



Full-frame playback



Thumbnail playback

### 2 Press the **AE-L/AF-L** (**OK**) button.

The photograph will be marked with a **OK** icon.

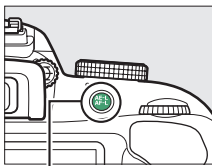





**AE-L/AF-L** (**OK**) button





### **Removing Protection**

To remove protection from individual pictures so that they can be deleted, display pictures full-frame or highlight them in the thumbnail list and then press the  (**AF-L**) button. To remove protection from all images in the folder or folders currently selected in the **Playback folder** menu ( 220), press the  (**AF-L**) and  buttons together for about two seconds during playback.

## Rating Pictures

Rate pictures or mark them as candidates for later deletion. Rating is not available with protected images.

### Rating Individual Pictures

#### 1 Select an image.

Display the image in full-frame playback or playback zoom or highlight it in the thumbnail list in thumbnail or calendar playback.

#### 2 Display playback options.

Press the **i** button to display playback options.

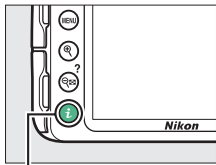

**i** button

#### 3 Select Rating.

Highlight **Rating** and press

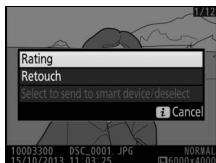

## 4 Choose a rating.

Press ◀ or ▶ to choose a rating of from zero to five stars, or select  to mark the picture as a candidate for later deletion.



## 5 Press .

Press  to complete the operation.



## Rating Multiple Pictures

Use the **Rating** option in the playback menu to rate multiple pictures.

## 1 Select Rating.



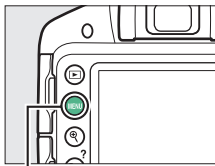

Press the MENU button to display the camera menus, then highlight **Rating** in the playback menu and press ▶.

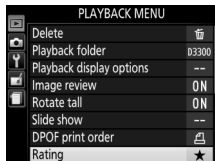



MENU button

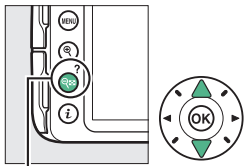

## 2 Rate pictures.

Use the multi selector to highlight pictures (to view the currently highlighted picture full frame, press and hold the  button) and keeping the  button pressed, press  or  to choose a rating of from zero to five stars, or select  to mark the picture as a candidate for later deletion.



 button



## 3 Press .

Press  to complete the operation.



## Selecting Pictures for Upload

Follow the steps below to select up to 100 photos for upload to a smart device when an optional wireless mobile adapter is connected (☐ 309). Connect a wireless mobile adapter before proceeding. Movies can not be selected for upload.

### Selecting Individual Pictures for Upload

#### 1 Select an image.

Display the image or highlight it in the thumbnail list in thumbnail or calendar playback.

#### 2 Display playback options.

Press the **i** button.

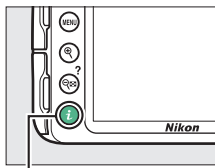

*i* button

#### 3 Choose **Select to send to smart device/deselect**.

Highlight **Select to send to smart device/deselect** and press **OK**. Pictures selected for upload are indicated by a  icon; to deselect, display or highlight the image and repeat Steps 2 and 3.

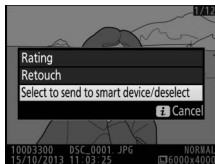

## Selecting Multiple Pictures for Upload

To change the upload status of multiple pictures, use the **Select to send to smart device** option in the playback menu when an optional wireless mobile adapter is connected.

### **1** Choose **Select to send to smart device**.

To display the menus, press the **MENU** button. Highlight **Select to send to smart device** in the playback menu and press ►.

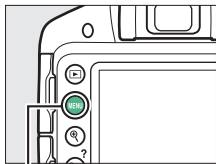

*MENU button*

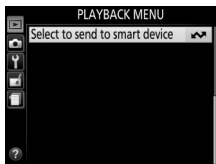



#### The icon

The  icon will no longer be displayed when upload is complete.

---

## 2 Select pictures.

Use the multi selector to highlight pictures and press  (?) to select or deselect (to view the highlighted picture full screen, press and hold the  button). Selected pictures are marked by a  icon.

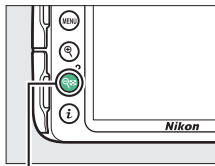

 (?) button



---

## 3 Press .

Press  to complete the operation.

## Deleting Photographs

Unprotected photographs can be deleted as described below. Once deleted, photographs can not be recovered.

### Full-Frame, Thumbnail, and Calendar Playback

#### 1 Select an image.

Display the image or highlight it in the thumbnail list in thumbnail or calendar playback.

#### 2 Press the button.

A confirmation dialog will be displayed.

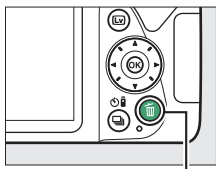

 button

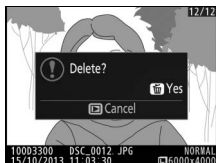

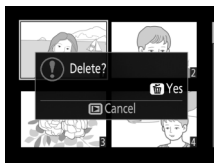

*Full-frame playback*



*Thumbnail playback*

#### 3 Press the button again.

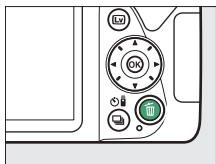

To delete the photograph, press the  button again. To exit without deleting the photograph, press the  button.





## The Playback Menu

The **Delete** option in the playback menu contains the following options. Note that depending on the number of images, some time may be required for deletion.

Option	Description
 <b>Selected</b>	Delete selected pictures.
 <b>Select date</b>	Delete all pictures taken on a selected date.
<b>ALL All</b>	Delete all pictures in the folder currently selected for playback (📖 220).

### ■ Selected: Deleting Selected Photographs

#### 1 Select **Delete**.

To display the menus, press the **MENU** button. Highlight **Delete** in the playback menu and press ►.

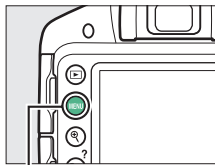

MENU button

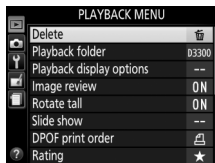

#### **Calendar Playback**

During calendar playback, you can delete all photographs taken on a selected date by highlighting the date in the date list and pressing the  button (📖 181).

- 2 Choose Selected.**  
Highlight **Selected** and press **▶**.

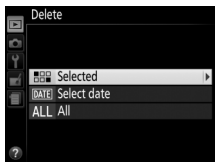

- 3 Highlight a picture.**  
Use the multi selector to highlight a picture (to view the highlighted picture full screen, press and hold the **Q** button).



- 4 Select the highlighted picture.**  
Press the **Q** (?) button to select the highlighted picture. Selected pictures are marked by a  icon. Repeat steps 3 and 4 to select additional pictures; to deselect a picture, highlight it and press **Q** (?).

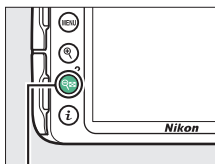

**Q** (?) button



- 5** Press **OK** to complete the operation.  
A confirmation dialog will be displayed; highlight **Yes** and press **OK**.



## ■ Select Date: Deleting Photographs Taken on a Selected Date

### 1 Choose **Select Date**.

In the delete menu, highlight **Select date** and press ►.

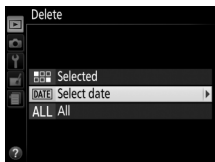

### 2 Highlight a date.

Press ▲ or ▼ to highlight a date.

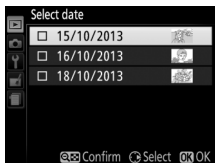

To view the pictures taken on the highlighted date, press (?). Use the multi selector to scroll through the pictures, or press and hold to view the current picture full screen. Press (?) to return to the date list.

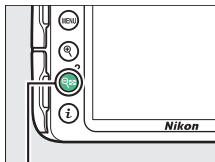

(?) button

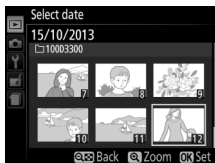

---

### 3 Select the highlighted date.

Press ► to select all pictures taken on the highlighted date. Selected dates are indicated by check marks.

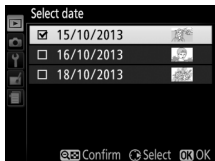

Repeat steps 2 and 3 to select additional dates; to deselect a date, highlight it and press ►.

---

### 4 Press OK to complete the operation.

A confirmation dialog will be displayed; highlight Yes and press OK.

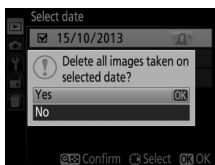

## Slide Shows

The **Slide show** option in the playback menu is used to display a slide show of the pictures in the current playback folder (📖 220).

### 1 Select Slide show.

To display the slide show menu, press the **MENU** button and select **Slide show** in the playback menu.

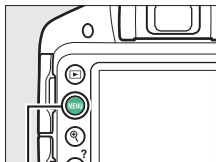

*MENU button*

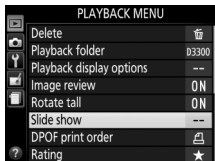



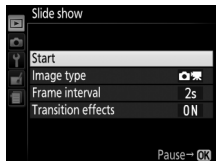

## 2 Start the slide show.

Highlight **Start** in the slide show menu and press **OK**.



The following operations can be performed while the slide show is in progress:

To	Use	Description
Skip back/skip ahead		Press <b>◀</b> to return to previous frame, <b>▶</b> to skip to next frame.
View additional photo info		Change photo info displayed (□ 172).
Pause/resume slide show		Pause show. Press again to resume.
Raise/lower volume	<b>Q</b> / <b>Q</b> (?)	Press <b>Q</b> during movie playback to increase volume, <b>Q</b> (?) to decrease.
Exit to playback mode		End show and return to playback mode.

The dialog shown at right is displayed when the show ends. Select **Restart** to restart or **Exit** to return to the playback menu.



## Slide Show Options

Before starting a slide show, you can use the options in the slide show menu to select the images displayed by type or rating and choose how long each image is displayed.

- **Image type:** Choose from **Still images and movies**, **Still images only**, **Movies only**, and **By rating**. To

include only pictures with selected ratings, highlight **By rating** and press ►. A list of ratings will be displayed; highlight ratings and press ► to select or deselect pictures with the highlighted rating for inclusion in the slide show. Selected ratings are indicated by a check mark. Press OK to exit when the desired ratings are selected.

- **Frame interval:** Choose how long still images are displayed.

- **Transition effects:** Choose from **On** (each frame is pushed out of the display by the following frame) and **Off** (no transition between frames).

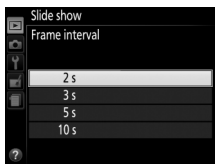



# Connections

## Installing ViewNX 2

Install the supplied software to display and edit photographs and movies that have been copied to your computer. Before installing ViewNX 2, confirm that your computer meets the system requirements on page 203. Be sure to use the latest version of ViewNX 2, which is available for download from the websites listed on page xviii, as earlier versions that do not support the D3300 may fail to transfer NEF (RAW) images correctly.

### 1 Launch the installer.

Start the computer, insert the installer CD, and launch the installer. A language selection dialog will be displayed. If the desired language is not available, click **Region Selection** to choose a different region (region selection is not available in the European release).

#### ① Select region (if required)

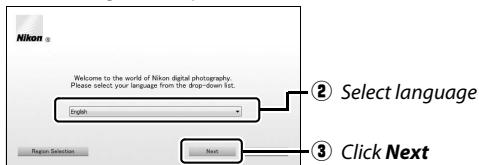

---

## 2 Start the installer.

Click **Install** and follow the on-screen instructions.



*Click **Install***

---

## 3 Exit the installer.

### Windows

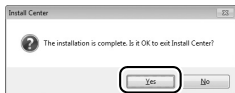

*Click **Yes***

### Mac

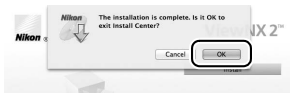

*Click **OK***

---

## 4 Remove the installer CD from the CD-ROM drive.

 **System Requirements**

	<b>Windows</b>	<b>Mac</b>
<b>CPU</b>	<ul style="list-style-type: none"><li>• <b>Photos:</b> Intel Celeron, Pentium 4, Core Series; 1.6 GHz or better</li><li>• <b>Movies (playback):</b> Pentium D 3.0 GHz or better; Intel Core i5 or better recommended when viewing movies with a frame size of 1280×720 or more at a frame rate of 30 fps or above or movies with a frame size of 1920×1080 or more</li><li>• <b>Movies (editing):</b> Intel Core i5 or better</li></ul>	<ul style="list-style-type: none"><li>• <b>Photos:</b> Intel Core or Xeon series</li><li>• <b>Movies (playback):</b> Core Duo 2 GHz or better; Intel Core i5 or better recommended when viewing movies with a frame size of 1280×720 or more at a frame rate of 30 fps or above or movies with a frame size of 1920×1080 or more</li><li>• <b>Movies (editing):</b> Intel Core i5 or better</li></ul>
<b>OS</b>	Pre-installed versions of Windows 8.1, Windows 7, Windows Vista, and Windows XP; note that 64-bit versions of Windows XP are not supported	OS X 10.9, 10.8, or 10.7
<b>Memory (RAM)</b>	<ul style="list-style-type: none"><li>• <b>32-bit Windows 8.1, Windows 7, or Windows Vista:</b> 1 GB or more (2 GB or more recommended)</li><li>• <b>64-bit Windows 8.1, Windows 7, or Windows Vista:</b> 2 GB or more (4 GB or more recommended)</li><li>• <b>Windows XP:</b> 512 MB or more (2 GB or more recommended)</li></ul>	2 GB or more (4 GB or more recommended)
<b>Hard disk space</b>	A minimum of 1 GB available on the startup disk (3 GB or more recommended)	
<b>Graphics</b>	<b>Resolution:</b> 1024×768 pixels (XGA) or more (1280×1024 pixels or more recommended) <b>Color:</b> 24-bit color (True Color) or more	<b>Resolution:</b> 1024×768 pixels (XGA) or more (1280×1024 pixels or more recommended) <b>Color:</b> 24-bit color (millions of colors) or more

See the websites listed on page xviii for the latest information on supported operating systems.

## Using ViewNX 2

### Copy Pictures to the Computer

Before proceeding, be sure you have installed the software on the supplied ViewNX 2 CD (☞ 201).

#### 1 Connect the USB cable.

After turning the camera off and ensuring that a memory card is inserted, connect the supplied USB cable as shown and then turn the camera on.

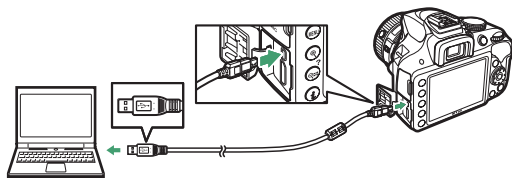

#### 2 Start Nikon Transfer 2 component of ViewNX 2.

If a message is displayed prompting you to choose a program, select Nikon Transfer 2.

##### Windows 7

If the following dialog is displayed, select Nikon Transfer 2 as described below.

- 1 Under **Import pictures and videos**, click **Change program**. A program selection dialog will be displayed; select **Import File using Nikon Transfer 2** and click **OK**.



- 2 Double-click **Import File**.

---

### 3 Click **Start Transfer**.

At default settings, pictures on the memory card will be copied to the computer.



**Start Transfer**

#### **During Transfer**

Do not turn the camera off or disconnect the USB cable while transfer is in progress.

---

### 4 Terminate the connection.

When transfer is complete, turn the camera off and disconnect the USB cable.

#### **Use a Reliable Power Source**

To ensure that data transfer is not interrupted, be sure the camera battery is fully charged.

#### **Connecting Cables**

Be sure the camera is off when connecting or disconnecting interface cables. Do not use force or attempt to insert the connectors at an angle. Close the connector cover when the connector is not in use.

#### **USB Hubs**

Transfer may not proceed as expected if the camera is connected via a USB hub or keyboard.

## View Pictures

Pictures are displayed in ViewNX 2 when transfer is complete.

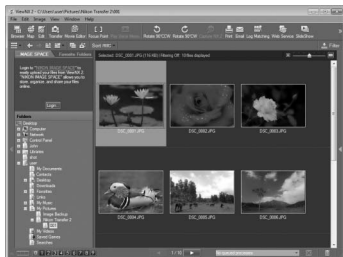

### Starting ViewNX 2 Manually

- Windows: Double-click the ViewNX 2 shortcut on the desktop.
- Mac: Click the ViewNX 2 icon in the Dock.

### Retouching Photographs

To crop pictures and perform such tasks as adjusting sharpness and tone levels, click the **Edit** button in the ViewNX 2 toolbar.



### Editing Movies

To perform such tasks as trimming unwanted footage from movies shot with the camera, click the **Movie Editor** button in the ViewNX 2 toolbar.



## ■ ■ *Printing Pictures*

Click the **Print** button in the ViewNX 2 toolbar. A dialog will be displayed, allowing you to print pictures on a printer connected to the computer.

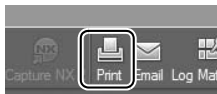

### ✔ **For More Information**

Consult online help for more information on using ViewNX 2.

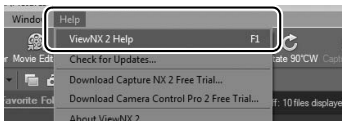

### ✔ **Viewing the Nikon Website**

To visit the Nikon website after installing ViewNX 2, select **All Programs > Link to Nikon** from the Windows start menu (Internet connection required).

## Printing Photographs

Selected JPEG images can be printed on a PictBridge printer (□ 352) connected directly to the camera.

### Connecting the Printer

Connect the camera using the supplied USB cable.

---

**1** Turn the camera off.

---

**2** Connect the USB cable.

Turn the printer on and connect the USB cable. Do not use force or attempt to insert the connectors at an angle.

---

**3** Turn the camera on.

A welcome screen will be displayed in the monitor, followed by a PictBridge playback display. To print pictures one at a time, proceed to page 209. To print multiple selected pictures or all pictures, proceed to page 211.

#### **Selecting Photographs for Printing**

NEF (RAW) photographs (□ 85) can not be selected for printing. JPEG copies of NEF (RAW) images can be created using the **NEF (RAW) processing** option in the retouch menu (□ 275).

#### **Date Imprint**

If you select **Print time stamp** in the PictBridge menu when printing photographs containing date information recorded using **Print date** in the setup menu (□ 254), the date will appear twice. The imprinted date may however be cropped out if the photographs are cropped or printed without a border.

#### **Panoramas**

Some printers may not print panoramas, while at some settings others may not print entire panoramas. See the printer manual for details.



## Printing Pictures One at a Time

---

### 1 Display the desired picture.

Press ◀ or ▶ to view additional pictures. Press the 🔍 button to zoom in on the current frame (☞ 182; press ▶ to exit zoom). To view six pictures at a time, press the 🔄 (?) button. Use the multi selector to highlight pictures, or press 🔍 to display the highlighted picture full frame.

---

### 2 Adjust printer settings.

Press Ⓚ to display the following items, then press ▲ or ▼ to highlight an item and press ▶ to view options (only options supported by the current printer are listed; to use the default option, select **Printer default**). After selecting an option, press Ⓚ to return to the printer settings menu.

Option	Description
Page size	Choose a page size.
No. of copies	This option is listed only when pictures are printed one at a time. Press ▲ or ▼ to choose number of copies (maximum 99).
Border	Choose whether to frame photos in white borders.
Time stamp	Choose whether to print the times and dates of recordings on photos.
Cropping	This option is listed only when pictures are printed one at a time. To exit without cropping, highlight <b>No cropping</b> and press Ⓚ. To crop the current picture, highlight <b>Crop</b> and press ▶. A crop selection dialog will be displayed; press 🔍 to increase the size of the crop, 🔄 (?) to decrease, and use the multi selector to position the crop. Note that print quality may drop if small crops are printed at large sizes.

---

### 3 Start printing.

Select **Start printing** and press **OK** to start printing. To cancel before all copies have been printed, press **OK**.

## Printing Multiple Pictures

---







### 1 Display the PictBridge menu.

Press the MENU button in the PictBridge playback display.

---

### 2 Choose an option.

Highlight one of the following options and press ►.

- **Print select:** Select pictures for printing. Use the multi selector to highlight pictures (to view the highlighted picture full screen, press and hold the  button) and keeping the  (?) button pressed, press ▲ or ▼ to choose the number of prints. To deselect a picture, set the number of prints to zero.
- **Select date:** Print one copy of all the pictures taken on selected dates. Press ▲ or ▼ to highlight dates and press ► to select or deselect. To view the pictures taken on the selected date, press  (?). Use the multi selector to scroll through the pictures, or press and hold  to view the current picture full screen. Press  (?) again to return to the date selection dialog.
- **Print (DPOF):** Print the current DPOF print order ( 213). The order can be viewed and modified before printing as described in the description for **Print select**, above.
- **Index print:** To create an index print of all JPEG pictures on the memory card, proceed to Step 3. Note that if the memory card contains more than 256 pictures, only the first 256 images will be printed. A warning will be displayed if the page size selected in Step 3 is too small for an index print.



---

### 3 Adjust printer settings.

Adjust printer settings as described in Step 2 on page 209.

---

### 4 Start printing.

Select **Start printing** and press  to start printing. To cancel before all copies have been printed, press .

## Creating a DPOF Print Order: Print Set

The **DPOF print order** option in the playback menu is used to create digital “print orders” for PictBridge-compatible printers and devices that support DPOF.

### 1 Choose DPOF print order > Select/set.

Press the **MENU** button and select **DPOF print order** in the playback menu. Highlight **Select/set** and press **▶** (to remove all photographs from the print order, select **Deselect all**).

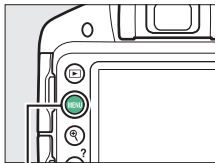

MENU button

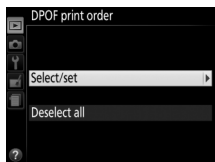

### 2 Select pictures.

Use the multi selector to highlight pictures (to view the highlighted picture full screen, press and hold the **🔍** button) and keeping the **🔍 (?)** button pressed, press **▲** or **▼** to choose the number of prints. To deselect a picture, set the number of prints to zero. Press **OK** when all the desired pictures have been selected.



### 3 Select imprint options.

Highlight the following options and press ► to toggle the highlighted option on or off.

- **Print shooting data:** Print shutter speed and aperture on all pictures in print order.
- **Print date:** Print date of recording on all pictures in print order.

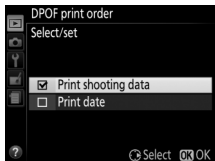

### 4 Complete the print order.

Press OK to complete the print order.

#### ✔ DPOF Print Order

To print the current print order when the camera is connected to a PictBridge printer, select **Print (DPOF)** in the PictBridge menu and follow the steps in "Printing Multiple Pictures" to modify and print the current order (□ 211). DPOF print date and shooting data options are not supported when printing via direct USB connection; to print the date of recording on photographs in the current print order, use the PictBridge **Time stamp** option.

The **DPOF print order** option can not be used if there is not enough space on the memory card to store the print order.

NEF (RAW) photographs (□ 85) can not be selected using this option. JPEG copies of NEF (RAW) images can be created using the **NEF (RAW) processing** option in the retouch menu (□ 275).

Print orders may not print correctly if images are deleted using a computer or other device after the print order is created.

## Viewing Pictures on TV

The supplied audio video (A/V) cable can be used to connect the camera to a television or video recorder for playback or recording. A High-Definition Multimedia Interface (HDMI) cable (available separately from third-party suppliers) with a mini HDMI connector (Type C) can be used to connect the camera to high-definition video devices.

### Standard Definition Devices

Before connecting the camera to a standard television, confirm that the camera video standard (📖 260) matches that used in the TV.

---

#### **1** Turn the camera off.

Always turn the camera off before connecting or disconnecting the A/V cable.

---

#### **2** Connect the A/V cable as shown.

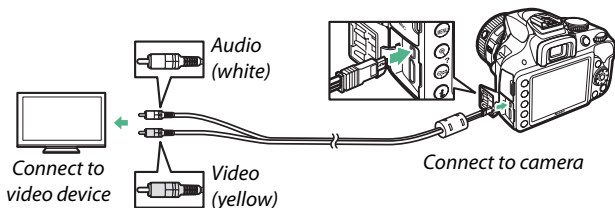

---

**3** Tune the television to the video channel.

---

**4** Turn the camera on and press the  button.

During playback, images will be displayed on the television screen. Note that the edges of images may not be displayed.

 **Video Mode**

If no image is displayed, check that camera is correctly connected and that the option selected for **Video mode** (📄 260) matches the video standard used in the TV.

 **Television Playback**

Use of an AC adapter (available separately) is recommended for extended playback.



## High-Definition Devices

The camera can be connected to HDMI devices using a third-party HDMI cable with a mini HDMI connector (Type C).

---

### 1 Turn the camera off.

Always turn the camera off before connecting or disconnecting an HDMI cable.

---

### 2 Connect the HDMI cable as shown.

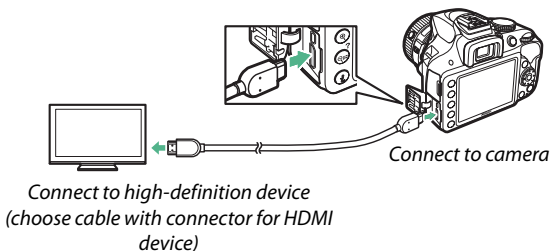

---

### 3 Tune the device to the HDMI channel.

---

### 4 Turn the camera on and press the button.

During playback, images will be displayed on the high-definition television or monitor screen. Note that the edges of images may not be displayed.

#### Playback Volume

Volume can be adjusted using television controls; the camera controls can not be used.

## ■ Choosing an Output Resolution

To choose the format for images output to the HDMI device, select **HDMI > Output resolution** in the camera setup menu (☞ 231). If **Auto** is selected, the camera will automatically select the appropriate format.

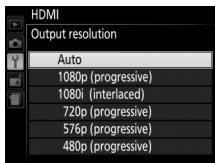

## ■ Controlling the Camera with the TV Remote

If **On** is selected for **HDMI > Device control** in the setup menu (☞ 231) when the camera is connected to a television that supports HDMI-CEC and both the camera and television are on, the television remote can be used in place of the camera multi selector and **OK** button during full-frame playback and slide shows. If **Off** is selected, the television remote can not be used to control the camera, but the camera can be used to shoot photographs and movies in live view.

### ✓ HDMI-CEC Devices

HDMI-CEC (**H**igh-**D**efinition **M**ultimedia **I**nterface–**C**onsumer **E**lectronics **C**ontrol) is a standard that allows HDMI devices to be used to control peripherals to which they are connected. When the camera is connected to an HDMI-CEC device, **ℓ ℓ ℓ** will appear in the viewfinder in place of the number of exposures remaining.

### ✓ 1920 × 1080 60p/50p

Selecting **1920 × 1080; 60p** or **1920 × 1080; 50p** for **Movie settings > Frame size/frame rate** may cause variations in the resolution and frame rate of the data output to HDMI devices during recording. During playback (☞ 162), HDMI devices will display the movie only; indicators will not be displayed.

### ✓ HDMI > Output Resolution

Movies can not be output at resolutions of **1920 × 1080; 60p** or **1920 × 1080; 50p**. Some devices may not support an **Output resolution** setting of **Auto**; in this case, select **1080i (interlaced)**.

# Camera Menus

## ▶ The Playback Menu: *Managing Images*

To display the playback menu, press **MENU** and select the  (playback menu) tab.

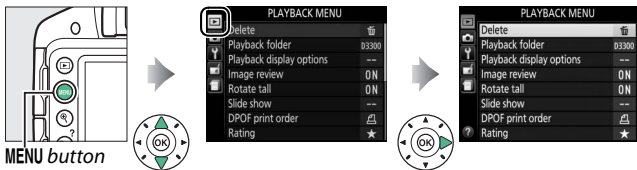

The playback menu contains the following options:

Option	Default	
Delete	—	193
Playback folder	Current	220
<b>Playback display options</b>		
Additional photo info	—	220
Transition effects	On	
Image review	On	221
Rotate tall	On	221
<b>Slide show</b>		
Image type	Still images and movies	198
Frame interval	2 s	
Transition effects	On	
DPOF print order	—	213
Rating	—	187
Select to send to smart device	—	190

## Playback Folder

MENU button →  playback menu

Choose a folder for playback:

Option	Description
<b>Current</b>	Only photos in the folder currently selected for <b>Storage folder</b> in the setup menu (  257) are displayed during playback. This option is selected automatically when a photo is taken; select <b>All</b> to view pictures in all folders.
<b>All</b>	Pictures in all folders will be visible during playback.

## Playback Display Options

MENU button →  playback menu

Choose the information available in the playback photo information display ( 172) and the transition between frames during playback.

- **Additional photo info:** Press ▲ or ▼ to highlight and press ► to select or deselect. Selected items are indicated by check marks. To return to the playback menu, press .

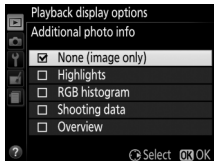

- **Transition effects:** Choose from **On** (each frame is pushed out of the display by the following frame) and **Off** (no transition between frames).

## Image Review

MENU button →  playback menu

Choose whether pictures are automatically displayed in the monitor immediately after shooting.

## Rotate Tall

MENU button →  playback menu



If **On** is selected, “tall” (portrait-orientation) pictures will be automatically rotated for display in the monitor (pictures taken with **Off** selected for **Auto image rotation** will still be displayed in landscape orientation;  243). Note that because the camera itself is already in the appropriate orientation during shooting, images are not rotated automatically during image review.



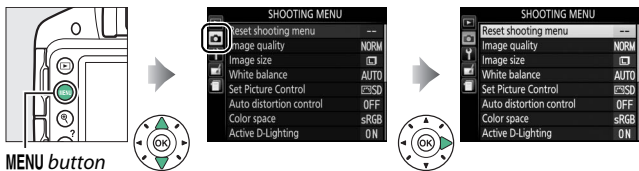

## The Shooting Menu: *Shooting Options*

To display the shooting menu, press **MENU** and select the  (shooting menu) tab.



The shooting menu contains the following options:

Option	Default		
<b>Reset shooting menu</b>	—	224	
<b>Image quality</b>	JPEG normal	85	
<b>Image size</b>			
	Normal panorama	88	
Other modes	Large	87	
<b>White balance</b>	Auto	124	
<b>Fluorescent</b>	Cool-white fluorescent	126	
<b>Set Picture Control</b>	Standard	135	
<b>Auto distortion control</b>	Off	225	
<b>Color space</b>	sRGB	225	
<b>Active D-Lighting</b>	On	122	
<b>Noise reduction</b>	On	226	
<b>ISO sensitivity settings</b>			
<b>ISO sensitivity</b>	<b>P, S, A, M</b>	100	95
	Other modes	Auto	
<b>Auto ISO sensitivity control</b>	Off	227	

Option		Default	
<b>AF-area mode</b>			
<b>Viewfinder</b>		Single-point AF	78
		Dynamic-area AF	
	Other modes	Auto-area AF	
<b>Live view/movie</b>		Face-priority AF	145
		Normal-area AF	
	Other modes	Wide-area AF	
<b>Built-in AF-assist illuminator</b>		On	228
<b>Metering</b>		Matrix metering	114
<b>Flash cntrl for built-in flash</b>		TTL	229
<b>Optical VR <sup>1</sup></b>		On	230
<b>Movie settings</b>			
<b>Frame size/frame rate <sup>2</sup></b>		—	158, 159
<b>Movie quality</b>		Normal	
<b>Microphone</b>		Auto sensitivity	
<b>Wind noise reduction</b>		Off	
<b>Manual movie settings</b>		Off	

1 Available only with lenses that support this item.

2 Default varies with country of purchase.

**Note:** Depending on camera settings, some items may be grayed out and unavailable.





## Reset Shooting Menu

MENU button →  shooting menu

Select **Yes** to reset shooting menu settings.

### Reset Shooting Options

Selecting **Yes** for **Reset shooting menu** also restores Picture Control settings to their default values (📖 137) and resets the following:

Option	Default	📖
Release mode		
	Continuous	67
Other modes	Single frame	
Focus point	Center	80
Flexible program	Off	103
AE-L/AF-L (  ) button hold	Off	252
Focus mode		
Viewfinder	Auto-servo AF	74
Live view/movie	Single-servo AF	144
Flash mode		
	Auto	89, 91
	Auto slow sync	
	Flash off	
P, S, A, M	Fill flash	
Exposure compensation	Off	118
Flash compensation	Off	120



## Auto Distortion Control

MENU button →  shooting menu

Select **On** to reduce barrel distortion in photos taken with wide-angle lenses and to reduce pin-cushion distortion in photos taken with long lenses (note that the edges of the area visible in the viewfinder may be cropped out of the final photograph, and that the time needed to process photographs before recording begins may increase). This option does not apply to movies and is available only with type G, E, and D lenses (PC, fisheye, and certain other lenses excluded); results are not guaranteed with other lenses.

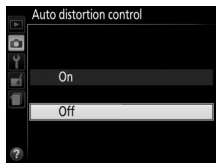

## Color Space

MENU button →  shooting menu

The color space determines the gamut of colors available for color reproduction. **sRGB** is recommended for movies and for general-purpose printing and display, **Adobe RGB** for professional publication and commercial printing.

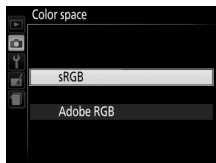

### Adobe RGB

For accurate color reproduction, Adobe RGB images require applications, displays, and printers that support color management.

### Color Space

ViewNX 2 (supplied) and Capture NX 2 (available separately) automatically select the correct color space when opening photographs created with this camera. Results can not be guaranteed with third-party software.

## Noise Reduction

MENU button →  shooting menu

Select **On** to reduce noise (bright spots, randomly-spaced bright pixels, lines, or fog). Noise reduction takes effect at all ISO sensitivities, but is most noticeable at higher values. The time required for processing at shutter speeds slower than about 1 s roughly doubles; during processing, “*u00b0*” will flash in the viewfinder and photographs can not be taken. Noise reduction will not be performed if the camera is turned off before processing is complete.



If **Off** is selected, noise reduction will only be performed as required; the amount of noise reduction is less than that performed when **On** is selected.

## ISO Sensitivity Settings

MENU button →  shooting menu

Adjust ISO sensitivity (📖 95).

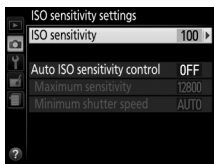

## ■ Auto ISO Sensitivity control

If **Off** is chosen for **Auto ISO sensitivity control** in **P**, **S**, **A**, and **M** modes, ISO sensitivity will remain fixed at the value selected by the user (□ 95). When **On** is chosen, ISO sensitivity will automatically be adjusted if optimal exposure can not be achieved at the value selected by the user. The maximum value for auto ISO sensitivity can be selected using the **Maximum sensitivity** option in the **Auto ISO sensitivity control** menu (choose lower values to prevent noise (randomly-spaced bright pixels, fog, or lines), but note that if the ISO sensitivity selected by the user is higher than that chosen for **Maximum sensitivity**, the value selected by the user will be used instead; the minimum value for auto ISO sensitivity is automatically set to ISO 100). In modes **P** and **A**, sensitivity will only be adjusted if underexposure would result at the shutter speed selected for **Minimum shutter speed** ( $1/2000-1$  s, or **Auto**; in modes **S** and **M**, sensitivity will be adjusted for optimal exposure at the shutter speed selected by the user). If **Auto** (available only with CPU lenses) is selected, the camera will choose the minimum shutter speed based on the focal length of the lens. Slower shutter speeds will be used only if optimum exposure can not be achieved at the ISO sensitivity value selected for **Maximum sensitivity**.

When **On** is selected, the viewfinder shows **ISO-AUTO** and the information display shows **ISO-A**. These indicators flash when sensitivity is altered from the value selected by the user.



### **Maximum Sensitivity/Minimum Shutter Speed**

When auto ISO sensitivity control is enabled, the ISO sensitivity and shutter speed graphics in the information display show the maximum sensitivity and minimum shutter speed.

*Maximum sensitivity*

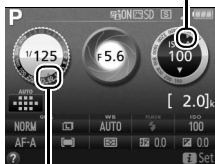

*Minimum shutter speed*

### **Auto ISO Sensitivity Control**

Noise (randomly-spaced bright pixels, fog, or lines) is more likely at higher sensitivities. Use the **Noise Reduction** option in the shooting menu to reduce noise (☞ 226). Note that ISO sensitivity may be raised automatically when auto ISO sensitivity control is used in combination with slow sync flash modes (available with the built-in flash and the optional flash units listed on page 299), possibly preventing the camera from selecting slow shutter speeds. Auto ISO sensitivity control is available only in i-TTL flash control mode (☞ 229, 301); in other modes, the value selected for **ISO sensitivity** will be used for pictures taken with the built-in flash or optional flash units.

## **Built-in AF-assist Illuminator**

MENU button →  shooting menu

Choose whether the built-in AF-assist illuminator lights to assist the focus operation when lighting is poor.

*AF-assist illuminator*

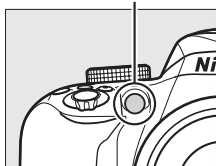



Option	Description
<b>On</b>	The AF-assist illuminator lights when lighting is poor (for more information, see page 331).
<b>Off</b>	The AF-assist illuminator does not light to assist the focus operation. The camera may not be able to focus using autofocus when lighting is poor.

## Flash Cntrl for Built-in Flash



MENU button →  shooting menu

Choose the flash mode for the built-in flash in **P**, **S**, **A**, and **M** modes.

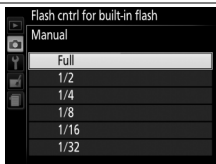
Option	Description
TTL 	Flash output is adjusted automatically in response to shooting conditions.
<b>M  Manual</b>	Choose a flash level. At full power, the built-in flash has a Guide Number of approximately 12/39 (m/ft., ISO 100, 20 °C/68 °F).



### Manual

A  icon flashes in the viewfinder and  flashes in the information display when **Manual** is selected and the flash is raised.



### The SB-400 and SB-300

When an optional SB-400 or SB-300 flash unit is attached and turned on, **Flash cntrl for built-in flash** changes to **Optional flash**, allowing the flash control mode for the optional flash unit to be selected from **TTL** and **Manual**.

### TTL Flash Control

The following types of flash control are supported when a CPU lens is used in combination with the built-in flash (□ 89) or optional flash units (□ 299).

- **i-TTL Balanced Fill-Flash for Digital SLR:** Information from the 420-pixel RGB sensor is used to adjust flash output for a natural balance between the main subject and the background.
- **Standard i-TTL Fill-Flash for Digital SLR:** Flash output is adjusted for the main subject; the brightness of the background is not taken into account.

Standard i-TTL flash control is used with spot metering or when selected with the optional flash unit. i-TTL balanced fill-flash for digital SLR is used in all other cases.

## Optical VR

MENU button →  shooting menu

This item is displayed only with lenses that support it. Selecting **On** enables vibration reduction, which takes effect whenever the shutter-release button is pressed halfway (□ 356). Select **Off** to disable vibration reduction.

### The Vibration Reduction Indicator

A vibration reduction indicator appears in the information display when **On** is selected for **Optical VR**.



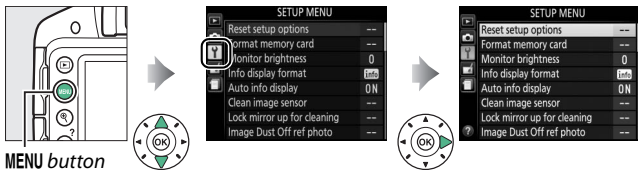

## Y The Setup Menu: Camera Setup

To display the setup menu, press **MENU** and select the **Y** (setup menu) tab.



The setup menu contains the following options:

Option	Default	
<b>Reset setup options</b>	—	233
<b>Format memory card</b>	—	234
<b>Monitor brightness</b>	0	235
<b>Info display format</b>		
<b>AUTO/SCENE/EFFECTS</b>	Graphic	236
<b>P/S/A/M</b>	Graphic	
<b>Auto info display</b>	On	238
<b>Clean image sensor</b>		
<b>Clean at startup/shutdown</b>	Clean at startup & shutdown	314
<b>Lock mirror up for cleaning<sup>1</sup></b>	—	317
<b>Image Dust Off ref photo</b>	—	239
<b>Flicker reduction</b>	Auto	241
<b>Time zone and date<sup>2</sup></b>		
<b>Daylight saving time</b>	Off	242
<b>Language<sup>2</sup></b>	—	243
<b>Auto image rotation</b>	On	243

Option	Default	
Image comment	—	244
Auto off timers	Normal	245
<b>Self-timer</b>		
Self-timer delay	10 s	246
Number of shots	1	
Remote on duration (ML-L3)	1 min	247
Beep	Low	247
Rangefinder	Off	248
File number sequence	Off	249
<b>Buttons</b>		
Assign Fn button	ISO sensitivity	251
Assign AE-L/AF-L button	AE/AF lock	252
Shutter-release button AE-L	Off	252
Slot empty release lock	Release locked	253
Print date	Off	254
Storage folder	—	257
<b>Accessory terminal</b>		
<b>Remote control</b>		
Remote shutter release	Take photos	258
Assign Fn button	Same as camera  button	
<b>Location data</b>		
Standby timer	Enable	259
Set clock from satellite	Yes	



Option	Default	
<b>Video mode</b> <sup>2</sup>	—	260
<b>HDMI</b>		
<b>Output resolution</b>	Auto	218
<b>Device control</b>	On	
<b>Wireless mobile adapter</b>	Enable	260
<b>Eye-Fi upload</b> <sup>3</sup>	Enable	261
<b>Firmware version</b>	—	262

1 Not available when battery is low.

2 Default varies with country of purchase.

3 Only available when compatible Eye-Fi memory card is inserted ( 261).

**Note:** Depending on camera settings, some items may be grayed out and unavailable.

## Reset Setup Options

MENU button →  setup menu

Select **Yes** to reset all setup menu settings except **Time zone and date**, **Language**, **Storage folder**, and **Video mode** to the defaults listed above.

## Format Memory Card

MENU button →  setup menu

Memory cards must be formatted before first use or after being formatted in other devices. Format the card as described below.

### **Formatting Memory Cards**

*Formatting memory cards permanently deletes any data they may contain.* Be sure to copy any photographs and other data you wish to keep to a computer before proceeding ( 204).

#### **1 Highlight Yes.**

To exit without formatting the memory card, highlight **No** and press .



#### **2 Press .**

A message will be displayed while the card is formatted. *Do not remove the memory card or remove or disconnect the power source until formatting is complete.*



## Monitor Brightness

MENU button →  setup menu

Press ▲ or ▼ to choose monitor brightness. Choose higher values for increased brightness, lower values for reduced brightness.

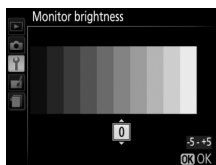

## Info Display Format

MENU button →  setup menu

Choose an information display format (📖 7). Formats can be chosen separately for auto, scene, and special effects modes and for **P**, **S**, **A**, and **M** modes.





Classic (📖 237)

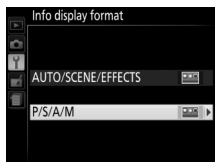

Graphic (📖 7)

- 1 Select a shooting mode option.**  
Highlight **AUTO/SCENE/EFFECTS** or **P/S/A/M** and press .



- 2 Select a design.**  
Highlight a design and press .



The “Classic” display is shown below.

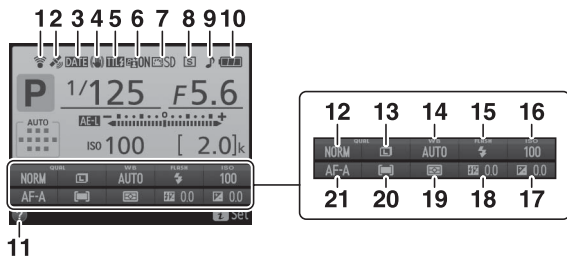

<b>1</b> Eye-Fi connection indicator ..... 261	<b>11</b> Help icon ..... 11, 336
<b>2</b> Satellite signal indicator ..... 260	<b>12</b> Image quality ..... 85
<b>3</b> Print date indicator ..... 254	<b>13</b> Image size ..... 87
<b>4</b> Vibration reduction indicator ..... 23, 230	<b>14</b> White balance ..... 124
<b>5</b> Flash control indicator ..... 229	<b>15</b> Flash mode ..... 90, 92
Flash compensation indicator for optional flash units ..... 304	<b>16</b> ISO sensitivity ..... 95
<b>6</b> Active D-Lighting ..... 122	<b>17</b> Exposure compensation ..... 118
<b>7</b> Picture Control ..... 135	<b>18</b> Flash compensation ..... 120
<b>8</b> Release mode ..... 67	<b>19</b> Metering ..... 114
<b>9</b> “Beep” indicator ..... 247	<b>20</b> AF-area mode ..... 78, 145
<b>10</b> Battery indicator ..... 21	<b>21</b> Focus mode ..... 74, 144

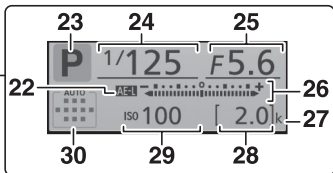

<p><b>22</b> Autoexposure (AE) lock indicator ..... 116</p> <p><b>23</b> Shooting mode              AUTO auto/              Ⓢ auto (flash off) ..... 25              Scene modes ..... 47              Special effects mode ..... 50              <b>P, S, A, and M</b> modes ..... 100</p> <p><b>24</b> Shutter speed ..... 101</p> <p><b>25</b> Aperture (f-number) ..... 101</p> <p><b>26</b> Exposure indicator ..... 109              Exposure compensation              indicator ..... 119</p>	<p><b>27</b> "k" (appears when memory              remains for over 1000 exposures)              ..... 19</p> <p><b>28</b> Number of exposures remaining              ..... 19              White balance recording              indicator ..... 130</p> <p><b>29</b> ISO sensitivity ..... 95              Auto ISO sensitivity indicator              ..... 227</p> <p><b>30</b> Auto-area AF indicator ..... 78              3D-tracking indicator ..... 78              Focus point ..... 80</p>
---	--

**Note:** Display shown with all indicators lit for illustrative purposes.

## Auto Info Display

MENU button → setup menu

If **On** is selected, the information display will appear after the shutter-release button is pressed halfway. If **Off** is selected, the information display can be viewed by pressing the button.

## Image Dust Off Ref Photo

MENU button → Y setup menu

Acquire reference data for the Image Dust Off option in Capture NX 2 (available separately; for more information, see the Capture NX 2 manual).

**Image Dust Off ref photo** is available only when a CPU lens is mounted on the camera. A lens with a focal length of at least 50 mm is recommended. When using a zoom lens, zoom all the way in.

### 1 Choose a start option.

Highlight one of the following options and press . To exit without acquiring image dust off data, press MENU.



- **Start:** The message shown at right will be displayed and “rEF” will appear in the viewfinder.
- **Clean sensor and then start:** Select this option to clean the image sensor before starting. The message shown at right will be displayed and “rEF” will appear in the viewfinder when cleaning is complete.



#### Image Sensor Cleaning

Image Dust Off reference data recorded before image sensor cleaning is performed can not be used with photographs taken after image sensor cleaning is performed. Select **Clean sensor and then start** only if the Image Dust Off reference data will not be used with existing photographs.

---

## 2 Frame a featureless white object in the viewfinder.

With the lens about ten centimeters (four inches) from a well-lit, featureless white object, frame the object so that it fills the viewfinder and then press the shutter-release button halfway.

In autofocus mode, focus will automatically be set to infinity; in manual focus mode, set focus to infinity manually.

---

## 3 Acquire Image Dust Off reference data.

Press the shutter-release button the rest of the way down to acquire Image Dust Off reference data.

If the reference object is too bright or too dark, the camera may be unable to acquire Image Dust Off reference data and the message shown at right will be displayed. Choose another reference object and repeat the process from step 1.



### Image Dust Off Reference Data



The same reference data can be used for photographs taken with different lenses or at different apertures. Reference images can not be viewed using computer imaging software. A grid pattern is displayed when reference images are viewed on the camera.





## Flicker Reduction

MENU button →  setup menu

Reduce flicker and banding when shooting under fluorescent or mercury-vapor lighting during live view ( 142) or movie recording ( 155). Choose **Auto** to allow the camera to automatically choose the correct frequency, or manually match the frequency to that of the local AC power supply.

### Flicker Reduction



If **Auto** fails to produce the desired results and you are unsure as to the frequency of the local power supply, test both options and choose the one that produces the best results. Flicker reduction may not produce the desired results if the subject is very bright, in which case you should select mode **A** or **M** and choose a smaller aperture (higher f-number) before starting live view. Note that flicker reduction is not available when **On** is selected for **Movie settings > Manual movie settings** ( 159) in mode **M**.

## Time Zone and Date

MENU button →  setup menu

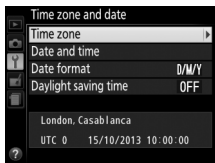
Change time zones, set the camera clock, choose the date display order, and turn daylight saving time on or off.

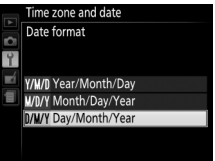
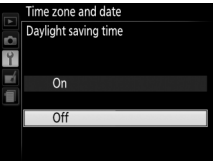

Option	Description	
<b>Time zone</b>	Choose a time zone. The camera clock is automatically set to the time in the new time zone.	
<b>Date and time</b>	Set the camera clock (📖 18).	
<b>Date format</b>	Choose the order in which the day, month, and year are displayed.	
<b>Daylight saving time</b>	Turn daylight saving time on or off. The camera clock will automatically be advanced or set back one hour.	

## Language

MENU button →  setup menu

Choose a language for camera menus and messages.

## Auto Image Rotation

MENU button →  setup menu

Photographs taken while **On** is selected contain information on camera orientation, allowing them to be rotated automatically during playback or when viewed in ViewNX 2 or Capture NX 2 (available separately). The following orientations are recorded:



*Landscape (wide)  
orientation*



*Camera rotated 90°  
clockwise*



*Camera rotated 90°  
counterclockwise*



Camera orientation is not recorded when **Off** is selected. Choose this option when panning or taking photographs with the lens pointing up or down.

### Rotate Tall



To automatically rotate “tall” (portrait-orientation) photographs for display during playback, select **On** for the **Rotate tall** option in the playback menu (☐ 221).

## Image Comment

MENU button →  setup menu



Add a comment to new photographs as they are taken. Comments can be viewed as metadata in ViewNX 2 (supplied) or Capture NX 2 (available separately;  307). The comment is also visible on the shooting data page in the photo information display ( 177). The following options are available:

- **Input comment:** Input a comment as described below. Comments can be up to 36 characters long.

- **Attach comment:** Select this option to attach the comment to all subsequent photographs. **Attach comment** can be turned on and off by highlighting it and pressing . After choosing the desired setting, press  to exit.



### Text Entry

The dialog at right is displayed when text entry is required. Use the multi selector to highlight the desired character in the keyboard area and press  to insert the highlighted character at the current cursor position (note that if a character is entered when the field is full, the last character in the field will be deleted). To delete the character under the cursor, press the  button. To move the cursor to a new position, rotate the command dial. To complete entry and return to the previous menu, press . To exit without completing text entry, press MENU.

*Keyboard area*





*Text display area*

## Auto off Timers

MENU button →  setup menu

This option determines how long the monitor remains on if no operations are performed during menu display and playback (**Playback/menus**), while photographs are displayed in the monitor after shooting (**Image review**), and during live view (**Live view**), and how long the standby timer, viewfinder, and information display remain on when no operations are performed (**Standby timer**). Choose shorter auto-off delays to reduce the drain on the battery.

Option	Description (all times are approximate)				
SHORT <b>Short</b> NORM <b>Normal</b> LONG <b>Long</b>	Auto off timers are set to the following values:				
		Playback/ menus	Image review	Live view	Standby timer
	Short	20 s	4 s	5 min.	4 s
	Normal	1 min.	4 s	10 min.	8 s
Long	5 min.	20 s	20 min.	1 min.	
 <b>Custom</b>	Choose separate delays for <b>Playback/menus</b> , <b>Image review</b> , <b>Live view</b> , and <b>Standby timer</b> . When settings are complete, press  .				

### Auto off Timers

The monitor and viewfinder will not turn off automatically when the camera is connected to a computer or printer via USB.

## Self-Timer

MENU button →  setup menu

Choose the length of the shutter release delay and the number of shots taken.



- **Self-timer delay:** Choose the length of the shutter-release delay.



- **Number of shots:** Press ▲ and ▼ to choose the number of shots taken each time the shutter-release button is pressed (from 1 to 9; if a value other than 1 is selected, shots will be taken at intervals of about 4 seconds).



## Remote on Duration (ML-L3)

MENU button →  setup menu



Choose how long the camera will wait for a signal from the optional ML-L3 remote control before cancelling remote release mode. Choose shorter times for longer battery life. This setting applies only during viewfinder photography.



## Beep

MENU button →  setup menu

Choose the pitch (**High** or **Low**) of the beep that sounds when the camera focuses and in self-timer and remote-control modes. Select **Off** to prevent the beep from sounding.







The current setting is shown in the information display:  is displayed when the beep is on,  when it is off.



## Rangefinder

MENU button →  setup menu

Choose **On** to use the exposure indicator to determine whether the camera is correctly focused in manual focus mode (☐ 83; note that this function is not available in shooting mode **M**, when the exposure indicator instead shows whether the subject is correctly exposed).

Indicator	Description
	Subject in focus.
	Focus point is slightly in front of subject.
	Focus point is well in front of subject.
	Focus point is slightly behind subject.
	Focus point is well behind subject.
	Camera can not determine correct focus.

### Using the Electronic Rangefinder

The electronic rangefinder requires a lens with a maximum aperture of  $f/5.6$  or faster. The desired results may not be achieved in situations in which the camera would be unable to focus using autofocus (☐ 76). The electronic rangefinder is not available during live view.



## File Number Sequence

MENU button →  setup menu

When a photograph is taken, the camera names the file by adding 1 to the last file number used. This option controls whether file numbering continues from the last number used when a new folder is created, the memory card is formatted, or a new memory card is inserted in the camera.

Option	Description
<b>On</b>	When a new folder is created, the memory card formatted, or a new memory card inserted in the camera, file numbering continues from the last number used. If a photograph is taken when the current folder contains a photograph numbered 9999, a new folder will be created automatically and file numbering will begin again from 0001.
<b>Off</b>	File numbering is reset to 0001 when a new folder is created, the memory card is formatted, or a new memory card is inserted in the camera. Note that a new folder is created automatically if a photograph is taken when the current folder contains 999 photographs.
<b>Reset</b>	Resets the file numbering for <b>On</b> to 0001 and creates a new folder with the next photograph taken.

### File Number Sequence

If the current folder is numbered 999 and contains either 999 photographs or a photograph numbered 9999, the shutter-release button will be disabled and no further photographs can be taken. Choose **Reset** for **File number sequence** and then either format the current memory card or insert a new memory card.

### File Names

Photographs are stored as image files with names of the form “DSC\_#####.xxx,” where ##### is a four-digit number between 0001 and 9999 assigned automatically in ascending order by the camera, and xxx is one of the following three-letter extensions: “NEF” for NEF (RAW) images, “JPG” for JPEG images, or “MOV” for movies. The NEF and JPEG files recorded at a setting of NEF (RAW)+JPEG have the same file names but different extensions. Copies created with image overlay (☐ 272) and movie edit options (☐ 164) have file names beginning with “DSC\_” ; copies created with the other options in the retouch menu have file names beginning with “CSC” (e.g., “CSC\_0001.JPG”). Images recorded with the **Color space** option in the shooting menu set to **Adobe RGB** (☐ 225) have names that begin with an underscore (e.g., “\_DSC0001.JPG”).

### ■ ■ Assign Fn Button

Choose the role played by the **Fn** button.

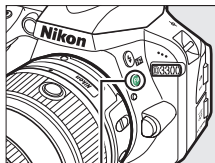

**Fn** button



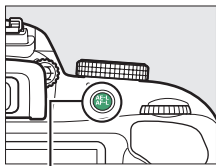

Option	Description
QUAL <b>Image quality/ size</b>	Keeping the <b>Fn</b> button pressed, rotate the command dial to select image quality and size (□ 85).
ISO <b>ISO sensitivity</b>	Keeping the <b>Fn</b> button pressed, rotate the command dial to select ISO sensitivity (□ 95).
WB <b>White balance</b>	Keeping the <b>Fn</b> button pressed, rotate the command dial to select white balance ( <b>P</b> , <b>S</b> , <b>A</b> , and <b>M</b> modes only; □ 124).
 <b>Active D-Lighting</b>	Keeping the <b>Fn</b> button pressed, rotate the command dial to select Active D-Lighting ( <b>P</b> , <b>S</b> , <b>A</b> , and <b>M</b> modes only; □ 122).

## ■ Assign AE-L/AF-L Button

Choose the role played by the  $\overset{\text{AE-L}}{\text{AF-L}}$  (On) button.



$\overset{\text{AE-L}}{\text{AF-L}}$  (On) button

Option	Description
 <b>AE/AF lock</b>	Focus and exposure lock while the $\overset{\text{AE-L}}{\text{AF-L}}$ (On) button is pressed.
 <b>AE lock only</b>	Exposure locks while the $\overset{\text{AE-L}}{\text{AF-L}}$ (On) button is pressed.
 <b>AE lock (Hold)</b>	Exposure locks when the $\overset{\text{AE-L}}{\text{AF-L}}$ (On) button is pressed, and remains locked until the button is pressed a second time or the standby timer expires.
 <b>AF lock only</b>	Focus locks while the $\overset{\text{AE-L}}{\text{AF-L}}$ (On) button is pressed.
 <b>AF-ON</b>	The $\overset{\text{AE-L}}{\text{AF-L}}$ (On) button initiates autofocus. The shutter-release button can not be used to focus.

## ■ Shutter-Release Button AE-L

If **On** is selected, exposure will lock when the shutter-release button is pressed halfway.

## Slot Empty Release Lock

MENU button →  setup menu

If **Release locked** is selected, the shutter-release button is only enabled when a memory card is inserted in the camera. Selecting **Enable release** allows the shutter to be released when no memory card is inserted, although no pictures will be recorded (they will however be displayed in the monitor in demo mode).

## Print Date

MENU button →  setup menu

Choose the date information imprinted on photographs as they are taken. Date imprints can not be added to or removed from existing photos.

Option	Description
<b>Off</b>	The time and date do not appear on photographs.
DATE <b>Date</b>	The date or date and time are imprinted on photographs taken while this option is in effect. <b>10.15.2013</b>
DATE ⊕ <b>Date and time</b>	<b>10.15.2013 10:02</b>
 <b>Date counter</b>	New photos are imprinted with a time stamp showing the number of days between the date of shooting and a selected date (see below).

At settings other than **Off**, the selected option is indicated by a **DATE** icon in the information display.



### Print Date

The date is recorded in the order selected for **Time zone and date** (☞ 242). The imprinted data may be cropped out or rendered illegible in copies created when images are retouched (☞ 263). The date does not appear on panoramas or on NEF (RAW) or NEF (RAW)+JPEG images.

## ■ ■ Date Counter

Pictures taken while this option is in effect are imprinted with the number of days remaining until a future date or the number of days elapsed since a past date. Use it to track the growth of a child or count down the days until a birthday or wedding.

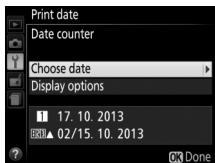

*Future date  
(two days remaining)*

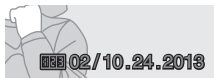

*Past date  
(two days elapsed)*

The camera offers three slots for storing dates.

### 1 Enter the first date.

The first time you select **Date counter**, you will be prompted to enter a date for the first slot. Enter a date using the multi selector and press **OK** to exit to the date list.

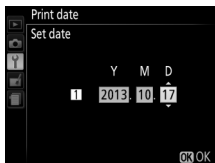

### 2 Enter additional dates or edit existing dates.

To change a date or enter additional dates, highlight a slot, press **►**, and enter a date as described above.

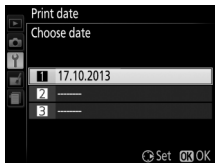



---

### 3 Choose a date.

Highlight a slot in the date list and press .



- 
- ### 4 Choose a date counter format.
- Highlight **Display options** and press , then highlight a date format and press .

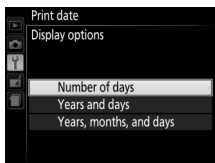

---

### 5 Exit the date counter menu.

Press  to exit the date counter menu.



## Storage Folder

MENU button →  setup menu

Create, rename, or delete folders, or choose the folder in which subsequent photographs will be stored.

- **Select folder:** Choose the folder in which subsequent photographs will be stored.



- **New:** Create a new folder and name it as described on page 244. Folder names can be up to five characters long.
- **Rename:** Select a folder from the list and rename it as described on page 244.
- **Delete:** Delete all empty folders on the memory card.

### Folder Names

On the memory card, folder names are preceded by a three-digit folder number assigned automatically by the camera (e.g., 100D3300). Each folder can contain up to 999 photographs. During shooting, pictures are stored in the highest-numbered folder with the selected name. If a photograph is taken when the current folder is full or contains a photograph numbered 9999, the camera will create a new folder by adding 1 to the current folder number (e.g., 101D3300). The camera treats folders with the same name but different folder numbers as the same folder. For example, if the folder NIKON is selected for **Storage folder**, photographs in all folders named NIKON (100NIKON, 101NIKON, 102NIKON, etc.) will be visible when **Current** is selected for **Playback folder** (📖 220). Renaming changes all folders with the same name but leaves the folder numbers intact. Selecting **Delete** deletes empty numbered folders but leaves other folders with the same name intact.

## Accessory Terminal

MENU button →  setup menu



Choose the role of the optional accessory connected to the accessory terminal.

### Remote Control

Choose the functions performed using a remote cord or wireless remote controller (□ 308, 309).





### Remote Shutter Release

Choose whether the shutter-release button on the optional accessory is used for photography or movie recording.

Option	Description
 <b>Take photos</b>	The shutter-release button on the optional accessory is used to take photographs.
 <b>Record movies</b>	The shutter-release button on the optional accessory is used for movie recording. Press the button halfway to start live view or to focus in <b>AF-S</b> and <b>AF-F</b> modes. Press the button all the way down to start or end recording. Use the camera  button to end live view.

### Assign Fn button

Choose the role played by the **Fn** buttons on wireless remote controllers.

Option	Description
 <b>Same as camera button</b>	The <b>Fn</b> button on the wireless remote controller performs the function currently assigned to the camera  (  ) button (□ 252).
 <b>Live view</b>	The <b>Fn</b> button on the wireless remote controller can be used to start and end live view.

## Location Data

This item is used to adjust settings for optional GP-1 or GP-1A GPS units (☞ 309). The unit can be connected to the camera's accessory terminal (☞ 309) using the cable supplied with the device, allowing information on the camera's current position to be recorded when photographs are taken (turn the camera off before connecting the unit; for more information, see the manual provided with the device).

The **Location data** menu contains the options listed below.

- **Standby timer:** Choose whether or not the standby timer is enabled when the unit is attached.

Option	Description
<b>Enable</b>	Standby timer enabled. The timer expires automatically if no operations are performed for the time selected for <b>Auto off timers &gt; Standby timer</b> in the setup menu (☞ 245; to allow the camera time to acquire location data, the delay is extended by up to one minute after standby timer is activated or the camera is turned on). This reduces the drain on the battery. Note that the unit will remain active to acquire location data for a set period after the timer expires.
<b>Disable</b>	Standby timer disabled, ensuring uninterrupted recording of location data.



- **Position:** This item is only available if a GP-1 or GP-1A is connected, when it displays the current latitude, longitude, altitude, and Coordinated Universal Time (UTC) as reported by the unit.
- **Set clock from satellite:** Choose **Yes** to set the camera clock based on the time provided by the satellite navigation system.

### Coordinated Universal Time (UTC)

UTC data is provided by the location data satellite system and is independent of the camera clock.

### The Satellite Signal Indicator

Connection status is shown as follows:

-  (**static**): Location data acquired.
-  (**flashing**): The unit is searching for a signal. Pictures taken while the icon is flashing do not include location data.
- **No icon**: No new location data have been received from the unit for at least two seconds. Pictures taken when the  icon is not displayed do not include location data.



## Video Mode

MENU button →  setup menu

When connecting the camera to a television or VCR, be sure the camera video mode matches the device video standard (NTSC or PAL).

## Wireless Mobile Adapter

MENU button →  setup menu

Choose whether the camera will establish wireless connections with smart devices when an optional WU-1a wireless mobile adapter (☞ 309) is attached to the camera USB and A/V connector.

Option	Description
<b>Enable</b>	Enable wireless connections to smart devices running the Wireless Mobile Utility.
<b>Disable</b>	Disable wireless connections to smart devices. Choose this option in locations where the use of wireless devices is prohibited. Selecting this option also reduces the drain on the camera battery.





## Eye-Fi Upload

MENU button →  setup menu

This option is displayed only when an Eye-Fi memory card (available separately from third-party suppliers) is inserted in the camera. Choose **Enable** to upload photographs to a preselected destination. Note that pictures will not be uploaded if signal strength is insufficient.

Observe all local laws concerning wireless devices and choose **Disable** where wireless devices are prohibited.

When an Eye-Fi card is inserted, its status is indicated by an icon in the information display:

- : Eye-Fi upload disabled.
- : Eye-Fi upload enabled but no pictures available for upload.
-  (static): Eye-Fi upload enabled; waiting to begin upload.
-  (animated): Eye-Fi upload enabled; uploading data.
- : Error.



### Eye-Fi Cards

Whether due to errors or other causes, Eye-Fi cards may emit wireless signals when **Disable** is selected. If a warning is displayed in the monitor ( 337), turn the camera off and remove the card.

The camera can be used to turn Eye-Fi cards on and off, but may not support other Eye-Fi functions. Be sure to keep the card firmware updated. See the documentation provided with the Eye-Fi card for more information; for information on the availability of Eye-Fi cards in your country or region, contact the manufacturer.

Eye-Fi cards can not be used to upload photographs when an optional WU-1a wireless mobile adapter is connected.

### Using Eye-Fi Cards in Ad Hoc Mode

Additional time may be required when connecting using Eye-Fi cards that support ad hoc mode. Select longer values for **Auto off timers** > **Standby timer** in the setup menu (📖 245).

## Firmware Version

MENU button → 🗝️ setup menu







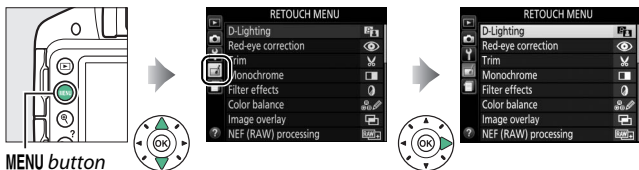













View the current camera firmware version.

## The Retouch Menu: Creating Retouched Copies

To display the retouch menu, press **MENU** and select the  (retouch menu) tab.



The retouch menu is used to create trimmed or retouched copies of the photographs on the memory card, and is only available when a memory card containing photographs is inserted in the camera.

Option		Option	
 <b>D-Lighting</b>	266	 <b>Distortion control</b>	280
 <b>Red-eye correction</b>	267	 <b>Fisheye</b>	280
 <b>Trim</b>	268	 <b>Color outline</b>	281
 <b>Monochrome</b>	269	 <b>Photo illustration</b>	281
 <b>Filter effects</b>	270	 <b>Color sketch</b>	282
 <b>Color balance</b>	271	 <b>Perspective control</b>	282
 <b>Image overlay</b>	272	 <b>Miniature effect</b>	283
 <b>NEF (RAW) processing</b>	275	 <b>Selective color</b>	284
 <b>Resize</b>	277	 <b>Edit movie</b>	164
 <b>Quick retouch</b>	279	 <b>Side-by-side comparison *</b>	286
 <b>Straighten</b>	279		

\* Available only if retouch menu is displayed by pressing **i** and selecting **Retouch** in full-frame playback when a retouched image or original is displayed.

## Creating Retouched Copies

To create a retouched copy:

- 1 Display retouch options.**  
Highlight the desired item in the retouch menu and press **▶**.

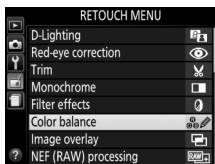

- 2 Select a picture.**  
Highlight a picture and press **OK** (to view the highlighted picture full screen, press and hold the **Q** button).

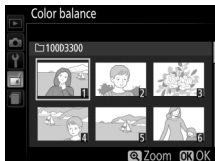

### Retouch

The camera may not be able to display or retouch images created with other devices. If the image was recorded at image quality settings of NEF (RAW) + JPEG (85), retouch options apply only to the RAW copy.

- 3 Select retouch options.**  
For more information, see the section for the selected item. To exit without creating a retouched copy, press **MENU**.





## 4 Create a retouched copy.

Press **OK** to create a retouched copy. Except in the photo information “image only” page (172), retouched copies are indicated by a  icon.



### **Creating Retouched Copies During Playback**

To create a retouched copy of the picture currently displayed in full-frame playback (170), press **i**, then highlight **Retouch** and press **OK** and select a retouch option (**Image overlay** excluded).

### **Retouching Copies**

Most options can be applied to copies created using other retouch options, although with the exceptions of **Image overlay** and **Edit movie > Choose start/end point**, each option can be applied only once (note that multiple edits may result in loss of detail). Options that can not be applied to the current image are grayed out and unavailable.

### **Image Quality and Size**

Except in the case of copies created with **Trim** and **Resize**, copies created from JPEG images are the same size and quality as the original, while copies created from NEF (RAW) photos are saved as large fine-quality JPEG images.

## D-Lighting

MENU button →  retouch menu

D-Lighting brightens shadows, making it ideal for dark or backlit photographs.

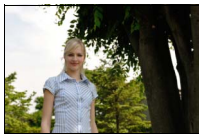

*Before*

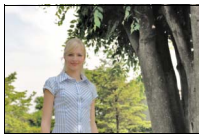

*D-Lighting*



*D-Lighting  
(portrait subject)*

Press ◀ or ▶ to choose the amount of correction performed; the effect can be previewed in the edit display. Press  to copy the photograph.

### **Portrait Subjects**

Select **Portrait subjects** to restrict D-Lighting to portrait subjects.

#### **Portrait Subjects**

The camera automatically selects up to three subjects for portrait D-Lighting (note that portrait D-Lighting can not be applied to photos taken with **Off** selected for **Auto image rotation** in the setup menu;  243). Depending on composition and how the subjects are posed, the desired results may not be achieved; if you are not satisfied, remove the check from **Portrait subjects**.

## Red-Eye Correction

MENU button →  retouch menu







This option is used to correct “red-eye” caused by the flash, and is available only with photographs taken using the flash. The photograph selected for red-eye correction can be previewed in the edit display. Confirm the effects of red-eye correction and press  to create a copy. Note that red-eye correction may not always produce the expected results and may in very rare circumstances be applied to portions of the image that are not affected by red-eye; check the preview thoroughly before proceeding.

## Trim

MENU button →  retouch menu

Create a cropped copy of the selected photograph. The selected photograph is displayed with the selected crop shown in yellow; create a cropped copy as described in the following table.



To	Use	Description
Increase size of crop		Press the  button to increase the size of the crop.
Reduce size of crop		Press the  (?) button to reduce the size of the crop.
Change crop aspect ratio		Rotate the command dial to switch between aspect ratios of 3 : 2, 4 : 3, 5 : 4, 1 : 1, and 16 : 9.
Move crop		Use multi selector to position the crop.
Create copy		Save the current crop as a separate file.

### Image Size

The size of the copy (which varies with crop size and aspect ratio) appears at upper left in the crop display.

### Viewing Cropped Copies

Playback zoom may not be available when cropped copies are displayed.

## Monochrome

MENU button →  retouch menu

Copy photographs in **Black-and-white**, **Sepia**, or **Cyanotype** (blue and white monochrome).

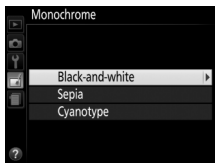

Selecting **Sepia** or **Cyanotype** displays a preview of the selected image; press ▲ to increase color saturation, ▼ to decrease. Press Ⓞ to create a monochrome copy.

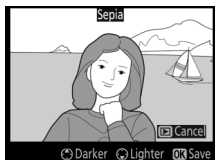

*Increase saturation*



*Decrease saturation*

## Filter Effects

MENU button →  retouch menu

After adjusting filter effects as described below, press **OK** to copy the photograph.

Option	Description
<b>Skylight</b>	Creates the effect of a skylight filter, making the picture less blue.
<b>Warm filter</b>	Creates a copy with warm tone filter effects, giving the copy a “warm” red cast.
<b>Red intensifier</b>	Intensify reds ( <b>Red intensifier</b> ), greens ( <b>Green intensifier</b> ), or blues ( <b>Blue intensifier</b> ). Press <b>▲</b> to increase the effect, <b>▼</b> to decrease.
<b>Green intensifier</b>	
<b>Blue intensifier</b>	
<b>Cross screen</b>	<p>Add starburst effects to light sources.</p> <ul style="list-style-type: none"> <li>• <b>Number of points:</b> Choose from four, six, or eight.</li> <li>• <b>Filter amount:</b> Choose the brightness of the light sources affected.</li> <li>• <b>Filter angle:</b> Choose the angle of the points.</li> <li>• <b>Length of points:</b> Choose the length of points.</li> <li>• <b>Confirm:</b> Preview the effects of the filter. Press <b>OK</b> to preview the copy full frame.</li> <li>• <b>Save:</b> Create a retouched copy.</li> </ul>
<b>Soft</b>	<p>Add a soft filter effect. Press <b>◀</b> or <b>▶</b> to choose the filter strength.</p>

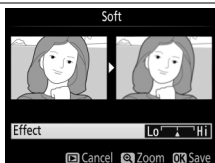
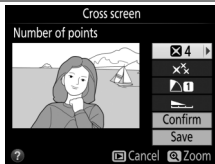
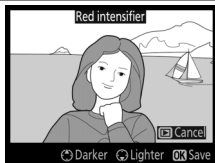



## Color Balance

MENU button →  retouch menu

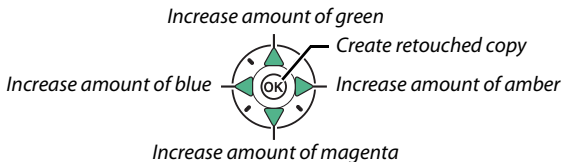

Use the multi selector to create a copy with modified color balance as shown below. Red, green, and blue histograms (📖 174) show the distribution of tones in the copy.



### Zoom

To zoom in on the image displayed in the monitor, press the  button. The histogram will be updated to show data only for the portion of the image displayed in the monitor. While the image is zoomed in, press the  button to toggle back and forth between color balance and zoom.



When zoom is selected, you can zoom in and out with the  and  buttons and scroll the image with the multi selector.

## Image Overlay

MENU button →  retouch menu

Image overlay combines two existing NEF (RAW) photographs to create a single picture that is saved separately from the originals; the results, which make use of RAW data from the camera image sensor, are noticeably better than overlays created in an imaging application. The new picture is saved at current image quality and size settings; before creating an overlay, set image quality and size (☐ 85, 87; all options are available). To create an NEF (RAW) copy, choose an image quality of **NEF (RAW)**.

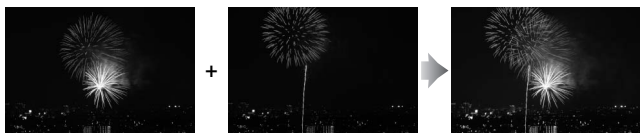

### 1 Select Image overlay.

Highlight **Image overlay** in the retouch menu and press



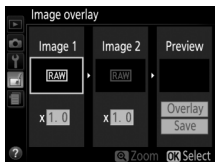
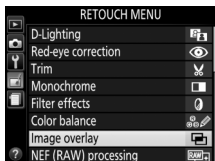

The dialog shown at right will be displayed, with **Image 1** highlighted; press **OK** to display a list of the NEF (RAW) pictures created with this camera.





---

## 2 Select the first image.

Use the multi selector to highlight the first photograph in the overlay. To view the highlighted photograph full frame, press and hold the  button. Press  to select the highlighted photograph and return to the preview display.

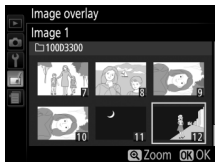



---

## 3 Select the second image.

The selected image will appear as **Image 1**. Highlight **Image 2** and press , then select the second photo as described in Step 2.

---

## 4 Adjust gain.

Highlight **Image 1** or **Image 2** and optimize exposure for the overlay by pressing  or  to select gain from values between 0.1 and 2.0.

Repeat for the second image. The default value is 1.0; select 0.5 to halve gain or 2.0 to double it. The effects of gain are visible in the **Preview** column.

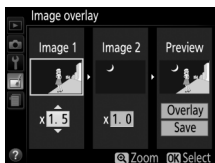

## 5 Preview the overlay.

Press ◀ or ▶ to place the cursor in the **Preview** column and press ▲ or ▼ to highlight **Overlay**. Press **OK** to preview the overlay as shown at right (to save the overlay without displaying a preview, select **Save**). To return to Step 4 and select new photos or adjust gain, press **Q** (?).



## 6 Save the overlay.

Press **OK** while the preview is displayed to save the overlay. After an overlay is created, the resulting image will be displayed full-frame in the monitor.



### Image Overlay

The overlay has the same photo info as the photograph selected for **Image 1**.

Create JPEG copies of NEF (RAW) photographs.

### 1 Select NEF (RAW)

**processing.**

Highlight **NEF (RAW)**

**processing** in the retouch

menu and press  to

display a picture selection

dialog listing only NEF

(RAW) images created with this camera.

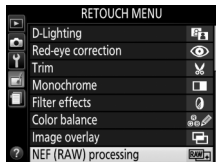

### 2 Select a photograph.

Use the multi selector to

highlight a photograph (to

view the highlighted

photograph full frame,

press and hold the  button).

Press  to select

the highlighted photograph and proceed to the next step.

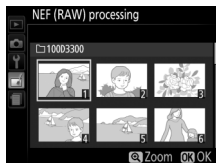

### 3 Adjust NEF (RAW) processing settings.

Adjust the settings listed below. Note that white balance is not available with pictures created with image overlay, and that the effects of exposure compensation may differ from those that might have been expected when the photograph was taken.

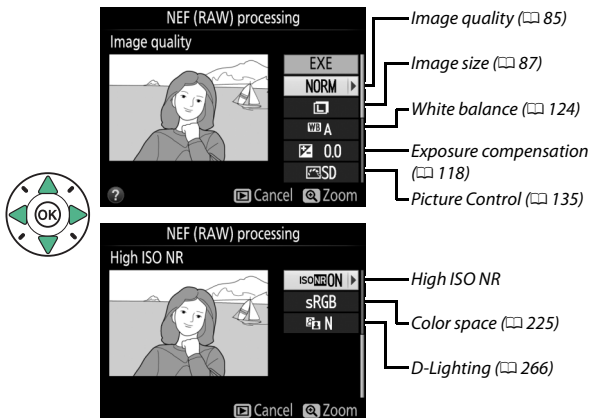

### 4 Copy the photograph.

Highlight **EXE** and press **OK** to create a JPEG copy of the selected photograph. To exit without copying the photograph, press the MENU button.



## Resize

MENU button →  retouch menu

Create small copies of one or more selected photographs.

### 1 Select **Resize**.

Highlight **Resize** in the retouch menu and press .



### 2 Choose a size.

Highlight **Choose size** and press .



Highlight an option and press .



### 3 Choose pictures.

Highlight **Select image** and press **▶**.



Highlight pictures using the multi selector and press the **Q (?)** button to select or deselect (to view the highlighted picture full screen, press and hold the **Q** button).

Selected pictures are marked by a  icon. Press **OK** when the selection is complete.

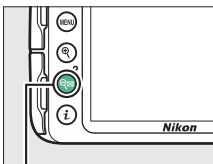
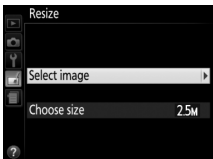

**Q (?)** button



### 4 Save the resized copies.

A confirmation dialog will be displayed. Highlight **Yes** and press **OK** to save the resized copies.

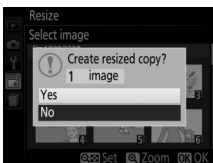

#### Viewing Resized Copies

Playback zoom may not be available when resized copies are displayed.

## Quick Retouch

MENU button →  retouch menu

Create copies with enhanced saturation and contrast. D-Lighting is applied as required to brighten dark or backlit subjects.

Press ◀ or ▶ to choose the amount of enhancement. Press Ⓞ to copy the photograph.

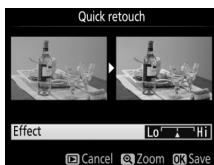

## Straighten

MENU button →  retouch menu

Create a straightened copy of the selected image. Press ▶ to rotate the image clockwise by up to five degrees in increments of approximately 0.25 degrees, ◀ to rotate it counterclockwise (note that edges of the image will be trimmed to create a rectangular copy). Press Ⓞ to save the retouched copy.

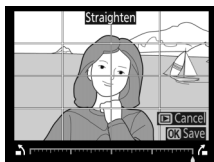

## Distortion Control

MENU button →  retouch menu

Create copies with reduced peripheral distortion. Select **Auto** to let the camera correct distortion automatically and then make fine adjustments using the multi-selector, or select **Manual** to reduce distortion manually (note that **Auto** is not available with photos taken using auto distortion control; see page 225).

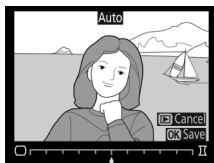

Press ► to reduce barrel distortion, ◀ to reduce pin-cushion distortion (note that greater amounts of distortion control result in more of the edges being cropped out). Press Ⓞ to save the retouched copy.

### Auto

**Auto** is for use only with pictures taken with type G, E, and D lenses (PC, fisheye, and certain other lenses excluded); results are not guaranteed with other lenses.

## Fisheye

MENU button →  retouch menu

Create copies that appear to have been taken with a fisheye lens. Press ► to increase the effect (this also increases the amount that will be cropped out at the edges of the image), ◀ to reduce it. Press Ⓞ to save the retouched copy.





## Color Outline

MENU button →  retouch menu

Create an outline copy of a photograph to use as a base for painting. Press **OK** to save the retouched copy.

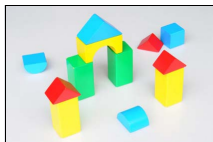

Before

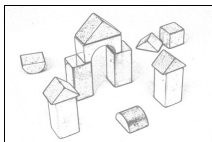

After

## Photo Illustration

MENU button →  retouch menu

Sharpen outlines and simplify coloring for a poster effect. Press **▶** or **◀** to make outlines thicker or thinner. Press **OK** to save the retouched copy.

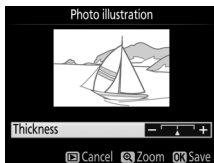

Before



After

## Color Sketch

MENU button →  retouch menu

Create a copy of a photograph that resembles a sketch made with colored pencils. Press ▲ or ▼ to highlight **Vividness** or **Outlines** and press ◀ or ▶ to change. Vividness can be increased to make colors more saturated, or decreased for a washed-out, monochromatic effect, while outlines can be made thicker or thinner. Thicker outlines make colors more saturated. Press ⊙ to save the retouched copy.



## Perspective Control

MENU button →  retouch menu

Create copies that reduce the effects of perspective taken from the base of a tall object. Use the multi selector to adjust perspective (note that greater amounts of perspective control result in more of the edges being cropped out). Press ⊙ to save the retouched copy.

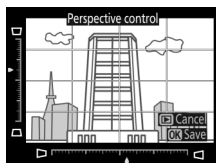

*Before*









*After*

## Miniature Effect

MENU button →  retouch menu

Create a copy that appears to be a photo of a diorama. Works best with photos taken from a high vantage point. The area that will be in focus in the copy is indicated by a yellow frame.

To	Press	Description
Choose orientation	 (?)	Press  (?) to choose orientation of area that is in focus.
Choose area in focus		If area of effect is in wide orientation, press ▲ or ▼ to position frame showing area of copy that will be in focus.
		If area of effect is in tall orientation, press ◀ or ▶ to position frame showing area of copy that will be in focus.
Choose size		If area of effect is in wide orientation, press ◀ or ▶ to choose height.
		If area of effect is in tall orientation, press ▲ or ▼ to choose width.
Create copy		Create copy.

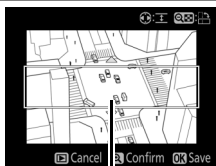

*Area in focus*





## Selective Color

MENU button →  retouch menu



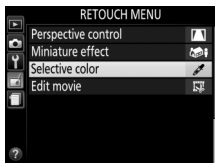

Create a copy in which only selected hues appear in color.

- 1 Select Selective color.**  
Highlight **Selective color** in the retouch menu and press .





- 2 Select a photograph.**  
Highlight a photograph and press  (to view the highlighted photograph full frame, press and hold the  button).

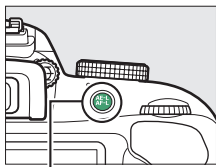

- 3 Select a color.**  
Use the multi selector to position the cursor over an object and press  () to select the color of the object as one that will remain in the final copy (the camera may have difficulty detecting unsaturated colors; choose a saturated color). To zoom in on the picture for precise color selection, press . Press  (?) to zoom out.



 () button

Selected color



#### 4 Highlight the color range.

Rotate the command dial to highlight the color range for the selected color.



Color range





#### 5 Choose the color range.

Press ▲ or ▼ to increase or decrease the range of similar hues that will be included in the final photograph. Choose from values between 1 and 7; note that higher values may include hues from other colors.



#### 6 Select additional colors.

To select additional colors, rotate the command dial to highlight another of the three color boxes at the top of the display and repeat Steps 3–5 to select another color. Repeat for a third color if desired. To deselect the highlighted color, press  (To remove all colors, press and hold . A confirmation dialog will be displayed; select **Yes**).



- 7 Save the edited copy.**  
Press **OK** to copy the photograph.



## Side-by-side Comparison

**MENU** button → **i** retouch menu

Compare retouched copies to the original photographs. This option is only available if the retouch menu is displayed by pressing the **i** button and selecting **Retouch** when a copy or original is played back full frame.

- 1 Select a picture.**

Select a retouched copy (shown by a **i** icon) or a photograph that has been retouched in full-frame playback. Press **i**, then highlight **Retouch** and press **OK**.

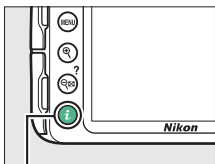

**i** button



## 2 Select Side-by-side comparison.

Highlight **Side-by-side comparison** in the retouch menu and press **OK**.

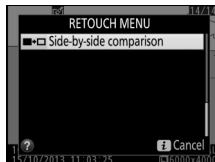

## 3 Compare the copy with the original.

The source image is displayed on the left, the retouched copy on the right, with the options used to create the copy listed at the top of the display. Press **◀** or **▶** to switch between the source image and the retouched copy. To view the highlighted picture full frame, press and hold the **Ⓚ** button. If the copy was created from two images using **Image overlay**, press **▲** or **▼** to view the other source image. If multiple copies exist for the current source image, press **▲** or **▼** to view the other copies. Press **OK** to return to playback with the highlighted image displayed.

*Options used to create copy*

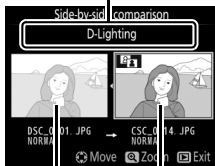

*Source image*

*Retouched copy*

### **✔ Side-by-side comparison**

The source image will not be displayed if the copy was created from a photograph that has since been deleted or that was protected when the copy was made (☐ 184).

## Recent Settings



To display the recent settings menu, press **MENU** and select the  (recent settings) tab.

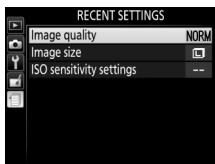

The recent settings menu lists the 20 most recently used settings. Press **▲** or **▼** to highlight an option and press **▶** to select.



### Removing Items from the Recent Settings Menu

To remove an item from the recent settings menu, highlight it and press the  button. A confirmation dialog will be displayed; press  again to delete the selected item.





# Technical Notes

Read this chapter for information on compatible accessories, cleaning and storing the camera, and what to do if an error message is displayed or you encounter problems using the camera.

## Compatible Lenses

### Compatible CPU Lenses

This camera supports autofocus with AF-S, AF-P, and AF-I CPU lenses only. AF-S lenses have names beginning with **AF-S**, AF-P lenses with **AF-P**, and AF-I lenses with **AF-I**. Autofocus is not supported with other autofocus (AF) lenses. The following table lists the features available with compatible lenses in viewfinder photography:

Camera setting  Lens/accessory	Focus			Mode		Metering		
	AF	MF (with electronic rangefinder)	MF	M	Other modes			
						3D	Color	
AF-S, AF-P, AF-I NIKKOR	✓	✓	✓	✓	✓	✓	—	✓ <sup>1</sup>
Other type G or D AF NIKKOR	—	✓	✓	✓	✓	✓	—	✓ <sup>1</sup>
PC-E NIKKOR series <sup>2,3</sup>	—	✓ <sup>4</sup>	✓	✓	✓	✓	—	✓ <sup>1</sup>
PC Micro 85mm f/2.8D <sup>5</sup>	—	✓ <sup>4</sup>	✓	✓	—	✓	—	✓ <sup>1</sup>
AF-S/AF-I teleconverter	✓ <sup>6</sup>	✓ <sup>6</sup>	✓	✓	✓	✓	—	✓ <sup>1</sup>
Other AF NIKKOR (except lenses for F3AF)	—	✓ <sup>7</sup>	✓	✓	✓	—	✓	✓ <sup>1</sup>
AI-P NIKKOR	—	✓ <sup>8</sup>	✓	✓	✓	—	✓	✓ <sup>1</sup>

1 Spot metering meters selected focus point ( 114).

2 Observe due caution when tilting or shifting PC-E NIKKOR 24mm f/3.5D ED lenses, as they may contact the camera body and cause damage or injury.

3 Shifting and/or tilting the lens interferes with exposure.

- 4 Can not be used with shifting or tilting.
  - 5 Optimal exposure will only be achieved if the lens is at maximum aperture and the lens is not shifted or tilted.
  - 6 With maximum effective aperture of  $f/5.6$  or faster.
  - 7 When AF 80–200mm  $f/2.8$ , AF 35–70mm  $f/2.8$ , AF 28–85mm  $f/3.5-4.5$  (New), or AF 28–85mm  $f/3.5-4.5$  lenses are zoomed all the way in at the minimum focus distance, the in-focus indicator (●) may be displayed when the image on the matte screen in the viewfinder is not in focus. Before shooting, confirm that the image in the viewfinder screen is in focus.
  - 8 With maximum aperture of  $f/5.6$  or faster.
- Noise in the form of lines may appear during autofocus when movies are recorded at high ISO sensitivities. Use manual focus or focus lock.

**IX NIKKOR Lenses**

IX NIKKOR lenses can not be used.

### Identifying CPU and Type G, E, and D Lenses

CPU lenses can be identified by the presence of CPU contacts, type G, E, and D lenses by a letter on the lens barrel. Type G and E lenses are not equipped with a lens aperture ring.

*CPU contacts*

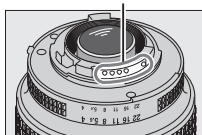

*CPU lens*

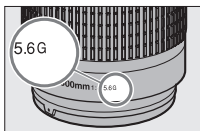

*Type G or E lens*

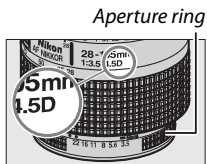

*Type D lens*

When using a CPU lens equipped with an aperture ring, lock the aperture ring at the minimum aperture (highest f-number).

### Matrix Metering

For matrix metering, the camera uses a 420-pixel RGB sensor to set exposure according to tone distribution, color, composition, and, with type G, E, or D lenses, distance information (3D color matrix metering II; with other CPU lenses, the camera uses color matrix metering II; which does not include 3D distance information).

## Compatible Non-CPU Lenses

Non-CPU lenses may only be used when the camera is in mode **M**. Selecting another mode disables the shutter release.

Aperture must be adjusted manually via the lens aperture ring and the camera metering system, i-TTL flash control, and other features requiring a CPU lens can not be used. Some non-CPU lenses can not be used; see “Incompatible Accessories and Non-CPU Lenses,” below.

Camera setting Lens/accessory	Focus			Mode	
	AF	MF (with electronic rangefinder)	MF	M	Other modes
AI-, AI-modified NIKKOR or Nikon Series E lenses	—	✓ <sup>1</sup>	✓	✓ <sup>2</sup>	—
Medical NIKKOR 120mm f/4	—	✓	✓	✓ <sup>2,3</sup>	—
Reflex NIKKOR	—	—	✓	✓ <sup>2</sup>	—
PC NIKKOR	—	✓ <sup>4</sup>	✓	✓ <sup>2</sup>	—
AI-type Teleconverter	—	✓ <sup>5</sup>	✓	✓ <sup>2</sup>	—
PB-6 Bellows Focusing Attachment <sup>6</sup>	—	✓ <sup>1</sup>	✓	✓ <sup>2</sup>	—
Auto extension rings (PK-series 11A, 12, or 13; PN-11)	—	✓ <sup>1</sup>	✓	✓ <sup>2</sup>	—

1 With maximum aperture of f/5.6 or faster.

2 Exposure indicator can not be used.

3 Can be used at shutter speeds slower than flash sync speed by one step or more.

4 Can not be used with shifting or tilting.

5 With maximum effective aperture of f/5.6 or faster.

6 Attach in vertical orientation (can be used in horizontal orientation once attached).

### **Incompatible Accessories and Non-CPU Lenses**

The following accessories and non-CPU lenses can NOT be used with the D3300:

- TC-16A AF teleconverter
- Non-AI lenses
- Lenses that require the AU-1 focusing unit (400mm f/4.5, 600mm f/5.6, 800mm f/8, 1200mm f/11)
- Fisheye (6mm f/5.6, 7.5mm f/5.6, 8mm f/8, OP 10mm f/5.6)
- 2.1cm f/4
- Extension Ring K2
- 180–600mm f/8 ED (serial numbers 174041–174180)
- 360–1200mm f/11 ED (serial numbers 174031–174127)
- 200–600mm f/9.5 (serial numbers 280001–300490)
- AF lenses for the F3AF (AF 80mm f/2.8, AF 200mm f/3.5 ED, AF Teleconverter TC-16)
- PC 28mm f/4 (serial number 180900 or earlier)
- PC 35mm f/2.8 (serial numbers 851001–906200)
- PC 35mm f/3.5 (old type)
- Reflex 1000mm f/6.3 (old type)
- Reflex 1000mm f/11 (serial numbers 142361–143000)
- Reflex 2000mm f/11 (serial numbers 200111–200310)

### **AF-Assist Illumination**

The AF-assist illuminator has a range of about 0.5–3.0 m (1 ft 8 in.–9 ft 10 in.); when using the illuminator, use a lens with a focal length of 18–200 mm and remove the lens hood. AF-assist illumination is not available with the following lenses:

- AF-S NIKKOR 14–24mm f/2.8G ED
- AF-S NIKKOR 28–300mm f/3.5–5.6G ED VR
- AF-S DX NIKKOR 55–300mm f/4.5–5.6G ED VR
- AF-S VR Zoom-Nikkor 70–200mm f/2.8G IF-ED
- AF-S NIKKOR 70–200mm f/2.8G ED VR II
- AF-S Zoom-Nikkor 80–200mm f/2.8D IF-ED
- AF-S NIKKOR 80–400mm f/4.5–5.6G ED VR
- AF-S VR Nikkor 200mm f/2G IF-ED
- AF-S NIKKOR 200mm f/2G ED VR II
- AF-S VR Zoom-Nikkor 200–400mm f/4G IF-ED
- AF-S NIKKOR 200–400mm f/4G ED VR II

At ranges under 1 m (3 ft 3 in.), the following lenses may block the AF-assist illuminator and interfere with autofocus when lighting is poor:

- AF-S DX NIKKOR 10–24mm f/3.5–4.5G ED
- AF-S NIKKOR 16–35mm f/4G ED VR
- AF-S Zoom-Nikkor 17–35mm f/2.8D IF-ED
- AF-S DX Zoom-Nikkor 17–55mm f/2.8G IF-ED
- AF-S NIKKOR 18–35mm f/3.5–4.5G ED
- AF-S DX NIKKOR 18–105mm f/3.5–5.6G ED VR
- AF-S DX VR Zoom-Nikkor 18–200mm f/3.5–5.6G IF-ED
- AF-S DX NIKKOR 18–200mm f/3.5–5.6G ED VR II
- AF-S DX NIKKOR 18–300mm f/3.5–5.6G ED VR
- AF-S NIKKOR 24–70mm f/2.8G ED
- AF-S VR Zoom-Nikkor 24–120mm f/3.5–5.6G IF-ED
- AF-S NIKKOR 24–120mm f/4G ED VR
- AF-S NIKKOR 28mm f/1.8G
- AF-S Zoom-Nikkor 28–70mm f/2.8D IF-ED
- AF-S NIKKOR 35mm f/1.4G
- AF-S NIKKOR 70–200mm f/4G ED
- AF-S NIKKOR 70–200mm f/4G ED VR
- AF-S NIKKOR 85mm f/1.4G
- AF-S NIKKOR 85mm f/1.8G
- AF-S VR Micro-Nikkor 105mm f/2.8G IF-ED

### ✓ The Built-in Flash

The built-in flash can be used with lens focal lengths of 18–300 mm, although in some cases the flash may be unable to entirely light the subject at some ranges or focal lengths due to shadows cast by the lens (see the illustration below), while lenses that block the subject's view of the red-eye reduction lamp may interfere with red-eye reduction. Remove lens hoods to prevent shadows.

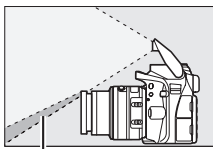

*Shadow*

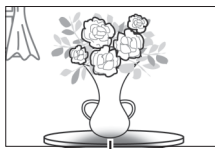

*Vignetting*

The flash has a minimum range of 0.6 m and can not be used in the macro range of macro zoom lenses. The flash may be unable to light the entire subject with the following lenses at ranges less than those given below:

<b>Lens</b>	<b>Zoom position</b>	<b>Minimum distance without vignetting</b>
AF-S DX NIKKOR 10–24mm f/3.5–4.5G ED	24 mm	1.5 m / 4 ft 11 in.
AF-S DX Zoom-Nikkor 12–24mm f/4G IF-ED	24 mm	1.0 m / 3 ft 3 in.
AF-S NIKKOR 16–35mm f/4G ED VR	35 mm	1.0 m / 3 ft 3 in.
AF-S DX NIKKOR 16–85mm f/3.5–5.6G ED VR	24–85 mm	No vignetting
AF-S Zoom-Nikkor 17–35mm f/2.8D IF-ED	28 mm	1.0 m / 3 ft 3 in.
	35 mm	No vignetting

<b>Lens</b>	<b>Zoom position</b>	<b>Minimum distance without vignetting</b>
AF-S DX Zoom-Nikkor 17–55mm f/2.8G IF-ED	28 mm	1.5 m / 4 ft 11 in.
	35 mm	1.0 m / 3 ft 3 in.
	45–55 mm	No vignetting
AF-S NIKKOR 18–35mm f/3.5–4.5G ED	24 mm	1.5 m / 4 ft 11 in.
	28 mm	1.0 m / 3 ft 3 in.
	35 mm	No vignetting
AF Zoom-Nikkor 18–35mm f/3.5–4.5D IF-ED	24 mm	1.0 m / 3 ft 3 in.
	28–35 mm	No vignetting
AF-P DX NIKKOR 18–55mm f/3.5–5.6G VR, AF-P DX NIKKOR 18–55mm f/3.5–5.6G	18 mm	1.0 m / 3 ft 4 in.
	24–55 mm	No vignetting
AF-S DX Zoom-Nikkor 18–70mm f/3.5–4.5G IF-ED	18 mm	1.0 m / 3 ft 3 in.
	24–70 mm	No vignetting
AF-S DX NIKKOR 18–105mm f/3.5–5.6G ED VR	18 mm	2.5 m / 8 ft 2 in.
	24 mm	1.0 m / 3 ft 3 in.
	35–105 mm	No vignetting
AF-S DX Zoom-Nikkor 18–135mm f/3.5–5.6G IF-ED	18 mm	2.0 m / 6 ft 7 in.
	24–135 mm	No vignetting
AF-S DX NIKKOR 18–140mm f/3.5–5.6G ED VR	24 mm	1.0 m / 3 ft 3 in.
	35–140 mm	No vignetting
AF-S DX VR Zoom-Nikkor 18–200mm f/3.5–5.6G IF-ED, AF-S DX NIKKOR 18–200mm f/3.5–5.6G ED VR II	24 mm	1.0 m / 3 ft 3 in.
	35–200 mm	No vignetting
AF-S DX NIKKOR 18–300mm f/3.5–5.6G ED VR	35–300 mm	1.0 m / 3 ft 3 in.
AF Zoom-Nikkor 20–35mm f/2.8D IF	24 mm	2.5 m / 8 ft 2 in.
	28 mm	1.0 m / 3 ft 3 in.
	35 mm	No vignetting
AF-S NIKKOR 24mm f/1.4G ED	24 mm	1.0 m / 3 ft 3 in.
AF-S NIKKOR 24–70mm f/2.8G ED	35 mm	1.5 m / 4 ft 11 in.
	50–70 mm	No vignetting



<b>Lens</b>	<b>Zoom position</b>	<b>Minimum distance without vignetting</b>
AF-S VR Zoom-Nikkor 24–120mm f/3.5–5.6G IF-ED	24 mm	1.0 m / 3 ft 3 in.
	28–120 mm	No vignetting
AF-S NIKKOR 24–120mm f/4G ED VR	24 mm	1.5 m / 4 ft 11 in.
	28–120 mm	No vignetting
AF-S Zoom-Nikkor 28–70mm f/2.8D IF-ED	35 mm	1.5 m / 4 ft 11 in.
	50–70 mm	No vignetting
AF-S NIKKOR 28–300mm f/3.5–5.6G ED VR	28 mm	1.5 m / 4 ft 11 in.
	35 mm	1.0 m / 3 ft 3 in.
	50–300 mm	No vignetting
AF-S VR Zoom-Nikkor 200–400mm f/4G IF-ED, AF-S NIKKOR 200–400mm f/4G ED VR II	200 mm	4.0 m / 13 ft 2 in.
	250 mm	3.0 m / 9 ft 10 in.
	300 mm	2.5 m / 8 ft 2 in.
PC-E NIKKOR 24mm f/3.5D ED *	24 mm	3.0 m / 9 ft 10 in.

\* When not shifted or tilted.

When used with the AF-S NIKKOR 14–24mm f/2.8G ED, the flash will be unable to light the entire subject at all ranges.

### Calculating Angle of View

The size of the area exposed by a 35 mm camera is  $36 \times 24$  mm. The size of the area exposed by the D3300, in contrast, is  $23.5 \times 15.6$  mm, meaning that the angle of view of a 35 mm camera is approximately 1.5 times that of the D3300. The approximate focal length of lenses for the D3300 in 35 mm format can be calculated by multiplying the focal length of the lens by about 1.5.

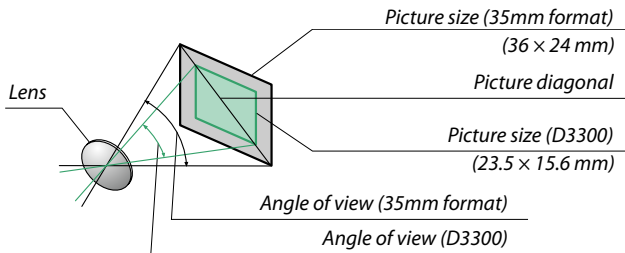

## Optional Flash Units (Speedlights)

The camera supports the Nikon Creative Lighting System (CLS) and can be used with CLS-compatible flash units. The built-in flash will not fire when an optional flash unit is attached.

### Flash Units Compatible with the Creative Lighting System (CLS)

The camera can be used with the following CLS-compatible flash units:

Flash unit		SB-910 <sup>1</sup>	SB-900 <sup>1</sup>	SB-800	SB-700 <sup>1</sup>	SB-600	SB-400 <sup>2</sup>	SB-300 <sup>2</sup>	SB-R200 <sup>3</sup>
Feature									
Guide No. <sup>4</sup>	ISO 100	34/111	34/111	38/125	28/92	30/98	21/69	18/59	10/33
	ISO 200	48/157	48/157	53/174	39/128	42/138	30/98	25/82	14/46

1 If a color filter is attached to the SB-910, SB-900, or SB-700 when **AUTO** or  (flash) is selected for white balance, the camera will automatically detect the filter and adjust white balance appropriately.

2 Wireless flash control is not available.

3 Controlled remotely using optional SB-910, SB-900, SB-800, or SB-700 flash unit or SU-800 wireless Speedlight commander.

4 m/ft, 20 °C (68 °F), SB-910, SB-900, SB-800, SB-700, and SB-600 at 35 mm zoom head position; SB-910, SB-900, and SB-700 with standard illumination.

- **The SU-800 wireless speedlight commander:** When mounted on a CLS-compatible camera, the SU-800 can be used as a commander for remote SB-910, SB-900, SB-800, SB-700, SB-600, or SB-R200 flash units in up to three groups. The SU-800 itself is not equipped with a flash.

### **The Nikon Creative Lighting System (CLS)**

Nikon's advanced Creative Lighting System (CLS) offers improved communication between the camera and compatible flash units for improved flash photography. Refer to the documentation provided with the flash unit for details.

### **Guide Number**

To calculate the range of the flash at full power, divide the Guide Number by the aperture. If, for example, the flash unit has a Guide Number of 34 m or 111 ft (ISO 100, 20 °C/68 °F); its range at an aperture of f/5.6 is  $34 \div 5.6$  or about 6.1 meters (or in feet,  $111 \div 5.6 =$  approximately 19 ft 10 in.). For each twofold increase in ISO sensitivity, multiply the Guide Number by the square root of two (approximately 1.4).

The following features are available with CLS-compatible flash units:

		CLS-compatible flash units										
		SB-900	SB-910	SB-800	SB-700	SB-600	SU-800		SB-R200	SB-400	SB-300	
							Commander	Close-up photography				
Single flash	i-TTL	i-TTL balanced fill-flash for digital SLR <sup>1</sup>	✓	✓	✓	✓	—	—	—	✓	✓	
		Standard i-TTL flash for digital SLR	✓ <sup>2</sup>	✓ <sup>2</sup>	✓	✓ <sup>2</sup>	—	—	—	✓	✓	
	AA	Auto aperture	✓ <sup>3</sup>	✓ <sup>3</sup>	—	—	—	—	—	—	—	
	A	Non-TTL auto	✓ <sup>3</sup>	✓ <sup>3</sup>	—	—	—	—	—	—	—	
	GN	Distance-priority manual	✓	✓	✓	—	—	—	—	—	—	
	M	Manual	✓	✓	✓	✓	—	—	—	✓ <sup>4</sup>	✓ <sup>4</sup>	
	RPT	Repeating flash	✓	✓	—	—	—	—	—	—	—	
Advanced Wireless Lighting	Master	Remote flash control	✓	✓	✓	—	✓	✓	—	—	—	
		i-TTL i-TTL	✓	✓	✓	—	—	—	—	—	—	
		[A:B]	Quick wireless flash control	—	—	✓	—	—	✓	—	—	—
		AA	Auto aperture	✓ <sup>5</sup>	✓ <sup>5</sup>	—	—	—	—	—	—	—
		A	Non-TTL auto	✓	✓	—	—	—	—	—	—	—
		M	Manual	✓	✓	✓	—	—	—	—	—	—
		RPT	Repeating flash	✓	✓	—	—	—	—	—	—	—

			CLS-compatible flash units									
			SB-900	SB-910	SB-800	SB-700	SB-600	SU-800		SB-R200	SB-400	SB-300
								Commander	Close-up photography			
Advanced Wireless Lighting	Remote	i-TTL	✓	✓	✓	✓	—	—	✓	—	—	
		[A:B] Quickwireless flash control	✓	✓	✓	✓	—	—	✓	—	—	
		AA Auto aperture	✓ <sup>5</sup>	✓ <sup>5</sup>	—	—	—	—	—	—	—	
		A Non-TTL auto	✓	✓	—	—	—	—	—	—	—	
		M Manual	✓	✓	✓	✓	—	—	✓	—	—	
		RPT Repeating flash	✓	✓	✓	✓	—	—	—	—	—	
Flash Color Information Communication			✓	✓	✓	✓	—	—	—	✓	✓	
AF-assist for multi-area AF			✓	✓	✓	✓	✓	—	—	—	—	
Red-eye reduction			✓	✓	✓	✓	—	—	—	✓	—	
Camera flash mode selection			—	—	—	—	—	—	—	✓	✓	
Camera flash unit firmware update			✓	—	✓	—	—	—	—	—	✓	

- 1 Not available with spot metering.
- 2 Can also be selected with flash unit.
- 3 **AA/A** mode selection performed on flash unit using custom settings. **A** is selected when a non-CPU lens is used.
- 4 Can only be selected with camera (□ 229).
- 5 When a non-CPU lens is used, non-TTL auto (**A**) is used regardless of mode selected with flash unit.

## Other Flash Units

The following flash units can be used in non-TTL auto and manual modes. Use with the camera in exposure mode **S** or **M** and a shutter speed of  $1/200$  s or slower selected.

Flash unit	SB-80DX, SB-28DX, SB-28, SB-26, SB-25, SB-24	SB-50DX <sup>1</sup>	SB-30, SB-27 <sup>2</sup> , SB-22S, SB-22, SB-20, SB-16B, SB-15	SB-23, SB-29 <sup>3</sup> , SB-21B <sup>3</sup> , SB-29S <sup>3</sup>
<b>A</b> Non-TTL auto	✓	—	✓	—
<b>M</b> Manual	✓	✓	✓	✓
 Repeating flash	✓	—	—	—
<b>REAR</b> Rear-curtain sync <sup>4</sup>	✓	✓	✓	✓

- 1 Select mode **P**, **S**, **A**, or **M**, lower built-in flash, and use optional flash unit only.
- 2 Flash mode is automatically set to TTL and shutter-release is disabled. Set flash unit to **A** (non-TTL auto flash).
- 3 Autofocus is available with AF-S VR Micro-Nikkor 105mm f/2.8G IF-ED and AF-S Micro NIKKOR 60mm f/2.8G ED lenses only.
- 4 Available when camera is used to select flash mode.

### The AS-15 Sync Terminal Adapter





When the AS-15 sync terminal adapter (available separately) is mounted on the camera accessory shoe, flash accessories can be connected via a sync cable.

### Use Only Nikon Flash Accessories

Use only Nikon flash units. Negative voltages or voltages over 250 V applied to the accessory shoe could not only prevent normal operation, but damage the sync circuitry of the camera or flash. Before using a Nikon flash unit not listed in this section, contact a Nikon-authorized service representative for more information.

### ✔ Notes on Optional Flash Units

Refer to the Speedlight manual for detailed instructions. If the flash unit supports CLS, refer to the section on CLS-compatible digital SLR cameras. The D3300 is not included in the “digital SLR” category in the SB-80DX, SB-28DX, and SB-50DX manuals.

If an optional flash unit is attached in shooting modes other than , , , , and , the flash will fire with every shot, even in modes in which the built-in flash can not be used.

i-TTL flash control can be used at ISO sensitivities between 100 and 12800. At high ISO sensitivities, noise (lines) may appear in photos taken with some optional flash units; if this occurs, choose a lower value. At values over 12800, the desired results may not be achieved at some ranges or aperture settings. If the flash-ready indicator flashes for about three seconds after a photograph is taken, the flash has fired at full power and the photograph may be underexposed (CLS-compatible flash units only; for information on the exposure and flash charge indicators on other units, see the manual provided with the flash).

When an SC-series 17, 28, or 29 sync cable is used for off-camera flash photography, correct exposure may not be achieved in i-TTL mode. We recommend that you choose spot metering to select standard i-TTL flash control. Take a test shot and view the results in the monitor.

In i-TTL, use the flash panel or bounce adapter provided with the flash unit. Do not use other panels such as diffusion panels, as this may produce incorrect exposure.

If the controls on the optional SB-910, SB-900, SB-800, SB-700 or SB-600 flash unit or SU-800 wireless Speedlight commander are used to set flash compensation,  will appear in the information display.



The SB-910, SB-900, SB-800, SB-700, SB-600, and SB-400 provide red-eye reduction, while the SB-910, SB-900, SB-800, SB-700, SB-600, and SU-800 provide AF-assist illumination with the following restrictions:

- **SB-910 and SB-900:** AF-assist illumination is available with 17–135 mm AF lenses, however, autofocus is available only with the focus points shown at right.

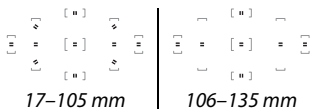

- **SB-800, SB-600, and SU-800:** AF-assist illumination is available with 24–105 mm AF lenses, however, autofocus is available only with the focus points shown at right.

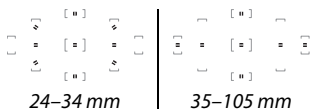

- **SB-700:** AF-assist illumination is available with 24–135 mm AF lenses, however, autofocus is available only with the focus points shown at right.

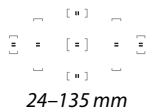

## Other Accessories

At the time of writing, the following accessories were available for the D3300.

<b>Power sources</b>	<ul style="list-style-type: none"><li>• <b>Rechargeable Li-ion Battery EN-EL14a</b> (☐ 14): Additional EN-EL14a batteries are available from local retailers and Nikon-authorized service representatives. EN-EL14 batteries can also be used.</li><li>• <b>Battery Charger MH-24</b> (☐ 14): Recharge EN-EL14a and EN-EL14 batteries.</li><li>• <b>Power Connector EP-5A, AC Adapter EH-5b</b>: These accessories can be used to power the camera for extended periods (EH-5a and EH-5 AC adapters can also be used). A power connector EP-5A is required to connect the camera to the EH-5b, EH-5a, or EH-5; see page 311 for details.</li></ul>
<b>Filters</b>	<ul style="list-style-type: none"><li>• Filters intended for special-effects photography may interfere with autofocus or the electronic rangefinder.</li><li>• The D3300 can not be used with linear polarizing filters. Use C-PL or C-PL II circular polarizing filters instead.</li><li>• NC filters are recommended for protecting the lens.</li><li>• To prevent ghosting, use of a filter is not recommended when the subject is framed against a bright light, or when a bright light source is in the frame.</li><li>• Center-weighted metering is recommended with filters with exposure factors (filter factors) over 1 × (Y44, Y48, Y52, O56, R60, X0, X1, C-PL, ND2S, ND4, ND4S, ND8, ND8S, ND400, A2, A12, B2, B8, B12). See the filter manual for details.</li></ul>

<b>Viewfinder eyepiece accessories</b>	<ul style="list-style-type: none"> <li>• <b>DK-5 Eyepiece Cap</b> (□ 73): Prevents light entering via the viewfinder from appearing in the photograph or interfering with exposure.</li> <li>• <b>DK-20C Eyepiece Correction Lenses:</b> Lenses are available with diopters of <math>-5</math>, <math>-4</math>, <math>-3</math>, <math>-2</math>, <math>0</math>, <math>+0.5</math>, <math>+1</math>, <math>+2</math>, and <math>+3 \text{ m}^{-1}</math> when the camera diopter adjustment control is in the neutral position (<math>-1 \text{ m}^{-1}</math>). Use eyepiece correction lenses only if the desired focus can not be achieved with the built in diopter adjustment control (<math>-1.7</math> to <math>+0.5 \text{ m}^{-1}</math>). Test eyepiece correction lenses before purchase to ensure that the desired focus can be achieved. The rubber eyecup can not be used with eyepiece correction lenses.</li> <li>• <b>Magnifier DG-2:</b> The DG-2 magnifies the scene displayed in the center of the viewfinder for greater precision during focusing. Eyepiece adapter required (available separately).</li> <li>• <b>Eyepiece Adapter DK-22:</b> The DK-22 is used when attaching the DG-2 magnifier.</li> <li>• <b>Right-Angle Viewing Attachment DR-6:</b> The DR-6 attaches at a right angle to the viewfinder eyepiece, allowing the image in the viewfinder to be viewed at right angles to the lens (for example, from directly above when the camera is horizontal).</li> </ul>
<b>Software</b>	<ul style="list-style-type: none"> <li>• <b>Capture NX 2:</b> A complete photo editing package offering such features as white balance adjustment and color control points.</li> </ul> <p><b>Note:</b> Use the latest versions of Nikon software. Most Nikon software offers an auto update feature (Nikon Message Center 2) when the computer is connected to the Internet. See the websites listed on page xviii for the latest information on supported operating systems.</p>

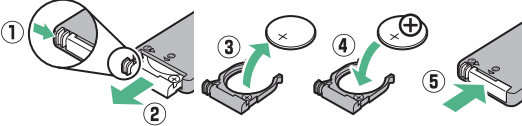
<b>Body cap</b>	<b>Body Cap BF-1B/Body Cap BF-1A:</b> The body cap keeps the mirror, viewfinder screen, and image sensor free of dust when a lens is not in place.
<b>Accessory shoe covers</b>	<b>Accessory Shoe Cover BS-1:</b> A cover protecting the accessory shoe. The accessory shoe is used for optional flash units.
<b>Remote controls/ wireless remote controller</b>	<ul style="list-style-type: none"> <li>• <b>Wireless Remote Control ML-L3</b> (□ 97): The ML-L3 uses a 3 V CR2025 battery.</li> </ul>  <p>Pressing the battery-chamber latch to the right (①), insert a fingernail into the gap and open the battery chamber (②). Ensure that the battery is inserted in the correct orientation (④).</p> <ul style="list-style-type: none"> <li>• <b>Wireless Remote Controller WR-R10/WR-T10:</b> When a WR-R10 wireless remote controller is attached, the camera can be controlled wirelessly using a WR-T10 wireless remote controller (□ 99, 258).</li> <li>• <b>Wireless Remote Controller WR-1</b> (□ 99, 258): WR-1 units are used in groups of two or more, with one functioning as a transmitter and the remaining units acting as receivers. The receivers are attached to the accessory terminals of one or more cameras, allowing the transmitter to be used to release the camera shutters.</li> </ul>

**Microphones Stereo Microphone ME-1** (☐ 161)**Accessory terminal accessories**

The D3300 is equipped with an accessory terminal for **WR-1** and **WR-R10 wireless remote controllers** (☐ 99, 258), **MC-DC2 remote cords** (☐ 110, 258), and **GP-1/GP-1A GPS units** (☐ 259), which connect with the ◀ mark on the connector

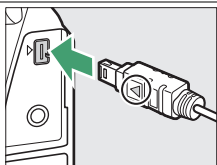

aligned with the ▶ next to the accessory terminal (close the connector cover when the terminal is not in use).

**USB and A/V connector accessories**

- **UC-E17 and UC-E6 USB cables** (☐ 204, 208): The supplied UC-E17 cable is not available for separate purchase; purchase UC-E6 cables instead.
- **EG-CP14 audio/video cables**
- **Wireless Mobile Adapter WU-1a** (☐ 260): Supports two-way communication between the camera and smart devices running the Wireless Mobile Utility.

**Optional Accessories**

Availability may vary with country or region. See our website or brochures for the latest information.

## Approved Memory Cards

The following SD memory cards have been tested and approved for use in the D3300. Cards with class 6 or faster write speeds are recommended for movie recording. Recording may end unexpectedly when cards with slower write speeds are used.

	SD memory cards	SDHC memory cards <sup>2</sup>	SDXC memory cards <sup>3</sup>
SanDisk	2 GB <sup>1</sup>	4 GB, 8 GB, 16 GB, 32 GB	64 GB
Toshiba			
Panasonic		4 GB, 6 GB, 8 GB, 12 GB, 16 GB, 24 GB, 32 GB	48 GB, 64 GB
Lexar Media		4 GB, 8 GB, 16 GB, 32 GB	—
Platinum II			64 GB
Professional			64 GB, 128 GB
Full-HD Video		—	4 GB, 8 GB, 16 GB

- 1 Check that any card readers or other devices with which the card will be used support 2 GB cards.
- 2 Check that any card readers or other devices with which the card will be used are SDHC-compliant. The camera supports UHS-I.
- 3 Check that any card readers or other devices with which the card will be used are SDXC-compliant. The camera supports UHS-I.



Other cards have not been tested. For more details on the above cards, please contact the manufacturer.

## **Attaching a Power Connector and AC Adapter**

Turn the camera off before attaching an optional power connector and AC adapter.

### **1 Ready the camera.**

Open the battery-chamber (①) and power connector (②) covers.

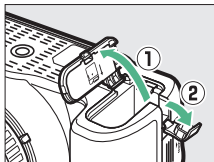

### **2 Insert the EP-5A power connector.**

Be sure to insert the connector in the orientation shown, using the connector to keep the orange battery latch pressed to one side. Be sure the connector is fully inserted.

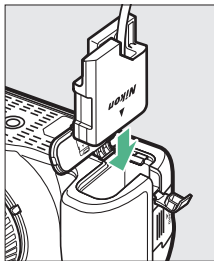

### **3 Close the battery-chamber cover.**

Position the power connector cable so that it passes through the power connector slot and close the battery-chamber cover.

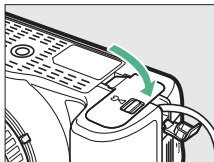

---

## 4 Connect the AC adapter.

Connect the AC adapter power cable to the AC socket on AC adapter (3) and the EP-5A power cable to the DC socket (4). A  icon is displayed in the monitor when the camera is powered by the AC adapter and power connector.

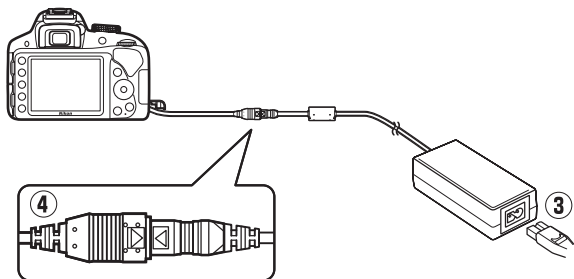



## Caring for the Camera

### Storage

When the camera will not be used for an extended period, remove the battery and store it in a cool, dry area with the terminal cover in place. To prevent mold or mildew, store the camera in a dry, well-ventilated area. Do not store your camera with naphtha or camphor moth balls or in locations that:

- are poorly ventilated or subject to humidities of over 60%
- are next to equipment that produces strong electromagnetic fields, such as televisions or radios
- are exposed to temperatures above 50 °C (122 °F) or below -10 °C (14 °F)

### Cleaning

<b>Camera body</b>	Use a blower to remove dust and lint, then wipe gently with a soft, dry cloth. After using the camera at the beach or seaside, wipe off sand or salt with a cloth lightly dampened in distilled water and dry thoroughly. <b>Important:</b> <i>Dust or other foreign matter inside the camera may cause damage not covered under warranty.</i>
<b>Lens, mirror, and viewfinder</b>	These glass elements are easily damaged. Remove dust and lint with a blower. If using an aerosol blower, keep the can vertical to prevent the discharge of liquid. To remove fingerprints and other stains, apply a small amount of lens cleaner to a soft cloth and clean with care.
<b>Monitor</b>	Remove dust and lint with a blower. When removing fingerprints and other stains, wipe the surface lightly with a soft cloth or chamois leather. Do not apply pressure, as this could result in damage or malfunction.

*Do not use alcohol, thinner, or other volatile chemicals.*

## Image Sensor Cleaning

If you suspect that dirt or dust on the image sensor is appearing in photographs, you can clean the sensor using the **Clean image sensor** option in the setup menu. The sensor can be cleaned at any time using the **Clean now** option, or cleaning can be performed automatically when the camera is turned on or off.

### ■ “Clean Now”

- 1 Place the camera base down.**  
Image sensor cleaning is most effective when the camera is placed base down as shown at right.

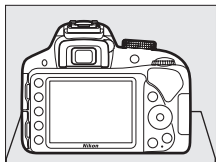

- 2 Select Clean image sensor in the setup menu.**  
Press the **MENU** button to display the menus. Highlight **Clean image sensor** in the setup menu (📖 231) and press ►.

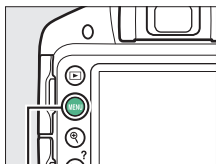

MENU button



- 3** Select **Clean now**.  
Highlight **Clean now** and  
press **OK**.



The camera will check the image sensor and then begin cleaning. **b54** flashes in the viewfinder and other operations can not be performed. Do not remove or disconnect the power source until cleaning is complete and the message shown at right is no longer displayed.



## ■ “Clean at Startup/Shutdown”

### 1 Select Clean at startup/ shutdown.

Select **Clean image sensor**, then highlight **Clean at startup/shutdown** and press **▶**.

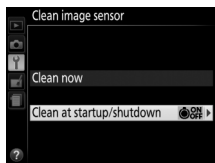

### 2 Select an option.

Highlight an option and press **OK**. Choose from **Clean at startup**, **Clean at shutdown**, **Clean at startup & shutdown**, and **Cleaning off**.

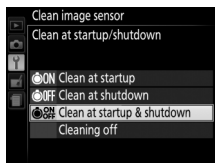

#### ✔ Image Sensor Cleaning

Using camera controls during startup interrupts image sensor cleaning.

Cleaning is performed by vibrating the image sensor. If dust can not be fully removed using the options in the **Clean image sensor** menu, clean the image sensor manually (□ 317) or consult a Nikon-authorized service representative.

If image sensor cleaning is performed several times in succession, image sensor cleaning may be temporarily disabled to protect the camera's internal circuitry. Cleaning can be performed again after a short wait.

## Manual Cleaning

If foreign matter can not be removed from the image sensor using the **Clean image sensor** option in the setup menu (☰ 314), the sensor can be cleaned manually as described below. Note, however, that the sensor is extremely delicate and easily damaged. Nikon recommends that the sensor be cleaned only by Nikon-authorized service personnel.

---

### 1 Charge the battery.

A reliable power source is required when inspecting or cleaning the image sensor. Be sure the battery is fully charged before proceeding.

---

### 2 Remove the lens.

Turn the camera off and remove the lens.

---

### 3 Select **Lock mirror up for cleaning**.

Turn the camera on and press the **MENU** button to display the menus. Highlight **Lock mirror up for cleaning** in the setup menu and press **▶** (note that this option is not available at battery levels of  or below).

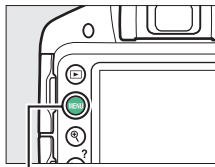

MENU button



---

#### 4 Press **OK**.

The message shown at right will be displayed in the monitor.

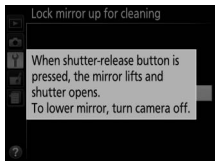

---

#### 5 Raise the mirror.

Press the shutter-release button all the way down. The mirror will be raised and the shutter curtain will open, revealing the image sensor.



---

#### 6 Examine the image sensor.

Holding the camera so that light falls on the image sensor, examine the interior of the camera for dust or lint. If no foreign objects are present, proceed to Step 8.

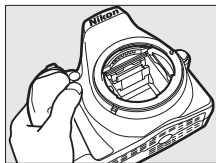

---

#### 7 Clean the sensor.

Remove any dust and lint from the sensor with a blower. Do not use a blower-brush, as the bristles could damage the sensor. Dirt that can not be removed with a blower can only be removed by Nikon-authorized service personnel. Under no circumstances should you touch or wipe the sensor.



---

## 8 Turn the camera off.

The mirror will return to the down position and the shutter curtain will close. Replace the lens or body cap.

### Use a Reliable Power Source

The shutter curtain is delicate and easily damaged. If the camera powers off while the mirror is raised, the curtain will close automatically. To prevent damage to the curtain, observe the following precautions:

- Do not turn the camera off or remove or disconnect the power source while the mirror is raised.
- If the battery runs low while the mirror is raised, a beep will sound and the self-timer lamp will flash to warn that the shutter curtain will close and the mirror will be lowered after about two minutes. End cleaning or inspection immediately.

### **Foreign Matter on the Image Sensor**

Foreign matter entering the camera when lenses or body caps are removed or exchanged (or in rare circumstances lubricant or fine particles from the camera itself) may adhere to the image sensor, where it may appear in photographs taken under certain conditions. To protect the camera when no lens is in place, be sure to replace the body cap provided with the camera, being careful to first remove all dust and other foreign matter that may be adhering to the camera mount, lens mount, and body cap. Avoid attaching the body cap or exchanging lenses in dusty environments.

Should foreign matter find its way onto the image sensor, use the image sensor cleaning option as described on page 314. If the problem persists, clean the sensor manually (☞ 317) or have the sensor cleaned by authorized Nikon service personnel. Photographs affected by the presence of foreign matter on the sensor can be retouched using the clean image options available in some imaging applications.

### **Servicing the Camera and Accessories**

The camera is a precision device and requires regular servicing. Nikon recommends that the camera be inspected by the original retailer or Nikon-authorized service representative once every one to two years, and that it be serviced once every three to five years (note that fees apply to these services). Frequent inspection and servicing are particularly recommended if the camera is used professionally. Any accessories regularly used with the camera, such as lenses or optional flash units, should be included when the camera is inspected or serviced.



## Caring for the Camera and Battery: Cautions

### Caring for the Camera

**Do not drop:** The product may malfunction if subjected to strong shocks or vibration.

**Keep dry:** This product is not waterproof, and may malfunction if immersed in water or exposed to high levels of humidity. Rusting of the internal mechanism can cause irreparable damage.

**Avoid sudden changes in temperature:** Sudden changes in temperature, such as those that occur when entering or leaving a heated building on a cold day, can cause condensation inside the device. To prevent condensation, place the device in a carrying case or plastic bag before exposing it to sudden changes in temperature.

**Keep away from strong magnetic fields:** Do not use or store this device in the vicinity of equipment that generates strong electromagnetic radiation or magnetic fields. Strong static charges or the magnetic fields produced by equipment such as radio transmitters could interfere with the monitor, damage data stored on the memory card, or affect the product's internal circuitry.

**Do not leave the lens pointed at the sun:** Do not leave the lens pointed at the sun or other strong light source for an extended period. Intense light may cause the image sensor to deteriorate or produce a white blur effect in photographs.

**Turn the product off before removing or disconnecting the power source:** Do not unplug the product or remove the battery while the product is on or while images are being recorded or deleted. Forcibly cutting power in these circumstances could result in loss of data or in damage to product memory or internal circuitry. To prevent an accidental interruption of power, avoid carrying the product from one location to another while the AC adapter is connected.

**Cleaning:** When cleaning the camera body, use a blower to gently remove dust and lint, then wipe gently with a soft, dry cloth. After using the camera at the beach or seaside, wipe off any sand or salt using a cloth lightly dampened in pure water and then dry the camera thoroughly.

The lens and mirror are easily damaged. Dust and lint should be gently removed with a blower. When using an aerosol blower, keep the can vertical to prevent discharge of liquid. To remove fingerprints and other stains from the lens, apply a small amount of lens cleaner to a soft cloth and wipe the lens carefully.

See “Image Sensor Cleaning” (☞ 314, 317) for information on cleaning the image sensor.

**Do not touch the shutter curtain:** The shutter curtain is extremely thin and easily damaged. Under no circumstances should you exert pressure on the curtain, poke it with cleaning tools, or subject it to powerful air currents from a blower. These actions could scratch, deform, or tear the curtain.

**Storage:** To prevent mold or mildew, store the camera in a dry, well-ventilated area. If you are using an AC adapter, unplug the adapter to prevent fire. If the product will not be used for an extended period, remove the battery to prevent leakage and store the camera in a plastic bag containing a desiccant. Do not, however, store the camera case in a plastic bag, as this may cause the material to deteriorate. Note that desiccant gradually loses its capacity to absorb moisture and should be replaced at regular intervals.

To prevent mold or mildew, take the camera out of storage at least once a month. Turn the camera on and release the shutter a few times before putting it away.

Store the battery in a cool, dry place. Replace the terminal cover before putting the battery away.

**Notes on the monitor:** The monitor is constructed with extremely high precision; at least 99.99% of pixels are effective, with no more than 0.01% being missing or defective. Hence while these displays may contain pixels that are always lit (white, red, blue, or green) or always off (black), this is not a malfunction and has no effect on images recorded with the device.

Images in the monitor may be difficult to see in a bright light.

Do not apply pressure to the monitor, as this could cause damage or malfunction. Dust or lint on the monitor can be removed with a blower. Stains can be removed by wiping lightly with a soft cloth or chamois leather. Should the monitor break, care should be taken to avoid injury from broken glass and to prevent liquid crystal from the monitor touching the skin or entering the eyes and mouth.

**Moiré:** Moiré is an interference pattern created by the interaction of an image containing a regular, repeating grid, such as the pattern of weave in cloth or windows in a building, with the camera image sensor grid. If you notice moiré in your photographs, try changing the distance to the subject, zooming in and out, or changing the angle between the subject and the camera.

## **Caring for the Battery**







Batteries may leak or explode if improperly handled. Observe the following precautions when handling batteries:

- Use only batteries approved for use in this equipment.
- Do not expose the battery to flame or excessive heat.
- Keep the battery terminals clean.
- Turn the product off before replacing the battery.
- Remove the battery from the camera or charger when not in use and replace the terminal cover. These devices draw minute amounts of charge even when off and could draw the battery down to the point that it will no longer function. If the battery will not be used for some time, insert it in the camera and run it flat before removing it and storing it in a location with an ambient temperature of 15 °C to 25 °C (59 °F to 77 °F; avoid hot or extremely cold locations). Repeat this process at least once every six months.
- Turning the camera on and off repeatedly when the battery is fully discharged will shorten battery life. Batteries that have been fully discharged must be charged before use.
- The internal temperature of the battery may rise while the battery is in use. Attempting to charge the battery while the internal temperature is elevated will impair battery performance, and the battery may not charge or charge only partially. Wait for the battery to cool before charging.
- Continuing to charge the battery after it is fully charged can impair battery performance.













- A marked drop in the time a fully charged battery retains its charge when used at room temperature indicates that it requires replacement. Purchase a new EN-EL14a battery.
- Charge the battery before use. When taking photographs on important occasions, ready a spare EN-EL14a battery and keep it fully charged. Depending on your location, it may be difficult to purchase replacement batteries on short notice. Note that on cold days, the capacity of batteries tends to decrease. Be sure the battery is fully charged before taking photographs outside in cold weather. Keep a spare battery in a warm place and exchange the two as necessary. Once warmed, a cold battery may recover some of its charge.
- Used batteries are a valuable resource; recycle in accord with local regulations.













## Available Settings

The following table lists the settings that can be adjusted in each mode.

	 AUTO	P, S, A, M		
Image quality	✓	✓	✓	✓
Image size	✓	✓	✓	✓
White balance	—	✓	—	—
Set Picture Control	—	✓	—	—
Auto distortion control	✓	✓	✓	✓ (not available in  mode)
Color space	✓	✓	✓	✓
Active D-Lighting	—	✓	—	—
Noise reduction	✓	✓	✓	✓ (not available in  mode)
ISO sensitivity settings	—	✓	✓	✓ (not available in  and  modes)

Shooting menu 1

			P, S, A, M			
<b>Shooting menu 1</b>	AF-area mode	Viewfinder	✓ <sup>2</sup>	✓	✓ <sup>2</sup>	✓ <sup>2</sup> (not available in  ,  , and  modes)
		Live view/movie	—	✓	✓ <sup>2</sup>	✓ <sup>2</sup> (not available in  mode)
	Built-in AF-assist illuminator		✓	✓	✓ (not available in  and  modes)	✓ (not available in  ,  , and  modes)
	Metering		—	✓	—	—
	Flash cntrl for built-in flash/Optional flash		—	✓	—	—
	Movie settings		✓	✓	✓	✓

			P, S, A, M			
Other settings	Release mode	✓ <sup>2</sup>	✓	✓ <sup>2</sup>	✓ <sup>2</sup> (not available in  mode)	
	Focus mode	Viewfinder	✓	✓	✓	✓ (not available in  and  modes)
		Live view/ movie	✓	✓	✓	✓
	AE-L/AF-L button hold	—	✓	✓ <sup>2</sup>	✓ <sup>2</sup>	
	Flexible program	—	(available only in <b>P</b> mode)	—	—	
	Exposure compensation	—	✓	—	✓ <sup>2</sup> (available only in  and  modes)	
	Flash mode	✓ <sup>2</sup> (not available in  mode)	✓	✓ <sup>2</sup> (not available in  and  modes)	✓ <sup>2</sup> (available only in <b>VI</b> , <b>POP</b> ,  ,  , and  modes)	
	Flash compensation	—	✓	—	—	

1 Reset with **Reset shooting menu** ( 224).

2 Reset when mode dial is rotated to new setting.



## Troubleshooting

If the camera fails to function as expected, check the list of common problems below before consulting your retailer or Nikon representative.

### **Battery/Display**

---

**The camera is on but does not respond:** Wait for recording to end. If the problem persists, turn the camera off. If the camera does not turn off, remove and reinsert the battery or, if you are using an AC adapter, disconnect and reconnect the AC adapter. Note that although any data currently being recorded will be lost, data that have already been recorded will not be affected by removing or disconnecting the power source.

---

**Viewfinder is out of focus:** Adjust viewfinder focus (☐ 20). If this does not correct the problem, select single-servo autofocus (**AF-S**; ☐ 74), single-point AF ([\*]; ☐ 78), and the center focus point, and then frame a high-contrast subject in the center focus point and press the shutter-release button halfway to focus the camera. With the camera in focus, use the diopter adjustment control to bring the subject into clear focus in the viewfinder. If necessary, viewfinder focus can be further adjusted using optional corrective lenses (☐ 307).

---

**Displays turn off without warning:** Choose longer delays for **Auto off timers** (☐ 245).

---

**Information display does not appear in monitor:** Shutter-release button is pressed halfway. If information display does not appear when you remove your finger from shutter-release button, confirm that **On** is selected for **Auto info display** (☐ 238) and that battery is charged.

---

**Viewfinder display is unresponsive and dim:** The response times and brightness of this display vary with temperature.

---

## Shooting (All Modes)

---

**Camera takes time to turn on:** Delete files or folders.

---

**Shutter-release disabled:**

- Memory card is locked, full, or not inserted (☐ 15, 23, 338).
  - **Release locked** is selected for **Slot empty release lock** (☐ 253) and no memory card is inserted (☐ 15).
  - Built-in flash is charging (☐ 31).
  - Camera is not in focus (☐ 27).
  - CPU lens with aperture ring attached but aperture not locked at highest f-number (☐ 291).
  - Non-CPU lens is attached but camera is not in mode **M** (☐ 292).
- 

**Only one shot taken each time shutter-release button is pressed in continuous shooting mode:** Continuous shooting is not available if built-in flash fires (☐ 69, 89).

---

**Final photo is larger than area shown in viewfinder:** Viewfinder horizontal and vertical frame coverage is approximately 95%.

---

**Photos are out of focus:**

- AF-S, AF-P, or AF-I lens is not attached: use AF-S, AF-P, or AF-I lens or focus manually.
  - Camera unable to focus using autofocus: use manual focus or focus lock (☐ 76, 81, 83).
  - Camera is in manual focus mode: focus manually (☐ 83).
- 

**Focus does not lock when shutter-release button is pressed halfway:** Use  $\overset{\text{AF-L}}{\text{AF-L}}$  (**○-n**) button to lock focus when live view is off and **AF-C** is selected for focus mode or when photographing moving subjects in **AF-A** mode (☐ 81).

---

**Can not select focus point:**

- **[ ]** (**Auto-area AF**; ☐ 78) is selected: choose another AF-area mode.
  - Press shutter-release button halfway to start standby timer (☐ 31).
- 

**Can not select AF-area mode:** Manual focus selected (☐ 74, 83).

---

---

**AF-assist illuminator does not light:**

- AF-assist illuminator does not light if **AF-C** is selected for autofocus mode (☐ 74) or if continuous-servo autofocus is selected when the camera is in **AF-A** mode. Choose **AF-S**. AF-assist is also not available when [3D] (**3D-tracking (11 points)**) is selected for AF-area mode; if single-point or dynamic-area AF is selected, select center focus point (☐ 78, 80).
- The camera is currently in live view or a movie is being recorded.
- **Off** is selected for **Built-in AF-assist illuminator** (☐ 228).
- The AF-assist illuminator can not be used in some shooting modes (☐ 326).
- Illuminator has turned off automatically. Illuminator may become hot with continued use; wait for it to cool down.

---

**Image size can not be changed:** An NEF (RAW) option is selected for image quality (☐ 86).

---

**Camera is slow to record photos:**

- Depending on shooting conditions and memory card performance, access lamp may light for up to about a minute after shooting ends in continuous release mode.
- Turn noise reduction off (☐ 226).

---

**Noise (bright spots, randomly-spaced bright pixels, fog, or lines) appear in photos:**

- Choose lower ISO sensitivity or turn noise reduction on (☐ 226).
- Shutter speed is slower than 1 s: use noise reduction (☐ 226).
- Turn **Active D-Lighting** off to avoid heightening the effects of noise (☐ 123).

---

**No photo taken when remote control shutter-release button is pressed:**

- Replace battery in remote control (☐ 308).
  - Choose remote control release mode (☐ 97).
  - Flash is charging (☐ 31).
  - Time selected for **Remote on duration (ML-L3)** (☐ 247) has elapsed.
  - Bright light is interfering with ML-L3 remote control.
-

---

**Beep does not sound:**

- **Off** is selected for **Beep** (☞ 247).
- Camera is in quiet shutter-release mode (☞ 70), or movie is being recorded (☞ 155).
- **MF** or **AF-C** is selected as the focus mode or subject moves when **AF-A** is selected (☞ 74).

---

**Smudges appear in photographs:** Clean front and rear lens elements. If problem persists, perform image sensor cleaning (☞ 314).

---

**Date is not imprinted on photos:** An NEF (RAW) option is selected for image quality (☞ 86, 254).

---

**Sound is not recorded with movies:** **Microphone off** is selected for **Movie settings > Microphone** (☞ 158).

---

**Flicker or banding appears during live view or movie recording:** Choose an option for **Flicker reduction** that matches the frequency of the local AC power supply (☞ 241).

---

**Menu item can not be selected:** Some options are not available in all modes.

---

## **Shooting (P, S, A, M)**

---

### **Shutter-release disabled:**

- Non-CPU lens is attached: rotate camera mode dial to **M** (☞ 292).
  - Mode dial rotated to **S** after shutter speed of “Bulb” or “Time” selected in mode **M**: choose new shutter speed (☞ 104).
- 

### **Full range of shutter speeds not available:**

- Flash in use (☞ 93).
  - When **On** is selected for **Movie settings > Manual movie settings** in the shooting menu, the range of available shutter speed varies with the frame rate (☞ 159).
- 

**Can not select desired aperture:** Range of available apertures varies with lens used.

---

### **Colors are unnatural:**

- Adjust white balance to match light source (☞ 124).
  - Adjust **Set Picture Control** settings (☞ 135).
- 

**Can not measure white balance:** Subject is too dark or too bright (☞ 131).

---

**Image can not be selected as source for preset white balance:** Image was not created with D3300 (☞ 133).

---

**Effects of Picture Control differ from image to image:** **A** (auto) is selected for sharpening, contrast, or saturation. For consistent results over a series of photos, choose another setting (☞ 140).

---

**Metering can not be changed:** Autoexposure lock is in effect (☞ 116).

---

**Exposure compensation can not be used:** Choose mode **P**, **S**, or **A** (☞ 100, 119).

---

**Noise (reddish areas or other artifacts) appears in long time-exposures:** Turn noise reduction on (☞ 226).

---

## **Playback**

---

**NEF (RAW) image is not played back:** Photo was taken at image quality of NEF (RAW)+JPEG (☞ 86).

---

**Some pictures are not displayed during playback:** Select **All** for **Playback folder**. Note that **Current** is automatically selected after photograph is taken (☞ 220).

---

**“Tall” (portrait) orientation photos are displayed in “wide” (landscape) orientation:**

- Select **On** for **Rotate tall** (☞ 221).
  - Photo was taken with **Off** selected for **Auto image rotation** (☞ 243).
  - Photo is displayed in image review (☞ 221).
  - Camera was pointed up or down when photo was taken (☞ 243).
- 

**Can not delete picture:**

- Picture is protected: remove protection (☞ 184).
  - Memory card is locked (☞ 23).
- 

**Can not retouch picture:** Photo can not be further edited with this camera (☞ 264).

---

**Can not change print order:**

- Memory card is full: delete pictures (☞ 192, 338).
  - Memory card is locked (☞ 23).
- 

**Can not select photo for printing:** Photo is in NEF (RAW) format. Create JPEG copy using **NEF (RAW) processing** or transfer to computer and print using supplied software or Capture NX 2 (☞ 204, 275, 307).

---

---

**Picture is not displayed on TV:**

- Choose correct video mode (☐ 260) or output resolution (☐ 218).
- A/V (☐ 215) or HDMI (☐ 217) cable is not correctly connected.

---

**Camera does not respond to remote control for HDMI-CEC television:**

- Select **On** for **HDMI > Device control** in the setup menu (☐ 218).
- Adjust HDMI-CEC settings for the television as described in documentation provided with the device.

---

**Can not transfer photos to computer:** OS not compatible with camera or transfer software. Use card reader to copy photos to computer (☐ 203).

---

**Photos are not displayed in Capture NX 2:** Update to latest version (☐ 307).

---

**Image Dust Off option in Capture NX 2 does not have desired effect:** Image sensor cleaning changes the position of dust on the image sensor. Image Dust Off reference data recorded before image sensor cleaning is performed can not be used with photographs taken after image sensor cleaning is performed. Image Dust Off reference data recorded after image sensor cleaning is performed can not be used with photographs taken before image sensor cleaning is performed (☐ 239).

---

## **Miscellaneous**

---

**Date of recording is not correct:** Set camera clock (☐ 18, 242).



---







**Menu item can not be selected:** Some options are not available at certain combinations of settings or when no memory card is inserted (☐ 15, 263, 326).

## Error Messages



This section lists the indicators and error messages that appear in the viewfinder and monitor.

### Warning Icons

A flashing  in the monitor or  in the viewfinder indicates that a warning or error message can be displayed in the monitor by pressing the  (?) button.

Indicator		Solution	
Monitor	Viewfinder		
<b>Lock lens aperture ring at minimum aperture (largest f/-number).</b>	<b><i>F E</i></b>  (flashes)	Set lens aperture ring to minimum aperture (highest f-number).	291
<b>Lens not attached</b>	<b><i>F -</i></b>  (flashes)	<ul style="list-style-type: none"> <li>• Attach non-IX NIKKOR lens.</li> <li>• If non-CPU lens is attached, select mode <b>M</b>.</li> </ul>	290 108
<b>Before taking photos, rotate the zoom ring to extend the lens.</b>	<b><i>F -</i></b>  (flashes)	A lens with a retractable lens barrel button is attached with the lens barrel retracted. Press the retractable lens barrel button and rotate the zoom ring to extend the lens.	17
<b>Shutter release disabled. Recharge battery.</b>	  (flashes)	Turn camera off and recharge or replace battery.	14, 17
<b>This battery cannot be used. Choose battery designated for use in this camera.</b>	 (flashes)	Use Nikon-approved battery.	306



Indicator		Solution	📖
Monitor	Viewfinder		
Initialization error. Turn camera off and then on again.	 / (E r r) (flashes)	Turn camera off, remove and replace battery, and then turn camera on again.	15, 17
Battery level is low. Complete operation and turn camera off immediately.	—	End cleaning and turn camera off and recharge or replace battery.	319
Clock not set	—	Set camera clock.	18, 242
No memory card inserted	(- E -)/[?] (flashes)	Turn camera off and confirm that card is correctly inserted.	15
Memory card is locked. Slide lock to “write” position.	 d (flashes)	Memory card is locked (write protected). Slide card write-protect switch to “write” position.	23
This memory card cannot be used. Card may be damaged. Insert another card.	 d/(E r r) (flashes)	<ul style="list-style-type: none"> <li>• Use approved card.</li> <li>• Format card. If problem persists, card may be damaged. Contact Nikon-authorized service representative.</li> <li>• Error creating new folder. Delete files or insert new memory card.</li> <li>• Insert new memory card.</li> <li>• Eye-Fi card is still emitting wireless signal after <b>Disable</b> has been selected for <b>Eye-Fi upload</b>. To terminate wireless transmission, turn the camera off and remove the card.</li> </ul>	310 234  15, 192  15 261

Indicator		Solution	📖
Monitor	Viewfinder		
<b>Not available if Eye-Fi card is locked.</b>	<b>[d]/[Err]</b> (flashes)	Eye-Fi card is locked (write protected). Slide card write-protect switch to “write” position.	23
<b>This card is not formatted. Format the card.</b>	<b>(For)</b> (flashes)	Format card or turn camera off and insert new memory card.	15, 234
<b>Card is full</b>	<b>FuL/G/?</b> (flashes)	<ul style="list-style-type: none"> <li>• Reduce quality or size.</li> <li>• Delete photographs.</li> <li>• Insert new memory card.</li> </ul>	85 192 15
—	● (flashes)	Camera can not focus using autofocus. Change composition or focus manually.	27, 76, 83
<b>Subject is too bright</b>	? (flashes)	<ul style="list-style-type: none"> <li>• Use a lower ISO sensitivity.</li> <li>• Use commercial ND filter.</li> <li>• In mode: <ul style="list-style-type: none"> <li><b>S</b> Increase shutter speed</li> <li><b>A</b> Choose a smaller aperture (higher f-number)</li> <li><b>[ ]</b> Choose another shooting mode</li> </ul> </li> </ul>	95 306 105 107 4
<b>Subject is too dark</b>		<ul style="list-style-type: none"> <li>• Use a higher ISO sensitivity.</li> <li>• Use flash.</li> <li>• In mode: <ul style="list-style-type: none"> <li><b>S</b> Lower shutter speed</li> <li><b>A</b> Choose a larger aperture (lower f-number)</li> </ul> </li> </ul>	95 89 105 107

Indicator		Solution	📖
Monitor	Viewfinder		
No "Bulb" in S mode	⚡ ⚡ ⚡ (flashes)	Change shutter speed or select mode M.	105, 108
No "Time" in S mode	- - (flashes)		
Press the live-view button when you are ready to start a panorama.	EFFECTS (flashes)/ P R N O	Press the  button to start live view before recording a panorama.	63
Cannot shoot panorama with lens of this focal length.	—	Use a lens with a focal length of 55 mm or less to shoot panoramas. If you are using a zoom lens, choose a focal length of 55 mm or less.	63
—	⚡ (flashes)	Flash has fired at full power. Check photo in monitor; if underexposed, adjust settings and try again.	—
—	⚡/? (flashes)	<ul style="list-style-type: none"> <li>• Use the flash.</li> <li>• Change distance to subject, aperture, flash range, or ISO sensitivity.</li> <li>• Lens focal length is less than 18 mm: use a longer focal length.</li> <li>• Optional SB-400 or SB-300 flash unit attached: flash is in bounce position or focus distance is very short. Continue shooting; if necessary, increase focus distance to prevent shadows from appearing in photograph.</li> </ul>	89 94, 95, 107 — —

Indicator		Solution	📖
Monitor	Viewfinder		
<b>Flash error</b>	⚠️ (flashes)	Error occurred updating firmware for optional flash unit. Contact Nikon-authorized service representative.	—
<b>Error. Press shutter release button again.</b>	Er r (flashes)	Release shutter. If error persists or appears frequently, consult Nikon-authorized service representative.	—
<b>Start-up error. Contact a Nikon-authorized service representative.</b>		Consult Nikon-authorized service representative.	—
<b>Metering error</b>			
<b>Unable to start live view. Please wait for camera to cool.</b>	—	Wait for the internal circuits to cool before resuming live view or movie recording.	152, 157
<b>Folder contains no images.</b>	—	Folder selected for playback contains no images (note that this message will be displayed if memory card is inserted after <b>Current</b> is selected for <b>Playback folder</b> in playback menu and playback started before any pictures are taken). Insert another memory card or select <b>All</b> for <b>Playback folder</b> .	15, 220

Indicator		Solution	📖
Monitor	Viewfinder		
Cannot display this file.	—	File can not be played back on camera.	—
Cannot select this file.	—	Images created with other devices can not be retouched.	264
No image for retouching.	—	Memory card does not contain NEF (RAW) images for use with <b>NEF (RAW) processing.</b>	275
Check printer.	—	Check printer. To resume, select <b>Continue</b> (if available).	—*
Check paper.	—	Paper is not selected size. Insert paper of correct size and select <b>Continue.</b>	—*
Paper jam.	—	Clear jam and select <b>Continue.</b>	—*
Out of paper.	—	Insert paper of selected size and select <b>Continue.</b>	—*
Check ink supply.	—	Check ink. To resume, select <b>Continue.</b>	—*
Out of ink.	—	Replace ink and select <b>Continue.</b>	—*







\* See printer manual for more information.

# Specifications

## ■ Nikon D3300 Digital Camera



Type	
Type	Single-lens reflex digital camera
Lens mount	Nikon F mount (with AF contacts)
Effective angle of view	Nikon DX format; focal length equivalent to approx. 1.5× that of lenses with FX format angle of view
Effective pixels	
Effective pixels	24.2 million
Image sensor	
Image sensor	23.5 × 15.6 mm CMOS sensor
Total pixels	24.78 million
Dust-reduction System	Image sensor cleaning, Image Dust Off reference data (optional Capture NX 2 software required)
Storage	
Image size (pixels)	<ul style="list-style-type: none"><li>•  (easy panorama) mode:<ul style="list-style-type: none"><li>- Normal, horizontal pan: 4800 × 1080</li><li>- Normal, vertical pan: 1632 × 4800</li><li>- Wide, horizontal pan: 9600 × 1080</li><li>- Wide, vertical pan: 1632 × 9600</li></ul></li><li>• Other modes:<ul style="list-style-type: none"><li>- 6000 × 4000 (Large)</li><li>- 4496 × 3000 (Medium)</li><li>- 2992 × 2000 (Small)</li></ul></li></ul>
File format	<ul style="list-style-type: none"><li>• <b>NEF (RAW)</b>: 12 bit, compressed</li><li>• <b>JPEG</b>: JPEG-Baseline compliant with fine (approx. 1 : 4), normal (approx. 1 : 8), or basic (approx. 1 : 16) compression</li><li>• <b>NEF (RAW)+JPEG</b>: Single photograph recorded in both NEF (RAW) and JPEG formats</li></ul>



Storage	
<b>Picture Control System</b>	Standard, Neutral, Vivid, Monochrome, Portrait, Landscape; selected Picture Control can be modified
<b>Media</b>	SD (Secure Digital) and UHS-I compliant SDHC and SDXC memory cards
<b>File system</b>	DCF 2.0, DPOF, Exif 2.3, PictBridge
Viewfinder	
<b>Viewfinder</b>	Eye-level pentamirror single-lens reflex viewfinder
<b>Frame coverage</b>	Approx. 95% horizontal and 95% vertical
<b>Magnification</b>	Approx. $0.85 \times$ (50 mm f/1.4 lens at infinity, $-1.0 \text{ m}^{-1}$ )
<b>Eyepoint</b>	18 mm ( $-1.0 \text{ m}^{-1}$ ; from center surface of viewfinder eyepiece lens)
<b>Diopter adjustment</b>	$-1.7 - +0.5 \text{ m}^{-1}$
<b>Focusing screen</b>	Type B BriteView Clear Matte Mark VII screen
<b>Reflex mirror</b>	Quick return
<b>Lens aperture</b>	Instant return, electronically controlled
Lens	
<b>Compatible lenses</b>	<p>Autofocus is available with AF-S, AF-P, and AF-I lenses. Autofocus is not available with other type G and D lenses, AF lenses (IX NIKKOR and lenses for the F3AF are not supported), and AI-P lenses. Non-CPU lenses can be used in mode <b>M</b>, but the camera exposure meter will not function.</p> <p>The electronic rangefinder can be used with lenses that have a maximum aperture of f/5.6 or faster.</p>

Shutter	
Type	Electronically-controlled vertical-travel focal-plane shutter
Speed	$\frac{1}{4000}$ – 30 s in steps of $\frac{1}{3}$ EV; Bulb; Time
Flash sync speed	X= $\frac{1}{200}$ s; synchronizes with shutter at $\frac{1}{200}$ s or slower
Release	
Release mode	 (single frame),  (continuous),  (quiet shutter release),  (self-timer),  2s (delayed remote; ML-L3),  (quick-response remote; ML-L3)
Frame advance rate	Up to 5 fps <b>Note:</b> Frame rates assume manual focus, manual or shutter-priority auto exposure, a shutter speed of $\frac{1}{250}$ s or faster, and other settings at default values.
Self-timer	2 s, 5 s, 10 s, 20 s; 1–9 exposures
Exposure	
Metering mode	TTL exposure metering using 420-pixel RGB sensor
Metering method	<ul style="list-style-type: none"> <li>• <b>Matrix metering:</b> 3D color matrix metering II (type G, E, and D lenses); color matrix metering II (other CPU lenses)</li> <li>• <b>Center-weighted metering:</b> Weight of 75% given to 8-mm circle in center of frame</li> <li>• <b>Spot metering:</b> Meters 3.5-mm circle (about 2.5% of frame) centered on selected focus point</li> </ul>
Range (ISO 100, f/1.4 lens, 20 °C/68 °F)	<ul style="list-style-type: none"> <li>• <b>Matrix or center-weighted metering:</b> 0–20 EV</li> <li>• <b>Spot metering:</b> 2–20 EV</li> </ul>
Exposure meter coupling	CPU



Exposure	
<b>Mode</b>	Auto modes (AUTO auto;  auto, flash off); programmed auto with flexible program (P); shutter-priority auto (S); aperture-priority auto (A); manual (M); scene modes ( portrait;  landscape;  child;  sports;  close up;  night portrait); special effects modes ( night vision; VI super vivid; POP pop;  photo illustration;  color sketch;  toy camera effect;  miniature effect;  selective color;  silhouette;  high key;  low key;  HDR painting;  easy panorama)
<b>Exposure compensation</b>	Can be adjusted by -5 – +5 EV in increments of 1/3 EV in P, S, A, and M modes
<b>Exposure lock</b>	Luminosity locked at detected value with  (O-m) button
<b>ISO sensitivity (Recommended Exposure Index)</b>	ISO 100 – 12800 in steps of 1 EV. Can also be set to approx. 1 EV (ISO 25600 equivalent) above ISO 12800; auto ISO sensitivity control available
<b>Active D-Lighting</b>	On, off
Focus	
<b>Autofocus</b>	Nikon Multi-CAM 1000 autofocus sensor module with TTL phase detection, 11 focus points (including one cross-type sensor), and AF-assist illuminator (range approx. 0.5–3 m/1 ft 8 in.–9 ft 10 in.)
<b>Detection range</b>	-1 – +19 EV (ISO 100, 20 °C/68 °F)

Focus	
<b>Lens servo</b>	<ul style="list-style-type: none"> <li>• <b>Autofocus (AF):</b> Single-servo AF (<b>AF-S</b>); continuous-servo AF (<b>AF-C</b>); auto AF-S/AF-C selection (<b>AF-A</b>); predictive focus tracking activated automatically according to subject status</li> <li>• <b>Manual focus (MF):</b> Electronic rangefinder can be used</li> </ul>
<b>Focus point</b>	Can be selected from 11 focus points
<b>AF-area mode</b>	Single-point AF, dynamic-area AF, auto-area AF, 3D-tracking (11 points)
<b>Focus lock</b>	Focus can be locked by pressing shutter-release button halfway (single-servo AF) or by pressing <b>AE-L/AF-L</b> (  ) button
Flash	
<b>Built-in flash</b>	 : Auto flash with auto pop-up <b>P, S, A, M:</b> Manual pop-up with button release
<b>Guide Number</b>	Approx. 12/39, 12/39 with manual flash (m/ft, ISO 100, 20 °C/68 °F)
<b>Flash control</b>	<b>TTL:</b> i-TTL flash control using 420-pixel RGB sensor is available with built-in flash and SB-910, SB-900, SB-800, SB-700, SB-600, SB-400, or SB-300; i-TTL balanced fill-flash for digital SLR is used with matrix and center-weighted metering, standard i-TTL flash for digital SLR with spot metering
<b>Flash mode</b>	Auto, auto with red-eye reduction, auto slow sync, auto slow sync with red-eye reduction, fill-flash, red-eye reduction, slow sync, slow sync with red-eye reduction, rear-curtain with slow sync, rear-curtain sync, off

Flash	
<b>Flash compensation</b>	-3 – +1 EV in increments of 1/3 EV
<b>Flash-ready indicator</b>	Lights when built-in flash or optional flash unit is fully charged; flashes after flash is fired at full output
<b>Accessory shoe</b>	ISO 518 hot-shoe with sync and data contacts and safety lock
<b>Nikon Creative Lighting System (CLS)</b>	Advanced Wireless Lighting supported with SB-910, SB-900, SB-800, or SB-700 as a master flash or SU-800 as commander; Flash Color Information Communication supported with all CLS-compatible flash units
<b>Sync terminal</b>	AS-15 sync terminal adapter (available separately)
White balance	
<b>White balance</b>	Auto, incandescent, fluorescent (7 types), direct sunlight, flash, cloudy, shade, preset manual, all except preset manual with fine-tuning
Live view	
<b>Lens servo</b>	<ul style="list-style-type: none"> <li>• <b>Autofocus (AF):</b> Single-servo AF (<b>AF-S</b>); full-time-servo AF (<b>AF-F</b>)</li> <li>• <b>Manual focus (MF)</b></li> </ul>
<b>AF-area mode</b>	Face-priority AF, wide-area AF, normal-area AF, subject-tracking AF
<b>Autofocus</b>	Contrast-detect AF anywhere in frame (camera selects focus point automatically when face-priority AF or subject-tracking AF is selected)
<b>Automatic scene selection</b>	Available in  and  modes

<b>Movie</b>	
<b>Metering</b>	TTL exposure metering using main image sensor
<b>Metering method</b>	Matrix
<b>Frame size (pixels) and frame rate</b>	<ul style="list-style-type: none"> <li>• 1920 × 1080, 60p (progressive)/50p/30p/25p/24p, ★ high/normal</li> <li>• 1280 × 720, 60p/50p, ★ high/normal</li> <li>• 640 × 424, 30p/25p, ★ high/normal</li> </ul> <p>Frame rates of 30p (actual frame rate 29.97 fps) and 60p (actual frame rate 59.94 fps) are available when <b>NTSC</b> is selected for video mode. 25p and 50p are available when <b>PAL</b> is selected for video mode. Actual frame rate when 24p is selected is 23.976 fps.</p>
<b>File format</b>	MOV
<b>Video compression</b>	H.264/MPEG-4 Advanced Video Coding
<b>Audio recording format</b>	Linear PCM
<b>Audio recording device</b>	Built-in monaural or external stereo microphone; sensitivity adjustable
<b>ISO sensitivity</b>	ISO 100–12800; can also be set to approx. 1 EV (ISO 25600 equivalent) above ISO 12800
<b>Monitor</b>	
<b>Monitor</b>	7.5-cm (3-in.), approx. 921k-dot (VGA) TFT LCD with 170 ° viewing angle, approx. 100% frame coverage, and brightness adjustment
<b>Playback</b>	
<b>Playback</b>	Full-frame and thumbnail (4, 9, or 72 images or calendar) playback with playback zoom, movie and panorama playback, photo and/or movie slide shows, histogram display, highlights, auto image rotation, picture rating, and image comment (up to 36 characters)

Interface	
<b>USB</b>	Hi-Speed USB
<b>Video output</b>	NTSC, PAL
<b>HDMI output</b>	Type C mini-pin HDMI connector
<b>Accessory terminal</b>	<b>Wireless remote controllers:</b> WR-1, WR-R10 (available separately) <b>Remote cords:</b> MC-DC2 (available separately) <b>GPS units:</b> GP-1/GP-1A (available separately)
<b>Audio input</b>	Stereo mini-pin jack (3.5mm diameter); supports optional ME-1 stereo microphones
Supported languages	
<b>Supported languages</b>	Arabic, Bengali, Bulgarian, Chinese (Simplified and Traditional), Czech, Danish, Dutch, English, Finnish, French, German, Greek, Hindi, Hungarian, Indonesian, Italian, Japanese, Korean, Marathi, Norwegian, Persian, Polish, Portuguese (Portugal and Brazil), Romanian, Russian, Serbian, Spanish, Swedish, Tamil, Telugu, Thai, Turkish, Ukrainian, Vietnamese
Power source	
<b>Battery</b>	One rechargeable Li-ion EN-EL14a battery
<b>AC adapter</b>	EH-5b AC adapter; requires EP-5A power connector (available separately)
Tripod socket	
<b>Tripod socket</b>	1/4 in. (ISO 1222)

<b>Dimensions/weight</b>	
<b>Dimensions (W × H × D)</b>	Approx. 124 × 98 × 75.5 mm (4.9 × 3.9 × 3 in.)
<b>Weight</b>	Approx. 460 g (1 lb 0.2 oz) with battery and memory card but without body cap; approx. 410 g/14.5 oz (camera body only)
<b>Operating environment</b>	
<b>Temperature</b>	0 °C–40 °C (+32 °F–104 °F)
<b>Humidity</b>	85% or less (no condensation)

- Unless otherwise stated, all measurements are performed in conformity with Camera and Imaging Products Association (CIPA) standards or guidelines.
- All figures are for a camera with a fully-charged battery.
- Nikon reserves the right to change the appearance and specifications of the hardware and software described in this manual at any time and without prior notice. Nikon will not be held liable for damages that may result from any mistakes that this manual may contain.

## ■ ■ *MH-24 Battery Charger*

<b>Rated input</b>	AC 100–240 V, 50/60 Hz, 0.2 A maximum
<b>Rated output</b>	DC 8.4 V/0.9 A
<b>Supported batteries</b>	Nikon Rechargeable Li-ion Battery EN-EL14a
<b>Charging time</b>	Approx. 1 hour and 50 minutes at an ambient temperature of 25 °C/77 °F when no charge remains
<b>Operating temperature</b>	0 °C–40 °C (+32 °F–104 °F)
<b>Dimensions (W × H × D)</b>	Approx. 70 × 26 × 97 mm (2.8 × 1.0 × 3.8 in.), excluding plug adapter
<b>Weight</b>	Approx. 96 g (3.4 oz), excluding plug adapter

## ■ ■ *EN-EL14a Rechargeable Li-ion Battery*

<b>Type</b>	Rechargeable lithium-ion battery
<b>Rated capacity</b>	7.2 V/1230 mAh
<b>Operating temperature</b>	0 °C–40 °C (+32 °F–104 °F)
<b>Dimensions (W × H × D)</b>	Approx. 38 × 53 × 14 mm (1.5 × 2.1 × 0.6 in.)
<b>Weight</b>	Approx. 49 g (1.7 oz), excluding terminal cover

Nikon reserves the right to change the appearance and specifications of the hardware and software described in this manual at any time and without prior notice. Nikon will not be held liable for damages that may result from any mistakes that this manual may contain.

## ■ ■ *Supported Standards*

- **DCF Version 2.0:** The Design Rule for Camera File Systems (DCF) is a standard widely used in the digital camera industry to ensure compatibility among different makes of camera.
- **DPOF:** Digital Print Order Format (DPOF) is an industry-wide standard that allows pictures to be printed from print orders stored on the memory card.
- **Exif version 2.3:** The D3300 supports Exif (Exchangeable Image File Format for Digital Still Cameras) version 2.3, a standard in which information stored with photographs is used for optimal color reproduction when the images are output on Exif-compliant printers.
- **PictBridge:** A standard developed through cooperation with the digital camera and printer industries, allowing photographs to be output directly to a printer without first transferring them to a computer.
- **HDMI:** High-Definition Multimedia Interface is a standard for multimedia interfaces used in consumer electronics and AV devices capable of transmitting audiovisual data and control signals to HDMI-compliant devices via a single cable connection.



### **Trademark Information**

Mac OS and OS X are registered trademarks of Apple Inc. in the United States and/or other countries. Microsoft, Windows, and Windows Vista are either registered trademarks, or trademarks of Microsoft Corporation in the United States and/or other countries. PictBridge logo is a trademark. The SD, SDHC, and SDXC logos are trademarks of the SD-3C, LLC. HDMI, the HDMI logo and High-Definition Multimedia Interface are trademarks or registered trademarks of HDMI Licensing LLC.

## **HDMI**

All other trade names mentioned in this manual or the other documentation provided with your Nikon product are trademarks or registered trademarks of their respective holders.

### **FreeType License (FreeType2)**

Portions of this software are copyright © 2014 The FreeType Project (<http://www.freetype.org>). All rights reserved.

### **MIT License (HarfBuzz)**

Portions of this software are copyright © 2014 The HarfBuzz Project (<http://www.freedesktop.org/wiki/Software/HarfBuzz>). All rights reserved.

## Lens Kits

The camera can be purchased as a kit with the lens listed below.

### **AF-P DX NIKKOR 18–55mm f/3.5–5.6G VR and** **AF-P DX NIKKOR 18–55mm f/3.5–5.6G**

These retractable lenses are for use exclusively with DX format Nikon digital SLR cameras; SLR film cameras and D4-series, D3-series, D2-series, D1-series, D800-series, D700, D610, D600, D300-series, D200, D100, D90, D80, D70-series, D60, D50, D40-series, D7000, D5100, D5000, D3200, D3100, D3000 digital SLR cameras are not supported. The parts of the lens are listed below.

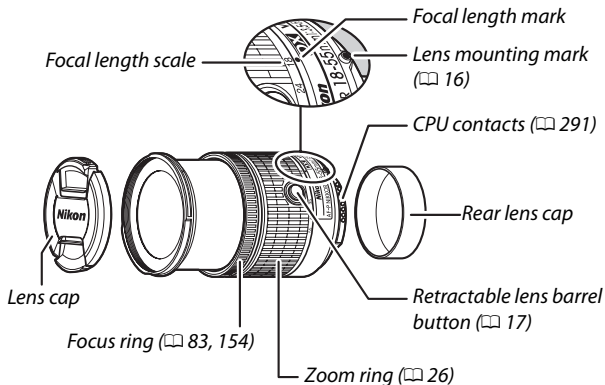

## ■ ■ Focus

The focus mode can be selected using camera controls (☞ 74).

### Autofocus

Focus is adjusted automatically when the camera is in autofocus mode (☞ 74). The focus ring can also be used to focus the camera if the shutter-release button is kept pressed halfway (or if the AF-ON button is kept pressed); this is known as “autofocus with manual override” (M/A). Autofocus will resume when the shutter-release button is pressed halfway (or the AF-ON button is pressed) a second time. Note that touching the focus ring while autofocus is in effect will change the focus position.

### Manual Focus

When the camera is in manual focus mode, focus can be adjusted by rotating the lens focus ring (☞ 83). When the camera is off or the standby timer has expired, the focus ring can not be used to focus and rotating the zoom ring will change the focus position; before focusing, turn the camera on or press the shutter-release button to reactivate the standby timer.

Users of D810-series, Df, D750, D7200, D7100, and D5200 cameras should note that if the standby timer is allowed to expire, the focus position will change when the timer is restarted. Refocus before shooting. Longer standby times are recommended for manual focus and in other situations in which you may not release the shutter immediately after focusing.

## ■ Using the Built-in Flash

When using the built-in flash, be sure the subject is at a range of at least 0.6 m (2 ft) and remove lens hoods to prevent vignetting (shadows created where the end of the lens obscures the built-in flash).

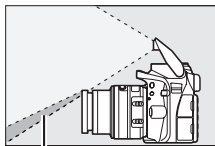

Shadow



Vignetting

Camera	Zoom position	Minimum distance without vignetting
D5500/D5300/D5200/D3300	18 mm	1.0 m/3 ft 4 in.
	24, 35, 45, and 55 mm	No vignetting

## ■ Vibration Reduction (VR, AF-P DX NIKKOR 18–55mm f/3.5–5.6G VR Only)

When an AF-P DX NIKKOR 18–55mm f/3.5–5.6G VR is mounted on the camera, vibration reduction can be enabled or disabled using the **Optical VR** option in the shooting menu (📖 230). If **On** is selected, vibration reduction will take effect whenever the shutter-release button is pressed halfway. Vibration reduction reduces blur caused by camera shake, allowing shutter speeds up to 4.0 stops slower than would otherwise be the case, increasing the range of shutter speeds available. The effects of VR on shutter speed are measured according to Camera and Imaging Products Association (CIPA) standards; FX-format lenses are measured using FX-format digital cameras, DX-format lenses using DX-format cameras. Zoom lenses are measured at maximum zoom.

### **Vibration Reduction**

- When using vibration reduction, press the shutter-release button halfway and wait for the image in the viewfinder to stabilize before pressing the shutter-release button the rest of the way down.
- When vibration reduction is active, the image in the viewfinder may jiggle after the shutter is released. This does not indicate a malfunction.
- When the camera is panned, vibration reduction applies only to motion that is not part of the pan (if the camera is panned horizontally, for example, vibration reduction will be applied only to vertical shake), making it much easier to pan the camera smoothly in a wide arc.
- If the camera is equipped with a built-in flash, vibration reduction will be disabled while the flash charges.
- Vibration reduction is generally recommended when the camera is mounted on a tripod, although you may prefer to turn it off depending on shooting conditions and the type of tripod.

## ■ Supplied Accessories

- 55 mm snap-on Front Lens Cap LC-55A
- Rear Lens Cap

## ■ Compatible Accessories

- 55 mm screw-on filters
- Rear Lens Cap LF-4
- Lens Case CL-0815
- Bayonet Hood HB-N106

Align the lens hood mounting mark (●) with the lens hood alignment mark (┌) as shown in Figure ① and then rotate the hood (②) until the ● mark is aligned with the lens hood lock mark (—○).

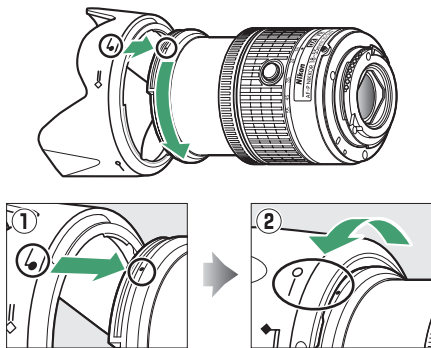

When attaching or removing the hood, hold it near the symbol on its base and avoid gripping it too tightly. Vignetting may occur if the hood is not correctly attached. The hood can be reversed and mounted on the lens when not in use.

## ■ Specifications

Type	Type G AF-P DX lens with built-in CPU and F mount
Focal length	18–55 mm
Maximum aperture	f/3.5–5.6
Lens construction	12 elements in 9 groups (2 aspherical lens elements)
Angle of view	76° – 28° 50′
Focal length scale	Graduated in millimeters (18, 24, 35, 45, 55)
Distance information	Output to camera
Zoom	Manual zoom using independent zoom ring
Focusing	Autofocus controlled by stepping motor; separate focus ring for manual focus
Vibration reduction (AF-P DX NIKKOR 18–55mm f/3.5–5.6G VR only)	Lens shift using voice coil motors (VCMs)
Minimum focus distance	0.25 m (0.9 ft) from focal plane (□ 84) at all zoom positions
Diaphragm blades	7 (rounded diaphragm opening)
Diaphragm	Fully automatic
Aperture range	<ul style="list-style-type: none"><li>• <b>18 mm focal length:</b> f/3.5–22</li><li>• <b>55 mm focal length:</b> f/5.6–38</li></ul> The minimum aperture displayed may vary depending on the size of the exposure increment selected with the camera.
Metering	Full aperture
Filter-attachment size	55 mm (P = 0.75 mm)
Dimensions	Approx. 64.5 mm maximum diameter × 62.5 mm (distance from camera lens mount flange)
Weight	<ul style="list-style-type: none"><li>• <b>AF-P DX NIKKOR 18–55mm f/3.5–5.6G VR:</b> Approx. 205 g (7.3 oz)</li><li>• <b>AF-P DX NIKKOR 18–55mm f/3.5–5.6G:</b> Approx. 195 g (6.9 oz)</li></ul>

## **AF-S DX NIKKOR 18–55mm f/3.5–5.6G VR II**

This retractable lens, for use exclusively with DX format Nikon digital SLR cameras, is the lens generally used in this manual for illustrative purposes. The parts of the lens are listed below.

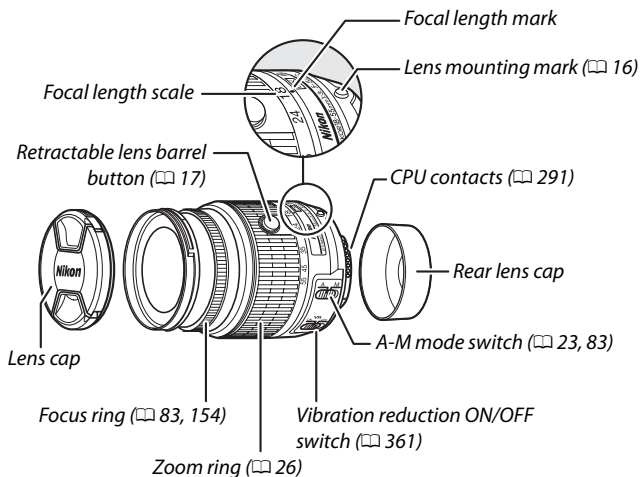

### **■ Focus**

Focus mode is determined by the camera focus mode and the position of the lens A-M mode switch ( 74, 83).



## ■ ■ Using the Built-in Flash

When using the built-in flash, be sure the subject is at a range of at least 0.6 m (2 ft) and remove lens hoods to prevent vignetting (shadows created where the end of the lens obscures the built-in flash).

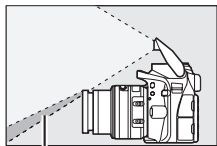

Shadow

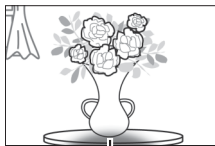

Vignetting

## ■ ■ Vibration Reduction (VR)

Vibration reduction can be enabled by sliding the vibration reduction switch to **ON** and takes effect whenever the shutter-release button is pressed halfway. Vibration reduction reduces blur caused by camera shake, allowing shutter speeds up to 4.0 stops slower than would otherwise be the case (as measured at 55 mm with a DX-format camera according to Camera and Imaging Products Association [CIPA] standards; effects vary with the photographer and shooting conditions). This increases the range of shutter speeds available.



### **Vibration Reduction**

- When using vibration reduction, press the shutter-release button halfway and wait for the image in the viewfinder to stabilize before pressing the shutter-release button the rest of the way down.
- When vibration reduction is active, the image in the viewfinder may jiggle after the shutter is released. This does not indicate a malfunction.
- When the camera is panned, vibration reduction applies only to motion that is not part of the pan (if the camera is panned horizontally, for example, vibration reduction will be applied only to vertical shake), making it much easier to pan the camera smoothly in a wide arc.
- Do not turn the camera off or remove the lens while vibration reduction is in effect.
- If the camera is equipped with a built-in flash, vibration reduction will be disabled while the flash charges.
- Select **OFF** when the camera is mounted on a tripod unless the tripod head is unsecured or the camera is mounted on a monopod, in which case **ON** is recommended.

## ■ ■ Supplied Accessories

- 52 mm snap-on Front Lens Cap LC-52
- Rear Lens Cap

## ■ ■ Compatible Accessories

- 52 mm screw-on filters
- Rear Lens Cap LF-4
- Flexible Lens Pouch CL-0815
- Bayonet Hood HB-69

Align the lens hood mounting mark (●) with the lens hood alignment mark (◡) as shown in Figure ① and then rotate the hood (②) until the ● mark is aligned with the lens hood lock mark (—○).

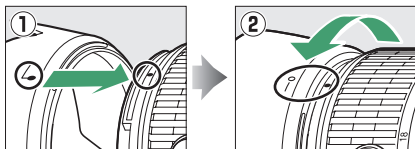
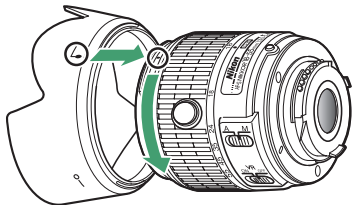

When attaching or removing the hood, hold it near the symbol on its base and avoid gripping it too tightly. Vignetting may occur if the hood is not correctly attached. The hood can be reversed and mounted on the lens when not in use.

## ■ Specifications

Type	Type G AF-S DX lens with built-in CPU and F mount
Focal length	18–55 mm
Maximum aperture	f/3.5–5.6
Lens construction	11 elements in 8 groups (including 1 aspherical lens element)
Angle of view	76°–28° 50′
Focal length scale	Graduated in millimeters (18, 24, 35, 45, 55)
Distance information	Output to camera
Zoom	Manual zoom using independent zoom ring
Focusing	Autofocus controlled by Silent Wave Motor and separate focus ring for manual focus
Vibration reduction	Lens shift using voice coil motors (VCMs)
Minimum focus distance	<ul style="list-style-type: none"><li>• <b>AF:</b> 0.28 m (0.92 ft) from focal plane (□ 84) at all zoom positions</li><li>• <b>MF:</b> 0.25 m (0.82 ft) from focal plane at all zoom positions</li></ul>
Diaphragm blades	7 (rounded diaphragm opening)
Diaphragm	Fully automatic
Aperture range	<ul style="list-style-type: none"><li>• <b>18 mm focal length:</b> f/3.5–22</li><li>• <b>55 mm focal length:</b> f/5.6–38</li></ul> The minimum aperture displayed may vary depending on the size of the exposure increment selected with the camera.
Metering	Full aperture
Filter-attachment size	52 mm (P=0.75 mm)
Dimensions	Approx. 66 mm diameter × 59.5 mm (distance from camera lens mount flange when lens is retracted)
Weight	Approx. 195 g (6.9 oz)

### Lens Care

- Keep the CPU contacts clean.
- Use a blower to remove dust and lint from the lens surfaces. To remove smudges and fingerprints, apply a small amount of ethanol or lens cleaner to a soft, clean cotton cloth or lens-cleaning tissue and clean from the center outwards using a circular motion, taking care not to leave smears or touch the glass with your fingers.
- Never use organic solvents such as paint thinner or benzene to clean the lens.
- The lens hood or NC filters can be used to protect the front lens element.
- Attach the front and rear caps before placing the lens in its flexible pouch.
- When a lens hood is attached, do not pick up or hold the lens or camera using only the hood.
- If the lens will not be used for an extended period, store it in a cool, dry location to prevent mold and rust. Do not store in direct sunlight or with naphtha or camphor moth balls.
- Keep the lens dry. Rusting of the internal mechanism can cause irreparable damage.
- Leaving the lens in extremely hot locations could damage or warp parts made from reinforced plastic.

### A Note on Wide- and Super Wide-Angle Lenses

Autofocus may not provide the desired results in situations like those shown below.

#### 1 Objects in the background occupy more of the focus point than the main subject:

If the focus point contains both foreground and background objects, the camera may focus on the background and the subject may be out of focus.

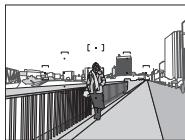

**Example:** *A far-off portrait subject at some distance from the background*

#### 2 The subject contains many fine details.

The camera may have difficulty focusing on subjects that lack contrast or appear smaller than objects in the background.

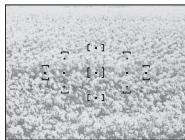

**Example:** *A field of flowers*

In these cases, use manual focus, or use focus lock to focus on another subject at the same distance and then recompose the photograph. For more information, see “Getting Good Results with Autofocus” (📖 76).

## Memory Card Capacity

The following table shows the approximate number of pictures that can be stored on a 16 GB SanDisk Extreme Pro SDHC UHS-I card at different image quality and size settings (figures for panoramas are not included).

Image quality	Image size	File size <sup>1</sup>	No. of images <sup>1</sup>	Buffer capacity <sup>2</sup>
NEF (RAW)+JPEG fine <sup>3</sup>	Large	31.5 MB	345	6
NEF (RAW)	—	19.5 MB	524	11
JPEG fine	Large	12.1 MB	1000	100
	Medium	7.4 MB	1700	100
	Small	3.8 MB	3300	100
JPEG normal	Large	6.3 MB	2000	100
	Medium	3.8 MB	3300	100
	Small	2.0 MB	6300	100
JPEG basic	Large	2.9 MB	3900	100
	Medium	1.9 MB	6500	100
	Small	1.0 MB	12,100	100

- 1 All figures are approximate. Results will vary with card type, camera settings, and scene recorded.
- 2 Maximum number of exposures that can be stored in memory buffer at ISO 100. Drops when noise reduction (☐ 226), auto distortion control (☐ 225), or **Print date** (☐ 254) is on.
- 3 Image size applies to JPEG images only. Size of NEF (RAW) images can not be changed. File size is the total for NEF (RAW) and JPEG images.

## Battery Life

The movie footage or number of shots that can be recorded with fully-charged batteries varies with the condition of the battery, temperature, the interval between shots, and the length of time menus are displayed. Sample figures for EN-EL14a (1230 mAh) batteries are given below.

- **Photographs, single-frame release mode (CIPA standard <sup>1</sup>):**  
Approximately 700 shots
  - **Photographs, continuous release mode (Nikon standard <sup>2</sup>):**  
Approximately 2500 shots
  - **Movies:** Approximately 55 minutes at 1080/60p and 1080/50p<sup>3</sup>
- 1 Measured at 23 °C/73.4 °F ( $\pm 2$  °C/3.6 °F) with an AF-S DX NIKKOR 18–55mm f/3.5–5.6G VR II lens under the following test conditions: lens cycled from infinity to minimum range and one photograph taken at default settings once every 30 s; after photograph is taken, monitor is turned on for 4 s; tester waits for standby timer to expire after monitor is turned off; flash fired at full power once every other shot. Live view not used.
  - 2 Measured at 20 °C/68 °F with an AF-S DX NIKKOR 18–55mm f/3.5–5.6G VR II lens under the following test conditions: vibration reduction off, continuous release mode, focus mode set to **AF-C**, image quality set to JPEG basic, image size set to **M** (medium), white balance set to **AUTO**, ISO sensitivity set to ISO 100, shutter speed  $\frac{1}{250}$  s, focus cycled from infinity to minimum range three times after shutter-release button has been pressed halfway for 3 s; six shots are then taken in succession and monitor turned on for 4 s and then turned off; cycle repeated once standby timer has expired.
  - 3 Measured at 23 °C/73.4 °F ( $\pm 2$  °C/3.6 °F) with the camera at default settings and an AF-S DX NIKKOR 18–55mm f/3.5–5.6G VR II lens under conditions specified by the Camera and Imaging Products Association (CIPA). Individual movies can be up to 20 minutes in length or 4 GB in size; recording may end before these limits are reached if the camera temperature rises.



The following can reduce battery life:

- Using the monitor
- Keeping the shutter-release button pressed halfway
- Repeated autofocus operations
- Taking NEF (RAW) photographs
- Slow shutter speeds
- Using a GP-1 or GP-1A GPS unit
- Using an Eye-Fi card
- Using a WU-1a wireless mobile adapter
- Using VR (vibration reduction) mode with VR lenses
- Repeatedly zooming in and out with an AF-P lens.

To ensure that you get the most from rechargeable Nikon EN-EL14a batteries:

- Keep the battery contacts clean. Soiled contacts can reduce battery performance.
- Use batteries immediately after charging. Batteries will lose their charge if left unused.

# Index

## Symbols

(Auto mode) .....	4, 25
(Auto (flash off) mode) .....	4, 25
(Portrait) .....	5, 47
(Landscape) .....	5, 47
(Child) .....	5, 48
(Sports) .....	5, 48
(Close up) .....	5, 48
(Night portrait) .....	5, 49
EFFECTS (Special effects) .....	5, 50
(Night vision) .....	5, 51
VI (Super vivid) .....	5, 51
POP (Pop) .....	5, 51
(Photo illustration) .....	5, 52, 56
(Color sketch) .....	5, 52, 57
(Toy camera effect) .....	5, 52, 58
(Miniature effect) .....	5, 53, 59
(Selective color) .....	5, 53, 61
(Silhouette) .....	5, 54
(High key) .....	5, 54
(Low key) .....	5, 54
(HDR painting) .....	5, 55
(Easy panorama) .....	5, 55, 63
P (Programmed auto) .....	4, 100, 102
S (Shutter-priority auto) .....	4, 100, 104
A (Aperture-priority auto) .....	4, 100, 106
M (Manual) .....	4, 100, 108
GUIDE (Guide) .....	41
(flexible program) .....	103
(Single frame) .....	67
(Continuous) .....	67, 68
(Self-timer) .....	67, 71
(Delayed remote (ML-L3)) .....	67, 97
(Quick-response remote (ML-L3)) ..	67, 97
(Quiet shutter release) .....	67, 70
(Single-point AF) .....	78

(Dynamic-area AF) .....	78
(Auto-area AF) .....	78
(3D-tracking) .....	78, 79
(Face-priority AF) .....	145, 147
(Wide-area AF) .....	145, 147
(Normal-area AF) .....	145, 147
(Subject-tracking AF) .....	145, 147
(Matrix metering) .....	114
(Center-weighted metering) ..	114
(Spot metering) .....	114
AUTO (auto flash) .....	90
(red-eye reduction) .....	90, 92
SLOW (slow sync) .....	90, 92
REAR (rear-curtain sync) .....	92
(Flash compensation) .....	120
(Exposure compensation) .....	118
WB (White balance) .....	124
PRE (Preset manual) .....	129
("Beep" indicator) .....	247
(focus indicator) .....	27, 81, 84
(flash-ready indicator) ...	6, 31, 304
(live view) .....	32, 37, 142, 155
(Lv) button .....	32, 37, 142, 155
i button .....	9, 151, 171
(Memory buffer) .....	69, 367

## Numerics

3D color matrix metering .....	291
3D-tracking (AF-area mode) ..	78, 79
420-pixel RGB sensor ..	230, 291, 344, 346

## A

A/V cable .....	215
AC adapter .....	306, 311
Access lamp .....	28
Accessories .....	306
Accessory terminal .....	258, 309

Accessory terminal accessories ..	309
Active D-Lighting .....	122
Adobe RGB .....	225
AE lock .....	116
AE-L .....	116
<b>AE-L/AF-L</b> button .....	81, 116, 252
AF .....	74–82, 144–147
AF-A .....	74
AF-area mode .....	78, 145
AF-assist illuminator .....	77, 228, 294
AF-C .....	74
AF-F .....	144
AF-S .....	74, 144
A-M mode switch .....	23, 83, 360
Angle of view .....	298
Aperture .....	101, 106, 109
Aperture-priority auto .....	106
Auto (White balance) .....	124
Auto distortion control .....	225
Auto flash .....	90
Auto image rotation .....	243
Auto info display .....	238
Auto ISO sensitivity control .....	227, 228
Auto off timers .....	245
Auto-area AF (AF-area mode) .....	78
Autoexposure lock .....	116
Autofocus .....	74–82, 144–147
Auto-servo AF .....	74
Available settings .....	326

## **B**

Battery .....	14, 306, 351
Beep .....	247
Black-and-white .....	269
Blue intensifier (Filter effects) .....	270
Body cap .....	2, 308
Border (PictBridge) .....	209
Built-in AF-assist illuminator .....	77, 228, 294
Built-in flash .....	89, 295
Bulb .....	110

Burst .....	68
Buttons .....	251

## **C**

Calendar playback .....	181
Capture NX 2 .....	307
CEC .....	218
Center-weighted metering .....	114
Charger .....	14, 306, 351
Choose start/end point .....	164
Clean image sensor .....	314
Clock .....	18, 242
Clock battery .....	24
Cloudy (White balance) .....	124
CLS .....	299, 300
Color balance .....	271
Color outline .....	281
Color sketch .....	57, 282
Color space .....	225
Color temperature .....	126
Compatible lenses .....	289
Continuous (Release mode) ....	67, 68
Continuous-servo AF .....	74
CPU contacts .....	291
CPU lens .....	289
Creative Lighting System ....	299, 300
Cropping (PictBridge) .....	209
Cross screen (Filter effects) .....	270
Cyanotype .....	269

## **D**

Date and time .....	18, 242
Date counter .....	254, 255
Date format .....	18, 242
Daylight saving time .....	18, 242
DCF version 2.0 .....	352
Delayed remote (ML-L3) .....	67, 97
Delete .....	192
Delete all images .....	193
Delete current image .....	192
Delete selected images .....	193

Device control (HDMI) .....	218
Digital Print Order Format .	211, 213, 352
Dioptr adjustment control .	20, 307
Direct sunlight (White balance) .	124
Distortion control .....	280
D-Lighting .....	266
DPOF .....	211, 213, 352
DPOF print order .....	213
Dynamic-area AF .....	78

## E

---

Easy panorama .....	63
Edit movie .....	164, 168
Electronic rangefinder .....	84, 248
Exif version 2.3 .....	352
Exposure .....	101, 114, 116, 118
Exposure compensation .....	118
Exposure indicator .....	109, 149
Exposure lock .....	116
Exposure meters .....	31
Exposure mode .....	100
External microphone .....	161, 309
Eye-Fi upload .....	261

## F

---

Face-priority AF .....	145
File information .....	172
File number sequence .....	249
Filter effects .....	139, 141, 270
Filters .....	306
Fine-tuning white balance .....	127
Firmware version .....	262
Fisheye .....	280
Flash .....	31, 89, 299
Flash (White balance) .....	124
Flash cntrl for built-in flash .....	229
Flash compensation .....	120
Flash control .....	230
Flash mode .....	90, 92
Flash range .....	94

Flash ready indicator .....	6, 31, 304
Flash sync speed .....	93, 344
Flexible program .....	103
Flicker reduction .....	157, 241
Fluorescent (White balance) .....	124, 126
<b>Fn</b> button .....	251, 258
f-number .....	101, 106
Focal length .....	298
Focal length scale .....	354, 360
Focal plane mark .....	84
Focus .....	74–84, 144–147, 154
Focus indicator .....	27, 81, 84
Focus lock .....	81
Focus mode .....	74, 144
Focus point .....	27, 78, 80, 84, 147
Focusing screen .....	343
Focusing the viewfinder .....	20
Focus-mode switch .....	23, 83
Format .....	234
Format memory card .....	22, 234
Frame interval (Slide show) .....	200
Frame size/frame rate .....	158
Framing grid .....	150
Front-curtain sync .....	92
Full-frame playback .....	170
Full-time-servo AF .....	144

## G

---

GPS unit .....	259, 309
Green intensifier (Filter effects) ..	270
Guide mode .....	41

## H

---

H.264 .....	348
HDMI .....	217, 352
HDMI-CEC .....	218
Help .....	11
Hi (Sensitivity) .....	95
High definition .....	217, 352
Highlights .....	173, 220

Histogram ..... 174, 220, 271

## I

---

Image comment ..... 244

Image Dust Off ref photo ..... 239

Image overlay ..... 272

Image quality ..... 85

Image review ..... 221

Image size ..... 87

Incandescent (White balance) .... 124

Info display format ..... 236

In-focus indicator ..... 27, 81, 84

Information display ..... 7, 236

Infrared receiver ..... 98

ISO sensitivity ..... 95, 226

i-TTL ..... 229, 230

i-TTL balanced fill-flash for digital  
SLR ..... 230

## J

---

JPEG ..... 85

JPEG basic ..... 85

JPEG fine ..... 85

JPEG normal ..... 85

## L

---

Landscape (Set Picture Control) 135

Language ..... 18, 243

Large (Image size) ..... 87

Lens ..... 16, 289

Lens focus ring ..... 83, 354, 360

Lens mount ..... 2, 84

Lens vibration reduction switch ..23,  
360, 361

Live view ..... 32, 37, 142, 155

Location data ..... 179, 259, 309

Lock mirror up for cleaning ..... 317

## M

---

Manual ..... 83, 108

Manual focus ..... 83, 144, 154

Manual movie settings ..... 159

Matrix metering ..... 114

Maximum aperture ..... 84, 343

Maximum sensitivity ..... 227

Medium (Image size) ..... 87

Memory buffer ..... 69

Memory card ..... 15, 234, 310, 367

Memory card capacity ..... 367

Metering ..... 114

Microphone ..... 158, 161

Miniature effect ..... 59, 283

Minimum shutter speed ..... 227

Mirror ..... 2, 317

Mode dial ..... 4

Monitor ..... 142, 170, 235

Monitor brightness ..... 235

Monochrome ..... 269

Monochrome (Set Picture Control) ..  
135

Mounting mark ..... 16, 354, 360

MOV ..... 250

Movie quality ..... 158

Movie settings ..... 158

Movie-record button ..... 38, 156

Movies ..... 37, 155

## N

---

NEF (RAW) ..... 85, 275

NEF (RAW) processing ..... 275

Neutral (Set Picture Control) ..... 135

Nikon Transfer 2 ..... 204

No. of copies (PictBridge) ..... 209

Noise reduction ..... 226

Non-CPU lens ..... 292

Normal-area AF ..... 145

Number of shots ..... 368

## O

---

Optional flash ..... 230, 299

Output resolution (HDMI) ..... 218

Overview data ..... 178

## **P**

---

Page size (PictBridge) ..... 209

Panoramas ..... 63, 66

Perspective control ..... 282

Photo illustration ..... 56, 281

Photo information ..... 172, 220

PictBridge ..... 208, 352

Picture Controls ..... 135, 137

Playback ..... 170

Playback display options ..... 220

Playback folder ..... 220

Playback information ..... 172, 220

Playback menu ..... 219

Playback zoom ..... 182

Portrait (Set Picture Control) ..... 135

Power connector ..... 306, 311

Power switch ..... 17

Preset manual (White balance) . 124,  
129

Press the shutter-release button all  
the way down ..... 28

Press the shutter-release button  
halfway ..... 27, 28

Print (DPOF) ..... 211, 214

Print date ..... 254

Print select ..... 211

Printing ..... 208

Programmed auto ..... 102

Protecting photographs ..... 184

## **Q**

---

Quick retouch ..... 279

Quick-response remote (ML-L3) ..67,  
97

Quiet shutter release .....67, 70

## **R**

---

Rangefinder ..... 84, 248

Rating ..... 186, 200

Rear-curtain sync ..... 92

Recent settings .....288

Red intensifier (Filter effects) ..... 270

Red-eye correction ..... 267

Red-eye reduction ..... 90, 92

Release mode ..... 67

Remote control ..... 97, 258, 308

Remote cord ..... 110, 258, 309

Remote on duration (ML-L3) ..... 247

Remote shutter release ..... 258

Reset ..... 224, 233

Reset setup options ..... 233

Reset shooting menu ..... 224

Resize ..... 277

Retouch menu ..... 263

Retractable lens barrel button .... 17,  
24, 26, 354, 360

RGB ..... 174, 225

RGB histogram ..... 174

Rotate tall ..... 221

## **S**

---

Save selected frame ..... 168

Scene auto selector ..... 34

Scene mode ..... 47

Select to send to smart device .... 189

Selective color ..... 61, 284

Self-timer ..... 67, 71, 246

Sensitivity ..... 95, 226

Sepia ..... 269

Set clock from satellite ..... 259

Set Picture Control ..... 137

Setup menu ..... 231

Shade (White balance) ..... 124

Shooting data ..... 176

Shooting menu ..... 222

Shutter-priority auto ..... 104

Shutter-release button ... 28, 81, 116,  
252

Side-by-side comparison ..... 286

Single frame (Release mode) ..... 67

Single-point AF (AF-area mode) ...	78
Single-servo AF .....	74, 144
Size .....	87, 158
Skylight (Filter effects) .....	270
Slide show .....	198
Slot empty release lock .....	253
Slow sync .....	90, 92
Small (Image size) .....	87
Soft (Filter effects) .....	270
Special effects mode .....	50
Speedlight .....	299
Spot metering .....	114
sRGB .....	225
Standard (Set Picture Control) ....	135
Standard i-TTL fill-flash for digital SLR .....	230
Standby timer .....	31, 245, 259
Start printing (PictBridge) ...	210, 212
Storage folder .....	257
Straighten .....	279
Subject-tracking AF .....	145

## T

Television .....	215
Thumbnail playback .....	180
Time .....	110
Time stamp (PictBridge) .....	209
Time zone .....	18, 242
Time zone and date .....	242
Timer .....	71
Toning .....	139, 141
Transition effects .....	200, 220
Trim .....	268
Trimming movies .....	164
Type D lens .....	291
Type E lens .....	291
Type G lens .....	291

## U

USB cable .....	204, 208, 309
UTC .....	179, 259

## V

Vibration reduction .....	23, 356, 361
Video mode .....	216, 260
Viewfinder .....	6, 20, 343
Viewfinder eyepiece cap .....	73
ViewNX 2 .....	201, 204
Vivid (Set Picture Control) .....	135
Volume .....	163, 199

## W

Warm filter (Filter effects) .....	270
WB .....	124
White balance .....	124
Wide-area AF .....	145
Wind noise reduction .....	159
Wireless mobile adapter ....	260, 309
Wireless remote controller ...	99, 258, 309

No reproduction in any form of this manual, in whole or in part (except for brief quotation in critical articles or reviews), may be made without written authorization from NIKON CORPORATION.