

Nikon

En

The Nikon Guide to Digital Photography
with the

D200

DIGITAL CAMERA



CE

About This Manual

The topics in this manual are arranged in order from easy to advanced.

These chapters cover all you need to know for simple, “point-and-shoot” photography

Read these chapters for a complete description of all aspects of camera operation

Introduction (page 1)

Learn the names of camera parts and ready the camera for use.

Tutorial: Photography and Playback (page 17)

The basic operations involved in taking photographs and playing them back.

Reference: More on Photography (page 26)

Play with exposure and explore the creative possibilities of some of the camera’s more advanced settings.

Reference: More on Playback (page 98)

Learn more about camera playback, transferring photographs to a computer, and printing photographs.

Setup: Basic Camera Settings (page 115)

Basic camera setup, including formatting memory cards and setting the camera clock.

Setup: Shooting, Playback, and Custom Settings (page 124)

Read this chapter for more information on Custom Settings and on shooting and playback options.

Technical Notes (page 173)

Read this chapter for information on camera specifications, accessories, and troubleshooting.

Trademark Information

Macintosh, Mac OS, and QuickTime are registered trademarks of Apple Computer, Inc. Microsoft and Windows are registered trademarks of Microsoft Corporation. CompactFlash is a trademark of SanDisk Corporation. Lexar Media is a trademark of Lexar Media Corporation. Microdrive is a trademark of Hitachi Global Storage Technologies in the United States and other countries. Adobe and Acrobat are registered trademarks of Adobe Systems Inc. PictBridge is a trademark. All other trade names mentioned in this manual or the other documentation provided with your Nikon product are trademarks or registered trademarks of their respective holders.

Introduction



Tutorial

Photography and Playback



Reference

More on Photography



More on Playback



Setup

**Basic Camera Settings:
The Setup Menu**



**Shooting Options:
The Shooting Menu**



**Playback Options:
The Playback Menu**



**Custom Settings:
The Custom Settings Menu**



Technical Notes



For Your Safety

To prevent damage to your Nikon product or injury to yourself or to others, read the following safety precautions in their entirety before using this equipment. Keep these safety instructions where all those who use the product will read them.

The consequences that could result from failure to observe the precautions listed in this section are indicated by the following symbol:



This icon marks warnings, information that should be read before using this Nikon product to prevent possible injury.

WARNINGS



Do not look at the sun through the viewfinder

Viewing the sun or other strong light source through the viewfinder could cause permanent visual impairment.



Turn off immediately in the event of malfunction

Should you notice smoke or an unusual smell coming from the equipment or from the AC adapter (available separately), unplug the AC adapter and remove the battery immediately, taking care to avoid burns. Continued operation could result in injury. After removing the battery, take the equipment to a Nikon-authorized service center for inspection.



Do not use in the presence of flammable gas

Do not use electronic equipment in the presence of flammable gas, as this could result in explosion or fire.



Do not place strap around the neck of an infant or child

Placing the camera strap around the neck of an infant or child could result in strangulation.



Do not disassemble

Touching the product's internal parts could result in injury. In the event of a malfunction, the product should be repaired only by a qualified technician. Should the product break open as the result of a fall or other accident, remove the battery and/or AC adapter and then take the product to a Nikon-authorized service center for inspection.



Observe proper precautions when handling batteries

Batteries may leak or explode if improperly handled. Observe the following precautions when handling batteries for use in this product:

- Be sure the product is off before replacing the battery. If you are using an AC adapter, be sure it is unplugged.
- Use only batteries approved for use in this equipment. Do not mix old and new batteries or batteries of different types.
- Do not attempt to insert the battery upside down or backwards.
- Do not short or disassemble the battery.
- Do not expose the battery to flame or to excessive heat.
- Do not immerse in or expose to water.
- Replace the terminal cover when transporting the battery. Do not transport or store with metal objects such as necklaces or hairpins.

-
- Batteries are prone to leakage when fully discharged. To avoid damage to the product, be sure to remove the battery when no charge remains.
 - When the battery is not in use, attach the terminal cover and store in a cool place.
 - Immediately after use, or when the product is used on battery power for an extended period, the battery may become hot. Before removing the battery, turn the camera off and allow the battery to cool.
 - Discontinue use immediately should you notice any changes in the battery, such as discoloration or deformation.

**Use appropriate cables**

When connecting cables to the input and output jacks, use only the cables provided or sold by Nikon for the purpose, to maintain compliance with product regulations.

**Keep out of reach of children**

Failure to observe this precaution could result in injury.

**CD-ROMs**

The CD-ROMs on which the software and manuals are distributed should not be played back on audio CD equipment. Playing CD-ROMs on an audio CD player could cause hearing loss or damage the equipment.

**Observe caution when using the flash**

- Do not operate the flash with the flash window touching a person or object. Failure to observe this precaution could result in burns or fire.
- Using the flash close to your subject's eyes could cause temporary visual impairment. Particular care should be observed if photographing infants, when the flash should be no less than one meter (39") from the subject.

**When using the viewfinder**

When operating the diopter adjustment control with your eye to the viewfinder, care should be taken not to put your finger in your eye accidentally.

**Avoid contact with liquid crystal**

Should the monitor break, care should be taken to avoid injury due to broken glass and to prevent liquid crystal from the monitor touching the skin or entering the eyes or mouth.

Notices

- No part of the manuals included with this product may be reproduced, transmitted, transcribed, stored in a retrieval system, or translated into any language in any form, by any means, without Nikon's prior written permission.
- Nikon reserves the right to change the specifications of the hardware and software described in these manuals at any time and without prior notice.
- Nikon will not be held liable for any damages resulting from the use of this product.
- While every effort has been made to ensure that the information in these manuals is accurate and complete, we would appreciate it were you to bring any errors or omissions to the attention of the Nikon representative in your area (address provided separately).

Notices for Customers in the U.S.A.

Federal Communications Commission (FCC) Radio Frequency Interference Statement

This equipment has been tested and found to comply with the limits for a Class B digital device, pursuant to Part 15 of the FCC rules. These limits are designed to provide reasonable protection against harmful interference in a residential installation. This equipment generates, uses, and can radiate radio frequency energy and, if not installed and used in accordance with the instructions, may cause harmful interference to radio communications. However, there is no guarantee that interference will not occur in a particular installation. If this equipment does cause harmful interference to radio or television reception, which can be determined by turning the equipment off and on, the user is encouraged to try to correct the interference by one or more of the following measures:

- Reorient or relocate the receiving antenna.
- Increase the separation between the equipment and receiver.
- Connect the equipment into an outlet on a circuit different from that to which the receiver is connected.
- Consult the dealer or an experienced radio/television technician for help.

Notice for Customers in Canada

CAUTION

This class B digital apparatus meets all requirements of the Canadian Interference Causing Equipment Regulations.



CAUTIONS

Modifications

The FCC requires the user to be notified that any changes or modifications made to this device that are not expressly approved by Nikon Corporation may void the user's authority to operate the equipment.

Interface Cables

Use the interface cables sold or provided by Nikon for your equipment. Using other interface cables may exceed the limits of Class B Part 15 of the FCC rules.

Notice for Customers in the State of California

WARNING: Handling the cord on this product will expose you to lead, a chemical known to the State of California to cause birth defects or other reproductive harm. *Wash hands after handling.*

Nikon Inc.,
1300 Walt Whitman Road, Melville, New York
11747-3064, U.S.A. Tel.: 631-547-4200

ATTENTION

Cet appareil numérique de la classe B respecte toutes les exigences du Règlement sur le matériel brouilleur du Canada.

Symbol for Separate Collection in European Countries

This symbol indicates that this product is to be collected separately.



The following apply only to users in European countries:

- This product is designated for separate collection at an appropriate collection point. Do not dispose of as household waste.
- For more information, contact the retailer or the local authorities in charge of waste management.

Notice Concerning Prohibition of Copying or Reproduction

Note that simply being in possession of material that has been digitally copied or reproduced by means of a scanner, digital camera or other device may be punishable by law.

• Items prohibited by law from being copied or reproduced

Do not copy or reproduce paper money, coins, securities, government bonds, or local government bonds, even if such copies or reproductions are stamped "Sample."

The copying or reproduction of paper money, coins, or securities which are circulated in a foreign country is prohibited.

Unless the prior permission of the government has been obtained, the copying or reproduction of unused postage stamps or post cards issued by the government is prohibited.

The copying or reproduction of stamps issued by the government and of certified documents stipulated by law is prohibited.

• Cautions on certain copies and reproductions

The government has issued cautions on copies or reproductions of securities issued by private companies (shares, bills, checks, gift certificates, etc.), commuter passes, or coupon tickets, except when a minimum of necessary copies are to be provided for business use by a company. Also, do not copy or reproduce passports issued by the government, licenses issued by public agencies and private groups, ID cards, and tickets, such as passes and meal coupons.

• Comply with copyright notices

The copying or reproduction of copyrighted creative works such as books, music, paintings, woodcut prints, maps, drawings, movies, and photographs is governed by national and international copyright laws. Do not use this product for the purpose of making illegal copies or to infringe copyright laws.

Disposing of Data Storage Devices

Please note that deleting images or formatting memory cards or other data storage devices does not completely erase the original image data. Deleted files can sometimes be recovered from discarded storage devices using commercially available software, potentially resulting in the malicious use of personal image data. Ensuring the privacy of such data is the user's responsibility.

Before discarding a data storage device or transferring ownership to another person, erase all data using commercial deletion software, or format the device and then completely refill it with images containing no private information (for example, pictures of empty sky). Be sure to also replace any pictures selected for preset white balance. Care should be taken to avoid injury or damage to property when physically destroying data storage devices.

Table of Contents

For Your Safety	ii
Notices	iv
Introduction	1
Getting to Know the Camera	2
First Steps	8
Attaching a Lens	8
Inserting Memory Cards	14
Charging and Inserting the Battery	10
Adjusting Viewfinder Focus	16
Basic Setup	12
Tutorial: Photography and Playback	17
Basic Photography	17
Basic Playback	22
Reference	23
Using Camera Menus	24
Reference: More on Photography	26
Choosing a Shooting Mode	26
Image Quality and Size	28
Image Quality	28
Image Size	32
ISO Sensitivity	33
White Balance	35
Optimizing Images	45
Color Space	50
Focus	51
Focus Mode	51
Focus Lock	56
Focus Area Selection	53
The AF-Assist Illuminator	58
AF-Area Mode	54
Getting Good Results with Autofocus	59
Focus Zone Selection	55
Manual Focus	60
Exposure	61
Metering	61
Exposure Compensation	72
Exposure Mode	62
Exposure and Flash Bracketing	73
Autoexposure Lock	70
Flash Photography	76
Flash Sync Modes	77
Flash Exposure Compensation	80
Using the Built-in Flash	78
FV Lock	81
Self-Timer Mode	83
Image Overlay and Multiple Exposure	84
Interval Timer Photography	89
Non-CPU Lenses	93
Using a GPS Unit	96
Two-Button Reset	97

Reference: More on Playback	98
Viewing Photographs.....	98
Single-Image Playback.....	98
Photo Information	99
Viewing Multiple Images:	
Thumbnail Playback	102
Taking a Closer Look: Playback Zoom..	103
Protecting Photographs	
from Deletion.....	104
Deleting Individual Photographs	105
Viewing Photographs on TV	106
Connecting to a Computer	107
Printing Photographs.....	110
Setup	115
Basic Camera Settings: The Setup Menu	115
Format	116
LCD Brightness	116
Mirror Lock-Up	117
Video Mode.....	117
World Time	117
Language	118
Image Comment	118
Auto Image Rotation.....	119
Recent Settings.....	119
USB	121
Dust Off Ref Photo.....	121
Battery Info	123
Firmware Version	123
Shooting Options: The Shooting Menu.....	124
Shooting Menu Bank	125
Menu Reset	127
Folders.....	128
File Naming	129
Optimize Image.....	129
Color Space	129
Image Quality	129
Image Size.....	130
JPEG Compression.....	130
Raw Compression	130
White Balance	130
Long Exp. NR	131
High ISO NR	131
ISO Sensitivity	132
Image Overlay	132
Multiple Exposure	132
Interval Timer Shooting.....	132
Non-CPU Lens Data	132
Playback Options: The Playback Menu	133
Delete	133
Playback Folder.....	135
Slide Show	135
Hide Image.....	137
Print Set	139
Display Mode	141
Image Review	141
After Delete	142
Rotate Tall	142
Custom Settings.....	143
Technical Notes.....	173
Optional Accessories.....	173
Caring for the Camera.....	184
Troubleshooting	189
Appendix	195
Specifications	203
Index.....	208

Take Test Shots

Before taking pictures on important occasions (for example, at weddings or before taking the camera with you on a trip), take a test shot to ensure that the camera is functioning normally. Nikon will not be held liable for damages or lost profits that may result from product malfunction.

Life-Long Learning

As part of Nikon's "Life-Long Learning" commitment to ongoing product support and education, continually-updated information is available on-line at the following sites:

- For users in the U.S.A.: <http://www.nikonusa.com/>
- For users in Europe and Africa: <http://www.europe-nikon.com/support>
- For users in Asia, Oceania, and the Middle East: <http://www.nikon-asia.com/>

Visit these sites to keep up-to-date with the latest product information, tips, answers to frequently-asked questions (FAQs), and general advice on digital imaging and photography. Additional information may be available from the Nikon representative in your area. See the URL below for contact information:







<http://nikonimaging.com/>

Introduction

Thank you for your purchase of a Nikon D200 single-lens reflex (SLR) digital camera with interchangeable lenses. This manual has been written to help you enjoy taking pictures with your Nikon digital camera. Read this manual thoroughly before use, and keep it handy when using the product. The documentation for this product also includes the manuals listed below. Please be sure to read all instructions thoroughly to get the most from the camera.

- **Quick Start Guide:** The *Quick Start Guide* takes you through the process of unpacking and setting up your Nikon digital camera, taking your first photographs, and transferring them to your computer.
- **Software manual (on CD):** The software manual contains information on using the software provided with your camera. For information on viewing the software manual, see the *Quick Start Guide*.

To make it easier to find the information you need, the following symbols and conventions are used:

 This icon marks cautions, information that should be read before use to prevent damage to the camera.	 This icon marks tips, additional information that may be helpful when using the camera.
 This icon marks notes, information that should be read before using the camera.	 This icon indicates that more information is available elsewhere in this manual or in the <i>Quick Start Guide</i> .
 This icon marks settings that can be adjusted using camera menus.	 This icon marks settings that can be fine-tuned from the Custom Settings menu.

Lens

An AF-S DX 18–70 mm f/3.5–4.5G ED lens is used in this manual for illustrative purposes. The parts of the lens are shown below.

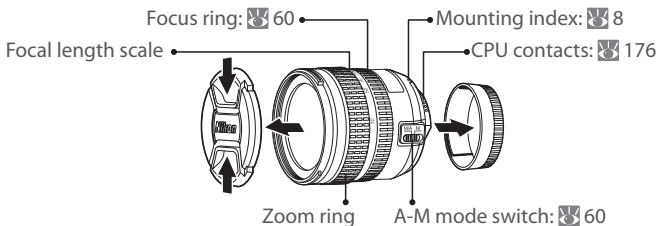

Getting to Know the Camera

Take a few moments to familiarize yourself with camera controls and displays. You may find it helpful to bookmark this section and refer to it as you read through the rest of the manual.

Camera Body

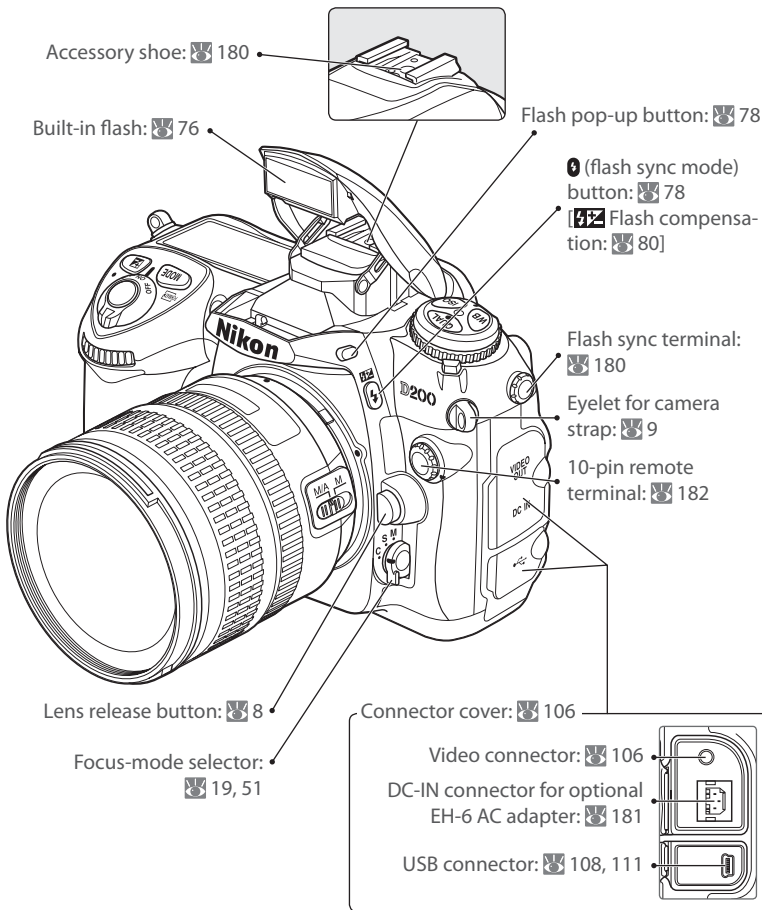

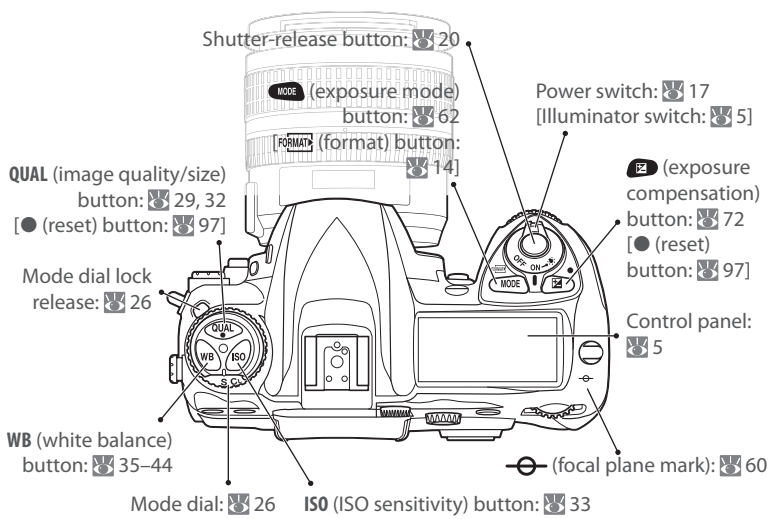
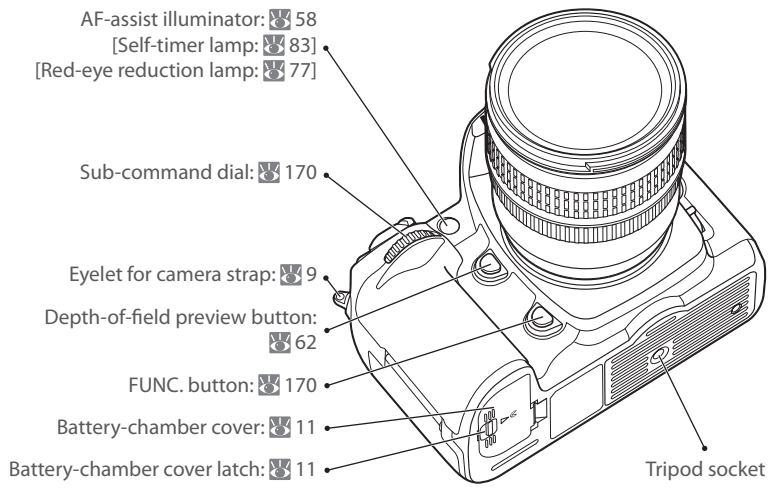

Camera Body (continued)

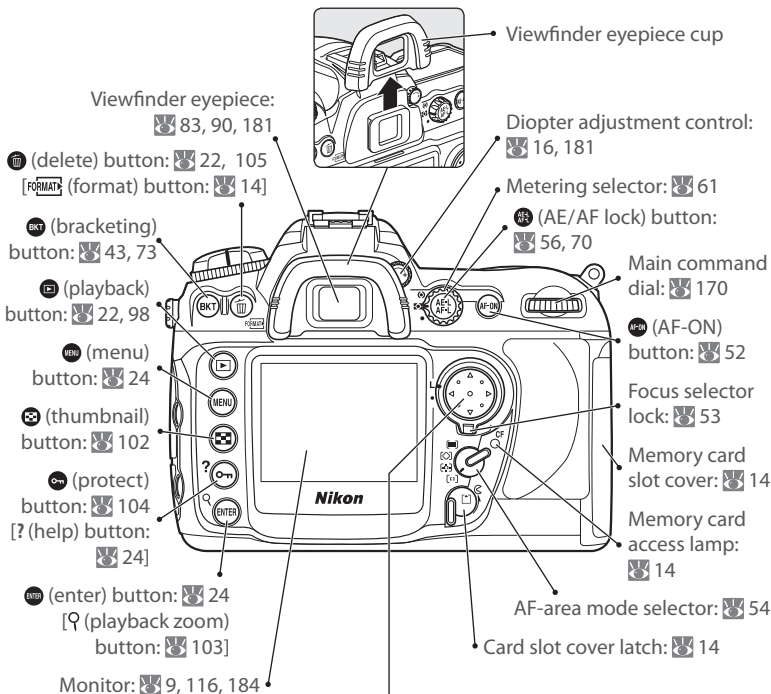

Multi selector

The multi selector is used for menu navigation and to control the display of photo information during playback.

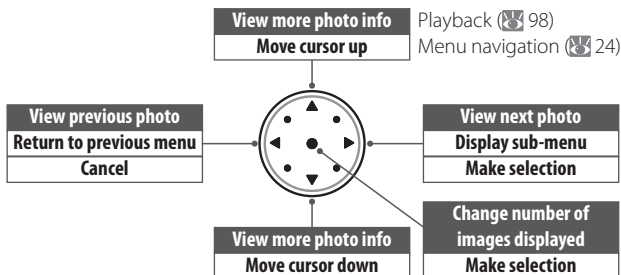

Control Panel

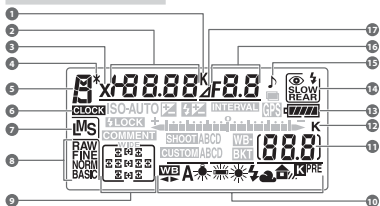

1	Color temperature indicator	38
2	Shutter speed	62–69
	Exposure compensation value	72
	Flash compensation value	80
	ISO sensitivity	33
	White balance fine-tuning, color temperature, or preset number	37–42
	Number of shots in bracketing sequence	73
	Number of intervals	91
	Focal length (non-CPU lens)	94
3	Flash sync indicator	79
4	Flexible program indicator	63
5	Exposure mode	62
6	“Clock not set” indicator	117
7	Image size	32

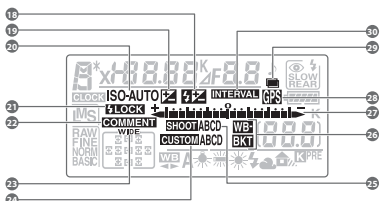

18	Flash compensation indicator	80
19	Exposure compensation indicator	72
20	ISO sensitivity indicator	33
21	Flash value (FV) lock	81

8	Image quality	28
9	Focus area	53
	AF-area mode	54
10	White balance mode	35
11	Number of exposures remaining	17
	Number of shots remaining before memory buffer fills	27
	PC mode indicator	108
	Preset white balance recording indicator	40
12	“K” (appears when memory remains for over 1000 exposures)	7
13	Battery indicator	17
14	Flash sync mode	77
15	“Beep” indicator	158
16	Aperture (f/-number)	62–69
	Aperture (number of stops)	67, 69
	Bracketing increment	43, 73
	Number of shots per interval	91
	Maximum aperture (non-CPU lens)	95
	PC connection indicator	108
17	Aperture stop indicator	67, 69
22	Image comment indicator	118
23	Wide-frame focus area indicator	56
24	Custom menu bank	146
25	Shooting menu bank	125
26	Bracketing indicator	43, 73
27	Electronic analog exposure display	69
	Exposure compensation	72
	Bracketing progress indicator	43, 73
	PC connection indicator	108
28	GPS connection indicator	96
29	Multiple exposure indicator	87
30	Interval timer indicator	91

The LCD Illuminator

Holding the power switch in the  position activates the exposure meters and the control panel backlight (LCD illuminator), allowing the display to be read in the dark. After the power switch is released, the illuminator will remain active while the camera exposure meters are active or until the shutter is released.

The Viewfinder Display

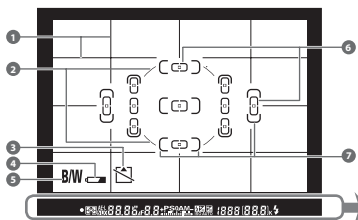

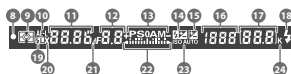

When the battery is totally exhausted, the display in the viewfinder will dim. The viewfinder display will return to normal when a fully-charged battery is inserted.



1 Framing grid (displayed when On is selected for Custom Setting d2 (Grid Display)).....	158	14 Flash compensation indicator.....	80
2 8-mm (0.31-in.) reference circle for center-weighted metering.....	61	15 Exposure compensation indicator.....	72
3 "No memory card" warning *.....	7	16 ISO sensitivity.....	33
4 Battery indicator *.....	17	17 Number of exposures remaining.....	17
5 Black-and-white indicator *.....	45	Number of shots remaining	
6 Normal-frame focus brackets (focus areas).....	53, 55	before memory buffer fills.....	27
7 Wide-frame focus brackets (focus areas).....	55	Preset white balance recording indicator.....	40
8 Focus indicator.....	20	Exposure compensation value.....	72
9 Metering.....	61	Flash compensation value.....	80
10 Autoexposure (AE) lock.....	70	PC connection indicator.....	108
11 Shutter speed.....	62–69	18 Flash-ready indicator.....	79
12 Aperture (f/-number).....	62–69	19 Flash value (FV) lock.....	81
Aperture (number of stops).....	67, 69	20 Flash sync indicator.....	79
13 Exposure mode.....	62	21 Aperture stop indicator.....	67, 69
		22 Electronic analog exposure display.....	69
		Exposure compensation.....	72
		23 Auto sensitivity indicator.....	153
		24 "K" (appears when memory remains for over 1000 exposures).....	7

* Can be hidden with Custom Setting d3  158).

Advanced Focusing Screen Display

When the background is bright, the active focus area ( 53) is highlighted in black. When the background is dark, the active focus area is highlighted briefly in red as needed to establish contrast with the background (“Vari-Brite” focus areas), making it easier to identify the selected focus area. The viewfinder is also equipped with on-demand grid lines. When **On** is selected for Custom Setting d2 (**Grid display**;  158), a reference grid is superimposed over the display in the viewfinder. This grid is a useful aid when composing landscape shots or when tilting or shifting a PC Nikkor lens.

Owing to the characteristics of this type of viewfinder display, you may notice fine lines radiating outwards from the selected focus area, or that the display in the viewfinder turns red when the selected focus area is highlighted. These phenomena are normal and do not indicate a malfunction.

The Viewfinder Display

The focus-area and grid-line displays in the viewfinder (advanced focusing screen display) tend to brighten at high temperatures and to darken and exhibit slower response times at low temperatures. The other displays in the viewfinder tend to darken at high temperatures and exhibit slower response times at low temperatures. All displays will return to normal at room temperature.

Large-Capacity Memory Cards

When enough memory remains on the memory card to record a thousand or more pictures at current settings, the number of exposures remaining will be shown in thousands, rounded down to the nearest hundred (e.g., if there is room for approximately 1,260 exposures, the exposure count display will show 1.2K).

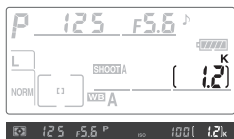

Camera Off Display/No Memory Card

If the camera is turned off with a battery and memory card inserted, the number of exposures remaining will be displayed in the control panel. If no memory card is inserted, the control panel will show (-E-) and a  icon will be displayed in the viewfinder.



First Steps

Attaching a Lens

Care should be taken to prevent dust from entering the camera when the lens is removed.

- 1 After confirming that the camera is off, remove the rear lens cap and camera body cap.

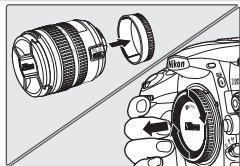

- 2 Keeping the mounting index on the lens aligned with the mounting index on the camera body, position the lens in the camera's bayonet mount. Being careful not to press the lens-release button, rotate the lens counter-clockwise until it clicks into place.

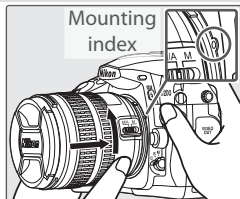

Detaching Lenses

Be sure the camera is off when removing or exchanging lenses. To remove the lens, press and hold the lens-release button while turning the lens clockwise.

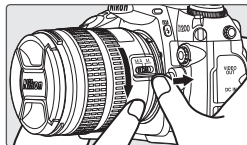

Aperture Ring

If the lens is equipped with an aperture ring, lock aperture at the minimum setting (highest f/-number). See the lens manual for details.

Attaching the Camera Strap

Attach the strap as shown below.

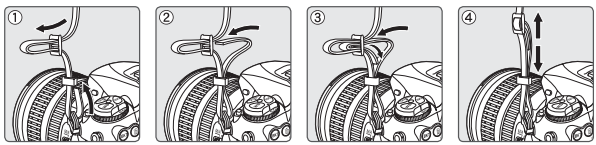

The Monitor Cover

A clear plastic cover (the BM-6 LCD monitor cover) is provided with the camera to keep the monitor clean and protect it when the camera is not in use. To attach the cover, insert the projection on the top of the cover into the matching indentation above the camera monitor (1), then press the bottom of the cover until it clicks into place (2).

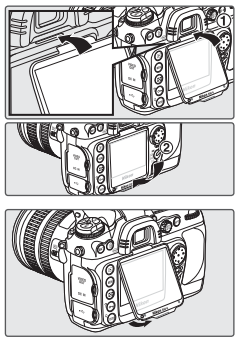

To remove the cover, hold the camera firmly and pull the bottom of the cover gently outwards as shown at right.

Charging and Inserting the Battery

The supplied EN-EL3e battery is not charged at shipment. Charge the battery using the supplied MH-18a quick charger as described below.

1 Charge the battery

- 1.1** Connect the power cord to the charger and plug it in.

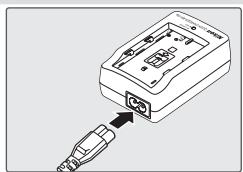

- 1.2** Place the battery in the charger. The CHARGE lamp will blink as the battery charges. About two and a quarter hours are required for an exhausted battery to fully charge.

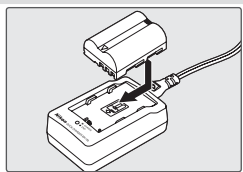

- 1.3** Charging is complete when the CHARGE lamp stops blinking. Remove the battery from the charger and unplug the charger.

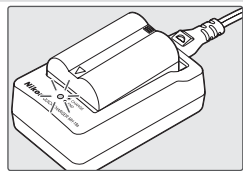

✓ The Battery and Charger

Read and follow the warnings and cautions on pages ii–iii and 187–188 of this manual, together with any warnings and instructions provided by the battery manufacturer. Use only EN-EL3e batteries. The D200 is not compatible with the EN-EL3 or EN-EL3a batteries available for D100, D70-series, or D50 cameras or with the MS-D70 CR2 battery holder.

Do not use the battery at ambient temperatures below 0°C (32°F) or above 40°C (104°F). During charging, the temperature should be in the vicinity of 5–35°C (41–95°F). For best performance, charge at temperatures of about 20°C (68°F) or higher. Note that the battery may become hot during use; wait for the battery to cool before charging. Failure to observe these precautions could damage the battery, impair its performance, or prevent it from charging normally.

Battery capacity drops at low temperatures. This is reflected in the battery level display; at low temperatures, a freshly-charged battery may appear to be partially discharged. At temperatures below about 5°C (41°F), the charging life shown in the **Battery info** display may be temporarily reduced. The displays will return to normal at about 20°C (68°F) or higher.

2 Insert the battery

- 2.1** After confirming that the camera is off, open the battery chamber cover.

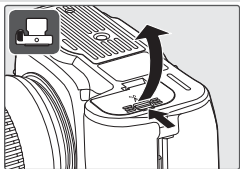

- 2.2** Insert a fully charged battery as shown at right. Close the battery chamber cover.

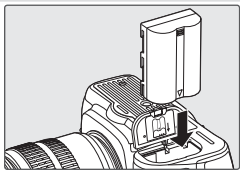

EN-EL3e Rechargeable Li-ion Batteries

The EN-EL3e shares information with compatible devices, enabling the battery charge state to be shown in six levels in the control panel and as a percentage in the setup menu **Battery Info** display (123), together with battery life and the number of pictures taken since the battery was last charged.

✔ Use Only Nikon Brand Electronic Accessories

Nikon cameras are designed to the highest standards and include complex electronic circuitry. Only Nikon brand electronic accessories (including lenses, Speedlights, battery chargers, batteries, and AC adapters) certified by Nikon specifically for use with this Nikon digital camera are engineered and proven to operate within the operational and safety requirements of this electronic circuitry.

THE USE OF NON-NIKON ELECTRONIC ACCESSORIES COULD DAMAGE THE CAMERA AND MAY VOID YOUR NIKON WARRANTY. The use of third-party rechargeable Li-ion batteries not bearing the Nikon holographic seal (see right) could interfere with normal operation of the camera or result in the batteries overheating, igniting, rupturing, or leaking.



For more information about Nikon brand accessories, contact an authorized Nikon dealer.

✍ Removing the Battery

Turn the camera off before removing the battery. Replace the terminal cover when the battery is not in use.

Basic Setup

The language option in the setup menu is automatically highlighted the first time menus are displayed. Choose a language and set the time and date.



Turn camera on and press **MENU** button.



Display language menu.



Select language.

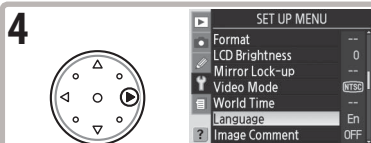

Return to setup menu.

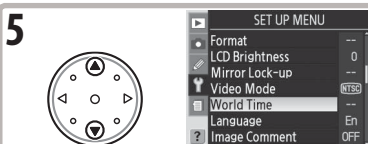

Highlight **World Time**.

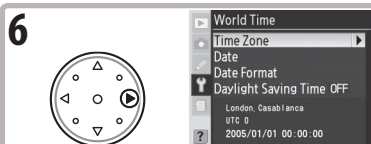

Display options.

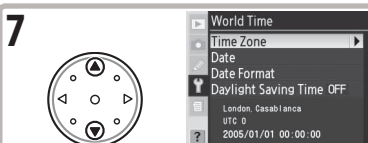

Highlight **Time Zone**.

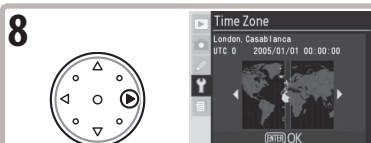

Display map of world time zones.

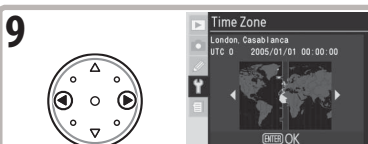

Select local time zone.*

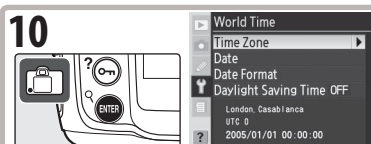

Return to **WORLD TIME** menu.

* **UTC** field shows time difference between selected time zone and Coordinated Universal Time (UTC), in hours.

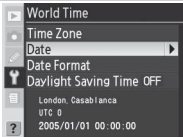

11

World Time
Time Zone
Date
Date Format
Daylight Saving Time OFF
London, Casablanca
UTC 0
2005/01/01 00:00:00

Highlight **Date**.†

12

World Time
Date
Y M D
2005 01 01
H M S
00 : 00 : 00
Set OK

Display **DATE** menu.

† If daylight saving time is in effect in local time zone, highlight **Daylight Saving Time** and press multi selector right. Press multi selector down to highlight **On** and press multi selector right. Time will automatically be advanced one hour.

13



World Time
Date
Y M D
2005 01 01
H M S
00 : 00 : 00
Set OK

Press multi selector left or right to select item, up or down to change.

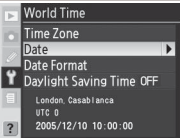

14

World Time
Time Zone
Date
Date Format
Daylight Saving Time OFF
London, Casablanca
UTC 0
2005/12/10 10:00:00

Return to **WORLD TIME** menu.

15

World Time
Time Zone
Date
Date Format
Daylight Saving Time OFF
London, Casablanca
UTC 0
2005/12/10 10:00:00

Highlight **Date Format**.

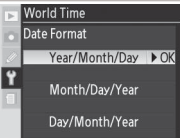

16

World Time
Date Format
Year/Month/Day OK
Month/Day/Year
Day/Month/Year

Display options.

17

World Time
Date Format
Year/Month/Day OK
Month/Day/Year
Day/Month/Year

Choose order in which date is displayed.

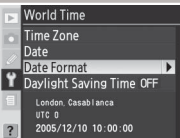

18

World Time
Time Zone
Date
Date Format
Daylight Saving Time OFF
London, Casablanca
UTC 0
2005/12/10 10:00:00

Return to **WORLD TIME** menu.

19

SET UP MENU
Format --
LCD Brightness 0
Mirror Lock-up --
Video Mode NTSC
World Time --
Language En
Image Comment OFF

Return to setup menu.

Using Camera Menus

The language option is only highlighted automatically the first time menus are displayed. See "Using Camera Menus" (24–25) for information on normal menu operation.

Inserting Memory Cards

Photographs are stored on CompactFlash memory cards (available separately).

1 Insert a memory card

- 1.1** Turn the camera off before inserting or removing memory cards. Unlatch (1) and open (2) the memory card cover.

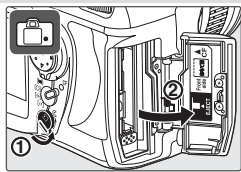

- 1.2** Insert the card as shown at right. The eject button will pop up and the memory card access lamp will light for about a second. Close the memory card slot cover.

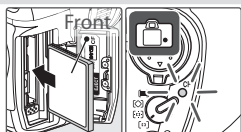

✓ Inserting Memory Cards

Confirm that the memory card is in the orientation shown. Attempting to insert cards upside down or backward could damage the camera or card. Do not use force.

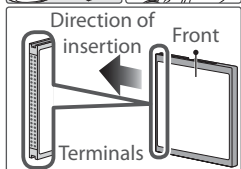

2 Format the memory card

Formatting memory cards permanently deletes all photographs and other data they may contain. Be sure all data you wish to keep have been copied to another storage device before formatting the card.

2.1



Turn camera on and press **FORMAT** (Ⓜ) and **MODE** buttons simultaneously for about 2 seconds until **F a r** blinks in control panel and viewfinder.

2.2

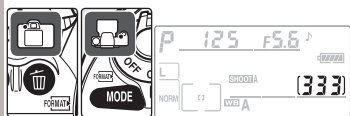

Press **FORMAT** buttons again.* Do not turn camera off or remove battery or memory card until formatting is complete and control panel shows number of exposures remaining.

* Press any other button to exit without formatting memory card.

Removing Memory Cards

1 Confirm that the access lamp is off.

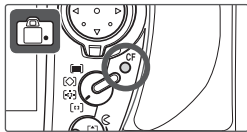

2 Turn the camera off and open the memory card slot cover.

3 Press the eject button to partially eject the card (1). The card can then be removed by hand (2). Do not push on the memory card while pressing the eject button. Failure to observe this precaution could damage the camera or memory card.

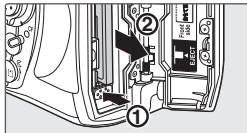

Illustrations

In illustrations throughout this manual, indicators in the control panel and viewfinder relevant to the explanation in the accompanying text are shown in black. Indicators not mentioned in the text are shown in gray.

Adjusting Viewfinder Focus

Photographs are framed in the viewfinder. Before shooting, make sure that the display in the viewfinder is in clear focus.

- 1 Remove the lens cap and turn the camera on.



- 2 Rotate the diopter adjustment control until the focus brackets are displayed in sharp focus when the shutter-release button is pressed halfway. When operating the diopter adjustment control with your eye to the viewfinder, be careful not to put your fingers or fingernails in your eye.

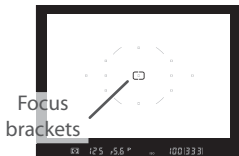
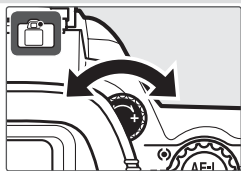

Auto Meter-Off

At default settings, the viewfinder display and the aperture and shutter-speed indicators in the control panel will turn off if no operations are performed for about six seconds (auto meter-off), reducing the drain on the battery. Press the shutter-release button halfway to reactivate the display.

Tutorial: Photography and Playback

Basic Photography

This section describes how to take pictures at default settings.

1 Turn the camera on

- 1.1** Remove the lens cap and turn the camera on. The control panel will turn on and the display in the viewfinder will light. The monitor remains off during shooting.



- 1.2** Check the battery level in the viewfinder or control panel.

Control panel	View-finder	Description
	—	Battery fully charged.
	—	Battery partially discharged.
		Low battery. Ready fully-charged spare battery.
 (blinks)	 (blinks)	Shutter-release disabled. Change battery.



Battery level is not displayed when camera is powered by optional AC adapter.

- 1.3** The exposure count displays in the control panel and viewfinder show the number of photographs that can be stored on the memory card. Check the number of exposures remaining.

If there is not enough memory to store additional photographs at current settings, the display will flash as shown at right. No further pictures can be taken until the memory card has been replaced or pictures have been deleted.





2 Adjust camera settings

This tutorial describes how to take photographs at the default settings listed in the table below, using a type G or D lens. See the “Reference” section for information on when and how to change settings from their default values.

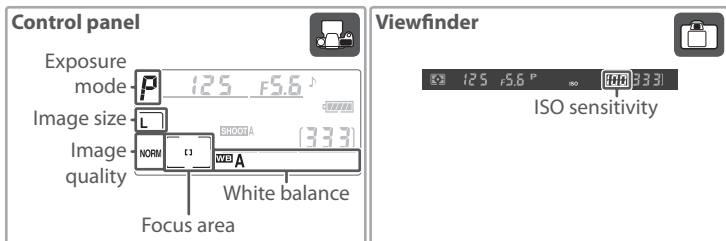

Option	Default	Description	
Image quality	NORM (JPEG Normal)	Balance between image quality and file size is ideal for snapshots.	28–31
Image size	L (Large)	Images are 3,872 × 2,592 pixels in size.	32
ISO sensitivity	100	ISO sensitivity (digital equivalent of film speed) set to value roughly equivalent to ISO 100.	33–34
White balance	A (Auto)	White balance automatically adjusted for natural coloration under most types of lighting.	35–44
Exposure mode	P (Programmed auto)	Built-in exposure program automatically adjusts shutter speed and aperture for optimal exposure in most situations.	62–69
Focus area	Center focus area	Camera focuses on subject in center focus area.	53

- 2.1** Press the mode-dial lock release (1) while turning the mode dial (2) to **S** (single frame). At this setting, the camera will take one photograph each time the shutter-release button is pressed.

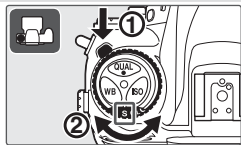

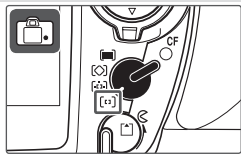

- 2.2** Rotate the AF-area mode selector until it clicks into place pointing to **[+]** (single-area AF). At this setting, the camera will focus on the subject in the focus area selected by the user.

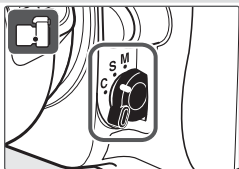

- 2.3** Rotate the focus-mode selector until it clicks into place pointing to **S** (single-servo auto-focus). At this setting, the camera will focus automatically when the shutter-release button is pressed halfway. Pictures can only be taken when the camera is in focus.



- 2.4** Rotate the metering selector to  (matrix metering). Matrix metering uses information from all areas of the frame to determine exposure, producing optimal results for the entire frame. A  icon appears in the viewfinder.

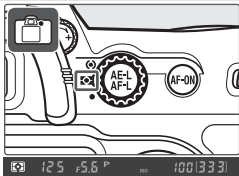

3 Frame a photograph

- 3.1** Hold the camera as shown.

Holding the Camera

Hold the handgrip in your right hand and cradle the camera body or lens with your left. Keep your elbows propped lightly against your torso for support and place one foot half a pace ahead of the other to keep your upper body stable.



- 3.2** Frame a photo in the viewfinder with the main subject positioned in the center focus area.



4 Focus

Press the shutter-release button halfway to focus. If the camera is able to focus on the subject in the center focus area, a beep will sound and the in-focus indicator (●) will appear in the viewfinder (if the focus indicator blinks, the camera was unable to focus using autofocus). Focus will lock while the shutter-release button is pressed halfway.

If the subject is dark, the AF-assist illuminator may light to assist the focus operation.

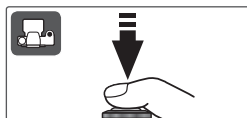

5 Check exposure

In exposure mode **P** (programmed auto), the camera automatically sets shutter speed and aperture when the shutter-release button is pressed halfway. Before shooting, check the shutter-speed and aperture indicators in the viewfinder. If the photo would be under- or over-exposed at current settings, one of the following indicators will be displayed.



Indicator	Description
	Photo will be overexposed. Use optional Neutral Density (ND) filter.
	Photo will be underexposed. Use flash or raise ISO sensitivity.

The Shutter-Release Button

The camera has a two stage shutter-release button. The camera focuses when the button is pressed halfway; focus locks until the button is released. To take the picture, press the shutter-release button the rest of the way down.

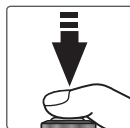
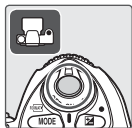

6 Take the photograph

Smoothly press the shutter-release button the rest of the way down to release the shutter and record the photograph. The access lamp next to the card slot cover will light. ***Do not eject the memory card or remove or disconnect the power source until the lamp has gone out and recording is complete.***

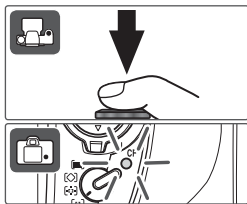

Basic Playback



Press the  button to view photographs. The most recent photo will be displayed in the monitor; additional pictures can be displayed by pressing the multi-selector left or right.

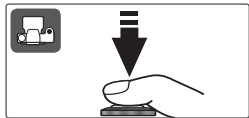

To end playback and return to shooting mode, press the shutter-release button halfway.



Deleting Unwanted Photographs

To delete the photograph currently displayed in the monitor, press the  button. A confirmation dialog will be displayed. Press the  button again to delete the image and return to playback. To exit without deleting the picture, press the  button or press the shutter-release button halfway.

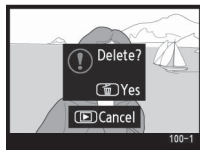

Reference

This section builds on the Tutorial to cover more advanced shooting and playback options.

Use the menus	Using Camera Menus: 📷 24
Take photographs in bursts Reduce shutter lag	Choosing a Shooting Mode: 📷 26
Adjust image quality and size	Image Quality and Size: 📷 28
Raise ISO sensitivity when lighting is poor	ISO Sensitivity: 📷 33
Make colors look natural Take photos under unusual lighting	White Balance: 📷 35
Customize sharpening, contrast, color, saturation, and hue	Optimizing Images: 📷 45
Choose a color space	Color Space: 📷 50
Shoot a moving subject or focus manually	Focus: 📷 51
Let the camera choose shutter speed and aperture	Exposure Mode P (Programmed Auto): 📷 63
Freeze or blur motion	Exposure Mode S (Shutter-Priority Auto): 📷 64
Control depth of field	Exposure Mode A (Aperture-Priority Auto): 📷 66
Choose shutter speed and aperture manually	Exposure Mode M (Manual): 📷 68
Make photographs brighter or darker or enhance contrast	Exposure Compensation: 📷 72
Use the built-in flash	Flash Photography: 📷 76
Take photos with the self-timer	Self-Timer Mode: 📷 83
Superimpose photos on one another	Image Overlay and Multiple Exposure: 📷 84
Take photos at specified intervals	Interval-Timer Photography: 📷 89
Use a non-CPU lens	Non-CPU Lenses: 📷 93
Record GPS data with photographs	Using a GPS Unit: 📷 96
View photographs	Viewing Photographs: 📷 98



Using Camera Menu

Most shooting, playback, and setup options can be accessed from the camera menus. To view the menus, press the **MENU** button.



Choose from playback, shooting, Custom Settings, and setup menus (see below)

View recent settings

If “?” icon is displayed, help for current item can be viewed by pressing **HELP** button.

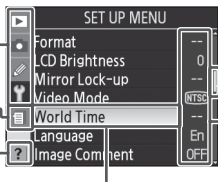

Slider is displayed if more options are available in current menu

Current setting for each option is shown by icon

Current menu item is highlighted

Menu	Description
Playback	Adjust playback settings and manage photos (133).
Shooting	Adjust shooting settings (124).
Custom Settings	Personalize camera settings (143).
Setup	Format memory cards and perform basic camera setup (115).
Recent Settings	Lists the fourteen most recently used items in the shooting and Custom Settings menus.

The multi selector is used to navigate through the camera menus.

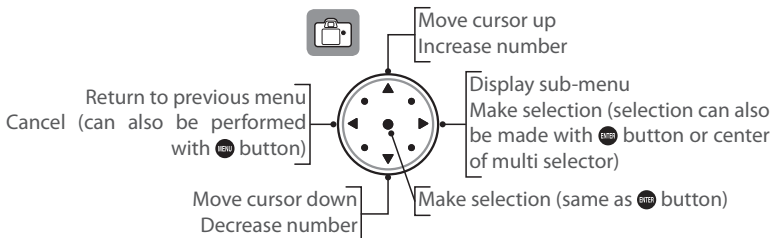

Help

For help on menu options, press the **HELP** button. A description of the currently selected option or menu will be displayed. To scroll the display, press the **HELP** button while pressing the multi selector up or down.

Locking and Deleting Recent Settings

The **Recent Settings** option in the setup menu (119) can be used to delete all items from the Recent Settings menu or to lock the menu at current settings, creating a customized menu of shooting and Custom Menu options.

To modify menu settings:

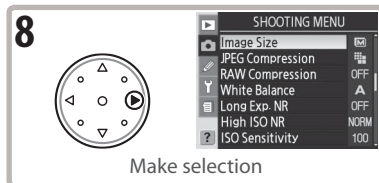
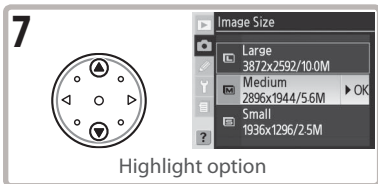
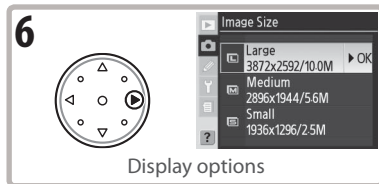
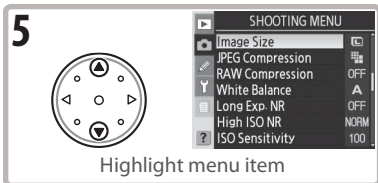
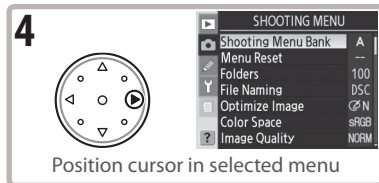
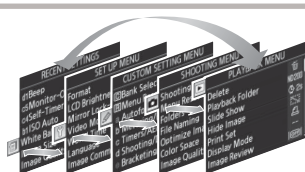
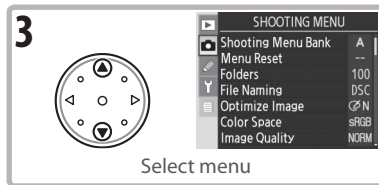
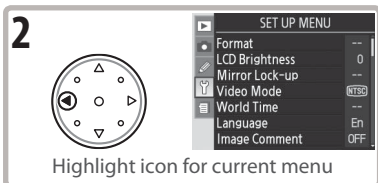
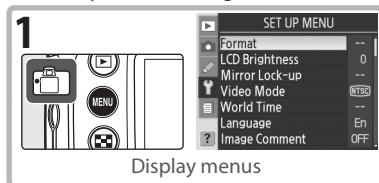

- Menu items that are displayed in gray are not currently available.
- When formatting memory cards and in other cases in which user confirmation is required, a selection can only be made with the center of the multi-selector or by pressing the **MENU** button. A message to this effect will appear in the display.



Exiting the Menus

Press the shutter-release button halfway to exit the menus and return to shooting mode, or press the **MENU** button once to highlight the icon for the current menu and again to exit to shooting mode.

Reference: More on Photography

Choosing a Shooting Mode

Shooting mode determines how the camera takes photographs: one at a time, in a continuous sequence, with a timed shutter-release delay, or with the mirror raised to enhance shutter response and minimize vibration.

Mode	Description
S Single frame	Camera takes one photograph each time shutter-release button is pressed. Access lamp will light while photo is recorded; next shot can be taken immediately if enough space remains in memory buffer.
CL Continuous low speed	While shutter-release button is held down, camera records 1–4 frames per second.* Frame rate can be chosen using Custom Setting d4 (Shooting Speed ;  158).
CH Continuous high speed	While shutter-release button is held down, camera records up to 5 frames per second.* Use to photograph moving objects or to capture a fleeting expression on portrait subjects.
 Self-timer	Use the self-timer for self-portraits or to reduce blurring caused by camera shake ( 83).
MUP Mirror up	Press shutter-release button once to raise mirror, again to take photograph (shutter will be released automatically if shutter-release button is not pressed for 30s after mirror up). Mirror will be lowered after shutter is released. Choose this mode to minimize camera shake in situations in which the least camera movement can result in blurred photographs. Note that autofocus, metering, and framing can not be confirmed in the viewfinder while mirror is raised.

* Average frame rate with continuous-servo AF, manual or shutter-priority auto exposure, a shutter speed of $1/250$ s or faster, and memory remaining in memory buffer.

To choose a shooting mode, press the mode dial lock release and turn the mode dial to the desired setting.

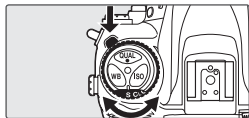

Buffer Size

The number of images that can be stored in the memory buffer at current settings is shown in the exposure-count displays in the viewfinder and control panel while the shutter-release button is pressed (at image qualities of **JPEG Fine**, **JPEG Normal**, and **JPEG Basic**, the display will show 25 when the buffer contains space for 25 or more images). This number is updated as photographs are transferred to the memory card and more memory becomes available in the buffer. If 0 is displayed, the memory buffer is full and shooting will slow.

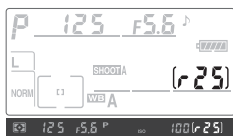

Auto Image Rotation (119)

In continuous mode, the orientation recorded for the first shot applies to all photographs in the same burst, even if camera orientation is changed during shooting.

The Memory Buffer

The camera is equipped with a memory buffer for temporary storage, allowing shooting to continue while photographs are being saved to the memory card. When the buffer is full, the shutter is disabled until enough data have been transferred to the memory card to make room for another photograph. In continuous mode, shooting will continue to a maximum of 100 shots as long as the shutter-release button is held down, although the frame rate will drop once the buffer has filled.

While photographs are being recorded to the memory card, the access lamp next to the memory card slot will light. Depending on the number of images in the buffer, recording may take from a few seconds to a few minutes. **Do not remove the memory card or remove or disconnect the power source until the access lamp has gone out.** If the camera is switched off while data remain in the buffer, the power will not turn off until all images in the buffer have been recorded. To turn the camera off without recording the images in the buffer, press the button while turning the camera off (keep the button pressed for at least one second after turning the camera off). If the battery is exhausted while images remain in the buffer, the shutter release will be disabled and the images transferred to the memory card.

The approximate time required to write the entire buffer to a 1 GB SanDisk SDCFX (Extreme III) card is as follows (ISO sensitivity set to ISO 100 equivalent):

Uncompressed NEF (RAW) + JPEG Basic (Large)	50 s (19 frames)
Uncompressed NEF (RAW)	50 s (22 frames)
JPEG Fine (Large)	35 s (37 frames)

The buffer size shown in the control panel and viewfinder is an approximation only. The file size of compressed images varies with the scene recorded, producing variations in the number of images that can be stored. See the Appendix (196) for more information.

Image Quality and Size

Together, image quality and size determine how much space each photograph occupies on the memory card.

Image Quality

The camera supports the following image quality options (listed in descending order by image quality and file size):

Mode	Description
NEF (RAW)	Raw 12-bit data from the image sensor are saved directly to the memory card in Nikon Electronic Format (NEF).
JPEG Fine	Record JPEG images at a compression ratio of roughly 1:4.*
JPEG Normal	Record JPEG images at a compression ratio of roughly 1:8.*
JPEG Basic	Record JPEG images at a compression ratio of roughly 1:16.*
NEF (RAW) + JPEG Fine	Two images are recorded: one NEF (RAW) image and one fine-quality JPEG image.
NEF (RAW) + JPEG Normal	Two images are recorded: one NEF (RAW) image and one normal-quality JPEG image.
NEF (RAW) + JPEG Basic	Two images are recorded: one NEF (RAW) image and one basic-quality JPEG image.

* **Size Priority** selected for **JPEG Compression** (📷 30).

Image quality can be set using the **Image Quality** option in the shooting menu or by pressing the **QUAL** button and rotating the main command dial. Two options are available for controlling compression: **RAW Compression** for NEF (RAW) images (📷 31) and **JPEG Compression** for JPEG images (📷 30).

NEF (RAW)/NEF+JPEG

NEF (RAW) images can only be viewed on a computer using the supplied software or Nikon Capture 4 Version 4.4 or later (available separately; 📷 182). When photographs taken at **NEF (RAW) + JPEG Fine**, **NEF (RAW) + JPEG Normal**, or **NEF (RAW) + JPEG Basic** are viewed on the camera, only the JPEG image will be displayed. When photographs taken at these settings are deleted, both the NEF and JPEG images will be deleted.

White balance bracketing can not be used with NEF (RAW) images. Selecting an NEF (RAW) option for image quality cancels white balance bracketing.

Image Quality, Image Size, and File Size

See the Appendix for information on the number of pictures that can be stored on a memory card (📷 196).





The Image Quality Menu

1 Highlight **Image Quality** in the shooting menu and press the multi selector to the right.



2 Highlight the desired option and press the multi selector to the right. The shooting menu will be displayed.

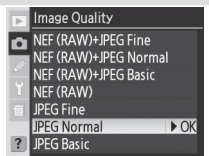

The QUAL Button

Press the **QUAL** button and rotate the main command dial until the desired setting is displayed in the control panel (note that **RAW Compression** and **JPEG Compression** can only be adjusted from the shooting menu).

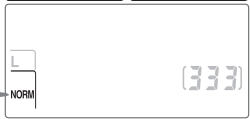
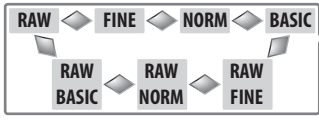

File Names

Photographs are stored as image files with names of the form "DSC_nnnn.xxx," where nnnn is a four-digit number between 0001 and 9999 assigned automatically in ascending order by the camera, and xxx is one of the following three letter extensions: "NEF" for NEF images, "JPG" for JPEG images, and "NDF" for Dust Off ref photos (121–122). The NEF and JPEG files recorded at a setting of "NEF+JPEG" have the same file names but different extensions. Images recorded at a **Color Space** setting of **AdobeRGB** (50) have names that begin with an underscore (e.g., "_DSC0001.JPG"). The "DSC" portion of the file name can be changed using the **File Naming** option in the shooting menu (129).

The JPEG Compression Menu

The JPEG compression menu offers the following options for JPEG images:

Mode	Description
Size Priority (default)	Images are compressed to produce relatively uniform file size. Quality varies with scene recorded.
Optimal Quality	Optimal image quality. File size varies with scene recorded.

The effects of these options are most pronounced with high ISO sensitivity (📷 33), complex scenes, basic-quality JPEG images, or heavy sharpening (📷 46).

- 1 Highlight **JPEG Compression** in the shooting menu and press the multi selector to the right.

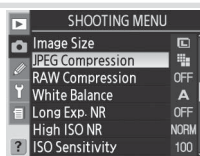

- 2 Highlight the desired option and press the multi selector to the right. The shooting menu will be displayed. The selected option applies to all subsequent JPEG-quality images.

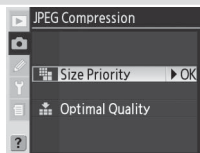

The RAW Compression Menu

The following options are available for NEF (RAW) images:

Mode	Description
NEF (RAW) (default)	NEF images are not compressed.
Comp. NEF (RAW)	NEF images are compressed by about 40–50% with little drop in quality. Recording time is reduced.

- 1 Highlight **RAW Compression** in the shooting menu and press the multi selector to the right.

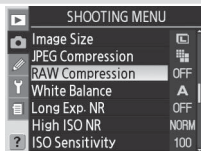

- 2 Highlight the desired option and press the multi selector to the right. The shooting menu will be displayed. The selected option applies to all subsequent NEF (RAW) images.

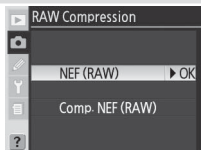

Image Size

Image size is measured in pixels. Smaller sizes produce smaller files, making them suited to distribution via e-mail or inclusion in web pages. Conversely, the larger the image, the larger the size at which it can be printed without becoming noticeably “grainy.” Choose image size according to the space available on the memory card and the task at hand.

Image size	Size (pixels)	Approximate size when printed at 200 dpi
Large (3872×2592/10.0 M)	3,872 × 2,592	49.2 × 32.9 cm (19.36 × 12.96 in.)
Medium (2896×1944/5.6 M)	2,896 × 1,944	36.8 × 24.7 cm (14.48 × 9.72 in.)
Small (1936×1296/2.5 M)	1,936 × 1,296	24.6 × 16.5 cm (9.68 × 6.48 in.)

Image size can be set using the **Image Size** option in the shooting menu or by pressing the **QUAL** button and rotating the sub-command dial. Note that the option selected does not affect the size of NEF (RAW) images. When viewed on a computer using the supplied software or Nikon Capture 4 Version 4.4 or later (available separately), NEF images are 3,872 × 2,592 pixels in size.

The Image Size Menu

- 1 Highlight **Image Size** in the shooting menu and press the multi selector to the right.

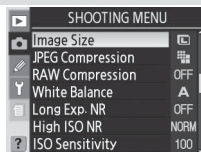

- 2 Highlight the desired option and press the multi selector to the right. The shooting menu will be displayed.

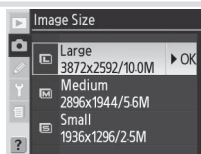

The QUAL Button

Press the **QUAL** button and rotate the sub-command dial until the desired setting is displayed in the control panel.



ISO Sensitivity

“ISO sensitivity” is the digital equivalent of film speed. The higher the ISO sensitivity, the less light needed to make an exposure, allowing higher shutter speeds or smaller apertures.

ISO sensitivity can be set between values roughly equivalent to ISO 100 and ISO 1600 in steps equivalent to $\frac{1}{3}$ EV. Where high sensitivity is a priority, ISO sensitivity can be further increased up to 1 EV over ISO 1600. ISO sensitivity can be adjusted using the **ISO Sensitivity** option in the shooting menu or by pressing the **ISO** button and rotating the main command dial.

The ISO Sensitivity Menu

- 1 Highlight **ISO Sensitivity** in the shooting menu and press the multi selector to the right.

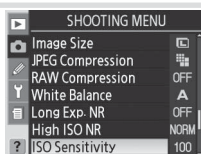

- 2 Highlight the desired option and press the multi selector to the right. The shooting menu will be displayed.

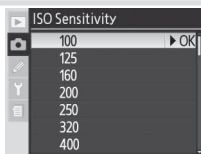

The ISO Button

Press the **ISO** button and rotate the main command dial until the desired setting is displayed in the control panel or viewfinder.

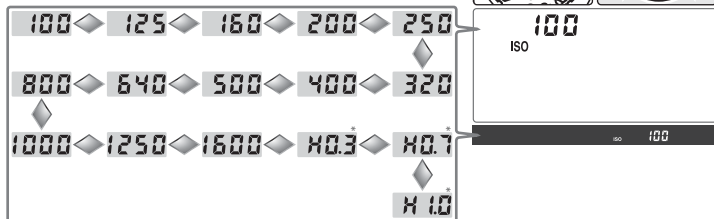

* Viewfinder display shows **H** i.

Noise

The higher the ISO sensitivity, the more likely pictures are to be subject to “noise” in the form of randomly-spaced, brightly-colored pixels. Photos taken at ISO sensitivities over ISO 1600 will likely contain appreciable amounts of noise.

High ISO NR 131

This option can be used to reduce noise at ISO sensitivities of 400 or more (this reduces the capacity of the memory buffer). Note that although high ISO noise reduction is always in effect at ISO sensitivities over ISO 800, turning **High ISO NR** on will increase the amount of noise reduction performed.

b1—ISO Auto 152

When **On** is selected for Custom Setting b1 (**ISO Auto**), the camera will automatically vary ISO sensitivity from the value selected by the user to help ensure optimum exposure (maximum can be selected from ISO 200, 400, 800, and 1600). ISO sensitivity can not be raised above 1600 while **ISO Auto** is on, and **On** can not be selected for **ISO Auto** at ISO sensitivities over 1600.

b2—ISO Step Value 154

Depending on the option selected for Custom Setting b2, ISO sensitivity can also be set in increments equivalent to $\frac{1}{2}$ or 1 EV.

ISO step value set to 1/2 step



ISO step value set to 1 step









If possible, the current ISO sensitivity setting is maintained when the step value is changed. If the current sensitivity setting is not available at the new step value, ISO sensitivity will be rounded up to the nearest available setting.



White Balance

The color of light reflected from an object varies with the color of the light source. The human brain is able to adapt to changes in the color of the light source, with the result that white objects appear white whether seen in the shade, direct sunlight, or under incandescent lighting. Unlike the film used in film cameras, digital cameras can mimic this adjustment by processing images according to the color of the light source. This is known as “white balance.” For natural coloration, choose a white balance setting that matches the light source before shooting. The following options are available:

Option	Approximate color temperature*	Description
A Auto	3,500–8,000 K	White balance adjusted automatically using color temperature measured by 1,005-pixel RGB sensor and image sensor. For best results, use type G or D lens. With built-in flash or optional SB-800 and SB-600 Speedlights, white balance reflects conditions in effect when flash fires.
 Incandescent	3,000 K	Use under incandescent lighting.
 Fluorescent	4,200 K	Use under fluorescent lighting.
 Dir. Sunlight	5,200 K	Use with subjects lit by direct sunlight.
 Flash	5,400 K	Use with built-in flash or optional Nikon flash units.
 Cloudy	6,000 K	Use in daylight under overcast skies.
 Shade	8,000 K	Use in daylight with subjects in the shade.
 Choose Color Temp.	2,500–10,000 K	Choose color temperature from list of values (📷 38).
PRE White Balance Preset	—	Use gray or white object or existing photograph as reference for white balance (📷 39).

* Fine-tuning set to 0. See the Appendix for other values.

Auto white balance is recommended with most light sources. If the desired results can not be achieved with auto white balance, choose an option from the list above or use preset white balance.

Studio Strobe Lighting

Auto white balance may not produce the desired results with studio strobe lighting. Choose a color temperature, use preset white balance, or set white balance to **Flash** and use fine tuning to adjust white balance.





White balance can be set using the **White Balance** option in the shooting menu or by pressing the **WB** button and rotating the main command dial.

The White Balance Menu

- 1 Highlight **White Balance** in the shooting menu and press the multi selector to the right.

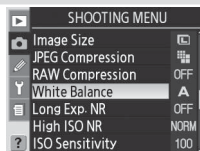

- 2 Highlight the desired option and press the multi selector to the right. Selecting **Choose Color Temp.** displays a menu of color temperatures (👁 38), **White Balance Preset** a preset white balance menu (👁 39), other options a fine-tuning dialog (👁 37).

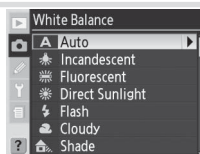

The WB Button

Press the **WB** button and rotate the main command dial until the desired setting is displayed in the control panel.

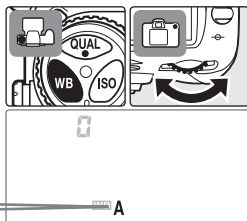

e5—Auto BKT Set (👁 166)

When **WB Bracketing** is selected for custom setting e5 (**Auto BKT Set**), the camera will create several images each time the shutter is released. White balance will be varied with each image, “bracketing” the value currently selected for white balance.



Fine-Tuning White Balance

At settings other than **☑ (Choose Color Temp.)** and **PRE (White Balance Preset)**, white balance can be “fine tuned” to compensate for variations in the color of the light source or to introduce a deliberate “warm” or “cold” cast into an image. Higher settings (“+”) can be used to lend images a bluish tinge or to compensate for light sources with a yellow or red cast, while lowering white balance (“-”) can make photographs appear slightly more yellow or red or compensate for light sources with a blue cast. Adjustments can be made in the range +3 to -3 in increments of one. Except in **Fluorescent** mode, each increment is equivalent to about 10 mired.

White balance is fine tuned using the **White Balance** option in the shooting menu or by pressing the **WB** button and rotating the sub-command dial. At settings other than ± 0 , a **◀▶** icon appears in the control panel.

The White Balance Menu

Selecting an option other than **Choose Color Temp.** or **White Balance Preset** in the white balance menu (📷 35) displays the menu shown at right. Press the multi selector up or down to choose the desired value and press the multi selector to the right. The shooting menu will be displayed.

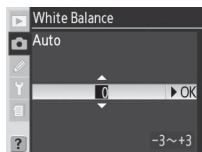

The WB Button

Press the **WB** button and rotate the sub-command dial until the desired value is displayed.

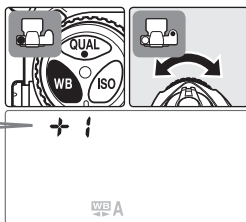

Mired

Any given change in color temperature produces a greater difference in color at low color temperatures than it would at higher color temperatures. For example, a change of 1000K produces a much greater change in color at 3000K than at 6000K. Mired, calculated by multiplying the inverse of the color temperature by 10^6 , is a measure of color temperature that takes such variation into account, and as such is the unit used in color-temperature compensation filters. E.g.:

- 4000K–3000K (a difference of 1000K) = 83 mired
- 7000K–6000K (a difference of 1000K) = 24 mired



Choosing a Color Temperature

Choose a setting of **K** (**Choose Color Temp.**) to select the color temperature from thirty-one predetermined values ranging from 2,500 K to 10,000 K in increments of roughly 10 mired (note that the desired results will not be obtained with flash or fluorescent lighting). Color temperature can be selected in the white-balance menu or with the **WB** button and sub-command dial.

The White Balance Menu

Selecting **Choose Color Temp.** in the white balance menu (35) displays the menu shown at right. Press the multi selector up or down to choose the desired value and press the multi selector to the right. The shooting menu will be displayed.

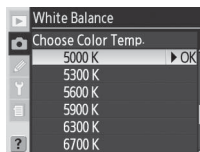

The WB Button

Press the **WB** button and rotate the sub-command dial until the desired value is displayed.

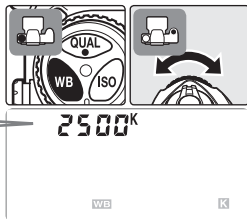

Take Test Shots

Take a test shot to determine if the selected value is appropriate to the light source.

Color Temperature

The perceived color of a light source varies with the viewer and other conditions. Color temperature is an objective measure of the color of a light source, defined with reference to the temperature to which an object would have to be heated to radiate light in the same wavelengths. While light sources with a color temperature in the neighborhood of 5,000–5,500 K appear white, light sources with a lower color temperature, such as incandescent light bulbs, appear slightly yellow or red. Light sources with a higher color temperature appear tinged with blue.

Preset White Balance

Preset white balance is used to record and recall custom white balance settings for shooting under mixed lighting or to compensate for light sources with a strong color cast. Two methods are available for setting preset white balance:

Method	Description
Direct measurement	Neutral gray or white object is placed under lighting that will be used in final photograph and white balance is measured by camera (40).
Copy from existing photograph	White balance is copied from photo on memory card (42) or white balance value is copied from Nikon Capture 4 Version 4.4 or later (available separately; 182).

The camera can store up to five values for preset white balance in presets d-0 through d-4. A descriptive comment can be added to any white balance preset (42).

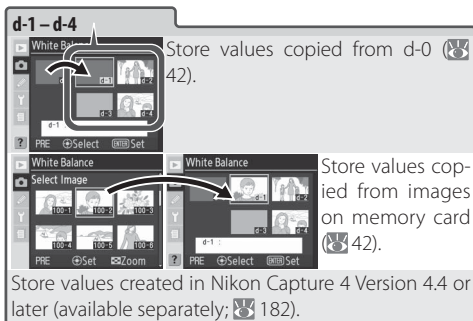

White Balance Presets

Changes to white balance presets apply to all shooting menu banks (125). A confirmation dialog will be displayed if the user attempts to change a white balance preset created in another shooting menu bank (no warning is displayed for preset d-0).

Measuring a Value for White Balance

White balance can be measured with reference to a neutral gray object. The new value for white balance is automatically stored in preset d-0.

- 1 Place a neutral gray or white object under the lighting that will be used in the final photograph. A standard gray card can be used as a reference in studio settings.

- 2 Press the **WB** button and rotate the main command dial until **PRE** is displayed in the control panel. If the new value for preset white balance will be used immediately, select preset d-0 by pressing the **WB** button and rotating the sub-command dial until d-0 is displayed. Otherwise there is no need to select d-0 when measuring a new value for white balance.

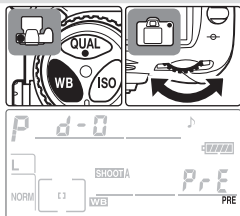

- 3 Release the **WB** button briefly and then press the button until the **PRE** icon starts to flash. A blinking **PRE** will also appear in the control panel and viewfinder frame-count displays.

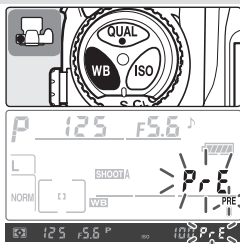

- 4 Frame the reference object so that it fills the viewfinder and press the shutter-release button all the way down. The camera will measure a value for white balance and use this value when preset white balance is selected. No photograph will be recorded; white balance can be measured accurately even when the camera is not in focus.



To exit without measuring a new value for white balance, press the **WB** button.

- 5 If the camera was able to measure a value for white balance, **Good** will flash in the control panel and the viewfinder will show a flashing **Good** for about three seconds before the camera returns to shooting mode.



If lighting is too dark or too bright, the camera may be unable to measure white balance. A flashing **no Good** will appear in the control panel and viewfinder for about three seconds. Return to Step 4 and measure white balance again.



The new value for white balance will be stored in preset d-0, automatically replacing the previous value for this preset (no confirmation dialog will be displayed). To use the new value, select preset d-0 (if no value has been measured for white balance before d-0 is selected, white balance will be set to a color temperature of 5,200 K, the same as **Direct Sunlight**). The new white balance value will remain in preset d-0 until white balance is measured again. By copying preset d-0 to one of the other presets before measuring a new value for white balance, up to five white balance values can be stored (📖 42).

Nikon Capture 4

Nikon Capture 4 Version 4.4 or later (available separately) can be used to edit white balance when RAW photographs taken with the D200 are displayed on a computer. The edited value can be copied directly to a white balance preset while the camera is connected to a computer, or the image can be saved to the camera memory card and the white balance value copied using the **Select Image** option in the preset menu. Any comments created with Nikon Capture 4 will also be copied to the comment for the selected preset. See the Nikon Capture 4 manual for details.

Preset White Balance Options

Selecting **White Balance Preset** in the **White Balance** menu (35) displays the menu of white-balance presets shown in Step 1. To display options for a selected preset:

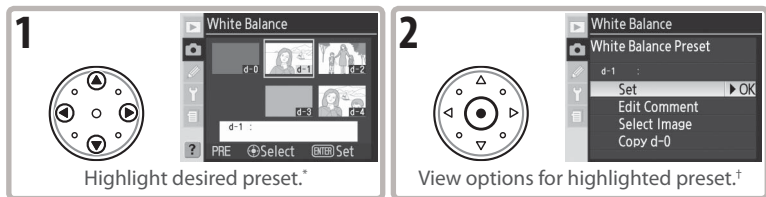

* To set white balance to the value for the highlighted preset and return to shooting mode without completing Step 2, press **OK** button.

† To view options for other presets, highlight name of current preset (d-0–d-4) and press multi selector right.

Press the multi selector up or down to highlight an option, then press to the right to select.

Option	Description
Set	Set white balance to value for selected preset and return to shooting menu.
Edit Comment	Text edit dialog is displayed (118). Enter comment of up to 36 characters for current preset and press OK button to return to Step 1.
Select Image (d-1–d-4 only)	Photos on memory card are displayed as thumbnail images. Use multi selector to highlight photos; press OK button to view highlighted photo full frame. Press center of multi selector to copy white balance value (and comment, if any) for highlighted image to current preset and return to Step 1. Only photos taken with D200 can be selected.
Copy d-0 (d-1–d-4 only)	Copy white balance value (and comment, if any) for preset d-0 to current preset and return to Step 1.

The WB Button

At a setting of **PRE (White Balance Preset)**, presets can also be selected by pressing the **WB** button and rotating the sub-command dial. The current preset is displayed while the **WB** button is pressed.

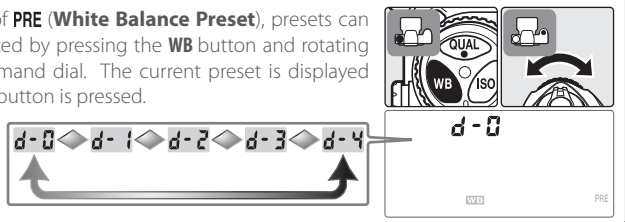



White Balance Bracketing

White balance bracketing creates multiple images each time the shutter is released, “bracketing” the current white balance setting (WB 35). Only one shot is required to complete the bracketing sequence. White balance bracketing is recommended when shooting under mixed lighting or experimenting with different white balance settings. White balance bracketing is not available at white-balance settings of **K** (**Choose Color Temp.**) or **PRE** (**White Balance Preset**) or at image qualities of **NEF (RAW)**, **NEF+JPEG Fine**, **NEF+JPEG Normal**, or **NEF+JPEG Basic**.

To use white balance bracketing:

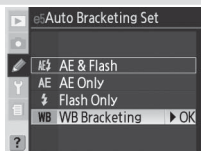
- 1 Choose **WB Bracketing** for Custom Setting e5 (**Auto BKT Set**;  166).



- 2 Pressing the **BKT** button, rotate the main command dial to choose the number of shots in the bracketing sequence ( 197). At settings other than zero, a **WB-BKT** icon and bracketing indicator will appear in the control panel.

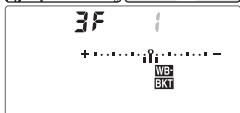

If the number of shots in the bracketing program exceeds the number of exposures remaining, **FULL** (**FuL**) will be displayed and the number of exposures remaining will blink. Shooting can begin if a new memory card is inserted.



- 3 Pressing the **BKT** button, rotate the sub-command dial to choose the white balance adjustment ( 197). Each increment is roughly equivalent to 10 mired.





- 4 Compose a photograph, focus, and shoot. Each shot will be processed to create the number of copies specified in the bracketing program, and each copy will have a different white balance. Modifications to white balance are added to the white balance adjustment made with white balance fine-tuning.

To cancel bracketing, press the **BKT** button and rotate the main command dial until the number of shots in the bracketing sequence is zero and white-balance bracketing indicator is no longer displayed in the control panel. The program last in effect will be restored the next time bracketing is activated. Bracketing can also be cancelled by performing a two-button reset (**1/3** 97), although in this case the bracketing program will not be restored the next time bracketing is activated.

Image Quality

Selecting **NEF (RAW)**, **NEF+JPEG Fine**, **NEF+JPEG Normal**, or **NEF+JPEG Basic** cancels white balance bracketing.

Shooting Mode

In all modes (including self-timer and continuous modes), only one shot will be taken each time the shutter-release button is pressed. Each shot will be processed to create the number of copies specified in the bracketing program.

Turning the Camera Off

If the camera is turned off while the camera while the memory card access lamp is lit, the camera will power off only after all photographs in the sequence have been recorded. To turn the camera off without recording the remaining photographs, press the **OFF** button while turning the camera off (keep the **OFF** button pressed for at least one second after turning the camera off).

Bracketing Programs

See the Appendix for a list of white balance bracketing programs.

e7—Auto BKT Order (1/3** 167)**









This option can be used to change the bracketing order.

e8—Auto BKT Selection (1/3** 167)**

If desired, the main command dial can be used to turn bracketing on and off and the sub-command dial to select both the number of shots and the white-balance increment.

Optimizing Images

The options in the **Optimize Image** menu can be used to optimize photographs according to how the picture will be used or the type of scene. Sharpening, contrast, color reproduction, saturation, and hue can also be customized individually to match the user's creative intent.

Option	Description
 Normal (default)	Recommended for most situations.
 Softer	Softens outlines, producing natural images suitable for portraits or retouching on a computer.
 Vivid	Enhances saturation, contrast, and sharpness to produce vivid images with vibrant reds, greens, and blues.
 More vivid	Maximizes saturation, contrast, and sharpness to produce crisp images with sharp outlines.
 Portrait	Lowers contrast while lending natural texture and rounded feel to skin of portrait subjects.
 Custom	Customize sharpness, contrast, color reproduction, saturation, and hue ( 46).
 Black-and-white	Take photos in black-and-white.

Black-and-white

A **B/W** icon is displayed in the viewfinder when shooting in black-and-white ( 6).

At Settings Other than Custom

At settings other than **Custom**:

- Photographs are optimized for current shooting conditions. Results will vary with exposure and the position of the subject in the frame, even in scenes of the same type. To take a series of photographs with identical image optimization, choose **Custom** and adjust settings individually, being sure not to select **Auto** for **Sharpening**, **Tone Compensation**, or **Saturation**.
- Use a type G or D lens for best results.

To select an image optimization option:

- 1 Highlight **Optimize Image** in the shooting menu (124) and press the multi selector to the right.

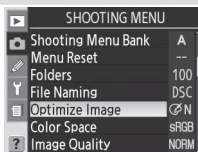

- 2 Highlight the desired option and press the multi selector to the right. If **Custom** is selected, a menu of custom options will be displayed (49). In all other cases, the shooting menu will be displayed.

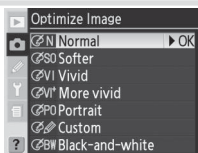

Customizing Image Enhancement Options

Select **Custom** to make separate adjustments to sharpening, contrast, color reproduction, saturation, and hue.

Making Edges More Distinct: Image Sharpening

During shooting, the camera processes photographs to emphasize the borders between light and dark areas, making pictures appear sharper. Sharpening can be customized using the **Image Sharpening** menu.

Option	Description
A Auto (default)	Camera automatically adjusts sharpening according to subject. Results vary from shot to shot, even in scenes of same type; choose different setting to take multiple shots with same sharpening. For best results, use type G or D lens.
0 Normal	All images are sharpened by same standard amount.
-2 Low	Images are sharpened less than standard amount.
-1 Medium Low	Images are sharpened slightly less than standard amount.
+1 Medium High	Images are sharpened slightly more than standard amount.
+2 High	Images are sharpened more than standard amount.
None	Images are not sharpened.

Adjusting Contrast: **Tone Compensation**

As photographs are saved to the memory card, they are processed to adjust the distribution of tones in the image, enhancing contrast. Tone compensation is performed by means of tone curves that define the relationship between the distribution of tones in the original image and the compensated result. The **Tone Compensation** menu controls the type of curve used.

Option	Description
A Auto (default)	Camera automatically optimizes contrast by selecting appropriate curve. Curve varies from shot to shot, even in scenes of same type; to take multiple shots with same curve, choose different setting. For best results, use type G or D lens.
0 Normal	Camera uses same standard curve for all images. Suited to most scenes, whether dark or bright.
- Less Contrast	Prevents highlights on portrait subjects from being “washed out” in direct sunlight.
+ More Contrast	Preserves detail in misty landscapes and other low-contrast subjects.
Custom	Custom curve can be created in Nikon Capture 4 Version 4.4 or later (available separately) and downloaded to camera. Choose Custom to select this user-defined curve. If no custom curve has been created, this option is equivalent to Normal .

Suiting Colors to the Subject: **Color Mode**

Much as film cameras offer a choice of films for different subjects, the D200 offers a choice of color modes with subtly different palettes.



Option	Description
I (default)	Choose for portrait shots.
II	Choose for photographs that will be extensively processed or retouched. This option is available only when AdobeRGB is selected for Color space .
III	Choose for nature or landscape shots.

Mode II

If **sRGB** is chosen for **Color space** when **Color mode** is set to Mode II, **Color mode** will be reset to the mode in effect when **sRGB** was last selected.

Controlling Vividness: Saturation

Saturation controls the vividness of colors.

Option	Description
A Auto	Camera automatically adjusts saturation according to subject. For best results, use type G or D lens.
 Normal (default)	Normal vividness. Recommended for most situations.
 Moderate	Reduced vividness. Use when taking pictures that will later be re-touched by computer.
 Enhanced	Increased vividness. Use for vivid, photoprint effect when taking pictures that will be printed "as is," without further modification.

Controlling Color: Hue Adjustment

Hue can be adjusted in the range of about -9° to $+9^\circ$ in increments of 3° . If red is taken as the starting color, raising hue above 0° (the default setting) would introduce a yellow cast, making colors that would be red at a setting of 0° appear increasingly orange. Lowering hue below 0° would introduce a blue cast, making colors that would be red at a setting of 0° appear increasingly purple.

Hue

The RGB color model used in digital photographs reproduces colors using differing amounts of red, green, and blue light. By mixing two colors of light, a variety of different colors can be produced. For example, red combined with a small amount of green light produces orange. If red and green are mixed in equal amounts, yellow results, while a smaller amount of red produces a yellow green. Mixing different amounts of red and blue light produces colors ranging from a reddish purple through purple to navy, while mixing different amounts of green and blue light produces colors ranging from emerald to turquoise. (Adding a third color of light results in lighter hues; if all three are mixed in equal amounts, the results range from white through gray.) When this progression of hues is arranged in a circle, the result is known as a color wheel.

Choosing Custom Image Optimization Options

Choosing **Custom** in the **Optimize Image** menu (📷 45) displays the menu shown in Step 1.

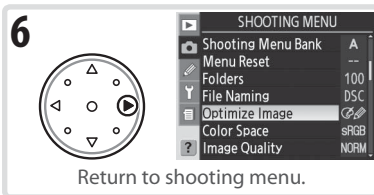
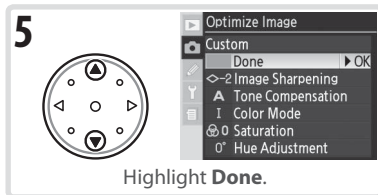
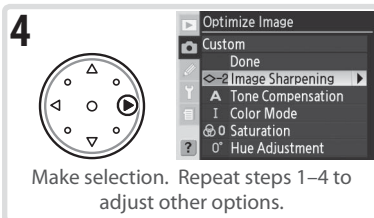
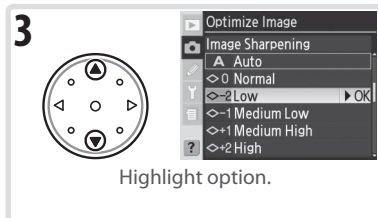
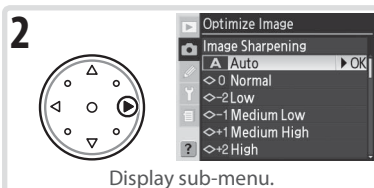
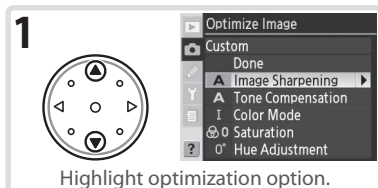

Color Space

The options in the **Color Space** menu determine the gamut of colors available for color reproduction. Choose a color space according to how photographs will be processed on leaving the camera.

Option	Description
sRGB sRGB (default)	Choose for photographs that will be printed or used “as is,” with no further modification. Color mode II is not available (47).
Adobe AdobeRGB	This color space is capable of expressing a wider gamut of colors than sRGB, making it the preferred choice for images that will be extensively processed or retouched.

- 1 Highlight **Color Space** in the shooting menu and press the multi selector to the right.



- 2 Highlight the desired option and press the multi selector to the right.

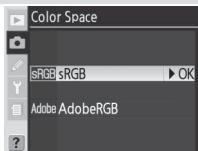

Color Space

sRGB is recommended when taking photographs that will be printed without modification or viewed in applications that do not support color management, or when taking photographs that will be printed with ExifPrint, the direct printing option on some household printers, or kiosk printing or other commercial print services. Adobe RGB photographs can also be printed using these options, but colors will not be as vivid.

JPEG photographs taken in the Adobe RGB color space are Exif 2.21 and DCF 2.0 compliant; applications and printers that support Exif 2.21 and DCF 2.0 will select the correct color space automatically. If the application or device does not support Exif 2.21 and DCF 2.0, select the appropriate color space manually. For more information, see the documentation provided with the application or device.

Nikon Software

Nikon Capture 4 Version 4.4 or later (available separately) and PictureProject automatically select the correct color space when opening photographs created with the D200.

Focus

This section describes the options that control how your camera focuses: focus mode, focus-area selection, and AF-area mode.

Focus Mode

Focus mode is controlled by the focus mode selector on the front of the camera. There are two *autofocus* (AF) modes, in which the camera focuses automatically when the shutter-release button is pressed halfway, and one *manual* focus mode, in which focus must be adjusted manually using the focusing ring on the lens:

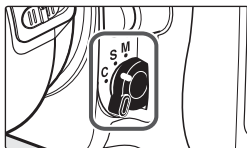

Option	Description
S Single-servo AF	Camera focuses when shutter-release button is pressed halfway. Focus locks when in-focus indicator (●) appears in viewfinder, and remains locked while shutter-release button is pressed halfway (<i>focus lock</i>). At default settings, shutter can only be released when in-focus indicator is displayed (<i>focus priority</i>).
C Continuous-servo AF	Camera focuses continuously while shutter-release button is pressed halfway. If subject moves, focus will be adjusted to compensate (<i>predictive focus tracking</i> ;  52). At default settings, photographs can be taken whether or not camera is in focus (<i>release priority</i>).
M Manual	Camera does not focus automatically; focus must be adjusted manually using the lens focusing ring. If maximum aperture of lens is f/5.6 or faster, viewfinder focus indicator can be used to confirm focus (<i>electronic range finding</i>), but photographs can be taken at any time, whether or not camera is in focus.

Choose single-servo AF when photographing stationary subjects. Continuous-servo AF may be a better choice with erratically-moving subjects. Manual focus is recommended when the camera is unable to focus using autofocus.



The AF-ON Button

For the purpose of focusing the camera, pressing the **AF-ON** button has the same effect as pressing the shutter-release button halfway.



Predictive Focus Tracking

In continuous-servo AF, the camera will automatically initiate predictive focus tracking if the subject moves while the shutter-release button is pressed halfway or the **AF-ON** button is pressed. In predictive focus tracking, the camera will track focus while attempting to predict where the subject will be when the shutter is released.

a1—AF-C Mode Priority (📖 148)

If **Focus** is selected for Custom Setting a1 (**AF-C Mode Priority**), photographs can be taken in continuous servo-AF only when the camera is in focus. Note that regardless of the setting selected, focus will not lock when the in-focus indicator is displayed.

a2—AF-S Mode Priority (📖 148)

If **Release** is selected for Custom Setting a2 (**AF-S Mode Priority**), photographs can be taken in single servo-AF even when the camera is not in focus. Note that regardless of the setting selected, focus will lock when the in-focus indicator is displayed.



a5—Lock-On (📖 150)

This option controls whether the camera immediately adjusts focus to track a subject when the distance to the subject changes drastically.

a6—AF Activation (📖 151)

If **AF-ON Only** is selected for Custom Setting a6 (**AF Activation**), the camera will only focus when the **AF-ON** button is pressed, not when the shutter-release button is pressed halfway.

Focus Area Selection

At default settings, the D200 offers a choice of eleven focus areas that together cover a wide area of the frame. The focus area can be selected manually, allowing photographs to be composed the main subject positioned almost anywhere in the frame, or automatically to ensure that the subject closest to the camera is always in focus regardless of where it is the frame (closest-subject priority;  54). Group dynamic-AF can be used to focus on the closest subject in a selected area of the frame ( 54).

To select the focus area, rotate the focus selector lock to the “●” position. The multi selector can then be used to select the focus area.

To select the center focus area (or focus area group) at any time, press the center of the multi selector.

The focus selector lock can be rotated to the “L” (locked) position following selection to prevent the selected focus area from changing when the multi selector is pressed.

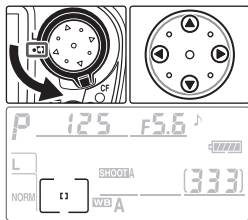

Focus Area Selection

The focus area can not be changed when the exposure meters are off, during playback, or while menus are displayed.

a3—Focus Area Frame (148)

In single-area () and dynamic-area AF () , select **Wide Frame (7 Areas)** to choose from seven wide focus areas instead of the normal eleven ( 55–56).

a7—AF Area Illumination (151)

Depending on the option selected for Custom Setting a7 (**AF Area Illumination**), the active focus area will be highlighted briefly in red to improve contrast as needed (“Vari-Brite” focus areas), highlighted at all times, or never highlighted.

a8—Focus Area (151)

This option can be used to set focus area selection to “wrap around.”

f1—Center Button > Shooting Mode (168)

Depending on the option selected for **Center Button > Shooting Mode** (Custom Setting f1), pressing the center of the multi selector will have no effect or will illuminate the selected focus area.

AF-Area Mode

AF-area mode determines how the focus area is selected in autofocus mode. To select the AF-area mode, rotate the AF-area mode selector. The selected mode is shown by an icon in the control panel (see below).

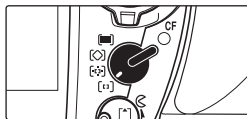

Mode	Icon	Description
Single-area AF		User selects focus area using multi selector; camera focuses on subject in selected focus area only. Use for relatively static compositions with subjects that will stay in selected focus area.
Dynamic-area AF		User selects focus area manually, but camera uses information from multiple focus areas to determine focus. If subject leaves selected focus area even briefly, camera will focus based on information from other focus areas (focus area selected in viewfinder does not change). Use with continuous-servo AF to follow erratically moving subjects and in other situations in which it is difficult to keep subject in selected focus area.
Group dynamic-AF		User chooses focus area group (see right). Camera focuses on center of selected group; if subject leaves focus area even briefly, camera focuses based on information from other focus areas in same group. Use when subject is moving erratically but place of subject in overall composition is known. Custom Setting a4 (149) can be used to change how focus areas are grouped or to focus on closest subject in selected group.
Dynamic-area AF with closest subject priority		Camera automatically selects focus area containing subject closest to camera. Prevents out-of-focus shots when photographing erratically moving subjects. Focus area can not be selected manually and is not displayed in viewfinder or control panel.

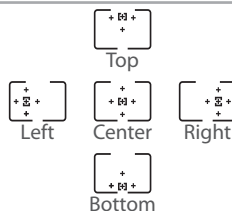

Manual Focus

Single-area AF is automatically selected when manual focus is used.

The Control Panel

The selected focus area or group of focus areas is shown in the control panel in single-area AF, dynamic-area AF, and group dynamic-AF. The illustrations in the "Icon" column show the display when the center focus area or focus area group is selected. The control panel display does not show the focus area selected by the camera for dynamic-area AF with closest subject priority.

Focus Zone Selection

When (single-area AF) or (dynamic-area AF) is selected for AF-area mode (54), the user can select from normal or wide focus areas (only normal focus areas are available when group dynamic-area or closest subject priority AF is selected for AF-area mode).

Option	Description
Normal Frame (11 Areas) (default)	User can select from eleven focus areas; camera focuses on selected focus area. Use to focus on specific areas of subject.
Wide Frame (7 Areas)	User can select from seven focus areas each covering wide area of frame, making it easier to position subject in focus area and reducing time needed to frame photographs. May produce unpredictable results if focus area contains multiple subjects.

Focus areas are displayed in the control panel and viewfinder as follows:

	Control panel		Viewfinder
	Single-area AF	Dynamic-area AF	
Normal Frame (11 Areas)			
Wide Frame (7 Areas)			

To choose focus zone size using Custom Setting a3 (**Focus Area Frame**), display the Custom Settings menu and follow the steps below.

- Highlight **Autofocus**.
- Display options.
- Highlight **a3 Focus Area Frame**.
- Display options.

5

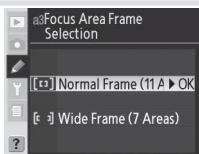

Highlight option.

6

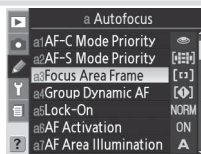

Make selection.

To choose focus zone size using the FUNC. button and sub-command dial:

1

Select **Focus Area Frame** for Custom Setting f4 (**FUNC. Button:** 170).



2

Press the FUNC. button and rotate the sub-command dial. Wide focus zones are used when **WIDE** is displayed in the control panel.

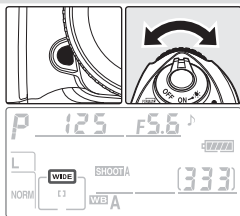

Focus Lock

Focus lock can be used to change the composition after focusing, making it possible to focus on a subject that will not be in a focus area in the final composition. It can also be used when the autofocus system is unable to focus (59).

In single-servo AF, focus locks automatically when the in-focus indicator (●) appears in the viewfinder. In continuous-servo AF, focus must be locked manually using the **AE-L/AF-L** button. To recompose a photograph using focus lock:

1

Position the subject in the selected focus area and press the shutter-release button halfway to initiate focus.



- 2** Check that the in-focus indicator (●) appears in the viewfinder.

Single-servo AF

Focus will lock automatically when the in-focus indicator appears, and remain locked until you remove your finger from the shutter-release button. Focus can also be locked by pressing the **AE-L/AF-L** button (see below).



Continuous-servo AF

Press the **AE-L/AF-L** button to lock both focus and exposure. Focus will remain locked while the **AE-L/AF-L** button is pressed, even if you later remove your finger from the shutter-release button.

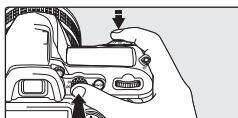

- 3** Recompose the photograph and shoot.

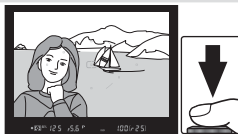

In single-servo AF, focus will remain locked between shots as long as the shutter-release button is kept pressed halfway, allowing several photographs in succession to be taken at the same focus setting. Focus will also remain locked between shots while the **AE-L/AF-L** button is pressed.

Do not change the distance between the camera and the subject while focus lock is in effect. If the subject moves, focus again at the new distance.

c2—AE-L/AF-L **156**

This option controls whether the **AE-L/AF-L** button locks focus and exposure (the default setting), focus only, or exposure only.

The AF-Assist Illuminator

The built-in AF assist illuminator enables the camera to focus even when the subject is poorly lit. The camera must be in focus mode **S** (single-servo autofocus), an AF-Nikkor lens must be attached, and the center focus area or focus area group must be selected or closest subject priority in effect. If these conditions are met and the subject is poorly lit, the illuminator will light automatically to assist the autofocus operation when the shutter-release button is pressed halfway.

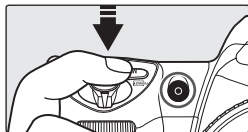

For the AF-assist illuminator to function correctly, the lens must have a focal length of 24–200 mm and the subject must be in range of the illuminator. Lens hoods should be removed. With most lenses, the illuminator has a range of about 0.5–3 m (1 ft. 8 in.–9 ft. 10 in.). With the following lenses, autofocus with AF-assist illumination is not available at ranges under 0.7 m (2 ft. 4 in.):

- AF Micro ED 200 mm f/4D
- AF-S VR ED 24–120 mm f/3.5–5.6G
- AF-S ED 28–70 mm f/2.8D
- AF Micro ED 70–180 mm f/4.5–5.6D

With the following lens, AF assist is not available at ranges under 1 m (3 ft. 3 in.):

- AF-S DX ED 55–200 mm f/4–5.6G

With the following lenses, AF assist is not available at ranges under 1.5 m (4 ft. 11 in.):

- AF-S VR ED 70–200 mm f/2.8G
- AF-S ED 80–200 mm f/2.8D
- AF ED 80–200 mm f/2.8D

With the following lens, AF assist is not available at ranges under 2.5 m (8 ft. 2 in.):

- AF VR ED 80–400 mm f/4.5–5.6D

AF assist is not available with the AF-S VR ED 200–400 mm f/4G.

Continuous Use of the AF-Assist Illuminator

After the AF-assist illuminator has been used for several consecutive shots, it may turn off briefly to protect the lamp. The illuminator can be used again after a short pause. Note that the illuminator may become hot with continuous use.

a9—AF Assist (152)

This option can be used to turn AF-assist illumination off.



Under the conditions described above, the optional SB-800 and SB-600 Speedlights and SU-800 wireless Speedlight commander will provide active AF illumination for the following focus areas:

AF lens focal length	Normal frame (11 areas)	Wide frame (7 areas)
23–34 mm		
35–70 mm		
71–105 mm		

With other Speedlights, the camera AF assist illuminator will be used.

Getting Good Results with Autofocus

Autofocus does not perform well under the conditions listed below. The shutter release may be disabled if the camera is unable to focus under these conditions, or the in-focus indicator (●) may be displayed and the camera may sound a beep, allowing the shutter to be released even when the subject is not in focus. In these cases, use manual focus (B 60) or use focus lock (B 56) to focus on another subject at the same distance and then recompose the photograph.

There is little or no contrast between the subject and the background

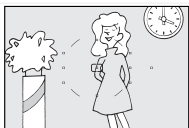

Example: subject is the same color as the background.

The focus area contains objects at different distances from the camera



Example: subject is inside a cage.

The subject is dominated by regular geometric patterns

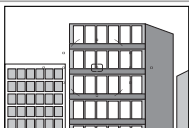

Example: a row of windows in a skyscraper.

The focus area contains areas of sharply contrasting brightness

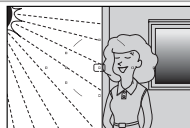

Example: subject is half in the shade.

The subject appears smaller than the focus area



Example: focus area contains both foreground subject and distant buildings.

The subject many contains fine details

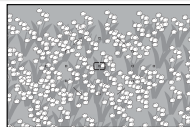

Example: a field of flowers or other subjects that are small or lack variation in brightness.

Manual Focus

Manual focus is available for lenses that do not support autofocus (non-AF Nikkor lenses) or when autofocus does not produce the desired results (📷 59). To focus manually, set the focus-mode selector to **M** and adjust the lens focusing ring until the image displayed on the clear matte field in the viewfinder is in focus. Photographs can be taken at any time, even when the image is not in focus.

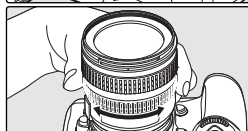

The Electronic Range Finder

If the lens has a maximum aperture of $f/5.6$ or faster, the viewfinder focus indicator can be used to confirm whether the portion of the subject in the selected focus area is in focus. After positioning the subject in the active focus area, press the shutter-release button halfway and rotate the lens focusing ring until the in-focus indicator (●) is displayed. Note that if the subject is one for which autofocus does not perform well (📷 59), the in-focus indicator may be displayed when the subject is not in focus. Confirm that the image in the viewfinder is in focus before shooting.

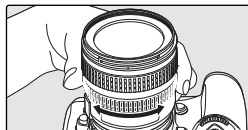

Focal Plane Position

To determine the distance between your subject and the camera, measure from the focal plane mark on the camera body. The distance between the lens mounting flange and the focal plane is 46.5 mm (1.83 in.).





🔧 A-M Selection/Autofocus with Manual Priority

When using a lens that offers A-M selection, select M when focusing manually. With lenses that support M/A (autofocus with manual priority), focus can be adjusted manually with the lens set to M or M/A. See the documentation provided with your lens for details.

Exposure

Metering

The metering method determines how the camera sets exposure:

Method	Description
 3D color matrix II/ Color matrix II/ Color matrix	1,005-pixel RGB sensor sets exposure based on variety of information from all areas of frame. With type G or D lens, camera uses <i>3D color matrix metering II</i> for natural results even when frame is dominated by bright (white or yellow) or dark (black or dark green) colors. With other CPU lenses, 3D range information is not included; instead, camera uses <i>color matrix metering II</i> . <i>Color matrix metering</i> is available when focal length and maximum aperture of non-CPU lens are specified using Non-CPU lens data item in shooting menu (📷 93; center-weighted metering is used if focal length or aperture is not specified). Matrix metering will not produce desired results with autoexposure lock (📷 70) or exposure compensation (📷 72), but is recommended in most other situations.
 Center-weighted	Camera meters entire frame but assigns greatest weight to area in center of frame 8 mm (0.31 in.) in diameter, shown by corresponding 8-mm reference circle in viewfinder. Classic meter for portraits; recommended when using filters with an exposure factor (filter factor) over $1 \times$ (📷 181).*
 Spot	Camera meters circle 3 mm (0.12 in.) in diameter (approximately 2.0% of frame). Circle is centered on current focus area (in group dynamic AF, on center focus area of current group; 📷 54), making it possible to meter off-center subjects (if non-CPU lens is used or if dynamic-area AF with closest subject priority is in effect, camera will meter center focus area). Ensures that subject will be correctly exposed, even when background is much brighter or darker.*

* For improved precision with non-CPU lenses, specify lens focal length and maximum aperture in **Non-CPU lens data** menu (📷 93).

Before shooting, rotate the metering selector to choose a method suited to the composition and lighting conditions, and confirm your selection in the viewfinder.

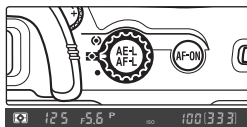

b6—Center Weight (📷 155)

This option controls the size of the area assigned the greatest weight in center-weighted metering.

b7—Fine Tune Exposure (📷 156)

Optimal exposure can be fine-tuned separately for each metering method (note that the exposure compensation icon is not displayed when exposure is fine-tuned).

Exposure Mode

Exposure mode determines how the camera sets shutter speed and aperture when adjusting exposure. Four modes are available: programmed auto (**P**), shutter-priority auto (**S**), aperture-priority auto (**A**), and manual (**M**).



Depth-of-Field Preview

To preview the effects of aperture, press and hold the depth-of-field preview button. The lens will be stopped down to the aperture value selected by the camera (modes **P** and **S**) or the value chosen by the user (modes **A** and **M**), allowing depth of field to be previewed in the viewfinder (the built-in flash and optional SB-800, SB-600, and SB-R200 Speedlights will emit a modeling flash).

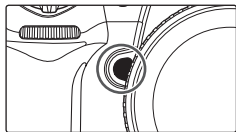

CPU Lenses

When using a CPU lens equipped with an aperture ring, lock the aperture ring at the minimum aperture (highest f/-number). At other settings, the shutter release will be disabled and a blinking **fE E** will appear in the aperture displays in the control panel and viewfinder. Type G lenses are not equipped with an aperture ring.

b1—ISO Auto (152)

When Custom Setting b1 (**ISO Auto**) is on, the camera automatically varies ISO sensitivity between ISO 100 and a maximum selected by the user to help ensure optimum exposure and flash level. In exposure modes **P** and **A**, the camera adjusts ISO sensitivity when the shutter speed needed to obtain optimum exposure would be faster than $1/8000$ s or slower than a specified value. Otherwise the camera adjusts ISO sensitivity when the limits of the camera exposure metering system are exceeded (mode **S**) or when optimum exposure can not be achieved at the shutter-speed and aperture selected by the user (mode **M**).

e4—Modeling Flash (166)

If **Off** is selected for Custom Setting e4 (**Modeling Flash**), the built-in flash and optional SB-800, SB-600, and SB-R200 Nikon Speedlights will not emit a modeling flash when the depth-of-field preview button is pressed.

P: Programmed Auto

In this mode, the camera automatically adjusts shutter speed and aperture according to a built-in program (📷 195) for optimal exposure in most situations. This mode is recommended for snapshots and other situations in which you want to leave the camera in charge of shutter speed and aperture. Adjustments can be made using flexible program, exposure compensation (📷 72), and auto exposure bracketing (📷 73). Programmed auto is only available with CPU lenses.

To take photographs in programmed auto:

- 1 Press the **MODE** button and rotate the main command dial until **P** is displayed in the viewfinder and control panel.

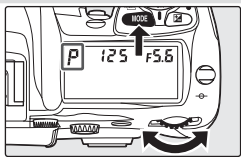

- 2 Frame a photograph, focus, and shoot.

Flexible Program

In mode **P**, different combinations of shutter speed and aperture can be selected by rotating the main command dial (“flexible program”). All combinations produce the same exposure. While flexible program is in effect, an asterisk (“*”) appears next to the exposure-mode indicator in the control panel. To restore default shutter speed and aperture settings, rotate the main command dial until the indicator is no longer displayed. Default settings can also be restored by turning the camera off, selecting another exposure mode, performing a two-button reset (📷 97), or choosing another setting for Custom Setting b3 (**EV Step**; 📷 154).



🔧 Non-CPU Lenses

Exposure mode **A** (aperture-priority auto) is automatically selected when a non-CPU lens is attached. The exposure mode indicator (**P**) will blink in the control panel and **A** will be displayed in the viewfinder. For more information, see “Aperture-Priority Auto” (📷 66).

🔧 Exposure Warning

If the limits of the exposure metering system are exceeded, one of the following indicators will be displayed in the control panel and viewfinder:

Indicator	Description
H i	Subject too bright. Use optional Neutral Density (ND) filter or lower ISO sensitivity (📷 33).
L o	Subject too dark. Use flash or raise ISO sensitivity (📷 33).



S: Shutter-Priority Auto

In shutter-priority auto, you choose the shutter speed while the camera automatically selects the aperture that will produce the optimal exposure. Shutter speed can be set to values between 30 s and $\frac{1}{8,000}$ s. Use slow shutter speeds to suggest motion by blurring moving objects, high shutter speeds to “freeze” motion. Shutter-priority auto is only available with CPU lenses.

To take photographs in shutter-priority auto:

- 1 Press the **MODE** button and rotate the main command dial until **S** is displayed in the viewfinder and control panel.

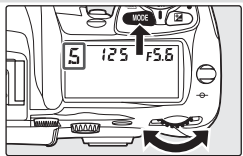

- 2 Rotate the main command dial to choose the desired shutter speed.

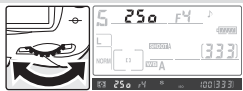

- 3 Frame a photograph, focus, and shoot.

Non-CPU Lenses





Exposure mode **A** (aperture-priority auto) is automatically selected when a non-CPU lens is attached. The exposure mode indicator (**S**) will blink in the control panel and **A** will be displayed in the viewfinder.

Changing from Mode M to Mode S

If you select a shutter speed of **b**, **w**, **l**, or **b** in mode **M** and then select mode **S** without changing the shutter speed, the shutter-speed display will flash and the shutter can not be released. Rotate the main command dial to select a different shutter speed before shooting.

Exposure Warning

If the camera is unable to produce the correct exposure at the selected shutter speed, the electronic analog exposure display ( 69) in the viewfinder will show the amount of under- or over-exposure and one of the following indicators will be displayed in the control panel and viewfinder aperture displays:

Indicator	Description
	Subject too bright. Choose faster shutter speed or lower ISO sensitivity ( 33), or use optional Neutral Density (ND) filter.
	Subject too dark. Choose slower shutter speed or higher ISO sensitivity ( 33), or use flash.

Long Exp. NR (131)

To reduce noise at slow shutter speeds, select **On** for the **Long Exp. NR** option in the shooting menu. Check that the battery is fully charged before making long time exposures.

b3—EV Step (154)

This option controls whether changes to shutter speed and aperture are made in increments equivalent to $\frac{1}{3}$ EV (the default setting), $\frac{1}{2}$ EV, or 1 EV.

f5—Command Dials > Change Main/Sub (170)

This option can be used to reverse the roles of the command dials so that the sub-command dial controls shutter speed, while the main command dial controls aperture.



A: Aperture-Priority Auto

In aperture-priority auto, you choose the aperture while the camera automatically selects the shutter speed that will produce the optimal exposure. Small apertures (high f /-numbers) increase depth of field, bringing both the main subject and background into focus. Large apertures (low f /-numbers) soften background details and let more light into the camera, increasing the range of the flash and making photographs less susceptible to blurring.

To take photographs in aperture-priority auto:

- 1 Press the **MODE** button and rotate the main command dial until **A** is displayed in the viewfinder and control panel.

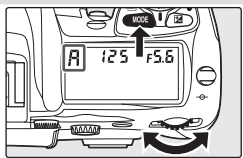

- 2 Rotate the sub-command dial to choose the desired aperture.



- 3 Frame a photograph, focus, and shoot.

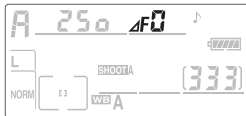

Non-CPU Lenses

If the maximum aperture of the lens has been specified using the **Non-CPU Lens Data** item in shooting menu (M 93) when a non-CPU lens is attached, the current f/-number will be displayed in the control panel and viewfinder, rounded to the nearest full stop. Otherwise the aperture displays will show only the number of stops (ΔF), with maximum aperture displayed as ΔF0 and the f/-number must be read from the lens aperture ring.



Exposure Warning

If the camera is unable to produce the correct exposure at the selected aperture, the electronic analog exposure display (M 69) in the viewfinder will show the amount of under- or over-exposure and one of the following indicators will be displayed in the control panel and viewfinder shutter-speed displays:

Indicator	Description
	Subject too bright. Choose smaller aperture (larger f/-number) or ISO sensitivity (M 33), or use optional Neutral Density (ND) filter.
	Subject too dark. Choose larger aperture (smaller f/-number) or higher ISO sensitivity (M 33), or use optional Speedlight.

b3—EV Step (M 154)

This option controls whether changes to shutter speed and aperture are made in increments equivalent to 1/3 EV (the default setting), 1/2 EV, or 1 EV.

f5—Command Dials (M 170)

Command Dials > Change Main/Sub and **Command Dials > Aperture Setting** control whether aperture is assigned with the main command dial, the sub-command dial, or the lens aperture ring. Regardless of the settings chosen, the sub-command dial is always used with type G lenses, the lens aperture ring with non-CPU lenses.



M: Manual

In manual exposure mode, you control both shutter speed and aperture. Shutter speed can be set to values between 30s and $1/8,000$ s, or the shutter can be held open for indefinitely for longer exposures (**bulb**). Aperture can be set to values between the minimum and maximum values for the lens. Using the electronic analog exposure display in the viewfinder, you can adjust exposure according to shooting conditions and the task at hand.

To take photographs in manual exposure mode:

- 1 Press the **MODE** button and rotate the main command dial until **M** is displayed in the viewfinder and control panel.

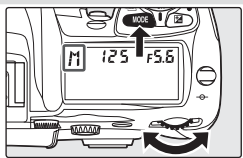

- 2 Rotate the main command dial to choose a shutter speed, and the sub-command dial to set aperture. Check exposure in the electronic analog exposure displays (see right), and continue to adjust shutter speed and aperture until the desired exposure is achieved.

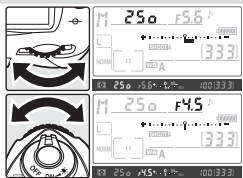

- 3 Frame a photograph, focus, and shoot.

bulb

At a shutter speed of **bulb**, the shutter will remain open while the shutter-release button is held down. Nikon recommends using a fully-charged EN-EL3e battery or an optional EH-6 AC adapter to prevent loss of power while the shutter is open. If the battery is exhausted during shooting, the camera will record the photograph to the memory card and then turn off automatically.

Electronic Analog Exposure Displays

At shutter speeds other than **b**, **1/3**, **1/2**, the electronic analog exposure displays in the control panel and viewfinder show whether the photograph would be under- or over-exposed at current settings. Depending on the option chosen for Custom Setting b3 (**EV Step**), the amount of under- or over-exposure is shown in increments of 1/3 EV, 1/2 EV, or 1 EV. If the limits of the exposure metering system are exceeded, the displays will flash.

"EV step" set to "1/3 step"		"EV step" set to "1/2 step"		"EV step" set to "1 step"	
Control panel	Viewfinder	Control panel	Viewfinder	Control panel	Viewfinder
Optimal exposure					
Underexposed by 1/3 EV		Underexposed by 1/2 EV		Underexposed by 1 EV	
Overexposed by more than 3 EV*					

* At 1/3 step, appears in the viewfinder when overexposure exceeds 2 EV.

AF Micro Nikkor Lenses

Provided that an external exposure meter is used, the exposure ratio need only be taken into account when the lens aperture ring is used to set aperture.

Non-CPU Lenses

If the maximum aperture of the lens has been specified using the **Non-CPU lens data** item in shooting menu (93) when a non-CPU lens is attached, the current f/number will be displayed in the viewfinder and control panel, rounded to the nearest full stop. Otherwise the aperture displays will show only the number of stops (**ΔF**, with maximum aperture displayed as **ΔF1**) and the f/number must be read from the lens aperture ring.

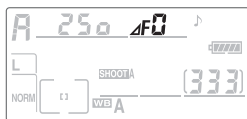

Long Exp. NR (131)

To reduce noise at slow shutter speeds, select **On** for the **Long Exp. NR** option in the shooting menu.

b3—EV Step (154)

This option controls whether changes to shutter speed and aperture are made in increments equivalent to 1/3 EV (the default setting), 1/2 EV, or 1 EV.

f5—Command Dials (170)

Command Dials > Change Main/Sub and **Command Dials > Aperture setting** control whether aperture is assigned with the main command dial, the sub-command dial, or the lens aperture ring. Regardless of the settings chosen, the sub-command dial is always used with type G lenses, the lens aperture ring with non-CPU lenses.



Autoexposure Lock

When center-weighted metering is used, an area in the center of the frame is assigned the greatest weight when determining exposure. Similarly, when spot metering is used, exposure is based upon lighting conditions in the selected focus area. If the subject is not in the metered area when the picture is taken, exposure will be based on lighting conditions in the background, and the main subject may be under- or over-exposed. To prevent this, use autoexposure lock:

- 1 Select exposure mode **P**, **S**, or **A** and choose center-weighted or spot metering (exposure lock has no effect in exposure mode **M**). If using center-weighted metering, select the center focus area with the multi selector (53).

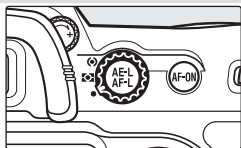

- 2 Position the subject in the selected focus area and press the shutter-release button halfway. With the shutter-release button pressed halfway and the subject positioned in the focus area, press the **AE-L/AF-L** button to lock exposure (and focus, except in manual focus mode). Confirm that the in-focus indicator (●) appears in the viewfinder.



While exposure lock is in effect, an **AE-L** indicator will appear in the viewfinder.

- 3 Keeping the **AE-L/AF-L** button pressed, recompose the photograph and shoot.

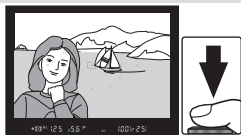



Adjusting Shutter Speed and Aperture

While exposure lock is in effect, the following settings can be changed without altering the metered value for exposure:

Exposure mode	Settings
Programmed auto	Shutter speed and aperture (flexible program; 63)
Shutter-priority auto	Shutter speed
Aperture-priority auto	Aperture

The new values can be confirmed in the viewfinder and control panel. Note that the metering method can not be changed while exposure lock is in effect (changes to metering take effect when the lock is released).

Metered Area

In spot metering, exposure will be locked at the value metered in a 3-mm (0.12 in.) circle centered on the selected focus area. In center-weighted metering, exposure will be locked at the value metered in an 8-mm (0.31 in.) circle at the center of the viewfinder.

c1—AE Lock (156)

If **+Release Button** is selected for **AE Lock**, exposure will lock when the shutter-release button is pressed halfway.

c2—AE-L/AF-L (156)

Depending on the option selected, the **AE-L/AF-L** button locks both focus and exposure (the default setting), only focus, or only exposure. Options are available for keeping exposure locked until the **AE-L/AF-L** button is pressed a second time, the shutter is released, or exposure meters turn off.

Exposure Compensation

To obtain the desired results with certain subject compositions, it may be necessary to use exposure compensation to alter exposure from the value suggested by the camera. As a rule of thumb, positive compensation may be needed when the main subject is darker than the background, negative values when the main subject is brighter than the background.

- 1 Pressing the button, rotate the main command dial and confirm exposure compensation in the control panel or the viewfinder (in the viewfinder, positive values are shown by a icon, negative values by a icon). Exposure compensation can be set to values between -5 EV (underexposure) and $+5$ EV (overexposure) in increments of $\frac{1}{3}$ EV.

At values other than ± 0 , the 0 at the center of the electronic analog exposure displays will flash and a icon will be displayed in the control panel and viewfinder after you release the button. The current value for exposure compensation can be confirmed in the electronic analog exposure display or by pressing the button.

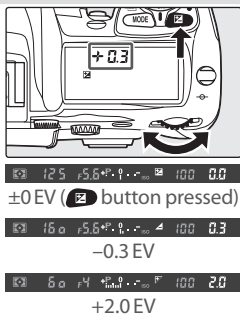

- 2 Frame the photograph, focus, and shoot.

Normal exposure can be restored by setting exposure compensation to ± 0 or performing a two button reset (97). Exposure compensation is not reset when the camera is turned off.

b4—Exp Comp/Fine Tune (154)

Use this option to set the increments for exposure compensation to $\frac{1}{2}$ or 1EV.

b5—Exposure Comp. (155)



If desired, exposure compensation can be set without pressing the button.

Exposure and Flash Bracketing

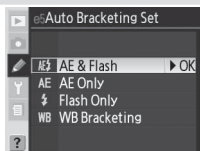

In exposure bracketing, the camera varies exposure compensation with each shot, while in the case of flash bracketing, flash level is varied with each shot (i-TTL and, with the optional SB-800 Speedlight, auto aperture flash control modes only). Only one photograph is produced each time the shutter is released, meaning that several shots (up to nine) are required to complete the bracketing sequence. Exposure and flash bracketing are recommended in situations in which it is difficult to set exposure and there is not enough time to check results and adjust settings with each shot.

- 1 Select the type of bracketing to be performed using Custom Setting e5 (**Auto BKT Set**;  166). Choose **AE & Flash** to vary both exposure and flash level (the default setting), **AE Only** to vary only exposure, or **Flash Only** to vary only flash level.

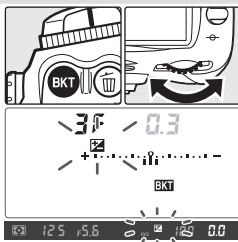

- 2 Pressing the  button, rotate the main command dial to choose the number of shots in the bracketing sequence ( 198–199). At settings other than zero, a **BKT** icon and bracketing indicator will be displayed in the control panel and the  icon will blink in the control panel and viewfinder.



- 3 Pressing the  button, rotate the sub-command dial to choose the exposure increment ( 198–199).

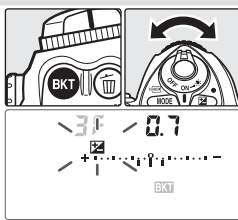

Bracketing Programs

See the Appendix for a list of exposure and flash bracketing programs.

e8—Auto BKT Selection (167)

If desired, the main command dial can be used to turn bracketing on and off and the sub-command dial to select both the number of shots and the exposure increment.

- 4** Compose a photograph, focus, and shoot. The camera will vary exposure and/or flash level shot-by-shot according to the bracketing program selected. Modifications to exposure are added to those made with exposure compensation (👁️ 72), making it possible to achieve exposure compensation values of more than 5 EV.

While bracketing is in effect, a bracketing progress indicator will be displayed in the control panel. A segment will disappear from the indicator after each shot.

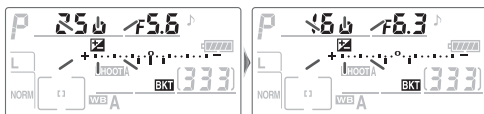

To cancel bracketing, press the **BKT** button and rotate the main command dial until the number of shots in the bracketing sequence is zero and **BKT** is no longer displayed in the control panel. The program last in effect will be restored the next time bracketing is activated. Bracketing can also be cancelled by performing a two-button reset (👁️ 97), although in this case the bracketing program will not be restored the next time bracketing is activated. Selecting **WB Bracketing** for Custom Setting e5 cancels the current the bracketing program.





Exposure Bracketing

The camera modifies exposure by varying shutter speed and aperture (programmed auto), aperture (shutter-priority auto), or shutter speed (aperture-priority auto, manual exposure mode). When **On** is selected for Custom Setting b1 (**ISO Auto**), the camera will automatically vary ISO sensitivity for optimum exposure when the limits of the camera exposure system are exceeded. If Custom Setting e5 (**Auto BKT Set**) is set **AE Only** or to **AE & Flash** and **On** is selected for Custom Setting b1 (**ISO Auto**), the camera will vary ISO sensitivity without varying shutter speed or aperture, regardless of the setting chosen for Custom Setting e6 (see below).

Shooting Mode

In single frame and self-timer modes, one shot will be taken each time the shutter-release button is pressed. In continuous low speed and continuous high speed modes, shooting will pause after the number of shots specified in the bracketing program have been taken. Shooting will resume the next time the shutter-release button is pressed.

Resuming Exposure or Flash Bracketing

If the memory card fills before all shots in the sequence have been taken, shooting can be resumed from the next shot in the sequence after the memory card has been replaced or shots have been deleted to make room on the memory card. If the camera is turned off before all shots in the sequence have been taken, bracketing will resume from the next shot in the sequence when the camera is turned on.

e6—Manual Mode Bkting 167

This option controls how the camera performs exposure and flash bracketing in manual exposure mode. Bracketing can be performed by varying flash level together with shutter speed and/or aperture, or by varying flash level alone.

e7—Auto BKT Order 167

This option can be used to change the bracketing order.

Flash Photography

Using the Built-in Flash

The D200 is equipped with a Guide Number 12/39 flash (ISO 100, m/ft) that can be used not only when natural lighting is inadequate, but also to fill in shadows and backlit subjects or to add a catch light to the subject's eyes.

The built-in flash supports the following types of flash control:

i-TTL Balanced Fill-Flash for Digital SLR: Speedlight emits series of nearly invisible preflashes (monitor preflashes) immediately before main flash. Preflashes reflected from objects in all areas of frame are picked up by 1,005-pixel RGB sensor and are analyzed in combination with information from matrix metering system to adjust flash output for natural balance between main subject and ambient background lighting. If type G or D lens is used, distance information is included when calculating flash output. Precision of calculation can be increased for non-CPU lenses by providing lens data (focal length and maximum aperture;  93–95). Not available when spot metering is used.

Standard i-TTL Flash for Digital SLR: Flash output adjusted to bring lighting in frame to standard level; brightness of background is not taken into account. Recommended for shots in which main subject is emphasized at expense of background details, or when exposure compensation is used. Standard i-TTL flash for digital SLR is activated automatically when spot metering is selected.

ISO Sensitivity

i-TTL flash control can adjust for ISO sensitivities between 100 and 1600. It may not be able to adjust flash level appropriately for ISO sensitivities over 1600. When **On** is selected for Custom Setting b1 (**ISO Auto**;  152), ISO sensitivity will automatically be adjusted as required for optimal flash output. This may result in foreground subjects being underexposed in flash photographs taken at slow shutter speeds, in daylight, or against a bright background. In these cases, choose a flash mode other than slow sync or select mode **A** or **M** and choose a larger aperture.

Using the Built-in Flash

If the built-in flash is used in continuous shooting mode, only one photograph will be taken each time the shutter-release button is pressed.

Vibration reduction (available with VR lenses) does not take effect if the shutter-release button is pressed halfway while the built-in flash is recharging.

After the built-in flash has been used for several consecutive shots, it may turn off briefly to protect the flash. The built-in flash can be used again after a short pause.







Flash Angle

The flash angle of the built-in flash can cover the field of view of an 18 mm lens. It may not be able to light the entire subject with some lenses or apertures ( 201).



Flash Sync Modes

The camera supports the following flash sync modes:

Flash sync mode	Description
 Front-curtain sync	Recommended for most situations. In programmed auto and aperture-priority auto modes, shutter speed will automatically be set to values between $\frac{1}{60}$ and $\frac{1}{250}$ s ($\frac{1}{60}$ to $\frac{1}{8,000}$ s when using optional Speedlight with Auto FP High-Speed Sync;  160).
 Red-eye reduction	Red-eye reduction pre-flash lights for approximately one second before main flash. Pupils in subject's eyes to contract, reducing "red-eye" effect sometimes caused by flash.
 Red-eye reduction with slow sync	Combines red-eye reduction with slow sync. This mode is only available in programmed auto and aperture-priority auto exposure modes. Use of a tripod is recommended to prevent blurring caused by camera shake.
 Slow sync	Flash is combined with speeds as slow as 30 s to capture both subject and background at night or under dim light. This mode is only available in programmed auto and aperture-priority auto exposure modes. Use of tripod is recommended to prevent blurring caused by camera shake.
 Rear-curtain sync	In shutter-priority auto or manual exposure mode, flash fires just before the shutter closes, creating effect of a stream of light behind moving objects. In programmed auto and aperture-priority auto, slow rear-curtain sync is used to capture both subject and background. Use of tripod is recommended to prevent blurring caused by camera shake.

Red-Eye Reduction

Some lenses may block the red-eye reduction lamp, preventing the subject from seeing the lamp and interfering with red-eye reduction.

Studio Flash Systems

Rear-curtain sync can not be used with studio flash systems, as the correct synchronization can not be obtained.

Compatible Lenses

See the Appendix for information on the lenses that can be used with the built-in flash.

e3—Built-in Flash (161)

Flash mode can be selected from **TTL**, **Manual**, **Repeating Flash**, and **Commander mode**. When fired at full power in **Manual** mode, the built-in flash has a Guide Number of 13/42 (ISO 100, m/ft). In **Repeating Flash** mode, the flash fires repeatedly while the shutter is open. The flash output, number of flashes, and interval between flashes can be selected from a menu. **Commander mode** can be used for wireless off-camera flash photography with optional SB-800, SB-600, or SB-R200 Speedlights.

Using the Built-in Flash

To use the built-in flash:

- 1 Choose a metering method (👁️ 61). Select matrix or center-weighted metering to activate i-TTL Balanced Fill-Flash for Digital SLR. Standard i-TTL Flash for Digital SLR is activated automatically when spot metering is selected.

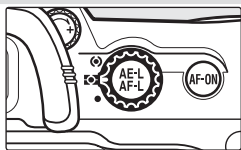

- 2 Press the flash pop-up button. The built-in flash will pop up and begin charging. When the flash is fully charged, the flash-ready indicator will light.

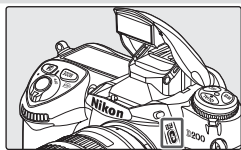

- 3 Press the **Q** button and rotate the main command dial until the desired flash sync icon is displayed in the control panel.

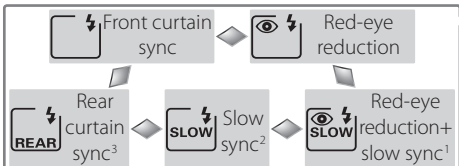

- 1 Only available in exposure modes **P** and **A**. 📷 (red-eye reduction) is selected in modes **S** and **M**.
- 2 Only available in exposure modes **P** and **A**. 📷 (front-curtain sync) is selected in modes **S** and **M**.
- 3 In exposure modes **P** and **A**, flash-sync mode will be set to 📷 (slow rear-curtain sync) when the **Q** button is released.



When the Speedlight Is Not in Use

To save battery power when the Speedlight is not in use, return it to the closed position by pressing it lightly downward until the latch clicks into place.



- 4** Press the shutter-release button halfway and check exposure (shutter speed and aperture). The shutter speeds and apertures available when the built-in flash is raised are listed below.

Exposure mode	Shutter speed	Aperture	
P	Set automatically by camera ($1/250$ – $1/60$ s) ¹	Set automatically	63
S	Value selected by user ($1/250$ – 30 s) ²	by camera	64
A	Set automatically by camera ($1/250$ – $1/60$ s) ¹	Value selected by	66
M	Value selected by user ($1/250$ – 30 s) ²	user ³	68

1 Limit for slow shutter speed is set using Custom Setting e2 (**Flash Shutter Speed**; 161). Regardless of option selected, camera may set shutter to speeds as slow as 30 s at flash sync settings of slow sync, slow rear-curtain sync, and slow sync with red-eye reduction.

2 Speeds faster than $1/250$ s will be reduced to $1/250$ s when built-in flash is raised or optional Speedlight is attached and turned on.

3 Flash range varies with ISO sensitivity and aperture. Consult table of flash of flash ranges (200) when setting aperture in **A** and **M** modes.

- 5** Check that the flash-ready indicator appears in the viewfinder. If the flash-ready indicator is not displayed when the built-in flash is used, the shutter release will be disabled.



- 6** Compose the photograph, making sure that the subject is within range of the flash (200), then focus and shoot. If the flash-ready light blinks for about three seconds after the photograph is taken, the flash has fired at full output and the photograph may be underexposed. Check the results in the monitor. If the photograph is underexposed, adjust settings and try again.

e1—Flash Sync Speed (160)



This option can be used to enable Auto FP High-Speed Sync (optional SB-800, SB-600, or SB-R200 Speedlight required; not available if built-in flash is fired) or to limit the fastest sync speed to a speed slower than $1/250$ s. To fix shutter speed at the sync speed limit in exposure modes **S** and **M**, select the setting after the slowest possible shutter speed (30 s or **bulb**). An X will be displayed in the flash sync indicator in the control panel.



Flash Exposure Compensation

Flash exposure compensation can be used to increase or reduce flash output from the level chosen by the camera's flash control system. Flash output can be increased to make the main subject appear brighter, or reduced to prevent unwanted highlights or reflections. As a rule of thumb, positive compensation may be needed when the main subject is darker than the background, negative compensation when the main subject is brighter than the background.

Pressing the  button, rotate the sub-command dial and confirm flash exposure compensation in the control panel or viewfinder. Flash exposure compensation can be set to values between -3 EV (darker) and $+1$ EV (brighter) in increments of $\frac{1}{3}$ EV.

At values other than ± 0 , a  icon will be displayed in the control panel and viewfinder after you release the  button. The current value for flash exposure compensation can be confirmed by pressing the  button.

Normal flash output can be restored by setting flash exposure compensation to ± 0.0 or performing a two button reset ( 97). Flash exposure compensation is not reset when the camera is turned off.

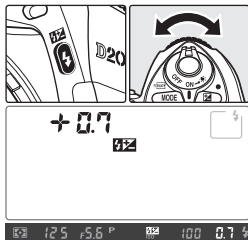

Using Flash Exposure Compensation with Optional Speedlights

Flash exposure compensation is also available when an optional SB-800 or SB-600 Speedlight is attached.

Modeling Illumination

The built-in flash and optional SB-800, SB-600, and SB-R200 Speedlights emit a modeling flash when the camera depth-of-field preview button is pressed. Modeling illumination can be turned off using Custom Setting e4 (**Modeling Flash**;  166).

b3—EV Step (154)

This option can be used to set the increments for flash compensation to $\frac{1}{2}$ or 1 EV.

FV Lock

This feature is used to lock flash output, allowing photographs to be recomposed without changing the flash level. This ensures that flash output is appropriate to the subject even when the subject is not positioned in the center of the frame. Flash output is adjusted automatically for any changes in ISO sensitivity or aperture. To use FV lock:

- 1 Select **FV Lock** or **FV Lock/Lens Data** for Custom Setting f4 (**FUNC. Button**;  170).



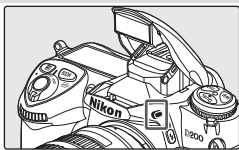

- 2 Press the flash pop-up button to raise the flash.

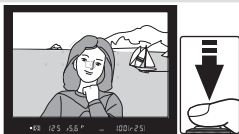

- 3 Position the subject in the center of the frame and press the shutter-release button halfway to focus.



- 4 Press the FUNC. button. The flash will emit a monitor preflash to determine the appropriate flash level. Flash output will be locked at this level and FV lock icons ( LOCK and ) will appear in the control panel and viewfinder.

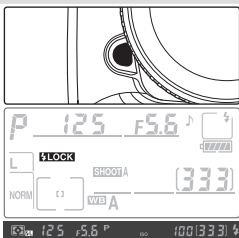

- 5 Recompose the photograph.





- 6** Press the shutter-release button the rest of the way down to shoot. If desired, additional pictures can be taken without releasing FV lock.



- 7** Press the camera FUNC. button to release FV lock and confirm that the FV lock icons (LOCK and FL) are no longer displayed in the control panel and viewfinder.

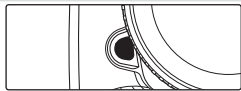

Using FV Lock with Optional Speedlights

FV lock is also available with SB-800, SB-600, and SB-R200 Speedlights (available separately). Set the Speedlight to TTL mode (the SB-800 can also be used in AA mode; see the Speedlight manual for details). While FV lock is in effect, flash output will automatically be adjusted for changes in Speedlight zoom head position.

When **Commander Mode** is selected for Custom Setting e3 (**Built-in Flash**; 161), FV lock can be used with remote SB-800, SB-600, or SB-R200 flash units if (a) any of the built-in flash, flash group A, or flash group B is in TTL mode, or (b) a flash group is composed entirely of SB-800 Speedlights in TTL or AA mode.

Using FV Lock with the Built-in Flash

When the built-in flash is used alone, FV lock is only available if **TTL** (the default setting) is selected for Custom Setting e3 (**Built-in Flash**; 161).



Self-Timer Mode

The self-timer can be used to reduce camera shake or for self-portraits.

1 Mount the camera on a tripod (recommended) or place the camera on a stable, level surface.

2 Press the shooting mode dial lock release and rotate the shooting mode dial to select  (self-timer mode).



3 Frame the photograph and focus. If autofocus is in effect, be sure not to block the lens when activating the self-timer. In single-servo autofocus ( 51), photographs can only be taken if the in-focus () indicator appears in the viewfinder.



Close the Viewfinder Eyepiece Shutter

In exposure modes other than manual, remove the viewfinder eyepiece cup and insert the supplied DK-5 eyepiece cap as shown. This prevents light entering via the viewfinder from interfering with exposure.

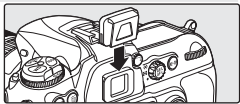

4 Press the shutter-release button all the way down to start the self-timer. The self-timer lamp (AF-assist lamp) will start to blink and a beep will begin to sound. Two seconds before the photograph is taken, the self-timer lamp will stop blinking and the beeping will become more rapid.

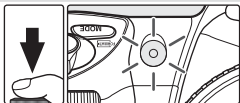

The Built-in Flash

The self-timer will be cancelled if the built-in flash is raised before the picture is taken. To start the timer after raising the flash, wait until the flash-ready indicator is displayed in the viewfinder and then press the shutter-release button.

To turn the self-timer off before a photograph is taken, press the mode dial lock release and turn the mode dial to another setting.

bulb

In self-timer mode, a shutter speed of **bulb** is equivalent to approximately $\frac{1}{3}$ s.

c4—Self-Timer (157)

Self-timer delay can be set to 2 s, 5 s, 10 s (the default setting), or 20 s.

Image Overlay and Multiple Exposure

The following options are available for combining multiple exposures in a single frame:

- **Image overlay:** two existing RAW photographs are combined to form a single picture which is saved separately from the originals. The originals must be on the same memory card.
- **Multiple exposure:** a series of two to ten exposures is recorded as a single photograph. The individual exposures are not saved separately.

Image Overlay

Overlays are created using the **Image Overlay** option in the shooting menu.

1 The new picture is saved at current image quality and size settings. Before creating an overlay, set image quality and size (📷 28).

2 Highlight **Image Overlay** in the shooting menu (📷 124) and press the multi selector to the right.

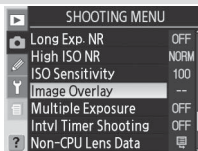

A preview will be displayed with **Image 1** highlighted.



3 Press the **ENTER** button to view the RAW images on the memory card. Press the multi selector left or right to highlight images. To zoom in on the highlighted image, press and hold the **⏏** button.

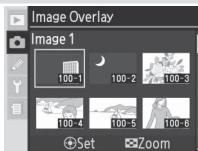

4 Press the center of the multi selector to select the highlighted image and return to the preview display. The selected image will appear as **Image 1**.

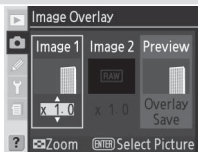

- 5** Press the multi selector up or down to select a value for gain between 0.1 and 2.0. The default value is 1.0; selecting 0.5 cuts gain in half, while selecting 2.0 doubles gain. The effects of gain are visible in the preview image.

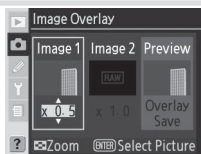

- 6** Press the multi selector left or right to highlight **Image 2**. Repeat steps 3–5 to select the second image and adjust gain.

- 7** Press the multi selector left or right to highlight **Overlay** and press the **ENTER** button to display a confirmation dialog (to save the new image without displaying the confirmation dialog, highlight **Save** and press the **ENTER** button). Press the **ENTER** button to save the new image, or the **DISCARD** button to return to the preview dialog.

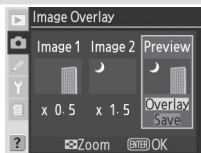

Selecting Photographs for Image Overlay

Only RAW photographs taken with the D200 can be selected for image overlay. Other images are not displayed in the thumbnail list. Hidden images are not displayed and can not be selected.

Image Overlay

The new image is recorded at current image quality, image size, and file name settings under a file name assigned by adding one to the largest file number in the current folder. White balance, sharpening, color space, color mode, and hue settings are copied from the photograph selected for **Image 1**, as are the date of recording, metering, shutter speed, aperture, exposure mode, exposure compensation, focal length, orientation, and other photo information.

Multiple Exposure

To create a multiple exposure:

- 1 Highlight **Multiple exposure** in the shooting menu (124) and press the multi selector to the right.

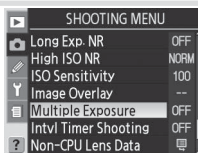

- 2 Press the multi selector up or down to highlight **Number of Shots** and press the multi selector to the right.

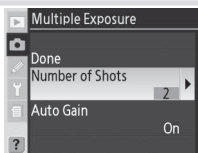

- 3 Press the multi selector up or down to choose the number of exposures that will be combined to form a single photograph. Press the multi selector to the right to return to the multiple exposure menu.

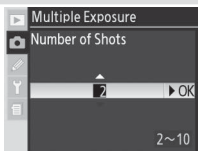

- 4 Press the multi selector up or down to highlight **Auto Gain** and press the multi selector to the right.

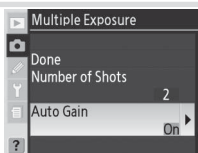

- 5 Press the multi selector up or down to highlight one of the following options and then press the multi selector to the right.

Option	Description
On (default)	Gain adjusted according to number of exposures actually recorded (gain for each exposure is set to $\frac{1}{2}$ for 2 exposures, $\frac{1}{3}$ for 3 exposures, etc.).
Off	Gain is not adjusted when recording multiple exposure.

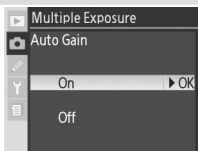

- 6 Press the multi selector up or down to highlight **Done** and press the multi selector to the right.

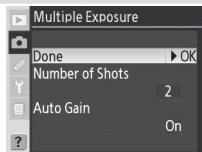

A  icon will be displayed in the control panel.



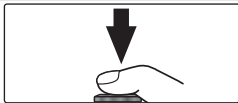

- 7 Frame a photograph, focus, and shoot. In continuous high-speed or continuous low-speed mode ( 26), the camera will record all exposures in a single burst. In single-frame shooting mode, one photograph will be taken each time the shutter-release button is pressed; continue shooting until all exposures have been recorded. Shooting will end automatically if:

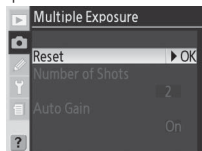

- No operations are performed for 30 s during shooting, or for 30 s after the monitor has turned off during playback or menu operations
- The user selects **Reset** or **Cancel** in the multiple exposure menu and presses the multi selector to the right
- The camera is turned off
- The battery is exhausted
- Pictures are deleted



If shooting ends before the specified number of exposures have been taken, a multiple exposure will be created from the exposures that have been recorded to that point. If **Auto Gain** is on, gain will be adjusted to reflect the number of exposures actually recorded. To end shooting without creating a multiple exposure, press the  button while turning the camera off.

The  icon will blink until shooting ends. When shooting ends, multiple exposure mode will end and the  icon will no longer be displayed. Repeat steps 1–7 to take additional multiple exposures.



Exchanging Memory Cards

Do not remove or replace the memory card while recording a multiple exposure.

Photo Info

The information listed in the playback photo information display (including date of recording and camera orientation) is for the first shot in the multiple exposure.



Auto Meter Off

Unless **No Limit** is selected for Custom Setting c3 (**Auto Meter-Off**;  157) or the camera is powered by an optional EH-6 AC adapter, shooting will end and a multiple exposure will be recorded if no operations are performed for 30s. To prevent the exposure meters from turning off before the 30s limit has expired, 30s are added to the auto meter-off delay when shooting starts. The existing meter-off delay is restored when shooting ends.

White Balance (35)

If **Auto** is selected for white balance, white balance will be fixed at a value suitable for direct sunlight while multiple exposure mode is in effect. Only use **Auto** if the subject is in direct sunlight.

Interval Timer Photography

If interval timer photography is activated before the first exposure is taken, the camera will record exposures at the selected interval until the number of exposures specified in the multiple exposure menu have been taken (the number of shots listed in the interval timer shooting menu is ignored). These exposures will then be recorded as a single photograph and multiple exposure mode and interval timer shooting will end. Note that unless **No Limit** is selected for Custom Setting c3 (**Auto Meter-Off**;  157) or the camera is powered by an optional EH-6 AC adapter, shooting will end automatically if no operations are performed for 30s; when recording a multiple exposure using the interval timer, choose an interval of less than 30s, select **No Limit** for Custom Setting c3 (**Auto Meter-Off**;  157), or use an AC adapter. Cancelling multiple exposure cancels interval timer shooting.

Bracketing and Other Settings

Bracketing is cancelled when multiple exposure is selected and can not be restored until shooting has ended. While multiple exposure mode is in effect, memory cards can not be formatted and the following can not be changed: shooting menu options other than **Intvl Timer Shooting** (**Intvl Timer Shooting** can only be adjusted before the first exposure is taken), **Dust Off Ref Photo**, and **Mirror Lock-up**.

Two Button Reset (97)

Multiple exposure settings are not affected when a two-button reset is performed. Performing a two-button reset does not cancel multiple exposure mode.

Interval Timer Photography

The D200 is equipped to take photographs automatically at preset intervals.

- 1 Highlight **Intvl timer shooting** in the shooting menu (📷 124) and press the multi selector to the right.

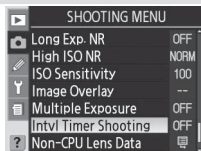

- 2 Press the multi selector up or down to choose one of the following **Start** options:

- **Now**: Shooting begins after a delay of about 3 s
- **Start time**: Shooting begins at **Start time**

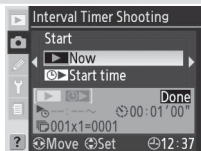

- 3 Press the multi selector left or right to highlight the following options and press the multi selector up or down to change interval timer settings.

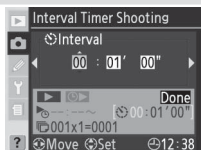

Option	Description
Start time	Enter start time for interval timer photography when Start time is selected for Start . Press multi selector left or right to highlight starting hour or minute, press up or down to change. Not available when Now is selected for Start .
Interval	Enter time between shots. Press multi selector left or right to highlight hour, minute, or second, press up or down to change. Note that camera will not be able to take photographs at specified interval if interval is shorter than shutter speed or time required to record images.
Select Intvl*Shots	Choose number of intervals and number of shots taken at each interval. Press multi selector left or right to highlight number of intervals or number of shots, press up or down to change. Total number of shots that will be taken appears to right.
Remaining (intvl*shots)	Shows number of intervals and total shots remaining in current interval program. This item can not be edited.
Start	Choose Off to adjust settings without starting interval timer. To start interval timer, select On and press OK . Shooting will start at selected start time and will continue for specified number of intervals.

- 4** Highlight **Start** at the bottom of the interval timer menu and press the multi selector up or down to select **On**, then press the **INFO** button. The first series of shots will be taken at the specified starting time. Shooting will continue at the selected interval until all shots have been taken. If shooting can not proceed at current settings (for example, if a shutter speed of **bu 1 b** is currently selected in manual exposure mode, or the starting time is less than one minute from the current time), a warning will appear and the interval timer menu will be displayed again.

Use of a tripod is recommended.

✓ **Take a Test Shot**

Before beginning interval timer photography, take a test shot at current settings and view the results in the monitor. Remember that the camera will focus before each shot—no shots will be taken if the camera is unable to focus in single-servo AF.

✎ **Use a Reliable Power Source**

To ensure that shooting is not interrupted, be sure the battery is fully charged. If in doubt, charge the battery before shooting or use an optional EH-6 AC adapter.

✎ **Check the Time**

Before choosing a starting time, select **World Time** in the setup menu and make sure that the camera clock is set to the correct time and date (12).

✎ **Out of Memory**

If the memory card is full, the interval timer will remain active but no pictures will be taken. Delete some pictures or turn the camera off and insert another memory card. When the camera is turned on, interval timer photography will be paused. See “Pausing Interval Timer Photography” on the following page for information on resuming interval timer photography.

✎ **Bracketing**

Adjust bracketing settings before starting interval timer photography. If exposure and/or flash bracketing is active while interval timer photography is in effect, the camera will take the number of shots in the bracketing program at each interval, regardless of the number of shots specified in the interval timer menu. If white balance bracketing is active while interval timer photography is in effect, the camera will take only one shot at each interval and process it to create the number of copies specified in the bracketing program.

✎ **The Eyepiece Cap**

In exposure modes other than manual, remove the viewfinder eyepiece cup and insert the supplied DK-5 eyepiece cap to prevent light entering via the viewfinder from interfering with exposure.

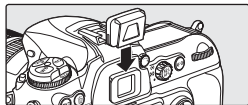

During Shooting

During interval timer photography, the **INTERVAL** icon in the control panel will blink. Immediately before the next shooting interval begins, the shutter speed display will show the number of intervals remaining, and the aperture display will show the number of shots remaining in the current interval. At other times, the number of intervals remaining and the number of shots in each interval can be viewed by pressing the shutter-release button halfway (once the button is released, the shutter speed and aperture will be displayed until the exposure meters turn off).

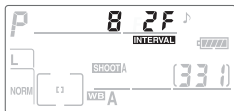

To view other interval timer settings while shooting is in progress, select **Intvl Timer Shooting** between shots. While interval timer photography is in progress, the interval timer menu will show the starting time, the shooting interval, the selected number of intervals and number of shots, and the number of intervals and shots remaining. None of these items can be changed while interval timer photography is in progress.

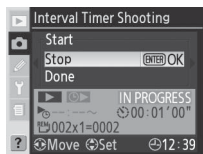

Pausing Interval Timer Photography

To pause interval timer photography:

- Press the **STOP** button between intervals.
- Highlight **Start** at the bottom of the interval timer menu and press the multi selector up or down until **Pause** is displayed, then press the **STOP** button
- Turn the camera off (if desired, the memory card can be replaced while the camera is off). Interval timer photography will be paused when the camera is turned on.

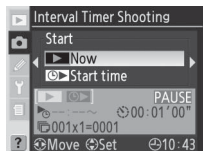

To resume shooting, choose a **Start** option as described in Step 2 (89). If **Start time** is selected, a new starting time can be chosen as described in Step 3; the interval, number of intervals, and number of shots can not be changed. Highlight **Start** at the bottom of the interval timer menu and press the multi selector up or down until **Restart** is displayed, then press the **STOP** button.



Interrupting Interval Timer Photography

To interrupt interval timer photography, highlight **Start** at the bottom of the interval timer menu and press the multi-selector up or down until **Done** is displayed, then press the  button.



Interval timer photography will also be interrupted if:

- A two-button reset is performed ( 97).
- **Menu Reset** is selected in the shooting menu ( 127).
- Bracketing settings are changed ( 73).
- The battery is exhausted.

Normal shooting will resume when interval timer photography ends.

During Shooting



Shooting and menu settings can be adjusted freely while interval timer photography is in progress. Note the following:

- Performing a two-button reset ( 97) or changing bracketing settings ( 73) will cancel interval timer photography.
- The monitor will turn off about four seconds before each interval.



Multiple Exposure

Interval timer shooting can be used to create a multiple exposure ( 86).

Shooting Mode

Regardless of the shooting mode selected, the camera will take the specified number of shots at each interval. In **CH** (continuous high speed) mode, photographs will be taken at a rate of five shots per second. In **S** (single frame), **CL** (continuous low-speed), and **Mup** (mirror up) modes, photographs will be taken at the rate chosen for Custom Setting d4 (**Shooting Speed**;  158). In  (self-timer) mode, the shutter-release delay applies to each photograph taken. In **Mup** mode, the mirror will be raised automatically immediately before each shot.

Shooting Menu Banks

Changes to interval timer settings apply to all shooting menu banks ( 125). If shooting menu settings are reset using the **Menu Reset** item in the shooting menu ( 127), interval timer settings will be reset as follows:

- Start time: **Now**
- Interval: 00:01 '00"
- Number of intervals: 1
- Number of shots: 1
- Start: **Off**

Non-CPU Lenses

By specifying lens data (lens focal length and maximum aperture), the user can gain access to a variety of CPU lens functions when using a non-CPU lens. If the focal length of the lens is known:

- Automatic power zoom can be used with optional SB-800 and SB-600 Speedlights
- Lens focal length is listed (with an asterisk) in the playback photo info display

When the maximum aperture of the lens is known:

- The aperture value is displayed in the control panel and viewfinder
- Flash level is adjusted for changes in aperture
- Aperture is listed (with an asterisk) in the playback photo info display

Specifying both the focal length and maximum aperture of the lens:

- Enables color matrix metering (note that it may be necessary to use center-weighted or spot metering to achieve accurate results with some lenses, including Reflex-Nikkor lenses)
- Improves the precision of center-weighted and spot metering and i-TTL Balanced Fill-Flash for Digital SLR

Specifying Lens Focal Length

Lens focal length can be specified using the **Non-CPU Lens Data** option in the shooting menu or by pressing the FUNC. button and rotating the main command dial. The following settings are available:

- 6–45 mm: 6, 8, 13, 15, 16, 18, 20, 24, 25, 28, 35, 43, and 45 mm
- 50–180 mm: 50, 55, 58, 70, 80, 85, 86, 100, 105, 135, and 180 mm
- 200–4000 mm: 200, 300, 360, 400, 500, 600, 800, 1000, 1200, 1400, 1600, 2000, 2400, 2800, 3200, and 4000 mm

The Non-CPU Lens Data Menu

- 1 Highlight **Non-CPU Lens Data** in the shooting menu (📷 124) and press the multi selector to the right.

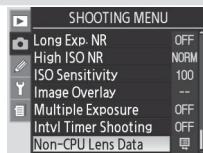

The FUNC. Button

Lower the built-in flash and turn any optional Speedlights off before using the FUNC. button to specify lens data.



- 2 Highlight **Focal Length** and press the multi selector to the right.

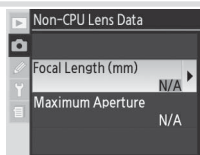

- 3 Select the group to which the lens belongs from **6-45, 50-180, 200-4000** and press the multi selector to the right.

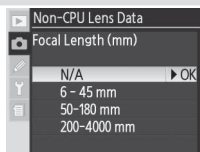

- 4 Select the lens focal length (in mm) and press the multi selector to the right.

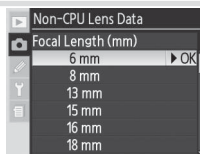

The FUNC. Button

- 1 Select **FV Lock/Lens Data** for Custom Setting f4 (**FUNC. Button**; 170).

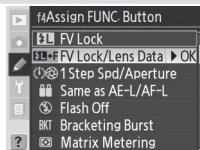

- 2 Press the FUNC. button and rotate the main command dial. Focal length is displayed in the control panel:



Focal Length Not Listed

If the correct focal length is not listed, choose the closest value greater than the actual focal length of the lens.

Default Maximum Aperture

Selecting a focal length sets **Maximum Aperture** to the last value selected at that focal length.

Specifying Maximum Aperture

Lens maximum aperture can be specified using the **Non-CPU Lens Data** option in the shooting menu or by pressing the FUNC. button and rotating the sub-command dial. The following f/-numbers are available:

- 1.2, 1.4, 1.8, 2, 2.5, 2.8, 3.3, 3.5, 4, 4.5, 5, 5.6, 6.3, 7.1, 8, 9.5, 11, 13, 15, 16, 19, 22

The Non-CPU Lens Data Menu

- 1 Highlight **Maximum Aperture** in the **Non-CPU Lens Data** menu and press the multi-selector to the right.

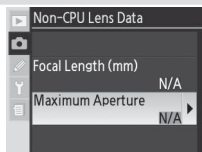

- 2 Select the f/-number corresponding to the maximum lens aperture and press the multi-selector to the right.

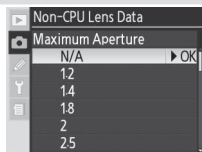

The FUNC. Button

- 1 Select **FV Lock/Lens Data** for Custom Setting f4 (**FUNC. Button**;  170).

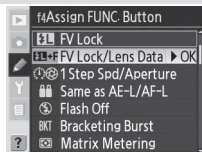

- 2 Press the FUNC. button and rotate the sub-command dial. Maximum aperture is displayed in the control panel:

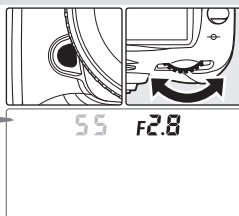





Zoom Lenses

Lens data are not adjusted when non-CPU lenses are zoomed in or out. After changing the zoom position, select new values for lens focal length and maximum aperture.

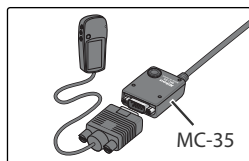
Using a GPS Unit

Garmin and Magellan GPS units that conform to version 2.01 or 3.01 of the National Marine Electronics Association NMEA0183 data format can be connected to the camera's ten-pin remote terminal using an MC-35 GPS adapter cord (available separately;  182), allowing information on the camera's current position to be recorded when photographs are taken. Operation has been confirmed with Garmin eTrex, Garmin geko, and Magellan SporTrack series devices equipped with a PC interface cable connector. These devices connect to the MC-35 using a cable with a D-sub 9-pin connector provided by the manufacturer of the GPS device. See the MC-35 instruction manual for details. Before turning the camera on, set the GPS device to NMEA mode (4800 baud).





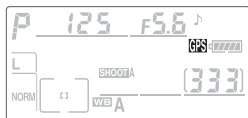

When the camera establishes communication with a GPS device, a  icon will be displayed in the control panel. The exposure meters will not turn off while this icon is displayed. Photo information for pictures taken while the  icon is displayed will include an additional page ( 100) recording the current latitude, longitude, altitude, and Coordinated Universal Time (UTC). If no data are received from the GPS unit for two seconds, the  icon will clear from the display and the camera will stop recording GPS information.



Coordinated Universal Time (UTC)

UTC data is provided by the GPS device and is independent of the camera clock.

GPS Data

GPS data are only recorded when the  icon is displayed. Confirm that the  icon is displayed in the control panel before shooting. A flashing  icon indicates that the GPS device is searching for a signal; pictures taken while the  icon is flashing will not include GPS data.

Two-Button Reset

The camera settings listed below can be restored to default values by holding the **QUAL** and  buttons down together for more than two seconds (these buttons are marked by a green dot). The control panels turn off briefly while settings are reset. Custom Settings are not affected.

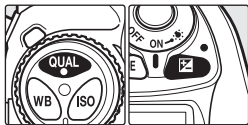

Option	Default
Focus area	Center*
Exposure mode	Programmed auto
Flexible program	Off
Exposure compensation	±0
AE hold	Off†

* If AF-area mode is set to group dynamic-AF, center group will be selected.

† Custom Setting c2 (**AE-L/AF-L**) is unaffected.

Option	Default
Bracketing	Off‡
Flash sync mode	Front-curtain sync
Flash exposure compensation	±0
FV lock	Off

‡ Number of shots is reset to zero. Bracketing increment is reset to 1 EV (exposure/flash bracketing) or 1 (white balance bracketing).

The following shooting-menu options will also be reset. Only settings in the bank currently selected using the **Shooting Menu Bank** option will be reset ( 125). Settings in the remaining banks are unaffected.

Option	Default
Image Quality	JPEG Normal
Image Size	Large

Option	Default
White Balance	Auto*
ISO Sensitivity	100

* Fine-tuning reset to 0.

Reset Shooting Menu (127)

Other shooting menu options for the current shooting menu bank can be reset by selecting **Yes** for the **Menu Reset** option in the shooting menu.

R—Menu Reset (147)

Custom Settings for the current custom settings bank can be restored to default values by selecting **Yes** for Custom Setting R (**Menu Reset**).



Reference: More on Playback

Viewing Photographs

Single-Image Playback

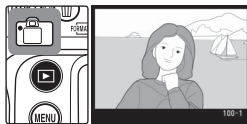
To play photographs back, press the  button. The most recent photograph will be displayed in the monitor.



To end playback and return to shooting mode, press the  button or press the shutter-release button halfway. To view camera menus ( 24), press the  button.

Using the Multi Selector

The multi selector can be used at any time when the monitor is on. The focus selector lock switch only takes effect when the monitor is off.

Image Review (141)

When **On** is selected for **Image review** in the playback menu, photographs are automatically displayed in the monitor as they are being recorded to the memory card. In single-frame, self-timer, and mirror-up modes, photographs are displayed one at a time as they are taken. In continuous shooting mode, display begins when shooting ends, with the first photograph in the current series displayed. Playback will be interrupted when the shutter-release button is pressed, and resume when the button is released after shooting.

Rotate Tall (142)

This playback menu option controls whether portrait-orientation photographs taken with **On** selected for the **Auto Image Rotation** option in the setup menu are automatically rotated during playback.



c5—Monitor-Off (157)

The monitor will turn off automatically to save power if no operations are performed for the time specified in Custom Setting c5 (**Monitor Off**). Press the  button again to return to playback mode.

Photo Information

Photo information is superimposed on images displayed in single-image playback. There are up to eight pages of information for each photo. Press the multi-selector down to cycle through photo information as follows: (Histogram), Basic Information, File Information, (Shooting Data Page 1), (Shooting Data Page 2), (GPS Data), (RGB Histogram), and (Highlights). Press the multi selector up to cycle through photo information in reverse order.

Basic Information

- | | |
|----------------------------|--|
| 1 Protect status 104 | 2 Folder number/frame number 135 |
|----------------------------|--|

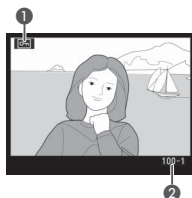

File Information

- | | |
|---|---|
| 1 Protect status 104 | 6 Date of recording 12 |
| 2 Focus brackets* 53 | 7 Time of recording 12 |
| 3 Frame number/total number of frames 135 | 8 File name 129 |
| 4 Folder name 135 | 9 Image size 32 |
| 5 Image quality 28 | 10 Folder number/frame number 135 |

* If **Focus Area** is selected for **Display Mode** in the playback menu (141), active focus area is highlighted in red (in photos taken using single-servo AF with dynamic-area AF, group dynamic-AF, or closest-subject priority, area where focus first locked is highlighted).

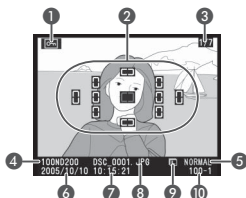

Shooting Data Page 1*

- | | |
|-----------------------------|---|
| 1 Protect status 104 | 7 Exposure compensation 72 |
| 2 Camera name | 8 Focal length 176 |
| 3 Metering method 61 | 9 Flash sync mode 77 |
| 4 Shutter speed 62–69 | 10 Folder number/frame number 135 |
| 5 Aperture 62 | |
| 6 Exposure mode 62 | |

* Displayed only if **Data** is selected for **Display mode** (141).

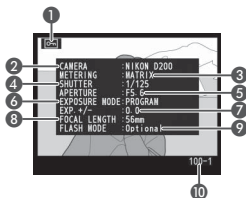

f3—Photo Info/Playback (169)

The roles of the multi selector buttons can be reversed, so that the left and right buttons display other images and the up and down buttons control photo information.

Shooting Data Page 2*

- | | | | | | |
|---|--------------------------|-----|----|----------------------|-----|
| 1 | Protect status | 104 | 7 | Color mode/ | |
| 2 | Image optimization | 45 | | Hue adjustment | 47 |
| 3 | ISO sensitivity† | 33 | 8 | Saturation | 48 |
| 4 | White balance/White | | 9 | Image comment | 118 |
| | balance adjustment | 35 | 10 | Folder number/frame | |
| 5 | Tone compensation | 47 | | number | 135 |
| 6 | Sharpening | 46 | | | |

* Displayed only if **Data** is selected for **Display mode** (141).

† Displayed in red if photo was taken with auto ISO on.

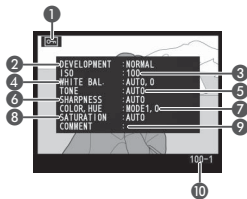

GPS Data*

- | | | | | | |
|---|----------------------|-----|---|-----------------------|-----|
| 1 | Protect status | 104 | 5 | Coordinated Universal | |
| 2 | Latitude† | | | Time (UTC) | |
| 3 | Longitude† | | 6 | Folder number/frame | |
| 4 | Altitude | | | number | 135 |

* Displayed only if GPS device was used when photo was taken (96).

† Items displayed may differ when photo is viewed on a computer.

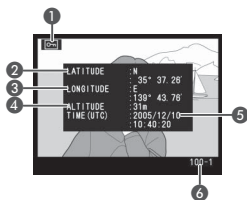

RGB Histogram*

- | | | | | | |
|---|-------------------------|-----|---|-----------------------------|--|
| 1 | Protect status | 104 | 4 | Histogram (RGB chan- | |
| 2 | Image highlights (areas | | | nel). In all histograms, | |
| | of image that may be | | | horizontal axis gives pixel | |
| | overexposed) are marked | | | brightness, vertical axis | |
| | by a flashing border† | | | number of pixels. | |
| 3 | Folder number/frame | | 5 | Histogram (red channel) | |
| | number | 135 | 6 | Histogram (green chan- | |
| | | | | nel) | |
| | | | 7 | Histogram (blue channel) | |
| | | | 8 | Current channel | |

* Displayed only if **RGB histogram** is selected for **Display mode** (141).

† Highlights can be displayed separately for each color channel. Press multi selector left or right while pressing  button to cycle through channels as follows: **RGB** (all channels) ↔ **R** (red) ↔ **G** (green) ↔ **B** (blue) ↔ highlight display off ↔ **RGB**.

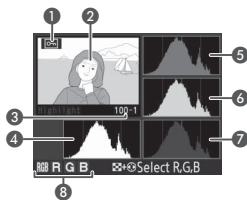

Histograms

Camera histograms may differ from those displayed in imaging applications.

Highlights*

- 1 Protect status 104
- 2 Image highlights (areas of image that may be overexposed) are marked by a flashing border†
- 3 Current channel
- 4 Folder number/frame number 135

* Displayed only if **Highlight** is selected for **Display mode** (▶ 141).

† Highlights can be displayed separately for each color channel. Press multi selector left or right while pressing  button to cycle through channels as follows: **RGB** (all channels) ↔ **R** (red) ↔ **G** (green) ↔ **B** (blue) ↔ **RGB**.

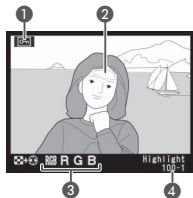
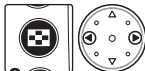

Histogram*

- 1 Protect status 104
- 2 Histogram showing the distribution of tones in the image. Horizontal axis corresponds to pixel brightness, vertical axis shows number of pixels of each brightness in image.
- 3 Folder number/frame number 135



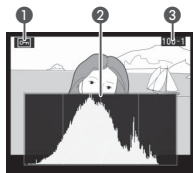





















* Displayed only if **Histogram** is selected for **Display mode** (▶ 141).



Viewing Multiple Images: Thumbnail Playback

To display images in “contact sheets” of four or nine images, press the  button and rotate the main command dial. The following operations can be performed while thumbnails are displayed:



To	Use	Description
Change number of images displayed	  	Press  button and rotate main command dial to change the number of images displayed as follows: single image ↔ four thumbnails ↔ nine thumbnails ↔ single image.
Toggle full frame playback		Press center of multi selector to switch back and forth between full frame and thumbnail playback.
Highlight photographs		Press multi selector up, right, left, or down to highlight thumbnails.
Page through photos	  	Press  button and rotate sub-command dial to scroll through photos a page at a time.
Delete photo		Confirmation dialog will be displayed. Press  again to delete photo. Press  button to exit without deleting photo.
Zoom in on highlighted photo	 (Q)	Press  for enlarged view of highlighted photo ( 103).
Protect photo		To protect image, or to remove protection from protected image, press  button ( 104).
Display menus		Press  button to display camera menus ( 24).
Return to shooting mode	Shutter-release/ 	To end playback and return to shooting mode, press  button or press shutter-release button halfway.

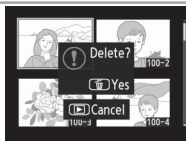





Image Review (141)

When **On** is selected for **Image Review** in the playback menu, photographs are automatically displayed in the monitor as they are being recorded to the memory card. In single-frame and self-timer modes, photographs are displayed one at a time as they are taken. In continuous shooting mode, display begins when shooting ends. Thumbnail playback is only available in continuous shooting mode.

Taking a Closer Look: Playback Zoom

Press the **ENTER** button to zoom in on the image displayed in single-image playback or on the image currently highlighted in thumbnail playback. The following operations can be performed while zoom is in effect:



To	Use	Description
Cancel/resume zoom		Press ENTER to cancel zoom and return to single-image or thumbnail playback. Press again to zoom image in.
Select area displayed		Press Multi-selector button to display frame showing area currently zoomed in. While Multi-selector button is pressed, multi selector can be used to move frame and main command dial can be used to control size of frame—rotate dial counterclockwise to zoom out, clockwise to zoom in to maximum of approximately 25x (large images), 19x (medium images), or 13x (small images). Release Multi-selector button to magnify selected area to fill monitor.
View other images		Rotate main command dial to view same area of other images at current zoom ratio.
View other areas of image		Use multi selector to view area not visible in monitor. Hold multi selector down to scroll rapidly to other areas of frame.

Using the Multi Selector

The multi selector can be used at any time when the monitor is on. The focus selector lock switch only takes effect when the monitor is off.



c5—Monitor-Off (🔧 157)

The monitor will turn off automatically to save power if no operations are performed for the time specified in Custom Setting c5 (**Monitor Off**). Press the **MONITOR** button again to return to playback mode.

f1—Center Button > Playback Mode (🔧 168)

Instead of toggling between full-frame and thumbnail playback, the center of the multi selector can be used to toggle playback zoom or display a histogram.

Protecting Photographs from Deletion

In full-frame, zoom, and thumbnail playback, the  button can be used to protect photographs from accidental deletion. Protected files can not be deleted using the  button or the **Delete** option in the playback menu, and have DOS “read-only” status when viewed on a Windows computer. Note that protected images *will* be deleted when the memory card is formatted.

To protect a photograph:

1 Display the image in full-frame playback or highlight it in the thumbnail list.

2 Press the  button. The photograph will be marked with a  icon.

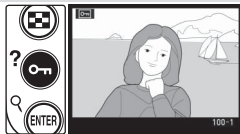

To remove protection from the photograph so that it can be deleted, display the photograph or highlight it in the thumbnail list and then press the  button.

Removing Protection from All Images

To remove protection from all images in the folder or folders currently selected in the **Playback Folder** menu, press the  and  buttons together for about two seconds.



Deleting Individual Photographs

To delete a photograph displayed in single-image or zoom playback, or the photograph highlighted in thumbnail playback, press the  button. Once deleted, photographs can not be recovered.

1 Display the image or highlight it in the thumbnail list.

2 Press the  button. A confirmation dialog will be displayed.



3 To delete the photograph, press the  button again. Press the  button to exit without deleting the photograph.

Protected and Hidden Images

Images marked with a  icon are protected and can not be deleted. Hidden images are not displayed in single-image or thumbnail playback and can not be selected for deletion.

Delete 133

To delete multiple images, use the **Delete** option in the playback menu.

After Delete 142

The **After Delete** option in the playback menu determines whether the next image or the previous image is displayed after an image is deleted.

Viewing Photographs on TV

The supplied EG-D100 video cable can be used to connect the camera to a television or VCR for playback or recording.

- 1 Select the appropriate video mode from the **Video Mode** menu (117).

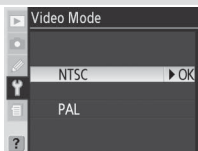

- 2 *Turn the camera off.* Always turn the camera off before connecting or disconnecting the video cable.



- 3 Open the cover protecting the video-out and DC-in connectors.

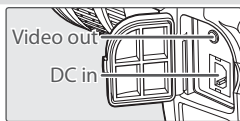

- 4 Connect the video cable as shown below.



Connect
to video
device

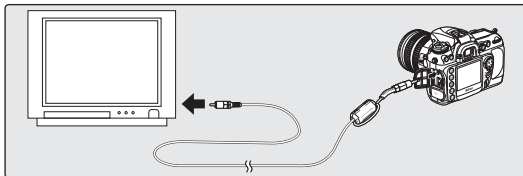

Connect
to
camera

- 5 Tune the television to the video channel.

- 6 Turn the camera on. During playback, images will be displayed on the television screen or recorded to video tape; the camera monitor will remain off. Note that the edges may not be visible when photographs are viewed on a television screen.

Use an AC Adapter

Use of an EH-6 AC adapter (available separately) is recommended for extended playback. When the EH-6 is connected, the camera monitor-off delay will be fixed at ten minutes and the exposure meters will no longer turn off automatically.

Connecting to a Computer

The supplied USB cable can be used to connect the camera to a computer. Once the camera is connected, the supplied software can be used to copy photographs to the computer, where they can be browsed, viewed, and retouched. The camera can also be used with Nikon Capture 4 Version 4.4 or later (available separately), which supports batch processing and more advanced image editing options and can be used to control the camera directly from the computer.

Before Connecting the Camera

Install the necessary software after reading the manuals and reviewing the system requirements. To ensure that data transfer is not interrupted, be sure the camera battery is fully charged. If in doubt, charge the battery before use or use an EH-6 AC adapter (available separately).

Before connecting the camera, set the USB option in the setup menu (121) according to the computer operating system and whether the camera is being controlled from Nikon Capture 4 Version 4.4 or later (available separately) or photographs are being transferred to the computer using the supplied software:



Operating system	Supplied software	Nikon Capture 4 Camera Control
Windows XP Home Edition Windows XP Professional Mac OS X	Choose PTP or Mass Storage	Choose PTP
Windows 2000 Professional Windows Millennium Edition (Me) Windows 98 Second Edition (SE) Mac OS 9	Choose Mass Storage *	
	Not supported	

* Do NOT select **PTP**. If **PTP** is selected when the camera is connected, the Windows hardware wizard will be displayed. Click **Cancel** to exit the wizard, and then disconnect the camera. Be sure to select **Mass Storage** before reconnecting the camera.

Connecting the USB Cable

1 Turn the computer on and wait for it to start up.

2 Turn the camera off.



3 Connect the UC-E4 USB cable as shown. Connect the camera directly to the computer; do not connect the cable via a USB hub or keyboard.

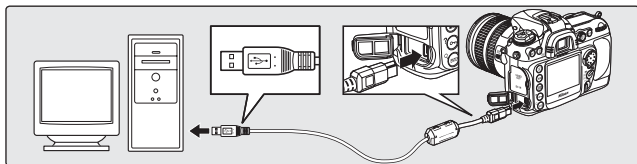

4 Turn the camera on. If **Mass Storage** is selected for **USB**, **PC** will be displayed in the control panel and viewfinder, and the PC mode indicator will flash (if **PTP** is selected, the camera displays will not change). Photographs can be transferred to the computer as described in the manual for the supplied software (on CD).



If Nikon Capture 4 Camera Control is running, the control panel will show **PC** in place of the number of exposures remaining. Any photographs taken will be recorded to the computer hard disk rather than the camera memory card. See *Nikon Capture 4 User's Manual* for more information.



During Transfer

Do not turn the camera off while transfer is in progress.

- 5 If **PTP** is selected for **USB** (🔌 121), the camera can be turned off and the USB cable disconnected once transfer is complete. If the **USB** option in the camera setup menu is still at its default setting of **Mass Storage**, the camera must first be removed from the system as described below.

Windows XP Home Edition/Windows XP Professional

Click the “Safely Remove Hardware” icon (🔌) in the taskbar and select **Safely remove USB Mass Storage Device** from the menu that appears.



Windows 2000 Professional

Click the “Unplug or Eject Hardware” icon (🔌) in the taskbar and select **Stop USB Mass Storage Device** from the menu that appears.



Windows Millennium Edition (Me)

Click the “Unplug or Eject Hardware” icon (🔌) in the taskbar and select **Stop USB Disk** from the menu that appears.



Windows 98 Second Edition (SE)

In My Computer, click with the right mouse button on the removable disk corresponding to the camera and select **Eject** from the menu that appears.

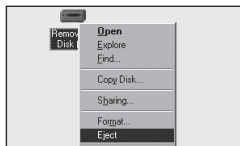

Macintosh

Drag the camera volume (“NIKON D200”) into the Trash.

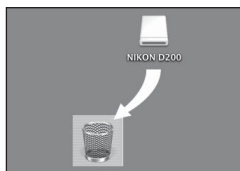

Printing Photographs

Photographs can be printed by any of the following methods:

- Connect the camera to a printer and print photographs directly from the camera (📷 111).
- Insert the memory card in a printer equipped with a card slot (see the printer manual for details). If the printer supports DPOF (📷 202), photographs can be selected for printing using **Print Set** (📷 139).
- Take the memory card to a developer or digital print center. If the center supports DPOF (📷 202), photographs can be selected for printing using **Print Set** (📷 139).
- Transfer the pictures using the supplied software and print them from a computer (see the software manual, on CD).

Note that RAW photographs can only be printed by transferring them to a computer and printing them using the supplied software or Nikon Capture 4 Version 4.4 or later (available separately).

Printing Via Direct USB Connection

When the camera is connected to a printer that supports PictBridge (📷 202), photographs can be printed directly from the camera.

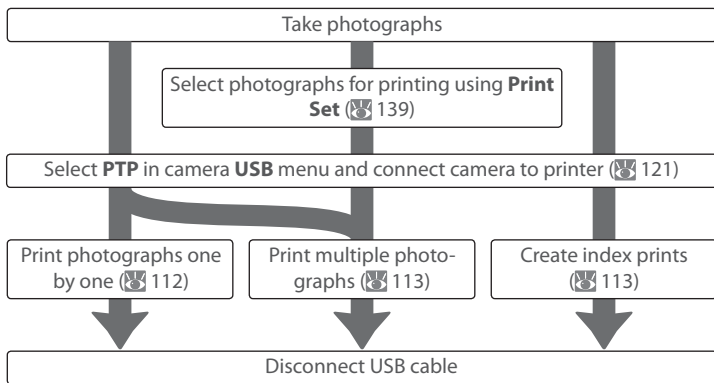

📷 Printing Via Direct USB Connection

Be sure the battery is fully charged or use an optional EH-6 AC adapter. When taking photographs to be printed without modification, choose **sRGB** for **Color Space**.

Connecting the Printer

- 1 Set the **USB** option in the setup menu to **PTP** (📷 121).

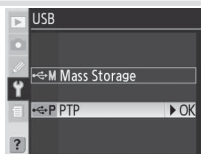

- 2 Turn the printer on.

- 3 Turn the camera off and connect the supplied USB cable as shown. Do not use force or attempt to insert the connectors at an angle. Connect the camera directly to the printer; do not connect the cable via a USB hub.

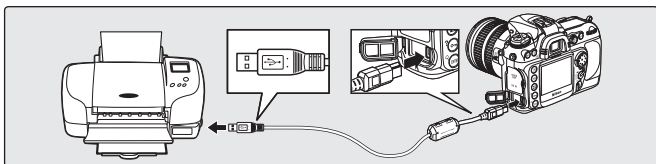

- 4 Turn the camera on. A welcome screen will be displayed, followed by the PictBridge playback display. Proceed to “Printing Photographs One at a Time” (📷 112) or “Printing Multiple Photographs” (📷 113).



Press the multi selector left or right to view additional photographs, or press and hold the **ENTER** button to zoom in on the current photo (📷 103). To view six photographs at a time, press the **⊗** button and rotate the main command dial. Use the multi selector to highlight photographs, or press the **⊗** button and rotate the main command dial to display the highlighted photograph full frame.

Printing Pictures One at a Time

To print the photograph selected in the PictBridge playback display, press and release the **ENTER** button. The menu shown at right will be displayed. Press the multi selector up or down to highlight an option and press to the right to select.

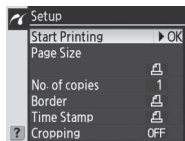

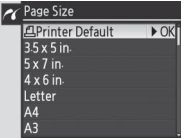
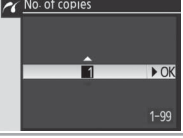
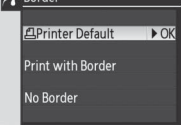
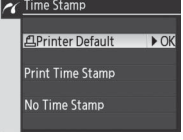
Option	Description
Start Printing	Print selected picture. To cancel and return to PictBridge playback display before all images have been printed, press ENTER button. PictBridge playback display will be shown when printing is complete. Print additional pictures as described above or turn camera off and disconnect USB cable.
Page Size	Press multi selector up or down to choose page size from Printer Default (default page size for current printer), 3.5 x 5 in. , 5 x 7 in. , Hagaki , 100 x 150 mm , 4 x 6 in. , 8 x 10 in. , Letter , A3 , or A4 , then press multi selector right to select and return to print menu. 
No. of copies	Menu shown at right will be displayed. Press multi selector up or down to choose number of copies (maximum 99), then press multi selector to right to select and return to print menu. 
Border	Menu shown at right will be displayed. Press multi selector up or down to highlight Printer Default (default setting for current printer), Print with Border (print photo with white border), or No Border , then press multi selector to right to select and return to print menu. 
Time Stamp	Menu shown at right will be displayed. Press multi selector up or down to highlight Printer Default (default setting for current printer), Print Time Stamp (print time and date of recording on photo), or No Time Stamp , then press multi selector to right to select and return to print menu. 

Page Size, Border, and Time Stamp

Choose **Printer Default** to print at current printer settings. Only options supported by the current printer can be selected.

Option	Description
Cropping	Menu shown at right will be displayed. Press multi selector up or down to highlight Crop (crop photo for printing) or No Cropping , then press multi selector to right.
	If Crop is selected, dialog shown at right will be displayed; rotate main command dial to choose size of crop and use multi selector to choose position of crop. Press EXIT to return to print menu. Note that quality may drop if small crop is printed at larger sizes.



Printing Multiple Pictures

To print multiple selected pictures or to create an index print listing all JPEG photographs as small thumbnail images, press the **MENU** button. The menu shown at right will be displayed. Press the multi selector up or down to highlight an option and press to the right to select.

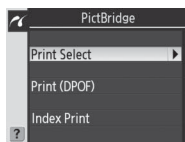

Option	Description
Print Select	Print selected pictures (114).
Print (DPOF)	Print current DPOF print order (139). Note that DPOF date and info options are not supported.
Index Print	Create index print of all JPEG photos (if memory card contains more than 256 photos, only 256 photos will be printed). Press EXIT button to display menu shown below at right; choose page size, border, and time stamp options as described on page 112 (warning will be displayed if selected page size is too small). To start printing, highlight Start Printing and press multi selector right. PictBridge menu will be displayed when printing is complete.

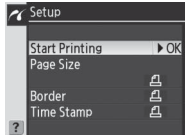

Printing Selected Photographs

Choosing **Print Select** in the PictBridge menu (see above) displays the menu shown in Step 1.

1

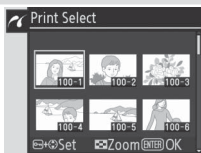

Scroll through pictures. To display current picture full screen, press **Set** button.*

2



Select current picture and set number of prints to 1. Selected pictures marked by **01** icon.

* To print photos in print order created with **Print Set** (139), select **Print (DPOF)** in PictBridge menu. Print order can be modified as described on this page.

3

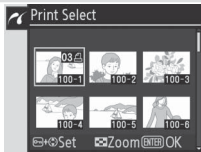

Specify number of prints (up to 99). To deselect picture, press multi selector down when number of prints is 1. Repeat steps 1–3 to select additional pictures.

4

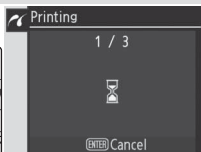
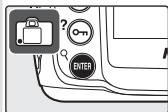

Display print options. Choose page size, border, and time stamp options as described on page 112. To print selected pictures, highlight **Start Printing** and press multi selector right. PictBridge menu will be displayed when printing is complete.

Using the Multi Selector

The multi selector can be used at any time when the monitor is on. The focus selector lock switch only takes effect when the monitor is off.

Error Messages

If the dialog shown at right is displayed, an error has occurred. After checking the printer and resolving any problems as directed in the printer manual, press the multi selector up or down to highlight **Continue** and press the multi selector to the right to resume printing. Select **Cancel** to exit without printing the remaining images.

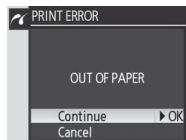

Selecting Photographs for Printing

NEF (RAW) photos are displayed in the Print Selected menu but can not be selected for printing.

Setup

Basic Camera Settings: The Setup Menu

The setup menu contains the following options. See “Using the Menus” (📖 24) for more information on using the menus.

Option	👁️
Format	116
LCD Brightness	116
Mirror Lock-up*	117
Video Mode	117
World Time	117
Language	118
Image Comment	118
Auto Image Rotation	119
Recent Settings	119
USB	121
Dust Off Ref Photo	121–122
Battery Info	123
Firmware Version	123

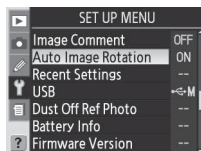

* Not available at battery levels of  or below or when camera is powered by optional MB-D200 battery pack equipped with AA batteries.

Using the Multi Selector

The multi selector can be used at any time when the monitor is on. The focus selector lock switch only takes effect when the monitor is off.

Format

Memory cards must be formatted before first use. Formatting memory cards is also an effective way of deleting all pictures on the card. Selecting **Format** displays the following options. Press the multi selector up or down to highlight an option and then press the **ENTER** button:

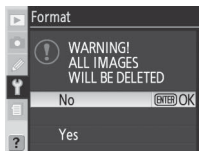

Option	Description
No	Exit without formatting memory card.
Yes	Format memory card. Message shown at right displayed while formatting is in progress. <i>Do not turn the camera off, remove the batteries or memory card, or unplug the AC adapter (available separately) until formatting is complete and setup menu is displayed.</i>

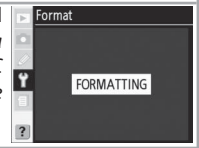

LCD Brightness

Press the multi selector up to increase brightness, down to decrease. The number to the right of the display indicates the current brightness level, with +2 the brightest setting and -2 the darkest. Press the multi selector to the right to complete the operation and return to the setup menu.



Before Formatting

Formatting memory cards permanently deletes all data they contain, including hidden and protected pictures and any other data that may be on the card. Before formatting, be sure to transfer to a computer any pictures you would like to keep.

FAT 32

The D200 supports FAT 32, allowing use of memory cards with capacities of over 2 GB. FAT 16 is used when reformatting cards already formatted in FAT 16.

Two-Button Format

Memory cards can also be formatted with the **FORMAT**  and **MODE**  buttons ( 14).

Mirror Lock-Up

This option is used to lock the mirror in the up position to allow inspection or cleaning of the low-pass filter that protects the image sensor. See “Technical Notes: Caring for the Camera” (📖 185).



This option is not available at battery levels of  or below, while multiple exposures are being shot, or when the camera is powered by an optional MB-D200 battery pack using AA batteries. Use a fully-charged EN-EL3e battery or an optional AC adapter. If the battery runs low while the mirror is raised, a beep will sound and the AF-assist illuminator will blink to warn you that the mirror will automatically lower in about two minutes.

Video Mode

Before connecting your camera to a video device such as a television or VCR (📖 106), choose a video mode setting that matches the video standard used in the device.

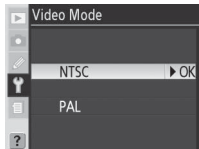

Option	Description
NTSC	Use when connecting camera to NTSC devices.
PAL	Use when connecting camera to PAL devices. Note that number of pixels in output is selectively reduced, causing drop in resolution.

World Time

World Time is used to set the camera clock to the current date and time (📖 12).

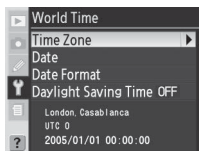

The Clock Battery

The clock-calendar is powered by an independent, rechargeable power source, which is charged as necessary when the main batteries are installed or the camera is powered by an optional EH-6 AC adapter. Two days of charging will power the clock for about three months. If the **🔌** icon flashes in the control panel, the clock battery is exhausted and the clock has been reset to a time starting at 2005.01.01.00:00:00. Set the clock to the correct date and time.

Language

Choose the language for camera menus and messages from:

De Deutsch	German	Ry Русский	Russian
En English	English	Sv Svenska	Swedish
Es Español	Spanish	繁 中文(繁體)	Traditional Chinese
Fr Français	French	简 中文(简体)	Simplified Chinese
It Italiano	Italian	日 日本語	Japanese
Ne Nederlands	Dutch	한 한글	Korean
Po Português	Portuguese		



Image Comment

Add brief text comments to photographs as they are taken. Comments can be viewed when the photographs are displayed using the supplied software or Nikon Capture 4 Version 4.4 or later (available separately). The first fifteen letters of the comment are also visible on Shooting Data Page 2 in the photo information display (100).

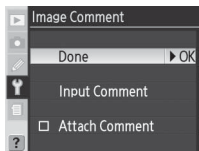

Done: Save changes and return to the setup menu.

Input Comment: The following dialog will be displayed. Enter a comment as described below.

Keyboard area: Use multi selector to highlight letters, press center of multi selector to select.

Comment area: Comment appears here. To move cursor, press  button and use multi selector.



To delete the character at the current cursor position, press the  button. To return to the setup menu without changing the comment, press the  button.

Comments can be up to thirty-six characters long. Any additional characters will be deleted.

After editing the comment, press  to return to the image comment menu.

Attach Comment: A comment is added to all photographs taken when this option is checked (). Highlight this option and press the multi selector to the right to toggle the check mark on or off.

Auto Image Rotation

Photographs taken while **On** (the default option) is selected contain information on camera orientation, allowing them to be rotated automatically during playback (p. 98) or when viewed in compatible Nikon software.* The following orientations are recorded:

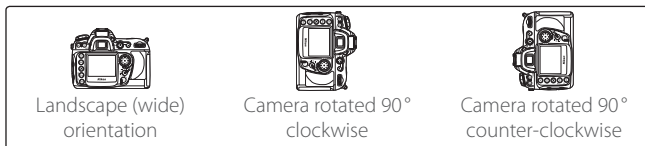
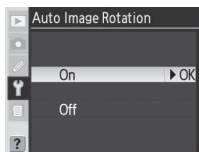

* In continuous mode (p. 26), orientation recorded for first shot applies to all images in same burst, even if camera orientation is changed during shooting.

Camera orientation is not recorded when **Off** is selected. Choose this option when taking photographs with the lens pointing up or down.

Recent Settings

The following options are available:

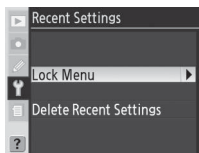

Option	Description
Lock Menu	Menu shown at right is displayed. Select Yes to lock menu so that no items are added or removed, No to unlock menu. Settings in other menus are not affected.
Delete Recent Settings	Menu shown at right is displayed. Select Yes to delete all recent settings, No to exit without changing Recent Settings menu. This option will take effect even when Recent Settings are locked.

Customizing the Recent Settings Menu

To create a personalized menu of shooting and Custom Settings options:

1 Select **Lock Menu** > **No** to unlock the Recent Settings menu.

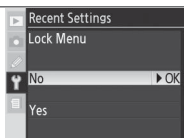

2 Select **Delete Recent Settings** > **Yes** to delete all existing recent settings.

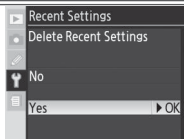

3 Select the items you wish to include in the Recent Settings menu from the shooting and Custom Settings menus. The fourteen most recently selected items will be stored.



4 Select **Lock Menu** > **Yes** to lock the Recent Settings menu.

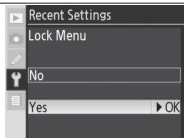

USB

Before connecting the camera to a computer via USB (107), select the appropriate USB option as determined by the computer operating system and whether the camera is being controlled from Nikon Capture 4 Version 4.4 or later (available separately) or photographs are being transferred to the computer using the supplied software:

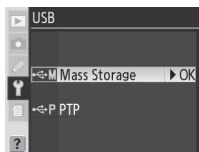

Operating system	Supplied software	Nikon Capture 4 Camera Control
Windows XP Home Edition Windows XP Professional Mac OS X	Choose PTP or Mass Storage	Choose PTP
Windows 2000 Professional Windows Millennium Edition (Me) Windows 98 Second Edition (SE) Mac OS 9	Choose Mass Storage Not supported	

Dust Off Ref Photo

Acquire reference data for the Image Dust Off function in Nikon Capture 4 Version 4.4 or later (available separately; for more information, see the *Nikon Capture 4 User's Manual*).



1 Mount a CPU lens on the camera (a lens with a focal length of at least 50 mm is recommended). The **Dust Off Ref Photo** option is only available with CPU lenses. If using a zoom lens, zoom in to the maximum telephoto position.

2 Press the multi selector to the right. The message shown at right will be displayed, and **rEF** will be displayed in the control panel and viewfinder.

To cancel the operation and return to the setup menu, press the **MENU** button.



3 With the lens ten centimeters (four inches) from a bright, featureless white object, frame the object so that nothing else is visible in the viewfinder and press the shutter-release button halfway. In autofocus mode, focus will automatically be set to infinity; in manual focus mode, set focus to infinity manually before pressing the shutter-release button. If using the aperture ring to set aperture, choose the minimum setting (largest f/-number).

4 Press the shutter-release button the rest of the way down to acquire Image Dust Off reference data (note that noise reduction turns on automatically when the subject is poorly lit, increasing the amount of time needed to record the data). The monitor turns off when the shutter-release button is pressed.

If the reference object is too bright or too dark, the camera may be unable to acquire Image Dust Off reference data and the message shown at right will be displayed. Choose another reference object and repeat the process from Step 1.



Image Dust Off

The Image Dust Off feature in Nikon Capture 4 Version 4.4 or later (available separately) processes NEF (RAW) photographs to remove the effects of dust in the camera imaging system by comparing the images to the data acquired with **Dust Off Ref Photo**. It is not available with JPEG images. The same reference data can be used for NEF (RAW) photographs taken with different lenses or at different apertures.

Image Dust Off Reference Data

Reference images can not be viewed using computer imaging software. A grid pattern is displayed when reference images are viewed on the camera.



Battery Info

View information on the EN-EL3e rechargeable Li-ion battery currently inserted in the camera.

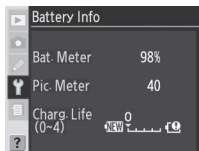

Option	Description
Bat. Meter	Current battery level as a percentage.
Pic. Meter	Number of times shutter has been released with current battery since battery was last charged. Note that camera may sometimes release shutter without recording photograph, for example when measuring value for preset white balance.
Charg. Life	Five-level display showing battery age. 0 (New) indicates that battery performance has not been affected; 4 (Replace) indicates that battery has reached end of charging life and should be replaced.

Firmware Version

View the camera firmware version. Press the multi selector to the left to return to the setup menu.

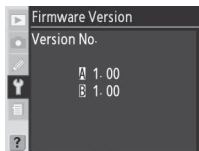

The MB-D200 Battery Pack

The following information is shown when the camera is powered by an MB-D200 battery pack:

- **MB-D200 contains EN-EL3e batteries:** Information for each battery is listed separately.
- **MB-D200 contains six AA batteries:** **Battery Info** can not be selected.

Shooting Options: The Shooting Menu

The shooting menu contains the following options. See “Using the Menus” (97) for more information on using the menus.

Option	
Shooting Menu Bank	125–126
Menu Reset	126
Folders	128
File Naming	129
Optimize Image	129
Color Space	129
Image Quality*	129
Image Size*	130
JPEG Compression	130
Raw Compression	130
White Balance*	130
Long Exp. NR	131
High ISO NR	131
ISO Sensitivity*	132
Image Overlay	132
Multiple Exposure	132
Intvl Timer Shooting	132
Non-CPU Lens Data	132

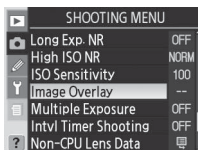
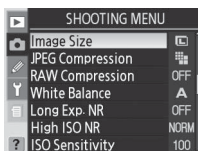
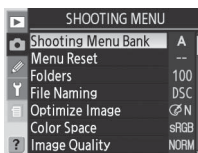

* Reset to defaults when a two-button reset is performed (97).

Using the Multi Selector

The multi selector can be used at any time when the monitor is on. The focus selector lock switch only takes effect when the monitor is off.

Shooting Menu Bank

All shooting menu options are stored in one of four banks. Changes to settings in one bank have no effect on the others. To store a particular combination of frequently-used settings, select one of the four banks (the default bank is bank A) and set the camera to these settings. The new settings will be stored in the bank even when the camera is turned off, and will be restored the next time the bank is selected. Different combinations of settings can be stored in the other banks, allowing the user to switch instantly from one combination to another by selecting the appropriate bank from the bank menu.

The default names for the four shooting menu banks are A, B, C, and D. A descriptive caption can be added using the **Rename** option.

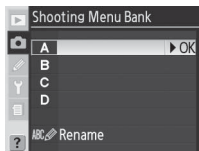

Shooting Menu Bank

The control panel shows the bank currently selected in the shooting menu bank menu.

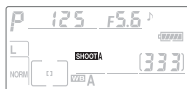

Renaming Shooting Menu Banks

1 Highlight **Rename** and press the multi selector to the right.

2 A list of shooting menu banks will be displayed. Highlight the desired bank and press the multi selector to the right.

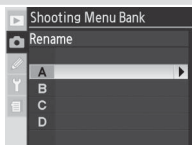



3 The following dialog will be displayed. Enter a name as described below.

Keyboard area: Use multi selector to highlight letters, press center of multi selector to select.

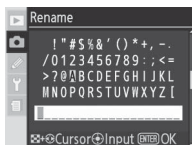
Name area: Name appears here. To move cursor, press  button and use multi selector.



To delete the character at the current cursor position, press the  button. To return to the shooting menu without changing the bank name, press the  button.

Bank names can be up to twenty characters long. Any characters after the twentieth will be deleted.

4 After editing the name, press  to return to the bank menu.

Menu Reset

To restore default settings for the current shooting menu bank (📷 125), highlight **Yes** and press the multi selector to the right (select **No** to exit without changing settings). The following settings are affected:

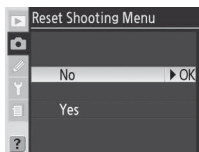

Option	Default
File naming	DSC
Optimize Image	Normal
Color space	sRGB
Image quality ¹	JPEG Normal
Image size ¹	Large
JPEG compression	Size Priority
RAW compression	NEF (Raw)
White balance ¹	Auto ²
Long Exp. NR	Off
High ISO NR	On (Normal)
ISO sensitivity ¹	100

Option	Default
Multiple exposure ³	
Number of shots	2
Auto gain	On
Interval timer shooting ⁴	
Start time	Now
Interval	00:01' :00"
No. of intervals	1
No. of shots	1
Start	Off
Non-CPU lens data	
Focal length	N/A
Maximum aperture	N/A

1 Defaults can also be restored by performing two-button reset (📷 97).

2 Fine tuning reset to 0.

3 Applies to all banks. **Menu Reset** can not be selected while shooting is in progress.

4 Applies to all banks. Shooting ends when reset is performed.



Folders

Select the folder in which subsequent images will be stored.

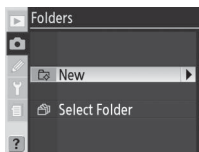

Option	Description
New	Dialog shown at right will be displayed; press multi selector up or down to choose number for new folder. Press multi selector to right to create new folder and return to shooting menu. Subsequent photographs will be stored in new folder.
Select Folder	List of existing folders will be displayed; press multi selector up or down to highlight folder, press to right to select and return to shooting menu. Subsequent photographs will be stored in selected folder.

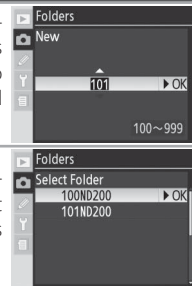

Creating a Folder at Startup

If the **CM** button is pressed when the camera is turned on, a new folder will be created by adding one to the current folder number. No folder will be created if the current folder is empty.

Number of Folders

Additional time may be required for recording and playback if the memory card contains a very large number of folders.

Automatic Folder Creation

If the current folder contains 999 files, or if sequential file numbering (159) is on and the current folder contains a picture numbered 9999, the camera will automatically create a new folder for the next picture by adding one to the current folder number. If the memory card already contains a folder numbered 999, the shutter release will be disabled. If sequential file numbering is on, the shutter release will also be disabled if the current folder is numbered 999 and contains a picture numbered 9999. To continue shooting, create a folder with a number less than 999, or select an existing folder with a number less than 999 and less than 999 images.

File Naming

Photographs are saved using file names consisting of “DSC_” or “_DSC” followed by a four-digit file number and a three-letter extension (e.g., “DSC_0001.JPG”). The **File Naming** option is used to change the “DSC” portion of the file name. Press the multi selector to the right to display the dialog shown below.

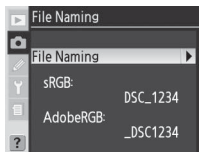

Keyboard area: Use multi selector to highlight letters, press center of multi selector to select.

Prefix area: File name prefix appears here. To move cursor left or right, press button and use multi selector.

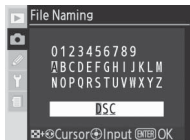

To delete the character at the current cursor position, press the button. To return to the shooting menu without changing the file naming rule, press the button.

After editing the file name prefix, press to return to the shooting menu. New photographs will be saved using the new file naming rule.

Optimize Image

Optimize color, contrast, sharpness, saturation, and hue or take photos in black-and-white. See “Reference: Optimizing Images” (45).

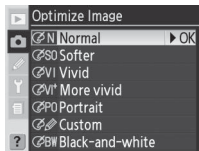

Color Space

Choose from sRGB and Adobe RGB color spaces. See “Reference: Color Space” (50).

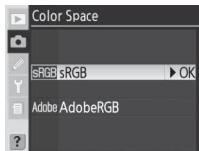

Image Quality

Seven options are available for image quality. See “Reference: Image Quality and Size” (28).

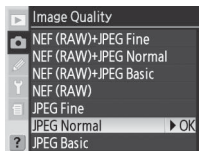
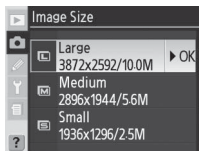



Image Size

Image size can be selected from **Large**, **Medium**, and **Small**. See “Reference: Image Quality and Size” (📖 32).



JPEG Compression

Choose whether to compress JPEG images to a fixed size or to vary file size for improved image quality. See “Reference: Image Quality and Size” (📖 30).

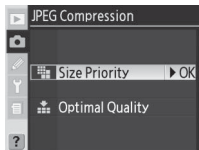

Raw Compression

Choose whether to compress NEF (RAW) images. See “Reference: Image Quality and Size” (📖 31).

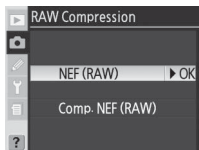

White Balance

Nine options are available for white balance. See “Reference: White Balance” (📖 35).

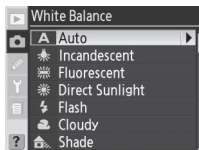

Long Exp. NR

Select **On** to reduce “noise” in the form of randomly-spaced, brightly-colored pixels in photographs taken at shutter speeds of 8 s or slower.

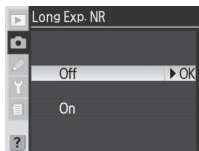

Option	Description
Off (default)	Noise reduction off; camera functions normally.
On	Photos taken at shutter speeds of about 8 s or slower are processed to reduce noise, increasing recording time by about 50–100% and halving number of images that can be stored in memory buffer. During processing, Job nr blinks in shutter-speed/aperture displays. Next photo can be taken when Job nr is no longer displayed. Note that if photographs are played back during processing, the image displayed in the monitor may not show the effects of noise reduction.



High ISO NR

Photographs taken at high sensitivities can be processed to reduce “noise.” Choose from the following options:

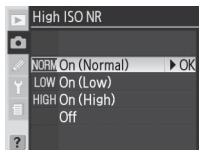

Option	Description
On (Normal) (default)	Noise reduction takes effect at ISO sensitivities of 400 or above or if ISO sensitivity is raised to 400 or higher when On is selected for Custom Setting b1 (ISO Auto). Select Normal or High for increased noise reduction.
On (Low)	Noise reduction is increased at ISO sensitivities over 1600.
On (High)	Noise reduction turns off at ISO sensitivities of 800 or below. Minimal noise reduction is performed at ISO sensitivities over 800.
Off	Noise reduction is performed at ISO sensitivities over 800.



ISO Sensitivity

ISO sensitivity can be increased from the default value (100). ISO sensitivities over 1600 are only available when Custom Setting b1 (**ISO Auto**) is off. See “Reference: Sensitivity (ISO Equivalency)” (83).

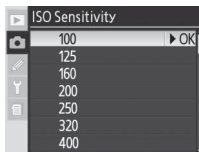

Image Overlay

Create a new image by superimposing two existing RAW photographs. The RAW photographs must have been created using the D200 and be on the same memory card. See “Reference: Image Overlay and Multiple Exposure” (84).



Multiple Exposure

Create a single photograph from two to ten exposures. See “Reference: Image Overlay and Multiple Exposure” (86).

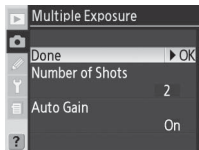

Interval Timer Shooting

Take photographs automatically at pre-selected intervals. See “Reference: Interval Timer Photography” (89).

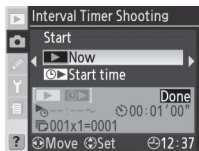

Non-CPU Lens Data

Specifying the focal length and maximum aperture allows such features as color matrix metering, aperture value display, and balanced fill flash to be used with non-CPU lenses. See “Reference: Non-CPU Lenses” (93).

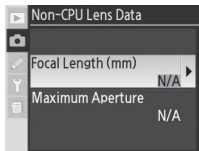

Playback Options: The Playback Menu

The playback menu contains the following options. See “Using the Menus” (137) for more information on using the menus.

Option	
Delete	133–134
Playback Folder	135
Slide Show	135–136
Hide Image	137–138
Print Set	139–140
Display Mode	141
Image Review	141
After Delete	142
Rotate Tall	142



The playback menu is only displayed if there is a memory card in the camera.

Delete

The delete menu contains the following options.

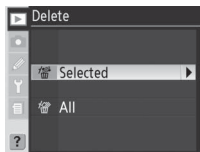

Option	Description
Selected	Delete selected photographs.
All	Delete all photographs.



Using the Multi Selector

The multi selector can be used at any time when the monitor is on. The focus selector lock switch only takes effect when the monitor is off.

Protected and Hidden Images

Images marked with a  icon are protected and can not be deleted. Hidden images ( 137) are not displayed in the thumbnail list and can not be selected for deletion.

High-Capacity Memory Cards

If the memory card contains a large number of files or folders and the number of pictures to be deleted is very large, deletion can sometimes take more than half an hour.

Deleting Selected Photographs: **Selected**

Choosing **Selected** displays the photographs in the folder or folders selected in the **Playback Folder** menu (135) as small thumbnail images.

1

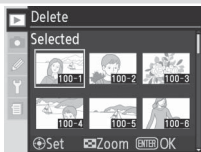

Highlight image. (To view highlighted image full screen, press **ENTER**. Release to return to thumbnail list.)

2



Select highlighted image. Selected image marked by  icon.

3

Repeat steps 1 and 2 to select additional pictures. To deselect picture, highlight and press center of multi selector. To exit without deleting pictures, press **MENU** button.

4

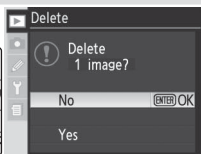
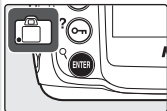

Confirmation dialog displayed. Press multi selector up or down to highlight option, press **ENTER** to select.

- **Yes:** delete selected pictures
- **No:** exit without deleting images

Deleting All Photographs: **All**

Choosing **All** displays the confirmation dialog shown at right. Press the multi selector up or down to highlight an option, then press the **ENTER** button to make a selection.

- **Yes:** delete all images in the folder or folders selected in the **Playback Folder** menu (135). Pictures that are protected or hidden will not be deleted.
- **No:** exit without deleting images.

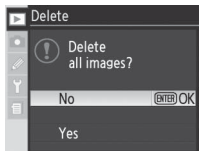

Playback Folder

Choose a folder for playback.

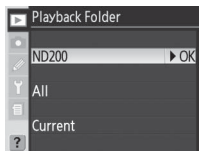

Option	Description
ND200	Images in all folders created by the D200 will be visible during playback.
All	Images in all folders created by cameras that conform to the Design Rule for Camera File System (DCF)—all Nikon digital cameras and most other makes of digital camera—will be visible during playback.
Current	Only images in folder currently selected using Folders option in shooting menu are displayed during playback.

Slide Show



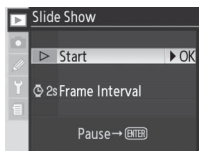

To play images back one after the other in an automated “slide show,” highlight **Start** in the slide show menu and press the multi selector right. All photographs in the folder or folders selected in the **Playback Folder** menu will be played back in the order recorded, with a pause between each image. Hidden photographs (🔒 137) will not be played back.



Selecting a Folder for Storage

The **Folders** option in the shooting menu is used to create new folders and to select the folder in which subsequent photographs will be stored (🔒 128).

The following operations can be performed during a slide show:

To	Use	Description
Go forward or back one frame		Press multi selector left to return to previous frame, right to skip to next frame.
View photo info		Press multi selector up or down to change photo info displayed during slide show.
Pause		Press ENTER to pause slide show.
Exit to playback menu		Press MENU to end slide show and display playback menu.
Exit to playback mode		Press EXIT to end slide show and return to playback with current image displayed in monitor.
Exit to shooting mode	Shutter release	Press shutter-release button halfway to end slide show, turn monitor off, and return to shooting mode.

The dialog shown at right is displayed when the show ends or when the **ENTER** button is pressed to pause playback. Press the multi selector up or down to highlight an option, then press to the right to make a selection.

- **Restart:** Resume slide show.
- **Frame Interval:** Change the length of time each picture is displayed.
- **Exit:** End slide show and return to the playback menu.

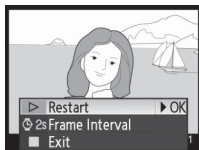

To exit the slide show and return to the playback menu, press the multi selector to the left or press the **MENU** button.

Changing the Display Interval: **Frame Interval**

To change the time each image is displayed, highlight **Frame Interval** in the **Slide Show** or pause menu and press the multi selector right. Press the multi selector up or down to highlight the appropriate option and then press the multi selector to the right to return to the previous menu.

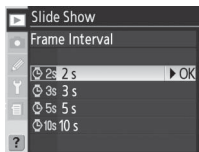

Hide Image

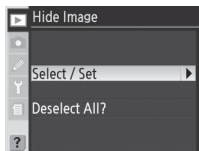

The **Hide Image** option is used to hide or reveal selected photographs. Hidden images are visible only in the **Hide Image** menu, and can only be deleted by formatting the memory card.







Option	Description
Select/Set	Hide or reveal selected photographs.
Deselect All?	Reveal all photographs.

Hiding Selected Photographs: **Select/Set**

Choosing **Select/Set** displays the photographs in the folder or folders selected in the **Playback Folder** menu (135) as small thumbnail images.

- 

Highlight image. (To view highlighted image full screen, press . Release to return to thumbnail list.)
- 

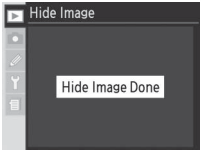
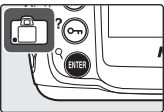
Select highlighted image. Selected image marked by  icon.
- Repeat steps 1 and 2 to select additional pictures. To deselect picture, highlight and press center of multi-selector. To exit without changing hidden status of pictures, press  button.
- 

Complete operation and return to playback menu.

File Attributes for Hidden Images

Hidden images have "hidden" and "read-only" status when viewed on a Windows computer. In the case of "NEF+JPEG" images, this marking applies to both the NEF (RAW) and JPEG image.

Protected and Hidden Images

Revealing an image that is both hidden and protected will simultaneously remove protection from the image.

Revealing All Photographs: **Deselect All**

Choosing **Deselect All?** displays the confirmation dialog shown at right. Press the multi selector up or down to highlight an option, then press the **ENTER** button to make a selection.

- **Yes:** reveal all images in the folder or folders selected in the **Playback Folder** menu (🔍 135). The monitor will briefly show the message “Deselect All Done,” and then the playback menu will be displayed.
- **No:** exit to the playback menu without changing the hidden status of images.

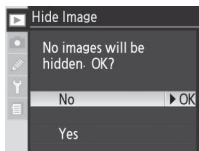

Print Set

Print Set is used to create a digital “print order” that lists the photographs to be printed, the number of copies, and the information to be included on each print. This information is stored on the memory card in **Digital Print Order Format (DPOF)**. The card can then be removed from the camera and used to print the selected images printed on any DPOF-compatible device.

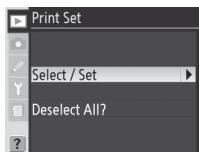

Option	Description
Select/Set	Select photographs for printing.
Deselect All?	Remove all images from print order.

Exif version 2.21

The D200 supports Exif (**Exchangeable Image File Format for Digital Still Cameras**) version 2.21, a standard that allows information stored with photographs to be used for optimal color reproduction when images are output on Exif-compliant printers.

DPOF/PictBridge

Digital Print Order Format (DPOF) is an industry-wide standard that allows pictures to be printed from print orders stored on the memory card. Before printing, check that the printer or print service supports DPOF. Pictures selected using **Print Set** can also be printed on PictBridge printers via direct USB connection (📖 110). When a PictBridge printer is connected to the camera using the supplied UC-E4 USB cable, a menu will be displayed in the camera monitor; select **DPOF Print** to print the current print order. Note that the date and shooting information will not be printed.

🔪 Print Set

Print Set will not be available if there is not enough space on the memory card to record the print order. Delete unwanted pictures and try again.

🔪 NEF Images

Images created at image quality settings of **NEF (Raw)** (📖 28) can not be selected for printing using this option.

🔪 After Creating a Print Order

After creating a print order, do not change the hidden status of images in the print order or use a computer or other device to delete images. Either action could cause problems during printing.



🔪 Taking Pictures for Direct Printing

When taking images to be printed without modification, set the **Color Space** option in the shooting menu to **sRGB** (📖 50).

Modifying the Print Order: **Select/Set**

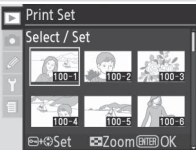

Choosing **Select/Set** displays the photographs in the folder or folders selected in the **Playback Folder** menu (135) as small thumbnail images.

1



Highlight image. (To view highlighted image full screen, press **Q**. Release to return to thumbnail list.)

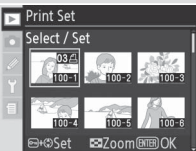

2



Press **Q** button and press multi selector up or down to specify number of prints (up to 99), or press center of multi selector to select image and set number of prints to 1. Selected images are marked by  icon.

3 Repeat steps 1 and 2 to select additional pictures. To deselect picture, press multi selector up or down until  icon is no longer displayed. To exit without changing print order, press **ENTER** button.

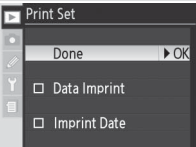
4



Return to Print Set menu. To select or deselect options, highlight and press multi selector to right. Selected items are marked with a .

- **Data Imprint:** Print shutter speed and aperture on all pictures in print order.
- **Imprint Date:** Print date of recording on all pictures in print order.

To complete print order and return to playback menu, highlight **Done** and press multi selector to right. To exit without altering print order, press **ENTER** button.

Removing All Images from the Print Order: **Deselect All**

Choosing **Deselect All?** displays the confirmation dialog shown at right. Press the multi selector up or down to highlight an option, then press the **ENTER** button to make a selection.

- **Yes:** remove all images from the print order. The monitor will briefly show the message "Deselect All Done," and then the playback menu will be displayed.
- **No:** exit to the playback menu without changing the print order.

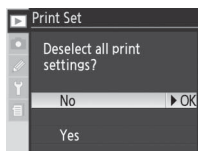

Display Mode

To choose the information listed in the photo-information display (📷 99), highlight the desired option and press the multi selector right. A ✓ appears next to selected items; to deselect, highlight and press the multi selector to the right. To return to the playback menu, highlight **Done** and press the multi selector to the right.

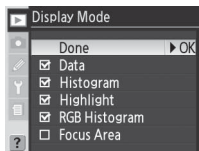

Option	Description
Data*	Shooting data appears in photo information display.
Histogram*	Histogram appears in photo information display.
Highlight*	Highlight page appears in photo information display.
RGB Histogram*	RGB histogram appears in photo information display.
Focus Area	Active focus area (if single-servo AF is used with dynamic-area AF, group dynamic-AF, or closest-subject priority, area where focus first locked) is shown in red in photo information display.

* Default selection.

Image Review

Image Review controls whether or not photographs are displayed in the monitor immediately after shooting.

Option	Description
Off (default)	Photographs are not automatically displayed after shooting.
On	Photographs are automatically displayed after shooting.

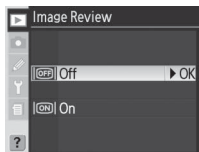

After Delete

Choose whether the following or previous picture is displayed after an image is deleted.

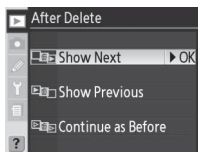

Option	Description
Show Next (default)	After image is deleted, following image is displayed or highlighted in thumbnail list. If deleted image was last frame in memory, previous frame will be displayed or highlighted.
Show Previous	After image is deleted, previous image is displayed or highlighted in thumbnail list. If deleted image was first frame in memory, following frame will be displayed or highlighted.
Continue as Before	If user was scrolling through images in order recorded before deletion, following image will be displayed or highlighted (if deleted image was last frame in memory, previous frame will be displayed or highlighted). If user was scrolling through images in reverse order, previous image will be displayed or highlighted (if deleted image was first frame in memory, following frame will be displayed or highlighted).

Rotate Tall

Choose whether photographs taken in "tall" (portrait) orientation are automatically rotated for display in the monitor.

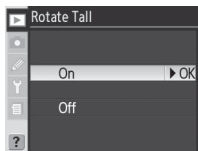

Option	Description
On (default)	"Tall" (portrait) orientation photos taken with On selected for Auto Image Rotation (119) are displayed in tall orientation during playback (tall orientation images are displayed at 2/3 size of other images to fit monitor).
Off	"Tall" photos are displayed in "wide" (landscape) orientation.



Custom Settings

Custom settings are used to fine-tune a variety of camera settings to suit the user's preferences, creating combinations of settings that differ from the factory defaults in effect at the time your camera was purchased. In addition to Custom Settings C (**Bank Select**) and R (**Menu Reset**), settings in the Custom Settings menu are divided into the following six groups:

	Group	Custom Settings
a	Autofocus	a1–a10
b	Metering/Exposure	b1–b7
c	Timers/AE&AF Lock	c1–c5
d	Shooting/Display	d1–d8
e	Bracketing/Flash	e1–e8
f	Controls	f1–f7

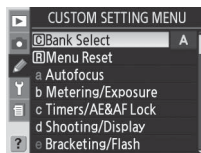

Press the multi selector up or down to highlight the desired group and then press the multi selector to the right. The full list of Custom Settings a1–f7 will be displayed, starting with the settings in the selected group. To select a setting in a different group, press the multi selector up or down scroll until the desired setting is displayed, or press the multi selector to the left to return the top menu and select a different group. Custom Setting a1 (**AF-C Mode Priority**) and f7 (**No Memory Card?**) are linked: pressing the multi selector up when Custom Setting a1 is highlighted displays Custom Setting f7, while pressing the multi selector down while Custom Setting f7 is highlighted displays Custom Setting a1.

Using the Multi Selector

The multi selector can be used at any time when the monitor is on. The focus selector lock switch only takes effect when the monitor is off.

The following Custom Settings are available:

		Custom Setting	
C	Bank Select	Custom Setting Bank	146
R	Menu Reset	Reset Custom Setting Menu	147
a	Autofocus		
a1	AF-C Mode Priority	AF-C Mode Priority Selection	148
a2	AF-S Mode Priority	AF-S Mode Priority Selection	148
a3	Focus Area Frame	Focus Area Frame Selection	148
a4	Group Dynamic AF	Pattern Selection in Group Dynamic AF	149–150
a5	Lock-On	Focus Tracking with Lock-On	150
a6	AF Activation	AF Activation	151
a7	AF Area Illumination	AF Area Illumination	151
a8	Focus Area	Focus Area Selection	151
a9	AF Assist	Built-in AF-Assist Illuminator	152
a10	AF-ON for MB-D200	AF-ON Button for MB-D200 Battery Pack	152
b	Metering/Exposure		
b1	ISO Auto	ISO Sensitivity Auto Control	152–153
b2	ISO Step Value	ISO Sensitivity Step Value	154
b3	EV Step	EV Steps for Exposure Control	154
b4	Exp Comp/Fine Tune	Steps for Exposure Comp and Fine Tuning	154
b5	Exposure comp.	Easy Exposure Compensation	155
b6	Center-Weighted	Center-Weighted Area	155
b7	Fine Tune Exposure	Fine Tune Optimal Exposure	156
c	Timers/AE&AF Lock		
c1	AE Lock	AE Lock Buttons	156
c2	AE-L/AF-L	Assignment of AE-L/AF-L Button	156–157
c3	Auto Meter-Off	Auto Meter-Off Delay	157
c4	Self-Timer	Self-Timer Delay	157
c5	Monitor-Off	Monitor-Off Delay	157
d	Shooting/Display		
d1	Beep	Beep	158
d2	Grid Display	Viewfinder Grid Display	158
d3	Viewfinder Warning	Viewfinder Warning Display	158
d4	Shooting Speed	CL-Mode Shooting Speed	158
d5	Exp. Delay Mode	Exposure Delay Mode	158
d6	File No. Sequence	File Number Sequence	159
d7	Illumination	LCD Illumination	159
d8	MB-D200 Batteries	MB-D200 Battery Type	160

Custom Setting			
e	Bracketing/Flash		
e1	Flash Sync Speed	Flash Sync Speed Setting	160
e2	Flash Shutter Speed	Slowest Speed When Using Flash	161
e3	Built-in Flash	Built-in Flash Mode	161–166
e4	Modeling Flash	Preview Button Activates Modeling Flash	166
e5	Auto BKT Set	Auto Bracketing Set	166
e6	Manual Mode Bkting	Auto Bracketing in M Exposure Mode	167
e7	Auto BKT Order	Auto Bracketing Order	167
e8	Auto BKT Selection	Auto Bracketing Selection Method	167
f	Controls		
f1	Center Button	Multi-Selector Center Button	168
f2	Multi-Selector	When Multi-Selector is Pressed;	169
f3	Photo Info/Playback	Role of Multi-Selector in full-frame Playback	169
f4	FUNC. Button	Assign FUNC. Button	170
f5	Command Dials	Customize Command Dials	170–171
f6	Buttons and Dials	Setting Method for Buttons and Dials	172
f7	No Memory Card?	Disable Shutter If No Memory Card	172



Custom Setting C: Custom Setting Bank

Custom Settings are stored in one of four banks. Changes to settings in one bank have no effect on the others. To store a particular combination of frequently-used settings, select one of the four banks and set the camera to these settings. The new settings will be stored in the bank even when the camera is turned off, and will be restored the next time the bank is selected. Different combinations of settings can be stored in the other banks, allowing the user to switch instantly from one combination to another by selecting the appropriate bank from the bank menu.

The default names for the four Custom Settings banks are A, B, C, and D. A descriptive caption can be added using the **Rename** option as described in “The Shooting Menu: Shooting Menu Bank” (125).

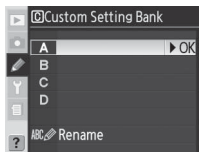

Custom Settings Bank

If settings in the current bank have been modified from default values, the control panel display will show **CUSTOM** and the letter of the bank. An asterisk will be displayed next to the altered settings in the second level of the Custom Settings menu.

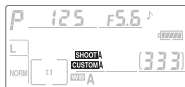

Custom Setting R: Reset Custom Setting Menu

To restore default settings for the current Custom Settings bank (146), highlight **Yes** and press the multi selector to the right (select **No** to exit without changing settings).

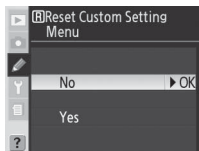

Custom Setting	Default
a1 AF-C Mode Priority	FPS rate
a2 AF-S Mode Priority	Focus
a3 Focus Area Frame	Normal Frame (11 Areas)
a4 Group Dynamic AF	Pattern 1/Center Area
a5 Lock-On	Normal
a6 AF Activation	Shutter/AF-ON
a7 AF Area Illumination	Auto
a8 Focus Area	No Wrap
a9 AF Assist	On
a10 AF-ON for MB-D200	AF-ON+Focus Area
b1 ISO Auto	Off
b2 ISO Step Value	1/3 Step
b3 EV Step	1/3 Step
b4 Exp Comp/Fine Tune	1/3 Step
b5 Exposure comp.	Off
b6 Center-Weighted	φ 8 mm
b7 Fine Tune Exposure	0*
c1 AE Lock	AE-L/AF-L Button
c2 AE-L/AF-L	AE/AF Lock
c3 Auto Meter-Off	6 s
c4 Self-Timer	10 s
c5 Monitor-Off	20 s
d1 Beep	High
d2 Grid Display	Off
d3 Viewfinder Warning	On
d4 Shooting Speed	3 fps
d5 Exp. Delay Mode	Off
d6 File No. Sequence	Off
d7 Illumination	Off
d8 MB-D200 Batteries	LR6 (AA-size Alkaline)

Custom Setting	Default
e1 Flash Sync Speed	1/250 s
e2 Flash Shutter Speed	1/60 s
e3 Built-in Flash	TTL
e4 Modeling Flash	On
e5 Auto BKT Set	AE & Flash
e6 Manual Mode Bkting	Flash/Speed
e7 Auto BKT Order	MTR>Under>Over
e8 Auto BKT Selection	Manual Value Select
f1 Center Button	
Shooting mode Center AF Area	
Playback Mode Thumbnail On/Off	
f2 Multi-Selector	Do Nothing
f3 Photo Info/Playback	Info ▲▼/PB ◀▶
f4 FUNC. Button	FV Lock
f5 Command Dials	
Rotate Direction Normal	
Change Main/Sub Off	
Aperture Setting Sub-command Dial	
Menus and Playback Off	
f6 Buttons and Dials	Default
f7 No Memory Card?	Disable Shutter

Two-Button Reset

Custom Settings are not reset when a two-button reset is performed (97).

* Applies to all metering methods.

Custom Setting a1: AF-C Mode Priority Selection

This option controls whether photographs can be taken whenever the shutter-release button is pressed (*release priority*) or only when the camera is in focus (*focus priority*) in continuous-servo AF.

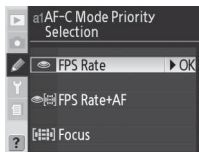

Option	Description
FPS Rate (default)	Photos can be taken whenever shutter-release button is pressed.
FPS Rate + AF	Photos can be taken even when camera is not in focus. In continuous mode, frame rate slows for improved focus if subject is dark or low contrast.
Focus	Photos can only be taken when in-focus indicator (●) is displayed. Note that focus does not lock when in-focus indicator is displayed.

Custom Setting a2: AF-S Mode Priority Selection

This option controls whether photographs can be taken only when the camera is in focus (*focus priority*) or whenever the shutter-release button is pressed (*release priority*) in single-servo AF. Regardless of the setting chosen, focus will lock when the in-focus indicator (●) is displayed.



Option	Description
Focus (default)	Photos can only be taken when in-focus indicator (●) is displayed.
Release	Photos can be taken whenever shutter-release button is pressed.

Custom Setting a3: Focus Area Frame Selection

At the default setting of **Normal Frame (11 Areas)**, the camera offers a choice of eleven focus areas. Select **Wide Frame (7 Areas)** for wider focus areas when [C] (single-area AF) or [C] (dynamic-area AF) is selected for AF-area mode (54).

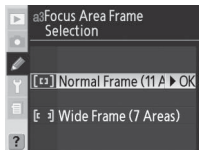

Custom Setting a4: Pattern Selection in Group Dynamic AF

This option controls how focus areas are grouped in group dynamic-AF (📷 54) and whether the camera gives priority to the subject in the center focus area of the selected group.

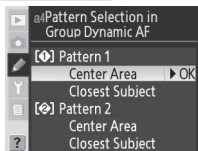

Option	Description
Pattern 1 / Center Area (default)	Focus areas are grouped in pattern 1 (📷 150). Camera focuses on subject in center focus area of selected group. Because camera does not have to select focus area, less time is required for focus operation. If subject moves out of center focus area, camera will focus based on information from other focus areas in same group. Center focus area of selected group is highlighted in control panel.
Pattern 1 / Closest Subject	Focus areas are grouped in pattern 1 (📷 150). Camera automatically selects focus area containing subject closest to camera in current focus area group. If subject moves out of selected focus area, camera will focus based on information from other focus areas in same group.
Pattern 2 / Center Area	As for Pattern 1/Center Area , except that focus areas are grouped in pattern 2 (📷 150).
Pattern 2 / Closest Subject	As for Pattern 1/Closest Subject , except that focus areas are grouped in pattern 2 (📷 150).



Focus areas are grouped as follows (illustrations show the control panel display):

	Pattern 1	Pattern 2*
Center Area	<p>Top</p> <p>Left Center Right</p> <p>Bottom</p>	<p>Top</p> <p>Left Center 1 Center 2 Right</p> <p>Bottom</p>
Closest Subject	<p>Top</p> <p>Left Center Right</p> <p>Bottom</p>	<p>Top</p> <p>Left Center 1 Center 2 Right</p> <p>Bottom</p>

* The center focus-area group is selected by pressing the center of the multi selector once to activate the current center focus-area group and then pressing the center of the multi selector to toggle between “center 1” and “center 2.” “Center 2” is only available when **Center AF Area** is selected for **Center Button** (Custom Setting f1) > **Shooting Mode**.

Custom Setting a5: Focus Tracking with Lock-On

This option controls how autofocus adjusts to sudden large changes in the distance to the subject.

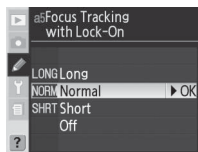

Option	Description
Long	Camera waits before adjusting focus when distance to subject changes abruptly. Prevents camera from refocusing when subject is briefly obscured by objects passing through frame. Select Long to increase length of time before camera refocuses, Short to reduce.
Normal (default)	
Short	
Off	Camera immediately adjusts focus when distance to subject changes abruptly. Use when photographing series of subjects at varying distances in quick succession.

Custom Setting a6: AF Activation

This option controls whether both the shutter-release button and the **AF-ON** button can be used to initiate autofocus or whether autofocus is only initiated when the **AF-ON** button is pressed.

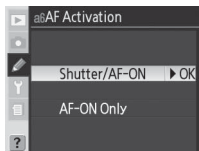

Option	Description
Shutter/AF-ON (default)	Autofocus can be performed with AF-ON button or by pressing shutter-release button halfway.
AF-ON Only	Autofocus can only be performed with AF-ON button.

Custom Setting a7: AF Area Illumination

This option controls whether or not the active focus area is highlighted in red in the viewfinder.

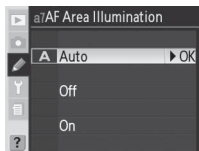

Option	Description
Auto (default)	Selected focus area is automatically highlighted as needed to provide contrast with background.
Off	Selected focus area is not highlighted.
On	Selected focus area is always highlighted, regardless of brightness of background. Depending on brightness of background, selected focus area may be difficult to see.

Custom Setting a8: Focus Area Selection

At the default setting of **No Wrap**, the focus-area display is bounded by the outer focus areas so that, for example, pressing the multi selector up when the top focus area is selected has no effect. Select **Wrap** to allow focus-area selection to “wrap around” from top to bottom, bottom to top, right to left, and left to right.



Custom Setting a9: Built-in AF-Assist Illuminator

At the default setting of **On**, the built-in AF-assist illuminator lights to assist the focus operation when the subject is poorly lit (📷 58). Select **Off** to turn the illuminator off.

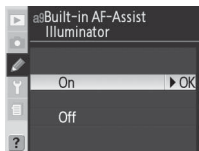

Custom Setting a10: AF-ON Button for MB-D200 Battery Pack

This option controls the function assigned to the **AF-ON** button for the optional MB-D200 battery pack (📷 181).

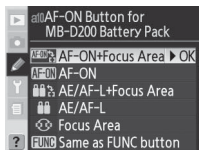

Option	Description
AF-ON+ Focus Area (default)	AF-ON button on battery pack performs same function as camera AF-ON button. Focus area can be selected by pressing AF-ON button on MB-D200 and rotating sub-command dial.
AF-ON	AF-ON button on battery pack performs same function as camera AF-ON button.
AE/AF-L+ Focus Area	AF-ON button on battery pack performs same function as camera AE-L/AF-L button. Focus area can be selected by pressing AF-ON button on MB-D200 and rotating sub-command dial.
AE/AF-L	AF-ON button on battery pack performs same function as camera AE-L/AF-L button.
Focus Area	Focus area can be selected by pressing AF-ON button on MB-D200 and rotating sub-command dial.
Same as FUNC button	AF-ON button on battery pack performs function currently assigned to camera FUNC. button using Custom Setting f4 (FUNC. Button ; 📷 170)



Custom Setting b1: ISO Sensitivity Auto Control

If **On** is selected for this option, the camera will automatically adjust ISO sensitivity when necessary to help ensure optimal exposure. This option is not available at ISO sensitivities over 1600.



High ISO NR (📷 131)

Noise is more likely to appear in photographs taken at higher sensitivities. To reduce noise at sensitivities of ISO 400 equivalent and above, turn on the **High ISO NR** option in the shooting menu.

Option	Description	
Off (default)	ISO sensitivity remains fixed at value selected by user, regardless of whether optimal exposure can be achieved at current exposure settings.	
On	If optimal exposure can not be achieved at ISO sensitivity selected by user, ISO sensitivity is adjusted to compensate, to minimum approximately equivalent to ISO 200 and maximum selected using Max. Sensitivity option. Flash level is adjusted appropriately when flash is used. In exposure modes P and A , ISO sensitivity will be adjusted if photo would be overexposed at shutter speed of $\frac{1}{8,000}$ or underexposed at value selected for Min. Shutter Speed . Otherwise camera adjusts ISO sensitivity when limits of exposure metering system are exceeded (mode S) or when optimum exposure can not be achieved at shutter speed and aperture selected by user (mode M). ISO sensitivity can not be set to values over 1600 while this option is in effect.	
Max. Sensitivity	Menu shown at right is displayed. Highlight desired ISO value and press multi selector right to return to ISO auto menu.	
Min. Shutter Speed	Menu shown at right is displayed. Highlight desired shutter speed and press multi selector right to return to ISO auto menu.	

When **On** is selected, the control panel and viewfinder show **ISO-AUTO**. When sensitivity is altered from the value selected by the user, these indicators blink and the altered value is shown in the viewfinder (the indicators do not blink if a flash is used).

ISO Auto > On

When a flash is used, foreground subjects may be underexposed in photos taken at slow shutter speeds, in daylight, or against a bright background. Choose a flash mode other than slow sync or select mode **A** or **M** and choose a larger aperture.

If a shooting menu bank in which ISO sensitivity has been set to a value greater than 1600 is chosen after **On** is selected, ISO sensitivity will not be adjusted automatically. ISO sensitivity will also not be adjusted automatically if a Custom Settings bank in which **On** is selected is chosen after ISO sensitivity has been set to a value over 1600.

Note that because sensitivity is only altered from the value selected by the user when the limits for aperture and shutter speed are exceeded, flexible program (mode **P**) has no effect on aperture or shutter speed when the **ISO-AUTO** indicators are blinking.

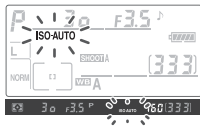

Custom Setting b2: ISO Sensitivity Step Value

Choose whether adjustments to sensitivity (ISO equivalency) are made in increments equivalent to $\frac{1}{3}$ EV (**1/3 Step**, the default option), $\frac{1}{2}$ EV (**1/2 Step**), or 1 EV (**1 Step**).



Custom Setting b3: EV Steps for Exposure Control

Choose whether adjustments to shutter speed, aperture, and bracketing are made in increments equivalent to $\frac{1}{3}$ EV (**1/3 Step**, the default option), $\frac{1}{2}$ EV (**1/2 Step**), or 1 EV (**1 Step**).

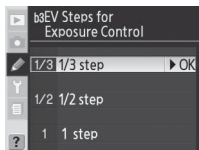



Custom Setting b4: Steps for Exposure Comp and Fine Tuning

Choose whether adjustments to exposure compensation and exposure fine tuning are made in increments equivalent to $\frac{1}{3}$ EV (**1/3 Step**, the default option), $\frac{1}{2}$ EV (**1/2 Step**), or 1 EV (**1 Step**).



Custom Setting b5: Easy Exposure Compensation

This option controls whether the  button is needed to set exposure compensation ( 72). If **On** is selected, the 0 at the center of the exposure display will blink even when exposure compensation is set to ± 0 .



Option	Description	
Off (default)	Exposure compensation set by pressing  button and rotating main command dial.	
On	Exposure compensation set by rotating command dial only. Dial used depends on option selected for Custom Setting f5 > Change Main/Sub .	
	Command dials (Custom Setting f5) > Change Main/Sub	
	Off	On
	Exposure mode	
	P	Sub-command dial
S	Sub-command dial	Main command dial
A	Main command dial	Sub-command dial
M	N/A	
On (Auto Reset)	As for On except that exposure compensation set using command dial only is cancelled when camera is turned off or exposure meters turn off.	

Custom Setting b6: Center-Weighted Area

When calculating exposure, center-weighted metering assigns the greatest weight to a circle in the center of the frame. The diameter (ϕ) of this circle can be selected from 6, 8, 10, and 13 mm (the default option is 8 mm; note that the diameter is fixed at 8 mm when a non-CPU lens is used, regardless of the setting selected for **Non-CPU Lens Data** in the shooting menu).

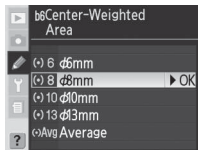

Custom Setting b7: Fine Tune Optimal Exposure

Use this option to fine-tune the exposure value selected by the camera. Exposure can be fine-tuned separately for each metering method by from +1 to -1 EV in steps of 1/6 EV. Selecting this option displays a message warning that the  icon does not appear when exposure is altered; highlight **Yes** and press the multi-selector to the right (select **No** to exit without altering exposure). Highlight a metering method and press the multi-selector to the right to display a list of exposure values. Highlight an option, then press to the right to make a selection.

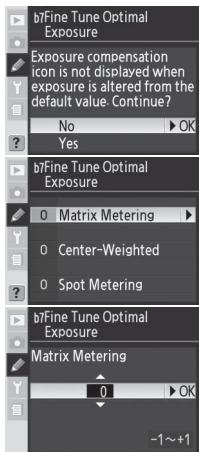

Custom Setting c1: AE Lock Buttons

This option determines what controls lock exposure.

Option	Description
AE-L/AF-L Button (default)	Exposure can only be locked by pressing AE-L/AF-L button.
+Release Button	Exposure can be locked by pressing AE-L/AF-L button or by pressing shutter-release button halfway.

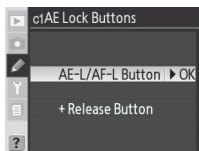

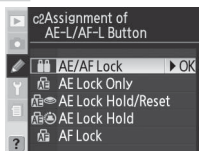

Custom Setting c2: Assignment of AE-L/AF-L Button

This option controls the behavior of the **AE-L/AF-L** button.



Fine-Tuning Exposure

Exposure can be fine-tuned separately for each Custom Settings bank. Note that as the exposure compensation icon () is not displayed, the only way to determine whether exposure has been altered is to view the fine-tuning menu. Exposure compensation ( 72) is recommended in most situations.

Option	Description
AE/AF Lock (default)	Both focus and exposure lock while AE-L/AF-L button is pressed.
AE Lock Only	Exposure locks while AE-L/AF-L button is pressed. Focus is unaffected.
AE Lock Hold/Reset	Exposure locks when AE-L/AF-L button is pressed and remains locked until button is pressed again, shutter is released or exposure meters turn off.
AE Lock Hold	Exposure locks when AE-L/AF-L button is pressed and remains locked until button is pressed again or exposure meters turn off.
AF Lock	Focus locks while AE-L/AF-L button is pressed. Exposure is unaffected.

Custom Setting c3: Auto Meter-Off Delay

This option controls how long the camera continues to meter exposure when no operations are performed: 4 s, 6 s (the default option), 8 s, or 16 s or until the camera is turned off (**No Limit**). Choose a shorter meter-off delay for longer battery life.

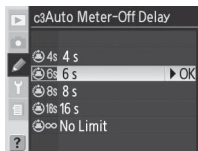

Custom Setting c4: Self-Timer Delay

This option controls the length of the shutter-release delay in self-timer mode. Shutter-release can be delayed by approximately 2 s, 5 s, 10 s (the default option), or 20 s.

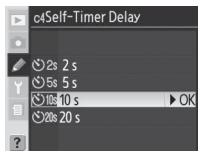

Custom Setting c5: Monitor-Off Delay

This option controls how long the monitor remains on when no operations are performed: 10 s, 20 s (the default option), 1 minute, 5 minutes, or 10 minutes. Choose a shorter monitor-off delay for longer battery life.

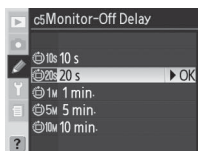

The EH-6 AC Adapter

When the camera is powered by an optional EH-6 AC adapter, exposure meters will not turn off and the monitor will only power off after ten minutes, regardless of the options chosen for Custom Settings c3 (**Auto Meter-Off**) and c5 (**Monitor-Off**).

Custom Setting d1: Beep

Controls the pitch of the beep that sounds when the self-timer is counting down or the camera focuses in single-servo AF with **Focus** (the default setting) selected for Custom Setting a2 (**AF-S Mode Priority**). Choose from **High** (the default option), **Low**, and **Off**.

A  icon appears in the control panel when **High** or **Low** is selected.

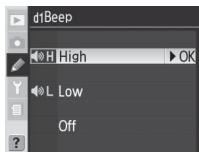

Custom Setting d2: Viewfinder Grid Display

Select **On** to display on-demand grid lines in the viewfinder ( 6). The default option is **Off**.

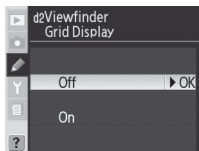

Custom Setting d3: Viewfinder Warning Display

Select **On** (the default option) to display a warning in the viewfinder when the battery is low, no memory card is inserted, or when shooting in black-and-white. No warning is displayed when **Off** is selected; before shooting, check indicators in the control panel.



Custom Setting d4: CL-Mode Shooting Speed

This option determines the rate at which photographs can be taken in **CL** (continuous low-speed) mode (during interval timer photography, this setting also determines the frame advance rate for single-frame and mirror-up modes). Shooting speed can be set to values between 1 and 4 frames per second (fps); the default value is 3 fps. The frame advance rate may drop at slow shutter speeds.



Custom Setting d5: Exposure Delay Mode

Select **On** to delay shutter release until about 0.4s after the shutter-release button is pressed, reducing camera shake in situations in which the least camera movement could result in blurred photographs (for example, microscope photography). The default option is **Off**.

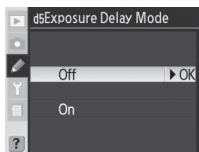

Custom Setting d6: File Number Sequence

When a photograph is taken, the camera names the file new by adding one to the last file number used. This option controls whether file numbering continues from the last number used when a new folder is created, the memory card is formatted, or a new memory card is inserted in the camera.

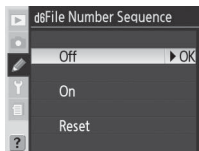

Option	Description
Off (default)	File numbering reset to 0001 when new folder is created, memory card is formatted or new memory card is inserted in camera.
On	When new folder is created, memory card is formatted, or new memory card inserted in camera, file numbering continues from last number used or from largest number in current folder, whichever is higher. If photograph is taken when current folder contains photograph numbered 9999, new folder will be created automatically and file numbering will begin again from 0001.
Reset	As for On , except that next photograph taken is assigned file number by adding one to largest file number in current folder. If selected folder contains no photographs, file numbering reset to 0001.

Custom Setting d7: LCD Illumination

This option controls the control panel backlight (LCD illuminator).

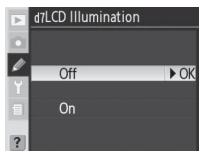

Option	Description
Off (default)	Control panel illuminates only while power switch is rotated to  position.
On	Backlight stays on while exposure meters are active (note that this increases drain on battery).

Custom Setting d8: MB-D200 Battery Type

To ensure that the camera functions as expected when AA batteries are used in the optional MB-D200 battery pack, match the option selected in this menu to the type of battery inserted in the battery pack. There is no need to adjust this option when using EN-EL3e batteries.

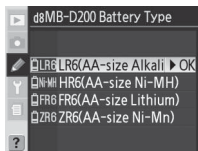

Option	Description
LR6 (AA-size Alkaline) (default)	Select when using LR6 alkaline AA batteries.
HR6 (AA-size Ni-MH)	Select when using HR6 NiMH AA batteries.
FR6 (AA-size Lithium)	Select when using FR6 lithium AA batteries.
ZR6 (AA-size Ni-Mn)	Select when using ZR6 nickel-manganese AA batteries.

Custom Setting e1: Flash Sync Speed Setting

This option controls flash sync speed. Options range from $\frac{1}{250}$ s (**1/250 s**, the default setting) and $\frac{1}{60}$ s (**1/60 s**). To enable Auto FP High-Speed Sync when using Speedlights that support the Nikon Creative Lighting System (CLS), select **1/250 s (Auto FP)** (flash sync speed will be set to $\frac{1}{250}$ s if the built-in flash fires or the attached Speedlight is not CLS-compatible). When the camera shows a shutter speed of $\frac{1}{250}$ s in exposure mode **P** or **A**, Auto FP High-Speed Sync will be activated if the actual shutter speed is faster than $\frac{1}{250}$ s.

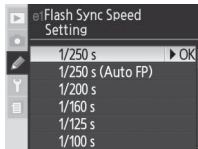

Fixing Shutter Speed at the Flash Sync Speed Limit

To fix shutter speed at the sync speed limit in shutter-priority auto or manual exposure modes, select the shutter speed after the slowest possible shutter speed (30 s or **bL bL**). An X will be displayed in the flash sync indicator in the control panel and viewfinder.

Using AA Batteries

EN-EL3e batteries are recommended for best performance. The capacity of AA batteries drops sharply at temperatures below 20°C (68°F) and varies with make and storage conditions; in some cases, batteries may cease to function before their expiry date. Some AA batteries can not be used; due to their limited capacity and performance characteristics, alkaline and nickel-manganese batteries should be used only if no alternative is available and do not use at low temperatures. The camera shows the level of AA batteries as follows:

Control panel	Viewfinder	Description
	—	Batteries fully charged.
	—	Low battery. Ready fresh batteries.
(blinks)	(blinks)	Shutter-release disabled. Change batteries.

Custom Setting e2: Slowest Speed When Using Flash

This option determines the slowest shutter speed possible when using front- or rear-curtain sync or red-eye reduction in programmed auto or aperture-priority auto exposure mode (regardless of the setting chosen, shutter speeds can be as slow as 30 s in shutter-priority auto and manual exposure modes or when the flash is set to slow sync, slow rear-curtain sync, or red-eye reduction with slow sync). Options range from $1/60$ s (**1/60 s**, the default setting) to 30 s (**30 s**).



Custom Setting e3: Built-in Flash Mode



Choose the flash mode for the built-in flash.

TTL (default): Flash output is adjusted automatically in response to shooting conditions.

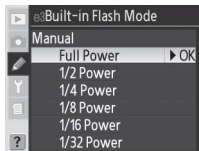

Manual: The flash fires at the level selected in the menu shown at right. Highlight a setting between **Full Power** and **1/128 Power** ($1/128$ of full power) and press the multi-selector right to return to the Custom Settings menu (at full power, built-in Speedlight has a Guide Number of 13/42 [m/ft, ISO 100]).  icons blink in the control panel and viewfinder. No monitor preflash is emitted, allowing the built-in flash to function as a master flash for optional slave flash units when used with a remote Speedlight commander such as the SU-4.



Repeating Flash: The flash fires repeatedly while the shutter is open, producing a strobe-light effect.  icons blink in the control panel and viewfinder when this option is selected. Press the multi selector left or right to highlight the following options, up or down to change. Press the  button to return to the Custom Settings menu when settings are complete.

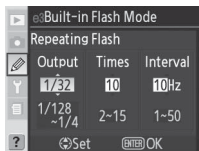

Option	Description
Output	Highlight flash output (expressed as fraction of full power).
Times	Choose number of times flash fires at selected output. Note that depending on shutter speed and option selected for Interval , actual number of flashes may be less than selected.
Interval	Choose number of times flash fires per second.

“Times”

The number of times the flash can fire in succession is determined by flash output.

Options available for “Times”	
Output	2
1/8	2–5
1/16	2–10
1/32	2–10, 15
1/64	2–10, 15, 20, 25
1/128	2–10, 15, 20, 25, 30, 35

Commander Mode: Choose this option to use the built-in flash as a master flash controlling one or more remote optional Speedlights in up to two groups (A and B) using Advanced Wireless Lighting.

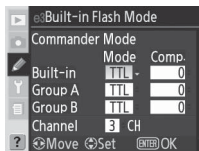

Option	Description
Built-in	Choose flash mode for built-in flash (commander flash).
TTL	i-TTL mode. Menu of flash compensation values will be displayed; choose value between +3.0 and -3.0 EV in steps of 1/3 EV. At settings other than ±0, will be displayed in control panel and viewfinder.
M	Choose flash output level for built-in flash from values between Full Power and 1/128 Power (1/128 of full power). flashes in control panel and viewfinder.
--	Built-in flash does not fire, but AF-assist illuminator lights. Built-in flash must be raised to allow monitor preflashes to fire. is not displayed in control panel flash-sync mode display.
Group A	Choose flash mode for all flashes in group A.
TTL	i-TTL mode. Menu of flash compensation values will be displayed; choose value between +3.0 and -3.0 EV in steps of 1/3 EV.
AA	Auto aperture (not available with SB-600 and SB-R200 Speedlights). Menu of flash compensation values will be displayed; choose value between +3.0 and -3.0 EV in steps of 1/3 EV.
M	Choose flash output level for flashes in Group A from values between Full Power and 1/128 Power (1/128 of full power).
--	Flashes in Group A do not fire.
Group B	Choose flash mode for all flashes in group B.
TTL	i-TTL mode. Menu of flash compensation values will be displayed; choose value between +3.0 and -3.0 EV in steps of 1/3 EV.
AA	Auto aperture (not available with optional SB-600 and SB-R200 Speedlights). Menu of flash compensation values will be displayed; choose value between +3.0 and -3.0 EV in steps of 1/3 EV.
M	Choose flash output level for flashes in Group B from values between Full Power and 1/128 Power (1/128 of full power).
--	Flashes in Group B do not fire.
Channel	Choose from channels 1-4. All Speedlights in both groups must be set to same channel.



To use optional Speedlights in commander mode, select **Commander Mode** for Custom Setting e3 and follow the steps below.

1



Built-in Flash Mode			
Commander Mode			
	Mode	Comp.	
Built-in	TTL	0	
Y Group A	TTL	0	
Group B	TTL	0	
Channel	3	CH	

Highlight **Built-in > Mode**.

2



Built-in Flash Mode			
Commander Mode			
	Mode	Comp.	
Built-in	TTL	0	
Y Group A	TTL	0	
Group B	TTL	0	
Channel	3	CH	

Select desired flash mode.

3



Built-in Flash Mode			
Commander Mode			
	Mode	Comp.	
Built-in	TTL	+1.0	
Y Group A	TTL	0	
Group B	TTL	0	
Channel	3	CH	

Built-in Flash Mode			
Commander Mode			
	Mode	Comp.	
Built-in	M	1/4	
Y Group A	TTL	0	
Group B	TTL	0	
Channel	3	CH	

If **TTL** or **M** is selected, additional options can be selected. Press multi selector up or down to display option, press right to select.

4



Built-in Flash Mode			
Commander Mode			
	Mode	Comp.	
Built-in	TTL	0	
Y Group A	TTL	0	
Group B	TTL	0	
Channel	3	CH	

Highlight **Group A > Mode**.

5



Built-in Flash Mode			
Commander Mode			
	Mode	Comp.	
Built-in	TTL	0	
Y Group A	TTL	0	
Group B	TTL	0	
Channel	3	CH	

Select desired flash mode.

6



Built-in Flash Mode			
Commander Mode			
	Mode	Comp.	
Built-in	TTL	+1.0	
Y Group A	TTL	0	
Group B	TTL	0	
Channel	3	CH	

Built-in Flash Mode			
Commander Mode			
	Mode	Comp.	
Built-in	TTL	0	
Y Group A	M	1/4	
Group B	TTL	0	
Channel	3	CH	

If **TTL**, **AA**, or **M** is selected, additional options can be selected. Press multi selector up or down to display option, press right to select. Repeat Steps 4–6 for **Group B**.

7



Built-in Flash Mode			
Commander Mode			
	Mode	Comp.	
Built-in	TTL	0	
Y Group A	TTL	0	
Group B	TTL	0	
Channel	3	CH	

Highlight **Channel**.

8



Built-in Flash Mode			
Commander Mode			
	Mode	Comp.	
Built-in	TTL	0	
Y Group A	TTL	0	
Group B	TTL	0	
Channel	3	CH	

Select channel.

9 Press **ENTER** button.

10 Compose shot and arrange optional Speedlights as shown below.

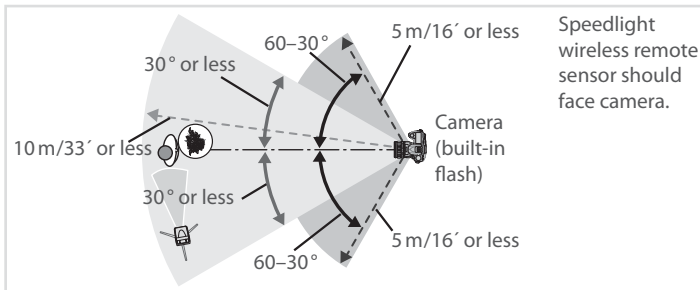

Maximum distance between optional Speedlights and camera is about 10 m (33') when Speedlight is positioned in front of camera (within 30° on either side of center line), or about 5 m (16') when Speedlight is 30–60° to either side of center line.

11 Turn all Speedlights on and set all optional Speedlights to channel selected in Steps 7–8. See Speedlight manual for details.

Commander Mode

Position the sensor windows on the optional Speedlights where they will pick up the monitor preflashes from the built-in flash (take particular care when not using a tripod). Be sure that direct light or strong reflections from the optional Speedlights do not enter the camera lens (in TTL mode) or the photocell on the optional Speedlight (AA mode), as this may interfere with exposure. To prevent the timing flashes emitted by the built-in flash from appearing in photographs taken at short ranges, use a low ISO sensitivity and small aperture (large f/-number) or an optional SG-3IR infrared panel for the built-in flash. An SG-3IR is required for best results with rear-curtain sync, which produces brighter timing flashes. After positioning the Speedlights, take a test shot and view the results in the camera monitor.

Although there is no limit on the number of optional Speedlights that may be used, the practical maximum is three. With more than this number, the light emitted by the other flash units will interfere with performance. All Speedlights must be in the same group; flash compensation (73) applies to all Speedlights. See the Speedlight manual for more information.

If **On** is selected for Custom Setting e4 (**Modeling Flash**, 166), all flashes will emit a modeling flash when the depth-of-field preview button is pressed. Commander mode can also be used with FV lock (81).



- 12** Press flash pop-button to raise built-in flash (note that built-in flash must be raised even if -- is selected for **Built-in > Flash Mode**).

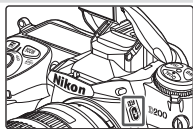

- 13** After confirming that camera flash-ready light and flash-ready lights for all Speedlights are lit, frame photograph, focus, and shoot.

Custom Setting e4: Preview Button Activates Modeling Flash

At the default setting of **On**, the built-in flash and optional Speedlights that support the Nikon Creative Lighting System will emit a modeling flash when the depth-of-field preview button is pressed. Select **Off** to disable this feature.



Custom Setting e5: Auto Bracketing Set

This option controls what settings are affected when auto bracketing is in effect.

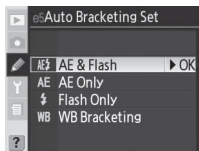

Option	Description
AE & Flash (default)	Camera performs exposure and flash-level bracketing.
AE Only	Camera performs exposure bracketing only.
Flash Only	Camera performs flash-level bracketing only.
WB Bracketing	Camera performs white balance bracketing (not available at image quality settings of NEF/RAW or NEF+JPEG).

Custom Setting e6: Auto Bracketing in M Exposure Mode

This option controls what settings are affected when **AE & Flash** or **AE Only** is selected for Custom Setting e5 in manual exposure mode.

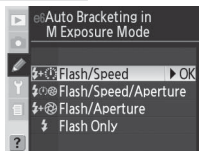

Option	Description
Flash/Speed (default)	Camera varies shutter speed (Custom Setting e5 set to AE Only) or shutter speed and flash level (Custom Setting e5 set to AE & Flash).
Flash/Speed/Aperature	Camera varies shutter speed and aperture (Custom Setting e5 set to AE Only) or shutter speed, aperture, and flash level (Custom Setting e5 set to AE & Flash).
Flash/Aperature	Camera varies aperture (Custom Setting e5 set to AE Only) or aperture and flash level (Custom Setting e5 set to AE & Flash).
Flash Only	Camera varies flash level only (Custom Setting e5 set to AE & Flash).

- If no flash is attached when Custom Setting b1 (**ISO Auto**) is on, camera will vary ISO sensitivity only, regardless of setting selected.
- Flash bracketing performed only with i-TTL or AA flash control.

Custom Setting e7: Auto Bracketing Order

This option controls the order in which bracketing is performed.

Option	Description
MTR>Under>Over (default)	Bracketing performed in order described in "Bracketing" (73).
Under>MTR>Over	Bracketing proceeds in order from lowest to highest value.

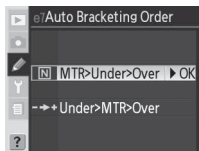

Custom Setting e8: Auto Bracketing Selection Method

This option controls how the bracketing program is selected.

Option	Description
Manual Value Select (default)	Pressing BKT button, rotate main command dial to select number of shots, sub-command dial to select bracketing increment.
Preset Value Select	Press BKT button and rotate main command dial to turn bracketing on and off. Press BKT button and rotate sub-command dial to select number of shots and bracketing increment.

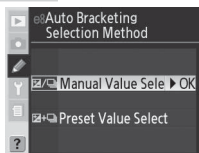

Custom Setting f1: Multi-Selector Center Button

This option determines what operations can be performed by pressing the center of the multi selector.



Shooting Mode: This option controls what operation can be performed by pressing the center of the multi selector when the camera is in shooting mode.



Option	Description
Center AF Area (default)	Pressing center of multi selector selects center focus area or center focus-area group (group dynamic-AF). If Pattern 2 is selected for Custom Setting a4 (Group Dynamic AF), center of multi selector can be used to toggle between center focus area groups.
Illuminate AF Area	Pressing center of multi selector illuminates active focus area or focus-area group (group dynamic-AF) in viewfinder.*
Not Used	Pressing center of multi selector has no effect when camera is in shooting mode.*

* Center of multi selector can not be used to toggle between center focus-area groups when **Pattern 2** is selected for Custom Setting a4 (**Group Dynamic AF**).

Playback Mode: This option controls what operation is performed when the center of the multi selector is pressed in playback mode.



Option	Description
Thumbnail On/Off (default)	Press center of multi selector to toggle between single-image and thumbnail playback.
Histogram On/Off	Press center of multi selector to turn histogram display on and off.
Zoom On/Off	Press center of multi selector to zoom in on image, press again to return to full-frame display or thumbnail playback. When this option is selected, menu of zoom settings is displayed. Choose from Low Magnification , Medium Magnification , and High Magnification .

Custom Setting f2: When Multi-Selector Is Pressed;

If desired, the multi selector can be used to activate the exposure meters or initiate autofocus.

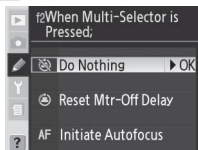

Option	Description
Do Nothing (default)	Multi selector does not activate exposure meters or initiate autofocus.
Reset Mtr-Off Delay	Pressing multi selector activates exposure meters.
Initiate Autofocus	In AF-S or AF-C mode, pressing multi selector activates exposure meters. Camera focuses while multi selector is pressed.

Custom Setting f3: Role of Multi-Selector in full-frame Playback

By default, pressing the multi selector up or down during playback displays the other images on the memory card, while pressing the multi selector left or right changes the photo information displayed. These roles can be reversed using Custom Setting f3.

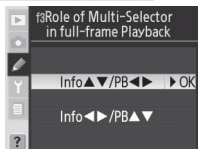

Option	Description
Info▲▼/PB◀▶ (default)	Press multi selector up or down to change photo info displayed, left or right to display additional images.
Info◀▶/PB▲▼	Press multi selector up or down to display additional images, left or right to change photo info displayed.

Using the Multi Selector

The multi selector can be used at any time when the monitor is on. The focus selector lock switch only takes effect when the monitor is off.

Custom Setting f4: Assign FUNC. Button

This option controls the function performed by the FUNC. button.

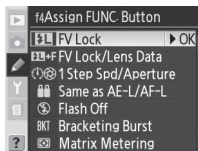



Option	Description
FV Lock (default)	If built-in flash or optional CLS-compatible Speedlight is used, flash value locks when FUNC. button is pressed. Press again to cancel FV lock.
FV Lock/ Lens Data	As above, except that if built-in flash is lowered or optional CLS-compatible Speedlight is not attached, FUNC. button and command dials can be used to specify focal length and aperture of non-CPU lenses (93).
1 Step Spd/ Aperture	If FUNC. button is pressed when rotating command dials, changes to shutter speed (exposure modes S and M) and aperture (exposure modes A and M) are made in increments of 1 EV.
Same as AE-L/AF-L	FUNC. button performs same functions as AE-L/AF-L button.
Flash Off	Flash will not fire in photos taken while FUNC. button is pressed.
Bracketing Burst	While FUNC. button is pressed, all shots in exposure or flash bracketing program will be taken each time shutter-release button is pressed. In continuous high-speed and continuous low-speed modes, camera will repeat bracketing burst while shutter-release button is held down. If white-balance bracketing is selected, camera will take photos at up to 5 fps (single or continuous high-speed mode) or 1–4 fps (continuous low-speed mode) and perform white balance bracketing on each frame.
Matrix Metering	Matrix metering activated while FUNC. button is pressed.
Center- Weighted	Center-weighted metering activated while FUNC. button is pressed.
Spot Metering	Spot metering activated while FUNC. button is pressed.
Focus Area Frame	Press FUNC. button and rotate command dials to cycle between normal and wide focus areas (56).

Custom Setting f5: Customize Command Dials

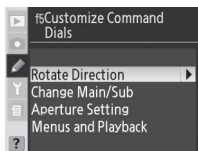
This option controls the operation of the main and sub-command dials.

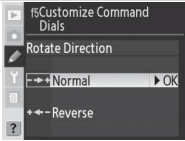
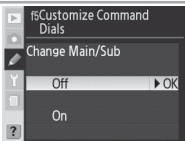
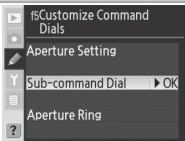

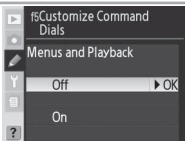
Option	Description
Rotate Direction	<p>Controls operation of command dials on camera and optional MB-D200 battery pack when setting flexible program, shutter speed, aperture, easy exposure compensation, exposure mode, exposure compensation value, bracketing increment, and flash sync mode.</p> <ul style="list-style-type: none"> • Normal (default): Normal command dial operation. • Reverse: Reverses rotation of command dials. 
Change Main/Sub	<p>Exchanges functions of main and sub-command dials when setting shutter speed and aperture.</p> <ul style="list-style-type: none"> • Off (default): Main command dial controls shutter speed, sub-command dial controls aperture. • On: Main command dial controls aperture, sub-command dial controls shutter speed. 
Aperture Setting	<p>Controls whether changes to aperture are made using lens aperture ring or command dials. Regardless of setting chosen, lens ring must be used to set aperture for non-CPU lenses, command dials to set aperture for type G lenses not equipped with aperture ring.</p> <ul style="list-style-type: none"> • Sub-command Dial (default): Aperture can only be adjusted with sub-command dial (or main command dial if Change Main/Sub is On). • Aperture Ring: Aperture can only be adjusted using lens aperture ring. Camera aperture display shows aperture in increments of 1 EV. This option is selected automatically when non-CPU lens is attached. 
Menus and Playback	<p>Controls functions performed by command dials during playback or when menus are displayed.</p> <ul style="list-style-type: none"> • Off (default): Multi selector used to choose picture displayed, highlight thumbnails, and navigate menus. • On: Main command dial performs same function as pressing multi selector left or right. Sub-command dial performs same function as pressing multi selector up or down. Note that this option has no effect on the roles played by the command dials during playback zoom. <p>Single-image playback: main command dial is used to choose picture displayed, sub-command dial to display additional photo information.</p> <p>Thumbnail playback: main command dial moves cursor left or right, sub-command dial moves cursor up or down.</p> <p>Menu navigation: main command dial moves highlight bar up or down. Rotate sub-command dial to right to display sub-menu, to left to return to previous menu. To make selection, press multi selector to right, press center of multi selector, or press  button.</p> 

Custom Setting f6: Setting Method for Buttons and Dials

This option allows adjustments that are normally made by pressing the **MODE**, **ISO**, **BKT**, **ISO**, **QUAL**, or **WB** button and rotating a command dial to be made by rotating the command dial after the button is released.

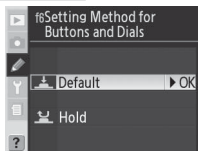

Option	Description
Default (default)	Changes to settings made by rotating command dial while button is held down.
Hold	Settings can be changed by rotating command dial after button is released. To exit, press button again, press shutter-release button halfway, or (except when No Limit is selected for Custom Setting c3 or optional AC adapter is used) wait for about 20s.

Custom Setting f7: Disable Shutter If No Memory Card

This option can be used to enable the shutter release when no memory card is inserted in the camera. Note that when photographs are being captured to a computer using Nikon Capture 4 Camera Control, photographs are not recorded to the camera memory card and the shutter release will be enabled regardless of the setting chosen for this option.

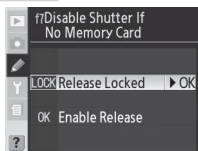

Option	Description
Release Locked (default)	Shutter-release button disabled when no memory card is inserted.
Enable Release	Shutter-release button enabled when no memory card is inserted. Photographs taken when no memory card is inserted are not saved, although they will be displayed in monitor.

Technical Notes

Optional Accessories

One advantage of digital SLR cameras is the wide variety of accessories available for broadening the scope of digital photography. See Nikon websites or recent product catalogs for the latest information on accessories for the D200.

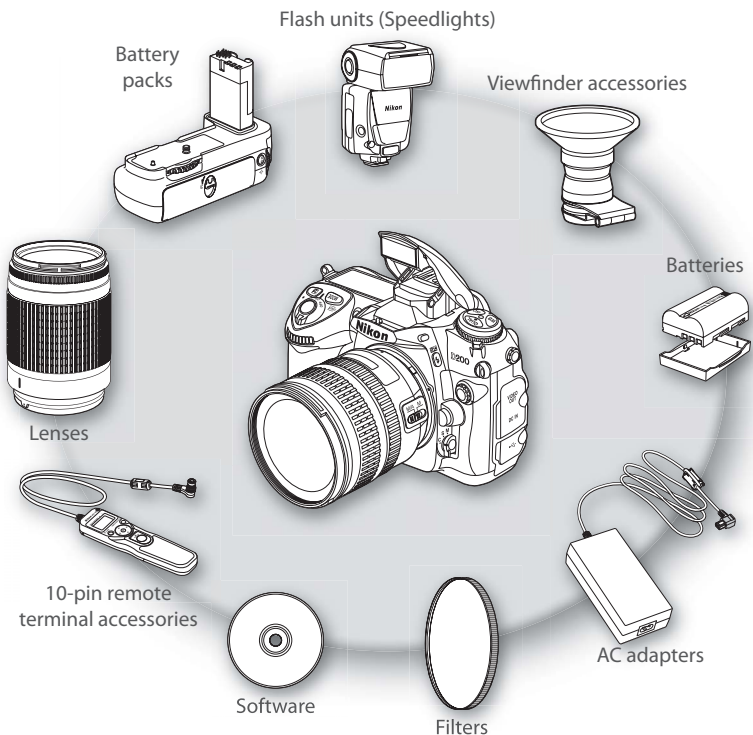

✔ Use Only Nikon Brand Accessories

Only Nikon brand accessories certified by Nikon specifically for use with your Nikon digital camera are engineered and proven to operate within its operational and safety requirements. THE USE OF NON-NIKON ACCESSORIES COULD DAMAGE YOUR CAMERA AND MAY VOID YOUR NIKON WARRANTY.



Lenses

CPU lenses (particularly type G and D lenses) are recommended for use with the D200 (note that IX Nikkor CPU lenses can not be used).

The following lenses can be used with the D200:

Camera setting		Focus		Mode		Metering			
		AF	M (with electronic range finder)	M	P S	A M	3D	Color	
Lens/accessory									
CPU lenses¹	Type G or D AF Nikkor ² ; AF-S, AF-I Nikkor	✓	✓	✓	✓	✓	✓	—	✓ ³
	PC-Micro Nikkor 85 mm f/2.8D ⁴	—	✓ ⁵	✓	—	✓ ⁶	✓	—	✓ ³
	AF-S/AF-I Teleconverter ⁷	✓ ⁸	✓ ⁸	✓	✓	✓	✓	—	✓ ³
	Other AF Nikkor (except lenses for F3AF)	✓ ⁹	✓ ⁹	✓	✓	✓	—	✓	✓ ³
	AI-P Nikkor	—	✓ ¹⁰	✓	✓	✓	—	✓	✓ ³
Non-CPU lenses¹¹	AI-modified, AI-, AI-S, or Series E Nikkor ¹²	—	✓ ¹⁰	✓	—	✓ ¹³	—	✓ ¹⁴	✓ ¹⁵
	Medical Nikkor 120 mm f/4	—	✓	✓	—	✓ ¹⁶	—	—	—
	Reflex Nikkor	—	—	✓	—	✓ ¹³	—	—	✓ ¹⁵
	PC-Nikkor	—	✓ ⁵	✓	—	✓ ¹⁷	—	—	✓
	AI-type Teleconverter ¹⁸	—	✓ ⁸	✓	—	✓ ¹³	—	✓ ¹⁴	✓ ¹⁵
	TC-16A AF Teleconverter	—	✓ ⁸	✓	—	✓ ¹³	—	✓ ¹⁴	✓ ¹⁵
	PB-6 Bellows Focusing Attachment ¹⁹	—	✓ ⁸	✓	—	✓ ²⁰	—	—	✓
	Auto extension rings (PK-series 11-A, 12, or 13; PN-11)	—	✓ ⁸	✓	—	✓ ¹³	—	—	✓

1 IX Nikkor lenses can not be used.

2 Vibration Reduction (VR) supported with VR lenses.

3 Spot metering meters selected focus area.

4 The camera's exposure metering and flash control systems do not work properly when shifting and/or tilting the lens, or when an aperture other than the maximum aperture is used.

5 Electronic range finder can not be used with shifting or tilting.

6 Manual exposure mode only.

7 Compatible with AF-I Nikkor lenses and with all AF-S lenses except AF-S DX VR ED 18–200 mm f/3.5–5.6G; AF-S DX ED 12–24 mm f/4G, 17–55 mm f/2.8G, 18–55 mm f/3.5–5.6G, 18–70 mm f/3.5–4.5G, and 55–200 mm f/4–5.6G; AF-S VR ED 24–120 mm f/3.5–5.6G; and AF-S ED 17–35 mm f/2.8D, 24–85 mm f/3.5–4.5G, and 28–70 mm f/2.8D.

8 With maximum effective aperture of f/5.6 or faster.

9 If AF 80–200 mm f/2.8S, AF 35–70 mm f/2.8S, new-model AF 28–85 mm f/3.5–4.5S, or AF 28–85 mm f/3.5–4.5S is zoomed in while focusing at minimum range, image on matte screen in viewfinder may not be in focus when in-focus indicator is displayed. Focus manually using image in viewfinder as guide.

10 With maximum aperture of f/5.6 or faster.

11 Some lenses can not be used (see following page).

12 Range of rotation for Ai 80–200 mm f/2.8S ED tripod mount limited by camera body. Filters can not be exchanged while Ai 200–400 mm f/4S ED is mounted on camera.

13 If maximum aperture is specified using **Non-CPU Lens Data** option in shooting menu, aperture value will be displayed in viewfinder and control panel.

14 Can be used only if lens focal length and maximum aperture are specified using **Non-CPU Lens Data** option in shooting menu. Use spot or center-weighted metering if desired results are not achieved.

15 For improved precision, specify lens focal length and maximum aperture using **Non-CPU Lens Data** option in shooting menu.

16 Can be used at in manual exposure modes at shutter speeds slower than 1/125 s. If maximum aperture is specified using **Non-CPU Lens Data** option in shooting menu, aperture value will be displayed in viewfinder and control panel.

17 Exposure determined by presetting lens aperture. In aperture-priority auto exposure mode, preset aperture using lens aperture ring before performing AE lock or shifting lens. In



manual exposure mode, preset aperture using lens aperture ring and determine exposure before shifting lens.

- 18 Exposure compensation required when used with AI 28–85 mm f/3.5–4.5S, AI 35–105 mm f/3.5–4.5S, AI 35–135 mm f/3.5–4.5S, or AF-S 80–200 mm f/2.8D. See teleconverter manual for details.

19 Requires PK-12 or PK-13 auto extension ring.

20 Use preset aperture. In exposure mode A, set aperture using focusing attachment before determining exposure and taking photograph.

• PF-4 Reprocopy Outfit requires PA-4 Camera Holder.

✓ Incompatible Accessories and Non-CPU Lenses

The following accessories and non-CPU lenses can NOT be used with the D200:

- Non-AI lenses
- Lenses that require the AU-1 focusing unit (400 mm f/4.5, 600 mm f/5.6, 800 mm f/8, 1200 mm f/11)
- Fisheye (6 mm f/5.6, 8 mm f/8, OP 10 mm f/5.6)
- 21 mm f/4 (old type)
- K2 rings
- ED 180–600 mm f/8 (serial numbers 174041–174180)
- ED 360–1200 mm f/11 (serial numbers 174031–174127)
- 200–600 mm f/9.5 (serial numbers 280001–300490)
- Lenses for the F3AF (80 mm f/2.8, 200 mm f/3.5, TC-16 Teleconverter)
- PC 28 mm f/4 (serial number 180900 or earlier)
- PC 35 mm f/2.8 (serial numbers 851001–906200)
- PC 35 mm f/3.5 (old type)
- 1000 mm f/6.3 Reflex (old type)
- 1000 mm f/11 Reflex (serial numbers 142361–143000)
- 2000 mm f/11 Reflex (serial numbers 200111–200310)

✍ Compatible Non-CPU Lenses

If lens data are specified using the **Non-CPU Lens Data** option in the shooting menu, many of the features available with CPU lenses can also be used with non-CPU lenses. If lens data are not specified, color matrix metering can not be used, and center-weighted metering is used when matrix metering is selected.

Non-CPU lenses can only be used in exposure modes A and M, when aperture must be set using the lens aperture ring. If the maximum aperture has not been specified using **Non-CPU Lens Data**, the camera aperture display will show the number of stops from maximum aperture; the actual aperture value must be read off the lens aperture ring. Aperture-priority auto will be selected automatically in exposure modes P and S. The exposure-mode indicator in the control panel will blink, and **A** will be displayed in the viewfinder.



CPU lenses can be identified by the presence of CPU contacts. Type G lenses are marked with a “G” on the lens barrel, type D lenses with a “D.”

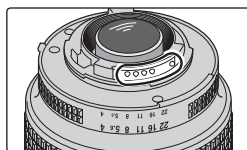

CPU lens

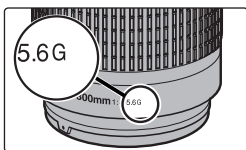

Type G lens

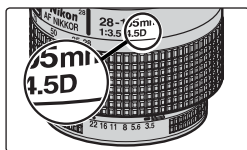

Type D lens

Type G lenses are not equipped with a lens aperture ring. Unlike other CPU lenses, there is no need to lock the aperture ring at the minimum aperture setting (maximum f/-number) when using a type G lens.

Picture Angle and Focal Length

The diagonal picture angle of the D200 is less than that of a 35-mm camera. When calculating the focal length of the lenses for the D200 in 35-mm format, multiply the focal length of the lens by about 1.5:

Option	Approximate focal length (mm) in 35-mm format (modified for picture angle)							
35-mm camera	17	20	24	28	35	50	60	85
D200	25.5	30	36	42	52.5	75	90	127.5
35-mm camera	105	135	180	200	300	400	500	600
D200	157.5	202.5	270	300	450	600	750	900

Calculating Picture Angle

The size of the area exposed by a 35-mm camera is 36×24 mm. The size of the area exposed by the D200, in contrast, is 23.6×15.8 mm, meaning that the diagonal picture angle of a 35-mm camera is approximately 1.5 times that of the D200.

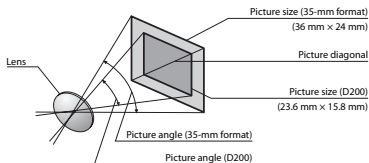

Optional Flash Units (Speedlights)

When used with a compatible device such as the SB-800, SB-600, and remote SB-R200 Speedlights (available separately), the D200 supports the full range of options available with the Nikon Creative Lighting System (CLS), including i-TTL flash control (📷 76), FV Lock (📷 81), and Auto FP High-Speed Sync (📷 160). Support for Advanced Wireless Lighting allows the built-in flash to be used as a commander unit for remote SB-800, SB-600, and SB-R200 Speedlights. See the Speedlight manual for details. Note that the built-in Speedlight will not fire when an optional Speedlight is attached.

SB-800 and SB-600 Speedlights

These high performance Speedlights have Guide Numbers of 38/125 and 30/98 respectively (m/ft, 35-mm zoom head position, ISO 100, 20°C/68°F). The flash head can be rotated through 90° above the horizontal, 180° left, and 90° right for bounce-flash or close-up photography. The SB-800 can be rotated 7° below the horizontal. Auto power zoom (24–105 mm and 24–85 mm, respectively) ensures that the illuminating angle is adjusted in accord with lens focal length. The built-in wide panel can be used for an angle of 14 mm (the SB-800 also supports 17 mm). An illuminator is included to assist in adjusting settings in the dark.

SB-R200 Wireless Remote Speedlight

This high-performance wireless remote Speedlight has a Guide Number of 10/32 (m/ft, ISO 100, 20°C/68°F). Although it cannot be mounted on the camera accessory shoe, the SB-R200 can be fired using an optional SB-800 Speedlight or SU-800 wireless Speedlight commander, or a camera with Advanced Wireless Lighting and a built-in flash. With the D200 in commander mode (📷 163), the SB-R200 serves as a remote flash. It can be held by hand, placed on an AS-20 Speedlight stand, or mounted on the camera lens using the SX-1 attachment for remote control and close-up i-TTL photography.

Use Only Nikon Flash Accessories

Use only Nikon Speedlights. Negative voltages or voltages over 250V applied to the accessory shoe could not only prevent normal operation, but damage the sync circuitry of the camera or flash. Before using a Nikon Speedlight not listed in this section, contact a Nikon-authorized service representative for more information.



The following features are available with the SB-800, SB-600, and SB-R200:

Flash mode/feature		Speedlight		Advanced Wireless Lighting		
		SB-800	SB-600	SB-800	SB-600 ¹	SB-R200 ²
i-TTL ³		✓ ⁴	✓ ⁴	✓	✓	✓
AA	Auto aperture ⁵	✓ ⁶	—	✓	—	—
A	Non-TTL auto	✓ ⁶	—	✓ ⁷	—	—
GN	Range-priority manual	✓	—	—	—	—
M	Manual	✓	✓	✓	✓	✓
RPT	Repeating flash	✓	—	✓ ⁹	✓ ⁹	—
REAR	Rear-curtain sync	✓	✓	✓	✓	✓
	Red-eye reduction	✓	✓	✓	—	—
Flash Color Information Communication		✓	✓	—	—	—
Auto FP High-Speed Sync ⁸		✓	✓	✓ ⁹	✓ ⁹	✓ ⁹
FV lock		✓	✓	✓	✓	✓
AF-assist for multi-area AF ¹⁰		✓ ⁵	✓ ⁵	—	—	—
Auto zoom		✓	✓	—	—	—
ISO Auto (Custom Setting b1)		✓	✓	—	—	—

1 Functions as remote flash only.

2 Can not be mounted on camera accessory shoe. Can be used as remote flash if camera is in commander mode ( 163) or SB-800 Speedlight is mounted on camera and SB-R200 is controlled by optional SU-800 wireless Speedlight commander.

3 When using non-CPU lens with i-TTL Balanced Fill-Flash for Digital SLR, improved precision can be obtained if lens data are specified in **Non-CPU Lens Data** menu.

4 Standard i-TTL for Digital SLR is used with spot metering or when selected with Speedlight.

5 Not available with non-CPU lenses unless lens data have been specified using **Non-CPU Lens Data**.

6 Use Speedlight controls to select flash mode.

7 Available only if non-CPU lens is used without specifying lens data in **Non-CPU Lens Data** menu.

8 Select **1/250 s (Auto FP)** for Custom Setting e2 (**Flash Sync Speed**;  161). Not available if built-in flash fires.

9 Available only when SB-800 is used as master flash or optional SU-800 wireless Speedlight commander is used.

10 Available with AF CPU lenses only.

The following Speedlights can be used in non-TTL auto and manual modes. If they are set to TTL, the camera shutter-release button will lock and no photographs can be taken.

Flash mode		Speedlight	SB-80DX, SB-28DX, SB-28, SB-26, SB-25, SB-24	SB-50DX, SB-23, SB-29 ² , SB-21B ² , SB-29S ²	SB-30, SB-27 ¹ , SB-22S, SB-22, SB-20, SB-16B, SB-15
		A	Non-TTL auto	✓	—
M	Manual	✓	✓	✓	
	Repeating flash	✓	—	—	
REAR	Rear-curtain sync	✓	✓	✓	

1 When an SB-27 is mounted on the D200, the flash mode is automatically set to TTL, and the shutter-release will be disabled. Set the SB-27 to A (non-TTL auto flash).

2 Autofocus is only available with AF-Micro lenses (60 mm, 105 mm, or 200 mm).



Notes on Optional Speedlights

Refer to the Speedlight manual for detailed instructions. If the Speedlight supports the Creative Lighting System, refer to the section on CLS-compatible digital SLR cameras. The D200 is not included in the “digital SLR” category in the SB-80DX, SB-28DX, and SB-50DX manuals.

If Auto FP High-Speed Sync is not used, the shutter will synchronize with an external flash at speeds of $1/250$ s or slower.

i-TTL flash control can be used at ISO sensitivities between 100 and 1600. At values over 1600, the desired results may not be achieved at some ranges or aperture settings. If the flash-ready indicator blinks for about three seconds after a photograph is taken, the flash has fired at full power and the photograph may be underexposed.

When an SB-800 or SB-600 is attached, AF-assist illumination and red-eye reduction are performed by the optional Speedlight. The camera provides AF-assist illumination when other Speedlights are used  58–59).

Auto power zoom is available only with SB-800 and SB-600 Speedlights.

In programmed auto, the maximum aperture (minimum f -number) is limited according to sensitivity (ISO equivalency), as shown below:

Maximum aperture at ISO equivalent of:												
100	125	160	200	250	320	400	500	640	800	1000	1250	1600
4	4.2	4.5	4.8	5	5.3	5.6	6	6.3	6.7	7.1	7.6	8

For each one-step increase in sensitivity (e.g., from 200 to 400), aperture is stopped down by half an f -stop. If the maximum aperture of the lens is smaller than given above, the maximum value for aperture will be the maximum aperture of the lens.

When an SC-series 17, 28, or 29 sync cable is used for off-camera flash photography, correct exposure may not be achieved in i-TTL mode. We recommend that you choose spot metering to select standard i-TTL flash control. Take a test shot and view the results in the monitor.

In i-TTL, use the flash panel or bounce adapter provided with your Speedlight. Do not use other panels such as diffusion panels, as this may produce incorrect exposure.



The Accessory Shoe

The D200 is equipped with an accessory shoe that allows SB-series Speedlights, including the SB-800, 600, 80DX, 50DX, 28DX, 28, 27, 23, 22S, and 29S to be mounted directly on the camera without a sync cable. The accessory shoe is equipped with a safety lock for Speedlights with a locking pin, such as the SB-800 and SB-600.

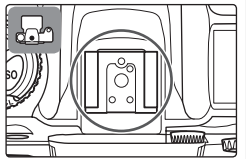

The Sync Terminal

A sync cable can be connected to the sync terminal as required. Do not connect another Speedlight via a sync cable when performing rear-curtain sync flash photography with an SB-series Speedlights such as the 800, 600, 80DX, 28DX, 28, 50DX, 27, 23, 22s, or 29s mounted on the camera accessory shoe.

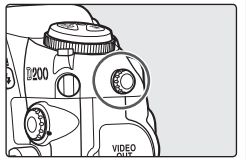

ISO Sensitivity (SB-800/SB-600)

When used with optional SB-800 and SB-600 Speedlights, i-TTL flash control can adjust for ISO sensitivities between 100 and 1600. It may not be able to adjust flash level appropriately for values over 1600. When **On** is selected for Custom Setting b1 (**ISO Auto**;  152), ISO sensitivity will automatically be adjusted as required for optimal flash output. This may result in foreground subjects being underexposed in flash photographs taken at slow shutter speeds, in daylight, or against a bright background. In these cases, choose a flash mode other than slow sync or select mode **A** or **M** and choose a larger aperture.



Other Accessories

At the time of writing, the following accessories were available for the D200. Contact your retailer or local Nikon representative for details.

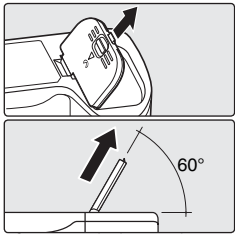
Power sources	<p>◆EN-EL3e Rechargeable Li-ion Battery: Additional EN-EL3e batteries are available from local retailers and Nikon service representatives. EN-EL3a and EN-EL3 batteries can not be used.</p> <p>◆MB-D200 Battery Pack: The MB-D200 takes one or two rechargeable Nikon EN-EL3e Li-ion batteries or six AA alkaline, NiMH, lithium, or nickel-manganese batteries. It is equipped with a shutter-release button and main- and sub-command dials for improved operation when taking photographs in portrait (tall) orientation. When attaching the MB-D200, remove the camera battery cover as shown at right.</p> <p>◆EH-6 AC Adapter: Use the EH-6 to power the camera for extended periods.</p>	
Viewfinder eyepiece accessories	<p>◆Dioptric-Adjustment Viewfinder Lenses: Lenses are available with diopters of -5, -4, -3, -2, 0, $+0.5$, $+1$, $+2$, and $+3\text{m}^{-1}$. Use diopter adjustment lenses only if the desired focus can not be achieved with the built-in diopter adjustment control (-2.0 to $+1.0\text{m}^{-1}$). Test diopter adjustment lenses before purchase to ensure that the desired focus can be achieved.</p> <p>◆DK-21M Magnifying Eyepiece: Increases viewfinder magnification to approximately $1.10\times$ (50-mm $f/1.4$ lens at infinity; -1.0m^{-1}).</p> <p>◆DG-2 Magnifier: Magnify the scene displayed in the center of the viewfinder for close-up photography, copying, telephoto lenses, and other tasks that call for added precision. Eyepiece adapter required (available separately).</p> <p>◆Eyepiece Adapter: Use to attach the DG-2 Magnifier to the D200.</p> <p>◆DR-6 Right-Angle Viewing Attachment: The DR-6 attaches at a right angle to the viewfinder eyepiece, allowing the image in the viewfinder to be viewed from above when the camera is in the horizontal shooting position.</p>	
Filters	<ul style="list-style-type: none">• Nikon filters can be divided into three types: screw-in, drop-in, and rear-interchange. Use Nikon filters; other filters may interfere with autofocus or electronic range finding.• The D200 can not be used with linear polarizing filters. Use the C-PL circular polarizing filter instead.• The NC and L37C filters are recommended for protecting the lens.• When using an R60 filter, set exposure compensation to $+1$.• To prevent moiré, use of a filter is not recommended when the subject is framed against a bright light, or when a bright light source is in the frame.• Center-weighted metering is recommended with filters with exposure factors (filter factors) over $1\times$ (Y48, O56, R60, X0, X1, C-PL, ND45, ND85, A2, A12, B2, B8, B12).	



Remote terminal accessories

The D200 is equipped with a ten-pin remote terminal for remote control and automatic photography. The terminal is provided with a cap, which protects the contacts when the terminal is not in use. The following accessories can be used (cable lengths are given in parentheses; all figures are approximate):

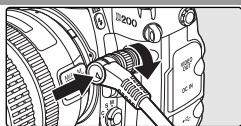

◆**MC-22 Remote Cord** (1 m/3 ft. 3 in.): Remote shutter release with blue, yellow, and black terminals for connection to a remote shutter-triggering device, allowing control via sound or electronic signals.

◆**MC-30 Remote Cord** (80 cm/2 ft. 7 in.): Remote shutter release; can be used to reduce camera shake or keep the shutter open during a time exposure.

◆**MC-36 Remote Cord** (85 cm/2 ft. 9 in.): Remote shutter release; can be used to reduce camera shake or keep the shutter open during a time exposure. Equipped with back-lit control panel, shutter-release lock for use in bulb photography, and timer that beeps at one-second intervals.

◆**MC-21 Extension Cord** (3 m/9 ft. 10 in.): Can be connected to ML-3 or MC-series 22, 23, 25, 30, or 36. Only one MC-21 can be used at a time.

◆**MC-23 Connecting Cord** (40 cm/1 ft. 4 in.): Connects two cameras for simultaneous operation.

◆**MC-25 Adapter Cord** (20 cm/8 in.): Ten-pin to two-pin adapter cord for connection to devices with two-pin terminals, including the MW-2 radio control set, MT-2 intervalometer, and ML-2 modulite control set.

◆**MC-35 GPS Adapter Cord** (35 cm/1 ft. 2 in.): Connects camera to compatible GPS devices via PC cable supplied by manufacturer of GPS device, allowing latitude, longitude, altitude, and UTC (Coordinated Universal Time) to be recorded with photographs (📷 96).

◆**ML-3 Modulite Control Set:** Allows infrared remote control at ranges of up to 8 m (26 ft.).

Body caps

◆**BF-1A Body Cap:** The BF-1A keeps the mirror, viewfinder screen, and low-pass filter free of dust when a lens is not in place.

PC card adapters

◆**EC-AD1 PC Card Adapter:** The EC-AD1 PC card adapter allows Type I CompactFlash memory cards to be inserted in PCMCIA card slots.

Software

◆**Nikon Capture 4 (Version 4.4 or Later):** Nikon Capture 4 Version 4.4 or later can be used to control the camera, capture photos to a computer, and edit and save RAW images in other formats.

◆**Capture NX:** A complete photo editing package.

◆**Camera Control Pro:** Control the camera remotely from a computer and save photographs directly to the computer hard disk.

Approved Memory Cards

The following cards have been tested and approved for use in the D200:

SanDisk	SDCFB	128 MB, 256 MB, 512 MB, 1 GB, 2 GB, 4 GB
	SDCFB (Type II)	300 MB
	SDCF2B (Type II)	256 MB
	SDCFH (Ultra II)	256 MB, 512 MB, 1 GB, 2 GB, 4 GB, 8 GB
	SDCFX (Extreme III)	1 GB, 2 GB, 4 GB
Lexar Media	Entry-level CompactFlash cards	128 MB, 256 MB, 512 MB
	High speed 40x with Write Acceleration (WA)	256 MB, 512 MB, 1 GB
	Professional 40x with WA	8 GB
	Professional 80x with WA	512 MB, 1 GB, 2 GB, 4 GB
	Professional 80x with WA and LockTight technology	512 MB, 2 GB
Microdrive		1 GB, 2 GB, 4 GB, 6 GB

Operation is not guaranteed with other makes of card. For more details on the above cards, please contact the manufacturer.

Memory Cards

- Format memory cards in the camera before first use.
- Turn the power off before inserting or removing memory cards. Do not remove memory cards from the camera, turn the camera off, or remove or disconnect the power source during formatting or while data are being recorded, deleted, or copied to a computer. Failure to observe these precautions could result in loss of data or in damage to the camera or card.
- Do not touch the card terminals with your fingers or metal objects.
- Do not apply force to the card casing. Failure to observe this precaution could damage the card.
- Do not bend, drop, or subject to strong physical shocks.
- Do not expose to heat, water, high levels of humidity, or direct sunlight.



Caring for the Camera

Storage

When the camera will not be used for an extended period, replace the monitor cover, remove the battery, and store the battery in a cool, dry area with the terminal cover in place. To prevent mold or mildew, store the camera in a dry, well-ventilated area. Do not store your camera with naphtha or camphor moth balls or in locations that:

- are poorly ventilated or subject to humidities of over 60%
- are next to equipment that produces strong electromagnetic fields, such as televisions or radios
- are exposed to temperatures above 50°C/122°F (for example, near a space heater or in a closed vehicle on a hot day) or below -10°C (14°F)

Cleaning

Camera body	Use a blower to remove dust and lint, then wipe gently with a soft, dry cloth. After using the camera at the beach or seaside, wipe off sand or salt with a cloth lightly dampened in distilled water and dry thoroughly. IMPORTANT: Dust or other foreign matter inside the camera may cause damage not covered under warranty.
Lens, mirror, and viewfinder	These elements are made of glass and are easily damaged. Remove dust and lint with a blower. If using an aerosol blower, keep the can vertical to prevent the discharge of liquid. To remove fingerprints and other stains, apply a small amount of lens cleaner to a soft cloth and clean with care.
Monitor	Remove dust and lint with a blower. When removing fingerprints and other stains, wipe the surface lightly with a soft cloth or chamois leather. Do not apply pressure, as this could result in damage or malfunction.

The Monitor

Should the monitor break, care should be taken to avoid injury caused by broken glass and to prevent liquid crystal from entering your eyes and mouth.

The Control Panel

Rarely, static electricity may cause the control panel to brighten or darken. This does not indicate a malfunction; the display will shortly return to normal.



The Low-Pass Filter

The image sensor that acts as the camera's picture element is fitted with a low-pass filter to prevent moiré. Although this filter prevents foreign objects from adhering directly to the image sensor, under certain conditions dirt or dust on the filter may appear in photographs. If you suspect that dirt or dust inside the camera is affecting your photographs, you can clean the filter as described below. Note, however, that the low-pass filter is extremely delicate and easily damaged. Nikon recommends that filter be cleaned only by Nikon-authorized service personnel.

1 Remove the lens and turn the camera on.

2 Display the **Mirror Lock-up** menu and press the multi selector right (👉 117; note that this option is not available at battery levels of  or below, while shooting multiple exposures, or when using an optional MB-D200 battery pack with AA batteries). The message shown at right will be displayed and a row of dashes will appear in the control panel and viewfinder. To return to normal operation without raising the mirror, turn the camera off.

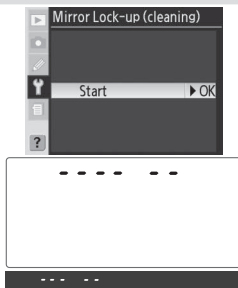

3 Press the shutter-release button all the way down. The mirror will be raised and the shutter curtain will open, revealing the low-pass filter, and a row of dashes will blink in the control panel. The display in the viewfinder will turn off.

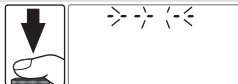

Use a Reliable Power Source

The camera shutter curtain is delicate and easily damaged. If the camera powers off while the mirror is raised, the shutter curtain will close automatically. Observe the following precautions to prevent damage to the curtain:

- Use a fully-charged battery or an EH-6 AC adapter (available separately) for prolonged inspection or cleaning of the low-pass filter.
- Do not turn the camera off or remove or disconnect the power source while the mirror is raised.
- If the battery runs low while the mirror is raised, a beep will sound and the AF-assist illuminator will blink to warn that the shutter curtain will close and the mirror will lower in about two minutes. End cleaning or inspection immediately.

- 4** Holding the camera so that light falls on the low-pass filter, examine the filter for dust or lint. If no foreign objects are present, proceed to Step 6.

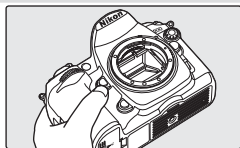

- 5** Remove any dust and lint from the filter with a blower. Do not use a blower-brush, as the bristles could damage the filter. Dirt that can not be removed with a blower can only be removed by Nikon-authorized service personnel. Under no circumstances should you touch or wipe the filter.

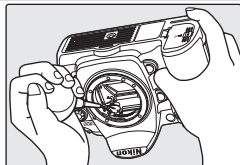

- 6** Turn the camera off. The mirror will return to the down position and the shutter curtain will close. Replace the lens or body cap.

✓ Foreign Matter on the Low-Pass Filter

Nikon takes every possible precaution to prevent foreign matter from coming into contact with the low-pass filter during production and shipping. The D200, however, is designed to be used with interchangeable lenses, and foreign matter may enter the camera when lenses are removed or exchanged. Once inside the camera, this foreign matter may adhere to the low-pass filter, where it may appear in photographs taken under certain conditions. To prevent foreign matter from entering the camera, do not exchange lenses in dusty environments. To protect the camera when no lens is in place, be sure to replace the body cap provided with the camera, being careful to first remove all dust and other foreign matter that may be adhering to the body cap.

Should foreign matter find its way onto the low-pass filter, clean the low-pass filter as instructed on pages 185–186 of this manual, or have the low-pass filter cleaned by authorized Nikon service personnel. Photographs affected by the presence of foreign matter on the low-pass filter can be retouched using Nikon Capture 4 Version 4.4 or later (available separately) or the clean image options available in some third-party imaging software.

✓ Servicing the Camera and Accessories

The D200 is a precision device and requires regular servicing. Nikon recommends that the camera be inspected by the original retailer or Nikon service representative once every one to two years, and that it be serviced once every three to five years (note that fees apply to these services). Frequent inspection and servicing are particularly recommended if the camera is used professionally. Any accessories regularly used with the camera, such as lenses or optional Speedlights, should be included when the camera is inspected or serviced.



Caring for the Camera and Battery: Cautions

Do not drop

The product may malfunction if subjected to strong shocks or vibration.

Keep dry

This product is not waterproof, and may malfunction if immersed in water or exposed to high levels of humidity. Rusting of the internal mechanism can cause irreparable damage.

Avoid sudden changes in temperature

Sudden changes in temperature, such as occur when entering or leaving a heated building on a cold day, can cause condensation inside the device. To prevent condensation, place the device in a carrying case or a plastic bag before exposing it to sudden changes in temperature.

Keep away from strong magnetic fields

Do not use or store this device in the vicinity of equipment that generates strong electromagnetic radiation or magnetic fields. Strong static charges or the magnetic fields produced by equipment such as radio transmitters could interfere with the monitor, damage data stored on the memory card, or affect the product's internal circuitry.

Do not leave the lens pointed at the sun

Do not leave the lens pointed at the sun or another sight source for an extended period. Intense light may cause the image sensor to deteriorate or produce a white blur effect in photographs.

Blooming

Vertical white streaks may appear in photographs of the sun or other strong light sources. This phenomenon, known as “blooming,” can be prevented by reducing the amount of light that falls on the image sensor, either by choosing a slow shutter speed and small aperture or by using an ND filter.

Do not touch the shutter curtain

The shutter curtain is extremely thin and easily damaged. Under no circumstances should you exert pressure on the curtain, poke it with cleaning tools, or subject it to powerful air currents from a blower. These actions could scratch, deform, or tear the curtain.

Handle all moving parts with care

Do not apply force to the battery-chamber, card-slot, or connector covers. These parts are especially susceptible to damage.

Cleaning

- When cleaning the camera body, use a blower to remove dust and lint, then wipe gently with a soft, dry cloth. After using your camera at the beach or seaside, wipe off any sand or salt using a cloth lightly dampened with pure water and then dry your camera thoroughly. In rare instances, static electricity produced by a brush or cloth may cause the LCD displays to light up or darken. This does not indicate a malfunction, and the display will shortly return to normal.
- When cleaning the lens and mirror, remember that these elements are easily damaged. Dust and lint should be gently removed with a blower. When using an aerosol blower, keep the can vertical (tilting the can could result in liquid being sprayed on the mirror). If you do get a fingerprint or other stain on the lens, apply a small amount of lens cleaner to a soft cloth and wipe the lens carefully.
- See “Cleaning the Low-Pass Filter” for information on cleaning the low-pass filter (185).



Storage

- To prevent mold or mildew, store the camera in a dry, well-ventilated area. If you will not be using the product for long periods, remove the battery to prevent leakage and store the camera in a plastic bag containing a desiccant. Do not, however, store the camera case in a plastic bag, as this may cause the material to deteriorate. Note that desiccant gradually loses its capacity to absorb moisture and should be replaced at regular intervals.
- Do not store the camera with naphtha or camphor moth balls, close to equipment that produces strong magnetic fields, or in areas subject to extremes of temperature, for example near a space heater or in a closed vehicle on a hot day.
- To prevent mold or mildew, take the camera out of storage at least once a month. Turn the camera on and release the shutter a few times before putting the camera away again.
- Store the battery in a cool, dry place. Replace the terminal cover before putting the battery away.

Notes on the monitor

- The monitor may contain a few pixels that are always lit or that do not light. This is a characteristic common to all TFT LCD monitors and does not indicate a malfunction. Images recorded with the product will not be affected.
- Images in the monitor may be difficult to see in a bright light.
- Do not apply pressure to the monitor; this could cause damage or malfunction. Dust or lint on the monitor can be removed with a blower. Stains can be removed by rubbing the surface lightly with a soft cloth or chamomile leather.
- Should the monitor break, care should be taken to avoid injury due to broken glass and to prevent the liquid crystal from the monitor touching the skin or entering the eyes or mouth.
- Replace the monitor cover when transporting the camera or leaving it unattended.

Turn the product off before removing or disconnecting the power source

Do not unplug the product or remove the battery while the product is on, or while images are being recorded or deleted. Forcibly cutting power to the product in these circumstances could result in loss of data or in damage to product memory or internal circuitry. To prevent an accidental interruption of power, avoid carrying the product from one location to another while the AC adapter is connected.

Batteries

- Dirt on the battery terminals can prevent the camera from functioning.
- When you turn the device on, check the battery-level displayed in the control panel to determine whether the battery needs to be recharged or replaced. The battery needs to be recharged or replaced when the battery-level indicator is flashing.
- When taking photographs on important occasions, ready a spare EN-EL3e battery and keep it fully charged. Depending on your location, you may find it difficult to purchase replacement batteries on short notice.
- On cold days, the capacity of batteries tends to decrease. Be sure the battery is fully charged before taking photographs outside in cold weather. Keep a spare battery in a warm place and exchange the two as necessary. Once warmed, a cold battery may recover some of its charge.
- Continuing to charge the battery after it is fully charged can impair battery performance.
- Should the battery terminals become dirty, wipe them off with a clean, dry cloth before use.
- After removing the battery from the camera, be sure to replace the terminal cover.
- Used batteries are a valuable resource. Please recycle used batteries in accord with local regulations.

Troubleshooting

If the camera fails to function as expected, check the list of common problems below before consulting your retailer or Nikon representative. Refer to the page numbers in the right-most column for more information.

Problem	Solution	
Camera takes time to turn on.	Delete files or folders.	105, 133
Viewfinder is out of focus.	<ul style="list-style-type: none"> Adjust viewfinder focus. Use optional diopter adjustment lens. 	16 181
Viewfinder is dark.	Charge battery or insert charged battery.	10
Displays turn off without warning.	Choose longer monitor off or meter off delays.	157
Unusual characters displayed in control panel	See "A Note on Electronically Controlled Cameras," below.	—
Displays in control panel or viewfinder are slow and dim	Displays are affected by high or low temperatures.	7
<ul style="list-style-type: none"> Fine lines around active focus area in viewfinder Viewfinder display turns red 	These phenomena are normal and do not indicate a malfunction.	—
Playback menu is unavailable.	Insert memory card.	14
Menu item is unavailable.	Insert memory card. Battery Info option is only available when using EN-EL3e batteries.	14 123
Image size can not be changed.	NEF (RAW) selected for image quality.	28
Shutter release is disabled.	<ul style="list-style-type: none"> Aperture not locked at highest f/-number. Memory card is full or not inserted. Flash is charging. Camera is not in focus. Exposure mode S selected with b u l b selected for shutter speed. 	8 14 79 20 64, 68

A Note on Electronically-Controlled Cameras

In extremely rare instances, unusual characters may appear in the control panel and the camera may stop functioning. In most cases, this phenomenon is caused by a strong external static charge. Turn the camera off, remove and replace the battery (note that the battery may be hot), and turn the camera on again, or, if you are using an AC adapter (available separately), disconnect and reconnect the adapter and turn the camera on again. In the event of continued malfunction, contact your retailer or Nikon representative. Note that disconnecting the power source as described above may result in loss of any data not recorded to the memory card at the time the problem occurred. Data already recorded to the card will not be affected.









Problem	Solution	
Can not select focus area.	• Unlock focus area selector.	53
	• Closest subject priority is in effect.	54
	• Monitor is on: camera in playback mode.	98
	• Exposure meters are off: press shutter-release button halfway.	16
AF-assist illuminator does not light.	• Camera is in focus mode C .	51
	• Center focus area or focus area group is not selected or closest priority is selected for group dynamic-area AF.	53, 54, 149
	• Off selected for Custom Setting a9 (AF Assist).	152
Full range of shutter speeds not available.	• Illuminator has turned off automatically. Illuminator may become hot with continued use; wait for lamp to cool down.	58
	Flash in use. Flash sync speed can be selected using Custom Setting e1 (Flash Sync Speed); when using optional SB-800, SB-600, or SB-R200 Speedlight, choose 1/250 s (Auto FP) for full range of shutter speeds.	160
Focus does not lock when shutter-release button is pressed halfway.	Camera is in focus mode C : use AE-L/AF-L button to lock focus.	56
Area shown in viewfinder is smaller than final photo.	Viewfinder has vertical and horizontal frame coverage of about 95%.	—
Photos are out of focus.	• Rotate focus-mode selector to S or C .	51
	• Camera unable to focus using autofocus: use manual focus or focus lock.	56, 60
Recording time increases.	Turn noise reduction off.	131
Randomly-spaced bright pixels (“noise”) appear in photos.	• Choose lower ISO sensitivity or turn high ISO noise reduction on.	33, 131
	• Shutter speed is slower than 8 s: use long exposure noise reduction.	131
Blotches appear on photos.	• Clean lens.	184
	• Clean low-pass filter.	185
Colors are unnatural.	• Adjust white balance to match light source.	35
	• Adjust Optimize Image settings.	45
Continuous shooting unavailable.	Lower flash.	78
RAW image is not played back.	Photo taken at image quality of NEF+JPEG.	28
Can not measure white balance.	Subject is too dark or too bright.	41
Image can not be selected as source for preset white balance.	Image was not created with D200.	42

Problem	Solution	
White balance bracketing unavailable.	<ul style="list-style-type: none"> • NEF (RAW) or NEF+JPEG image quality option selected for image quality. • White balance set to K (Choose Color Temp.) or PRE (White Balance Preset). • Multiple exposure is being recorded. 	43 38, 40 86
Results for Optimize Image vary from shot to shot.	Select Custom and choose setting other than Auto for Image Sharpening, Tone Compensation, and Saturation .	45
Metering can not be changed.	Autoexposure lock is in effect.	70
Exposure compensation can not be used.	Choose exposure mode P, S, or A .	62
"Tall" (portrait-orientation) photos are displayed in "wide" (landscape) orientation.	<ul style="list-style-type: none"> • Select On for Rotate Tall. • Photo was taken with Off selected for Auto Image Rotation. 	142 119
	<ul style="list-style-type: none"> • Camera orientation was changed while shutter-release button was pressed in continuous mode. • Camera was pointed up or down when shot was taken. 	27 119
Can not delete photo.	Photo is protected: remove protection.	104
Some photos are not displayed during playback.	Select All for Playback Folder . Note that Current will automatically be selected when next photo is taken.	135
Message is displayed stating that no images are available for playback.	Select All for Playback Folder .	135
Can not change print order.	Memory card is full: delete photos.	105, 133
Can not print pictures via direct USB connection.	Set USB to PTP .	121
Can not select photo for printing.	Photo is a RAW (NEF) image. Transfer picture to computer and use supplied software or Nikon Capture 4 Version 4.4 or later (available separately) to print photo.	107, 182
Photo is not displayed on TV.	Choose correct video mode.	117
Can not copy photos to computer.	Choose correct USB option.	121
Can not use Camera Control.	Set USB to PTP .	121
Date of recording is not correct.	Set camera clock.	12







Camera Error Messages and Displays



This section lists the indicators and error messages that appear in the viewfinder, control panel, and monitor when there is a problem with the camera.

Indicator		Problem	Solution	
Control panel	Viewfinder			
FE E (blinks)		Lens aperture ring is not locked at minimum aperture.	Lock ring at minimum aperture (largest f/-number).	8
		Low battery.	Ready fully-charged spare battery.	10
 (blinks)	 (blinks)	<ul style="list-style-type: none"> Battery exhausted. Battery information not available. 	<ul style="list-style-type: none"> Recharge or exchange with fully-charged spare battery. Battery can not be used in camera. 	10 11
CLOCK (blinks)		Camera clock is not set.	Set camera clock.	12
ΔF		No lens attached, or non-CPU lens attached without specifying maximum aperture. Aperture shown in stops from maximum aperture.	Aperture value will be displayed if maximum aperture is specified.	67, 69
	● (blinks)	Camera unable to focus using autofocus.	Focus manually.	60
H i		Subject too bright; photo will be overexposed.	<ul style="list-style-type: none"> Choose lower sensitivity. Use optional Neutral Density (ND) filter In exposure mode: <ul style="list-style-type: none"> S Increase shutter speed A Choose smaller aperture (larger f/-number) 	33 181 64 66
L o		Subject too dark; photo will be underexposed.	<ul style="list-style-type: none"> Choose a higher sensitivity (ISO equivalency) Use optional Speedlight In exposure mode: <ul style="list-style-type: none"> S Lower shutter speed A Choose a larger aperture (smaller f/-number) 	33 177 64 66
b u l b (blinks)		b u l b selected in mode M and mode dial rotated to S .	Change shutter speed or select mode M .	64, 68
 (blinks)	 (blinks)	Speedlight that does not support i-TTL flash control attached and set to TTL.	Change flash mode setting on optional Speedlight.	178



Indicator		Problem	Solution	
Control panel	Viewfinder			
 (blinks)	 (blinks)	Memory insufficient to record further photos at current settings, or camera has run out of file or folder numbers.	<ul style="list-style-type: none"> • Reduce quality or size. • Delete photographs. • Insert new memory card. 	28 105, 133 14
(-E-)	 (blinks) (-E-)	No memory card.	Insert memory card.	14
 (blinks)		Camera malfunction.	Release shutter. If error persists or appears frequently, consult with Nikon-authorized service representative.	viii



Indicator			Problem	Solution	
Monitor	Control panel	Viewfinder			
NO CARD PRESENT	(- E -)	 (blinks) (- E -)	Camera cannot detect memory card.	Turn camera off and confirm that card is correctly inserted.	14
THIS CARD CAN NOT BE USED	(ERR) (blinks)		<ul style="list-style-type: none"> • Error accessing memory card. • Unable to create new folder. 	<ul style="list-style-type: none"> • Use Nikon-approved card. • Check that contacts are clean. If card is damaged, contact retailer or Nikon representative. • Delete files or insert new memory card. 	183 viii 14, 105, 133
CARD IS NOT FORMATTED (displayed when  button is pressed)	(For) (blinks)		Memory card has not been formatted for use in D200.	Format memory card.	14, 116
FOLDER CONTAINS NO IMAGES			<ul style="list-style-type: none"> • Memory card contains no images. • Current folder is empty. 	<ul style="list-style-type: none"> • Insert another card. • Set Playback Folder to All. 	14, 135
ALL IMAGES HIDDEN			All photos in current folder are hidden.	Set Playback Folder to All or use Hide Image to reveal hidden photos.	135, 137
FILE DOES NOT CONTAIN IMAGE DATA			File has been created or modified using a computer or different make of camera, or file is corrupt.	Delete file or reformat memory card.	14, 105, 116, 133



Appendix

The Appendix covers the following topics:

Topic	
Exposure Program (Mode P)	195
Memory Card Capacity and Image Quality/Size	196
Bracketing Programs	197–199
Fine Tuning and Color Temperature	200
Flash Range, Aperture, and Sensitivity	200
Lenses That Can Be Used with the Built-in Flash	201
Supported Standards	202

Exposure Program (Mode P)

The exposure program for mode **P** is shown in the following graph:

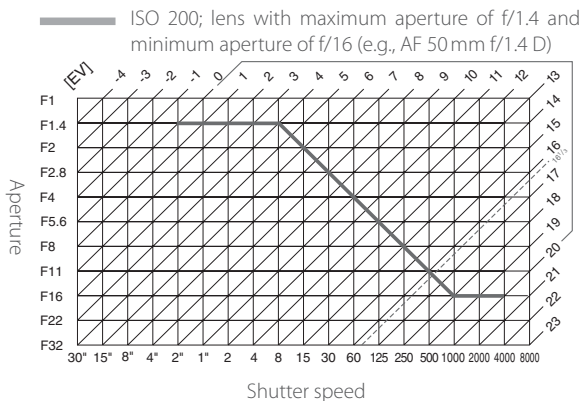

The maximum and minimum values for EV vary with sensitivity (ISO equivalency); the above graph assumes a sensitivity of ISO 200 equivalent. When matrix metering is used, values over $16\frac{1}{3}$ EV are reduced to $16\frac{1}{3}$ EV.



Memory Card Capacity and Image Quality/Size

The following table shows the approximate number of pictures that can be stored on a 1 GB SanDisk SDCFX (Extreme III) series card at different image quality and size settings.

Image quality	Image size	File size (MB) ¹	No. of images ¹	Buffer capacity ^{1,2}
NEF+JPEG Fine ^{3,4,5}	L ⁶	20.7	44	19
	M ⁶	18.6	49	19
	S ⁶	17.1	55	19
NEF+JPEG Normal ^{3,4,5}	L ⁶	18.3	50	19
	M ⁶	17.2	54	19
	S ⁶	16.5	57	19
NEF+JPEG Basic ^{3,4,5}	L ⁶	17.1	55	19
	M ⁶	16.5	57	19
	S ⁶	16.2	58	19
NEF (RAW)	—	15.8	60	22
JPEG Fine ^{5,7}	L	4.8	167	37
	M	2.7	294	56
	S	1.2	650	74
JPEG Normal ^{5,7}	L	2.4	332	54
	M	1.4	578	74
	S	0.63	1200	76
JPEG Basic ^{5,7}	L	1.2	650	57
	M	0.7	1100	75
	S	0.33	2200	76

1 All figures are approximate. File size varies with scene recorded and make of memory card.

2 Maximum number of frames that can be stored in memory buffer at ISO 100. Capacity of memory buffer will drop if noise reduction is on.

3 Total for NEF and JPEG images.

4 Figures assume **RAW Compression** is set to **NEF (RAW)**. Selecting **Comp. NEF (RAW)** decreases file size of NEF (RAW) images by approximately forty to fifty percent; although camera displays do not change, number of images that can be recorded increases.

5 Figures assume **JPEG Compression** is set to **Size Priority**. Selecting **Optimal Quality** increases file size of JPEG images by up to eighty percent; number of images and buffer capacity drop accordingly.

6 Applies to JPEG images only. Size of NEF (RAW) images can not be changed.

7 Regardless of option chosen for **JPEG Compression**, camera never shows more than 25 frames remaining in buffer, even when more shots can be stored.



Bracketing Programs

The following bracketing programs are available when **WB Bracketing** is selected for Custom Setting e5 (**Auto BKT Set**).

Control panel display	No. of shots	WB increment	Bracketing order
+ 3F	3	+1	+1, 0, +2
+ 3F 2	3	+2	+2, 0, +4
+ 3F 3	3	+3	3, 0, 6
-- 3F	3	-1	-1, -2, 0
-- 3F 2	3	-2	-2, -4, 0
-- 3F 3	3	-3	-3, -6, 0
+ 2F	2	+1	0, +1
+ 2F 2	2	+2	0, +2
+ 2F 3	2	+3	0, +3
-- 2F	2	-1	0, -1
-- 2F 2	2	-2	0, -2
-- 2F 3	2	-3	0, -3
3F	3	±1	0, -1, +1
3F 2	3	±2	0, -2, +2
3F 3	3	±3	0, -3, +3
5F	5	±1	0, -2, -1, +1, +2
5F 2	5	±2	0, -4, -2, +2, +4
5F 3	5	±3	0, -6, -3, +3, +6
7F	7	±1	0, -3, -2, -1, +1, +2, +3
7F 2	7	±2	0, -6, -4, -2, +2, +4, +6
7F 3	7	±3	0, -9, -6, -3, +3, +6, +9
9F	9	±1	0, -4, -3, -2, -1, +1, +2, +3, +4
9F 2	9	±2	0, -8, -6, -4, -2, +2, +4, +6, +8
9F 3	9	±3	0, -12, -9, -6, -3, +3, +6, +9, +12



The programs are available when **AE & Flash**, **AE Only** or **Flash Only** is selected for Custom Setting e5 (**Auto BKT Set**) depend on the option selected for Custom Setting b3 (**EV Step**).

1/3 Step Selected for EV Step

Control panel display	No. of shots	Exposure increment	Bracketing order (EVs)
+3F0.3	3	+1/3	+0.3, 0, +0.7
+3F0.7	3	+2/3	+0.7, 0, +1.3
+3F 1.0	3	+1	1.0, 0, 2.0
--3F0.3	3	-1/3	-0.3, -0.7, 0
--3F0.7	3	-2/3	-0.7, -1.3, 0
--3F 1.0	3	-1	-1.0, -2.0, 0
+2F0.3	2	+1/3	0, +0.3
+2F0.7	2	+2/3	0, +0.7
+2F 1.0	2	+1	0, +1
--2F0.3	2	-1/3	0, -0.3
--2F0.7	2	-2/3	0, -0.7
--2F 1.0	2	-1	0, -1
3F0.3	3	$\pm 1/3$	0, -0.3, +0.3
3F0.7	3	$\pm 2/3$	0, -0.7, +0.7
3F 1.0	3	± 1	0, -1, +1
5F0.3	5	$\pm 1/3$	0, -0.7, -0.3, +0.3, +0.7
5F0.7	5	$\pm 2/3$	0, -1.3, -0.7, +0.7, +1.3
5F 1.0	5	± 1	0, -2.0, -1, +1, +2.0
7F0.3	7	$\pm 1/3$	0, -1.0, -0.7, -0.3, +0.3, +0.7, +1.0
7F0.7	7	$\pm 2/3$	0, -2.0, -1.3, -0.7, +0.7, +1.3, +2.0
7F 1.0	7	± 1	0, -3.0, -2.0, -1.0, +1.0, +2.0, +3.0
9F0.3	9	$\pm 1/3$	0, -1.3, -1.0, -0.7, -0.3, +0.3, +0.7, +1.0, +1.3
9F0.7	9	$\pm 2/3$	0, -2.7, -2.0, -1.3, -0.7, +0.7, +1.3, +2.0, +2.7
9F 1.0	9	± 1	0, -4.0, -3.0, -2.0, -1.0, +1.0, +2.0, +3.0, +4.0



1/2 Step Selected for EV Step

Control panel display	No. of shots	Exposure increment	Bracketing order (EVs)
+ 3F 0.5 ⁺	3	+1/2	+0.5, 0, +1.0
+ 3F 1.0 ⁺	3	+1	1.0, 0, 2.0
-- 3F 0.5 ⁻	3	-1/2	-0.5, -1.0, 0
-- 3F 1.0 ⁻	3	-1	-1.0, -2.0, 0
+ 2F 0.5 ⁺	2	+1/2	0, +0.5
+ 2F 1.0 ⁺	2	+1	0, +1
-- 2F 0.5 ⁻	2	-1/2	0, -0.5
-- 2F 1.0 ⁻	2	-1	0, -1
3F 0.5 [±]	3	±1/2	0, -0.5, +0.5
3F 1.0 [±]	3	±1	0, -1, +1
5F 0.5 [±]	5	±1/2	0, -1.0, -0.5, +0.5, +1.0
5F 1.0 [±]	5	±1	0, -2.0, -1, +1, +2.0
7F 0.5 [±]	7	±1/2	0, -1.5, -1.0, -0.5, +0.5, +1.0, +1.5
7F 1.0 [±]	7	±1	0, -3.0, -2.0, -1.0, +1.0, +2.0, +3.0
9F 0.5 [±]	9	±1/2	0, -2.0, -1.5, -1.0, -0.5, +0.5, +1.0, +1.5, +2.0
9F 1.0 [±]	9	±1	0, -4.0, -3.0, -2.0, -1.0, +1.0, +2.0, +3.0, +4.0

1 Step Selected for EV Step

Control panel display	No. of shots	Exposure increment	Bracketing order (EVs)
+ 3F 1.0 ⁺	3	+1	1.0, 0, 2.0
-- 3F 1.0 ⁻	3	-1	-1.0, -2.0, 0
+ 2F 1.0 ⁺	2	+1	0, +1
-- 2F 1.0 ⁻	2	-1	0, -1
3F 1.0 [±]	3	±1	0, -1, +1
5F 1.0 [±]	5	±1	0, -2.0, -1, +1, +2.0
7F 1.0 [±]	7	±1	0, -3.0, -2.0, -1.0, +1.0, +2.0, +3.0
9F 1.0 [±]	9	±1	0, -4.0, -3.0, -2.0, -1.0, +1.0, +2.0, +3.0, +4.0



Fine-Tuning and Color Temperature

Approximate color-temperatures for settings other than **A** (auto) are given below (values may differ from color temperatures given by photo color meters):

	Incandescent	Fluorescent*	Direct sunlight	Flash	Cloudy (daylight)	Shade (daylight)
+3	2,700K	2,700K	4,800 K	4,800 K	5,400K	6,700K
+2	2,800K	3,000K	4,900 K	5,000 K	5,600K	7,100K
+1	2,900K	3,700K	5,000 K	5,200 K	5,800K	7,500K
±0	3,000K	4,200K	5,200 K	5,400 K	6,000K	8,000K
-1	3,100K	5,000K	5,300 K	5,600 K	6,200K	8,400K
-2	3,200K	6,500K	5,400 K	5,800 K	6,400K	8,800K
-3	3,300K	7,200K	5,600 K	6,000 K	6,600K	9,200K

* The size of the increments for **Fluorescent** reflects the wide variations in color temperature among the many different types of fluorescent light source, ranging from low-temperature stadium lighting to high-temperature mercury-vapor lamps.

Using the Built-in Flash

The range of the built-in flash varies with sensitivity (ISO equivalency) and aperture.

Aperture at ISO equivalent of														Range	
100	125	160	200	250	320	400	500	640	800	1000	1250	1600	m	ft.	
1.4	1.6	1.8	2	2.2	2.5	2.8	3.2	3.5	4	4.5	5	5.6	1.0–7.5	3.3–24.6	
2	2.2	2.5	2.8	3.2	3.5	4	4.5	5	5.6	6.3	7.1	8	0.7–5.4	2.3–17.7	
2.8	3.2	3.5	4	4.5	5	5.6	6.3	7.1	8	9	10	11	0.6–3.8	2.0–12.5	
4	4.5	5	5.6	6.3	7.1	8	9	10	11	13	14	16	0.6–2.7	2.0–8.9	
5.6	6.3	7.1	8	9	10	11	13	14	16	18	20	22	0.6–1.9	2.0–6.2	
8	9	10	11	13	14	16	18	20	22	25	29	32	0.6–1.4	2.0–4.6	
11	13	14	16	18	20	22	25	29	32	—	—	—	0.6–0.9	2.0–2.9	
16	18	20	22	25	29	32	—	—	—	—	—	—	0.6–0.7	2.0–2.3	

In programmed auto, the maximum aperture (minimum f/-number) is limited according to sensitivity (ISO equivalency), as shown below:

Maximum aperture at ISO equivalent of:														
100	125	160	200	250	320	400	500	640	800	1000	1250	1600		
2.8	3	3.2	3.3	3.5	3.8	4	4.2	4.5	4.8	5	5.3	5.6		

For each one-step increase in sensitivity (e.g., from 200 to 400), aperture is stopped down by half an f/-stop. If the maximum aperture of the lens is smaller than given above, the maximum value for aperture will be the maximum aperture of the lens.



Lenses That Can Be Used with the Built-in Flash

The built-in flash can be used with any CPU lens with a focal length of 18–300 mm. Note that the flash may be unable to light the entire subject if the following lenses are not used at or above the minimum ranges given below:

Lens	Zoom position	Minimum range
AF-S DX ED 12–24 mm f/4G	18 mm	1.5 m/4 ft. 11 in.
	20 mm	1.0 m/3 ft. 3 in.
AF-S ED 17–35 mm f/2.8D	24 mm	1.0 m/3 ft. 3 in.
AF-S DX IF ED 17–55 mm f/2.8G	24 mm	1.0 m/3 ft. 3 in.
AF ED 18–35 mm f/3.5–4.5D	18 mm	1.5 m/4 ft. 11 in.
AF-S DX VR ED 18–200 mm f/3.5–5.6G	18 mm	1.0 m/3 ft. 3 in.
AF 20–35 mm f/2.8D	20 mm	1.0 m/3 ft. 3 in.
AF-S ED 28–70 mm f/2.8D	28 mm	1.5 m/4 ft. 11 in.
	35 mm	1.0 m/3 ft. 3 in.
AF Zoom Micro Nikkor ED 70–180 mm f/4.5–5.6D	70 mm	1.0 m/3 ft. 3 in.

The built-in flash can also be used with Ai-S, Ai, and Ai-modified non-CPU lenses with a focal length of 18–200 mm. Restrictions apply to the following lenses:

- Ai 50–300 mm f/4.5, Ai-modified 50–300 mm f/4.5, and Ai-S ED 50–300 mm f/4.5: use at 135 mm and above
- Ai ED 50–300 mm f/4.5: use at 105 mm and above



Supported Standards

DCF Version 2.0: Design Rule for Camera File System (DCF) is standard widely used in the digital camera industry to ensure compatibility among different makes of camera.

DPOF: Digital Print Order Format (DPOF) is an industry-wide standard that allows pictures to be printed from print orders stored on the memory card.

Exif version 2.21: The D200 supports Exif (**Ex**changeable **I**mage **F**ile **F**ormat for Digital Still Cameras) version 2.21, a standard that allows information stored with photographs to be used for optimal color reproduction when images are output on Exif-compliant printers.

PictBridge: A standard developed by in cooperation with the digital camera and printer industries, allowing photographs to be output directly to a printer without connecting the camera to a computer.



Specifications

Type	Single-lens reflex digital camera with interchangeable lenses
Effective pixels	10.2 million
CCD	23.6 × 15.8 mm; total pixels: 10.92 million
Image size (pixels)	<ul style="list-style-type: none"> • 3872 × 2592 (Large) • 2896 × 1944 (Medium) • 1936 × 1296 (Small)
Lens mount	Nikon F mount (with AF coupling and AF contacts)
Compatible lenses*	
Type G or D AF Nikkor	All functions supported
Micro Nikkor 85 mm f/2.8D	All functions supported except autofocus and some exposure modes
Other AF Nikkor†	All functions supported except 3D color matrix metering II
AI-P Nikkor	All functions supported except 3D color matrix metering II and autofocus
Non-CPU	Can be used in exposure modes A and M; electronic range finder can be used if maximum aperture is f/5.6 or faster; color matrix metering, i-TTL balanced fill-flash for digital SLR, and aperture value display supported if user provides lens data
* IX Nikkor lenses can not be used	
† Excluding lenses for F3AF	
Picture angle	Equivalent in 35-mm format is approximately 1.5 times lens focal length
Viewfinder	Optical fixed eye-level pentaprism
Diopter adjustment	-2.0 – +1.0 m ⁻¹
Eyepoint	19.5 mm (-1.0 m ⁻¹)
Focusing screen	Type B BriteView clear matte screen Mark II with superimposed focus brackets and On-Demand grid lines
Frame coverage	Approximately 95% of lens (vertical and horizontal)
Magnification	Approximately 0.94× (50-mm lens at infinity; -1.0 m ⁻¹)
Reflex mirror	Quick return
Lens aperture	Instant return with depth-of-field preview
Focus-area selection	Normal: 11 areas; single area or group can be selected Wide: focus area can be selected from 7 areas
Lens servo	Instant single-servo AF (S); continuous-servo AF (C); manual (M); predictive focus tracking automatically activated according to subject status in continuous-servo AF



Autofocus	TTL phase detection by Nikon Multi-CAM1000 autofocus sensor module
Detection range	-1 – +19EV (ISO 100 at 20°C/68°F)
AF-area mode	Single-area AF, dynamic-area AF, group dynamic-AF, dynamic-area AF with closest subject priority
Focus lock	Focus can be locked by pressing shutter-release button halfway (single-servo AF) or by pressing AE-L/AF-L button

Exposure	
Metering	Three-mode through-the-lens (TTL) exposure metering
Matrix	3D color matrix metering II (type G and D lenses); color matrix metering II (other CPU lenses); color matrix metering available with non-CPU lenses if user provides lens data; metering performed by 1,005-segment RGB sensor
Center-weighted	Weight of 75% given to 6, 8, 10, or 13-mm circle in center of frame
Spot	Meters 3-mm circle (about 2.0% of frame) centered on active focus area (on center focus area when non-CPU lens is used)
Range (ISO 100 equivalent, f/1.4 lens, 20 °C/68 °F)	0 – 20 EV (3D color matrix or center-weighted metering) 2 – 20 EV (spot metering)
Exposure meter coupling	Combined CPU and AI
Exposure control	
Operating mode	Programmed auto with flexible program; shutter-priority auto; aperture priority auto; manual
Exposure compensation	-5 – +5 EV in increments of 1/3, 1/2, or 1 EV
Bracketing	Exposure and/or flash bracketing (2–9 exposures in increments of 1/3, 1/2, 2/3, or 1 EV)
Exposure lock	Luminosity locked at detected value with AE-L/AF-L button

Shutter	Electronically-controlled vertical-travel focal-plane shutter
Speed	30 – 1/8000 s in steps of 1/3, 1/2, or 1 EV, bulb
ISO Sensitivity (Recommended Exposure Index)	100– 1600 in steps of 1/3, 1/2, or 1 EV with additional settings up to 1 EV over 1600; auto gain to 1600

White balance	Auto (TTL white-balance with 1,005 pixels RGB sensor), six manual modes with fine-tuning,, color temperature setting, and preset white balance
Bracketing	2–9 exposures in increments of 1, 2, or 3



Built-in flash	Manual pop-up with button release
Guide number (m/ft at ISO 100 and 20 °C/68 °F)	Approximately 12/39 (manual 13/42)
Flash	
Sync contact	X-contact only; flash synchronization at up to 1/250 s
Flash control	
TTL	TTL flash control by 1,005-pixel RGB sensor <ul style="list-style-type: none"> • SB-800, 600: i-TTL balanced fill-flash for digital SLR and standard i-TTL flash for digital SLR
Auto aperture	Available with SB-800 with CPU lens
Non-TTL auto	Available with such Speedlights as SB-800, 80DX, 28DX, 28, 27, and 22s
Range-priority manual	Available with SB-800
Flash sync modes	Front curtain sync (normal), slow sync, rear-curtain sync, red-eye reduction, red-eye reduction with slow sync
Flash compensation	-3 – +1 EV in increments of 1/3 or 1/2 EV
Flash-ready indicator	Lights when SB-series Speedlight such as 800, 600, 80DX, 28DX, 50DX, 28, 27, or 22s is fully charged; blinks for 3 s after flash is fired at full output
Accessory shoe	Standard ISO hot-shoe contact with safety lock
Nikon Creative Lighting System	With SB-800, 600 and R200, supports Advanced Wireless Lighting (SB-600 and R200 only supports AWL when used as remote flash), Auto FP High-Speed Sync, Flash Color Information Communication, modeling illumination, and FV Lock
Storage	
Media	Type I and II CompactFlash memory cards; Microdrives
File system	Compliant with Design Rule for Camera File System (DCF) 2.0 and Digital Print Order Format (DPOF)
Compression	<ul style="list-style-type: none"> • NEF (RAW): compressed 12-bit • JPEG: JPEG baseline-compliant
Self-timer	Electronically controlled timer with 2 – 20 s duration
Depth-of-field preview	When CPU lens is attached, lens aperture can be stopped down to value selected by user (A and M modes) or value selected by camera (P , and S modes)
Monitor	2.5 in., 230,000-dot, low-temperature polysilicon TFT LCD with brightness adjustment
Video output	Can be selected from NTSC and PAL

External interface	USB 2.0 Hi-speed
Tripod socket	¼ in. (ISO)
Firmware upgrades	Firmware can be upgraded by user
Supported languages	Chinese (Simplified and Traditional), Dutch, English, French, German, Italian, Japanese, Korean, Portuguese, Russian, Spanish, Swedish
Power source	<ul style="list-style-type: none"> • One rechargeable Nikon EN-EL3e Li-ion battery; charging voltage (MH-18a quick charger): 7.4V DC • MB-D200 battery pack (available separately) with one or two rechargeable Nikon EN-EL3e Li-ion batteries or six LR6 alkaline, HR-6 NiMH, FR-6 lithium, or ZR6 nickel-manganese AA batteries • EH-6 AC adapter (available separately)
Dimensions (W × H × D)	Approximately 147 × 113 × 74 mm (5.8 × 4.4 × 2.9 in.)
Weight	Approximately 830 g (1 lb 13 oz) without battery, memory card, body cap, or monitor cover

Operating environment

Temperature	0 – +40°C (+32 – 104°F)
Humidity	Less than 85% (no condensation)

- Unless otherwise stated, all figures are for a camera with a fully-charged battery operating at an ambient temperature of 20°C (68°F).
- Nikon reserves the right to change the specifications of the hardware and software described in this manual at any time and without prior notice. Nikon will not be held liable for damages that may result from any mistakes that this manual may contain.

MH-18a Quick Charger

Rated input	AC 100–240V, 50/60 Hz
Rated output	DC 8.4V/900 mA
Supported batteries	EN-EL3e rechargeable Li-ion batteries
Charging time	Approximately 135 minutes
Operating temperature	0 – +40°C (+32 – 104°F)
Dimensions (W × H × D)	Approximately 90 × 35 × 58 mm (3.5 × 1.4 × 2.3 in.)
Length of cord	Approximately 1800 mm (5 ft. 11 in.)
Weight	Approximately 80 g (2.8 oz), excluding power cable

EN-EL3e Rechargeable Li-ion Battery

Type	Rechargeable lithium-ion battery
Rated capacity	7.4V/1500 mAh
Dimensions (W × H × D)	Approximately 39.5 × 56 × 21 mm (1.6 × 2.2 × 0.8 in.)
Weight	Approximately 80 g (2.8 oz), excluding terminal cover

Battery Life

The number of shots that can be taken with a fully-charged EN-EL3e battery (1500 mAh) varies with the condition of the batteries, temperature, and how the camera is used. The following measurements were performed at a temperature of 20 °C (68 °F).

Example 1: 1800 shots

Zoom Nikkor AF-S VR 70–200 mm f/2.8G IF ED lens (VR off); continuous shooting mode; continuous-servo autofocus; image quality set to JPEG Basic; image size set to **M**; shutter speed 1/250 s; shutter-release pressed halfway for three seconds and focus cycled from infinity to minimum range three times with each shot; after six shots, monitor turned on for five seconds and then turned off; cycle repeated once exposure meters have turned off.

Example 2: 340 shots

Zoom Nikkor AF-S VR 24–120 mm f/3.5–5.6G IF ED lens (VR off); single-frame shooting mode; single-servo autofocus; image quality set to JPEG Normal; image size set to **L**; shutter speed 1/250 s; shutter-release pressed halfway for five seconds and focus cycled from infinity to minimum range once with each shot; built-in Speedlight fired at full power with every other shot; AF-assist illuminator lights when Speedlight is used; cycle repeated once exposure meters have turned off; camera turned off for one minute with every ten shots.

The following can reduce battery life:

- Using the monitor
- Repeated autofocus operations
- Keeping the shutter-release button pressed halfway
- Taking NEF (RAW) photographs
- Slow shutter speeds

To ensure maximum battery performance:

- Keep the battery contacts clean. Soiled contacts can reduce battery performance.
- Use EN-EL3e batteries immediately after charging. Batteries will lose their charge if left unused.

The battery level displayed by the camera may vary with changes in temperature.



Menus

- ▶ **PLAYBACK MENU**, 133–142
 - Delete, 133–134
 - Playback Folder, 135
 - Slide Show, 135–136
 - Hide Image, 137–138
 - Print Set, 139–140
 - Display Mode, 141
 - Image Review, 141
 - After Delete, 142
 - Rotate Tall, 142
- 📷 **SHOOTING MENU**, 124–132
 - Shooting Menu Bank, 125–126
 - Menu Reset, 127
 - Folders, 128
 - File Naming, 129
 - Optimize Image, 45–49
 - Color Space, 50
 - Image Quality, 28–29
 - Image Size, 32
 - JPEG Compression, 30
 - Raw Compression, 31
 - White Balance, 35–42
 - Long Exp. NR, 131
 - High ISO NR, 131
 - ISO Sensitivity, 33–34
 - Image Overlay, 84–85
 - Multiple Exposure, 86–88
 - Intvl Timer Shooting, 89–92
 - Non-CPU Lens Data, 93–95
- 🔧 **CUSTOM SETTING MENU**, 143–172
 - C: Bank select, 146
 - R: Menu Reset, 147
 - a1: AF-C Mode Priority, 148
 - a2: AF-S Mode Priority, 148
 - a3: Focus Area Frame, 148
 - a4: Group Dynamic AF, 149–150
 - a5: Lock-On, 150
 - a6: AF Activation, 151
 - a7: AF Area Illumination, 151
 - a8: Focus Area, 151
 - a9: AF Assist, 152
 - a10: AF-ON for MB-D200, 152
 - b1: ISO Auto, 152–153

- b2: ISO Step Value, 154
- b3: EV Step, 154
- b4: Exp Comp/Fine Tune, 154
- b5: Exposure Comp., 155
- b6: Center-Weighted, 155
- b7: Fine Tune Exposure, 156
- c1: AE Lock, 156
- c2: AE-L/AF-L, 156
- c3: Auto Meter-Off, 157
- c4: Self-Timer, 157
- c5: Monitor-Off, 157
- d1: Beep, 158
- d2: Grid Display, 158
- d3: Viewfinder Warning, 158
- d4: Shooting Speed, 158
- d5: Exp. Delay Mode, 158
- d6: File No. Sequence, 159
- d7: Illumination, 159
- d8: MB-D200 Batteries, 160
- e1: Flash Sync Speed, 160
- e2: Flash Shutter Speed, 161
- e3: Built-in Flash, 161–166
- e4: Modeling Flash, 166
- e5: Auto BKT Set, 166
- e6: Manual Mode Bkting, 167
- e7: Auto BKT Order, 167
- e8: Auto BKT Selection, 167
- f1: Center Button, 168
- f2: Multi-Selector, 169
- f3: Photo Info/Playback, 169
- f4: FUNC. Button, 170
- f5: Command Dials, 170–171
- f6: Buttons and Dials, 172
- f7: No Memory card?, 172
- Y SET UP, 115–123
 - Format, 116
 - LCD Brightness, 116
 - Mirror Lock-up, 117
 - Video Mode, 117
 - World Time, 12–13
 - Language, 12, 118
 - Image Comment, 118
 - Auto Image Rotation, 119
 - Recent Settings, 119–120
 - USB, 121
 - Dust Off Ref Photo, 121–122
 - Battery Info, 123
 - Firmware Version, 123

Symbols

- 3D color matrix metering II. *See* Metering
- A**
 - Advanced Wireless Lighting, 163, 177, 178
 - AF-area mode, 54
 - AF-assist illuminator, 58–59, 152
 - Aperture, 62–69
 - adjusting, 66–67
 - maximum, 61, 67, 69, 93–95, 195
 - minimum, 8, 68, 122, 192, 195
 - non-CPU lenses and, 61, 63, 65, 67, 69, 93–95
 - value display, 5, 6
 - Auto meter off, 16, 157
 - Autoexposure lock, 70
 - Autofocus, 51, 54, 148–152
 - continuous-servo, 51
 - focus tracking, 51, 52
 - single-area AF, 54
 - single-servo, 51
 - Auto FP high-speed sync, 77, 160, 178
- B**
 - Backlight, control panel, 5, 159
 - BASIC. *See* Image quality
 - Battery,
 - inserting, 10–11
 - life, 207
 - storage, ii–iii, 188
 - Black-and-white, 6, 45
 - Blur, reducing, 26, 77, 83. *See also* Exposure delay mode; Mirror-up mode
 - Bulb. *See* Long time exposures
 - Bracketing, 43–44, 73–75, 166–167, 198–199. *See also* Exposure bracketing; White balance, bracketing
 - Brightness. *See* Monitor, brightness of

- C**
- C. *See* Autofocus, continuous-servo
 - Camera Control, 107, 121
 - Ch. *See* Shooting mode
 - Cl. *See* Shooting mode
 - Clock-calendar, 117
 - Closest subject priority. *See* AF-area mode
 - Color temperature. *See* White balance
 - CompactFlash. *See* Memory card
 - Compression. *See* Image quality
 - Computer, 107–109
 - Continuous shooting mode, 26–27
 - Contrast. *See* **SHOOTING MENU**, **Optimize Image**
 - CPU lenses, 61, 62, 63, 174–175
 - Creative Lighting System, 160, 166, 170, 177–179
 - Custom Settings, 143–172
 - defaults, 147
 - menu banks, 146
- D**
- Daylight saving time, 13
 - DCF version 2.0. *See* Design rule for Camera File system
 - Deleting, 22, 102, 105, 119–120, 133–134, 142. *See also* Memory card, formatting
 - all images, 134
 - playback menu, 133–134
 - selected images, 134
 - single-frame playback, 22, 105
 - Depth-of-field preview, 62
 - Design rule for Camera File system, 135, 202
 - Digital Print Order Format, 113, 139, 202
 - Diopter, 16, 181
 - DPOF. *See* Digital Print Order Format
- E**
- Electronic analog exposure display, 69, 72
 - Electronic range finder, 60
 - Exif version 2.21, 50, 139, 202
 - Exposure bracketing, 73–75, 166, 198–199
 - Exposure compensation, 72, 154, 155
 - Exposure delay mode, 158
 - Exposure meters, 16, 157. *See also* Auto meter off
 - Exposure mode, 62–69
 - aperture-priority auto, 66–67
 - manual, 68–69
 - programmed auto, 63
 - shutter-priority auto, 64–65
- F**
- FINE. *See* Image quality
 - Flash, 76–80. *See also* Speedlight bracketing, 73–75
 - Flash Color Information Communication, 177, 178
 - Flash-ready indicator, 78–79, 83
 - Flash sync mode, 77
 - Flexible program, 63. *See also* Exposure mode, programmed auto
 - Focal plane mark, 3, 60
 - Focus. *See* autofocus; focus mode; manual focus
 - Focus area (focus brackets), 18, 53, 54, 55–56, 141, 148, 149–150, 151
 - Focus lock, 20, 56–57
 - Focus mode, 51–52
 - Focus zone, 55–56
 - Focusing screen, 7
 - Folders, 128, 135
 - FV lock, 81–82, 170
- G**
- GPS, 96
 - data, 99–100
 - Group dynamic-AF. *See* AF-area mode
- H**
- Highlight display, 99–101, 141
 - Histogram, 99–101, 141
 - RGB, 100, 141
- I**
- Illuminator. *See* Backlight, control panel
 - Image dust off, 121–122
 - Image sensor, 28, 185, 187
 - Image size, 32
 - Image quality, 28–31
 - ISO auto, 152–153
 - ISO sensitivity, 18, 33–34
 - i-TTL flash control, 76, 78, 178
- J**
- JPEG, 28–29, 30
- L**
- L. *See* Image size
 - Lens, 1, 8, 58, 93–95, 174–176, 184
 - attaching, 8
 - compatible, 174–176
 - CPU, 1, 61, 62, 174, 176
 - non-CPU, 93–95, 132, 174–175
 - type D, 18, 176
 - type G, 18, 176
 - Long time-exposures, 68, 131
 - Low-pass filter, 185–186
- M**
- M. *See* Exposure mode, manual; Manual focus; Image size
 - Manual focus, 51, 60
 - Memory buffer, 26, 27
 - Memory card, 14–15
 - approved, 183
 - capacity of, 196
 - formatting, 14, 116
 - Metering, 61
 - 3D color matrix, 61, 156
 - center-weighted, 61, 155, 156
 - color matrix, 61, 156
 - spot, 61, 156
 - Microdrive. *See* memory card
 - Mirror up. *See* Shooting mode
 - Monitor, 4, 9, 22, 184, 188
 - auto off, 157
 - brightness of, 116
 - cover, 9, 188
 - Monochrome. *See* Black-and-white
 - M.U.P. *See* Shooting mode

N

- NEF, 28–29, 31
- Nikon Capture 4, 39, 47, 107–109, 110, 118, 121, 122, 182
- Noise, 34
 - reduction, 131
 - high sensitivities, 34, 131
 - slow shutter speeds, 65, 68, 131
- NORMAL. *See* Image quality

P

- PictBridge. *See* Printing photographs
- Picture Transfer Protocol. *See* PTP
- Photo information, 99–101
- Playback, 22, 98–105
- Playback menu, 133–142
- PRE. *See* White balance, preset
- Predictive focus tracking, 52
- Printing photographs, 110–114.
 - See also* Digital Print Order Format
- Protecting images, 104
- PTP, 107, 108–109, 110, 111, 121

R

- RAW, 28–29, 31. *See also* Image quality; NEF
- Recommended exposure index. *See* ISO sensitivity
- Red-eye reduction, 77, 78–79, 178

S

- S. *See* Autofocus, single-servo; Exposure mode, shutter-priority auto; Shooting mode
- Self-portraits. *See* Self-timer
- Self-timer, 26, 83
- Sensitivity. *See* ISO sensitivity
- Sequential file numbering, 159
- Setup menu, 115–123
- Shutter speed, 62–69
 - and flash synchronization, 77, 78–79, 160, 161
- Shooting menu, 124–132
 - banks, 125–126
- Shooting mode, 26–27
- Single-frame. *See* Shooting mode

- Single-frame playback, 22, 98
- Size. *See* Image size
- Software, 50, 107, 110, 182
- Speedlight, 163–166, 177–180.
 - See also* flash
- sRGB. *See*  SHOOTING MENU, Color space

T

- Television, 106, 117
- Time. *See* **YSET UP, World Time**
- Time exposures. *See* Long time-exposures
- Time zone. *See* **YSET UP, World Time**
- Thumbnail playback, 102
- Two-button reset, 97

U

- USB, 107, 108–109, 110, 111, 121.
 - See also* computer

V

- Video device, 106, 117
- Video out, 2, 106
- Viewfinder, 6–7, 16
 - focus. *See* Diopter

W

- White balance, 18, 35–44, 166, 197
 - bracketing, 43–44, 166, 197
 - color temperature, 38
 - fine-tuning, 37
 - preset, 39–42

Nikon

No reproduction in any form of this manual, in whole or in part (except for brief quotation in critical articles or reviews), may be made without written authorization from NIKON CORPORATION.

NIKON CORPORATION

Fuji Bldg., 2-3 Marunouchi 3-chome,
Chiyoda-ku, Tokyo 100-8331, Japan

Printed in Thailand
6MBA5011-05