

Interchangeable Lens Digital Camera

α7R^{III}

E-mount

Instruction Manual



“Help Guide” (Web manual)

Refer to “Help Guide” for in-depth instructions on the many functions of the camera.

http://rd1.sony.net/help/ilc/1710/h_zz/

Check out the Help Guide!



The “Help Guide” is an on-line manual that you can read on your computer or smartphone. Refer to it for details on menu items, advanced usage, and the latest information on the camera.



Scan here

http://rd1.sony.net/help/ilc/1710/h_zz/

ILCE-7RM3 Help Guide



Instruction Manual (this book)



This manual introduces some basic functions.

For the quick start guide, see “Startup guide” (page 25). The “Startup guide” introduces the initial procedures from when you open the package until you release the shutter for the first shot.

In-Camera Guide



The [In-Camera Guide] shows explanations of the menu items on the monitor of the camera.

You can quickly pull up information during shooting.

To use the [In-Camera Guide] function, some settings must be made beforehand. For details, search “In-Camera Guide” in the Help Guide.



Table of contents

Check out the Help Guide!.....	2
Notes on using your camera.....	6



Preparations for shooting

Checking the camera and the supplied items	11
Identifying parts.....	12
Front side	12
Rear side	13
Top side/Side view	15
Bottom	19
Basic operations.....	20
Using the control wheel	20
Using the multi-selector.....	21
Using the Fn (Function) button	21
How to use the Quick Navi screen	22
Startup guide	25
Step 1: Charging the battery pack.....	25
Step 2: Inserting the battery pack into the camera.....	26
Step 3: Inserting a memory card.....	27
Step 4: Attaching a lens	29
Step 5: Setting the language and the clock.....	32
Step 6: Shooting images in auto mode	33

Shooting

Focusing	35
Focus Mode	35
Auto focus	37
Focus Area	37
Manual Focus	40
Direct manual focus (DMF)	41
Continuous shooting	42
Using touch function	44
Touch Operation	44
Touch Panel/Pad	44
Touch Focus	45
Selecting a still image size/image quality	47
 JPEG Image Size	47
 JPEG Quality	48
 File Format	48

Shooting movies

Changing settings for movie recording	49
 File Format	49
 Record Setting	50





Using network functions

Using the Wi-Fi/One-touch (NFC)/Bluetooth functions	53
Installing PlayMemories Mobile	53
Recording location information to captured images	54
Transferring images to the FTP server	54
Connecting the camera to a wireless access point	55

Using a computer

Connecting the camera to a computer	56
Connecting to a computer	56
Disconnecting the camera from the computer	57
Introduction to computer software	58
Image management software (PlayMemories Home).....	58
RAW processing/remote camera control software	59

MENU items/List of icons

Using MENU items	60
List of MENU items.....	61
 1 (Camera Settings 1).....	61
 2 (Camera Settings 2).....	67
 (Network).....	70
 (Playback)	71
 (Setup).....	73
★ (My Menu)	76
List of icons on the monitor.....	77
Icons on the shooting screen.....	77
Icons on the playback screen.....	82

About this product

Specifications	84
Battery life and number of recordable images.....	84
Memory cards that can be used	85
Number of recordable images	87
Recordable movie times.....	88
Specifications.....	91

Index..... 96

For details on the Wi-Fi functions and NFC One-touch functions, refer to the "Help Guide" (page 2).

Notes on using your camera

Along with this section, also see “Precautions” in the Help Guide (page 2).

Screen language

You can select the language displayed on the screen using the menu (page 74).

Notes on handling the product

- This camera is designed to be dust- and moisture-resistant, but is not waterproof or dust-proof.
 - When using the power zoom lens, be careful not to get your fingers or any other objects caught in the lens.
 - Always attach the lens front cap or body cap when you are not using the camera. To prevent dust or debris from getting inside the camera, remove dust from the body cap before attaching it to the camera.
 - Do not leave the lens or the viewfinder exposed to a strong light source such as sunlight. Because of the lens’s condensing function, doing so may cause smoke, fire, or a malfunction inside the camera body or the lens. If you have to leave the camera exposed to a light source such as sunlight, attach the lens cap to the lens.
- When you shoot with backlighting, keep the sun sufficiently far away from the angle of view. Otherwise, the sunlight may enter the focus inside the camera and cause smoke or fire. Even if the sun is slightly away from the angle of view, it may still cause smoke or fire.
 - Do not directly expose the lens to beams such as laser beams. That may damage the image sensor and cause the camera to malfunction.
 - Do not look at sunlight or a strong light source through the lens when it is detached. This may result in unrecoverable damage to the eyes or cause a malfunction.
 - Do not leave the camera, the supplied accessories, or memory cards within the reach of infants. They may be accidentally swallowed. If this occurs, consult a doctor immediately.

Notes on the monitor and electronic viewfinder

- The monitor and electronic viewfinder are manufactured using extremely high-precision technology, and over 99.99% of the pixels are operational for effective use. However, there may be some small black dots and/or bright dots (white, red, blue or green in color) that constantly appear on the monitor and electronic viewfinder. These are imperfections due to the manufacturing process and do not affect the recorded images in any way.

- The image may be slightly distorted near the corners of the viewfinder. This is not a malfunction. When you want to see the full composition with all its details, you can also use the monitor.
- If you pan the camera while looking into the viewfinder or move your eyes around, the image in the viewfinder may be distorted or the color of the image may change. This is a characteristic of the lens or display device and is not a malfunction. When you shoot an image, we recommend that you look at the center area of the viewfinder.
- When shooting with the viewfinder, you may experience symptoms such as eyestrain, fatigue, travel sickness, or nausea. We recommend that you take a break at regular intervals when you are shooting with the viewfinder. In case you may feel uncomfortable, refrain from using the viewfinder until your condition recovers, and consult your doctor as necessary.

Notes on continuous shooting

During continuous shooting, the monitor or viewfinder may flash between the shooting screen and a black screen. If you keep watching the screen in this situation, you may experience uncomfortable symptoms such as feeling of unwellness. If you experience uncomfortable symptoms, stop using the camera, and consult your doctor as necessary.

Notes on recording for long periods of time or recording 4K movies

- Depending on the camera and battery temperature, you may be unable to record movies or the power may turn off automatically to protect the camera. A message will be displayed on the screen before the power turns off or you can no longer record movies. In this case, leave the power off and wait until the camera and battery temperature goes down. If you turn on the power without letting the camera and battery cool enough, the power may turn off again or you may be unable to record movies.
- When the temperature of the camera rises, the image quality may deteriorate. It is recommended that you wait until the temperature of the camera drops before continuing to shoot.
- Under high ambient temperatures, the temperature of the camera rises quickly.
- Camera body and battery may get warm with use – this is normal.

- If the same part of your skin touches the camera for a long period of time while using the camera, even if the camera does not feel hot to you, it may cause symptoms of a low-temperature burn such as redness or blistering. Pay special attention in the following situations and use a tripod, etc.
 - When using the camera in a high-temperature environment
 - When someone with poor circulation or impaired skin sensation uses the camera
 - When using the camera with the [Auto Pwr OFF Temp.] set to [High].
- Especially during 4K movie shooting, the recording time may be shorter under low temperature conditions. Warm up the battery pack or replace it with a new battery.

Notes on recording/playback

- Before you start recording, make a trial recording to make sure that the camera is working correctly.
- The recorded image may be different from the image you monitored before recording.
- Do not use the camera in areas where strong radio waves or radiation are being emitted. Recording and playback may not function correctly.
- Playback of images recorded with your product on other equipment and playback of images recorded or edited with other equipment on your product are not guaranteed.

- Sony can provide no guarantees in the event of failure to record or loss or damage of recorded images or audio data due to a malfunction of the camera or recording media, etc. We recommend backing up important data.
- Once you format the memory card, all the data recorded on the memory card will be deleted and cannot be restored. Before formatting, copy the data to a computer or other device.

Notes on the Multi Interface Shoe

- When attaching or detaching accessories such as an external flash to the Multi Interface Shoe, first turn the power to OFF. When attaching the accessory, confirm that it is firmly fastened to the camera.
- Do not use the Multi Interface Shoe with a commercially available flash that applies voltages of 250 V or more or has the opposite polarity of the camera. It may cause a malfunction.

Notes on using lenses and accessories

It is recommended that you use Sony lenses/accessories designed to suit the characteristics of this camera. Using this camera with products from other manufacturers may affect its performance, leading to accidents or malfunction. Sony bears no responsibility for such accidents or malfunction.

On the data specifications described in this manual

The data on performance and specifications are defined under the following conditions, except as described in this manual: at an ordinary ambient temperature of 25°C (77°F), and using a battery pack that has been fully charged until the charge lamp has turned off.

Warning on copyright

Television programs, films, videotapes, and other materials may be copyrighted. Unauthorized recording of such materials may be contrary to the provisions of the copyright laws.

Notes on location information

If you upload and share an image tagged with a location, you may accidentally reveal the information to a third party. To prevent third parties from obtaining your location information, set [ Loc. Info. Link Set.] to [Off] before shooting images.

Notes on discarding or transferring this product to others

When discarding or transferring this product to others, make sure to perform the following operation to protect private information.

- Select [Setting Reset] → [Initialize].

Notes on discarding or transferring a memory card to others

Executing [Format] or [Delete] on the camera or a computer may not completely delete the data on the memory card. When transferring a memory card to others, we recommend that you delete the data completely using data deletion software. When discarding a memory card, we recommend that you physically destroy it.

Notes on wireless LAN

If your camera is lost or stolen, Sony bears no responsibility for the loss or damage caused by illegal access or use of the registered access point on the camera.

Notes on security when using wireless LAN products

- Always make sure that you are using a secure wireless LAN to avoid hacking, access by malicious third parties, or other vulnerabilities.
- It is important that you set the security settings when using a wireless LAN.
- If a security problem arises because no security precautions are in place or due to any inevitable circumstances when using a wireless LAN, Sony bears no responsibility for the loss or damage.

How to turn off wireless network functions (Wi-Fi, etc.) temporarily

When you board an airplane, etc., you can turn off all wireless network functions temporarily using [Airplane Mode].

Power Cord

For the customers in the UK, Ireland, Malta, Cyprus and Saudi Arabia Use the power cord (A). For safety reasons, the power cord (B) is not intended for above countries/regions and shall therefore not be used there. For the customers in other EU countries/regions Use the power cord (B).

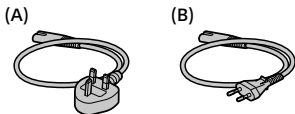

For Customers in the U.S.A.

If you have any questions about this product, you may call:

Sony Customer Information Center
1-800-222-SONY (7669).

The number below is for the FCC related matters only.

Regulatory Information

Declaration of Conformity

Trade Name: SONY

Model No.: WW940439

Responsible Party: Sony Electronics
Inc.

Address: 16535 Via Esprillo, San
Diego, CA 92127 U.S.A.

Telephone No.: 858-942-2230

This device complies with Part15 of the FCC Rules. Operation is subject to the following two conditions:

(1) This device may not cause harmful interference, and (2) this device must accept any interference received, including interference that may cause undesired operation.

Checking the camera and the supplied items

The number in parentheses indicates the number of pieces.

- Camera (1)
- Battery charger (1)



- Power cord (mains lead) (1)*



* Multiple power cords may be supplied with your camera. Use the appropriate one that matches your country/region. See page 10.

- Rechargeable battery pack NP-FZ100 (1)



- USB Type-C™ cable (1)

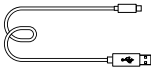

- Shoulder strap (1)

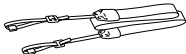

- Body cap (1) (Attached to the camera)



- Cable protector (1)



- Shoe cap (1) (Attached to the camera)

- Eyepiece cup (1) (Attached to the camera)

- Instruction Manual (1) (this manual)

- Reference Guide (1)

Identifying parts

See the pages in parentheses for details.

Front side

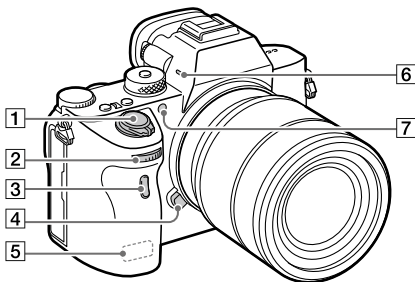

- 1 ON/OFF (Power) switch (32)/Shutter button (33)
- 2 Front dial
You can quickly adjust the settings for each shooting mode.
- 3 Remote sensor
- 4 Lens release button (31)
- 5 Wi-Fi/Bluetooth antenna (built-in) (53)
- 6 Microphone
Do not cover this part during movie recording. Doing so may cause noise or lower the volume.
- 7 AF illuminator (62)/Self-timer lamp

When the lens is removed

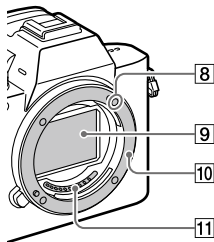

- 8 Mounting index (30)
- 9 Image sensor*
- 10 Mount
- 11 Lens contacts*

* Do not directly touch these parts.

Rear side

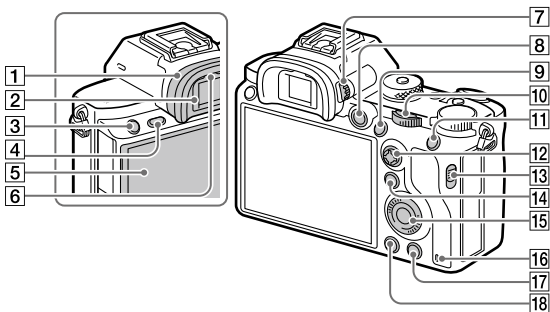

1 Eyepiece cup

To remove the eyepiece cup

Push the grips at the bottom of the eyepiece cup to the left and right and lift up the cup.

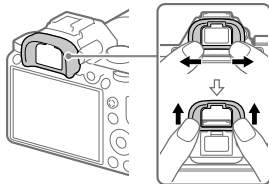

Remove the eyepiece cup when attaching an angle finder (sold separately).

Also, select MENU → 2 (Camera Settings 2) → [FINDER/MONITOR], and then switch to [Viewfinder (Manual)] or [Monitor (Manual)].

2 Viewfinder

3 C3 button (Custom button 3) (69)/ (Protect) button

4 MENU button (60)

5 Monitor

(For touch operation: Touch panel/Touch pad) (44)



You can adjust the monitor to an easily viewable angle and shoot from any position.



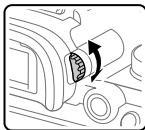

6 Eye sensor

- 7 Diopter-adjustment dial**
Adjust the diopter-adjustment dial according to your eyesight until the display appears clearly in the viewfinder. If it is hard to operate the diopter-adjustment dial, remove the eyepiece cup before operating the dial.





- 8 MOVIE (Movie) button (34)**
- 9 For shooting: AF-ON (AF On) button**
For viewing:  (Enlarge Image) button
- 10 Rear dial**
You can quickly adjust the settings for each shooting mode.
- 11 For shooting: AEL button**
For viewing:  (Image Index) button
- 12 Multi-selector (21)**
- 13 Media slot cover switch**
- 14 For shooting: Fn (Function) button (21, 69)**
For viewing:  (Send to Smartphone) button
You can display the screen for [Send to Smartphone] by pressing this button.
- 15 Control wheel (20)**

- 16 Access lamp**
- 17 For shooting: C4 button (Custom button 4) (69)**
For viewing:  (Delete) button (34)
- 18  (Playback) button (34)**

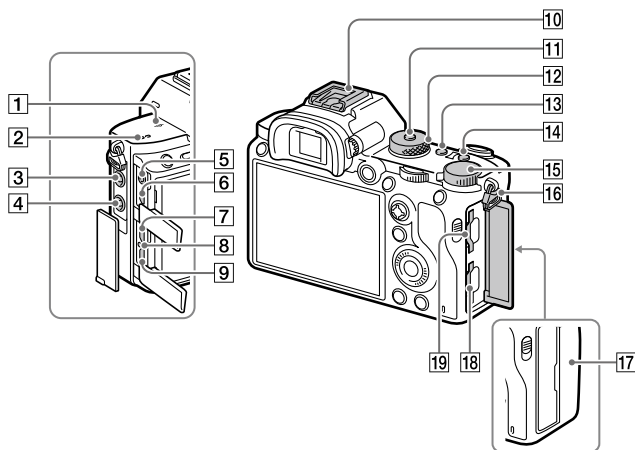
Top side/Side view



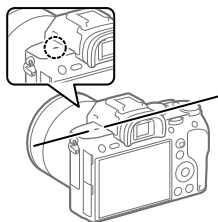

- 1**  Image sensor position mark
- The image sensor is the sensor that converts light into an electric signal. The  mark shows the location of the image sensor. When you measure the exact distance between the camera and the subject, refer to the position of the horizontal line.



- If the subject is closer than the minimum shooting distance of the lens, the focus cannot be confirmed. Make sure you put enough distance between the subject and the camera.

2 Speaker

- 3**  **(Microphone) jack**
When an external microphone is connected, the built-in microphone turns off automatically. When the external microphone is a plugin-power type, the power of the microphone is supplied by the camera.

- 4**  **(Flash sync) terminal**

- 5**  **(Headphones) jack**

- 6** **HDMI micro jack**

- 7** **USB Type-C terminal (17, 56)**

- 8** **Charge lamp**

- 9** **Multi/Micro USB Terminal* (17, 56)**

This terminal supports Micro USB-compatible devices.

- 10** **Multi Interface Shoe***
Some accessories may not go in all the way and protrude backward from the Multi interface shoe. However, when the accessory reaches the front end of the shoe, the connection is completed.

- 11** **Mode dial lock release button**

- 12** **Mode dial (34)**

- 13** **C2 button (Custom button 2) (69)**

- 14** **C1 button (Custom button 1) (69)**

- 15** **Exposure compensation dial**

- 16** **Hooks for shoulder strap**
Attach both ends of the strap onto the camera.

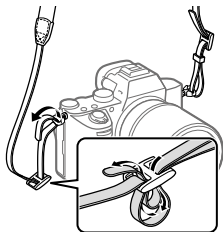

- 17** **N (N mark) (53)**
- This mark indicates the touch point for connecting the camera and an NFC-enabled Smartphone.

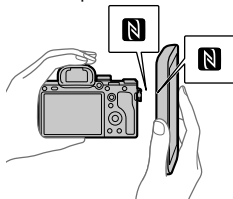

- NFC (Near Field Communication) is an international standard of short-range wireless communication technology.

- 18** **SLOT 1 (Memory card slot 1) (27)**
Supports SD cards only (compatible with UHS-I and UHS-II)

19 SLOT 2 (Memory card slot 2) (29)

Supports SD cards
(compatible with UHS-I) and
Memory Stick PRO Duo media

- * For details on compatible accessories for the multi interface shoe and the Multi/Micro USB Terminal, visit the Sony website, or consult your Sony dealer or local authorized Sony service facility. Accessories for the Accessory Shoe can also be used. Operations with other manufactures' accessories are not guaranteed.

ni Multi
Interface Shoe

Accessory Shoe

Notes on USB terminals

You can use either the USB Type-C terminal or the Multi/Micro USB Terminal for supplying power, charging the battery, and USB communications. However, you cannot conduct these operations with both terminals simultaneously.

- The battery charging time does not change according to the terminal you use.
- You can use accessories for the Multi/Micro USB Terminal, such as a remote commander (sold separately), while supplying power or performing PC Remote shooting using the USB Type-C terminal.

Notes on the cable protector

Use the cable protector to prevent a cable from being disconnected when shooting images with the cable connected.

To attach the cable protector

- ① Thread the cable through the cable protector.
- ② Open both of the jack covers on the monitor side and insert the cable into one of the jacks.
- ③ Fit the hook of the cable protector into the slit under the Multi/Micro USB Terminal.
 - Attach the cable protector as illustrated so that the upper jack cover fits into the notch in the cable protector, and then insert the claw of the cable protector into the slit next to the HDMI micro jack.
- ④ Push the attachment screw in and turn it to secure the cable protector.
- ⑤ Insert the cable into the holding part and then secure the cable with the fixing dial.

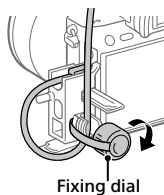
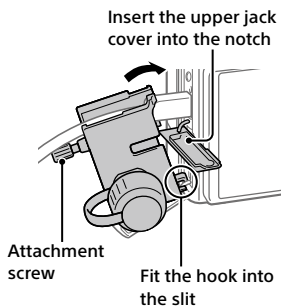

To remove the cable protector

Loosen the attachment screw. Push down the upper part of the cable protector and pull it out as illustrated.

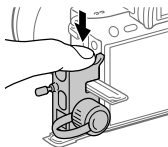

Bottom

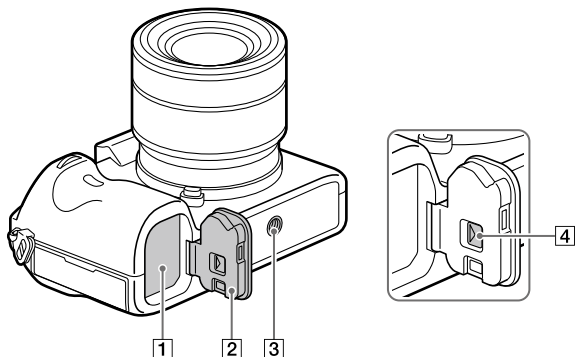



- 1 Battery insertion slot (26)**
- 2 Battery cover (26)**
- 3 Tripod socket hole**
Use a tripod with a screw less than 5.5 mm (7/32 inches) long. Otherwise, you cannot firmly secure the camera, and damage to the camera may occur.
- 4 Battery cover release lever**

Basic operations

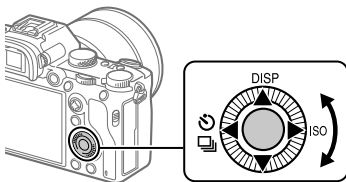
Using the control wheel



- You can select setting items by turning or pressing the top/bottom/left/right side of the control wheel. Your selection is determined when you press the center of the control wheel.
- The DISP (Display Setting), /  (Drive Mode), and ISO (ISO) functions are assigned to the top/left/right side of the control wheel. In addition, you can assign selected functions to the left/right/bottom side and the center of the control wheel, and to the rotation of the control wheel.
- During playback, you can display the next/previous image by pressing the right/left side of the control wheel or by turning the control wheel.

Using the multi-selector

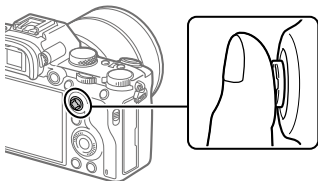

- Put your finger right on top of the multi-selector to manipulate it more precisely.
- When [Focus Area] is set to [Zone], [Flexible Spot], or [Expand Flexible Spot], you can move the focus area by pressing the multi-selector up/down/left/right.
- The [Focus Standard] function is assigned to the center of the multi-selector in the default settings.

Using the Fn (Function) button

You can register frequently used functions to the Fn (function) button and recall them while shooting. Up to 12 frequently used functions can be registered to the Fn (Function) button.

- 1 Press the DISP on the control wheel repeatedly to display a screen mode other than [For viewfinder], and then press the Fn (Function) button.**

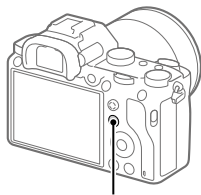

Fn button

- 2 Select the desired function by pressing the top/bottom/left/right side of the control wheel.**

3 Select the desired setting by turning the front dial, and press the center of the control wheel.

- Some functions can be fine-tuned using the rear dial.

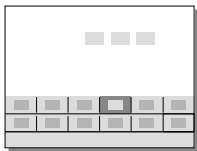

To adjust settings from the dedicated setting screens

Select the desired function in step 2, then press the center of the control wheel. The dedicated setting screen for the function will appear. Follow the operating guide to adjust settings.



Operation guide

How to use the Quick Navi screen

The Quick Navi screen is a function optimized for shooting with the viewfinder, that lets you control settings directly.

-
- 1 Select **MENU** → **2 (Camera Settings 2)** → **[DISP Button]** → **[Monitor]**.
 - 2 Place a mark on **[For viewfinder]** and then select **[Enter]**.
 - 3 Press the **DISP** on the control wheel to set the screen mode to **[For viewfinder]**.
-

4 Press the Fn button to switch to the Quick Navi screen.

- The displayed contents and their positions in the illustrations are just guidelines, and may differ from the actual displays.

Auto mode



P/A/S/M mode



5 Select a function to set by pressing the top/bottom/left/right side of the control wheel.

6 Select the desired setting by turning the front dial.

- Some functions can be fine-tuned using the rear dial.

To adjust settings from the dedicated setting screens

Select the desired function in step 5, then press the center of the control wheel. The dedicated setting screen for the function will appear. Follow the operating guide to adjust settings.



Operation guide

Note

- Items that are gray on the Quick Navi screen are not adjustable.
- When using functions such as [Creative Style] or [Picture Profile], some settings can only be controlled from the dedicated screen.

Startup guide

Step 1: Charging the battery pack

1 Insert the battery pack into the battery charger.

- Place the battery pack on the battery charger in the direction of the ▲.
- Slide the battery pack in the direction of the arrow as far as it will go.

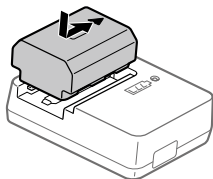

2 Connect the power cord (supplied) to the battery charger, and connect the battery charger to the wall outlet (wall socket).

The CHARGE lamp on the battery charger will light up in orange and charging will start.

CHARGE lamp (orange)

Lit: Charging

Flashing: Charging error or charging paused temporarily because the camera is not within the proper temperature range

- When charging is finished, the CHARGE lamp and all indicators turn off.
- Charging time (full charge): approximately 150 min. (when charging a fully depleted battery pack at a temperature of 25°C (77°F))
- When you use a completely new battery pack or a battery pack that has not been used for a long time, the CHARGE lamp may flash quickly when the battery is charged for the first time. If this happens, remove the battery pack and then re-insert it to recharge.
- Be sure to use only genuine Sony brand battery packs.

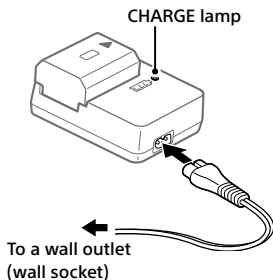

Step 2: Inserting the battery pack into the camera

1 Open the battery cover.

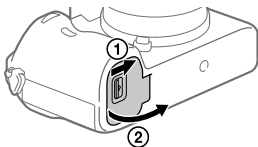

2 Insert the battery pack while pressing the lock lever with the tip of the battery until the battery locks into place.

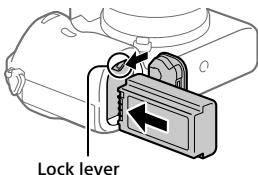

3 Close the cover.

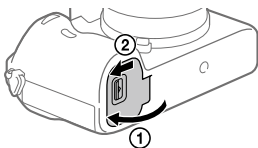

■ To charge the battery pack while it is inserted in the camera

Turn the camera off and connect it to a device such as a computer using the USB cable.

If you turn on the camera, power will be supplied from the computer or the device that you connected, and you will be able to operate the camera. However, the battery pack will not charge.

Use the USB Type-C cable (supplied) or a USB-standard cable.

■ To remove the battery pack

Make sure that the access lamp (page 14) is not lit, and turn off the camera. Then, slide the lock lever and remove the battery pack. Be careful not to drop the battery pack.

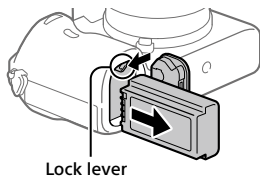

Step 3: Inserting a memory card

For details on memory cards that can be used with this camera, refer to page 85.

1 Open the memory card cover.

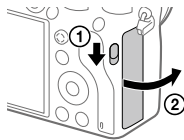

2 Insert the SD card into the slot 1.

Slot 1 (lower): Supports SD cards (compatible with UHS-I and UHS-II)

Slot 2 (upper): Supports SD cards (compatible with UHS-I) and Memory Stick PRO Duo media

- With the notched corner facing in the direction illustrated, insert the memory card until it clicks into place.
- You can change which memory card slot to use by selecting MENU →  (Setup) → [Rec. Media Settings] → [Prioritize Rec. Media]. The slot 1 is used in the default settings.
- Use the slot 1 when you are only using one SD card.
- Use the slot 2 when you are using Memory Stick media. In this case, set [Prioritize Rec. Media] to [Slot 2].

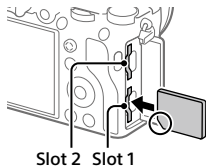

3 Close the cover.

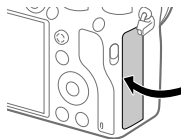

Hint

- When you use a memory card with the camera for the first time, it is recommended that you format the card on the camera for more stable performance of the memory card (page 75).

Note

- Do not insert a Memory Stick media into the slot 1. It may cause a malfunction.

To remove the memory card

Open the memory card cover.
Make sure that the access lamp (page 14) is not lit, and then push in the memory card once to remove it.

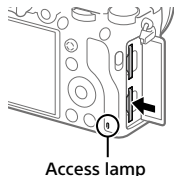

To record to memory cards in two slots

The slot 1 is used in the default settings. If you do not intend to change the settings and will only use one memory card, use the slot 1. By inserting another memory card into the slot 2, you can record the same images to two memory cards simultaneously or record a different type of image (still images/movies) to each memory card ([Recording Mode] under [Rec. Media Settings]) (page 75).

Step 4: Attaching a lens

1 Remove the body cap from the camera and the rear lens cap from the rear of the lens.

- When changing the lens, work quickly in a dust-free environment to keep dust or debris from getting inside the camera.
- It is recommended that you attach the front lens cap when you have done shooting.

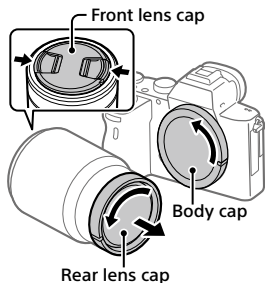

2 Mount the lens by aligning the two white index marks (mounting indexes) on the lens and camera.

- Hold the camera with the lens facing down to prevent dust or debris from entering the camera.

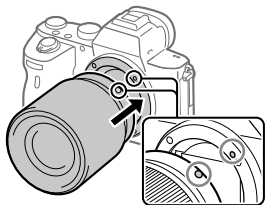

3 While pushing the lens lightly toward the camera, turn the lens slowly in the direction of the arrow until it clicks into the locked position.

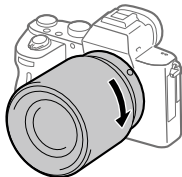

Note

- Be sure to hold the lens straight and do not use force when attaching a lens.
- Do not press the lens release button when attaching a lens.
- The Mount Adaptor (sold separately) is required to use an A-mount lens (sold separately). For details, refer to the operating manual supplied with the Mount Adaptor.
- If you want to shoot full-frame images, use a full-frame size compatible lens.
- When carrying the camera with a lens attached, hold both the camera and the lens firmly.
- Do not hold the part of the lens that is extended for zoom or focus adjustment.

To remove the lens

Keep pressing the lens release button and turn the lens in the direction of the arrow until it stops.

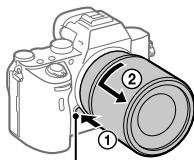

Lens release button

Compatible lenses

Lenses compatible with this camera are as follows:

Lens		Compatibility with the camera
A-mount lens	Lens compatible with 35 mm full-frame format	✓ (An optional Mount Adaptor (sold separately) compatible with full-frame format is required)
	APS-C size dedicated lens	✓* (An optional Mount Adaptor (sold separately) is required)
E-mount lens	Lens compatible with 35 mm full-frame format	✓
	APS-C size dedicated lens	✓*

* Images will be recorded in APS-C size. The angle of view will correspond to approximately 1.5 times the focal length indicated on the lens. (For example, the angle of view will correspond to 75 mm when a 50 mm-lens is attached.)

Step 5: Setting the language and the clock

- 1 Set the ON/OFF (Power) switch to "ON" to turn on the camera.

ON/OFF (Power) switch

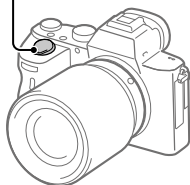

-
- 2 Select the desired language and then press the center of the control wheel.

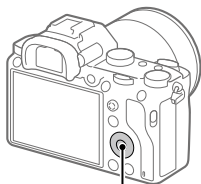

Control wheel

-
- 3 Make sure that [Enter] is selected on the screen and then press the center.
-
- 4 Select the desired geographic location and then press the center.
-
- 5 Select [Date/Time] using the top/bottom of the control wheel or by turning the control wheel, and then press the center.
-
- 6 Select the desired item by pressing the top/bottom/left/right side of the control wheel, and then press the center.

7 Repeat steps 5 and 6 to set other items, then select [Enter] and press the center.

Hint

- To reset the date and time setting, use MENU (page 75).

Note

- This camera does not have a function for inserting the date into images. You can insert the date into images and then save and print them using PlayMemories Home (for Windows only).

Step 6: Shooting images in auto mode

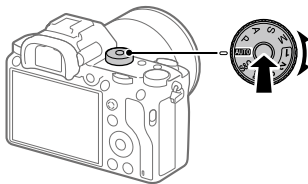

1 Press and hold the lock release button in the center of the mode dial, then turn the mode dial to set to **AUTO**.

The shooting mode will be set to **iA** (Intelligent Auto).

2 Look into the viewfinder or the monitor and hold the camera.

3 Set the size of the subject by rotating the zoom ring of the lens when a zoom lens is attached.

4 Press the shutter button halfway down to focus.

- When the image is in focus, an indicator (such as ●) will light up.

5 Press the shutter button all the way down.

■ To shoot movies

Press the MOVIE button to start/stop recording.

■ To play back images

Press the  (Playback) button to play back images. You can select the desired image using the control wheel.

■ To delete displayed image

Press the  (Delete) button while an image is displayed to delete it. Select [Delete] using the control wheel on the confirmation screen, and then press the center of the control wheel to delete the image.

■ To shoot images in various shooting modes

Set the mode dial to the desired mode depending on the subject or the functions you want to use.

Focusing

Focus Mode

Selects the focus method to suit the movement of the subject.

MENU →  1 (Camera Settings 1) → **[Focus Mode]** → **desired setting**.

AF-S (Single-shot AF): The product locks the focus once focusing is complete. Use this when the subject is motionless.

AF-A (Automatic AF): [Single-shot AF] and [Continuous AF] are switched according to the movement of the subject. When the shutter button is pressed halfway down, the product locks the focus when it determines that the subject is motionless, or continues to focus when the subject is in motion. During continuous shooting, the product automatically shoots with Continuous AF from the second shot.

AF-C (Continuous AF): The product continues to focus while the shutter button is pressed and held halfway down. Use this when the subject is in motion. In [Continuous AF] mode, there is no beep when the camera focuses.

DMF (DMF): You can make fine adjustments manually after performing auto focusing, letting you focus on a subject more quickly than when using the manual focus from the beginning. This is convenient in situations such as macro shooting.

MF (Manual Focus): Adjusts the focus manually. If you cannot focus on the intended subject using auto focus, use manual focus.

Focus indicator

- **(lit):** The subject is in focus and the focus is locked.
- **(flashing):** The subject is not in focus.
- ⦿ **(lit):** The subject is in focus. The focus will be adjusted continuously according to the movements of the subject.
- ⦿ **(lit):** Focusing is in progress.

Subjects on which it is difficult to focus using auto focus

- Dark and distant subjects
- Subjects with poor contrast
- Subjects seen through glass
- Fast-moving subjects
- Reflective light or shiny surfaces
- Flashing light
- Back-lit subjects
- Continuously repetitive patterns, such as the facades of buildings
- Subjects in the focusing area with different focal distances

Hint

- In [Continuous AF] mode, you can lock the focus by pressing and holding the button that has been assigned the [Focus Hold] function (page 69).
- When you set the focus to infinity in the manual focus mode or the direct manual focus mode, make sure that the focus is on a sufficiently distant subject by checking the monitor or the viewfinder.

Note











- [Automatic AF] is available only when you are using a lens that supports phase detection AF.
- When [Continuous AF] or [Automatic AF] is set, the angle of view may change little by little while focusing. This does not affect the actual recorded images.
- Only [Continuous AF] and [Manual Focus] are available when shooting movies or when the mode dial is set to **S&Q**.

Auto focus

Focus Area

Selects the focusing area. Use this function when it is difficult to focus properly in the auto focus mode.

MENU →  **1 (Camera Settings 1)** → **[Focus Area]** → **desired setting.**

-  **Wide:** Focuses on a subject covering the whole range of the screen automatically. When you press the shutter button halfway down in the still image shooting mode, a green frame is displayed around the area that is in focus.
-  **Zone:** Select a zone on the monitor on which to focus, and the product will automatically select a focus area.
-  **Center:** Focuses automatically on a subject in the center of the image. Use together with the focus-lock function to create the composition you want.
-  **Flexible Spot:** Allows you to move the focusing frame to a desired point on the screen and focus on an extremely small subject in a narrow area.
-  **Expand Flexible Spot:** If the product cannot focus on a single selected point, it uses focus points around the flexible spot as a secondary priority area for focusing.
-       **Lock-on AF:** When the shutter button is pressed and held halfway down, the product tracks the subject within the selected autofocus area. This setting is available only when the [Focus Mode] is set to [Continuous AF]. Point the cursor at [Lock-on AF] on the [Focus Area] setting screen, and then adjust the desired area to start tracking using the left/right sides of the control wheel. You can also move the tracking start area to the desired point by designating the area as a zone, flexible spot or expand flexible spot.

Examples of the focusing frame display

The focusing frame differs as follows.

When focusing on a larger area

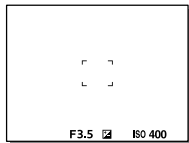

When focusing on a smaller area

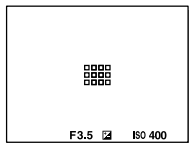

- When [Focus Area] is set to [Wide] or [Zone], the focusing frame may switch between “When focusing on a larger area” and “When focusing on a smaller area” depending on the subject or situation.
- When you attach an A-mount lens with a Mount Adaptor (LA-EA1 or LA-EA3) (sold separately) and [AF System] is set to [Phase Detection AF], the focusing frame for “When focusing on a smaller area” may be displayed.

When focus is achieved automatically based on the whole range of the monitor

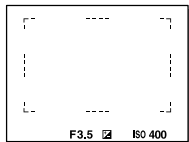

- When you use a zoom function other than the optical zoom, the [Focus Area] setting is disabled and the focusing frame is shown by the dotted line. The AF operates with priority on and around the center area.

To move the focus area

- You can move the focus area in [Flexible Spot], [Expand Flexible Spot], or [Zone] by operating the multi-selector. If you assign [Focus Standard] to the center of the multi-selector beforehand, you can move the focusing frame back to the center of the monitor by pressing the center of the multi-selector.
- You can move the focusing frame quickly by touching and dragging it on the monitor. Set [Touch Operation] to [On] beforehand (page 44).

Hint

- In the default settings, [Focus Area] is assigned to the C2 button.

Note

- [Focus Area] is locked to [Wide] in the following situations:
 - [Intelligent Auto]
- The focus area may not light up during continuous shooting or when the shutter button is pressed all the way down at once.
- When the mode dial is set to  (Movie) or **S&Q**, or during movie shooting, [Lock-on AF] cannot be selected as the [Focus Area].

Manual Focus

When it is difficult to focus properly in the autofocus mode, you can adjust the focus manually.

1 MENU →  **1 (Camera Settings 1)** → **[Focus Mode]** → **[Manual Focus]**.

2 Rotate the focusing ring to achieve sharp focus.

- When you rotate the focusing ring, the focus distance is displayed on the screen. The focus distance is not displayed when the Mount Adaptor (sold separately) is attached.

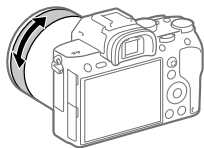

3 Press the shutter button fully down to shoot an image.

Note

- When you use the viewfinder, adjust the diopter level to obtain the correct focus on the viewfinder (page 14).

Direct manual focus (DMF)

You can make fine adjustments manually after performing auto focusing, letting you focus on a subject more quickly than when using the manual focus from the beginning. This is convenient in situations such as macro shooting.

1 MENU →  1 (Camera Settings 1) → [Focus Mode] → [DMF].

2 Press the shutter button halfway down to focus automatically.

3 Keep the shutter button pressed halfway down, and then rotate the focusing ring to achieve a sharper focus.

- When you rotate the focusing ring, the focus distance is displayed on the screen. The focus distance is not displayed when the Mount Adaptor (sold separately) is attached.

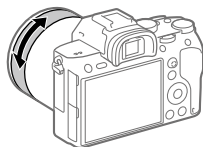

4 Press the shutter button fully down to shoot an image.

Continuous shooting



Shoots images continuously while you press and hold down the shutter button.

1 Select (Drive Mode) on the control wheel → [Cont. Shooting].

- You can also set the drive mode by selecting MENU →  1 (Camera Settings 1) → [Drive Mode].
-

2 Select the desired mode using the right/left side of the control wheel.

 **Continuous Shooting: Hi+:** Images are shot continuously at the maximum speed while you press and hold down the shutter button.

 **Continuous Shooting: Hi** /  **Continuous Shooting: Mid** /  **Continuous Shooting: Lo:** Subjects are easier to track because the subject is displayed in real-time on the monitor or viewfinder during shooting.

Hint

- To continuously adjust the focus and exposure during continuous shooting, set as follows:
 - [Focus Mode]: [Continuous AF]
 - [ AEL w/ shutter]: [Off] or [Auto]

Note

- The shooting speed during continuous shooting becomes slower when [RAW File Type] is set to [Uncompressed].
- The shooting speed during continuous shooting becomes slower when [e-Front Curtain Shut.] is set to [Off] in [Continuous Shooting: Hi], [Continuous Shooting: Mid] or [Continuous Shooting: Lo] mode.
- When the F-value is greater than F8 in [Continuous Shooting: Hi+], [Continuous Shooting: Hi] or [Continuous Shooting: Mid] mode, the focus is locked to the setting in the first shot.
- The subject is not displayed in real-time on the monitor or viewfinder when shooting in [Continuous Shooting: Hi+] mode.
- Continuous shooting is unavailable in the following situations:
 - [Picture Effect] is set to [Rich-tone Mono.].
 - [DRO/Auto HDR] is set to [Auto HDR].

■ Displaying continuous shooting remaining time indicator (Cont. Shoot. Length)

Sets whether to display an indicator of the remaining time for which continuous shooting can be performed at the same shooting speed.

MENU →  2 (Camera Settings 2) → [Cont. Shoot. Length] → desired setting.

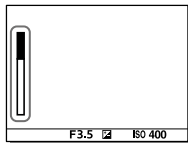

Always Display: Always displays the indicator when the drive mode is set to [Cont. Shooting].

Shoot.-Only Display: Displays the indicator only while continuous shooting is performed.

Not Displayed: Does not display the indicator.

Hint

- When the internal camera memory for buffering is full, "SLOW" will be displayed and the continuous shooting speed will decrease.

Using touch function

Touch Operation

Sets whether to activate or not the touch operation of the monitor. Touch operations when shooting with the monitor are referred to as "touch panel operations," and touch operations when shooting with the viewfinder are referred to as "touch pad operations."

MENU →  (Setup) → [Touch Operation] → **desired setting.**

On: Activates the touch operation.

Off: Deactivates the touch operation.

Touch Panel/Pad

Selects whether to activate touch panel operation when shooting with the monitor, or touch pad operation when shooting with the viewfinder.

MENU →  (Setup) → [Touch Panel/Pad] → **desired setting.**

Touch Panel+Pad: Activates both the touch panel operations when shooting with the monitor and touch pad operations when shooting with the viewfinder.

Touch Panel Only: Activates only the touch panel operations when shooting with the monitor.

Touch Pad Only: Activates only the touch pad operations when shooting with the viewfinder.

Touch Focus

You can select a subject on which to focus using touch operations in the still image and movie recording modes.

MENU →  (Setup) → [Touch Operation] → [On].

■ Specifying the position where you want to focus in the still image mode

You can focus on the desired position by touching the monitor.

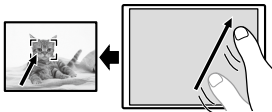

- ① Select a [Focus Area] other than [Flexible Spot] or [Expand Flexible Spot].
- ② **MENU** →  1 (Camera Settings 1) → [Center Lock-on AF] → [Off].
- ③ **Touch the monitor.**
 - When shooting with the monitor, touch the subject to focus.
 - When shooting with the viewfinder, you can move the position of the focus by touching and dragging on the monitor while looking through the viewfinder.



- When the shutter button is pressed halfway down, the camera focuses on the focusing frame. Press the shutter button all the way down to shoot images.
- To cancel focusing with touch operations, touch  or press the center of the control wheel if shooting with the monitor, and press the center of the control wheel if shooting with the viewfinder.

■ Specifying the position where you want to focus in the movie recording mode (spot focus)

The camera will focus on the touched subject. Spot focus is not available when shooting with the viewfinder.

- ① Select a [Focus Area] other than [Flexible Spot] or [Expand Flexible Spot].
- ② MENU →  1 (Camera Settings 1) → [Center Lock-on AF] → [Off].
- ③ Touch the subject on which you want to focus before or during recording.
 - When you touch the subject, the focus mode temporarily switches to manual focus and the focus can be adjusted using the focus ring.
 - To cancel spot focus, touch  or press the center of the control wheel.

Hint

- In addition to the touch focus function, touch operations such as the following are also available.
 - When [Focus Area] is set to [Flexible Spot] or [Expand Flexible Spot], the focusing frame can be moved using touch operations.
 - When the [Focus Mode] is set to [Manual Focus], the focus magnifier can be used by double-tapping the monitor.



Note

- The touch focus function is not available in the following situations:
 - When [Focus Mode] is set to [Manual Focus].
 - When using the digital zoom
 - When using the LA-EA2 or LA-EA4
 - When using the LA-EA1 or LA-EA3, and the shooting mode is set to [Movie]

Selecting a still image size/image quality

JPEG Image Size

The larger the image size, the more detail will be reproduced when the image is printed on large-format paper. The smaller the image size, the more images can be recorded.

MENU →  1 (Camera Settings 1) → [ JPEG Image Size] → desired setting.

When [ Aspect Ratio] is set to 3:2	
L: 42M	7952×5304 pixels
M: 18M	5168×3448 pixels
S: 11M	3984×2656 pixels

When [ Aspect Ratio] is set to 16:9	
L: 36M	7952×4472 pixels
M: 15M	5168×2912 pixels
S: 8.9M	3984×2240 pixels

When recording in the APS-C-equivalent size

When [ Aspect Ratio] is set to 3:2	
L: 18M	5168×3448 pixels
M: 11M	3984×2656 pixels
S: 4.5M	2592×1728 pixels



When [ Aspect Ratio] is set to 16:9	
L: 15M	5168×2912 pixels
M: 8.9M	3984×2240 pixels
S: 3.8M	2592×1456 pixels

Note

- When [ File Format] is set to [RAW] or [RAW & JPEG], the image size for RAW images corresponds to "L."

JPEG Quality



Selects the JPEG image quality when [ File Format] is set to [RAW & JPEG] or [JPEG].

MENU → 1 (Camera Settings 1) → [ JPEG Quality] → **desired setting.**

Extra fine/Fine/Standard: Since the compression rate increases from [Extra fine] to [Fine] to [Standard], the file size decreases in the same order. This allows more files to be recorded on one memory card, but the image quality is lower.

File Format

Sets the file format for still images.

MENU → 1 (Camera Settings 1) → [ File Format] → **desired setting.**

RAW: Digital processing is not performed on this file format. Select this format to process images on a computer for professional purposes.



RAW & JPEG: A RAW image and a JPEG image are created at the same time. This is suitable when you need two image files, a JPEG for viewing, and a RAW for editing.

JPEG: The image is recorded in the JPEG format.

Changing settings for movie recording

File Format

Selects the movie file format.

MENU →  2 (Camera Settings 2) → [ File Format] → **desired setting.**

 File Format	Characteristics	
XAVC S 4K	Records movies in 4K resolution (3840×2160).	You can save movies on a computer using the PlayMemories Home software.
XAVC S HD	Records movies in crisper quality than AVCHD with larger amounts of data.	You can save movies on a computer using the PlayMemories Home software.
AVCHD	The AVCHD format has a high degree of compatibility with storage devices other than computers.	You can save movies on a computer or create a disc that supports this format using the PlayMemories Home software.

For details on memory cards that can be used for these formats, refer to page 85.

Note

- When [File Format] is set to [AVCHD], the file size of movies is limited to approx. 2 GB. If the movie file size reaches approx. 2 GB during recording, a new movie file will be created automatically.
- Images will not appear on the monitor of the camera if you record movies while the camera is connected to an HDMI device with [File Format] set to [XAVC S 4K].
- When recording XAVC S 4K movies with [APS-C S35 Shooting] under [APS-C/Super 35mm] set to [Auto], the angle of view is equivalent to approx. 1.5 times the focal length indicated on the lens.

Record Setting

Selects the frame rate and bit-rate for movie recording.

MENU → **2 (Camera Settings 2)** → **Record Setting** → **desired setting.**

- The higher the bit-rate, the higher the image quality.
- For estimates of the maximum recordable movie time with each recording setting, refer to page 88.

When [File Format] is set to [XAVC S 4K]

Record Setting	Bit-rate	Description
30p 100M/25p 100M	Approx. 100 Mbps	Records movies in 3840×2160 (30p/25p).
30p 60M/25p 60M	Approx. 60 Mbps	Records movies in 3840×2160 (30p/25p).
24p 100M*	Approx. 100 Mbps	Records movies in 3840×2160 (24p).
24p 60M*	Approx. 60 Mbps	Records movies in 3840×2160 (24p).

* Only when [NTSC/PAL Selector] is set to NTSC

When [File Format] is set to [XAVC S HD]

Record Setting	Bit-rate	Description
60p 50M/50p 50M	Approx. 50 Mbps	Records movies in 1920×1080 (60p/50p).
60p 25M/50p 25M	Approx. 25 Mbps	Records movies in 1920×1080 (60p/50p).
30p 50M/25p 50M	Approx. 50 Mbps	Records movies in 1920×1080 (30p/25p).
30p 16M/25p 16M	Approx. 16 Mbps	Records movies in 1920×1080 (30p/25p).
24p 50M*	Approx. 50 Mbps	Records movies in 1920×1080 (24p).
120p 100M/100p 100M	Approx. 100 Mbps	Records high-speed movies in 1920×1080 (120p/100p). You can record movies in 120 fps or 100 fps. <ul style="list-style-type: none"> You can create smoother slow-motion movies by using compatible editing devices.
120p 60M/100p 60M	Approx. 60 Mbps	Records high-speed movies in 1920×1080 (120p/100p). You can record movies in 120 fps or 100 fps. <ul style="list-style-type: none"> You can create smoother slow-motion movies by using compatible editing devices.

* Only when [NTSC/PAL Selector] is set to NTSC

When [File Format] is set to [AVCHD]

Record Setting	Bit-rate	Description
60i 24M (FX)/ 50i 24M (FX)	24 Mbps at maximum	Records movies in 1920×1080 (60i/50i).
60i 17M (FH)/ 50i 17M (FH)	Approx. 17 Mbps on average	Records movies in 1920×1080 (60i/50i).

Note

- Creating an AVCHD recording disc from movies that were recorded with [60i 24M (FX)]/[50i 24M (FX)] as the [Record Setting] takes a long time because the image quality of movies is converted. If you want to store movies without converting them, use a Blu-ray Disc.
- [120p]/[100p] cannot be selected for the following settings.
 - [Intelligent Auto]

Using the Wi-Fi/One-touch (NFC)/Bluetooth functions

You can perform the following operations using the camera's Wi-Fi, NFC One-touch, and Bluetooth functions.

- Saving images to a computer
- Transferring images from the camera to a smartphone
- Using a smartphone as a remote control for the camera
- Viewing still images on a TV
- Recording location information from a smartphone to images
- Transferring images to the FTP server

For details, refer to the "Help Guide" (page 2).

Installing PlayMemories Mobile

PlayMemories Mobile is required to connect the camera and a smartphone. If PlayMemories Mobile is already installed on your smartphone, be sure to update it to the latest version.

For details on PlayMemories Mobile, refer to the support page (<http://www.sony.net/pmm/>).



Note

- To use the camera's NFC One-touch function, an NFC-enabled Android smartphone or tablet is required.
- The Wi-Fi functions introduced in this manual are not guaranteed to operate on all smartphones or tablets.
- The Wi-Fi functions of this camera are not available when connected to a public wireless LAN.
- Depending on future version upgrades, the operational procedures or screen displays are subject to change without notice.

Recording location information to captured images

By using PlayMemories Mobile, you can obtain location information from a connected smartphone (via Bluetooth communication) and record it to captured images.

Transferring images to the FTP server

You can use the camera's Wi-Fi function to transfer images to the FTP server.

For details, refer to the "FTP Help Guide."

http://rd1.sony.net/help/di/ftp/h_zz/



- Basic knowledge of FTP servers is required.

Connecting the camera to a wireless access point

Connect the camera to your wireless access point. Before starting the procedure, make sure you have the SSID (name of the access point) and password of your wireless access point with you.

1 MENU →  (Network) → [Wi-Fi Settings] → [Access Point Set.].

2 Use the control wheel to select the access point to which you want to connect. Press the center of the control wheel and enter the password for the wireless access point, then select [OK].

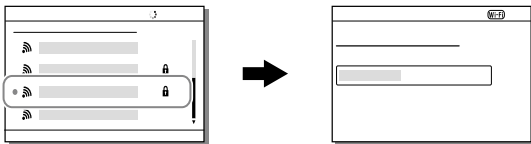

Note

- If a connection is not established, see the wireless access point operating instructions or contact the administrator of the access point.
To save images to a computer, install PlayMemories Home on your computer.

PlayMemories Home
<http://www.sony.net/pm/>

Connecting the camera to a computer

Connecting to a computer

1 Insert a sufficiently charged battery pack into the camera.

2 Turn on the camera and the computer.

3 Check that [USB Connection] under  (Setup) is set to [Mass Storage].

4 Connect the camera to the computer using the USB cable.

- When you connect the camera to the computer for the first time, the procedure for recognizing the camera may start automatically on the computer. Wait until the procedure is finished.
- If you connect the camera to your computer using the USB cable when [USB Power Supply] is set to [On], power is supplied from your computer. (Default setting: [On])
- Use the USB Type-C cable (supplied) or a USB-standard cable.
- Use a USB 3.1-compatible computer and the USB Type-C cable (supplied) for higher-speed communications.

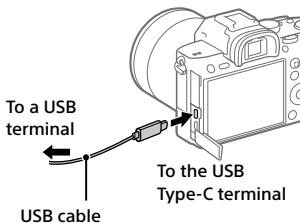

Disconnecting the camera from the computer

Perform steps 1 and 2 below before performing the following operations:

- Disconnecting the USB cable.
- Removing a memory card.
- Turning off the product.

1 Click  (Safely Remove Hardware and Eject Media) in the taskbar.

2 Click the displayed message.

Note

- On Mac computers, drag and drop the memory card icon or the drive icon into the "Trash" icon. The camera will be disconnected from the computer.
- On Windows 7/Windows 8 computers, the disconnection icon may not appear. In that case, you can skip the steps above.
- Do not remove the USB cable from the camera while the access lamp is lit. The data may be damaged.

Introduction to computer software

We offer the following computer software to enhance your enjoyment of photos/movies. Access one of the following URLs using your Internet browser and then download the software by following the onscreen instructions.

If one of these software is already installed on your computer, update it to the latest version before use.

Windows:

<http://www.sony.co.jp/imsoft/Win/>

Mac:

<http://www.sony.co.jp/imsoft/Mac/>

You can check the recommended operating environment for the software from the following URL:

<http://www.sony.net/pcenv/>

Image management software (PlayMemories Home)

PlayMemories Home allows you to import still images and movies to your computer and view or use them.

You need to install PlayMemories Home to import XAVC S movies or AVCHD movies to your computer.

You can access the download website directly from the following URL:

<http://www.sony.net/pm/>

- When you connect the camera to your computer, new functions may be added to PlayMemories Home. Connecting the camera to your computer is therefore recommended even if PlayMemories Home has already been installed on the computer.

RAW processing/remote camera control software

- You can develop and edit RAW images using various adjustment functions like tone curve and sharpness.
- With the software, you can change the camera settings or release the shutter from a computer connected via a USB cable.

To control the camera using the software, first select MENU →

 (Setup) → [USB Connection] → [PC Remote], then connect the camera to a computer via a USB cable.

Using MENU items

You can change settings related to all the camera operations including shooting, playback, and operating method. You can also execute camera functions from the MENU.

- 1 Press the MENU button to display the menu screen.**

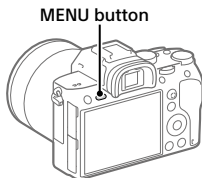

- 2 Select the desired setting you want to adjust using the top/bottom/left/right sides of the control wheel or by turning the control wheel, and then press the center of the control wheel.**

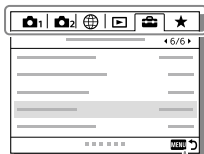

Select an icon at the top of the screen and press the left/right side of the control wheel to move to another MENU item.



Press the MENU button to go back to the previous screen.









- 3 Select the desired setting value, and press the center to confirm your selection.**











List of MENU items









For details on each MENU items, refer to the reference page in the last column or the Help Guide.

1 (Camera Settings 1)

Red tab





Quality/Image Size		
 File Format	Sets the file format for still images. ([RAW] / [JPEG], etc.)	48
 RAW File Type	Selects the file type for RAW images.	Help Guide
 JPEG Quality	Selects the JPEG image quality for [RAW & JPEG] or [JPEG] under [ File Format].	48
 JPEG Image Size	Selects the size of still images. (L / M / S)	47
 Aspect Ratio	Selects the aspect ratio for still images.	Help Guide
APS-C/Super 35mm	Sets whether to record in APS-C-equivalent size for still images and Super 35 mm-equivalent size for movies.	Help Guide
 Long Exposure NR	Sets noise reduction processing for shots with a shutter speed of 1 second or longer.	Help Guide
 High ISO NR	Sets noise reduction processing for high-sensitivity shooting.	Help Guide
 Color Space	Changes the color space (range of reproducible colors).	Help Guide
Lens Comp.	Selects the type of lens compensation.	Help Guide
Shoot Mode/Drive		
Drive Mode	Sets the drive mode, such as for continuous shooting. ([Self-timer] / [Cont. Bracket], etc.)	42, Help Guide











Bracket Settings	Sets self-timer shooting in bracket mode, shooting order for exposure bracketing, and white balance bracketing.	Help Guide
MR    Recall	Calls up settings pre-registered to [MR    Memory].	Help Guide
MR    Memory	Registers the desired modes and camera settings.	Help Guide
MR Select Media	Selects the memory card slot from which settings are recalled or to which settings are registered for M1 through M4.	Help Guide
Reg Cust Shoot Set	Assign functions to the custom key to recall when shooting.	Help Guide
AF		
Focus Mode	Selects the focus mode. ([Single-shot AF] / [Continuous AF], etc.)	35
Priority Set in AF-S	Sets the timing of the shutter release when [Focus Mode] is set to [Single-shot AF], [DMF] or [Automatic AF] with a still subject.	Help Guide
Priority Set in AF-C	Sets the timing of the shutter release when [Focus Mode] is set to [Continuous AF] or [Automatic AF] with a moving subject.	Help Guide
Focus Area	Selects the area of focus. ([Wide] / [Flexible Spot], etc.)	37
Focus Settings	Allows you to focus using the front dial, rear dial or control wheel.	Help Guide
 Swt. V/H AF Area	Sets whether to adjust the [Focus Area] and the position of the focusing frame based on the camera's position (horizontal or vertical).	Help Guide
 AF Illuminator	Sets the AF illuminator, which provides light to aid focusing in dark scenes.	Help Guide



Center Lock-on AF	Sets the function to track a subject and continue focusing when pressing the center of the control wheel in the shooting screen.	Help Guide
Set. Face Prty in AF	Sets whether the camera focuses based on detected faces.	Help Guide
 AF Track Sens	Sets the AF tracking sensitivity for the still image mode.	Help Guide
 AF System	Sets the auto focus method when an LA-EA1/LA-EA3 Mount Adaptor (sold separately) is attached.	Help Guide
 AF w/ shutter	Sets whether to perform auto focusing when the shutter button is pressed halfway down. This is useful when you want to adjust the focus and exposure separately.	Help Guide
 Pre-AF	Sets whether or not to perform auto focus before the shutter button is half pressed.	Help Guide
 Eye-Start AF	Sets whether to use auto focus when you look through the viewfinder if an LA-EA2/LA-EA4 Mount Adaptor (sold separately) is attached.	Help Guide
 AF Area Regist.	Sets whether to move the focusing frame to a preassigned position when shooting still images.	Help Guide
 Del. Reg. AF Area	Deletes the focusing frame position information that was registered using [ AF Area Regist.].	Help Guide
AF Area Auto Clear	Sets whether the focus area is displayed all the time or disappears automatically shortly after focusing.	Help Guide
Disp. cont. AF area	Sets whether or not to display the focus area in [Continuous AF] mode.	Help Guide
Phase Detect. Area	Sets phase detection AF area.	Help Guide





AF Micro Adj.	Finely adjusts the autofocused position, when using the LA-EA2 or LA-EA4 Mount Adaptor (sold separately).	Help Guide
Exposure		
Exposure Comp.	Compensates for the brightness of the entire image.	Help Guide
Reset EV Comp.	Sets whether to maintain the exposure value set using [Exposure Comp.] when you turn off the power when the exposure compensation dial position is set to "0."	Help Guide
ISO	Sets the ISO sensitivity. ([ISO AUTO], etc.)	Help Guide
ISO AUTO Min. SS	Sets the slowest shutter speed at which ISO sensitivity will start to change in [ISO AUTO] mode.	Help Guide
Metering Mode	Selects the method for measuring brightness. ([Multi] / [Spot], etc.)	Help Guide
Face Prty in Mlti Mtr	Sets whether the camera measures brightness based on detected faces when [Metering Mode] is set to [Multi].	Help Guide
Spot Metering Point	Sets whether to coordinate the spot metering point with the focus area when [Focus Area] is set to [Flexible Spot] or [Expand Flexible Spot].	Help Guide
Exposure step	Selects the size of the increment step for shutter speed, aperture, and exposure compensation values.	Help Guide
 AEL w/ shutter	Sets whether to lock the exposure when the shutter button is pressed halfway down. This is useful when you want to adjust the focus and exposure separately.	Help Guide

Exposure Std. Adjust	Adjusts the standard for the correct exposure value for each metering modes.	Help Guide
Flash		
Flash Mode	Sets the flash settings.	Help Guide
Flash Comp.	Adjusts the intensity of flash output.	Help Guide
Exp. comp. set	Sets whether to reflect exposure compensation value to flash compensation.	Help Guide
Wireless Flash	Sets whether to shoot with the wireless flash.	Help Guide
Red Eye Reduction	Reduces the red-eye phenomenon when using flash.	Help Guide
Color/WB/Img. Processing		
White Balance	Corrects the tone effect of the ambient light to shoot whitish objects in a white tone. ([Auto] / [Daylight], etc.)	Help Guide
Priority Set in AWB	Selects which tone to prioritize when shooting under lighting conditions such as incandescent light with [White Balance] set to [Auto].	Help Guide
DRO/Auto HDR	Analyzes the contrast of light and shadow between the subject and the background by dividing the image into small areas, and creates an image with the optimal brightness and gradation.	Help Guide
Creative Style	Selects the desired image processing. You can also adjust contrast, saturation, and sharpness. ([Vivid] / [Portrait], etc.)	Help Guide
Picture Effect	Shoots images with a texture unique to the selected effect. ([Toy Camera] / [Rich-tone Mono.], etc.)	Help Guide

Picture Profile	Changes settings such as color and tone when recording images. * This function is for skilled movie creators.	Help Guide
Focus Assist		
Focus Magnifier	Enlarges the image before shooting so that you can check the focus.	Help Guide
Focus Magnif. Time	Sets the length of time the image will be shown in an enlarged form.	Help Guide
 Initial Focus Mag.	Sets the initial magnification scale when using [Focus Magnifier].	Help Guide
 AF in Focus Mag.	Sets whether or not to autofocus when an enlarged image is being displayed. While the enlarged image is being displayed, you can focus within a smaller area than the flexible spot.	Help Guide
 MF Assist	Displays an enlarged image when focusing manually.	Help Guide
Peaking Setting	Sets the peaking function, which enhances the outline of in-focus areas when focusing manually.	Help Guide
Shoot Assist		
 Anti-flicker Shoot.	Detects flickering/blinking from artificial light sources such as fluorescent lighting and times the shooting of images to moments when flickering will have less of an impact.	Help Guide
Face Registration	Registers or changes the person to be given priority when focusing.	Help Guide
Regist. Faces Priority	Detects the registered face with higher priority using [Face Registration].	Help Guide

Movie		
 Exposure Mode	Sets the exposure mode when shooting movies.	Help Guide
 S&Q Exposure Mode	Sets the exposure mode when shooting slow-motion/quick-motion movies.	Help Guide
 File Format	Selects the movie file format. ([XAVC S 4K] / [AVCHD], etc.)	49
 Record Setting	Selects a frame-rate and bit-rate for the movie.	50
 S&Q S&Q Settings	Changes the settings for slow-motion and quick-motion movie shooting.	Help Guide
 Px Proxy Recording	Records low-bit-rate proxy files simultaneously when recording XAVC S movies.	Help Guide
 AF drive speed	Switches focusing speed when using autofocus in movie mode.	Help Guide
 AF Track Sens	Sets the AF tracking sensitivity for the movie mode.	Help Guide
 Auto Slow Shut.	Sets the function that automatically adjusts the shutter speed following the brightness of the environment in movie mode.	Help Guide
Audio Recording	Sets whether to record audio when shooting a movie.	Help Guide
Audio Rec Level	Adjusts the audio recording level during movie recording.	Help Guide
Audio Level Display	Sets whether to display the audio level.	Help Guide
Audio Out Timing	Sets the timing of audio output during the movie recording.	Help Guide
Wind Noise Reduct.	Reduces wind noise during movie recording.	Help Guide
 Marker Display	Sets whether to display markers on the monitor when recording movies.	Help Guide

 Marker Settings	Sets which markers to display on the monitor when recording movies.	Help Guide
Video Light Mode	Sets the illumination setting for the HVL-LBPC LED light (sold separately).	Help Guide
Movie w/ shutter	Records movies using the shutter button.	Help Guide
Shutter/SteadyShot		
 Silent Shooting	Shoots images without the shutter sound.	Help Guide
e-Front Curtain Shut.	Sets whether to use the electronic front curtain shutter function.	Help Guide
Release w/o Lens	Sets whether to release the shutter when the lens is not attached.	Help Guide
Release w/o Card	Sets whether to release the shutter when a memory card is not inserted.	Help Guide
SteadyShot	Sets whether to activate SteadyShot for shooting.	Help Guide
SteadyShot Settings	Sets SteadyShot settings.	Help Guide
Zoom		
Zoom	Sets the zoom scale for zoom functions other than the optical zoom.	Help Guide
Zoom Setting	Sets whether to use the Clear Image Zoom and Digital Zoom when zooming.	Help Guide
Zoom Ring Rotate	Assigns the zoom in/out to the rotational direction of the zoom lens. This function is only available with a power zoom lens that is compatible with this function.	Help Guide
Display/Auto Review		
DISP Button	Sets the type of information to be displayed on the monitor or in the viewfinder when the DISP button is pressed.	Help Guide

FINDER/MONITOR	Sets the method for switching the display between the electronic viewfinder and the monitor.	Help Guide
 Finder Frame Rate	Sets the frame rate for the viewfinder when shooting still images.	Help Guide
Zebra Setting	Sets the stripes displayed to adjust brightness.	Help Guide
Grid Line	Displays grid lines for adjusting the image composition.	Help Guide
Exposure Set. Guide	Sets the guide displayed when exposure settings are changed in the shooting screen.	Help Guide
Live View Display	Sets whether to reflect settings such as exposure compensation in screen display.	Help Guide
Cont. Shoot. Length	Sets whether to display an indicator of the remaining time for which continuous shooting can be performed at the same shooting speed.	43
Auto Review	Sets auto review to display the captured image after shooting.	Help Guide
Custom Operation		
 Custom Key	Assigns functions to the various keys so that you can perform operations more quickly by pressing the keys when shooting still images.	Help Guide
 Custom Key	Assigns functions to the various keys so that you can perform operations more quickly by pressing the keys when shooting movies.	Help Guide
 Custom Key	Assigns functions to the keys so that you can perform operations more quickly by pressing the keys when playing back images.	Help Guide
Function Menu Set.	Customizes the functions displayed when the Fn (Function) button is pressed.	Help Guide

Dial Setup	Sets the functions of the front and rear dials when the exposure mode is set to M. Dials can be used for adjusting shutter speed and aperture value.	Help Guide
Av/Tv Rotate	Sets the direction of turning the front or rear dial or the control wheel to adjust the aperture value or shutter speed.	Help Guide
Dial Ev Comp	Sets whether to compensate the exposure with the front or rear dial.	Help Guide
MOVIE Button	Enables or disables for the MOVIE button.	Help Guide
Lock Operation Parts	Sets whether to disable the multi-selector, control wheel, or front and rear dials temporarily when the Fn button is pressed and held down.	Help Guide
Audio signals	Selects whether the camera beeps during auto focus and self-timer operations.	Help Guide

(Network)

Green tab



Snd to Smrtphn Func	Sets movies to be transferred to a smartphone, or transfers images to a smartphone.	Help Guide
Send to Computer	Backs up images by transferring them to a computer connected to a network.	Help Guide
FTP Transfer Func.	Sets image transfer using FTP and executes it. * Basic knowledge of FTP server is required.	54
View on TV	Allows you to view images on a network-enabled TV.	Help Guide
Ctrl w/ Smartphone	Sets the condition for connecting the camera to a smartphone.	Help Guide

Airplane Mode	Disables wireless communications from the device such as Wi-Fi, NFC, and Bluetooth function.	Help Guide
Wi-Fi Settings	Allows you to register your access point and check or change the Wi-Fi connection information.	Help Guide
Bluetooth Settings	Controls the settings for connecting the camera with a smartphone via a Bluetooth connection.	Help Guide
 Loc. Info. Link Set.	Obtains location information from the paired smartphone and records it to captured images.	Help Guide
Edit Device Name	Changes the device name under Wi-Fi Direct, etc.	Help Guide
Imp Root Certificate	Imports a root certificate to the camera.	Help Guide
Reset Network Set.	Resets all the network settings.	Help Guide



(Playback)

Blue tab

Protect	Protects recorded images against accidental erasure.	Help Guide
Rotate	Rotates the image.	Help Guide
Delete	Deletes images.	Help Guide
Rating	Assigns rating to recorded images on a scale from ★ to ★★★.	Help Guide
Rating Set (Cust Key)	Sets the rating (number of ★) that can be selected using the custom key to which [Rating] has been assigned with [ Custom Key].	Help Guide
Specify Printing	Specifies in advance on the memory card which still images to print out later.	Help Guide

Copy	Copies images from the memory card in the memory card slot designated in [Select PB Media] to the memory card in the other slot.	Help Guide
Photo Capture	Captures a chosen scene in a movie to save as a still image.	Help Guide
 Enlarge Image	Enlarges the playback images.	Help Guide
 Enlarge Init. Mag.	Sets the initial magnification scale when playing back enlarged images.	Help Guide
 Enlarge Initial Pos.	Sets the initial magnification area when playing back enlarged images.	Help Guide
Slide Show	Plays a slide show.	Help Guide
Select PB Media	Selects the memory card slot of the memory card to be played back.	Help Guide
View Mode	Plays back images from a specified date or specified folder of still images and movies.	Help Guide
Image Index	Displays multiple images at the same time.	Help Guide
Disp Cont Shoot Grp	Sets whether to display continuously shot images as a group.	Help Guide
Display Rotation	Sets the playback orientation for images shot vertically.	Help Guide

Monitor Brightness	Adjusts the brightness of the screen.	Help Guide
Viewfinder Bright.	Sets the brightness of the electronic viewfinder.	Help Guide
Finder Color Temp.	Sets the color temperature of the viewfinder.	Help Guide
Gamma Disp. Assist	Adjusts the screen to make monitoring easier when displaying an S-Log or HLG movie.	Help Guide
Volume Settings	Sets the volume for movie playback.	Help Guide
Delete confirm.	Sets whether [Delete] or [Cancel] is preselected in the delete confirmation screen.	Help Guide
Display Quality	Sets the display quality. * When [High] is selected, the battery is consumed more quickly. * When the temperature of the camera is high, [Display Quality] may be locked to [Standard].	Help Guide
Pwr Save Start Time	Sets the time intervals to automatically switch to power save mode.	Help Guide
Auto Pwr OFF Temp.	Sets the camera temperature at which the camera turns off automatically during shooting. When shooting in hand-held mode, set to [Standard].	Help Guide
NTSC/PAL Selector*1	Changes the TV format of the device so that you can shoot in a different movie format.	Help Guide
Cleaning Mode	Starts the cleaning mode to clean the image sensor.	Help Guide
Touch Operation	Sets whether or not to activate the touch operation of the monitor.	44

Touch Panel/Pad	Selects whether to activate touch panel operation when shooting with the monitor, or touch pad operation when shooting with the viewfinder.	44
Touch Pad Settings	Adjusts settings related to touch pad operation.	Help Guide
Demo Mode	Sets demonstration playback of movies to on or off.	Help Guide
TC/UB Settings	Sets the time code (TC) and user bit (UB). * This function is for skilled movie creators.	Help Guide
Remote Ctrl	Sets whether to use the infrared remote control.	Help Guide
HDMI Settings	Sets the HDMI settings. * Images will not appear on the monitor of the camera if you record movies while the camera is connected to an HDMI device with [File Format] set to [XAVC S 4K].	Help Guide
 4K Output Sel.	Sets how to record and output 4K movies via HDMI when the camera is connected to an external recorder/ player that supports 4K.	Help Guide
USB Connection	Sets the USB connection method.	Help Guide
USB LUN Setting	Enhances compatibility by limiting the functions of USB connection. Set to [Multi] in normal conditions and to [Single] only when the connection cannot be established.	Help Guide
USB Power Supply	Sets whether to supply power via USB connection when the camera is connected to a computer or USB device.	Help Guide
PC Remote Settings	Controls the PC remote shooting settings.	Help Guide
 Language	Selects the language.	32

Date/Time Setup	Sets the date, time, and daylight savings.	32
Area Setting	Sets the location of use.	Help Guide
Copyright Info	Sets copyright information for still images.	Help Guide
Format	Formats the memory card.	Help Guide
File Number	Sets the method used to assign file numbers.	Help Guide
Set File Name	Changes the first 3 characters of the file names for still images.	Help Guide
Rec. Media Settings	Sets the method for recording images to two memory card slots.	Help Guide
Select REC Folder	Changes the folder selected for storing still images.	Help Guide
New Folder	Creates a new folder for storing still images.	Help Guide
Folder Name	Sets the folder format for still images.	Help Guide
Recover Image DB	Recovers the image database file and enables recording and playback.	Help Guide
Display Media Info.	Displays the remaining recording time of movies and the recordable number of still images on the memory card.	Help Guide
Version	Displays the camera software version.	Help Guide
Setting Reset	Restores settings to their defaults. Select [Initialize] to restore all settings to their default values.	Help Guide

Add Item	Adds desired MENU items to ★ (My Menu).	Help Guide
Sort Item	Sorts the MENU items added to ★ (My Menu).	Help Guide
Delete Item	Deletes MENU items added to ★ (My Menu).	Help Guide
Delete Page	Deletes all the MENU items on a page in ★ (My Menu).	Help Guide
Delete All	Deletes all the MENU items added to ★ (My Menu).	Help Guide

*1 If you change this item, you will need to format the memory card for compatibility with the PAL or NTSC system. Also, note that it may not be possible to play back movies recorded for the NTSC system on PAL system TVs.

List of icons on the monitor

The displayed contents and their positions in the illustrations are just guidelines, and may differ from the actual displays.

Icons on the shooting screen

Monitor mode

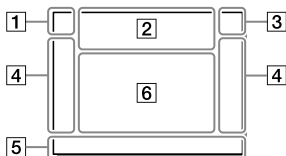

Viewfinder mode

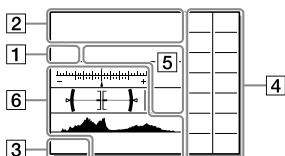

1 Shooting mode/ Scene recognition

i **P P* A S M**
i [Histogram] [P] [A] [S] [M]
S&Q P S&Q A S&Q S S&Q M

Shooting mode (33)

1 2 3 [M] [M] [M] [M]
 1 2 3 4

Register number (62)



Scene Recognition icons

2 Camera settings

1 2 [1] [2] [1RAW]
 [2RAW] [1RAW] [2RAW] [1JPEG] [2JPEG]
 [1JPEG] [2JPEG] [1R+J] [2R+J] [1R+J]

[2R+J] **NO CARD**

Memory card status (27, 85)

100

Remaining number of recordable images (87)

|||||3

Writing data / Number of images left to write

3:2 16:9

Aspect ratio of still images (61)

**42M 36M 18M 15M 11M 8.9M
4.5M 3.8M**

Image size of still images (47)

RAW RAW

RAW recording (compressed/
uncompressed) (48)

X.FINE FINE STD

JPEG Quality (48)

XAVC S 4K XAVC S HD AVCHD

File format of movies (49)

**100 60 50 25 16
FX FH**

Record setting of movies (50)

**120p 60p 60i 30p 24p
100p 50p 50i 25p**

Frame rate of movies (50)

**100PX 60PX 50PX 25PX
16PX**

Proxy Recording (67)

**120fps 60fps 30fps 15fps 8fps
4fps
100fps 50fps 25fps 12fps 6fps
3fps 2fps 1fps**

Frame rate for slow/quick
motion shooting (67)



APS-C/Super 35mm (61)



Flash charge in progress

VIEW

Setting Effect OFF (69)



AF Illuminator (62)

Flicker

Flickering detected (66)



SteadyShot off/on, Camera
shake warning (68)

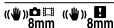

SteadyS. Focal Len./ Camera
shake warning (68)



Smart Zoom /
Clear Image Zoom / Digital
Zoom (68)

-PC-

PC remote (74)



Bright Monitoring



Silent Shooting (68)



Infrared remote control



No audio recording of movies
(67)



Wind Noise Reduct. (67)



Copyright information writing on (75)

Assist S-Log2 Assist 5-Log3 Assist HLG 709 Assist HLG 2020

Gamma Disp. Assist (73)



Focus Cancel (45)



Lock-on AF Cancel

Spot Focus

Performing [Spot Focus] (46)



NFC active (53)



Bluetooth connection available / Bluetooth connection unavailable (71)



Connected to smartphone / Not connected to smartphone



Obtaining location information/ Location information cannot be obtained (71)



Airplane Mode (71)



Overheating warning



Database file full/Database file error

3 Battery



Remaining battery (25)



Remaining battery warning



USB power supply (74)

4 Shooting settings

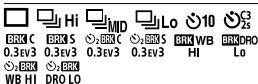

Drive Mode (42)

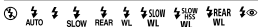

Flash Mode (65) / Wireless Flash (65) / Red Eye Reduction (65)



Flash Comp. (65)



Focus Mode (35)

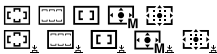

Focus Area (37)



Metering Mode (64)



7500K A5 G5

White Balance (Auto, Preset, Underwater Auto, Custom, Color temperature, Color filter) (65)



D-Range Opt./Auto HDR (65)

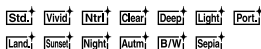

+3 +3 +3

Creative Style (65)/Contrast, saturation, and sharpness



Picture Effect (65)



Face Priority in AF (63)



Picture Profile (66)



Prioritize Rec. Media (75)

5 Focus indicator/exposure settings



Focus indicator (36)

1/250

Shutter speed

F3.5

Aperture value



Exposure compensation (64)/
Metered Manual

ISO400 ISO AUTO

ISO sensitivity (64)



AE lock/ FEL lock

6 Guides/other

● Lock-on AF

● Lock-on AF Cancel

Guide display for Lock-on AF
(63)

● Focus Cancel

Guide display for canceling
focusing (45)



Bracket indicator



Spot metering area (64)

320 400 500
5.0 5.6 6.3

Exposure Setting Guide (69)

1 1/125 1/250 1/500 1/1000 1/2000 1/4000

Shutter speed indicator

1/16 1/32 1/64 1/128 1/256 1/512 1/1024 1/2048

Aperture indicator



Histogram



Digital level gauge

STBY REC

Movie recording standby/Movie recording in progress

1:00:12

Actual movie recording time
(hours: minutes: seconds)



Audio Level Display (67)

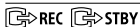

REC Control (74)

00:00:00:00

Time code (hours: minutes:
seconds: frames) (74)

00 00 00 00

User Bit (74)

Icons on the playback screen

Single-image playback display

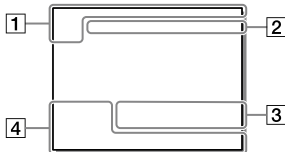

Histogram display

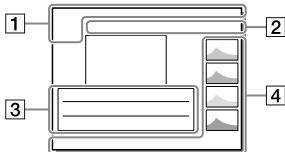

1 Basic information



Playback media (72)

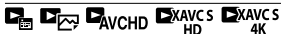

View Mode (72)



Rating (71)



Protect (71)

DPOF

DPOF set (71)

3/7

File number/Number of images
in the view mode



NFC active (53)



Remaining battery (25)



Continuous shooting group
(72)



Proxy movie included (67)

2 Camera settings

Refer to "Icons on the shooting
screen" (page 77).

3 Shooting settings



Picture Effect error



Auto HDR error (65)

35mm

Lens focal length

HLG

HDR recording (Hybrid Log-
Gamma)

Refer to "Icons on the shooting
screen" (page 77) for other icons
displayed in this area.

4 Image information



90°44'55"N
233°44'55"W

Latitude/longitude information
(71)

2017 - 1 - 1 10:37AM

Date of recording (32)



100-0003

Folder number – File number
(75)



Histogram (Luminance/R/G/B)

Specifications

Battery life and number of recordable images

		Battery life	Number of images
Shooting (still images)	Screen mode	—	Approx. 650
	Viewfinder mode	—	Approx. 530
Actual shooting (movies)	Screen mode	Approx. 115 min.	—
	Viewfinder mode	Approx. 100 min.	—
Continuous shooting (movies)	Screen mode	Approx. 190 min.	—
	Viewfinder mode	Approx. 180 min.	—

- The above estimates for battery life and number of recordable images apply when the battery pack has been fully charged. The battery life and number of images may decrease depending on the conditions of use.
- The battery life and number of recordable images are estimates based on shooting with the default settings under the following conditions:
 - Using the battery pack at an ambient temperature of 25°C (77°F).
 - Using a Sony SDXC memory card (U3) (sold separately)
 - Using a lens FE 28-70 mm F3.5-5.6 OSS (sold separately)
- The numbers for “Shooting (still images)” are based on the CIPA standard and shooting under the following conditions: (CIPA: Camera & Imaging Products Association)
 - One picture is taken every 30 seconds.
 - The power is turned on and off once every ten times.

- The number of minutes for movie shooting is based on the CIPA standard and shooting under the following conditions:
 - The image quality is set to XAVC S HD 60p 50M / 50p 50M.
 - Actual shooting (movies): Battery life based on repeated shooting, zooming, shooting stand-by, turning on/off, etc.
 - Continuous shooting (movies): Battery life based on non-stop shooting until the limit (29 minutes) has been reached, and then continued by pressing the MOVIE (Movie) button again. Other functions, such as zooming, are not operated.

Memory cards that can be used

When using microSD memory cards or Memory Stick Micro media with this camera, be sure to use the appropriate adaptor.

SD memory cards

Recording format		Supported memory card
Still image		SD/SDHC/SDXC card
AVCHD		SD/SDHC/SDXC card (Class 4 or faster, or U1 or faster)
XAVC S	4K 60 Mbps* HD 50 Mbps or lower* HD 60 Mbps	SDHC/SDXC card (Class 10, or U1 or faster)
	4K 100 Mbps* HD 100 Mbps	SDHC/SDXC card (U3)





* Including when recording proxy movies at the same time

Memory Stick media

Recording format		Supported memory card
Still image		Memory Stick PRO Duo/ Memory Stick PRO-HG Duo
AVCHD		Memory Stick PRO Duo (Mark 2)/ Memory Stick PRO-HG Duo
XAVC S	4K 60 Mbps* HD 50 Mbps or lower* HD 60 Mbps	Memory Stick PRO-HG Duo
	4K 100 Mbps* HD 100 Mbps	—

* Including when recording proxy movies at the same time

Note

- Use the slot 1 when you are using a UHS-II memory card. Also, select MENU →  (Setup) → [Rec. Media Settings] → [Prioritize Rec. Media] → [Slot 1].
- Memory Stick PRO Duo media cannot be used in the slot 1.
- When an SDHC memory card is used to record an XAVC S movie over extended periods of time, the recorded movies will be divided into files 4 GB in size. The divided files can be handled as a single file by importing them to a computer using PlayMemories Home.
- When recording a movie on memory cards in both the slot 1 and the slot 2 with following camera settings, insert two memory cards with the same file system. XAVC S movies cannot be recorded simultaneously when using a combination of the exFAT file system and FAT32 file system.
 - [File Format] is set to [XAVC S 4K] or [XAVC S HD]
 - [Recording Mode] under [Rec. Media Settings] is set to [Simult. ()] or [Simult. (/)]

Memory card	File system
SDXC memory card	exFAT
Memory Stick PRO Duo (Mark2) Memory Stick PRO-HG Duo SDHC memory card	FAT32

- Charge the battery pack sufficiently before attempting to recover the database files on the memory card.

Number of recordable images

When you insert a memory card into the camera and set the ON/OFF (Power) switch to "ON," the number of images that can be recorded (should you continue to shoot using the current settings) is displayed on the screen.

Note

- When "0" (the number of recordable images) flashes in orange, the memory card is full. Replace the memory card with another one, or delete images from the current memory card.
- When "NO CARD" flashes in orange, it means no memory card has been inserted. Insert a memory card.

The number of images that can be recorded on a memory card

The following table shows the approximate number of images that can be recorded on a memory card formatted with this camera. The values are defined using Sony standard memory cards for testing. The values may vary depending on the shooting conditions and the type of memory card used.

[JPEG Image Size]: [L: 42M]

[Aspect Ratio]: [3:2]*1

(Units: Images)

JPEG Quality/ File Format	8 GB	32 GB	64 GB	256 GB
Standard	770	3100	6200	24500
Fine	520	2100	4200	16500
Extra fine	270	1050	2150	8700
RAW & JPEG (Compressed RAW)*2	130	520	1050	4200
RAW (Compressed RAW)	170	700	1400	5600
RAW & JPEG (Uncompressed RAW)*2	75	300	600	2400
RAW (Uncompressed RAW)	88	355	710	2850

*1 When [Aspect Ratio] is set to other than [3:2], you can record more images than the numbers shown in the table (except when [RAW] is selected).

*2 [JPEG Quality] when [RAW & JPEG] is selected: [Fine]

Note

- Even if the number of recordable images is higher than 9999 images, "9999" will appear.
- The numbers shown are when using a Sony memory card.

Recordable movie times

The table below shows the approximate total recording times using a memory card formatted with this camera. The values may vary depending on the shooting conditions and the type of memory card used. The recording times for when [File Format] is set to [XAVC S 4K] and [XAVC S HD] are recording times when shooting with [Px Proxy Recording] set to [Off].

(h (hour), m (minute))

File Format	Record Setting	8 GB	32 GB	64 GB	256 GB
XAVC S 4K	30p 100M/ 25p 100M	8 m	35 m	1 h 15 m	5 h 15 m
	30p 60M/ 25p 60M	10 m	1 h	2 h 5 m	8 h 35 m
	24p 100M*	8 m	35 m	1 h 15 m	5 h 15 m
	24p 60M*	10 m	1 h	2 h 5 m	8 h 35 m
XAVC S HD	120p 100M/ 100p 100M	8 m	35 m	1 h 15 m	5 h 15 m
	120p 60M/ 100p 60M	10 m	1 h	2 h 5 m	8 h 35 m
	60p 50M/ 50p 50M	15 m	1 h 15 m	2 h 30 m	10 h 25 m
	60p 25M/ 50p 25M	30 m	2 h 25 m	5 h	20 h 10 m
	30p 50M/ 25p 50M	15 m	1 h 15 m	2 h 30 m	10 h 25 m
	30p 16M/ 25p 16M	50 m	3 h 50 m	7 h 45 m	31 h 25 m
	24p 50M*	15 m	1 h 15 m	2 h 30 m	10 h 25 m

File Format	Record Setting	8 GB	32 GB	64 GB	256 GB
AVCHD	60i 24M (FX)/ 50i 24M (FX)	40 m	2 h 55 m	6 h	24 h 15 m
	60i 17M (FH)/ 50i 17M (FH)	55 m	4 h 5 m	8 h 15 m	33 h 15 m

- * Only when [NTSC/PAL Selector] is set to NTSC
- Continuous shooting is possible for approximately 29 minutes (a product specification limit). The continuous recordable time may differ in the following situations:
 - When shooting slow-motion/quick-motion movies: Recording will automatically stop when the recorded file reaches approximately 29 minutes (the played back movie reaches approximately 29 minutes).
(Recording will automatically stop when the recorded file reaches approximately 15 minutes if [S&Q Record Setting] is set to [60p/50p] and [S&Q Frame Rate] is set to [30fps/25fps].)
- The times for slow-motion/quick-motion movies are playback times, not recording times.

Note

- The recordable time of movies varies because the camera is equipped with VBR (Variable Bit-Rate), which automatically adjusts image quality depending on the shooting scene. When you record a fast-moving subject, the image is clearer but the recordable time is shorter because more memory is required for recording. The recordable time also varies depending on the shooting conditions, the subject or the image quality/size settings.
- The times shown are recordable times using a Sony memory card.

Notes on continuous movie recording

- High-quality movie recording and high-speed continuous shooting require large amounts of power. Therefore, if you continue to shoot, the temperature inside the camera will rise, especially that of the image sensor. In such cases, the camera will turn off automatically because the surface of the camera is heated to a high temperature or the high temperature affects the quality of the images or the internal mechanism of the camera.



- The duration of time available for continuous movie recording when the camera records with the default settings after the power has been turned off for a while is as follows. The values indicate the continuous time from when the camera starts recording until the camera stops recording.

Ambient temperature	Continuous recording time for movies (HD)	Continuous recording time for movies (4K)
20°C (68°F)	Approx. 29 min.	Approx. 29 min.
30°C (86°F)	Approx. 29 min.	Approx. 29 min.
40°C (104°F)	Approx. 29 min.	Approx. 29 min.

[Auto Pwr OFF Temp.]: [Standard]

HD: XAVC S HD (60p 50M/50p 50M, when the camera is not connected via Wi-Fi)

4K: XAVC S 4K (30p 60M/25p 60M, when the camera is not connected via Wi-Fi)

- The duration of time available for movie recording varies with the temperature, file format/record setting for movies, Wi-Fi network environment, or condition of the camera before you start recording. If you frequently recompose or shoot images after the power is turned on, the temperature inside the camera will rise and the recording time available will be shorter.
- If the  icon appears, the temperature of the camera has risen.
- If the camera stops movie recording due to a high temperature, leave it for some time with the power turned off. Start recording after the temperature inside the camera drops fully.
- If you observe the following points, you will be able to record movies for longer periods of time.
 - Keep the camera out of direct sunlight.
 - Turn the camera off when it is not being used.
- When  [File Format] is set to [AVCHD], the file size of movies is limited to approx. 2 GB. If the movie file size reaches approx. 2 GB during recording, a new movie file will be created automatically.

Specifications

Camera

[System]

Camera Type:

Interchangeable Lens Digital Camera

Lens: Sony E-mount lens

[Image sensor]

Image format: 35 mm full frame
(35.9 mm × 24.0 mm), CMOS image sensor

Effective pixel number of camera:

Approx. 42 400 000 pixels

Total pixel number of camera:

Approx. 43 600 000 pixels

[SteadyShot]

In-camera sensor shift image stabilization system

[Auto focus system]

Detection system: Phase detection system/Contrast detection system

Sensitivity Range: -3 EV to +20 EV (at ISO 100 equivalent, F2.0)

[Electronic viewfinder]

Total number of dots: 3 686 400 dots

Magnification: Approx. 0.78× with 50 mm lens at infinity, -1 m^{-1}

Eye Point: Approx. 23 mm from the eyepiece and approx. 18.5 mm from the eyepiece frame at -1 m^{-1}

Diopter Adjustment:
 -4.0 m^{-1} to $+3.0 \text{ m}^{-1}$

[Monitor]

7.5 cm (3.0 type) TFT drive, touch panel

Total number of dots: 1 440 000 dots

[Exposure control]

Metering method: 1 200-zone evaluative metering

Metering Range: -3 EV to +20 EV (at ISO 100 equivalent with F2.0 lens)

ISO sensitivity (Recommended exposure index):

Still images: ISO 100 to ISO 32 000 (Extended ISO: Minimum ISO 50, maximum ISO 102 400)

Movies: ISO 100 to ISO 32 000 equivalent

[Shutter]

Type: Electronically-controlled, vertical-traverse, focal-plane type

Speed range:

Still images: 1/8 000 second to 30 seconds, BULB

Movies: 1/8 000 second to 1/4 second

1080 60i-compatible devices (1080 50i-compatible devices): up to 1/60 (1/50) second in AUTO mode (up to 1/30 (1/25) second in Auto slow shutter mode)

Flash sync speed: 1/250 second (when using a flash manufactured by Sony)

[Recording format]

File format: JPEG (DCF Ver. 2.0, Exif Ver. 2.31, MPF Baseline) compliant, RAW (Sony ARW 2.3 format)

Movie (XAVC S format):
MPEG-4 AVC/H.264 XAVC S ver.1.0 format compliant

Video: MPEG-4 AVC/H.264
Audio: LPCM 2ch (48 kHz 16 bit)

Movie (AVCHD format):
AVCHD format Ver. 2.0 compatible
Video: MPEG-4 AVC/H.264
Audio: Dolby Digital 2ch, equipped with Dolby Digital Stereo Creator

- Manufactured under license from Dolby Laboratories.

[Recording media]

SLOT 1: Slot for SD cards (UHS-I and UHS-II compatible)

SLOT 2: Multi-slot for
Memory Stick PRO Duo media and SD cards (UHS-I compatible)

[Input/output terminals]

USB Type-C terminal:
SuperSpeed USB (USB 3.1 Gen 1)

Multi/Micro USB Terminal*:
Hi-Speed USB (USB 2.0)

* Supports Micro USB compatible devices.

HDMI: HDMI type D micro jack

🎤 (Microphone) terminal:
Ø 3.5 mm Stereo mini jack

🎧 (Headphones) terminal:
Ø 3.5 mm Stereo mini jack

⚡ (Flash sync) terminal

[General]

Model No. WW940439

Rated input: 7.2 V , 3.7 W

Operating temperature:
0 to 40°C (32 to 104°F)

Storage temperature:
-20 to 55°C (-4 to 131°F)

Dimensions (W/H/D) (Approx.):
126.9 × 95.6 × 73.7 mm

126.9 × 95.6 × 62.7 mm
(from grip to monitor)

5 × 3 7/8 × 3 in.

5 × 3 7/8 × 2 1/2 in.
(from grip to monitor)

Mass (CIPA compliant) (Approx.):
657 g (1 lb 7.2 oz) (including battery pack, SD card)

[Wireless LAN]

Supported format: IEEE 802.11 b/g/n

Frequency band: 2.4 GHz

Security: WEP/WPA-PSK/WPA2-PSK

Connection method:

Wi-Fi Protected Setup™ (WPS)/
Manual

Access method: Infrastructure mode

[NFC]

Tag type: NFC Forum Type 3 Tag
compliant

[Bluetooth communications]

Bluetooth standard Ver. 4.1

Frequency band: 2.4 GHz

Battery charger BC-QZ1

Rated input:

100 - 240 V , 50/60 Hz, 0.38 A

Rated output: 8.4 V , 1.6 A

Rechargeable battery pack NP-FZ100



Rated voltage: 7.2 V 

Design and specifications are subject to change without notice.

On image data compatibility

- This camera conforms with DCF (Design rule for Camera File system) universal standard established by JEITA (Japan Electronics and Information Technology Industries Association).
- Playback of images recorded with your camera on other equipment and playback of images recorded or edited with other equipment on your camera are not guaranteed.

Trademarks

- Memory Stick and  are trademarks or registered trademarks of Sony Corporation.
- XAVC S and  are registered trademarks of Sony Corporation.
- "AVCHD" and the "AVCHD" logotype are trademarks of Panasonic Corporation and Sony Corporation.
- Mac is a trademark of Apple Inc., registered in the United States and other countries.
- IOS is a registered trademark or trademark of Cisco Systems, Inc.
- iPhone and iPad are trademarks of Apple Inc., registered in the U.S. and other countries.
- Blu-ray Disc™ and Blu-ray™ are trademarks of the Blu-ray Disc Association.
- DLNA and DLNA CERTIFIED are trademarks of Digital Living Network Alliance.
- USB Type-C™ and USB-C™ are trademarks of USB Implementers Forum.
- USB-IF SuperSpeed USB Trident logo is a registered trademark of USB Implementers Forum, Inc.
-  is a registered trademark of Dolby Laboratories.
- Dolby, Dolby Audio and double-D symbol are trademarks of Dolby Laboratories.
- The terms HDMI and HDMI High-Definition Multimedia Interface, and the HDMI Logo are trademarks or registered trademarks of HDMI Licensing Administrator, Inc. in the United States and other countries.

- Microsoft and Windows are registered trademarks or trademarks of Microsoft Corporation in the United States and/or other countries.
- SDXC logo is a trademark of SD-3C, LLC.
- Facebook and the “f” logo are trademarks or registered trademarks of Facebook, Inc.
- Android and Google Play are trademarks or registered trademarks of Google Inc.
- YouTube and the YouTube logo are trademarks or registered trademarks of Google Inc.
- Wi-Fi, the Wi-Fi logo and Wi-Fi Protected Setup are registered trademarks or trademarks of the Wi-Fi Alliance.
- The N Mark is a trademark or registered trademark of NFC Forum, Inc. in the United States and in other countries.
- The Bluetooth® word mark and logos are registered trademarks owned by the Bluetooth SIG, Inc. and any use of such marks by Sony Corporation is under license.
- QR code is a trademark of Denso Wave Inc.
- In addition, system and product names used in this manual are, in general, trademarks or registered trademarks of their respective developers or manufacturers. However, the ™ or ® marks may not be used in all cases in this manual.



■ On GNU GPL/LGPL applied software

The software that is eligible for the following GNU General Public License (hereinafter referred to as "GPL") or GNU Lesser General Public License (hereinafter referred to as "LGPL") are included in the product.

This informs you that you have a right to have access to, modify, and redistribute source code for these software programs under the conditions of the supplied GPL/LGPL. Source code is provided on the web. Use the following URL to download it. <http://oss.sony.net/Products/Linux/> We would prefer you do not contact us about the contents of source code.

Licenses (in English) are recorded in the internal memory of your product. Establish a Mass Storage connection between the product and a computer to read licenses in the "PMHOME" - "LICENSE" folder.

Additional information on this product and answers to frequently asked questions can be found at our Customer Support Website.

<http://www.sony.net/>

A

AF	37
AF-A.....	35
AF-C.....	35
AF-S.....	35
Auto focus.....	37
Auto Mode	33
AVCHD.....	49
AWB.....	65

B

Battery pack	26
--------------------	----

C

Charging.....	25
Clear Image Zoom	68
Clock setting	32
Computer	56, 58
Control wheel.....	20
Custom white balance.....	65

D

Date/Time Setup	32
Delete.....	34
Digital zoom.....	68
Diopeter-adjustment	14
Direct manual focus.....	35, 41
DISP	68
DMF	35, 41
DRO	65

F

Fn.....	14, 21
Focus.....	35
Focus indicator.....	36
Function button	14

H

HDR	65
Help Guide	2

I

In-Camera Guide.....	2
Intelligent Auto	33

L

Language	6
Lens.....	29
List of icons	77

M

Memory card.....	27, 85
MENU.....	60
MENU button	13, 60
MENU items.....	61
MF.....	35, 40
Monitor.....	77
Movie.....	34, 49
Movie file format.....	49
MOVIE (Movie) button	14
Multi-selector.....	21

N

NFC.....	5, 53
Noise reduction.....	61

O

One-touch (NFC) 53

P

Playback 34

PlayMemories Home 58

PlayMemories Mobile 53

Printing 71

Prioritize Rec. Media 28

Q

Quick Navi 22

R

RAW 48

Recordable number of images 87

Recordable time of movies 88

S

Sensitivity 64

Smart zoom 68

Software 58

Specifications 91

Still image 33

T

Touch Focus 45

Touch function 44

Touch Operation 44

Touch Panel/Pad 44

V

Volume 73

W

WB 65

Wi-Fi 5, 53

X

XAVC S 4K 49

XAVC S HD 49



<http://www.sony.net/SonyInfo/Support/>



4728779110