

SONY®

4-436-247-12(1)

Interchangeable Lens
Digital Camera

*α*99

Instruction Manual

A-mount

α

SLT-A99/SLT-A99V

Owner's Record

The model and serial numbers are located on the bottom.

Record the serial number in the space provided below.

Refer to these numbers whenever you call upon your Sony dealer regarding this product.

Model No. SLT-A99/SLT-A99V

Serial No. _____

WARNING

To reduce fire or shock hazard, do not expose the unit to rain or moisture.

**IMPORTANT SAFETY
INSTRUCTIONS
SAVE THESE
INSTRUCTIONS.
DANGER - TO
REDUCE THE RISK
OF FIRE OR
ELECTRIC SHOCK,
CAREFULLY
FOLLOW THESE
INSTRUCTIONS.**

If the shape of the plug does not fit the power outlet, use an attachment plug adaptor of the proper configuration for the power outlet.

Caution

Battery pack

If the battery pack is mishandled, the battery pack can burst, cause a fire or even chemical burns. Observe the following cautions.

- Do not disassemble.
- Do not crush and do not expose the battery pack to any shock or force such as hammering, dropping or stepping on it.
- Do not short circuit and do not allow metal objects to come into contact with the battery terminals.
- Do not expose to high temperature above 60°C (140°F) such as in direct sunlight or in a car parked in the sun.
- Do not incinerate or dispose of in fire.
- Do not handle damaged or leaking lithium ion batteries.
- Be sure to charge the battery pack using a genuine Sony battery charger or a device that can charge the battery pack.
- Keep the battery pack out of the reach of small children.
- Keep the battery pack dry.
- Replace only with the same or equivalent type recommended by Sony.
- Dispose of used battery packs promptly as described in the instructions.

Battery charger

Use the nearby wall outlet (wall socket) when using the Charger. Disconnect the Charger from the wall outlet (wall socket) immediately if any malfunction occurs while using the apparatus.

The power cord (mains lead), if supplied, is designed specifically for use with this camera only, and should not be used with other electrical equipment.

For Customers in the U.S.A. and Canada

RECYCLING LITHIUM-ION BATTERIES

Lithium-Ion batteries are recyclable.

You can help preserve our environment by returning your used rechargeable batteries to the collection and recycling location nearest you.



For more information regarding recycling of rechargeable batteries, call toll free 1-800-822-8837, or visit <http://www.rbrcl.org/>

Caution: Do not handle damaged or leaking Lithium-Ion batteries.

Battery Pack and lens (if lens supplied)

This device complies with Part 15 of the FCC Rules, Operation is subject to the following two conditions:

(1) This device may not cause harmful interference, and (2) this device must accept any interference received, including interference that may cause undesired operation.

This Class B digital apparatus complies with Canadian ICES-003.

For Customers in the U.S.A.

UL is an internationally recognized safety organization.

The UL Mark on the product means it has been UL Listed.

If you have any questions about this product, you may call:

Sony Customer Information Center
1-800-222-SONY (7669)

The number below is for the FCC related matters only.

Regulatory Information

Declaration of Conformity

Trade Name: SONY

Model No.: SLT-A99V

Responsible Party: Sony Electronics Inc.

Address: 16530 Via Esprillo,

San Diego, CA 92127 U.S.A.

Telephone No.: 858-942-2230

This device complies with Part 15 of the FCC Rules. Operation is subject to the following two conditions: (1) This device may not cause harmful interference, and (2) this device must accept any interference received, including interference that may cause undesired operation.

CAUTION

You are cautioned that any changes or modifications not expressly approved in this manual could void your authority to operate this equipment.

Note:

This equipment has been tested and found to comply with the limits for a Class B digital device, pursuant to Part 15 of the FCC Rules.

These limits are designed to provide reasonable protection against harmful interference in a residential installation. This equipment generates, uses, and can radiate radio frequency energy and, if not installed and used in accordance with the instructions, may cause harmful interference to radio communications. However, there is no guarantee that interference will not occur in a particular installation. If this equipment does cause harmful interference to radio or television reception, which can be determined by turning the equipment off and on, the user is encouraged to try to correct the interference by one or more of the following measures:

- Reorient or relocate the receiving antenna.
- Increase the separation between the equipment and receiver.
- Connect the equipment into an outlet on a circuit different from that to which the receiver is connected.
- Consult the dealer or an experienced radio/TV technician for help.

The supplied interface cable must be used with the equipment in order to comply with the limits for a digital device pursuant to Subpart B of Part 15 of FCC Rules.

For Customers in Europe

Hereby, Sony Corporation, declares that this SLT-A99V Interchangeable Lens Digital Camera is in compliance with the essential requirements and other relevant provisions of the Directive 1999/5/EC. For details, please access the following URL: <http://www.compliance.sony.de/>

Notice for the customers in the countries applying EU Directives

This product has been manufactured by or on behalf of Sony Corporation, 1-7-1 Konan Minato-ku Tokyo, 108-0075 Japan. Inquiries related to product compliance based on European Union legislation shall be addressed to the authorized representative, Sony Deutschland GmbH, Hedelfinger Strasse 61, 70327 Stuttgart, Germany. For any service or guarantee matters, please refer to the addresses provided in the separate service or guarantee documents.

This product has been tested and found compliant with the limits set out in the R&TTE Directive for using connection cables shorter than 3 meters (9.8 feet).

Attention

The electromagnetic fields at the specific frequencies may influence the picture and sound of this unit.

Notice

If static electricity or electromagnetism causes data transfer to discontinue midway (fail), restart the application or disconnect and connect the communication cable (USB, etc.) again.

Disposal of Old Electrical & Electronic Equipment (Applicable in the European Union and other European countries with separate collection systems)



This symbol on the product or on its packaging indicates that this product shall not be treated as household waste. Instead it shall be handed over to the applicable collection point for the recycling of electrical and electronic equipment. By ensuring this product is disposed of correctly, you will help prevent potential negative consequences for the environment and human health, which could otherwise be caused by inappropriate waste handling of this product. The recycling of materials will help to conserve natural resources. For more detailed information about recycling of this product, please contact your local Civic Office, your household waste disposal service or the shop where you purchased the product.

Disposal of waste batteries (applicable in the European Union and other European countries with separate collection systems)



This symbol on the battery or on the packaging indicates that the battery provided with this product shall not be treated as household waste.

On certain batteries this symbol might be used in combination with a chemical symbol. The chemical symbols for mercury (Hg) or lead (Pb) are added if the battery contains more than 0.0005% mercury or 0.004% lead.

By ensuring these batteries are disposed of correctly, you will help prevent potentially negative consequences for the environment and human health which could otherwise be caused by inappropriate waste handling of the battery. The recycling of the materials will help to conserve natural resources.



In case of products that for safety, performance or data integrity reasons require a permanent connection with an incorporated battery, this battery should be replaced by qualified service staff only. To ensure that the battery will be treated properly, hand over the product at end-of-life to the applicable collection point for the recycling of electrical and electronic equipment.

For all other batteries, please view the section on how to remove the battery from the product safely. Hand the battery over to the applicable collection point for the recycling of waste batteries.

For more detailed information about recycling of this product or battery, please contact your local Civic Office, your household waste disposal service or the shop where you purchased the product.

Notice for customers in the United Kingdom

A moulded plug complying with BS 1363 is fitted to this equipment for your safety and convenience.

Should the fuse in the plug supplied need to be replaced, a fuse of the same rating as the supplied one and approved by ASTA or BSI to BS 1362, (i.e., marked with an  or  mark) must be used.

If the plug supplied with this equipment has a detachable fuse cover, be sure to attach the fuse cover after you change the fuse.

Never use the plug without the fuse cover.

If you should lose the fuse cover, please contact your nearest Sony service station.

Table of contents

Introduction of functions	9
---------------------------------	---

Before use

Notes on using your camera	12
Checking the supplied items	15
Identifying parts	16
Front side	16
Rear side	17
Top side	19
Sides	21
Bottom	23
Shoe adaptor	24
List of icons on the screen	25
List of icons on the LCD screen	25
List of icons on the display panel	29

Functions list

Functions that can be operated with the buttons/dial	30
How to use the Quick Navi screen	31
How to use the silent multi-controller	32
Selecting a function with the Fn (Function) button	34
Functions that can be selected with the Fn (Function) button	35
The functions selected with the MENU button	37
Using the In-Camera Guide	48

Preparing the camera

Charging the battery pack	49
Inserting the battery pack/memory card (sold separately)	51
Compatible memory cards	54
Attaching a lens	55
Setting the date and time	57
Setting up the date/time again	58
Adjusting the angle of the LCD screen	59
Shooting a clear image without camera shake	60

Camera shake warning indicator	60
Using the SteadyShot function	60
Holding the camera properly	61
Removing the Eyepiece cup	62

Shooting and viewing images

Shooting still images	63
Recording movies	65
Playing back images	66
Switching between still images and movies	66
Deleting images	67

Selecting a shooting mode

Selecting a shooting mode	68
Functions available for each shooting mode	69

Various functions

Using the various functions of the camera thoughtfully	70
Depth Map Assist Continuous AF	70
AF Range Control	71
Movie recording with a positive approach to audio	72
ISO sensitivity/Multi frame noise reduction	73
Creative Style	74
Hand-held Twilight	75
DRO/Auto HDR	75
Playback functions	76

Viewing images on a computer

Using the software	77
--------------------------	----

Others

Learning more about the camera (a Handbook)	82
Checking the number of recordable images/recording time	83
Specifications	87

Index	94
--------------------	-----------

Introduction of functions

This section introduces some frequently-used shooting functions and characteristic functions.

See the pages in parentheses for details.

Shooting functions used frequently

Exposure compensation (30)

You can compensate the exposure to adjust the brightness of the entire screen.

Even when the exposure mode is set to M, the exposure can be compensated if the ISO sensitivity is set to [AUTO].

ISO sensitivity (73)/Multi frame noise reduction (73)

You can set the sensitivity to light.

The ISO sensitivity can be adjusted between ISO 50 and ISO 25600.

When you select $\frac{ISO}{AUTO}$ (Multi Frame Noise Reduct.), you can select larger ISO numbers than the maximum ISO sensitivity.

White balance (36)

You can adjust the color tones.

You can select an option to suit a light source, or perform a fine adjustment by combining the color temperature with the color filter.

Drive mode (35)

You can use an appropriate drive mode to suit your purposes, such as single-shot advanced, continuous advanced, bracket, or shooting with a Wireless Remote Commander.

Original characteristic functions

AF Range Control (71)

You can restrict the autofocus range to prevent unintended subjects from being focused on.

DRO/Auto HDR (75)

D-Range Optimizer: By dividing the image into small areas, the camera analyses the contrast of light and shadow between the subject and the background, producing the image with the optimal brightness and gradation.

Auto HDR: Shoots 3 images with different exposures, and then overlays these images to create an image with rich gradation.

Creative Style (74)

You can select the desired style from among 13 styles.

You can also adjust certain factors of the images, such as the exposure, by using the selected style as the base.

Hand-held Twilight (75)

You can shoot night scenes with less noise and blur without using a tripod.

Movie recording with manual adjustments (35)

You can adjust the exposure in P, A, S, M mode during movie recording.

How to operate or customize the camera

Screen information (40)

When you look into the viewfinder, the viewfinder mode is activated, and when you take your face away from the viewfinder, the viewing mode returns to the LCD screen mode. You can change the screen mode by pressing the DISP button.

Quick Navi (31)

In viewfinder mode, you can quickly switch the LCD screen to the Quick Navi screen by pressing the Fn button. You can set the items with an intuitive operation.

Silent multi-controller (32)

Using the silent multi-controller that is designed to reduce the sound of dial rotation, you can set certain items silently, such as focus mode, or recording level.

Customization (42)

The camera is equipped with a custom button that can be assigned a desired function. You can also assign functions to other buttons, such as the AEL button, or the ISO button.

Notes on using your camera

Screen language

You can select the language displayed on the screen using the menu (page 47).

Shooting procedure

This camera has 2 modes for monitoring subjects: the LCD screen mode using the LCD screen, and the viewfinder mode using the viewfinder.

Notes on the functions available with the camera

- To check whether it is a 1080 60i-compatible device or 1080 50i-compatible device, check for the following marks on the bottom of the camera.
1080 60i-compatible device:60i
1080 50i-compatible device:50i
- This camera is compatible with 1080 60p or 50p-format movies. Unlike standard recording modes up to now, which record in an interlacing method, this camera records using a progressive method. This increases the resolution, and provides a smoother, more realistic image.

Shooting with a DT lens

This camera is equipped with a 35 mm, full-frame CMOS sensor, however, the image size is automatically set to that of the APS-C size setting, and the image size is smaller when a DT lens ("DT" is attached to the product name) is used.

No compensation for contents of the recording

The contents of the recording cannot be compensated for if recording or playback is not possible due to a malfunction of your camera or a memory card, etc.

Back up recommendation

To avoid the potential risk of data loss, always copy (back up) data to other medium.

Notes on the LCD screen, electronic viewfinder, lens, and image sensor

- The LCD screen and electronic viewfinder are manufactured using extremely high-precision technology so over 99.99% of the pixels are operational for effective use. However, there may be some tiny black points and/or bright points (white, red, blue or green in color) that constantly appear on the LCD screen and electronic viewfinder. These points are normal in the manufacturing process and do not affect the images in any way.
- Do not hold the camera by the LCD screen.
- Do not expose the camera to sunlight or shoot sunward for a long time. The internal mechanism may be damaged. If sunlight is focused on a nearby object, it may cause a fire.
- There is a magnet on the back and around the rotating shaft of the hinge part of the LCD screen. Do not bring anything that is easily affected by a magnet, such as floppy disks or credit cards, near the LCD screen.
- Images may trail across on the screen in a cold location. This is not a malfunction. When turning on the camera in a cold location, the screen may become temporarily dark. When the camera warms up, the screen will function normally.
- The recorded image may be different from the image you monitored before recording.

Notes on long-time recording

- When you continue to shoot for a long time, the temperature of the camera rises. If the temperature reaches above a certain level, the [] icon appears on the screen and the camera turns itself off automatically. If the power is turned off, leave the camera for 10 minutes or longer to allow the temperature inside the camera to decrease to a safe level.
- Under high ambient temperatures, the temperature of the camera rises quickly.

- When the temperature of the camera rises, the image quality may deteriorate. It is recommended that you wait until the temperature of the camera drops before continuing to shoot.
- The surface of the camera may get warm. This is not a malfunction.

Notes on importing AVCHD movies to a computer

When importing AVCHD movies to a computer, for Windows computers, use the “PlayMemories Home” software on the CD-ROM (supplied).

Notes when playing movies on other devices

- This camera uses MPEG-4 AVC/H.264 High Profile for AVCHD format recording. Movies recorded in AVCHD format with this camera cannot be played with the following devices.
 - Other devices compatible with AVCHD format that does not support High Profile
 - Devices incompatible with the AVCHD format

This camera also uses MPEG-4 AVC/H.264 Main Profile for MP4 format recording. For this reason, movies recorded in MP4 format with this camera cannot be played on devices other than those that support MPEG-4 AVC/H.264.

- Discs recorded with HD image quality (high definition) can be played back only on AVCHD format-compatible devices. DVD-based players or recorders cannot play back HD image quality discs, as they are incompatible with the AVCHD format. Also, DVD-based players or recorders may fail to eject HD image quality discs.
- 1080 60p/50p movies can be played back on compatible devices only.

On GPS-compatible devices (SLT-A99V only)

- To determine whether your camera supports GPS function, check the model name of your camera.
GPS-compatible: SLT-A99V
GPS-incompatible: SLT-A99
- Use GPS in accordance with regulations of countries and regions where you use it.
- If you do not record the location information, set [GPS On/Off] to [Off] (page 45).
- In an airplane, make sure to turn off the camera following cabin announcements.

Warning on copyright

Television programs, films, videotapes, and other materials may be copyrighted. Unauthorized recording of such materials may be contrary to the provisions of the copyright laws.

The pictures used in this manual

The photographs used as examples of pictures in this manual are reproduced images, and are not actual images shot using this camera.

On the data specifications described in this manual

The data on performance and specifications is defined under the following conditions, except as described in this manual: at an ordinary ambient temperature of 25°C (77°F), and using a battery pack that has been fully charged for about 1 hour after the CHARGE lamp has turned off.

Notes on shooting with the viewfinder

This camera is equipped with an XGA Organic Electro-Luminescence viewfinder with high resolution and high contrast. This viewfinder achieves a wide viewing angle and a long eye relief. This camera is designed to provide an easily viewable viewfinder by appropriately balancing various elements.

- The image may be slightly distorted near the corners of the viewfinder. This is not a malfunction. When you want to check

every detail of the entire composition, you can also use the LCD screen.

- If you pan the camera while looking into the viewfinder or move your eyes around, the image in the viewfinder may be distorted or the color of the image may change. This is a characteristic of the lens or display device and is not a malfunction. When you shoot an image, we recommend that you look at the center area of the viewfinder.

Checking the supplied items

Consult your Sony dealer or local authorized Sony service facility if all the accessories are not supplied.

The number in parentheses indicates the number of pieces.

- Camera (1)
- BC-VM10A Battery charger (1)

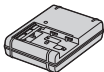

- Power cord (mains lead) (1)* (not supplied in the U.S.A. and Canada)



* Multiple power cords may be supplied with your camera. Use the appropriate one that matches your country/region.

- Rechargeable battery pack NP-FM500H (1)



- Shoe adaptor (1)/Connector protect cap (1) (Attached on the Shoe adaptor)



- USB cable (1)



- Shoulder strap (1)

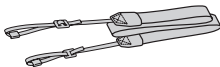

- Body cap (1) (Attached on the camera)



- Shoe Cap (1) (Attached on the camera)
- Eyepiece cup (1) (Attached on the camera)
- CD-ROM (1)
 - Application Software for α camera
 - α Handbook
- Instruction Manual (1) (This manual)

Identifying parts

See the pages in parentheses for details of operation.

Front side

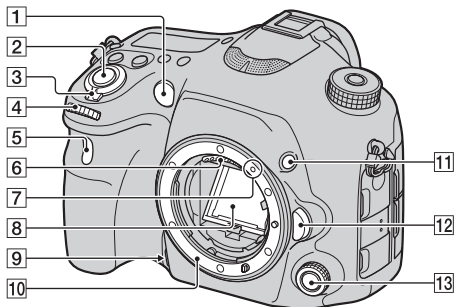

1 AF illuminator (38)/Self-timer lamp

2 Shutter button (63)

3 Power switch (57)

4 Front control dial

5 Remote sensor

6 Lens contacts*

7 Mounting index (55)

8 Mirror*

9 Preview button (30, 42)

10 Mount

11 Custom button (30, 42)





12 Lens release button (56)

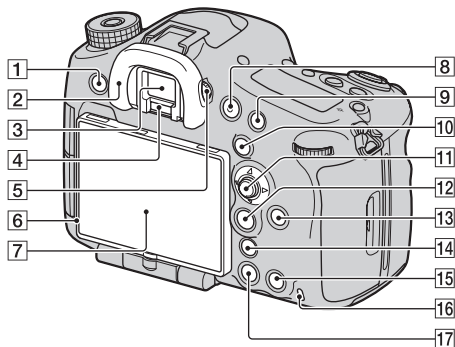

13 Silent multi-controller (32)

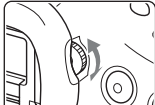
* **Do not directly touch these parts.**

Rear side





- 1** MENU button (37)
- 2** Eyepiece cup (62)
- 3** Viewfinder*
- When you look into the viewfinder, the viewfinder mode is activated, and when you take your face away from the viewfinder, the viewing mode returns to the LCD screen mode.
- 4** Eyepiece sensors (62)
- 5** Diopter-adjustment dial
- Adjust the diopter-adjustment dial to your eyesight until the display appears clearly in the viewfinder.
- 
- 6** Light sensor
- 7** LCD screen (25, 59)
- 8** MOVIE button (42, 65)
- 9** For shooting: AF/MF (Auto focus/manual focus) button (30, 42)
For viewing:  (Enlarge) button (30)
- 10** For shooting: AEL (AE lock) button (30, 41)/SLOW SYNC button (30)
For viewing:  (Image index) button (30)
- 11** Multi-selector
- 12** For shooting: Fn (Function) button (34, 35)
For viewing:  (Image rotation) button (30)

- 13** DISP (Display) button (30)
- 14**  (Smart teleconverter) button (30, 42)/Zoom button (30)/Focus Magnifier button (30)
- 15** For shooting: AF RANGE button (30)
For viewing:  (Delete) button (67)
When the Fn screen or menu screen is displayed: In-Camera Guide button (48)
- 16** Access lamp (53)
- 17**  (Playback) button (66)

* **Do not directly touch this part.**

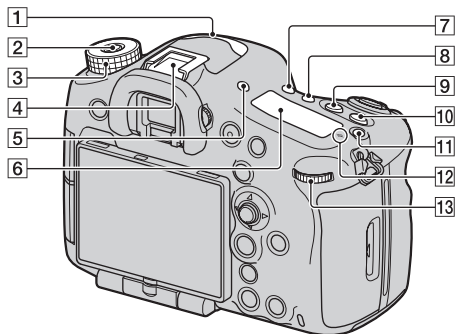
Top side



- 1 Microphone*
- 2 Mode dial lock release button (68)
- 3 Mode dial (68)
- 4 Multi interface shoe** (24)
 - Some of the accessories may not be inserted fully and protrude backward from the Multi interface shoe. However, the accessory reaches the front end of the shoe, the connection is completed.
- 5 FINDER/LCD button (30)
- 6 Display panel (29)
- 7  (Drive) button (30)
- 8 WB (White balance) button (30)
- 9  (Exposure) button (30)

- 10 ISO button (41, 73)
- 11 Display panel illumination button (29)
- 12  Image sensor position mark
- 13 Rear control dial

* **Do not cover this part during movie recording. Doing so may cause noise or lower the volume.**

** **For details on compatible accessories of the Multi interface shoe, visit the Sony web site in your area, or consult your Sony dealer or local authorized Sony service facility. Accessories for the**

**Accessory Shoe can also
be used.**

**Operations with other
manufactures'
accessories are not
guaranteed.**

ni Multi
Interface Shoe

Accessory Shoe

Sides

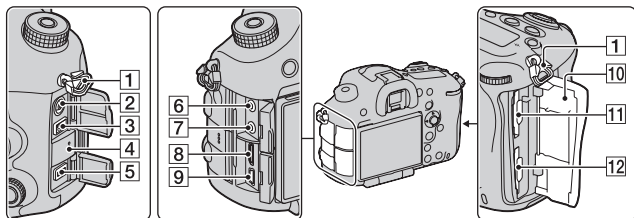

Before use

1 Hooks for shoulder strap

- Attach both ends of the strap onto the camera.

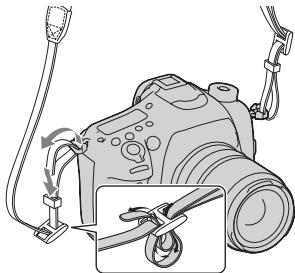
**2** ⚡ (Flash sync) terminal**3** REMOTE terminal

- When connecting the RM-L1AM Remote Commander (sold separately) to the camera, insert the plug of the Remote Commander into the REMOTE terminal, aligning the guide of the plug with the guide of the REMOTE terminal. Make sure

that the cord of the Remote Commander faces forward.

4 Speaker**5** DC IN terminal

- When connecting the AC-PW10AM AC Adaptor (sold separately) to the camera, turn the camera off, then plug the connector of the AC Adaptor to the DC IN terminal on the camera.

6 (Microphone) jack

- When an external microphone is connected, the microphone is turned on automatically. If the external microphone is a plug-in-power type, the power of the microphone is supplied by the camera.

7 (Headphones) jack**8** HDMI terminal**9** (USB) terminal**10** Memory card cover (51)

11 SLOT1 (Memory card slot 1)

(51)

- Available to either SD cards or “Memory Stick PRO Duo” media

12 SLOT2 (Memory card slot 2)

(51)

- Available to SD cards only

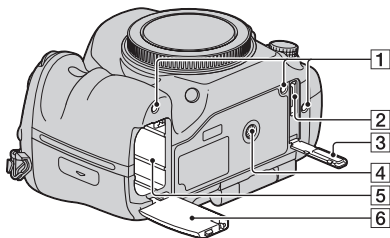
Bottom

Before use

- 1** Guide holes for the Vertical Grip
 - These holes are used when you connect the Vertical Grip (sold separately) to the camera. Be sure to keep dust or debris from getting inside the holes.
- 2** Connector for the Vertical Grip
- 3** Connector cover for the Vertical Grip
- 4** Tripod receptacle
 - Use a tripod with a screw length of less than 5.5 mm (7/32 inch). You will be unable to firmly secure the camera to tripods with a screw length of 5.5 mm (7/32 inch) or longer, and attempting to do so may damage the camera.
- 5** Battery insertion slot (51)
- 6** Battery cover (51)

Shoe adaptor

Remove the Shoe Cap attached to the camera and attach the Shoe adaptor to the camera so that you can attach accessories compatible with a conventional Accessory Shoe (Auto-lock Accessory shoe).

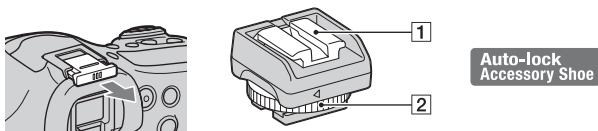

1 Auto-lock Accessory shoe

2 Lock knob

3 Tighten the Lock knob.

How to attach the Lock knob

1 Remove the Connector protect cap from the shoe.

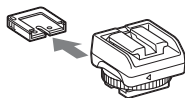

2 Loosen the Lock knob and insert the Shoe adaptor into the shoe.

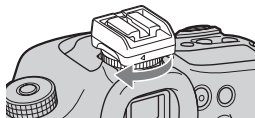
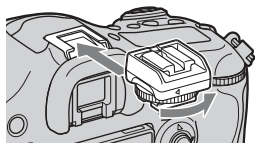

- Do not force the knob to turn after it locks.
- When you attach the Shoe adaptor to the camera, insert the Shoe adaptor all the way in.
- After you remove the Shoe adaptor from the camera, attach the Connector protect cap to the Shoe adaptor for storing the cap.

List of icons on the screen

List of icons on the LCD screen

The status of the LCD screen is set to “for the viewfinder mode (using the viewfinder for monitoring)” in the default settings.

Pressing the DISP button changes the screen status to “for the LCD screen mode.” You can also display the digital level gauge or histogram.

For the viewfinder mode

In Auto Mode or Scene Selection mode

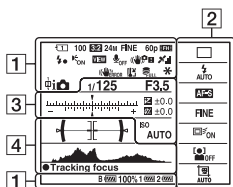

In Tele-zoom Cont. Priority AE/P/A/S/M/ Sweep Panorama mode

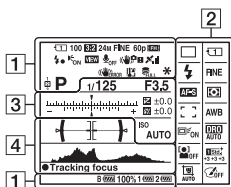

For the LCD screen mode

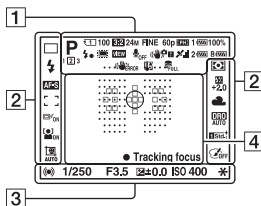

For playback (Basic information display)

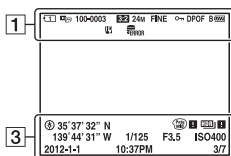











1

Display	Indication
	Exposure mode (68)
1 2 3	Register number (68)
	Scene Recognition icons (68)
	Memory card (51)/ Upload (46)
100	Remaining number of recordable images
3:2 16:9	Aspect ratio of still images (37)
24M 10M 4.6M 20M 8.7M 3.9M 10M 4.6M 2.0M 8.7M 3.9M 1.7M WIDE STD	Image size of still images (37)
RAW RAW+J X.FINE FINE STD	Image quality of still images (37)



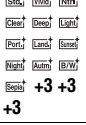













Display	Indication
60p 60i 24p 50p 50i 25p	Frame rate of movies (39)
	Image size of movies (39)
B 1 2 100%	Remaining battery (53)
	Flash charge in progress (35)
	APS-C Size Capture (46)
	Setting Effect OFF (41)
	No audio recording of movies (39)
	Wind Noise Reduction (39)
	SteadyShot/Camera shake warning (38, 39)
	GPS triangulating status (45) (SLT-A99V only)
	SteadyShot error
	Overheating warning (12)
	Database file full/ Database file error
	AE lock (30)/FEL lock (30)
	View Mode (43)
100-0003	Folder - file number
	Protect (44)
DPOF	DPOF set (44)
	Remaining battery warning (53)

2













Display	Indication
	Drive mode (35)
	Flash mode (35)/Red-eye reduction (40)
	Focus mode (35)
	AF area (35)
	Object tracking (35)
	Face Detection (35)/Smile Shutter (35)
	Metering mode (35)
	White balance (Auto, Preset, Custom, Color temperature, Color filter) (36)
	D-Range Optimizer/Auto HDR (36, 75)
	Creative Style (36, 74)/Contrast, Saturation, Sharpness
	Picture Effect (36)

Display	Indication
	Auto Portrait Framing (35)

3

Display	Indication
	EV scale
	Exposure compensation (30)/Metered Manual
	Flash compensation (36)
	Recording time of the movie (m:s)
	Focus (63)
	Shutter speed (68)
	Aperture (68)
	ISO sensitivity (35, 73)
	AE lock (30)/FEL lock (30)
	GPS information (SLT-A99V only)
	Latitude and longitude display (SLT-A99V only)
	Auto HDR image warning
	Picture Effect error
	Histogram
	Date of recording
	File number/Number of images in the view mode

4

Display	Indication
	Spot metering area (35)
	AF area (35)
	Assist area (71)
	Digital level gauge
	Histogram
	Smart teleconverter (30)
	Smart Zoom/Clear Image Zoom/Digital Zoom
	Shutter speed indicator
	Aperture indicator
	AF Range Control (30)
 Tracking focus	Tracking focus
	Audio level (72)

List of icons on the display panel

You can adjust the shutter speed, aperture, exposure compensation, flash compensation, ISO sensitivity, white balance, drive mode and image quality by checking the display panel on the top of the camera.



Shutter speed (68)/ Aperture (68)		Exposure (30)/Flash compensation (36)	
ISO sensitivity (35)		White balance (36)	
Drive mode (35)		Image quality (37)	
Remaining battery (53)		Remaining number of recordable images* (83)	

* Even when the remaining number of recordable images is more than 9,999, “9999” is displayed on the display panel.

To turn on the backlight of the display panel









Press the display panel illumination button on the top. Pressing again turns off the backlight.

Display panel illumination button



Functions that can be operated with the buttons/dial

You can set up or operate various functions with these buttons/dial.
For the location of the buttons/dial, see “Identifying parts” (page 16).

 button	Selects the drive mode.
WB button	Adjusts the white balance.
 button	Compensates the exposure.
ISO button	Adjusts the ISO sensitivity.
Mode dial	Switches the exposure mode. Rotate the dial while pressing the mode dial lock release button.
FINDER/LCD button	Switches the display between the LCD screen and the viewfinder.
Display panel illumination button	Turns on the backlight of the display panel.
MENU button	Displays the menu screen for setting up the menu item.
MOVIE button	Records movies.
AEL button/SLOW SYNC button/ button	Fixes the exposure of the entire screen./Shoots with the flash with a slower shutter speed./Displays multiple images on the screen simultaneously.
AF/MF button/ button	Switches the autofocus and manual focus temporarily./ Scales an image up when viewing images.
Fn button/ button	Displays the setup screen of the function that is set using the Fn button. In viewfinder mode, switches to the Quick Navi screen./Rotates images.
DISP button	Switches the recording information display of the viewfinder or the LCD screen.
 button/Zoom button/ Focus Magnifier button	Zooms in to the center of an image./Zooms in holding the current resolution of the image./Allows you to check the focus by enlarging the image before shooting.
 button	Plays back images.
AF RANGE button/In-Camera Guide button/ button	Limits the available operating range of autofocus./ Displays a In-Camera Guide./Deletes images.
Preview button	Checks blurring of the background.
Custom button	Assigns a frequently-used function to the button. The FEL lock function is assigned in the default settings.

Silent multi-controller

Adjusts the setting silently.

How to use the Quick Navi screen

Using the Quick Navi screen, you can change settings directly on the recording information display when the screen mode is set to [For viewfinder] (Quick Navi).

1 Press the DISP button to set the screen mode to [For viewfinder].

2 Press the Fn button to switch to the Quick Navi screen.

In Auto Mode or Scene Selection mode

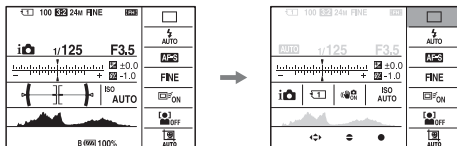

In Tele-zoom Cont. Priority AE/P/A/S/M/Sweep Panorama mode

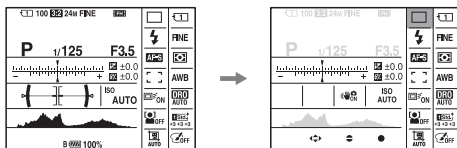

3 Select the desired item with ▲/▼/◀/▶ on the multi-selector.

4 Set the item with the front or rear control dial.

- Select an option with the front control dial and adjust it with the rear control dial.
- Pressing the center of the multi-selector turns on the designated screen used to set up the selected item.
- Pressing the Fn button again turns off the Quick Navi screen and the screen goes back to the original one.

Functions available on the Quick Navi screen

Auto Mode/Scene Selection/Tele-zoom Cont. Priority AE/Select Recording Media/Quality/SteadyShot (for still images)/Drive Mode/Flash Mode/Focus Mode/AF area/Object Tracking/Smile/Face Detect./Metering Mode/White Balance/DRO/Auto HDR/Creative Style/Picture Effect/Auto Port. Framing/Exposure Comp./Flash Comp./ISO

Notes

- Gray items on the Quick Navi screen are not available.
- When using Creative Style (page 74), some of the setup tasks can be accomplished only on a designated screen.

How to use the silent multi-controller

You can set an item without changing the screen using the silent multi-controller. Since the dial is designed to reduce the sound of the dialing operation, you can reduce the sound of the dialing operation during movie recording.

You can assign separate functions to the dial for still image shooting and movie recording (page 33).

1 Press the button so that the setup screen appears.

- [Focus Mode] is assigned to the button for still image shooting, and [Audio Rec Level] is assigned to the same button for movie recording in the default settings.

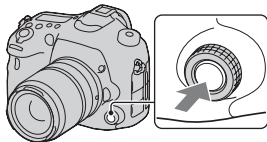

2 Rotate the dial to select the desired setting.

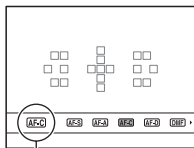
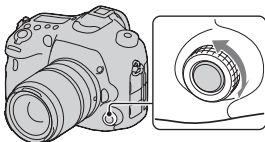

Current setting

3 Press the button to execute.

To assign other functions to the Silent Multi-Controller

Pressing and holding the button opens the screen used for assigning functions to the Silent Multi-Controller.

Rotate the dial to select a function. You can also select a function from: MENU button → 3 → [Silent Controller] or MENU button → 1 → [Silent Controller].

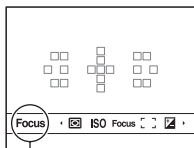

Current function

Functions available

Still image: Focus Mode/AF area/Select AF area/Exposure Comp./Metering Mode/ISO

Movie: Audio Rec Level/Focus Mode/AF area/Select AF area/Exposure Comp./Metering Mode/ISO/Shutter speed/Aperture

Selecting a function with the Fn (Function) button

This button is used for setting up or executing functions used frequently in shooting, except for functions from the Quick Navi screen.

1 Press the DISP button to set the screen mode to other than [For viewfinder] (page 30).

2 Press the Fn button.

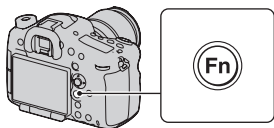

3 Select the desired item with ▲/▼/◀/▶ on the multi-selector, then press the center ● to execute.

The setup screen appears.

4 Following the operation guide, select and execute the desired function.

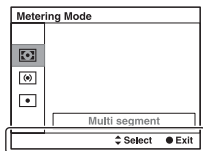

Operation guide

To set up the camera directly from the recording information screen

Turn the front control dial without pressing the center ● in step 3. You can set up the camera directly from the recording information screen.

Additionally, some functions can be fine-tuned using the rear control dial.

Functions that can be selected with the Fn (Function) button

The functions that can be selected with the Fn button are as follows:

Auto Mode	Selects the automatic shooting mode. (Intelligent Auto/Superior Auto)
Scene Selection	Selects an appropriate mode from among the Scene Selection preset settings to suit shooting conditions. (Portrait/Sports Action/Macro/Landscape/Sunset/Night Scene/Hand-held Twilight/Night Portrait)
Movie	Selects the exposure mode for movie recording to suit your subject or your effect. (P/A/S/M)
Tele-zoom Cont. Priority AE	Sets the speed for continuous shooting. (T10/T8)
Drive Mode	Sets the drive mode such as continuous shooting. (Single Shooting/Cont. Shooting/Self-timer/Bracket: Cont./Single Bracket/WB bracket/DRO Bracket/Remote Cdr.)
Flash Mode	Sets the flash mode of a flash (sold separately). (Flash Off/Autoflash/Fill-flash/Rear Sync./Wireless)
Focus Mode	Selects the focus mode. (Single-shot AF/Automatic AF/Continuous AF/Depth Map Assist Continuous AF/DMF/Manual Focus)
AF area	Selects the area of focus. (Wide/Zone/Spot/Local)
Object Tracking	Keeps the focus on a subject while tracking it. (Off/On/On(Tracking focus w/ shutter))
Smile/Face Detect.	Automatically captures people's face(s) with the optimal focus and exposure./Shoots when a smile is detected. (Face Detection Off/Face Detection On (Regist. Faces)/Face Detection On/Smile Shutter)
Auto Port. Framing	Analyzes the scene when capturing a face and saves another image with a more impressive composition. (Auto/Off)
ISO	Sets the sensitivity to light. The larger the number, the faster the shutter speed. (Multi Frame Noise Reduct./ISO AUTO/ISO 50 to 25600)
Metering Mode	Selects the method for measuring brightness. (Multi segment/Center weighted/Spot)

Flash Comp.	Adjusts the amount of flash light. (+3.0EV to -3.0EV)
White Balance	Adjusts the color tone of images. (Auto WB/Daylight/Shade/Cloudy/Incandescent/Fluor.: Warm White/Fluor.: Cool White/Fluor.: Day White/Fluor.: Daylight/Flash/C.Temp./Filter/Custom 1-3)
DRO/Auto HDR	Compensates for the brightness and contrast automatically. (Off/D-Range Opt./Auto HDR)
Creative Style	Selects your desired image processing. (Standard/Vivid/Neutral/Clear/Deep/Light/Portrait/ Landscape/Sunset/Night Scene/Autumn leaves/Black & White/Sepia/Style Box1-6)
Picture Effect	Shoots with the desired effect filter to achieve more impressive expression. (Off/Toy Camera/Pop Color/Posterization/Retro Photo/Soft High-key/Partial Color/High Contrast Mono./Soft Focus/ HDR Painting/Rich-tone Mono./Miniature)

The functions selected with the MENU button

You can set up the basic settings for the camera as a whole or execute functions such as shooting, playback, or other operations.

Press the MENU button, then set up the desired item with ▲/▼/◀/▶ on the multi-selector, then press the center of the multi-selector.

Select a page of the menu

Select an item on the menu



Still shooting menu

1 2 3 4	
Image Size	Selects the size of still images. (L/M/S)
Aspect Ratio	Selects the aspect ratio for still images. (3:2/16:9)
Quality	Sets the image quality for still images. (RAW/RAW & JPEG/Extra fine/Fine/Standard)
Panorama: Size	Selects the size of panoramic images. (Standard/Wide)
Panorama: Direction	Sets the shooting direction for panoramic images. (Right/Left/Up/Down)

1 2 3 4	
Clear Image Zoom	Zooms an image with higher quality than Digital Zoom. (On/Off)
Digital Zoom	Zooms an image with higher magnification than Clear Image Zoom. (On/Off)
Long Exposure NR	Sets noise reduction processing for shots in which shutter speed will be 1 second or longer. (On/Off)

High ISO NR	Sets noise reduction processing for high-sensitivity shooting. (Normal/Low/Off)
Flash control	Sets the method for determining the intensity of flash output. (ADI flash/Pre-flash TTL)
AF Illuminator	Sets the AF illuminator, which sheds light on a dark scene to aid focusing. (Auto/Off)



SteadyShot	Sets SteadyShot for still image shooting. (On/Off)
AF drive speed	Selects the focusing speed in autofocus mode. When [Slow] is selected in macro shooting, focusing is easier achieved. (Fast/Slow)
Color Space	Changes the range of reproducible colors. (sRGB/AdobeRGB)
 Silent Controller	Assigns the desired function to the silent multi-controller for still image shooting. (Focus Mode/AF area/Select AF area/Exposure Comp./ISO/Metering Mode)



Exposure step	Selects the size of the increment step for shutter speed, aperture, and exposure. (0.5 EV/0.3 EV)
Priority setup	Sets whether or not to release the shutter even when the focus is not confirmed in autofocus mode. (AF/Release)
AF w/ shutter	Sets whether or not to activate the autofocus by pressing the shutter button halfway down. This is convenient when you want to adjust the focus and exposure separately. (On/Off)
AEL w/ shutter	Sets whether or not to adjust the exposure by pressing the shutter button halfway down. This is convenient when you want to adjust the focus and exposure separately. (On/Off)
Memory	Registers combinations of frequently used modes and settings and allows easy recall of those combinations with the mode dial. (1/2/3)

Movie shooting menu

















File Format	Selects the movie file format. (AVCHD/MP4)
Record Setting	Selects the quality and size of the recorded movie frame. (60i 24M(FX)/50i 24M(FX)/60i 17M(FH)/50i 17M(FH)/60p 28M(PS)/50p 28M(PS)/24p 24M(FX)/25p 24M(FX)/24p 17M(FH)/25p 17M(FH)/1440×1080 12M/VGA 3M)
SteadyShot	Sets SteadyShot for movie recording. (On/Off)
AF Tracking Duration	Sets the tracking sensitivity of the autofocus feature for movie recording. (High/Mid/Low)
Auto Slow Shutter	Sets whether or not to automatically adjust the shutter speed to a slower setting during movie recording, when the subject is in a dark situation. (On/Off)
 Silent Controller	Assigns the desired function to the silent multi-controller for movie recording. (Audio Rec Level/Focus Mode/AF area/Select AF area/Exposure Comp./ISO/Metering Mode/Shutter Speed/Aperture)





















Audio Recording	Sets whether or not to record audio when shooting a movie. (On/Off)
Wind Noise Reduct.	Reduces wind noise during movie recording. (On/Off)
Audio Rec Level	Adjusts the audio recording level. (0 to 31)
Audio Level Display	Sets whether or not to display the audio level. (On/Off)
Audio Output Timing	Provides measures to reduce echo for movie recording. (Live/Lip Sync)







Custom menu

   1 2 3 4 5 6    	
Eye-Start AF	Sets whether or not to use auto focus when you look through the viewfinder. (On/Off)
FINDER/LCD Setting	Sets the method for switching between the viewfinder and LCD screen. (Auto/Manual)
Red Eye Reduction	Reduces the red-eye phenomenon during flash use. (On/Off)
Release w/o Lens	Sets whether shutter can open when lens is not attached. (Enable/Disable)
S. Auto Cont. Shooting	Sets whether or not to shoot continuously in Superior Auto mode. (Auto/Off)
S. Auto Image Extract.	Sets whether or not to save all the images that were shot continuously in Superior Auto mode. (Auto/Off)





   2 1 3 4 5 6    	
Grid Line	Sets a grid line display to enable alignment to a structural outline. (Rule of 3rds Grid/Square Grid/Diag. + Square Grid/Off)
Auto Review	Displays the captured image after shooting it automatically. You can set the duration of time the image is to be displayed. (10 Sec/5 Sec/2 Sec/Off)
DISP Button(Monitor)	Allows you to select the available screen display modes of the LCD screen that can be selected by pressing the DISP button. (Graphic Display/Display All Info./No Disp. Info./Level/Histogram/For viewfinder)
DISP Button(Finder)	Allows you to select the available screen display modes of the viewfinder that can be selected by pressing the DISP button. (Graphic Display/Display All Info./No Disp. Info./Level/Histogram)



   1 2 3 4 5 6    	
AF RANGE Button	Selects the function to be used with the AF RANGE button. (AF Range Control/In-Camera Guide)
AF Range Control Assist	Sets whether or not to show the status that the subject is located within the focus range on the screen using the assist area when the AF Range Control function is activated (available only when an AF-D compatible lens is attached). (On/Off)
Peaking Level	Enhances the outline of in-focus ranges with a specific color. (High/Mid/Low/Off)
Peaking Color	Sets the color used for the peaking function. (Red/Yellow/White)
Live View Display	Sets whether or not to display the effect of a function on the screen, such as the effect of the exposure compensation value. (Setting Effect ON/Setting Effect OFF)

   1 2 3 4 5 6    	
Func. of AEL button	Assigns the desired function to the AEL button. (Exposure Comp./Drive Mode/Flash Mode/Focus Mode/AF area/Smile/Face Detect./Auto Port. Framing/ISO/Metering Mode/Flash Comp./White Balance/DRO/Auto HDR/Creative Style/Picture Effect/Image Size/Quality/AEL hold/AEL toggle/  AEL hold/  AEL toggle/FEL Lock hold/FEL Lock toggle/Object Tracking/AF/MF Control Hold/AF/MF Control Toggle/AF lock/AF On/Aperture Preview/Shot. Result Preview/Focus Magnifier/Memory)
ISO Button	Assigns the desired function to the ISO button. (Exposure Comp./Drive Mode/Flash Mode/Focus Mode/AF area/Smile/Face Detect./Auto Port. Framing/ISO/Metering Mode/Flash Comp./White Balance/DRO/Auto HDR/Creative Style/Picture Effect/Image Size/Quality/AEL hold/AEL toggle/  AEL hold/  AEL toggle/FEL Lock hold/FEL Lock toggle/Object Tracking/AF/MF Control Hold/AF/MF Control Toggle/AF lock/AF On/Aperture Preview/Shot. Result Preview/Focus Magnifier/Memory)

AF/MF button	Assigns the desired function to the AF/MF button. (Exposure Comp./Drive Mode/Flash Mode/Focus Mode/AF area/Smile/Face Detect./Auto Port. Framing/ISO/Metering Mode/Flash Comp./White Balance/DRO/Auto HDR/Creative Style/Picture Effect/Image Size/Quality/AEL hold/AEL toggle/  AEL hold/  AEL toggle/FEL Lock hold/FEL Lock toggle/Object Tracking/AF/MF Control Hold/AF/MF Control Toggle/AF lock/AF On/Aperture Preview/Shot. Result Preview/Focus Magnifier/Memory)
Custom button	Assigns the desired function to the custom button. (Exposure Comp./Drive Mode/Flash Mode/Focus Mode/AF area/Smile/Face Detect./Auto Port. Framing/ISO/Metering Mode/Flash Comp./White Balance/DRO/Auto HDR/Creative Style/Picture Effect/Image Size/Quality/AEL hold/AEL toggle/  AEL hold/  AEL toggle/FEL Lock hold/FEL Lock toggle/Object Tracking/AF/MF Control Hold/AF/MF Control Toggle/AF lock/AF On/Aperture Preview/Shot. Result Preview/Focus Magnifier/Memory)
Preview Button	Assigns the desired function to the preview button. (Exposure Comp./Drive Mode/Flash Mode/Focus Mode/AF area/Smile/Face Detect./Auto Port. Framing/ISO/Metering Mode/Flash Comp./White Balance/DRO/Auto HDR/Creative Style/Picture Effect/Image Size/Quality/AEL hold/AEL toggle/  AEL hold/  AEL toggle/FEL Lock hold/FEL Lock toggle/Object Tracking/AF/MF Control Hold/AF/MF Control Toggle/AF lock/AF On/Aperture Preview/Shot. Result Preview/Focus Magnifier/Memory)
Smart Telecon. Button	Selects the function to be used with the  button. (Smart Telecon./Focus Magnifier/Zoom)
Focus Hold Button	Sets the function of the focus hold button of the lens. When you select [Preview Button], the function selected with [Preview Button] is assigned. (Focus Hold/Preview Button)



MOVIE Button	Selects the appropriate mode for the MOVIE button. (Always/Movie Mode Only)
Ctrl dial setup	Sets the functions of the front and rear control dials when the exposure mode is set to M. Dials can be used for adjusting shutter speed and aperture. ( SS  F/no. /  F/no.  SS)

Dial exp.comp	Compensates the exposure with the front or rear control dial. (Off/  Front dial/  Rear dial)
Exp.comp.set	Sets whether or not to compensate the exposure within the flash light range. (Ambient&flash/Ambient only)
Bracket order	Selects the order in exposure bracket and white balance bracket shooting. (0 → - → +/- → 0 → +)

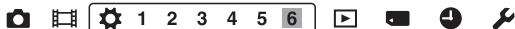

Lens Comp.: Shading	Compensates for the shaded corners of the screen caused by the lens attached. (Auto/Off)
Lens Comp.: Chro. Aber.	Reduces the color deviation at the corners of the screen caused by the lens attached. (Auto/Off)
Lens Comp.: Distortion	Compensates for distortion on the screen caused by the lens attached. (Auto/Off)
Front Curtain Shutter	Sets whether or not to use the electronic front curtain shutter function. (On/Off)
Face Priority Tracking	Sets whether to preferentially-track a certain face or not when the camera detects that face during object tracking. (On/Off)
Face Registration	Registers or changes the person to be given priority in the focus. (New Registration/Order Exchanging/Delete/Delete All)

Playback menu



Still/Movie Select	Allows you to determine how to group the playback images (View mode). (Folder View(Still)/Folder View(MP4)/AVCHD View)
Delete	Deletes images. (Multiple Img./All in Folder/All AVCHD view files)
Slide Show	Shows a slide show. (Repeat/Interval/Image Type)

Image Index	Sets the number of images displayed on one page of the image index screen. (4 Images/9 Images)
Protect	Protects or cancels protection for an image. (Multiple Img./Cancel All Images/Cancel All Movies(MP4)/Cancel All AVCHD view files)
Specify Printing	Specifies or unspecifies the images for DPOF. (DPOF Setup/Date Imprint)

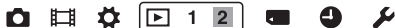

Select Playback Media	Selects the memory card slot to be used for playback. (Slot 1/Slot 2)
Copy	Duplicates images in a memory card.
Volume Settings	Sets the volume for movie playback. (0 to 7)
Playback Display	Sets how to play back an image recorded in portrait. (Auto Rotate/Manual Rotate)

Memory Card Tool menu



Select Recording Media	Selects the memory card slot to be used for recording. (Slot 1/Slot 2)
Recording Mode	Selects the recording method to record on memory cards. (Standard/Simult. Rec (Still)/Simult. Rec (Movie)/Sim. Rec (Still/Movie)/Sort(JPEG/RAW)/Sort(Still/Movie))
Format	Formats the memory card.
File Number	Sets the method used to assign file numbers to still images and MP4 movies. (Series/Reset)
Folder Name	Sets the folder format for still images. (Standard Form/Date Form)
Select REC Folder	Changes the selected folder for storing still images and MP4 movies.
New Folder	Creates a new folder for storing still images and MP4 movies.



Recover Image DB	Recovers the image database file and enables recording and playback.
Display Card Space	Displays the remaining recording time of movies and the recordable number of still images on the memory card.

Clock setup menu



Date/Time Setup	Sets date and time, and daylight savings.
Area Setting	Sets the location of where the camera is used.

Setup menu



Menu start	Sets the default position of the cursor on the menu to the top item or the last-selected item. (Top/Previous)
Delete confirm.	Sets [Delete] or [Cancel] as the default setting for the delete confirmation screen. ("Delete" first/"Cancel" first)
Mode Dial Guide	Displays an explanation of each shooting mode and also allows you to select another shooting mode. (On/Off)
LCD Brightness	Sets the brightness of the LCD screen. (Auto/Manual/Sunny Weather)
Viewfinder Bright.	Sets the brightness of the viewfinder. (Auto/Manual)
Viewfinder Color Temp.	Sets the color temperature of the screen in the viewfinder. Setting it toward + makes the color cooler, and toward – makes the color warmer. (+2 to 0 to –2)



GPS Settings (SLT-A99V only)	Sets the GPS functions.
Power Save	Sets the response level to be used to activate the power save mode. (Max/Standard)

Power Saving Start Time	Sets the interval after which power save mode engages. (30 Min/5 Min/1 Min/20 Sec/10 Sec)
HDMI Resolution	Sets the resolution when the camera is connected to an HDMI TV. (Auto/1080p/1080i)
CTRL FOR HDMI	Operates the camera from a TV that supports “BRAVIA” Sync. (On/Off)
HDMI Info. Display	Displays images on the screen of an HDMI TV connected without displaying recording information. (On/Off)



Upload Settings*	Sets whether to use the upload function of the camera with an Eye-Fi card. (On/Off)
USB Connection	Sets the USB connection method, appropriate to the computer or USB device. (Auto/Mass Storage/MTP/PC Remote)
USB LUN Setting	Allows the computer to recognize both the memory cards during a USB connection. (Multi/Single)
Audio signals	Sets whether or not to use the beep sound when the focus is achieved or the self-timer is working. (On/Off)
PAL/NTSC Selector (Only for 1080 50i-compatible models)	Plays back movies recorded with the camera on an NTSC system TV. (PAL/NTSC)
APS-C Size Capture	Sets whether or not to record with an APS-C size-equivalent area. (On/Auto)
AF Micro Adj.	Allows you to make fine adjustments to the position of the focus. (AF Adjustment Setting/amount/Clear)

* Appears when an Eye-Fi card is inserted in the memory card SLOT1 in the camera.



Version	Displays the camera software version.
Language	Selects the language.
Cleaning Mode	Starts the cleaning mode to clean the image sensor.
Demo Mode	Sets the demonstration playback of a movie to on or off. (On/Off)
Initialize	Restores the settings to their defaults. (Reset Default/Rec mode reset/Custom reset)

Using the In-Camera Guide

The AF RANGE button is equipped with both an In-Camera Guide feature and a delete feature.

When you press the AF RANGE button on the Fn screen or menu screen, a help guide explaining the currently selected function or setting appears automatically.

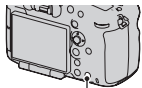

AF RANGE button

MENU button →  **3** → [AF RANGE Button] → [In-Camera Guide]

Charging the battery pack

When using the camera for the first time, be sure to charge the NP-FM500H “InfoLITHIUM” battery pack (supplied).

The “InfoLITHIUM” battery pack can be charged even when it has not been fully depleted.

It can also be used when it has not been fully charged.

The battery pack is discharged little by little without using it. To avoid missing the opportunity to shoot, charge it before use.

1 Insert the battery pack onto the battery charger.

Push the battery pack until it clicks.

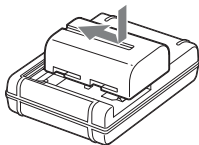

2 Connect the battery charger to the wall outlet (wall socket). For the U.S.A and Canada

Light on: Charging

Light off: Charge completed

Charging time	About 175 minutes
---------------	-------------------

- When charging a fully depleted battery pack at a temperature of 25°C (77°F).
- The CHARGE lamp turns off when charging is completed.

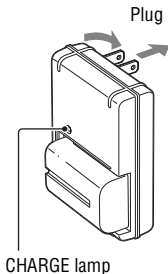

For countries/regions other than the U.S.A. and Canada

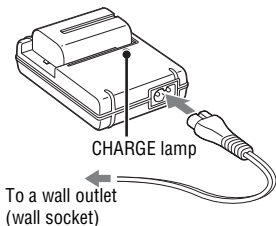

Notes

- The charging time differs depending on the remaining capacity of the battery pack or charging conditions.
- We recommend charging the battery pack in an ambient temperature of between 10°C to 30°C (50°F to 86°F). You may not be able to efficiently charge the battery pack outside of this temperature range.
- Connect the battery charger to the nearest wall outlet (wall socket).

Inserting the battery pack/memory card (sold separately)

This camera is equipped with 2 memory card slots; SLOT1 can be used with “Memory Stick PRO Duo” media or SD cards, but SLOT2 can be used only with SD cards.

- 1** While sliding the battery cover open lever, open the cover.

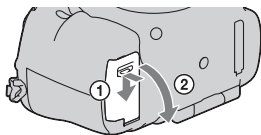

- 2** Firmly insert the battery pack all the way while pressing the lock lever with the tip of the battery.

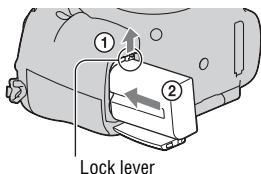

- 3** Close the cover.

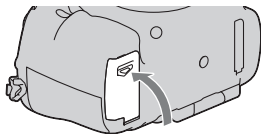

- 4** While sliding the memory card cover, open the cover.

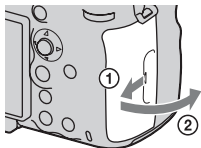

5 Insert a memory card.

- With the notched corner facing as illustrated, insert the memory card until it clicks into place.

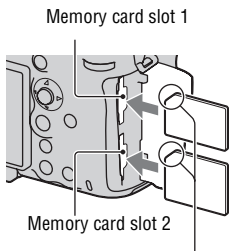

Ensure the notched corner faces correctly.

6 Close the cover.

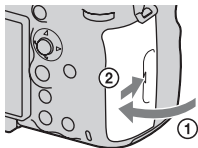

To select the memory card to be used for recording

[Slot 1] is selected in the default settings. Use slot 1 when you do not want to change the setting and intend to use only a single memory card.

MENU button → **1** → **[Select Recording Media]** → **Select the desired slot**

- You can also set [Select Recording Media] from the Quick Navi screen (page 31).

To record an image on both memory cards at the same time

You can record the same images on both memory cards at the same time or sort images onto the different memory cards by the type of image (page 44).

MENU button → **1** → **[Recording Mode]** → **Select the desired setting**

To remove the memory card

Check that the access lamp (page 18) is not lit, then open the memory card cover, and push the memory card once.

To check the remaining battery level

The supplied battery pack is a lithium-ion battery pack that has functions for exchanging information related to operating conditions with your camera. The remaining battery time in percent figures is displayed according to the operating conditions of your camera.

Battery level						"Battery exhausted."
	High Low					You cannot shoot any more pictures.

You can use 2 battery packs installed in the Vertical Grip (sold separately) by attaching it to the camera. Including the battery pack installed in the camera, this provides a total of 3 battery packs that are switched automatically.

You can check the status of these battery packs on the screen.

- B** The remaining battery level of the battery pack inserted in the camera
- 1** **2** The remaining battery level of the battery packs inserted in the Vertical Grip

For details on the Vertical Grip, refer to the operating instructions supplied with the Vertical Grip.

To remove the battery pack from the camera

Turn off the camera. Slide the lock lever in the direction of the arrow after confirming that the vibration of the camera has stopped and both the LCD screen and access lamp are turned off, then remove the battery pack. Be careful not to drop the battery pack.

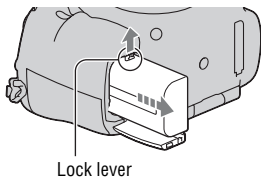

Lock lever

Compatible memory cards

The following memory cards are compatible with this camera. However, all memory cards are not guaranteed to work with this camera.

Types of memory card	Still images	Movies	Movies (Simult. Rec)	In this manual
Memory Stick PRO Duo	✓	✓* ¹	—	Memory Stick PRO Duo
Memory Stick PRO-HG Duo	✓	✓	✓	
SD memory card	✓	✓* ²	✓* ³	SD card
SDHC memory card	✓	✓* ²	✓* ³	
SDXC memory card	✓	✓* ²	✓* ³	

- MultiMediaCard cannot be used.

*1 “Memory Stick PRO Duo” media that match the Mark2

*2 SD cards that match the Class 4 or faster

*3 SD cards that match the Class 10 or faster, or the UHS-I (UHS Speed Class1) interface

Notes

- “Memory Stick PRO Duo” media cannot be used with slot 2.
- Images recorded on an SDXC memory card cannot be imported to or played on computers or AV devices that are not compatible with exFAT. Make sure that the device is compatible with exFAT before connecting it to the camera. If you connect your camera to an incompatible device, you may be prompted to format the card. Never format the card in response to this prompt, as doing so will erase all data on the card. (exFAT is the file system used on SDXC memory cards.)

Attaching a lens

1 Remove the body cap from the camera and the rear lens cap from the rear of the lens.

- When changing the lens, quickly change the lens away from dusty locations so as to keep dust or debris from getting inside the camera.
- When shooting, remove the front lens cap from the front of the lens.

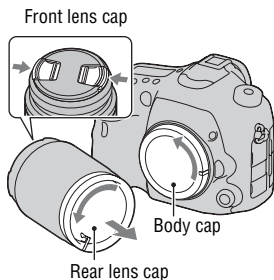

2 Mount the lens by aligning the orange index marks (mounting indexes) on the lens and camera.

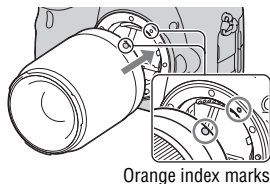

3 Turn the lens clockwise until it clicks into the locked position.

Be sure to put the lens on straight.

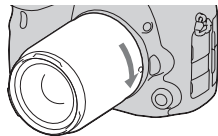

Notes

- When attaching a lens, do not press the lens release button.
- Do not use force when attaching a lens.
- E-mount lenses are not compatible with this camera.
- When a DT lens is attached or [APS-C Size Capture] is set to [On] in the  Setup menu, a live view image is displayed in full screen view on the LCD screen with the angle of view of the APS-C size. The live view image in the viewfinder is also displayed entirely and you can check the composition or effect using the whole screen.

- When you want to shoot full-frame images, use a lens designed for a full-frame camera.
- When you use a lens for which a tripod socket is provided, attach the lens onto the tripod using the tripod socket provided to help balance the weight of the lens.
- When carrying the camera with a lens attached, hold both the camera and the lens firmly.
- Do not hold the part of the lens that is extended for the zoom or focus adjustment.

To remove the lens

- 1 Press the lens release button all the way in and turn the lens counterclockwise until it stops.**

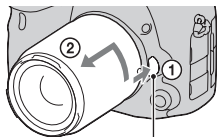

Lens release button

- 2 Attach the caps to the front and rear of the lens and the body cap to the camera.**

- Before you attach them, remove dust from them.

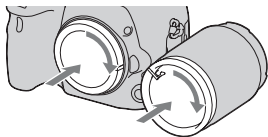

Note on changing the lens

When changing the lens, if dust or debris gets inside the camera and adheres to the surface of the image sensor (the part that converts the light to an electric signal), it may appear as dark spots on the image, depending on the shooting environment.

The camera is equipped with an anti-dust function to prevent dust from landing on the image sensor. However, quickly change the lens away from dusty locations when attaching/removing a lens.

Setting the date and time

When you turn the camera on for the first time or after you initialize the functions, the date/time setup screen appears.

1 Set the power switch to ON to turn the camera on.

The screen used for setting date and time appears.

- To turn the camera off, set it to OFF.

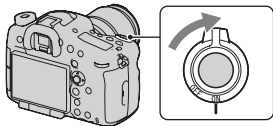

2 Verify that [Enter] is selected on the LCD screen, then press the center of the multi-selector.

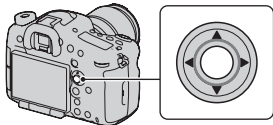

3 Select your area with ◀/▶ on the multi-selector, then press the center of the multi-selector.

4 Select each item with ◀/▶ and set the numeric value with ▲/▼.

[Daylight Svg.]: Turns on or off the daylight saving time setting.

[Date Format:]: Selects the format to display date.

- Midnight is indicated as 12:00 AM, and noon as 12:00 PM.

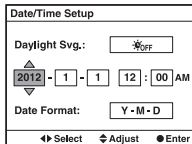
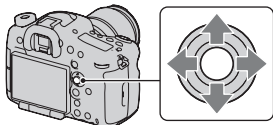

5 Repeat step 4 to set other items, then press the center of the multi-selector.

6 Verify that [Enter] is selected, then press the center of the multi-selector.

To cancel the date/time setting operation

Press the MENU button.

Setting up the date/time again

When you turn the camera on for the first time, the date/time setup screen appears automatically. The next time, set up the date and time from the menu.

MENU button →  **1** → [Date/Time Setup] or [Area Setting] (page 45)

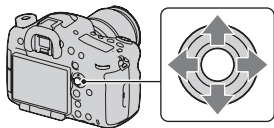

Maintaining the date and time setting

This camera has an internal rechargeable battery for maintaining the date and time and other settings regardless of whether the power is on or off, or the battery is installed or not.

Adjusting the angle of the LCD screen

Adjust the LCD screen to an easily viewable angle.

- Put your finger on the upper-left part of the LCD screen and draw it toward you.
- The LCD screen tilts 140 degrees upward and 180 degrees downward.
- The LCD screen rotates 180 degrees clockwise and 90 degrees counterclockwise.
- When the LCD screen is not used, it is recommended that you close it with the screen side facing to the camera.

Note

- When the LCD screen is open, the eyepiece sensors may not be able to function in situations involving low-position shooting. If you look into the viewfinder and the viewing mode does not switch from the monitor to the viewfinder automatically, press the FINDER/LCD button.

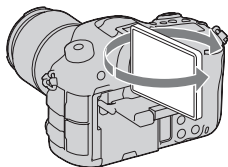
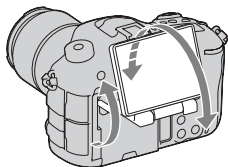
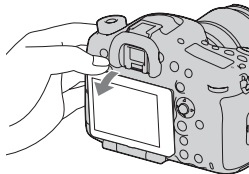



Shooting a clear image without camera shake

“Camera shake” refers to unwanted movement of the camera that occurs after the shutter button has been pressed, resulting in a blurred image. To reduce camera shake follow the instructions below.

Camera shake warning indicator

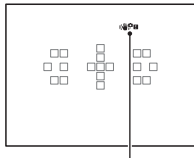
In situations where the camera may be subject to camera-shake, the  (Camera shake warning) indicator flashes. In this case, use a tripod or the flash.



 (Camera shake warning) indicator



Note

- The camera shake warning indicator does not appear in the following situations:
 - The exposure mode is set to M/S, or during movie recording.
 - When the viewing mode is set to [No Disp. Info.], [Level], or [Histogram].

Using the SteadyShot function

The SteadyShot function is available with this camera to reduce camera shake. The SteadyShot function can be set separately for still image shooting and for movie recording.

The SteadyShot function is set to [On] for still image shooting and [Off] for movie recording in the default settings.

MENU button →  **3** or  **1** → [SteadyShot] → **Select the desired setting**

- You can also set the SteadyShot function used for still image shooting from the Quick Navi screen (page 31).

Notes

- The SteadyShot function may not work optimally when the power has just been turned on, right after you point the camera towards a subject, or when the shutter button has been pressed all the way down without stopping halfway.
- When using a tripod, deactivate the SteadyShot function because there is a potential for malfunction of the SteadyShot function.

Holding the camera properly

Stabilize your upper body and take a position that keeps the camera from moving.

In viewfinder mode

In viewfinder mode
(vertical position)

In LCD screen mode

**Point ①**

One hand holds the grip of the camera, and the other hand supports the lens.

Point ②

Take a secure stance with your feet shoulder-width apart.

Point ③

Lightly tuck your elbows against your body.

When shooting in a kneeling position, steady your upper body by placing your elbow on your knee.

Removing the Eyepiece cup

When attaching the FDA-A1AM Angle Finder (sold separately) to the camera, remove the Eyepiece cup.

Carefully slide the Eyepiece cup off by pushing on each side of the Eyepiece cup.

- Put your fingers under the Eyepiece cup, and slide it upward.

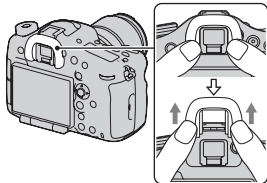

Note

- When an FDA-A1AM Angle Finder (sold separately) is attached to the camera, switch the display between the viewfinder and the LCD screen by setting [FINDER/LCD Setting] in the ⚙ Custom menu to [Manual] and pressing the FINDER/LCD button. Setting [Eye-Start AF] to [Off] is recommended because the eyepiece sensors located below the viewfinder may be activated.

Shooting still images

The “Auto Mode” allows you to easily shoot any subject under any conditions because the camera makes appropriate judgments on the situation to adjust the settings.

1 Set the mode dial to **AUTO** (Auto Mode).

- Rotate the mode dial while pressing the mode dial lock button on the center of the mode dial.

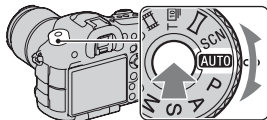

2 Hold the camera, monitoring your shot with the viewfinder.

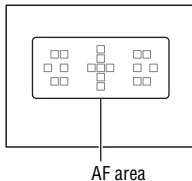

3 When using a zoom lens, turn the zoom ring, then decide on your shot.

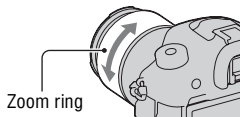

4 Press the shutter button halfway down to focus.

- When the focus is confirmed, ● or (●) (Focus indicator) lights up.

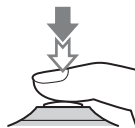

5 Press the shutter button fully down to shoot.

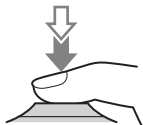

Recording movies

1 Press the MOVIE button to start recording.

- Movie recording can be started from any exposure mode.
- The camera continues to adjust the focus using [Continuous AF] when it is in autofocus mode.
- The shutter speed and aperture are adjusted automatically. If you want to set them to particular values, set them after the mode dial is set to  (Movie) (page 68).

MOVIE button

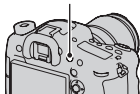

2 Press the MOVIE button again to stop recording.

Notes

- The sound of the camera and the lens in operation may be recorded while recording a movie. Using the silent multi-controller, you can reduce the sound of the dialing operation for adjustments you need to make (page 33). You can disable sound recording by setting [Audio Recording] to [Off] (page 39).
- The continuous recording time of a movie may be shorter, depending on the ambient temperature or the status of the camera. See “Notes on continuous movie recording.”
- When the  icon appears, the temperature of the camera is too high. Turn the camera off and wait until the temperature of the camera drops.

Playing back images

1 Press the  button.

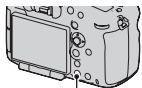

 button

2 Select an image with /  on the multi-selector.

- To play back movies, press the center of the multi-selector.

During movie playback	Multi-selector/Rear control dial operation/DISP button
To pause/resume	●
To fast-forward	▶
To fast-rewind	◀
To slow-forward	Rotate the rear control dial to the right during pause.
To slow-reverse	Rotate the rear control dial to the left during pause. <ul style="list-style-type: none">• The movie is played back frame-by-frame.
To adjust sound volume	▼ → ▲/▼
To display the information	DISP (Display) button

Note

- Movies recorded with other devices may not be played back on this camera.

Switching between still images and movies

To play back still images, set [Still/Movie Select] to [Folder View(Still)], and to play back movies, set [Still/Movie Select] to [Folder View(MP4)] or [AVCHD View] according to the file format.

MENU button →  1 → **[Still/Movie Select]** → **Select the desired mode**

Deleting images

Prior to deleting the image, be sure to make a copy or decide whether you no longer wish to keep the image or not. Make a copy of any images you may want to keep before deleting them from the camera

1 Display the image you want to delete and press the  button.

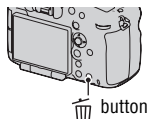

2 Select [Delete] with **▲** on the multi-selector, then press the center of the multi-selector.

Note

- Protected images cannot be deleted.

Selecting a shooting mode

Rotate the mode dial while pressing the mode dial lock button on the center of the mode dial.

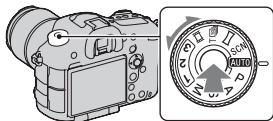

The following shooting modes are provided with the camera:

AUTO (Auto Mode)	Allows you to easily shoot any subject under any conditions because the camera makes appropriate judgements on the situation to adjust the settings.
P (Program Auto)	Allows you to shoot with the exposure adjusted automatically (both the shutter speed and the aperture value). The other settings can be adjusted manually.
A (Aperture Priority)	Allows you to shoot after adjusting the aperture value manually using the front or rear control dial.
S (Shutter Priority)	Allows you to shoot after adjusting the shutter speed manually using the front or rear control dial.
M (Manual Exposure)	Allows you to shoot after adjusting the exposure manually (both the shutter speed and the aperture value) using the front or rear control dial.
1/2/3	Calls up setting pre-registered in [Memory] in the Still shooting menu.
SCN (Scene Selection)	Allows you to easily shoot any subject under any conditions as the camera makes appropriate settings automatically.
(Sweep Panorama)	Allows you to shoot panoramic images by combining multiple images.
T (Tele-zoom Cont. Priority AE)	Allows continuous shooting while the shutter button is fully depressed. The camera records the images continuously at a maximum of about 10 or 8 images per second.
(Movie)	Allows you to shoot movies with the exposure adjusted manually (both the shutter speed and the aperture value).

- Press the Fn button when you want to change the function of the selected mode (pages 31, 34).

Functions available for each shooting mode

The functions you can use depend on the selected shooting mode. In the table below, ✓ indicates the function available. – indicates the function not available.

The functions you cannot use are displayed in gray on the screen.

Shoot Mode		Exposure Comp. (30)	Self-timer (35)	Cont. Shooting (35)	Face Detection (35)	Smile Shutter (35)	Auto Port. Framing (35)
(68)		–	✓	✓	✓	✓	✓
SCN (68)		–	✓	–	✓	✓	✓
		–	✓	✓	✓	✓	–
		–	✓	–	✓	✓	✓
		–	✓	–	✓	✓	✓
		–	✓	–	✓	✓	✓
		–	✓	–	✓	✓	✓
		–	–	–	✓	–	–
	–	✓	–	✓	✓	✓	
(68)		✓	–	–	–	–	–
(68)		✓	–	–	–	–	–
P (68)		✓	✓	✓	✓	✓	✓
A (68)		✓	✓	✓	✓	✓	✓
S (68)		✓	✓	✓	✓	✓	✓
M (68)		–*	✓	✓	✓	✓	✓
(65, 68)		✓*	✓	✓	✓	–	–

* When the exposure mode is set to M, the exposure can be compensated only when the ISO sensitivity is set to [AUTO].

Using the various functions of the camera thoughtfully

This “Instruction Manual” mainly provides the preparation of the camera before you use it, and information on the functions list. For details of the functions, refer to the “ α Handbook” on the CD-ROM.

This chapter introduces some functions described in the “ α Handbook.”

Depth Map Assist Continuous AF

In addition to the Continuous AF function, assist areas are displayed to help you to continue to focus on subjects.

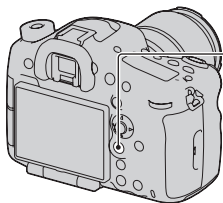

- ① Set [Focus Mode] to [Depth Map Assist Continuous AF] with the Fn button.

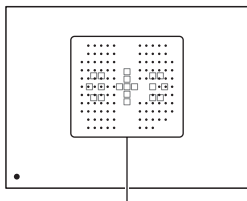

Assist area

After the camera focuses on the subject using the 19 AF areas, the camera continues to focus on the subject.

An assist area is displayed only when a compatible lens is attached to the camera.

For details on compatible lenses, visit the Sony web site in your area, or consult your Sony dealer or local authorized Sony service facility.

AF Range Control

You can restrict the autofocus range. This function allows the camera to focus on a subject without interference from objects in the back-ground and fore-ground.

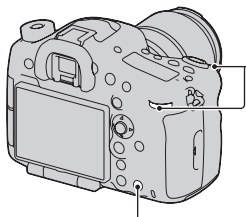

- ② Set the maximum shooting distance with the front control dial and set the minimum shooting distance with the rear control dial.



- ① Press the AF RANGE button so that the AF RANGE screen appears.
- ③ Press the AF RANGE button again to lock the distance.

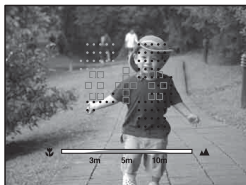

The AF area and assist area that overlap with the subject located within the AF range you set turn to yellow. An assist area is displayed only when a compatible lens is attached to the camera.

Movie recording with a positive approach to audio

In addition to full HD quality movie settings, the following items can be set: [Audio Rec Level], [Audio Level Display] and [Audio Output Timing].

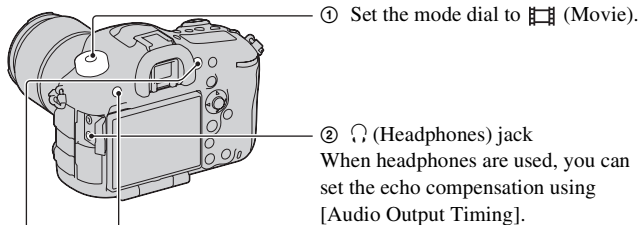

- ③ Press the MOVIE button to start or stop recording.

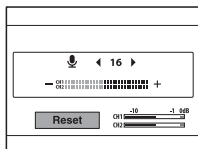

[Audio Rec Level]
You can adjust the audio recording level by monitoring the level meter.

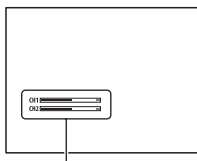



[Audio Level Display]
You can display the audio level on the screen and shoot the image.

ISO sensitivity/Multi frame noise reduction

The ISO sensitivity can be set to AUTO, or be adjusted between ISO 50 and ISO 25600.

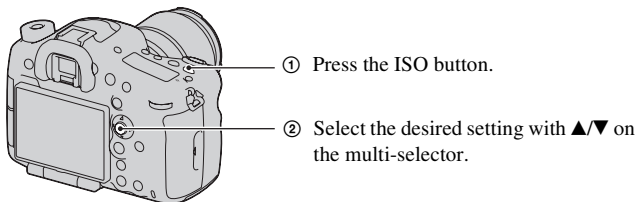
When [AUTO] is selected, you can change the range of the AUTO setting that is automatically set with [ISO AUTO Maximum] or [ISO AUTO Minimum].



When you select  (Multi Frame Noise Reduct.), you can select larger ISO numbers than the maximum ISO sensitivity.

The camera shoots continuous multiple images automatically, combines the images, reduces the noise, and records 1 image. The image recorded is comprised of one image combined from those taken.

Creative Style

You can select the style to be used to perform image processing from among 13 styles, and you can also adjust the contrast, saturation, and sharpness for each Creative Style.

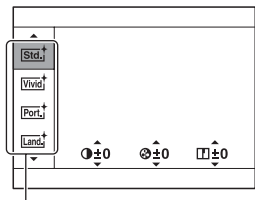
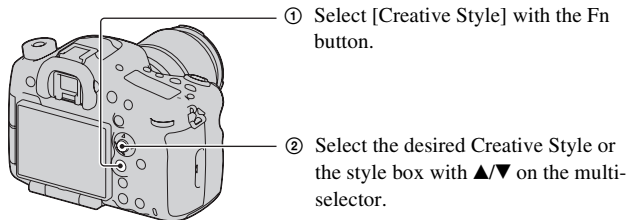

Creative Style item (13 types)

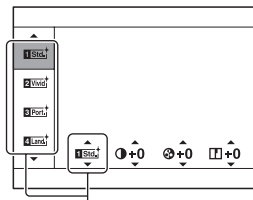

Style box

You can fine-tune the setting from the original setting and save the adjusted setting.

Hand-held Twilight

You can shoot night scenes with less noise and blur without using a tripod. A burst of shots is taken, and image processing is applied to reduce subject blur, camera shake, and noise.

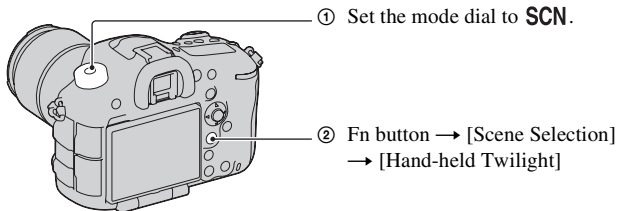

DRO/Auto HDR

Using the DRO/Auto HDR function, you can capture various gradations of the contrast of images.

DRO: By dividing the image into small areas, the camera analyses the contrast of light and shadow between the subject and the background, producing the image with the optimal brightness and gradation.

Auto HDR: Shoots 3 images with different exposures, and then overlays the correctly exposed image, the bright areas of an under exposed image and the dark areas of an over exposed image to create an image with rich gradation.

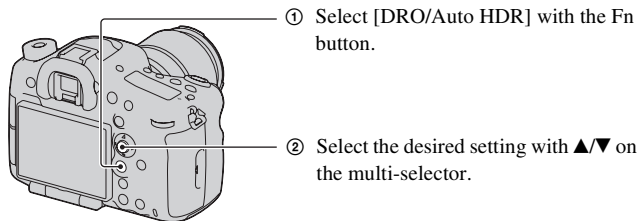

Playback functions

Convenient functions for playback are as follows:

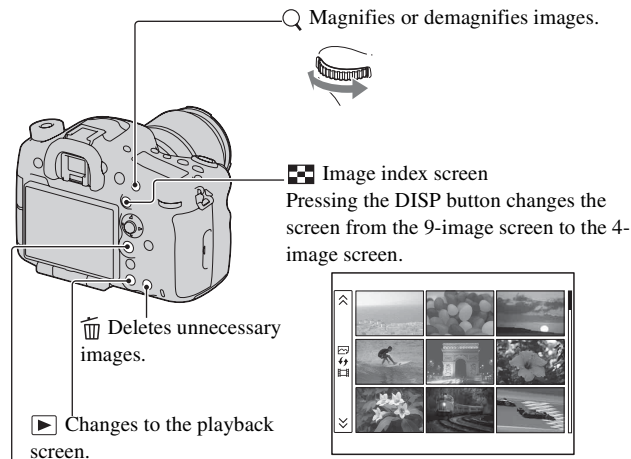

 Rotates the image counter-clockwise.

Pressing the center of the multi-selector rotates the image counter-clockwise.

Using the software

Following applications are contained on the CD-ROM (supplied) to allow more versatile use of images shot with your camera.

- “Image Data Converter”
- “PlayMemories Home”
- “Remote Camera Control”

For detailed notes on installation, also see pages 80, 81.

Using “Image Data Converter”

With “Image Data Converter” you can do things such as the following:

- Open and edit images recorded in RAW format with various corrections, such as tone curve, and sharpness.
- Adjust images with white balance, exposure, and creative style, etc.
- Save the images displayed and edited on a computer.

You can either save the image as RAW format or save it in the general file format.

- Display and compare RAW/JPEG images recorded with this camera.
- Rate the images on a scale of 5.
- Set color labels.

To use “Image Data Converter,” refer to Help.

Click [Start] → [All Programs] → [Image Data Converter] → [Help] → [Image Data Converter Ver.4].

“Image Data Converter” support page (English only)

<http://www.sony.co.jp/ids-se/>

Using “PlayMemories Home”

With “PlayMemories Home” you can do things such as the following:

- Set images shot with the camera and display them on the computer.
- Organize images on the computer on a calendar by shooting date to view them.
- Retouch (red-eye reduction, etc.), print, send still images as e-mail attachments, and change the shooting date.
- Edit images on the computer, such as trimming, resizing.

- Print or save still images with the date.
- Create Blu-ray discs or DVD discs from AVCHD movies imported to a computer. (An Internet connection environment is required when a Blu-ray disc/DVD disc is created for the first time.)

Notes

- “PlayMemories Home” is not compatible with Mac computers. When you play back images on Mac computers, use the appropriate application software supplied with the Mac computer.
- Movies recorded with the [60p 28M(PS)]/[50p 28M(PS)], [60i 24M(FX)]/[50i 24M(FX)] or [24p 24M(FX)]/[25p 24M(FX)] setting in [Record Setting] are converted by “PlayMemories Home” in order to create an AVCHD recording disc. This conversion can take a long time. Also, you cannot create a disc with the original image quality. If you want to keep the original image quality, you must store your movies on a Blu-ray disc.

To use “PlayMemories Home,” refer to “PlayMemories Home Help Guide.”

Double-click the shortcut of  (PlayMemories Home Help Guide) on the desktop. Or, click [Start] → [All Programs] → [PlayMemories Home] → [PlayMemories Home Help Guide].

“PlayMemories Home” support page (English only)

<http://www.sony.co.jp/pmh-se/>

Using “Remote Camera Control”

Connect the camera to your computer. With “Remote Camera Control” you can:

- Set up the camera or record an image from the computer.
- Record an image directly to the computer.
- Perform an Interval Timer Shooting.

Set up the following before use: MENU button →  3 → [USB Connection] → [PC Remote]

To use “Remote Camera Control,” refer to Help.

Click [Start] → [All Programs] → [Remote Camera Control] → [Help] → [Remote Camera Control Ver.3].

Note

- In Interval Timer Shooting, the drive mode is set to [Single Shooting]. If the focus is not achieved, the shutter is not released (except when the manual focus is selected or [Priority setup] in the  Still shooting menu is set to [Release]).

Recommended computer environment (Windows)

The following computer environment is recommended when using the supplied software and importing images via a USB connection.

OS (pre-installed)	Microsoft Windows XP* SP3/Windows Vista** SP2/ Windows 7 SP1
“PlayMemories Home”	CPU: Intel Pentium III 800 MHz or faster (For playing/editing the High Definition movies: Intel Core Duo 1.66 GHz or faster/Intel Core 2 Duo 1.66 GHz or faster, Intel Core 2 Duo 2.26 GHz or faster (AVC HD (FX/FH)), Intel Core 2 Duo 2.40 GHz or faster (AVC HD (PS))) Memory: Windows XP 512MB or more (1 GB or more is recommended), Windows Vista/Windows 7 1 GB or more Hard Disk: Disk space required for installation-approximately 500 MB Display: Screen resolution-1024 × 768 dots or more
“Image Data Converter Ver.4”/ “Remote Camera Control Ver.3”	CPU/Memory: Pentium 4 or faster/1 GB or more Display: 1024 × 768 dots or more

* 64-bit editions and Starter (Edition) are not supported. Windows Image Mastering API (IMAPI) Ver.2.0 or later is required to use the function for creating discs.

** Starter (Edition) is not supported.

Recommended computer environment (Mac)

The following computer environment is recommended when using the supplied software and importing images via a USB connection.

OS (pre-installed)	USB Connection: Mac OS X v10.3 – v10.8 “Image Data Converter Ver.4” “Remote Camera Control Ver.3”: Mac OS X v10.5 – v10.8
“Image Data Converter Ver.4”/ “Remote Camera Control Ver.3”	CPU: Intel Core Solo/Core Duo/Core 2 Duo or faster Memory: 1 GB or more is recommended. Display: 1024 × 768 dots or more

Notes

- Operation is not assured in an environment based on an upgrade of the operating systems described above or in a multi-boot environment.
- If you connect 2 or more USB devices to a single computer at the same time, some devices, including the camera, may not operate, depending on the types of USB devices you are using.
- Connecting the camera using a USB interface that is compatible with Hi-Speed USB (USB 2.0 compliant) allows advanced transfer (high speed transfer), as the camera is compatible with Hi-Speed USB (USB 2.0 compliant).
- When your computer resumes activity from suspend or sleep mode, communication between the camera and your computer may not recover at the same time.

Installing the software (Windows)

Log on as Administrator.

1 Turn on your computer, and insert the CD-ROM (supplied) into the CD-ROM drive.

The installation menu screen appears.

- If it does not appear, double-click [Computer] (For Windows XP: [My Computer]) →  (PMHOME) → [Install.exe].
- If the AutoPlay screen appears, select “Run Install.exe” and follow the instructions that appear on the screen to proceed with the installation.

2 Click [Install].

Make sure that “Image Data Converter” and “PlayMemories Home” are checked and follow the instructions on the screen.

- Connect the camera to the computer by following the instructions on the screen.
- When the restarting confirmation message appears, restart the computer following the instructions on the screen.
- DirectX may be installed depending on the system environment of your computer.

3 Remove the CD-ROM after the installation is complete.

The following software is installed and shortcut icons appear on the desktop.

“Image Data Converter”

“Remote Camera Control”

“PlayMemories Home”

“PlayMemories Home Help Guide”

Note

- If “PMB” (Picture Motion Browser) supplied with a camera that was purchased before 2011 has already been installed on the computer, “PMB” will be overwritten by “PlayMemories Home,” and you may be unable to use some functions of “PMB.”

Installing the software (Mac)

Log on as Administrator.

1 Turn on your Mac computer, and insert the CD-ROM (supplied) into the CD-ROM drive.

2 Double-click the CD-ROM icon.

3 Copy the [IDC_INST.pkg] and [RCC_INST.pkg] files in the [MAC] folder to the hard disk icon.

4 Double-click the [IDC_INST.pkg] and [RCC_INST.pkg] files in the copy-to folder.

Follow the instructions on the screen to complete the installation.

Learning more about the camera (α Handbook)

“ α Handbook,” which explains how to use the camera in detail, is included on the CD-ROM (supplied). Refer to it for in-depth instructions on the many functions of the camera.

For Windows users

- 1 Turn on your computer, and insert the CD-ROM (supplied) into the CD-ROM drive.**
 - 2 Click [Handbook].**
 - 3 Click [Install].**
 - 4 Start “ α Handbook” from the shortcut on the desktop.**
-

For Mac users

- 1 Turn on your computer, and insert the CD-ROM (supplied) into the CD-ROM drive.**
 - 2 Select the [Handbook] folder and copy “Handbook.pdf” stored in the [GB] folder to your computer.**
 - 3 After copying is complete, double-click “Handbook.pdf.”**
-

Checking the number of recordable images/recording time

Once you insert a memory card into the camera and set the power switch to ON, the number of images that can be recorded (should you continue to shoot using the current settings) is displayed on the screen.

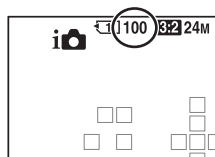

Notes

- When “0” (the number of recordable images) flashes in yellow, the memory card is full. Replace the memory card with another one, or delete images in the current memory card (pages 43, 67).
- When “NO CARD” (the number of recordable images) flashes in yellow, it means no memory card has been inserted. Insert a memory card.

The number of images that can be recorded on a memory card

The table shows the approximate number of images that can be recorded on a memory card formatted with this camera. The values are defined using Sony standard memory cards for testing. The values may vary depending on the shooting conditions and the type of memory card used.

Image Size: L 24M

Aspect Ratio: 3:2*

A memory card formatted with the camera

(Units: Images)

Capacity \ Size	2GB	4GB	8GB	16GB	32GB	64GB
Standard	280	560	1100	2250	4600	9200
Fine	195	395	800	1600	3200	6400
RAW & JPEG	54	105	215	435	870	1750
RAW	74	145	295	600	1200	2400

* When [Aspect Ratio] is set to [16:9], you can record more images than the numbers shown in the table above (except when [RAW] is selected).

The number of images that can be recorded using a battery pack

The approximate number of images that can be recorded is as follows when you use the camera with the battery pack (supplied) at full capacity.

Note that the actual numbers may be less than those indicated depending on the conditions of use.

	SLT-A99	SLT-A99V
LCD monitor mode	Approx. 500 images	Approx. 500 images
Viewfinder mode	Approx. 410 images	Approx. 410 images

- The number is calculated with a battery pack at full capacity and in the following situation:
 - At an ambient temperature of 25°C (77°F).
 - Using the battery pack that is charged for an hour after the CHARGE lamp goes out.
 - Using Sony “Memory Stick PRO Duo” media (sold separately).
 - “Memory Stick PRO Duo” media is inserted in memory card SLOT1 and there is no memory card in memory card SLOT2.
 - [Quality] is set to [Fine].
 - [Focus Mode] is set to [Automatic AF].
 - Shooting once every 30 seconds.
 - The power turns on and off once every 10 times.
 - [GPS On/Off] is set to [Off] (SLT-A99V only).
- The measurement method is based on the CIPA standard.
(CIPA: Camera & Imaging Products Association)

Available recording time for a movie

The table below shows the approximate total recording times using a memory card formatted with this camera.

A memory card formatted with the camera (h (hour), m (minute))

Record Setting	Capacity					
	2GB	4GB	8GB	16GB	32GB	64GB
60i 24M(FX)/50i 24M(FX)	10 m	20 m	40 m	1 h 30 m	3 h	6 h
60i 17M(FH)/50i 17M(FH)	10 m	30 m	1 h	2 h	4 h 5 m	8 h 15 m
60p 28M(PS)/50p 28M(PS)	9 m	15 m	35 m	1 h 15 m	2 h 30 m	5 h 5 m
24p 24M(FX)/25p 24M(FX)	10 m	20 m	40 m	1 h 30 m	3 h	6 h
24p 17M(FH)/25p 17M(FH)	10 m	30 m	1 h	2 h	4 h 5 m	8 h 15 m
1440×1080 12M	20 m	40 m	1 h 20 m	2 h 45 m	5 h 30 m	11 h 5 m
VGA 3M	1 h 10 m	2 h 25 m	4 h 55 m	10 h	20 h 5 m	40 h 15 m

Notes

- The recordable time of movies varies for the reason that the camera equipped with VBR (Variable Bit Rate) which automatically adjusts image quality depending on shooting scene. When you record fast-moving subject, the image is clearer but the recordable time is shorter because it spends much memory to record. The recordable time also vary depending on the shooting condition or subject or setting of image quality/size.
- The values shown are not the continuous recording time.
- Recording time may depend on shooting conditions and the memory card used.
- When [L] is indicated, stop recording the movie. The temperature inside the camera has increased to an unacceptable level.
- For details on movie playback, see page 66.

Notes on continuous movie recording

- It requires a lot of power to perform high quality movie recording or continuous shooting using the image sensor. Therefore, if you continue to shoot, the temperature inside the camera will rise, especially that of the image sensor. In such cases, the camera is turned off automatically since higher temperatures affect the quality of the images or burden the internal mechanism of the camera.
- The duration of time available for movie recording is as follows when the camera starts recording after the power of the camera has been turned off for a while. (The

following values indicate the continuous time from when the camera starts recording until the camera stops recording.)

Ambient temperature	Continuous recording time for movies
20°C (68°F)	About 29 minutes
30°C (86°F)	About 29 minutes
40°C (104°F)	About 29 minutes

- The duration of time available for movie recording varies with the temperature or condition of the camera before you start recording. If you frequently recompose or shoot images after the power is turned on, the temperature inside the camera rises and the recording time available is shorter than the values indicated in the table above.
- If the camera stops recording due to the temperature, leave it for several minutes with the power turned off. Start recording after the temperature inside the camera drops fully.
- If you observe the following points, the recording time is longer.
 - Keep the camera out of direct sunlight.
 - Turn the camera off when it is not being used.
- The maximum size of a movie file is about 2 GB. When the file size is about 2 GB, the recording stops automatically when [File Format] is set to [MP4], and a new movie file is created automatically when [File Format] is set to [AVCHD].
- The maximum continuous recording time is 29 minutes.

Specifications

Camera

[System]

Camera Type	Interchangeable Lens Digital Camera
Lens	A-mount lens* * When a DT lens is attached, the APS-C size is automatically selected.

[Image sensor]

Image format	35 mm full-frame (35.8 mm×23.9 mm) CMOS image sensor
Total pixel number of image sensor	Approx. 24 700 000 pixels
Effective pixel number of camera	Approx. 24 300 000 pixels

[SteadyShot]

For still images	System: Image sensor-shift mechanism Effect: Approx. 2.5 EV to 4.5 EV in shutter speed (depending on shooting conditions and the attached lens)
For movies	System: Electronic

[Anti-Dust]

System	Charge protection coating on Low-Pass Filter and image sensor-shift mechanism
--------	---

[Auto focus system]

System	TTL phase-detection system, 19 points (11 points cross type) and 102 assist points* * The AF assist function can be used only with compatible lenses.
Sensitivity Range	-1 EV to 18 EV (at ISO 100 equivalent)
AF illuminator	Approx. 1 m to 7 m (3.3 feet to 23 feet)

[Electronic viewfinder]

Type	Electronic viewfinder
Screen size	1.3 cm (0.5 type)
Total number of dots	2 359 296 dots

Frame coverage	100%
Magnification	0.71 × with 50 mm lens at infinity, -1 m^{-1} (diopter)
Eye Point	Approximately 27 mm from the eyepiece, 22 mm from the eyepiece frame at -1 m^{-1}
Diopter Adjustment	-4.0 m^{-1} to $+3.0 \text{ m}^{-1}$ (diopter)

[LCD monitor]

LCD panel	7.5 cm (3.0 type) TFT drive
Total number of dots	1 228 800 dots



[Exposure control]

Metering Cell	“Exmor” CMOS sensor
Metering method	1 200-zone evaluative metering
Metering Range	-2 EV to $+17 \text{ EV}$ (at ISO 100 equivalent with F1.4 lens)
ISO sensitivity (Recommended exposure index)	Still images: AUTO, ISO 50 to 25 600 (1/3 EV step) Movies: AUTO, ISO 100 to 6 400 (1/3 EV step) Multi frame noise reduction: AUTO/ISO 100 to 51 200
Exposure compensation	$\pm 5.0 \text{ EV}$ (switchable between 1/3 and 1/2 EV steps)

[Shutter]

Type	Electronically-controlled, vertical-traverse, focal-plane type
Speed range	Still images: 1/8 000 second to 30 seconds, bulb Movies: 1/8 000 second to 1/4 second (1/3 step) 1080 60i-compatible device up to 1/60 in AUTO mode (up to 1/30 in Auto slow shutter mode) 1080 50i-compatible device up to 1/50 in AUTO mode (up to 1/25 in Auto slow shutter mode)
Flash sync speed	1/250 second

[Continuous shooting]

Continuous shooting speed	Tele-zoom Cont. Priority AE: Approx. maximum 10 images per second/  Hi: Approx. maximum 6 images per second/  Lo: Approx. maximum 2.5 images per second <ul style="list-style-type: none"> • The speed of continuous shooting is estimated using our criteria. The speed of continuous shooting is slower, depending on shooting conditions.
---------------------------	--

The maximum number of continuous shots (when using “Memory Stick PRO-HG Duo” media)	In Tele-zoom Cont. Priority AE mode (approx. maximum 10 images per second) Extra fine: 18 images/Fine: 22 images/Standard: 24 images
	In Continuous shooting  Hi
	Extra fine: 14 images/Fine: 18 images/Standard: 20 images/RAW & JPEG: 11 images/RAW: 13 images
	<ul style="list-style-type: none"> The numbers vary, depending on the type of subject or the memory card. The numbers are calculated when the ISO sensitivity is set to ISO 320 or lower, or [High ISO NR] is set to [Off].

[Image zooming playback]

Scaling range	Image size: L: Approx. $\times 1.0 - \times 16.7$ /M: Approx. $\times 1.0 - \times 11.8$ /S: Approx. $\times 1.0 - \times 8.3$
---------------	--

[Recording format]

File format	JPEG (DCF Ver. 2.0, Exif Ver. 2.3, MPF Baseline) compliant, RAW (Sony ARW 2.3 format)
Movie (AVCHD format)	AVCHD Ver. 2.0 compliant Video: MPEG-4 AVC/H.264 Audio: Dolby Digital 2ch, equipped with Dolby Digital Stereo Creator <ul style="list-style-type: none"> Manufactured under license from Dolby Laboratories.
Movie (MP4 format)	Video: MPEG-4 AVC/H.264 Audio: MPEG-4 AAC-LC 2ch



[Recording media]

“Memory Stick PRO Duo” media, SD card

[Slot]

SLOT1	Multi-slot for “Memory Stick PRO Duo” media, SD card (UHS-I interface)
SLOT2	Slot for SD card (UHS-I interface) Operations between memory cards

[Input/output terminals]

USB	miniB, Hi-Speed USB (USB 2.0)
HDMI	HDMI minijack
 (Microphone) Terminal	∅ 3.5 mm Stereo minijack
 (Headphones) Terminal	∅ 3.5 mm Stereo minijack
REMOTE Terminal	

[Power, general]

Used battery pack	Rechargeable battery pack NP-FM500H
Power consumption (during shooting)	When using the viewfinder: Approx. 4.2 W When using the LCD screen: Approx. 3.6 W (With the SAL2470Z lens attached, for shooting still images)

[Others]

Microphone	Stereo
Speaker	Monaural
Exif Print	Compatible
PRINT Image Matching III	Compatible
DPOF	Compatible
Dimensions	Approx. 147 mm × 111.2 mm × 78.4 mm (5 7/8 inches × 4 1/2 inches × 3 1/8 inches) (W/H/D, excluding protrusions)
Mass	SLT-A99V Approx. 812 g (1 lb 12.7 oz) (with battery and “Memory Stick PRO Duo” media) Approx. 733 g (1 lb 9.9 oz) (body only) SLT-A99 Approx. 807 g (1 lb 12.5 oz) (with battery and “Memory Stick PRO Duo” media) Approx. 728 g (1 lb 9.7 oz) (body only)
Operating temperature	0°C to 40°C (32°F to 104°F)

ADP-MAA Shoe adaptor

Mass	Approx. 12 g (0.5 oz)
Dimensions	Approx. 26 mm × 20.1 mm × 26 mm (1 1/16 inches × 13/16 inches × 1 1/16 inches) (W/H/D, excluding protrusions)

BC-VM10A Battery charger

Input rating	100 V - 240 V AC, 50/60 Hz, 9 W
Output rating	8.4 V DC, 0.75 A
Operating temperature range	0°C to 40°C (32°F to 104°F)
Storage temperature range	-20°C to +60°C (-4°F to +140°F)

Maximum dimensions	Approx. 70 mm × 25 mm × 95 mm (2 7/8 inches × 1 inch × 3 3/4 inches) (W/H/D)
Mass	Approx. 90 g (3.2 oz)

Rechargeable battery pack NP-FM500H



Used battery	Lithium-ion battery	
Maximum voltage	DC 8.4 V	
Nominal voltage	DC 7.2 V	
Maximum charge voltage	DC 8.4 V	
Maximum charge current	2.0 A	
Capacity	Typical	11.8 Wh (1 650 mAh)
	Minimum	11.5 Wh (1 600 mAh)
Maximum dimensions	Approx. 38.2 mm × 20.5 mm × 55.6 mm (1 9/16 inches × 13/16 inches × 2 1/4 inches) (W/H/D)	
Mass	Approx. 78 g (2.8 oz)	

Design and specifications are subject to change without notice.

On image data compatibility

- This camera conforms with DCF (Design rule for Camera File system) universal standard established by JEITA (Japan Electronics and Information Technology Industries Association).
- Playback of images recorded with your camera on other equipment and playback of images recorded or edited with other equipment on your camera are not guaranteed.

Trademarks

- **α** is a trademark of Sony Corporation.
- “Memory Stick,” , “Memory Stick PRO,” **MEMORY STICK PRO**, “Memory Stick Duo,” **MEMORY STICK DUO**, “Memory Stick PRO Duo,” **MEMORY STICK PRO DUO**, “Memory Stick PRO-HG Duo,” **MEMORY STICK PRO-HG DUO**, “Memory Stick Micro,” “MagicGate,” and **MAGICGATE** are trademarks of Sony Corporation.
- “InfoLITHIUM” is a trademark of Sony Corporation.
- “PhotoTV HD” is a trademark of Sony Corporation.
- “AVCHD Progressive” and “AVCHD Progressive” logotype are trademarks of Panasonic Corporation and Sony Corporation.
- Blu-ray Disc TM and Blu-ray TM are trademarks of the Blu-ray Disc Association.
- Dolby and the double-D symbol are trademarks of Dolby Laboratories.
- Microsoft, Windows, DirectX, and Windows Vista are either registered trademarks or trademarks of Microsoft Corporation in the United States and/or other countries.
- The terms HDMI and HDMI High-Definition Multimedia Interface, and the HDMI Logo are trademarks or registered trademarks of HDMI Licensing LLC in the United States and other countries.
- Mac and Mac OS are trademarks or registered trademarks of Apple Inc.
- Intel, Intel Core, MMX, and Pentium are trademarks or registered trademarks of Intel Corporation.
- SDXC Logo is a trademark of SD-3C, LLC.
- Eye-Fi is a trademark of Eye-Fi Inc.
- MultiMediaCard is a trademark of MultiMediaCard Association.
- “” and “PlayStation” are registered trademarks of Sony Computer Entertainment Inc.
- Adobe is a registered trademark or a trademark of Adobe Systems Incorporated in the United States and/or other countries.
- In addition, system and product names used in this manual are, in general, trademarks or registered trademarks of their respective developers or manufacturers. However, the TM or ® marks are not used in all cases in this manual.



- Add further enjoyment with your PlayStation 3 by downloading the application for PlayStation 3 from PlayStation Store (where available.)
- The application for PlayStation 3 requires PlayStation Network account and application download. Accessible in areas where the PlayStation Store is available.



Index

A

A	68
ADI flash	38
Adobe RGB	38
AE Lock.....	30
AEL	30
AEL w/ shutter	38
AF area	35
AF drive speed.....	38
AF Illuminator	38
AF Micro Adj.	46
AF On	41
AF RANGE	71
AF RANGE Button	41
AF range control.....	71
AF Range Control Assist.....	41
AF Tracking Duration	39
AF w/ shutter	38
AF/MF button	30, 42
AF/MF control.....	30
AF-D.....	70
Ambient light.....	43
Anti-dust function.....	56
Aperture Preview	41
Aperture Priority.....	68
APS-C Size Capture	46
Area Setting	58
Aspect Ratio	37
Audio Level Display.....	39

Audio Output Timing	39
Audio Rec Level.....	39
Audio Recording.....	39
Audio signals	46
AUTO	63
Auto HDR.....	75
Auto Mode	68
Auto Port. Framing.....	35
Auto Review	40
Auto Slow Shutter.....	39
Auto WB.....	36
Autoflash.....	35
Auto-lock Accessory shoe	24
Automatic AF	35
AVCHD	39
AVCHD View	43

B

Battery pack	49, 51
Bracket order	43
Bracket: Cont.	35

C

Center weighted	35
Charging battery pack.....	49
Cleaning Mode.....	47
Clear Image Zoom	37
Cloudy (White balance).....	36
Color filter (White balance).....	36
Color Space.....	38

- Color temperature (White balance) 36
- Computer 77
- Continuous AF 35
- Continuous shooting 35
- Copy 44
- Creative Style 74
- Ctrl dial setup 42
- CTRL FOR HDMI 46
- Custom (White balance) 36
- Custom button 42
- D**
- Date Imprint 44
- Date/Time Setup 57
- Daylight (White balance) 36
- DC IN terminal 21
- Delete 43, 67
- Delete confirm. 45
- Demo Mode 47
- Depth Map Assist Continuous AF
..... 70
- Dial exp.comp 43
- Digital Zoom 37
- Diopter-adjustment 17
- Direct manual focus 35
- DISP 30
- DISP Button(Finder) 40
- DISP Button(Monitor) 40
- Display All Info. 40
- Display Card Space 45
- Display panel 29
- Display panel illumination button
..... 29
- DMF 35
- DPOF Setup 44
- D-Range Optimizer 75
- Drive mode 35
- DRO Bracket 35
- DRO/Auto HDR 75
- E**
- Enlarged image 30
- Exp.comp.set 43
- Exposure compensation 30
- Exposure mode 68
- Exposure step 38
- Extra fine 37
- Eye-Fi 46
- Eyepiece cup 62
- Eyepiece sensor 17, 62
- Eye-Start AF 40
- F**
- Face Detection 35
- Face Priority Tracking 43
- Face Registration 43
- FEL lock 30
- File Format (Movie) 39
- File Number 44
- Fill-flash 35
- FINDER/LCD Setting 40
- Fine 37
- Flash (White balance) 36

- Flash compensation36
- Flash control38
- Flash Mode35
- Flash Off35
- Flash sync terminal21
- Fluor.: Cool White (White balance)
.....36
- Fluor.: Day White (White balance)
.....36
- Fluor.: Daylight (White balance)
.....36
- Fluor.: Warm White (White
balance)36
- Fn34, 35
- Focus Hold42
- Focus Hold Button42
- Focus Magnifier42
- Focus Mode35
- Folder Name44
- Folder View43
- Format44
- Front Curtain Shutter43
- Func. of AEL button41
- Function button34
- G**
- GPS Settings45
- Graphic Display40
- Grid Line40
- H**
- Hand-held Twilight75
- HDMI Info. Display46
- HDMI Resolution 46
- HDR Painting 36
- High Contrast Mono. 36
- High ISO NR 38
- Histogram 40
- I**
- Image Data Converter 77
- Image Index 30
- Image Size 37
- In-Camera Guide 48
- Incandescent (White balance).... 36
- Initialize 47
- Install 80, 81
- Intelligent Auto 35
- ISO Button 41, 73
- ISO sensitivity 73
- L**
- Landscape 35
- Language 12, 47
- LCD Brightness 45
- LCD screen 25, 59
- Lens 55
- Lens Comp.: Chromatic Aberration
..... 43
- Lens Comp.: Distortion 43
- Lens Comp.: Peripheral Shading
..... 43
- Live View Display 41
- Local (AF area) 35
- Long Exposure NR 37

M

M	68
Macro	35
Manual Exposure	68
Manual focus	35
Mass Storage	46
Memory	38
Memory card	51, 54
MENU	37
Menu	37
Menu start	45
Metering Mode	35
Microphone jack	21
Miniature	36
Mode Dial Guide	45
MOVIE	65
Movie	65
MOVIE Button	42, 65
Movie recording	65
MP4	39
MTP	46
Multi frame noise reduction	73
Multi interface shoe	19, 24
Multi segment	35
Multi-selector	17

N

New Folder	44
Night Portrait	35
Night Scene	35
No Disp. Info.	40

Number of recordable images	83, 84
-----------------------------	--------

O

Object Tracking	35
-----------------	----

P

P	68
PAL/NTSC Selector	46
Panorama: Direction	37
Panorama: Size	37
Partial Color	36
PC Remote	46
Peaking Color	41
Peaking Level	41
Picture Effect	36
Playback Display	44
PlayMemories Home	77
Pop Color	36
Portrait	35
Posterization	36
Power Save	45
Power Saving Start Time	46
Pre-flash TTL	38
Pressing halfway down	63
Preview	30
Preview Button	30, 42
Priority setup	38
Program Auto	68
Protect	44

Q	
Quality	37
Quick Navi.....	31
R	
RAW	37
RAW+J	37
Rear sync.	35
Record Setting (Movie)	39
Recording Mode	44, 52
Recording movies	65
Recover Image DB	45
Red Eye Reduction	40
Reducing camera shake	60
Release w/o Lens	40
Remaining battery level.....	53
REMOTE.....	21
Remote Camera Control	78
Remote Commander	21, 35
REMOTE terminal	21
Retro Photo	36
Rich-tone Mono.....	36
Rotate.....	30, 76
S	
S.....	68
S. Auto Cont. Shooting.....	40
S. Auto Image Extract.	40
Scene Selection.....	68
SCN	68
Select Playback Media	44
Select REC Folder	44
Select Recording Media.....	52
Self-timer	35
Set the clock.....	57
Shade (White balance).....	36
Shoe adaptor	24
Shooting.....	63
Shooting mode	68
Shot. Result Preview.....	41
Shoulder strap	21
Shutter Priority.....	68
Silent Controller.....	33
Silent multi-controller.....	32
Single Bracket.....	35
Single Shooting.....	35
Single-shot AF	35
Slide Show	43
SLOW SYNC	30
Smart teleconverter	30
Smile Shutter	35
Soft Focus	36
Soft High-key.....	36
Software.....	77
Specifications.....	87
Specify Printing	44
Sports Action	35
Spot (AF area).....	35
Spot (Metering Mode)	35
sRGB.....	38
Standard	37
SteadyShot function.....	60
Still/Movie Select	43
Strap.....	21

Style box	74
Sunset.....	35
Superior Auto.....	35
Sweep Panorama.....	68

T

T10	35
T8	35
Tele-zoom Cont. Priority AE.....	68
Toy Camera.....	36
Tracking focus	35

U

Upload Settings.....	46
USB Connection	46
USB LUN Setting	46

V

Version.....	47
Viewfinder	17
Viewfinder Bright	45
Viewing image.....	66
Volume Settings.....	44, 66

W

WB	36
WB bracket	35
White Balance.....	36
Wide (AF area)	35
Wind Noise Reduct.	39
Wireless (Flash Mode).....	35

Z

Zone (AF area)	35
Zoom	30, 63

Additional information on this product and answers to frequently asked questions can be found at our Customer Support Website.

<http://www.sony.net/>

Printed on 70% or more recycled paper using
VOC (Volatile Organic Compound)-free
vegetable oil based ink.



4436247120