

SONY®

α560 α580

Interchangeable Lens
Digital Camera

α560 α580

Instruction Manual

A-mount

Preparing the camera

Before your operation

Shooting images

Using the shooting function

Using the viewing function

Changing your setup

Viewing images on a
computer

Printing images

Others

Index

Additional information on this product and answers to frequently asked questions can be found at our Customer Support Website.

<http://www.sony.net/>

© 2010 Sony Corporation Printed in Japan



4207863130

α

DSLR-A560/DSLR-A580

Owner's Record

The model and serial numbers are located on the bottom.

Record the serial number in the space provided below.

Refer to these numbers whenever you call upon your Sony dealer regarding this product.

Model No. DSLR-A580/A560

Serial No. _____

WARNING

To reduce fire or shock hazard, do not expose the unit to rain or moisture.

IMPORTANT SAFETY INSTRUCTIONS SAVE THESE INSTRUCTIONS. DANGER - TO REDUCE THE RISK OF FIRE OR ELECTRIC SHOCK, CAREFULLY FOLLOW THESE INSTRUCTIONS.

If the shape of the plug does not fit the power outlet, use an attachment plug adaptor of the proper configuration for the power outlet.

Caution

Battery pack

If the battery pack is mishandled, the battery pack can burst, cause a fire or even chemical burns. Observe the following cautions.

- Do not disassemble.
- Do not crush and do not expose the battery pack to any shock or force such as hammering, dropping or stepping on it.
- Do not short circuit and do not allow metal objects to come into contact with the battery terminals.
- Do not expose to high temperature above 60°C (140°F) such as in direct sunlight or in a car parked in the sun.
- Do not incinerate or dispose of in fire.
- Do not handle damaged or leaking lithium ion batteries.
- Be sure to charge the battery pack using a genuine Sony battery charger or a device that can charge the battery pack.

- Keep the battery pack out of the reach of small children.
- Keep the battery pack dry.
- Replace only with the same or equivalent type recommended by Sony.
- Dispose of used battery pack promptly described the instructions.

Battery charger

Even if the CHARGE lamp is not lit, the battery charger is not disconnected from the AC power source (mains) as long as it is connected to the wall outlet (wall socket). If some trouble occurs while using the battery charger, immediately shut off the power by disconnecting the plug from the wall outlet (wall socket).

The supplied power cord can be used only with this charger. The power cord cannot be used with other devices.

For Customers in the U.S.A. and Canada

RECYCLING LITHIUM-ION BATTERIES

Lithium-Ion batteries are recyclable.

You can help preserve our environment by returning your used rechargeable batteries to the collection and recycling location nearest you.



For more information regarding recycling of rechargeable batteries, call toll free 1-800-822-8837, or visit <http://www.rbrcl.org/>

Caution: Do not handle damaged or leaking Lithium-Ion batteries.

Battery pack

This device complies with Part 15 of the FCC Rules, Operation is subject to the following two conditions:

(1) This device may not cause harmful interference, and (2) this device must accept any interference received, including

interference that may cause undesired operation.

This Class B digital apparatus complies with Canadian ICES-003.

For Customers in the U.S.A.

UL is an internationally recognized safety organization.

The UL Mark on the product means it has been UL Listed.

If you have any questions about this product, you may call:

Sony Customer Information Services
Center
1-800-222-SONY (7669)

The number below is for the FCC related matters only.

Regulatory Information

Declaration of Conformity
Trade Name: SONY
Model No.: DSLR-A580
Responsible Party: Sony Electronics
Inc.
Address: 16530 Via Esprillo,
San Diego, CA 92127 U.S.A.
Telephone No.: 858-942-2230

This device complies with Part 15 of the FCC Rules. Operation is subject to the following two conditions: (1) This device may not cause harmful interference, and (2) this device must accept any interference received, including interference that may cause undesired operation.

Declaration of Conformity
Trade Name: SONY
Model No.: DSLR-A560
Responsible Party: Sony Electronics
Inc.
Address: 16530 Via Esprillo,
San Diego, CA 92127 U.S.A.
Telephone No.: 858-942-2230

This device complies with Part 15 of the FCC Rules. Operation is subject to the following two conditions: (1) This device may not cause harmful interference, and (2) this device must accept any interference received, including interference that may cause undesired operation.

CAUTION

You are cautioned that any changes or modifications not expressly approved in this manual could void your authority to operate this equipment.

Note:

This equipment has been tested and found to comply with the limits for a Class B digital device, pursuant to Part 15 of the FCC Rules.

These limits are designed to provide reasonable protection against harmful interference in a residential installation. This equipment generates, uses, and can radiate radio frequency energy and, if not installed and used in accordance with the instructions, may cause harmful interference to radio communications. However, there is no guarantee that interference will not occur in a particular installation. If this equipment does cause harmful interference to radio or television reception, which can be determined by turning the equipment off and on, the user is encouraged to try to correct the interference by one or more of the following measures:

- Reorient or relocate the receiving antenna.
- Increase the separation between the equipment and receiver.
- Connect the equipment into an outlet on a circuit different from that to which the receiver is connected.
- Consult the dealer or an experienced radio/TV technician for help.

The supplied interface cable must be used with the equipment in order to comply with the limits for a digital device pursuant to Subpart B of Part 15 of FCC Rules.

For Customers in Europe

Notice for the customers in the countries applying EU Directives

The manufacturer of this product is Sony Corporation, 1-7-1 Konan Minato-ku Tokyo, 108-0075 Japan. The Authorized Representative for EMC and product safety is Sony Deutschland GmbH, Hedelfinger Strasse 61, 70327 Stuttgart, Germany. For any service or guarantee matters please refer to the addresses given in separate service or guarantee documents.

This product has been tested and found compliant with the limits set out in the EMC Directive for using connection cables shorter than 3 meters (9.8 feet).

Attention

The electromagnetic fields at the specific frequencies may influence the picture and sound of this unit.

Notice

If static electricity or electromagnetism causes data transfer to discontinue midway (fail), restart the application or disconnect and connect the communication cable (USB, etc.) again.

Disposal of Old Electrical & Electronic Equipment (Applicable in the European Union and other European countries with separate collection systems)



This symbol on the product or on its packaging indicates that this product shall not be treated as household waste. Instead it shall be handed over to the applicable collection point for the recycling of electrical and electronic equipment. By ensuring this product is disposed of correctly, you will help prevent potential negative consequences for the environment and human health, which could otherwise be caused by inappropriate waste handling of this product. The recycling of materials will help to conserve natural resources. For more detailed information about recycling of this product, please contact your local Civic Office, your household waste disposal service or the shop where you purchased the product.

Disposal of waste batteries (applicable in the European Union and other European countries with separate collection systems)



This symbol on the battery or on the packaging indicates that the battery provided with this product shall not be treated as household waste.

On certain batteries this symbol might be used in combination with a chemical symbol. The chemical symbols for mercury (Hg) or lead (Pb) are added if the battery contains more than 0.0005% mercury or 0.004% lead.

By ensuring these batteries are disposed of correctly, you will help prevent potentially negative consequences for the environment and human health which could otherwise be caused by inappropriate waste handling of the battery. The recycling of the materials will help to conserve natural resources.

In case of products that for safety, performance or data integrity reasons require a permanent connection with an incorporated battery, this battery should be replaced by qualified service staff only.



To ensure that the battery will be treated properly, hand over the product at end-of-life to the applicable collection point for the recycling of electrical and electronic equipment.

For all other batteries, please view the section on how to remove the battery from the product safely. Hand the battery over to the applicable collection point for the recycling of waste batteries.

For more detailed information about recycling of this product or battery, please contact your local Civic Office, your household waste disposal service or the shop where you purchased the product.

Notice for customers in the United Kingdom

A moulded plug complying with BS 1363 is fitted to this equipment for your safety and convenience.

Should the fuse in the plug supplied need to be replaced, a fuse of the same rating as the supplied one and approved by ASTA or BSI to BS 1362, (i.e., marked with an  or  mark) must be used.

If the plug supplied with this equipment has a detachable fuse cover, be sure to attach the fuse cover after you change the fuse.

Never use the plug without the fuse cover. If you should lose the fuse cover, please contact your nearest Sony service station.

Notes on using your camera

Shooting procedure

- This camera has two modes for shooting: the Live View mode using the LCD monitor, and the viewfinder mode using the viewfinder (OVF).
- There may be differences between an image recorded in Live View mode and an image recorded in viewfinder mode, such as exposure, white balance, or D-range optimizer, depending on the method used of metering or the exposure mode.
- In Live View or focus check Live View mode, the recorded image may be different from the image you monitored with the LCD monitor.

Notes on the functions available with the camera

- To check whether it is a 1080 60i-compatible device or 1080 50i-compatible device, check for the following marks on the bottom of the camera.
1080 60i-compatible device:60i
1080 50i-compatible device:50i
- You may feel uncomfortable symptoms such as eyestrain, nausea, or a tired feeling while watching 3D-images recorded with the camera on 3D-compatible monitors. When you watch 3D-images, we recommend that you take a break at regular time intervals. Since the need for or frequency of break times varies between individuals, please set your own standards. If you feel sick, stop watching 3D-images, and consult a doctor as needed. Also, refer to the operating instructions of the connected device or the software used with the camera. A child's vision is always vulnerable (especially for children under six years of age). Before allowing them to watch 3D-images, please consult with an expert, such as a pediatric or ophthalmic doctor. Be sure to make sure your children follow the precautions above.

No compensation for contents of the recording

The contents of the recording cannot be compensated for if recording or playback is not possible due to a malfunction of your camera or a memory card, etc.

Back up recommendation

To avoid the potential risk of data loss, always copy (back up) data to other medium.

Notes on the LCD monitor and lens

- The LCD monitor is manufactured using extremely high-precision technology so over 99.99% of the pixels are operational for effective use. However, there may be some tiny black points and/or bright points (white, red, blue or green in color) that constantly appear on the LCD monitor. These points are normal in the manufacturing process and do not affect the images in any way.
To deal with such issues that may appear in Live View mode, you may reduce the effect by using the "Pixel mapping" function (page 182).

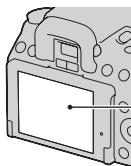

Black, white, red, blue and green points

- Do not hold the camera by taking hold of the LCD monitor.
- Do not expose the camera to sunlight or shoot upward for a long time. The internal mechanism may be damaged. If sunlight is focused on a nearby object, it may cause a fire.

- Images may trail across on the LCD monitor in a cold location. This is not a malfunction. When turning on the camera in a cold location, the LCD monitor may become temporarily dark. When the camera warms up, the monitor will function normally.
- Do not press against the LCD monitor. The monitor may be discolored and that may cause a malfunction.

Notes on long-time recording

- When you continue to shoot for a long time, the temperature of the camera rises. If the temperature reaches above a certain level, the [] mark is indicated on the screen and the camera is turned off automatically. If the power is turned off, leave the camera for 10 minutes or longer to allow the temperature inside the camera to decrease to a safe level.
- Under high ambient temperatures, the temperature of the camera rises quickly.
- When the temperature of the camera rises, the image quality may deteriorate. It is recommended that you wait until the temperature of the camera drops before continuing to shoot.
- The surface of the camera may get hot. This is not a malfunction.

Notes when playing movies on other devices

- This camera uses MPEG-4 AVC/H.264 High Profile for AVCHD format recording. Movies recorded in AVCHD format with this camera cannot be played with the following devices.
 - Other devices compatible with AVCHD format that does not support High Profile
 - Devices incompatible with the AVCHD format
 This camera also uses MPEG-4 AVC/H.264 Main Profile for MP4 format recording. For this reason, movies recorded in MP4 format with this camera cannot be played on devices other than those that support MPEG-4 AVC/H.264.
- Discs recorded with HD image quality (high definition) can be played back only on AVCHD format-compatible devices. DVD-based players or recorders cannot

play back HD image quality discs, as they are incompatible with the AVCHD format. Also, DVD-based players or recorders may fail to eject HD image quality discs.

Warning on copyright

Television programs, films, videotapes, and other materials may be copyrighted. Unauthorized recording of such materials may be contrary to the provisions of the copyright laws.



The pictures used in this manual

The photographs used as examples of pictures in this manual are reproduced images, and are not actual images shot using this camera.

On the data specifications described in this Instruction Manual

The data on performance and specifications is defined under the following conditions, except as described in this Instruction Manual: at an ordinary ambient temperature of 25°C (77°F), and using a battery pack that is charged for about an hour after the CHARGE lamp goes out.

Table of Contents

	Notes on using your camera	7
Preparing the camera	Checking the accessories supplied	13
	Identifying parts	14
	Preparing the battery pack	18
	Attaching a lens	25
	Inserting a memory card	27
	Preparing the camera	31
	Using the accessories supplied	33
	Checking the number of recordable images	35
	Cleaning	37
Before your operation	Switching between the LCD monitor and viewfinder (OVF)	40
	Adjusting the focus of the finder (diopter adjustment)	40
	The status of the screen in Live View mode	42
	Switching the status of the LCD monitor	42
	Recording information display	43
	The status of the screen in viewfinder (OVF) mode	45
	Switching the status of the LCD monitor	45
	Recording information display on the LCD monitor	46
	Viewfinder	48
	Selecting a function/setting	49
	Selecting a function with the Fn (Function) button ...	50
	The functions selected by the Fn (Function) button ...	51
	The functions selected by the MENU button	52
Shooting images	Shooting an image without camera shake	58
	Correct posture	58
	Using the SteadyShot function	59
	Using a tripod	60
	AUTO /  Shooting with the automatic setting	61
	Shooting with a suitable setting for the subject	63
	SCN Shooting with preset settings according to the scene (Scene Selection)	63
	 Shooting panoramic images (Sweep Panorama)	66

☐ Shooting 3D-panoramic images (3D Sweep Panorama)	69
Shooting an image the way you want it (Exposure mode)	70
P Shooting with program auto	71
A Shooting by controlling the blur of the background (Aperture priority)	72
S Shooting a moving subject with various expressions (Shutter speed priority)	75
M Shooting with the exposure adjusted manually (Manual exposure)	77
M Shooting trails with long exposure (BULB)	79
Recording movies	81
Available recording time for a movie	83
Notes on continuous movie recording	84
<hr/>	
Using the shooting function	
Selecting the focus method	85
Using autofocus	85
Shooting with your desired composition (Focus-lock)	87
Selecting the focus method to suit the movement of the subject (Autofocus Mode)	88
Selecting the focus area (AF area)	89
Adjusting the focus manually (Manual focus)	90
Composing your shot using the image sensor (Focus check Live View)	91
Checking the focus by enlarging the image	93
Detecting faces	95
Using the Face Detection function	95
Capturing smiling faces (Smile Shutter)	96
Using the flash	98
Performing wireless flash shooting	101
Adjusting the brightness of the image (Exposure, Flash compensation, Metering)	102
Shooting with fixed brightness (AE Lock)	102
Using brightness compensation for the entire image (Exposure compensation)	103
Adjusting the amount of flash light (Flash Compensation)	105

	Selecting the flash control mode to set the amount of flash light (Flash control)	106
	Selecting the method for measuring the brightness of a subject (Metering Mode)	107
	Setting ISO	108
	Compensating for the brightness and contrast automatically (D-Range)	109
	Correcting the brightness of the image (D-Range Optimizer)	109
	Compensating automatically with rich gradation (Auto High Dynamic Range)	110
	Image processing	112
	Selecting your desired image processing (Creative Style)	112
	Changing the range of color reproduction (Color Space)	113
	Adjusting the color tones (White balance)	114
	Adjusting the white balance to suit a specific light source (Auto/Preset white balance)	114
	Setting the color temperature and a filter effect (Color Temperature/Color Filter)	115
	Registering the color tones (Custom white balance)	116
	☺/☐ Selecting the drive mode	118
	Shooting single shot	118
	Shooting continuously	118
	Using the self-timer	119
	Shooting images with the exposure shifted (Exposure bracket)	120
	Shooting with white balance shifted (WB bracket)	122
	Shooting with the Wireless Remote Commander	122
Using the viewing function	Playing back images	123
	Checking the information of recorded images	129
	Protecting images (Protect)	133
	Deleting images (Delete)	134
	Viewing images on a TV screen	136

Changing your setup	Setting image size and image quality	140
	Setting the method for recording on a memory card	144
	Changing the noise reduction setting	148
	Changing the function of the buttons	149
	Changing other settings	150
	Setting the LCD monitor	152
	Confirming the version of the camera	154
	Resetting to the default	155
Viewing images on a computer	Using with your computer	158
	Using the software	160
	Connecting the camera to the computer	164
	Creating a movie disc	167
Printing images	Specifying DPOF	171
Others	Specifications	173
	Troubleshooting	178
	Warning messages	187
	Precautions	190
	AVCHD format	193
	3D-shootings	194
Index		195

Checking the accessories supplied

The number in parentheses indicates the number of pieces.

- BC-VM10 Battery charger (1)/
Power cord (mains lead) (1)
- Instruction Manual (This manual)
(1)



- Rechargeable battery pack NP-FM500H (1)



- USB cable (1)



- Shoulder strap (1)

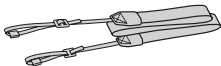

- Eyepiece cover (1)



- Body cap (1) (Attached on the camera)



- Eyecup (1) (Attached on the camera)
- CD-ROM (Application Software for α camera) (1)

Identifying parts

See the pages in parentheses for details of operation.

Front side

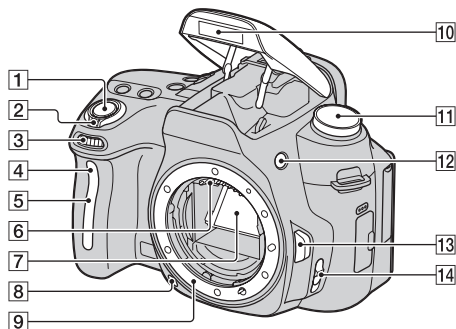

1 Shutter button (61)

2 Power switch (31)

3 Control dial (73)

4 Self-timer lamp (119)

5 Remote sensor

6 Lens contacts*

7 Mirror*

8 Preview button (74)

9 Mount

10 Built-in flash* (98)

11 Mode dial (61 – 80)

12 ⚡ (Flash pop-up) button (98)

13 Lens release button (26)

14 Focus mode switch (85, 90)

* **Do not directly touch these parts.**

Rear side

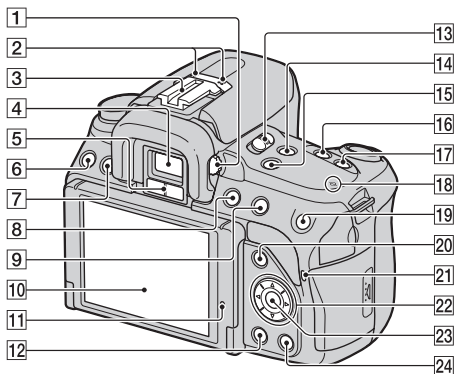

1 Diopter-adjustment dial (40)

2 Microphone**

3 Auto-lock Accessory shoe (101)



4 Viewfinder* (40)

5 Eyepiece sensors (41)

6 MENU button (52)

7 DISP (Display) button (42, 45, 123)

8 MOVIE button (81)

9 For shooting:  (Exposure button (103))
For viewing:  (Zoom out button (126))/ (Image index button (127))

10 LCD monitor (42, 123, 129)

- You can adjust the angle of the LCD monitor to meet various shooting situations.

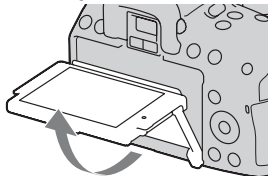



11 Light sensor (152)





12  (Playback) button (123)

13 LIVE VIEW/OVF switch (40)

14 FOCUS CHECK LV (Live View) button (91, 93)

15 D-RANGE (Dynamic range) button (109)

16  /  (Drive) button (118)

- 17 ISO button (108)
- 18  Image sensor position mark (87)
- 19 For shooting: AEL (AE lock) button (78, 102)/Focus Magnifier button (93, 149)
For viewing:  (Zoom in) button (126)
- 20 For shooting: Fn (Function) button (50, 51)
For viewing:  (Image rotation) button (125)
- 21 Access lamp (28)
- 22 Controller () button (49)
- 23 Controller (Enter) (49)/AF button (89)
- 24  (Delete) button (134)

* **Do not directly touch these parts.**

** **Do not cover this part during movie recording.**

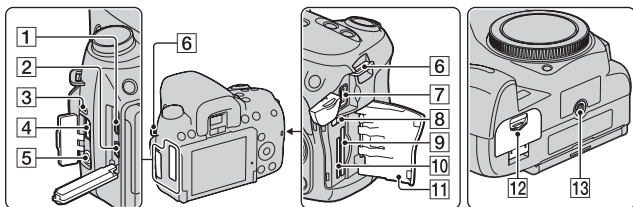

- 1** HDMI terminal (136)
- 2**  (USB) terminal (164)
- 3** Speaker
- 4** REMOTE terminal
- When connecting the RM-S1AM/RM-L1AM Remote Commander (sold separately) to the camera, insert the plug of the Remote Commander into the REMOTE terminal, aligning the guide of the plug with the guide of the REMOTE terminal. Make sure that the cord of the Remote Commander faces forward.
- 5** MIC (PLUG IN POWER) jack
- When an external microphone is connected, the internal microphone is turned off automatically. When the external microphone is a plug-in-power type, the power of the microphone is supplied by the camera.
- 6** Hooks for shoulder strap (33)
- 7** DC IN terminal
- When connecting the AC-PW10AM AC Adaptor (sold separately) to the camera, turn the camera off, then plug the connector of the AC Adaptor to the DC IN terminal on the camera.
- 8** Memory card switch
- 9** SD memory card insertion slot (27)
- 10** “Memory Stick PRO Duo” media insertion slot (27)
- 11** Memory card cover
- 12** Battery cover (22)
- 13** Tripod receptacle
- Use a tripod with a screw length of less than 5.5 mm (7/32 inch). You will be unable to firmly secure the camera to tripods having screws longer than 5.5 mm (7/32 inch), and may damage the camera.

Preparing the battery pack

When using the camera for the first time, be sure to charge the NP-FM500H “InfoLITHIUM” battery pack (supplied).

Charging the battery pack

The “InfoLITHIUM” battery pack can be charged even when it has not been fully depleted.

It can also be used when it has not been fully charged.

1 Insert the battery pack on the battery charger.

Push the battery pack until it clicks.

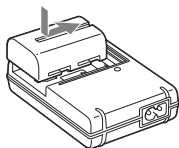

2 Connect the power cord (mains lead).

Light on: Charging

Light off: Charge completed

- The CHARGE lamp turns off when charging is finished.
- Time required to charge a fully depleted battery pack at a temperature of 25°C (77°F) is about 175 minutes.

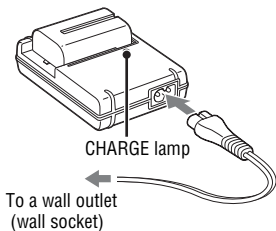

Notes

- The charging time differs depending on the remaining capacity of the battery pack or charging conditions.
- We recommend charging the battery pack in an ambient temperature of between 10°C to 30°C (50°F to 86°F). You may not be able to efficiently charge the battery pack outside of this temperature range.
- Connect the battery charger to the nearest wall outlet (wall socket).
- Do not try to charge the battery pack again right after it has been charged, or when it has not been used after being charged. Doing so will affect the performance of the battery pack.

- Do not charge any battery pack other than the “InfoLITHIUM” M series battery pack in the battery charger (supplied) with your camera. Batteries other than the specified kind may leak, overheat, or explode if you attempt to charge them, posing a risk of injury from electrocution and burns.
- When the CHARGE lamp flashes, this may indicate a battery error or that a battery pack other than the specified type has been installed. Check that the battery pack is the specified type. If the battery pack is the specified type, remove the battery pack, replace it with new one or another one and check if the battery charger operates correctly. If the battery charger operates correctly, a battery error may have occurred.
- If the battery charger is dirty, charging may not be performed successfully. Clean the battery charger with dry cloth, etc.

To use your camera abroad — Power sources

You can use your camera and the battery charger and the AC-PW10AM AC Adaptor (sold separately) in any country or region where the power supply is within 100 V to 240 V AC, 50/60 Hz.

Note

- Do not use an electronic transformer (travel converter), as this may cause a malfunction.

Representative plug of power supply cord of countries/regions around the world.



A Type
(American
Type)



B Type
(British
Type)



BF Type
(British
Type)



B3 Type
(British
Type)



C Type
(CEE
Type)



SE Type
(CEE
Type)



O Type
(Ocean
Type)

The representative supply voltage and plug type are described in this chart.

Depend on an area, Different type of plug and supply voltage are used.

Attention: Power cord meeting demands from each country shall be used.

-For only the United States

Use a UL Listed, 1.5-3 m (5-10 ft.), Type SPT-2 or NISPT-2, AWG no. 18 power supply cord, rated for 125 V 7 A, with a non-polarized NEMA 1-15P plug rated for 125 V 15 A.”

Europe

Countries/regions	Voltage	Frequency (Hz)	Plug type
Austria	230	50	C
Belgium	230	50	C
Czech	220	50	C
Denmark	230	50	C
Finland	230	50	C
France	230	50	C
Germany	230	50	C
Greece	220	50	C
Hungary	220	50	C
Iceland	230	50	C
Ireland	230	50	C/BF
Italy	220	50	C
Luxemburg	230	50	C
Netherlands	230	50	C
Norway	230	50	C
Poland	220	50	C
Portugal	230	50	C
Romania	220	50	C
Russia	220	50	C
Slovak	220	50	C
Spain	127/230	50	C
Sweden	230	50	C
Switzerland	230	50	C
UK	240	50	BF

Asia

Countries/regions	Voltage	Frequency (Hz)	Plug type
China	220	50	A
Hong Kong	200/220	50	BF
India	230/240	50	C
Indonesia	127/230	50	C
Japan	100	50/60	A
Korea (rep)	220	60	C
Malaysia	240	50	BF
Philippines	220/230	60	A/C

Singapore	230	50	BF
Taiwan	110	60	A
Thailand	220	50	C/BF
Vietnam	220	50	A/C

Oceania

Countries/regions	Voltage	Frequency (Hz)	Plug type
Australia	240	50	O
New Zealand	230/240	50	O

North America

Countries/regions	Voltage	Frequency (Hz)	Plug type
Canada	120	60	A
USA	120	60	A

Central America

Countries/regions	Voltage	Frequency (Hz)	Plug type
Bahamas	120/240	60	A
Costa Rica	110	60	A
Cuba	110/220	60	A/C
Dominican (rep)	110	60	A
El Salvador	110	60	A
Guatemala	120	60	A
Honduras	110	60	A
Jamaica	110	50	A
Mexico	120/127	60	A
Nicaragua	120/240	60	A
Panama	110/220	60	A

South America

Countries/regions	Voltage	Frequency (Hz)	Plug type
Argentina	220	50	C/BF/O
Brazil	127/220	60	A/C
Chile	220	50	C
Colombia	120	60	A
Peru	220	60	A/C
Venezuela	120	60	A

Middle East

Countries/regions	Voltage	Frequency (Hz)	Plug type
Iran	220	50	C/BF
Iraq	220	50	C/BF
Israel	230	50	C
Saudi Arabia	127/220	50	A/C/BF
Turkey	220	50	C
UAE	240	50	C/BF

Africa

Countries/regions	Voltage	Frequency (Hz)	Plug type
Algeria	127/220	50	C
Congo (dem)	220	50	C
Egypt	220	50	C
Ethiopia	220	50	C
Kenya	240	50	C/BF
Nigeria	230	50	C/BF
South Africa	220/230	50	C/BF
Tanzania	230	50	C/BF
Tunisia	220	50	C

Inserting the charged battery pack

- 1** While sliding the battery cover open lever, open the battery cover.

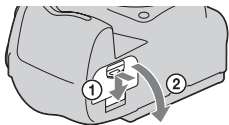

- 2** Firmly insert the battery pack all the way while pressing the lock lever with the tip of the battery.

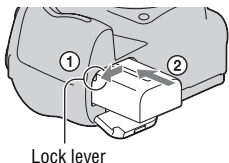

- 3** Close the battery cover.

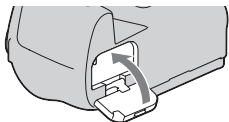

To remove the battery pack

Turn off the camera and slide the lock lever in the direction of the arrow. Be careful not to drop the battery pack.

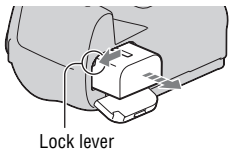

To remove the battery cover

The battery cover can be removed to attach the VG-B50AM Vertical Grip (sold separately).

To remove the cover, push the lever in the direction of the arrow and slide it out. To attach the cover, put the knob in the hole, pull down the lever, and slide it in.

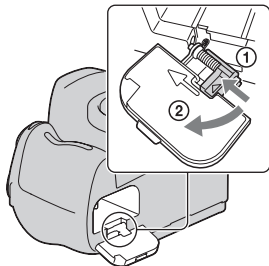

To check the remaining battery level

Check the level with the following indicators and percent figures displayed on the LCD monitor.

Battery level						“Battery exhausted.”
	High Low					You cannot shoot any more pictures.

What is an “InfoLITHIUM” battery pack?

An “InfoLITHIUM” battery pack is a lithium-ion battery pack that has functions for exchanging information related to operating conditions with your camera. Using the “InfoLITHIUM” battery pack, the remaining battery time in percent figures is displayed according to the operating conditions of your camera.

Notes

- The displayed level may not be correct under certain circumstances.
- Do not expose the battery pack to water. The battery pack is not water-resistant.
- Do not leave the battery pack in extremely hot places, such as in a car or under direct sunlight.

Available battery packs

Use only an NP-FM500H battery pack. Note that the NP-FM55H, NP-FM50 and NP-FM30 cannot be used.

Effective use of the battery pack

- Battery performance decreases in low temperature surroundings. So, the time that the battery pack can be used is shorter in cold places and the speed of continuous shooting slows down. We recommend that you put the battery pack in a pocket close to your body to warm it up, and insert it in your camera immediately before you start shooting.
- The battery pack will run out quickly if you use the flash frequently, use continuous shooting often, or turn the camera on and off frequently.
- The time available in the Live View mode is shorter than that in the viewfinder mode. When you feel that the battery consumption is too fast, switch to the viewfinder mode. Doing so makes the battery last longer.

Battery life

- The battery life is limited. Battery capacity decreases little by little as you use it more and more, and as time passes. If the battery operating time seems shortened considerably, a probable cause is that the battery pack has reached the end of its life. Buy a new battery pack.
- The battery life varies according to how it is stored and the operating conditions and environment in which each battery pack is used.

How to store the battery pack

If the battery pack is not to be used for a long time, fully charge it and then fully use it up once a year on your camera before storing the battery pack in a dry, cool place to prolong the battery life.

Attaching a lens

1 Remove the body cap from the camera and the packaging lid from the rear of the lens.

- When changing the lens, quickly change the lens away from dusty locations so as to keep dust or debris from getting inside the camera.

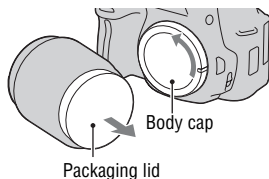

2 Mount the lens by aligning the orange index marks on the lens and camera.

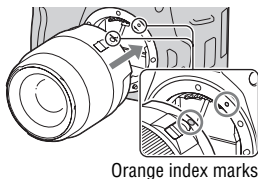

3 Turn the lens clockwise until it clicks into the locked position.

- Be sure to put the lens on straight.

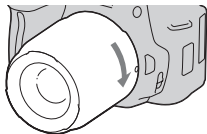

Notes

- When attaching a lens, do not press the lens release button.
- Do not use force when attaching a lens.
- Use an A-mount lens. E-mount lenses are not compatible with this camera.

To remove the lens

- 1 Press the lens release button all the way in and turn the lens counterclockwise until it stops.**

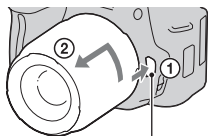

Lens release button

- 2 Replace the packaging lid on the lens and attach the body cap to the camera.**

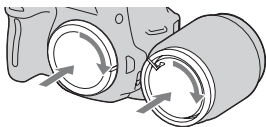

- Before you attach them, remove dust from them.
 - A rear lens cap is not supplied with the DT 18-55mm F3.5-5.6 SAM Lens Kit. When you store the lens without attaching it to the camera, purchase the Rear Lens Cap ALC-R55.
-

Note on changing the lens

When changing the lens, if dust or debris gets inside the camera and lands on the surface of the image sensor (the part that acts as the film), it may appear on the image, depending on the shooting environment.

The camera is equipped with an anti-dust function to prevent dust from landing on the image sensor. However, quickly change the lens away from dusty locations when attaching/removing a lens.

If dust or debris lands on the image sensor

Clean the image sensor using [Cleaning Mode] in the  Setup menu (page 38).

Inserting a memory card

1 Open the memory card cover.

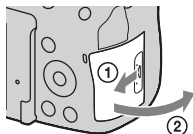

2 Insert “Memory Stick PRO Duo” media or an SD memory card.

- Insert the memory card until it clicks as illustrated.

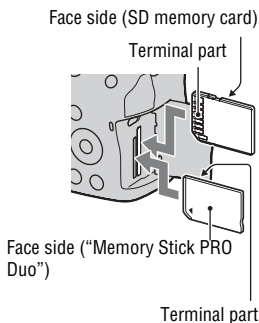

3 Select the type of memory card you want to use using the memory card switch.

- If you switch the memory card while the power is turned on, the LCD monitor is turned off for a few seconds. This is not a malfunction.

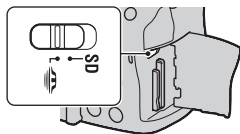

4 Close the memory card cover.

Available memory cards

- Only “Memory Stick PRO Duo” media, “Memory Stick PRO-HG Duo” media, SD memory cards, SDHC memory cards and SDXC memory cards can be used with this camera. A MultiMediaCard cannot be used with this camera. However, proper operation cannot be guaranteed for all memory cards functions.
- The “Memory Stick PRO Duo” media and “Memory Stick PRO-HG Duo” media are referred to as the “Memory Stick PRO Duo” media and the SD memory card, SDHC memory card and SDXC memory card are referred to as the “SD card” in this Instruction Manual.
- For recording movies, it is recommended that you use following memory cards.
 - MEMORY STICK PRO DUO (Mark2) (“Memory Stick PRO Duo” media (Mark2))
 - MEMORY STICK PRO-HG DUO (“Memory Stick PRO-HG Duo” media)
 - SD memory card, SDHC memory card, SDXC memory card (Class 4 or more)
- Images recorded on an SDXC memory card cannot be imported to or played on computers or AV devices that are not compatible with exFAT. Make sure that the device is compatible with exFAT before connecting it to the camera. If you connect your camera to an incompatible device, you may be prompted to format the card. Never format the card in response to this prompt, as doing so will erase all data on the card. (exFAT is the file system used on SDXC memory cards.)

To remove the memory card

Check that the access lamp is not lit, then open the memory card cover, and push the memory card once.

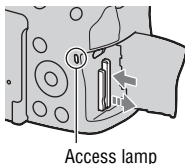



Notes on using memory cards

- Do not strike, bend or drop the memory card.
- Do not use or store the memory card under the following conditions:
 - High temperature locations such as the hot interior of a car parked in direct sunlight.
 - Locations exposed to direct sunlight.
 - Humid locations or locations with corrosive substances present.
- The memory card may be hot just after it has been used for a long time. Be careful when you handle it.
- When the access lamp is lit, do not remove the memory card or the battery pack, or turn off the power. The data may be corrupted.
- Data may be damaged if you place the memory card near strongly-magnetized material or use the memory card in a static-prone or electrically noisy environment.
- We recommend backing up important data, such as to a hard disk of a computer.
- When you carry or store the memory card, put it in the case supplied with it.
- Do not expose the memory card to water.
- Do not touch the terminal section of the memory card with your hand or a metal object.
- When the write-protect switch of a memory card is set to the LOCK position, you cannot perform operations, such as recording or deleting images.
- The memory cards formatted with a computer are not guaranteed to operate with this camera. Be sure to format the memory cards using the camera.
- Data read/write speeds differ depending on the combination of the memory cards and the equipment used.
- Do not press down hard when you write down on the memo area.
- Do not attach a label on the memory cards themselves.
- Do not disassemble or modify the memory cards.
- Do not leave the memory cards within the reach of small children. They might accidentally swallow it.

Notes on the “Memory Stick” media used with the camera

The types of “Memory Stick” media that can be used with this camera are listed in the table below. However, proper operation cannot be guaranteed for all “Memory Stick PRO Duo” media functions.

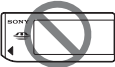
“Memory Stick PRO Duo” media *1*2*3	Available with your camera	
“Memory Stick PRO-HG Duo” media *1*2		
“Memory Stick Duo” media	Unavailable with your camera	
“Memory Stick” media and “Memory Stick PRO” media	Unavailable with your camera	

*1 This is equipped with MagicGate function. MagicGate is copyright protection technology that uses encryption technology. Data recording/playback that requires MagicGate functions cannot be performed with this camera.

*2 Supports high-speed data transfer using a parallel interface.

*3 When using “Memory Stick PRO Duo” media to record movies, only those marked with Mark2 can be used.

Notes on using “Memory Stick Micro” media (sold separately)

- This product is compatible with “Memory Stick Micro” media (“M2”). “M2” is an abbreviation for “Memory Stick Micro” media.
- To use a “Memory Stick Micro” media with the camera, be sure to insert the “Memory Stick Micro” media into an “M2” Adaptor as large as of Duo size. If you insert a “Memory Stick Micro” media into the camera without an “M2” Adaptor as large as of Duo size, you might not be able to remove it from the camera.
- Do not leave the “Memory Stick Micro” media within the reach of small children. They might accidentally swallow it.

Preparing the camera

Setting up the date

When you turn the camera on for the first time, the date/time setup screen appears.

1 Set the power switch to ON to turn the camera on.

The screen used for setting date and time appears.

- To turn the camera off, set it to OFF.

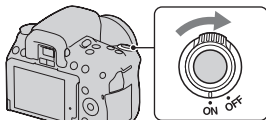

2 Verify that [Enter] is selected on the LCD monitor, then press the center of the controller.

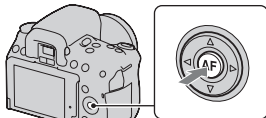

3 Select your area with ◀/▶ on the controller, then press the center of the controller.

4 Select each item with ◀/▶ and set the numeric value with ▲/▼.

[Daylight Svg.]: Turns on or off the daylight saving time setting.

[Date Format]: Selects the format to display date.

- Midnight is indicated as 12:00 AM, and noon as 12:00 PM.

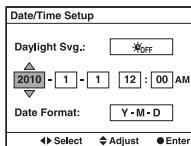
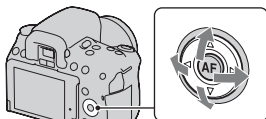

5 Repeat step 4 to set other items, then press the center of the controller.

6 Verify that [Enter] is selected, then press the center of the controller.

To cancel the date/time setting operation

Press the MENU button.

To set up the date/time again

When you turn the camera on for the first time, the date/time setup screen appears automatically. The next time, set up the date and time from the menu.

MENU button →  1 → [Date/Time Setup]

To set up the area again

You can set the area where you are using the camera. This allows you to set the local area when you use the camera abroad.

MENU button →  1 → [Area Setting]

Maintaining the date and time setting

This camera has an internal rechargeable battery for maintaining the date and time and other settings regardless of whether the power is on or off, or the battery is installed or not. For details, see page 190.

Using the accessories supplied

This section describes how to use the shoulder strap, the eyepiece cover, and eyecup. The other accessories are described in the following pages.

- Rechargeable battery pack (page 18)
- Battery charger, Power cord (mains lead) (page 18)
- USB cable (page 164)
- CD-ROM (page 160)

Attaching the shoulder strap

Attach both ends of the strap onto the camera.

- You can also attach the eyepiece cover (page 34) on the strap.

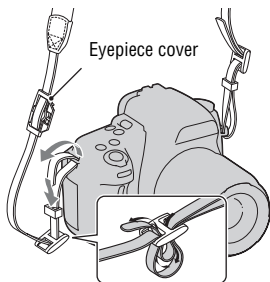

Using the eyepiece cover and eyecup

You can prevent light from entering through the viewfinder and affecting the exposure. When the shutter is released without the use of the viewfinder in viewfinder mode, as in shooting with the self-timer, attach the eyepiece cover.

1 Tilt the LCD monitor downward.

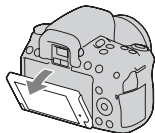

2 Carefully slide the eyecup off by pushing on each side of the eyecup.

- Put your fingers under the eyecup, and slide it upward.
- When attaching the FDA-MIAM Magnifier (sold separately), the FDA-AIAM Angle Finder (sold separately), or the FDA-MEIAM Magnifying Eyepiece (sold separately) to the camera, remove the eyecup as illustrated and attach them.

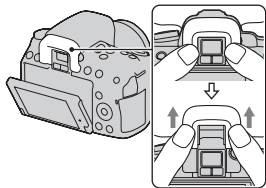

3 Slide the eyepiece cover over the viewfinder.

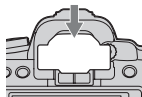

Note

- The eyepiece sensors located below the viewfinder may be activated depending on the situation, and the focus may be adjusted or the LCD monitor may continue to flash. In such cases, turn off both [Eye-Start AF] (page 41) and [Auto off w/ VF] (page 153).

Checking the number of recordable images

Once you insert a memory card into the camera and set the power switch to ON, the number of images that can be recorded (should you continue to shoot using the current settings) is displayed on the LCD monitor.

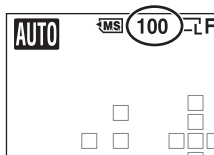

Notes

- When “0” (the number of recordable images) flashes in yellow, the memory card is full. Replace the memory card with another one, or delete images in the current memory card (page 134).
- When “NO CARD” (the number of recordable images) flashes in yellow, it means no memory card has been inserted. Insert a memory card.

The number of images that can be recorded on a memory card

The table shows the approximate number of images that can be recorded on a memory card formatted with this camera. The values are defined using Sony standard “Memory Stick PRO Duo” media for testing. The values may vary depending on the shooting conditions and the type of memory card used.

Image: Size: L 16M (DSLR-A580)/L 14M (DSLR-A560)

Image: Aspect Ratio: 3:2*

DSLR-A580

(Units: Images)

Capacity \ Size	2GB	4GB	8GB	16GB	32GB
Standard	386	781	1587	3239	6406
Fine	270	548	1116	2279	4510
RAW & JPEG	74	154	319	657	1304
RAW	106	220	452	928	1840

Size \ Capacity	2GB	4GB	8GB	16GB	32GB
Standard	433	875	1778	3626	7172
Fine	305	618	1258	2569	5083
RAW & JPEG	84	176	362	745	1478
RAW	122	251	514	1054	2089

* When [Image: Aspect Ratio] is set to [16:9], you can record more images than the numbers shown in the table above (except when [RAW] is selected).

The number of images that can be recorded using a battery pack

The approximate number of images that can be recorded is as follows when you use the camera with the battery pack (supplied) at full capacity.

Note that the actual numbers may be less than those indicated depending on the conditions of use.

	DSLR-A580	DSLR-A560
Live View mode	Approx. 560 images	Approx. 560 images
Viewfinder mode	Approx. 1050 images	Approx. 1050 images

- The number is calculated with a battery pack at full capacity and in the following situation:
 - At an ambient temperature of 25°C (77°F).
 - Using the battery pack that is charged for an hour after the CHARGE lamp goes out.
 - Using Sony “Memory Stick PRO Duo” media (sold separately).
 - [Image: Quality] is set to [Fine].
 - [Autofocus Mode] is set to [Automatic AF].
 - Shooting once every 30 seconds.
 - The flash strobes once every two times.
 - The power turns on and off once every ten times.
- The measurement method is based on the CIPA standard.
(CIPA: Camera & Imaging Products Association)

Cleaning

Cleaning the camera

- Do not touch the inside of the camera, such as lens contacts, or the mirror. Since dust on the mirror or around the mirror may affect the images or the performance of the camera, blow the dust away using a commercially available blower*. For details on cleaning the image sensor, see the next page.

* Do not use a spray blower. Using one may cause a malfunction.

- Clean the camera surface with a soft cloth slightly moistened with water, then wipe the surface with a dry cloth. Do not use the following as they may damage the finish or the casing.
 - Chemical products such as thinner, benzene, alcohol, disposable cloths, insect repellent, sunscreen or insecticide, etc.
 - Do not touch the camera with the above on your hand.
 - Do not leave the camera in contact with rubber or vinyl for a long time.

Cleaning the lens

- Do not use a cleaning solution containing organic solvents, such as thinner, or benzene.
- When cleaning the lens surface, remove dust using a commercially available blower. In case of dust that sticks to the surface, wipe it off with a soft cloth or tissue paper slightly moistened with lens cleaning solution. Wipe in a spiral pattern from the center to the outside. Do not spray lens cleaning solution directly onto the lens surface.

Cleaning the image sensor

If dust or debris enters the camera and lands on the image sensor (the part that acts as the film), it may appear on the photo image, depending on the shooting environment. If there is dust on the image sensor, use a commercially available blower and clean the image sensor following the steps below. You can easily clean the image sensor using only the blower and the anti-dust function.

Notes

- Cleaning can be performed only when the battery level is 50% or more.
- Low battery power during cleaning can cause damage to the shutter. The cleaning should be completed quickly. The use of an AC-PW10AM AC Adaptor (sold separately) is recommended.
- Do not use a spray blower because it may scatter water droplets inside the camera body.

1 Confirm that the battery is fully charged (page 23).

2 Press the MENU button, then select 2 with / on the controller.

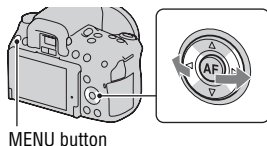

3 Select [Cleaning Mode] with / , then press the center of the controller.

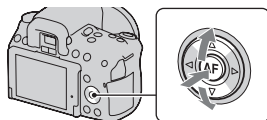

4 Select [Enter] with , and press the center of the controller.

After the image sensor vibrates for a short time, the mirror in front is lifted.

5 Detach the lens (page 26).

6 Use the blower to clean the image sensor surface and the surrounding area.

- Do not touch the image sensor with the tip of the blower. Complete the cleaning quickly.
- Hold the camera's face downward to prevent the dust from resettling in the camera.
- When cleaning the image sensor, do not put the tip of a blower into the cavity beyond the mount.

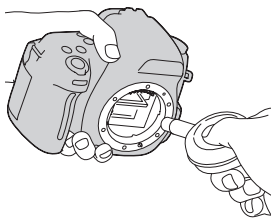

7 Attach the lens and turn the camera off.

Note

- The camera starts beeping if the battery pack becomes low during cleaning. Stop cleaning immediately and turn the camera off.

Switching between the LCD monitor and viewfinder (OVF)

You can select either the LCD monitor (Live View) or the viewfinder (OVF) to shoot images.

LIVE VIEW: Monitors subjects using the LCD monitor.

OVF: Monitors subjects using the viewfinder. On the LCD monitor, the recording information is displayed instead.

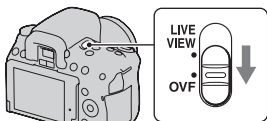

Adjusting the focus of the finder (diopter adjustment)

In viewfinder mode, adjust the diopter-adjustment dial to your eyesight until the display appears clearly in the viewfinder.

- Training the camera on a light allows you to adjust the diopter easily.
- When the indicators do not appear clearly, even if you adjust the diopter, it is recommended that you use a dioptic adjustment attachment (sold separately).

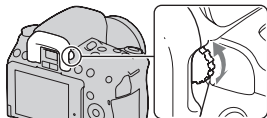

When it is hard to rotate the diopter-adjustment dial

Put your fingers under the eyecup, and slide it upward to remove the eyecup, then adjust the diopter.

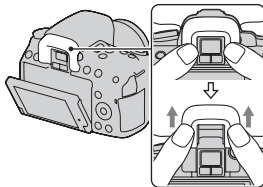

To focus on a subject quickly using the viewfinder

When you look into the viewfinder, the subject located in the AF area comes into focus automatically (Eye-Start AF).

MENU button →  1 → [Eye-Start AF] → [On]

When the FDA-A1AM Angle Finder (sold separately) is attached to the camera, setting [Eye-Start AF] to [Off] is recommended because the eyepiece sensors located below the viewfinder may be activated.

The status of the screen in Live View mode

Switching the status of the LCD monitor

In Live View mode, each time you press the DISP button, the recording information display changes as follows.

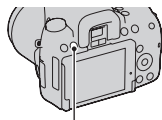

DISP button

Graphic Display

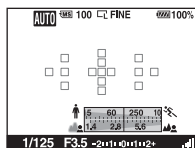

Recording information on

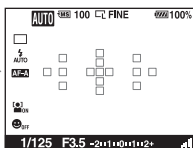

Recording information off

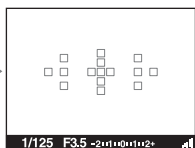

Note

- In focus check Live View mode, the digital level gauge is displayed after “recording information off” (page 91).

Recording information display

The Graphic Display graphically shows the shutter speed and aperture value and clearly illustrates how the exposure works. See pages in parentheses for details of operation.

Graphic Display

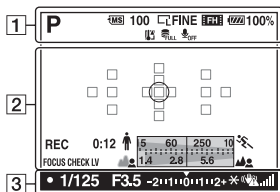

Recording information display

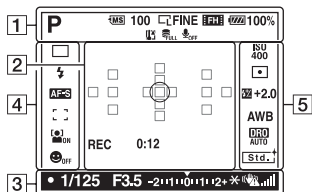

Before your operation

1

Display	Indication
	Exposure mode (61 – 80)
	Memory card (27)
100	Remaining number of recordable images (35)
	Image size of still images (140)/Aspect ratio of still images (142)/Image size of Sweep Shooting (141)
RAW RAW+J FINE STD	Image quality of still images (142)
	Image size of movies (141)



Display	Indication
	Remaining battery (23)
	Overheating warning (188)
	Database file full (188)/Database file error (188)
	No audio recording of movies (83)

2





Display	Indication
	Spot metering area (107)
	AF area (89)
	Shutter speed indicator (75)
	Aperture indicator (72)
FOCUS CHECK LV	Focus check Live View (91)

Display	Indication
REC 0:12	Recording time of the movie (m:s)







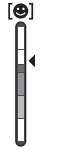

3

Display	Indication
	Focus (86)
1/125	Shutter speed (75)
F3.5	Aperture (72)
-2+1+0+1+2+	EV scale (78, 121)
*	AE lock (102)
	Camera shake warning (59)
	SteadyShot scale (59)

4

Display	Indication
	Drive mode (118)
	Flash mode (98)/Red-eye reduction (100)
AF-A AF-S AF-C MF	Focus mode (88)
	AF area (89)
	Face Detection (95)
	Smile Shutter (96)
	Smile Detection Sensitivity indicator (96)

5

Display	Indication
ISO 400 	ISO sensitivity (108)
	Metering (107)
 +2.0	Flash compensation (105)
AWB 	White balance (Auto, Preset, Custom, Color temperature, Color filter) (114)
WB  7500K G9	
D-R  OFF DRO  AUTO	D-Range Optimizer (109)/Auto HDR (110)
	Creative Style (112)

The status of the screen in viewfinder (OVF) mode

Switching the status of the LCD monitor

In viewfinder mode, press the DISP button to switch between the Graphic Display and the Standard Display. When you rotate the camera to a vertical position, the display automatically rotates to adjust to the camera position.

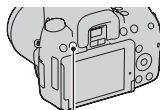

DISP button

Before your operation

Graphic Display
(Default setting)

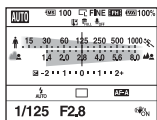

Standard Display

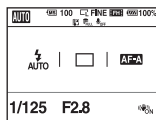

No display

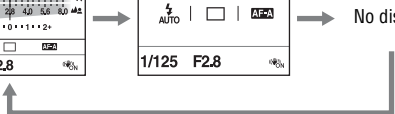

Recording information display on the LCD monitor

The Graphic Display graphically shows the shutter speed and aperture value and clearly illustrates how the exposure works. In AUTO or Scene Selection mode, only the items that can be set are displayed. See the pages in parentheses for details of operation.

Graphic Display

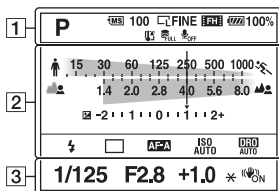

Standard Display

(In AUTO or Scene Selection mode)

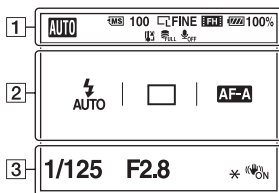

Standard Display

(In P/A/S/M mode)

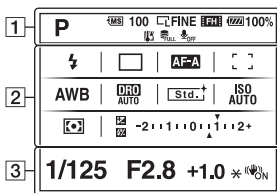

1

Display	Indication
AUTO P A S M	Exposure mode (61 – 80)
[MS] [SD]	Memory card (27)
100	Remaining number of recordable images (35)

Display	Indication
[L] [M] [S]	Image size of still images (140)/Aspect ratio of still images (142)
RAW RAW+J FINE STD	Image quality of still images (142)
[FH] [1080] [VGA]	Image size of movies (141)

Display	Indication
100%	Remaining battery (23)
	Overheating warning (188)
FULL ERROR	Database file full (188)/ Database file error (188)
OFF	No audio recording of movies (83)

2

Display	Indication
	Shutter speed indicator (75)
	Aperture indicator (72)
	Exposure compensation (103)/Metered Manual (78)
	Flash compensation (105)
	EV scale (78, 121)
	Drive mode (118)
	Flash mode (98)/Red-eye reduction (100)
	Focus mode (88)
	ISO sensitivity (108)
	D-Range Optimizer (109)/Auto HDR (110)
	AF area (89)
	White balance (Auto, Preset, Custom, Color temperature, Color filter) (114)

Display	Indication
Std.↑ Vivid↑	Creative Style (112)
Port.↑ Land.↑	
Sunset↑ B/W↑	
	Metering mode (107)

3

Display	Indication
1/125	Shutter speed (75)
F2.8	Aperture (72)
+1.0	Exposure (103)
	AE lock (102)
	SteadyShot (59)

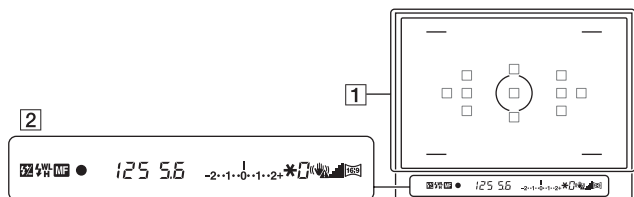

1

Display	Indication
	AF area (89)
	Spot metering area (107)
	Shooting area for aspect ratio 16:9 (142)

2

Display	Indication
	Flash compensation (105)
	Flash charging (98)
WL	Wireless flash (101)
H	High-speed sync
MF	Manual focus (90)
	Focus
125	Shutter speed (75)
5.6	Aperture (72)
	EV scale (78, 121)
	AE lock (102)
0	“Shooting unavailable” warning (118)
	Camera shake warning (59)
	SteadyShot scale (59)
	Aspect ratio 16:9 (142)

Notes

- Fine lines may be seen from an AF area in the viewfinder. This is not a malfunction.
- When you press the shutter button halfway down to focus on a dark subject, AF areas may be lit in red automatically. In such a case, a red light is reflected on the right side in the viewfinder. This is not a malfunction.

Selecting a function/setting

You can select a function for shooting or playback with the one of buttons, such as the Fn (Function) button, or the MENU button.

When you start an operation, an operation guide of controller functions will be displayed at the bottom of the screen.

◀▶: Press ▲/▼/◀/▶ on the controller to move the cursor.

●: Press the center button to execute the selection.

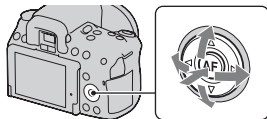

In this Instruction Manual, the process of selecting a function with the controller and the Fn button from the list displayed on the screen is described as follows (we explain the process with the default icons.):

Example: Fn button → AWB (White Balance) → Select the desired setting

The operation guide list

The operation guide also indicates operations other than the controller operation. The indications of icons are as follows.

	MENU button
	Returns with MENU button
	(Delete) button
	(Zoom in) button
	(Zoom out) button
	(Playback) button
	Control dial

Help guide

The Help Guide shows the information on a function selected with the Fn button, MENU button, mode dial, etc. You can also turn it off (page 150).

Selecting a function with the Fn (Function) button

This button is used for setting up or executing functions used frequently in shooting.

1 Press the Fn button.

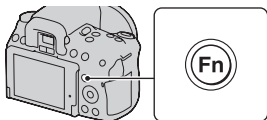

2 Select the desired item with ▲/▼/ ◀/▶ on the controller, then press the center ● to execute.

The setup screen appears.

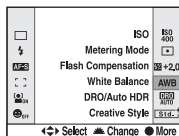

3 Following the operation guide, select and execute the desired function.

- For details on how to set up each item, see the corresponding page.

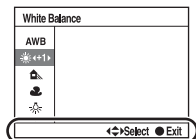

Operation guide

To set up the camera directly from the recording information screen

Turn the control dial without pressing the center ● in step 2. You can set up the camera directly from the recording information screen.

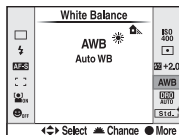

The functions selected by the Fn (Function) button

The items that will be displayed depend on the position of the mode dial.









Scene Selection (63)	Selects an appropriate mode from among the Scene Selection preset settings to suit shooting conditions.
Sweep Shooting (66, 69)	Switches between Sweep Panorama and 3D Sweep Panorama.
Drive Mode (118)	Sets the shooting mode to single-shot adv., continuous adv., self-timer, bracket shooting, etc.
Flash Mode (98)	Sets the flash mode to Autoflash, Fill-flash, Flash Off, etc.
Autofocus Mode (88)	Selects the method for focusing according to movement of the subject.
AF area (89)	Selects the area of focus.
Face Detection (95)	Automatically captures people's face(s) with the optimal focus and exposure.
Smile Shutter (96)	Camera shoots when a smile is detected.
ISO (108)	Sets the sensitivity to light. The larger the number, the faster the shutter speed.
Metering Mode (107)	Selects the method for measuring brightness.
Flash Compensation (105)	Adjusts the intensity of flash output. + direction increases brightness of subject, and the - direction increases darkness.
White Balance (114)	Adjusts the color tone of images.
DRO/Auto HDR (109)	Compensates for the brightness and contrast automatically.
Creative Style (112)	Selects your desired image processing.

The functions selected by the MENU button









You can set up the basic settings for the camera as a whole or execute functions such as shooting, playback, or other operations.

Press the MENU button, select the desired page with ◀/▶ on the controller, and select the desired item with ▲/▼.









Recording menu

	 1	2	3						
  	Image: Size (140)								Selects the size of still images.
	Image: Aspect Ratio (142)								Selects the aspect ratio for still images.
	Image: Quality (142)								Sets the images quality for still images.
	Movie: File Format (82)								Selects the movie file format.
	Movie: Size (141)								Selects the size of the recorded movie frame.
	Movie: Audio Rec. (83)								Sets whether or not to record audio when shooting a movie.
	SteadyShot (59)								Sets SteadyShot.











 1 2 3     		
  	Panorama: Size (141)	Selects the size of panoramic images.
	Panorama: Direction (68)	Sets the shooting direction for panoramic images.
	3D Pan.: Image Size (141)	Selects the size of 3D-images.
	3D Pan.: Direction (69)	Sets the shooting direction for 3D-images.
	Flash control (106)	Sets the method for determining the intensity of flash output.
	AF Illuminator (100)	Sets the AF illuminator, which sheds light on a dark scene to aid focusing.
	AF method (91)	Sets the autofocus system in focus check Live View mode.











 1 2 3     		
  	Color Space (113)	Changes the range of reproducible colors.
	Long Exposure NR (148)	Sets noise reduction processing for shots in which shutter speed will be 1 second or longer.
	High ISO NR (148)	Sets noise reduction processing for high-sensitivity shooting.



Custom menu

  1 2    		
  	Eye-Start AF (41)	Sets whether or not to use auto focus when you look through viewfinder.
	Func. of AEL button (149)	Sets the function of the AEL button between AE lock and Focus Magnifier in focus check Live View mode.
	AEL (149)	Sets the operation method of the AE lock button for fixing exposure during shooting.
	Focus Hold Button (149)	Sets the function of the focus hold button of the lens.
	Red Eye Reduction (100)	Reduces the red-eye phenomenon during flash use.
	Release w/oLens (150)	Sets whether shutter can open when lens is not attached.
	Auto off w/ VF (153)	Sets whether or not to turn off the LCD monitor when you look through the viewfinder.



  1 2    		
  	Grid Line (153)	Sets a grid line display to enable alignment to a structural outline.
	Histogram (104)	Sets whether or not to include the histogram display when switching screen display.
	Auto Review (152)	Displays the captured image after shooting. Sets auto review.



Playback menu

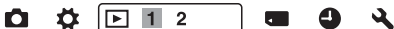

	Delete (134)	Deletes images.
	Still/Movie Select (124)	Switches between the still image playback screen and the movie playback screen.
	Slide Show (127)	Shows a slide show.
	3D Viewing (137)	Plays back 3D-images using a 3D-compatible TV connected to the camera.
	Protect (133)	Protects or cancels protection for an image.
	Specify Printing (171)	Specifies or unspecifies the images for DPOF.
	Volume Settings (124)	Sets the volume for movie playback.



	Select Folder (123)	Changes the folder for images to play back.
	Select Date (125)	Displays images from another date.
	Playback Display (123)	Sets how to play back an image recorded in portrait.



Memory Card Tool menu



	Format (145)	Formats the memory card.
	File Number (144)	Sets the method used to assign file numbers to still images and movies.
	Folder Name (144)	Sets the folder format for still images.
	Select REC Folder (145)	Changes the selected folder for storing still images.
	New Folder (145)	Creates a new folder for storing still images and movies.
	Recover Image DB (146)	Recovers the image database file for movies and enables recording and playback.
	Display Card Space (146)	Displays the remaining recording time of movies and the recordable number of still images on the memory card.













Clock setup menu











	Date/Time Setup (31)	Sets date and time, and daylight savings.
	Area Setting (32)	Sets the location of use.



Setup menu

      1 2		
 	LCD Brightness (152)	Sets the brightness of the LCD monitor.
	Power Save (LV) (150)	Sets the interval after which power save mode engages in Live View mode.
	Power Save (OVF) (150)	Sets the interval after which power save mode engages in viewfinder mode.
	 CTRL FOR HDMI (137)	Operates the camera from a TV that support "BRAVIA" Sync.
	 Language (151)	Selects the language.
	Help Guide Display (150)	Sets the display of the help guide for explaining functions displayed during operation.
	USB Connection (164)	Sets the USB connection method.



      1 2		
 	Upload Settings (146)*	Sets the upload function of the camera when using an Eye-Fi card.
	Audio signals (150)	Sets whether or not to use the beep sound when the focus is achieved or the self-timer is working.
	Cleaning Mode (38)	Starts the cleaning mode to clean the image sensor.
	 Pixel mapping (182)	Executes this function when dots appear and remain on the LCD monitor in Live View mode.
	Version (154)	Displays the camera software version.
	Demo Mode (151)	Sets the demonstration playback of a movie to on or off.
	Reset Default (155)	Restores the settings to their defaults.

* Appears when an Eye-Fi card (sold separately) is inserted in the camera.

Shooting an image without camera shake

“Camera shake” refers to unwanted movement of the camera that occurs after the shutter button has been pressed, resulting in a blurred image. To reduce camera shake, follow the instructions below.

Correct posture

Stabilize your upper body and take a position that keeps the camera from moving.

In Live View mode

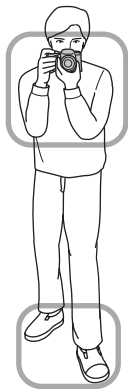

In viewfinder mode

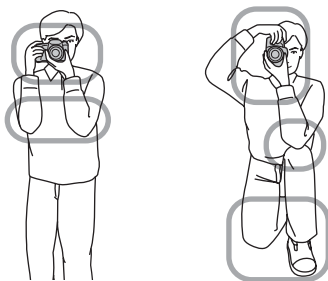

Point ①

One hand holds the grip of the camera, and the other hand supports the lens.

Point ②

Take a secure stance with your feet shoulder-width apart.

Point ③

Lightly tuck your elbows against your body.

When shooting in a kneeling position, steady your upper body by placing your elbow on your knee.

Camera shake warning indicator

Due to potential camera shake, the  (Camera shake warning) indicator flashes. In this case, use a tripod or the flash.

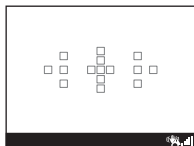

 (Camera shake warning) indicator

Note

- The  (Camera shake warning) indicator is displayed only in the modes that automatically set the shutter speed. This indicator is not displayed in M/S modes.

Using the SteadyShot function

The SteadyShot function can reduce the effect of camera shake by the equivalent of approximately 2.5 Ev to 4 Ev in shutter speed. The SteadyShot function is set to [On] in the default setting.

The SteadyShot scale indicator

The  (SteadyShot scale) indicator shows the camera shake status. Wait until the scale becomes low, then start shooting.

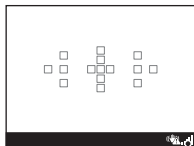

 (SteadyShot scale) indicator

To deactivate the SteadyShot function

MENU button →  **1** → [SteadyShot] → [Off]

Note

- The SteadyShot function may not work optimally when the power has just been turned on, right after you point the camera towards a subject, or when the shutter button has been pressed all the way down without stopping halfway.

Using a tripod

In the following cases, we recommend that you mount the camera on a tripod.

- Shooting without a flash under dark conditions.
- Shooting with slow shutter speeds, which are typically used in night-time shooting.
- Shooting a close subject, such as in macro shooting.
- Shooting with a telescopic lens.

Note

- When using a tripod, deactivate the SteadyShot function because there is a potential for malfunction of the SteadyShot function.

AUTO / Shooting with the automatic setting

The “AUTO” mode allows you to easily shoot any subject under any conditions because the camera makes appropriate judgments on the situation to adjust the settings.

Select  when shooting in a location where the use of a flash is restricted.

- 1** Set the mode dial to **AUTO** or  (Flash Off).

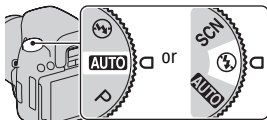

- 2** Adjust the LCD monitor to an easily viewable angle and hold the camera.

- 3** Overlay the AF area on the desired subject.

- If the  (Camera shake warning) indicator flashes, carefully shoot the subject, holding the camera steady, or by using a tripod.

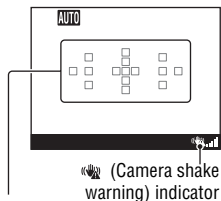

- 4** When using a zoom lens, turn the zoom ring, then decide on your shot.

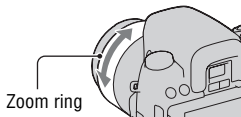

5 Press the shutter button halfway down to focus.

When the focus is confirmed, ● or (Focus indicator) lights up (page 86).

- Waiting until the (SteadyShot scale) indicator is low makes the SteadyShot function more effective.

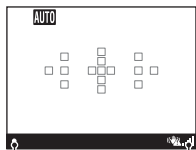
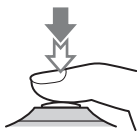

Focus indicator

(SteadyShot scale) indicator

6 Press the shutter button fully down to shoot.

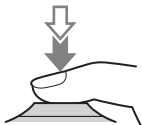

Note

- Since the camera turns on the automatic setting function, many features will be unavailable, such as exposure compensation, ISO setting. If you want to adjust various settings, set the mode dial to P, then shoot your subject.

Shooting with a suitable setting for the subject

Selecting an appropriate mode for the subject or the shooting conditions allows you to shoot the image with a suitable setting for the subject.

SCN Shooting with preset settings according to the scene (Scene Selection)

This mode is suitable for

- Shooting with preset settings according to the scene



















1 Set the mode dial to SCN (Scene Selection).

2 Press the center of the controller.

3 Select the desired mode with ▲/▼, then press the center of the controller.

- To change the scene, press the Fn button, then select another scene.
-

 (Portrait)	<p>Blurs away backgrounds and sharpens the subject. Expresses skin tones softly.</p> <ul style="list-style-type: none"> • To blur the background more, set the lens to the telephoto position. • You can shoot a vivid image by focusing on the eye that is closer to the lens. • Use the lens hood (sold separately) to shoot backlit subjects. • Use the red-eye reduction function if the eyes of your subject turn red from the flash (page 100). 	
 (Sports Action)	<p>Shoots a moving subject at a fast shutter speed so that the subject looks as if it is standing still. The camera shoots images continuously while the shutter button is pressed.</p> <ul style="list-style-type: none"> • Press and hold the shutter button halfway down until the right moment. 	
 (Macro)	<p>Shoots close subjects such as flowers, foods.</p> <ul style="list-style-type: none"> • You can shoot a closer subject using a macro lens (sold separately). • Set the flash mode to [Flash Off] when you shoot a subject within 1 m (3.3 feet). • When shooting in macro mode, the SteadyShot function will not be fully effective. Use a tripod to achieve better results. • The shortest focal distance does not change. 	
 (Landscape)	<p>Shoots the entire range of scenery in sharp focus with vivid colors.</p> <ul style="list-style-type: none"> • To accentuate the openness of the scenery, set the lens to wide angle. 	
 (Sunset)	<p>Shoots the red of the sunrise or sunset beautifully.</p>	

 (Night View)	<p>Shoots night scenes at a distance without losing the dark atmosphere of the surroundings.</p> <ul style="list-style-type: none"> • The shutter speed is slower, so using a tripod is recommended. • The picture may not be taken properly when shooting a wholly dark night scene. 	
 (Hand-held Twilight)	<p>Shoots night scenes with less noise and blur without using a tripod. A burst of shots are taken, and image processing is applied to reduce subject blur, camera shake, and noise.</p> <ul style="list-style-type: none"> • Reducing blur is less effective even in [Hand-held Twilight] when shooting: <ul style="list-style-type: none"> – Subjects with erratic movement – Subjects are too close to the camera – Subjects with a repeating pattern such as tiles, and subjects with little contrast such as sky, sandy beach, or lawn – Subjects with constant change such as waves or water falls • In the case of [Hand-held Twilight], block noise may occur when using a light source that flickers, such as fluorescent lighting. 	
 (Night Portrait)	<p>Shoots portraits in night scenes.</p> <ul style="list-style-type: none"> • The shutter speed is slower, so using a tripod is recommended. 	

Shooting technique

- When you want finer images, set the mode dial to P, A, S, or M and use the creative style function (page 112). In such cases, you can adjust the exposure, ISO, etc., even when you select a suitable setting for the subject.

Notes

- Since the camera judges the settings automatically, many features will be unavailable, such as exposure compensation, ISO setting.
- The flash is set to [Autoflash] or [Flash Off] for each Scene Selection mode. You can change these settings (page 98).

Shooting panoramic images (Sweep Panorama)

This mode is suitable for

- Shooting expansive scenery, or high-rise buildings with dynamic composition.



1 Set the mode dial to  (Sweep Shooting).

2 Press the center of the controller.

3 Select [Sweep Panorama] with ▲/▼, then press the center of the controller.

- To select [3D Sweep Panorama], press the Fn button, then select it.

4 Point the camera at the edge of the subject, then press the shutter button halfway down to adjust the focus.

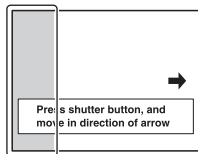

This part will not be taken

5 Press the shutter button fully down.

6 Pan or tilt the camera to the end, following the guidance on the screen.

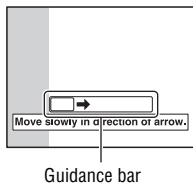

Notes

- If you cannot pan or tilt the camera across the entire subject within the given time, a gray area occurs in the composed image. If this happens, move the camera fast to record a full panoramic image.
- Since several images are stitched together, the stitched part will not be recorded smoothly. While shooting, do not tilt the camera back and forth, or right and left when you swing the camera straight ahead.
- Under low light conditions, panoramic images may be blurred or not be recorded.
- Under lights that flicker such as fluorescent light, the brightness or color of the combined image is not always the same.
- When the whole angle of panoramic shooting and the angle in which you fixed the focus and exposure with AE/AF lock are extremely different in brightness, color and focus, the shooting will not be successful. If this happens, change the lock angle and shoot again.
- [Sweep Panorama] is not suitable when shooting:
 - Subjects are moving.
 - Subjects are too close to the camera.
 - Subjects with a repeating pattern such as tiles, and subjects with little contrast such as sky, sandy beach, or lawn.
 - Subjects with constant change such as waves or water falls.
 - Subjects with the sun or electric lights, etc. that are much brighter than surroundings.
- [Sweep Panorama] recording may be discontinued in the following situations:
 - You pan or tilt the camera too fast or too slow.
 - There is too much camera shake.
- The camera continues shooting during [Sweep Panorama] recording, and the shutter keeps clicking until the end of the shooting.

Tips for shooting a panoramic image

Pan or tilt the camera in an arc with a constant velocity and in the same direction as the indication on the screen. [Sweep Panorama] is better suited for still subjects, rather than moving ones.

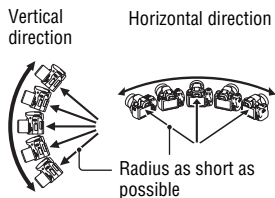

- In Sweep Panorama, it is recommended that you use a wide-angle lens.
- When you use a lens that has a long focal length, pan or tilt the camera more slowly than when you use a wide-angle lens.
- Determine the scene and press the shutter button halfway, so that you can lock the focus, exposure, and white balance.
- If a section with greatly varied shapes or scenery is concentrated along a screen edge, the image composition may fail. In such case, adjust the frame composition so that the section is in the center of the image, then shoot again.
- You can select the image size: MENU button → 2 → [Panorama: Size].

To set the direction in which to pan or tilt the camera

MENU button → 2 → [Panorama: Direction] → Select the desired setting

☐ Shooting 3D-panoramic images (3D Sweep Panorama)

This mode is suitable for

- Shooting 3D-panoramic images and making the images seen alive on a 3D-compatible TV screen.



1 Set the mode dial to ☐ (Sweep Shooting).

2 Press the center of the controller.

3 Select [3D Sweep Panorama] with ▲/▼, then press the center of the controller.

- To select [Sweep Panorama], press the Fn button, then select it.
-

4 Shoot a subject in the same way as that of [Sweep Panorama] shooting (pages 66 to 68).

- For details on the notes and essential points on this kind of shooting, see the details given for [Sweep Panorama] shooting.
 - For details on 3D-shooting, see page 194.
-

To set the direction in which to pan the camera

MENU button →  **2** → [3D Pan.: Direction] → **Select the desired setting**

Note

- The vertical direction is not provided with this function.

Shooting an image the way you want it (Exposure mode)

With an Interchangeable Lens Digital Camera, you can adjust the shutter speed (how long the shutter is open) and aperture (the range that is in focus: depth of field) to enjoy a variety of photographic expressions.

Adjusting the shutter speed and aperture not only creates the photographic effects of movement and focus, but also determines the brightness of the image by controlling the amount of exposure (the amount of light the camera takes in), which is the most important factor in photo shooting.

Changing the brightness of the picture by the amount of exposure



When using a faster shutter speed, the camera opens the shutter for a shorter time. This means less time for the camera to take in light, resulting in a darker picture. To take a brighter picture, you can open the aperture (the hole through which the light passes) to some extent in order to adjust the amount of light the camera takes in at one time.

The brightness of the picture adjusted by the shutter speed and aperture is called “exposure.”

This section will show you how to adjust the exposure and enjoy various photo expressions by the use of movement, focus, and light.

P Shooting with program auto

This mode is suitable for

- Using the automatic exposure, while keeping the custom settings for ISO sensitivity, Creative Style, D-Range optimizer, etc.



1 Set the mode dial to P.

2 Set the shooting functions to your desired settings (pages 85 to 122).

- To fire the flash, press the  button.

3 Adjust the focus and shoot the subject.

A Shooting by controlling the blur of the background (Aperture priority)

This mode is suitable for

- Putting the subject in sharp focus and blur everything in front of and beyond the subject. Opening the aperture narrows the range that is in focus. (Depth of field becomes shallower.)
- Shooting the depth of the scenery. Narrowing down the aperture widens the range that is in focus. (Depth of field becomes deeper.)



1 Set the mode dial to A.

2 Select the aperture value (F-number) with the control dial.

- Smaller F-number: The foreground and background of the subject are blurred.
Larger F-number: The subject and its foreground and background are all in focus.
- You cannot check the blurring of an image on the LCD monitor or in the viewfinder. However, you can check blurring of the background by pressing the preview button.

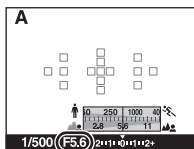
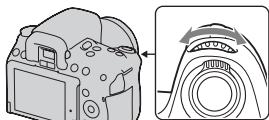

Aperture (F-number)

3 Adjust the focus and shoot the subject.

The shutter speed is automatically adjusted to obtain correct exposure.

- When the camera judges that the proper exposure is not obtained with the selected aperture value, the shutter speed flashes. In such cases, adjust the aperture again.

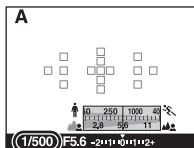

Shutter speed

Shooting techniques

- The shutter speed may become slower depending on the aperture value. When the shutter speed is slower, use a tripod.
- To blur the background more, use a telephoto lens or a lens that is equipped with a smaller aperture value (bright lens).

Note

- Press the  button when you shoot with the flash. However, the flash range differs according to the aperture value. When you shoot with the flash, check the flash range (page 100).

To check blurring of the background (Preview button)

The LCD monitor and the viewfinder shows an image captured with the widest aperture. The change in aperture affects the sharpness of the subject image, creating a discrepancy between the sharpness of the image before shooting and that of the actual image.

While you are pressing the preview button, you can see the image with the aperture used in the actual shot so that you can check the approximate sharpness of the subject before shooting. You can also adjust the aperture in preview mode.

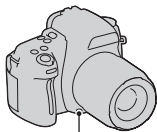

Preview button

Notes

- Press the preview button after you adjust the focus.
- In Live View mode, set the camera to the focus check Live View mode (page 91).
- In viewfinder mode, images displayed in the viewfinder become dark.

S Shooting a moving subject with various expressions (Shutter speed priority)

This mode is suitable for

- Shooting a moving subject at a moment in time. Use a faster shutter speed to crisply shoot an instant of the movement.
- Tracing the movement to express the dynamism and flow. Use a slower shutter speed to shoot a trailing image of the moving subject.

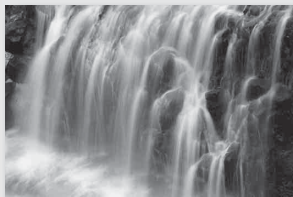

1 Set the mode dial to S.

2 Select the shutter speed with the control dial.

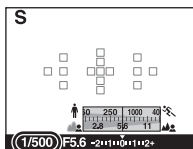
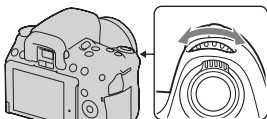

Shutter speed

3 Adjust the focus and shoot the subject.

The aperture is automatically adjusted to obtain correct exposure.

- When the camera judges that the proper exposure is not obtained with the selected shutter speed, the aperture value flashes. In such cases, adjust the shutter speed again.

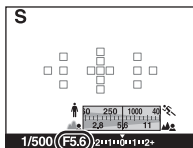



Aperture (F-number)

Shooting techniques

- When the shutter speed is slower, use a tripod.
- When shooting an indoor sport, select a higher ISO sensitivity.

Notes

- The  (Camera shake warning) indicator is not indicated in shutter speed priority mode.
- The higher the ISO sensitivity, the more conspicuous the noise.
- When the shutter speed is one second or more, noise reduction (Long Exposure NR) will be done for the same amount of time that the shutter was released. You cannot do any further shooting during the reduction.

- Press the  button when you shoot with the flash. However, when using the flash, if you close the aperture (a larger F-number) by making the shutter speed slower, the light of the flash will not reach distant subjects.

M Shooting with the exposure adjusted manually (Manual exposure)

This mode is suitable for

- Shooting with the desired exposure setting by adjusting both the shutter speed and aperture.



1 Set the mode dial to M.

2 Rotate the control dial to adjust the shutter speed, and while pressing the  button, rotate the control dial to adjust the aperture.

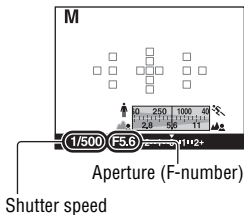
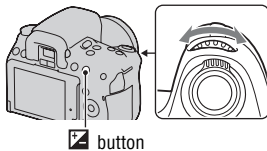

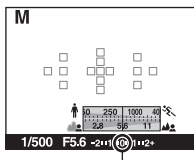

3 Shoot the image after the exposure is set.

- Check the exposure value on the EV scale (Metered Manual*).
Toward +: Images become brighter.
Toward -: Images become darker.
The ◀ ▶ arrow appears if the set exposure is beyond the range of the EV scale. The arrow starts flashing if the difference becomes greater.
- * When the camera is in M mode, it will show an under or over compensation value based on the correct exposure using the index on the exposure compensation indicator.



Standard value

Notes

- The  (Camera shake warning) indicator is not indicated in manual exposure mode.
- When the mode dial is set to M, the ISO setting [AUTO] is set to [100]. In M mode, the ISO setting [AUTO] is not available. Set the ISO sensitivity as necessary (page 108).
- Press the  button when you shoot with the flash. However, the flash range differs according to the aperture value. When you shoot with the flash, check the flash range (page 100).

Manual shift

You can change the shutter speed and aperture value combination without changing the exposure you set.

Rotate the control dial while pressing the AEL button to select the shutter speed and aperture value combination.

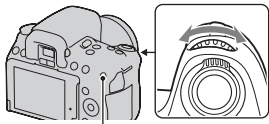

AEL button

M Shooting trails with long exposure (BULB)

This mode is suitable for

- Shooting trails of light, such as fireworks.
- Shooting trails of stars.



1 Set the mode dial to M.

2 Rotate the control dial to the left until [BULB] is indicated.

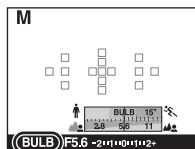
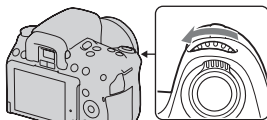

BULB

3 While pressing the  button, rotate the control dial to adjust the aperture (F-number).

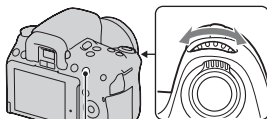

 button

4 Press the shutter button halfway down to adjust the focus.

5 Press and hold the shutter button for the duration of the shooting.

As long as the shutter button is pressed, the shutter remains open.

Shooting techniques

- Use a tripod.
- Set the focus to infinity in manual focus mode when shooting fireworks, etc. When the infinity position of the lens is not known, first adjust the focus on fireworks that is set off in the same general area, then shoot them.
- Use the Wireless Remote Commander (sold separately) (page 122). Pressing the SHUTTER button on the Wireless Remote Commander triggers BULB shooting and pressing it again stops BULB shooting. You do not need to press and hold the SHUTTER button on the Wireless Remote Commander.
- If you use a Remote Commander that is equipped with a shutter button lock function (sold separately), you can leave the shutter open using the Remote Commander.

Notes

- When using a tripod, turn off the SteadyShot function (page 59).
- The longer the exposure time, the more conspicuous the noise on the image.
- After shooting, noise reduction (Long Exposure NR) will be done for the same amount of time that the shutter was open. You cannot do any further shooting during the reduction.
- When the Smile Shutter or Auto HDR function is activated, you cannot set the shutter speed to [BULB].
- If the Smile Shutter or Auto HDR function is used with the shutter speed set to [BULB], the shutter speed is temporarily set to 30 seconds.
- It is recommended that you start BULB shooting after the temperature of the camera drops to prevent the quality of the image from deteriorating.

Recording movies

1 Adjust the focus.

2 Press the MOVIE button to start recording.

- Movie recording can be started from any exposure mode.
- The values relevant to the exposure, such as the shutter speed and aperture, are adjusted automatically.

MOVIE button



3 Press the MOVIE button again to stop recording.

To obtain your desired aperture values

Set the mode dial to “A” and select the aperture value (F number) using the control dial, then start recording your movie. You can record with the selected aperture value. This is convenient when you have to adjust the blurring of a background.

- The aperture value is not indicated and cannot be adjusted during movie recording.
- The aperture value is changed if you rotate the zoom ring of the lens during movie recording.

Shooting techniques

- The following settings that were set during still image shooting are used without change.
 - White Balance
 - Creative Style
 - Exposure compensation
 - Metering mode
- Exposure compensation can be used during movie recording.

Notes

- The autofocus cannot be used during movie recording. Adjust the focus using the autofocus or manual focus before pressing the MOVIE button.
- The angle of view of movies is narrower than that of still images (DSLR-A560 only). After you press the MOVIE button, the camera shows the actual range to be recorded.
- The Face Detection function cannot be used.
- Do not shoot a strong light source, such as the sun. The internal mechanism of the camera may be damaged.
- When you import AVCHD movies to a computer, use “PMB” (page 164).
- When you continue to shoot for a long time, the temperature of the camera rises and the image quality may deteriorate.
- When the [H] mark is indicated, the temperature of the camera is too high. Turn the camera off and wait until the temperature of the camera drops. If you continue to shoot, the camera is turned off automatically.
- For details on movie playback, see page 124.

To change the movie file format

MENU button →  **1** → **[Movie: File Format]** → **Select the desired format**

AVCHD	<p>This file format is suitable for viewing smooth video images on a high-definition TV.</p> <p>Movies shot with this camera are recorded in AVCHD format, approximately 60 fields/sec (1080 60i-compatible devices) or 50 fields/sec (1080 50i-compatible devices), in interlace mode, with Dolby Digital audio, AVCHD format.</p> <ul style="list-style-type: none">• To check if your camera is a 1080 60i-compatible device or 1080 50i-compatible device, check for the following marks on the bottom of the camera. 1080 60i-compatible device: 60i 1080 50i-compatible device: 50i
MP4	<p>This file format is suitable for WEB uploads, e-mail attachments or playing back on computers.</p> <p>Movies shot with this camera are recorded in MPEG-4 format at approximately 30 frames/sec (1080 60i-compatible devices) or approximately 25 frames/sec (1080 50i-compatible devices), in progressive mode, with AAC audio, mp4 format.</p>

Audio recording

When you record movies, the operating noise of the camera or lens may be recorded. You can reduce the noise of the camera by using a tripod, and setting the SteadyShot function to off.

You can also record movies without audio.

MENU button →  **1** → [Movie: Audio Rec.] → [Off]

To change the size

MENU button →  **1** → [Movie: Size] → Select the desired size

For details, see page 141.

Available recording time for a movie

The table below shows the approximate total recording times using a memory card formatted with this camera. The values are defined using Sony standard “Memory Stick PRO Duo” media for testing. The values may vary depending on the shooting conditions and the type of memory card used.

DSLR-A580

(Units: hour : minute : second)

File format/ Size	Capacity				
	2GB	4GB	8GB	16GB	32GB
AVCHD 1920 × 1080	0:14:00	0:28:30	0:58:10	1:58:50	3:55:20
MP4 1440 × 1080	0:20:40	0:41:40	1:24:40	2:52:30	5:41:00
MP4 VGA	1:15:10	2:31:10	5:06:20	10:23:50	20:33:00

File format/ Size	Capacity				
	2GB	4GB	8GB	16GB	32GB
AVCHD 1920 × 1080	0:14:00	0:28:30	0:58:10	1:58:50	3:55:20
MP4 1440 × 1080	0:20:40	0:41:40	1:24:40	2:52:30	5:41:00
MP4 VGA	1:15:10	2:31:10	5:06:20	10:23:50	20:33:00

Note

- The values shown are not the continuous recording time.

Notes on continuous movie recording

- Each continuous recording time value indicated is depending on the temperature or status of the camera.
- The recording time is longer when you disable the SteadyShot function that calls for using a tripod or a similar device.
- Each continuous recording time limit indicated for a movie is available for about 14 minutes (DSLR-A580) or for about 24 minutes (DSLR-A560) at a room temperature of 20°C (68°F). When you disable the SteadyShot function, it is still available for continuous recording for about 29 minutes on both the DSLR-A580 and DSLR-A560.
- If [] is indicated or the camera is turned off automatically since the temperature inside the camera is too high, you can record movies again after turning off the camera for several minutes.
- The maximum size of a movie file is about 2 GB. When the file size is about 2 GB, the recording stops automatically when the file format is MP4, and a new movie file is created automatically when the file format is AVCHD.
- The maximum continuous recording time is 29 minutes.

Selecting the focus method

There are two methods for adjusting the focus: autofocus and manual focus. Depending on the lens, the method for switching between the auto focus and manual focus is different.

The type of lens	The switch to be used	To switch to auto focus	To switch to manual focus
The lens is equipped with a focus mode switch	Lens (Always set the focus mode switch on the camera to AF.)	Set the focus mode switch on the lens to AF.	Set the focus mode switch on the lens to MF.
The lens is not equipped with a focus mode switch	Camera	Set the focus mode switch on the camera to AF.	Set the focus mode switch on the camera to MF.

Using autofocus

- 1 Set the focus mode switch on the camera to AF.**

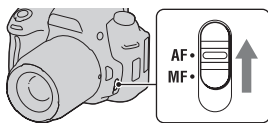

- 2 When the lens is equipped with the focus mode switch, set it to AF.**

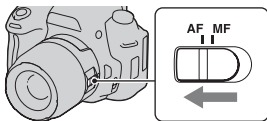

3 Press the shutter button halfway down to check the focus and shoot the image.

- When the focus is confirmed, the focus indicator changes to ● or (●) (below).
- The AF area where the focus has been confirmed turns green.

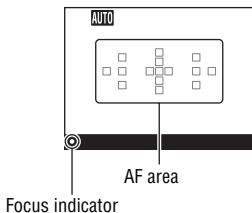

Shooting technique

- To select the AF area used for focusing, set up [AF area] (page 89).

Focus indicator

Focus indicator	Status
● lit	Focus locked. Ready to shoot.
(●) lit	Focus is confirmed. Focal point moves following a moving subject. Ready to shoot.
(C) lit	Still focusing. You cannot release the shutter.
● flashing	Cannot focus. The shutter is locked.

Subjects that may require special focusing

Using the autofocus, it is hard to focus on the following subjects. In such cases, use the focus lock shooting feature (page 87) or manual focus (page 90).

- A subject that is low in contrast, such as blue sky or a white wall.
- Two subjects at different distances overlapping in the AF area.
- A subject that is composed of repeating patterns, such as the facade of a building.
- A subject that is very bright or glittering, such as the sun, the body of an automobile, or the surface of water.
- Ambient light is not sufficient.

To measure the exact distance to the subject

The \ominus mark located on the top of the camera shows the location of the image sensor*. When you measure the exact distance between the camera and the subject, refer to the position of the horizontal line.

* The image sensor is the part of the camera that acts as the film.

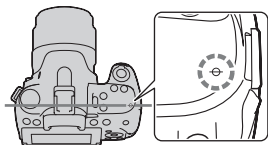

Note

- If the subject is closer than the minimum shooting distance of the attached lens, the focus cannot be confirmed. Make sure you put enough distance between the subject and the camera.

Shooting with your desired composition (Focus-lock)

- 1 Place the subject within the AF area and press the shutter button halfway down.**

The focus and exposure are fixed.

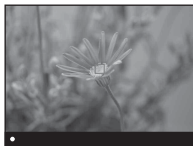

- 2 Keep the shutter button halfway down, and put the subject back in the original position to re-compose the shot.**

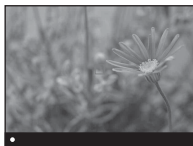

- 3 Press the shutter button fully down to take the picture.**

Selecting the focus method to suit the movement of the subject (Autofocus Mode)

Fn button → **AF-A (Autofocus Mode)** → **Select the desired setting**

AF-S (Single-shot AF)	The camera focuses and the focus is locked when you press the shutter button halfway down.
AF-A (Automatic AF)	The [Autofocus Mode] is switched between Single-shot AF and Continuous AF according to the movement of the subject. When you press and hold the shutter button halfway down, if the subject is motionless, the focus is locked and if the subject is in motion, the camera continues to focus.
AF-C (Continuous AF)	The camera continues to focus while the shutter button is pressed and held halfway down. <ul style="list-style-type: none">• The audio signals will not sound when the subject is in focus.• Focus-lock cannot be used.

Shooting techniques

- Use [Single-shot AF] when the subject is motionless.
- Use [Continuous AF] when the subject is in motion.

Notes

- [Automatic AF] is selected when the exposure mode is set to AUTO or one of the following Scene Selection modes: [Portrait], [Landscape], [Sunset], [Night View], [Night Portrait], or [Hand-held Twilight].
[Single-shot AF] is selected when the exposure mode is set to [Macro] in Scene Selection.
[Continuous AF] is selected when the exposure mode is set to [Sports Action] in Scene Selection.
- [Continuous AF] is selected when the Smile Shutter function is used.

Selecting the focus area (AF area)

Select the desired AF area to suit the shooting conditions or your preference. The AF area where the focus has been confirmed turns green and the other AF areas disappear.

- In viewfinder mode, the AF areas that were not used to adjust the focus will disappear.

LCD monitor

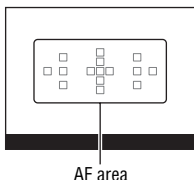

Viewfinder

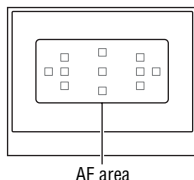

Fn button → (Wide) → **Select the desired setting**

(Wide)	The camera determines which of the 15 AF areas (the 11 AF areas in viewfinder mode) is used in focusing. In viewfinder mode, four metering points are also used, in addition to 11 AF areas.
(Spot)	The camera uses the AF area located in the center area exclusively.
(Local)*	Choose the area for which you want to activate the focus from among 15 AF areas (the 11 AF areas in viewfinder mode) with the controller. Press the AF button to display the setup screen and select the desired area.
(Flexible Spot)	Moves the AF area to focus on a small subject or narrow area with / / / of the controller.

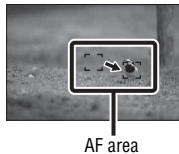

* When [Contrast AF] is selected, [Local] is indicated by .

Notes

- The available AF area settings depend on the status of the [AF method] setting (page 91). When [Contrast AF] is selected, [Spot] and [Flexible Spot] are available. When [Phase-detect AF] is selected, [Wide], [Spot], and [Local] are available.
- When the exposure mode is set to AUTO or Scene Selection, or the Smile Shutter is activated, [AF area] is fixed to [Wide] and you cannot select the other settings.
- The AF area may not be illuminated during continuous shooting or when the shutter button is pressed all the way down without pause.

Adjusting the focus manually (Manual focus)

When it is difficult to get the proper focus in autofocus mode, you can adjust the focus manually.

- 1 Set the focus mode switch on the lens to MF.**

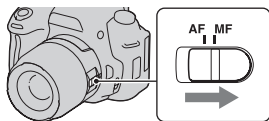

- 2 When the lens is not equipped with the focus mode switch, set the focus mode switch on the camera to MF.**

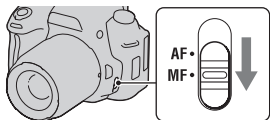

- 3 Rotate the focusing ring of the lens to achieve a sharp focus.**

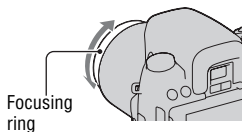

Notes

- In the case of a subject that can be focused in autofocus mode, the ● indicator lights up when the focus is confirmed. When the Wide AF area is used, the center area is used, and when the Local AF area is used, the area that is selected with the controller is used.

- When using a tele converter (sold separately), etc., rotation of the focusing ring may not be smooth.
- The correct focus in the viewfinder is not achieved if the diopter is not adjusted properly in viewfinder mode (page 40).

Composing your shot using the image sensor (Focus check Live View)

The image on the image sensor is displayed on the LCD monitor with 100% frame coverage.

1 Press the FOCUS CHECK LV button.

The mirror is raised.

FOCUS CHECK LV button

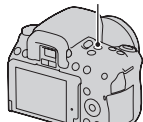

2 Adjust the focus and shoot the image.

In autofocus mode: Press the shutter button halfway down or press the AF button.

In manual focus mode: Rotate the focusing ring manually.

Notes

- The image in the viewfinder is not visible in focus check Live View mode.
- When using the focus check Live View function in viewfinder mode, it is recommended that you attach the eyepiece cover (page 34).
- When you perform continuous or exposure bracket shooting in focus check Live View mode, the autofocus is set at the first shot.

To change the AF method

The AF method can be switched between [Contrast AF] (default setting) and [Phase-detect AF] in focus check Live View mode. The phase-detection AF is always used for focusing when the camera is not in focus check Live View mode.

MENU button →  **2** → **[AF method]** → **Select the desired setting**

In focus check Live View mode, each AF method has the following differences.

Contrast AF	Live View works even when the focus is being adjusted. <ul style="list-style-type: none">• Only when SAM lenses or SSM lenses are used.• The Face Detection and Smile Shutter functions cannot be used.• The AF area setting can be selected from either [Spot] or [Flexible Spot].
Phase-detect AF	This shortens the time the focus is achieved, however, Live View does not work when the focus is being adjusted. <ul style="list-style-type: none">• The AF area setting can be selected from either [Wide], [Spot], or [Local].

Shooting technique

- When using [Contrast AF], attach the camera to a tripod because the focus may be difficult to be adjusted properly.

Notes

- When using [Contrast AF], it may take time to adjust the focus, depending on the subject or the lens attached.
- If you press the shutter button or AF button, the camera focuses on the subject again, even if the proper focus has already been obtained.
- The brightness of the screen may change when the contrast AF is activated.
- AF illuminator light is not emitted.

Subjects that may require special focusing

Using the autofocus, it is hard to focus on the following subjects. In such cases, use the focus lock shooting feature (page 87) or manual focus (page 90).

- It is dark and the subject is distant.
- The contrast between the subject and the background is poor.
- The subject is seen through glass.
- The subject is moving quickly.
- The subject reflects light such as mirror, or has shiny surfaces.
- The subject is flashing.
- The subject is backlit.

The focus may hard to be achieved, depending on the lens attached, even if you shoot the same subject.

The digital level gauge of this camera

In focus check Live View mode, press the DISP button so that the digital level gauge is displayed (page 42). The digital level gauge indicates whether the camera is level in both the horizontal and front-back directions. When the camera is level in both directions, the indicator turns to green.

Horizontal direction

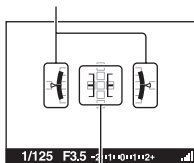

Front-back direction

Notes

- The error of the digital level gauge is larger if you tilt the camera too far forward or backward.
- A tilt of $\pm 1^\circ$ may be indicated even if the camera is almost level.

Checking the focus by enlarging the image

You can check the focus by enlarging the image before shooting.

1 Press the FOCUS CHECK LV button.

FOCUS CHECK LV button

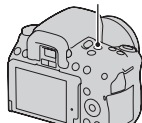

2 Press the AEL button.

AEL button

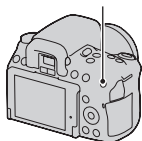

3 Press the AEL button again to enlarge the image and select the portion you want to enlarge with ▲/▼/◀/▶ on the controller.

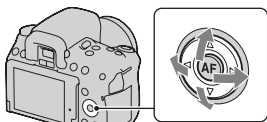

- Each time you press the AEL button, the zoom scaling changes as follows:
Full display → Approx. $\times 7.5$ →
Approx. $\times 15$ (DSLR-A580)/Full
display → Approx. $\times 7$ → Approx. $\times 14$
(DSLR-A560)

4 Adjust the focus and shoot the subject.

- You can record images when an image is enlarged, however the recorded image is for full display.
- The Focus Magnifier function will be released after shooting.

Note

- This function cannot be used when [Func. of AEL button] in the ⚙ Custom menu is set to [AEL].

Detecting faces

Using the Face Detection function

The camera detects faces, adjusts the focus, exposure, performs image processing, and adjusts flash settings. The Face Detection function is set to [On] in the default setting.

The Face Detection frame

When the camera detects faces, white Face Detection frames appear. When the camera judges that autofocus is possible, the Face Detection frames turn orange. When you press the shutter button halfway down, the Face Detection frames turn green.

- If a face is not positioned inside the AF area available when you press the shutter button halfway down, the AF area that is used for focusing turns green.
- When the camera detects multiple faces, the camera automatically selects a priority face and the single Face Detection frame turns orange.

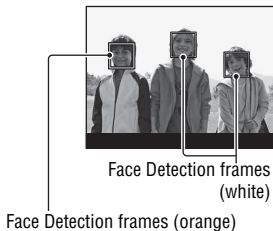

To deactivate the Face Detection function

Fn button →  **(Face Detection)** → [Off]

Shooting technique

- Compose to overlay the Face Detection frame and the AF area.

Notes

- When the exposure mode is Sweep Shooting or during movie recording, the Face Detection function cannot be used in viewfinder mode.

- Up to eight faces can be detected.
- The camera may not detect any faces, or may detect some other object, depending on the shooting conditions.

Capturing smiling faces (Smile Shutter)

When the camera detects a smile, the shutter is released automatically.

1 Fn button → ☺_{OFF} (Smile Shutter) → [On] → Select the desired Smile Detection Sensitivity mode

- You can set the sensitivity of the Smile Shutter function for detecting smiles to one of the following three options: ☺_{ON} (Slight Smile), ☺_{ON} (Normal Smile), and ☺_{ON} (Big Smile).
- When the Smile Shutter is activated, the Smile Detection Sensitivity indicator appears on the screen.

2 Wait detecting a smile.

The camera detects a smile and the focus is confirmed. When the smile level exceeds the ◀ point on the indicator, the camera records images automatically.

- When the camera detects faces, orange Face Detection frames appear around the faces. The Face Detection frames turn green when these subjects come into focus.
- The smile level of the face surrounded by the double Face Detection frame is indicated on the Smile Detection Sensitivity indicator.

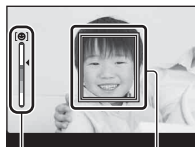

Face Detection frame
Smile Detection Sensitivity indicator

3 To stop shooting, Fn button → ☺_{ON} (Smile Shutter) → [Off]

Shooting techniques

- To focus on the smile, overlay the Face Detection frame and AF area.
- Do not cover the eyes with bangs, etc. Keep the eyes narrowed.

- Do not obscure the face with a hat, a mask, sunglasses, etc.
- Try to orient the face in front of the camera and keep it as level as possible.
- Hold a clear smile with an open mouth. The smile is easier to detect when the teeth are showing.
- If you press the shutter button while the Smile Shutter function is activated, the camera shoots the image, and then returns to Smile Shutter.

Notes

- When the exposure mode is set to Sweep Shooting, the Smile Shutter function cannot be used.
- The drive mode is automatically set to [Single-shot Adv.] or [Remote Cdr.].
- The AF illuminator does not work with the Smile Shutter function.
- If the camera does not detect a smile, change the settings for Smile Detection Sensitivity.
- Smiles may not be detected correctly, depending on the shooting conditions.

Using the flash

In a dark location, using the flash allows you to shoot the subject brightly, and it also helps to prevent camera shake. When shooting into the sun, you can use the flash to shoot a bright image of the backlit subject.

1 Fn button → ⚡ (Flash Mode) → Select the desired setting

2 Press the ⚡ button.

The flash pops up.

- In AUTO or Scene Selection mode, the flash automatically pops up if the amount of light is insufficient or the subject is backlit. The built-in flash does not pop up even if you press the ⚡ button.

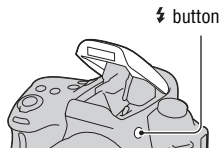





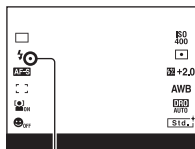

3 After the flash has finished charging, shoot the subject.

- Flashing: The flash is being charged. When the indicator flashes, you cannot release the shutter.
- Lit: The flash has been charged and is ready to fire.
- When you press the shutter button halfway down under dark lighting in autofocus mode, the flash may be fired to help focus on a subject (AF Illuminator).
- ● is indicated only in the recording information display mode (page 43).



- (Flash charging) indicator

 (Flash Off)	Does not fire even the built-in flash pops up.
 (Autoflash)	Fires if it is dark or against light.
 (Fill-flash)	Fires every time you trigger the shutter. When the exposure mode is set to P, A, S, or M, press the  button to pop the flash up before shooting.
 (Slow Sync.)	Fires every time you trigger the shutter. Slow sync shooting allows you to shoot a clear image of both the subject and the background by slowing the shutter speed.
 (Rear Sync.)	Fires right before the exposure is completed everytime you trigger the shutter.
 (Wireless)	Fires an external flash (sold separately) that is off the camera and away from it (Wireless flash shooting).

Shooting techniques

- The lens hood (sold separately) may block the light of the flash. Remove the lens hood when using the flash.
- When using the flash, shoot the subject at a distance of 1 m (3.3 feet) or greater.
- When shooting indoors or shooting nightscapes, you can use slow sync to shoot a brighter image of people and backgrounds.
- You can use rear sync to shoot a natural image of the trail of a moving subject such as a moving bicycle or a walking person.
- When using the HVL-F58AM/HVL-F42AM Flash (sold separately), you can shoot with the High-speed sync feature at any shutter speed. For details, refer to the operating instructions supplied with the flash.

Notes



- Do not hold the camera by grabbing the flash emitter.
- Shooting conditions required to prevent shadows from appearing on an image vary, depending on the lens.
- When the exposure mode is set to AUTO or Scene Selection, the [Slow Sync.], [Rear Sync.], and [Wireless] items cannot be selected.
- When the exposure mode is set to P, A, S, M, the [Flash Off] or [Autoflash] items cannot be selected. If you do not want to use the flash, push the flash down.
- If you use the flash with a stereo microphone or similar device attached to the Auto-lock Accessory shoe, the flash may not pop up to the correct position and recorded images may have a shadow on their corners. Remove any device from the Auto-lock Accessory shoe.

The flash range

The range of the built-in flash depends on the ISO sensitivity and aperture value. Refer to the following table.

Aperture		F2.8	F4.0	F5.6
ISO setting	100	1 m– 4.3 m (3.3 feet– 14 feet)	1 m– 3 m (3.3 feet– 9.8 feet)	1 m– 2.1 m (3.3 feet – 6.9 feet)
	200	1 m– 6 m (3.3 feet – 20 feet)	1 m– 4.3 m (3.3 feet – 14 feet)	1 m– 3 m (3.3 feet – 9.8 feet)
	400	1.4 m– 8.6 m (4.6 feet – 28 feet)	1 m– 6 m (3.3 feet – 20 feet)	1 m– 4.3 m (3.3 feet – 14 feet)
	800	2 m– 12 m (6.6 feet – 39 feet)	1.4 m– 8.6 m (4.6 feet – 28 feet)	1 m– 6 m (3.3 feet – 20 feet)

The AF illuminator

- AF illuminator does not operate when [Autofocus Mode] is set to [Continuous AF] or the subject is moving in [Automatic AF]. (The  or  indicator lights.)
- The AF illuminator may not operate with focal lengths of 300 mm or longer.
- When an external flash (sold separately) that is equipped with an AF illuminator is attached, the AF illuminator of the external flash is used.
- AF illuminator does not operate when [Smile Shutter] is set to [On].

To deactivate the AF illuminator

MENU button →  **2** → [AF Illuminator] → [Off]

To use the red-eye reduction

The red-eye reduction reduces the red-eye phenomenon by providing pre-flash (low-flash light) a few times before shooting when using the flash.

MENU button →  **1** → [Red Eye Reduction] → [On]

Performing wireless flash shooting

With a flash that has a wireless shooting function (sold separately), you can shoot with the flash without a cord, even when the flash is not attached to the camera. By changing the position of the flash, you can shoot an image with a three dimensional feel by highlighting the contrast of light and shadow on the subject.

For the actual steps of shooting, refer to the operating instructions of the flash.

1 Attach the wireless flash to the Auto-lock Accessory shoe and turn both the camera and the flash on.

2 Fn button → (Flash Mode) → (Wireless)

3 Remove the wireless flash from the Auto-lock Accessory shoe and pop up the built-in flash.

- If you perform a test fire of the flash, press the AEL button.

Notes

- The camera cannot carry out the wireless lighting ratio control.
- Turn off the wireless flash mode after wireless flash shooting. If the built-in flash is used while the wireless flash mode is still active, inaccurate flash exposures will result.
- Change the channel of the external flash when another photographer is using a wireless flash nearby and his/her built-in flash light causes your external flash to fire. To change the channel of the external flash, refer to the operating instructions supplied with it.

Setup of the AEL button

When using a wireless flash, it is recommended that you set [AEL] to [Hold] in the  Custom menu (page 149).

Adjusting the brightness of the image (Exposure, Flash compensation, Metering)

Shooting with fixed brightness (AE Lock)

When shooting into the sun or by a window, the exposure may not be appropriate for the subject because of the big difference in lighting between the subject and the background. In such cases, use the light meter where the subject is bright enough and lock the exposure before shooting. To reduce the brightness of the subject, point the camera forwards a spot that is brighter than the subject and use the light meter to lock the exposure of the entire image. To make the subject brighter, point the camera forwards a spot that is darker than the subject and use the light meter to lock the exposure of the entire image.

This section describes how to shoot a brighter image of the subject using the  (Spot).

The spot where you lock the exposure.

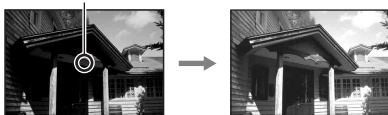

1 Fn button →  (Metering Mode) →  (Spot)

2 Adjust the focus on the portion you want to lock the exposure.

The exposure is set when the focus is achieved.

3 Press the AEL button to lock the exposure.

- * (AE lock mark) appears.

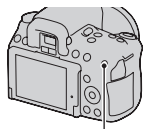

AEL button



4 While pressing the AEL button, focus on the subject, and shoot the subject.

- If you continue to shoot with the same exposure value, press and hold the AEL button after the shooting. The setting is canceled when the button is released.

Note

- In focus check Live View mode (page 91), set [Func. of AEL button] to [AEL] in the  Custom menu.

Using brightness compensation for the entire image (Exposure compensation)

Except for exposure mode M, the exposure is automatically selected (Automatic exposure).

Based on the exposure acquired by the automatic exposure, you can perform exposure compensation by shifting the exposure to either the + side or the – side, depending on your preference. You can make the entire image brighter by shifting to the + side. The entire image becomes darker when you shift it to the – side.

Adjust in the – direction



Base exposure



Adjust in the + direction



1 Press the button.

- The exposure compensation screen is displayed in the viewfinder mode.

 button



2 Adjust the exposure with the control dial.

Toward + (over): Brightens an image.

Toward - (under): Darkens an image.

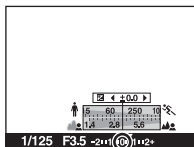

Standard exposure

3 Adjust the focus and shoot the subject.

Shooting techniques

- Adjust the compensation level by checking the recorded image.
- Using bracket shooting, you can shoot multiple images with the exposure shifted to the plus or minus sides (page 120).

Note

- This item cannot be set when the exposure mode is set to AUTO or Scene Selection.

To shoot while checking the screen using the histogram

The histogram displays the luminance distribution that shows how many pixels of a particular brightness exist in the picture.

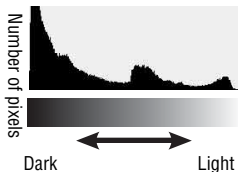

MENU button → 2 → [Histogram] → [On]

- Instead of the Graphic Display, the histogram is displayed after you press the DISP button several times (page 42).

The exposure compensation will change the histogram accordingly. The right illustration is an example.

Shooting with the exposure compensation on the positive side brightens the whole picture, making the entire histogram shift to the bright side (right side). If the exposure compensation is applied on the negative side, the histogram will shift to the other side. Both ends of the histogram show a high-key or low-key portion. It is impossible to restore these area with a computer later. Adjust the exposure if necessary and shoot again.



Notes

- The histogram displayed in Live View mode does not indicate the final recorded image. It indicates the condition of the image just monitored on the screen. The histogram will differ based on aperture setting, etc.
- The histogram differs between shooting and playback in the following situations:
 - When firing the flash.
 - When the subject has low intensity, such as night scenery.

Adjusting the amount of flash light (Flash Compensation)

When shooting with the flash, you can adjust the amount of flash light alone, without changing the exposure compensation. You can only change the exposure of a main subject which is within the flash range.

Fn button → ** (Flash Compensation)** → **Select the desired setting**

Toward +: Makes the flash level higher.

Toward -: Makes the flash level lower.

Notes

- This item cannot be set when the exposure mode is set to AUTO, Sweep Shooting, or Scene Selection.
- If you have adjusted the flash level,  appears in the viewfinder when the built-in flash is pulled up. When you adjust it, be careful not to forget to reset the value.
- The higher flash effect may not be visible due to the limited amount of flash light, if the subject is outside the maximum range of the flash. If the subject is very close, the lower flash effect may not be visible.

Exposure compensation and flash compensation

Exposure compensation changes the shutter speed, aperture, and ISO sensitivity (when [AUTO] is selected) to perform the compensation.

Flash compensation only changes the amount of flash light.

Selecting the flash control mode to set the amount of flash light (Flash control)

MENU button →  **2** → **[Flash control]** → **Select the desired setting**

ADI flash	This method controls the lighting of the flash, factoring in the focus distance information and light metering data from the pre-flash. This method enables an accurate flash compensation with virtually no effect from the reflection off the subject.
Pre-flash TTL	This method controls the amount of flash light depending on the data only from pre-flash light metering. This method is susceptible to the reflection off the subject.

ADI: Advanced Distance Integration

TTL: Through the lens



- When [ADI flash] is selected, using a lens that is provided with a distance encoder feature can perform more accurate flash compensation by using more accurate distance information.

Notes

- When the distance between the subject and the external flash (sold separately) cannot be determined (wireless flash shooting using an external flash (sold separately), shooting with an off-camera flash using a cable, shooting with a macro twin flash, etc.), the camera automatically selects Pre-flash TTL mode.
- Select [Pre-flash TTL] in the following cases, as the camera cannot perform flash compensations with ADI flash.
 - A wide panel is attached to the HVL-F36AM flash.
 - A diffuser is used for flash shooting.
 - A filter with an exposure factor, such as an ND filter, is used.
 - A close-up lens is used.
- ADI flash is only available in combination with a lens that is provided with a distance encoder. To determine if the lens is equipped with a distance encoder, refer to the operating instructions supplied with the lens.

Selecting the method for measuring the brightness of a subject (Metering Mode)

Fn button →  **(Metering Mode)** → **Select the desired mode**

 (Multi segment)	This mode measures light on each area after dividing the total area into multiple areas and determines the proper exposure of the entire screen.
 (Center weighted)	While emphasizing the central area of the screen, this mode measures the average brightness of the entire screen.
 (Spot)	This mode measures light only in the spot metering circle located in the center area.

Shooting techniques

- Use [Multi segment] metering for general shooting.
- When there is a high contrast subject in the AF area, measure the light of the subject you want to shoot with the optimal exposure using the spot metering function and take advantage of an AE lock shooting (page 102).

Note

- When the exposure mode is set to AUTO or Scene Selection, [Metering Mode] is fixed to [Multi segment] and you cannot select other modes.

Setting ISO

Sensitivity to light is expressed by the ISO number (recommended exposure index). The larger the number, the higher the sensitivity.

1 Press the ISO button to display the ISO screen.

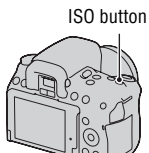

2 Select the desired setting with ▲/▼ on the controller.

- The larger the number, the higher the noise level.
- If you select [Multi Frame Noise Reduct.], select the desired value with ◀/▶.

Notes

- When the exposure mode is set to AUTO, Sweep Shooting, or Scene Selection, ISO is fixed to AUTO and you cannot select other ISO numbers.
- When the exposure mode is set to P/A/S and ISO is set to [AUTO], ISO is automatically set between ISO 100 and ISO 1600 (DSLR-A580)/ISO 200 and ISO 1600 (DSLR-A560).
- The [AUTO] setting is not provided in exposure mode M. If you change the exposure mode to M with the [AUTO] setting, it is switched to the minimum ISO sensitivity. Set the ISO according to your shooting conditions.

Multi frame noise reduction (Multi Frame NR)

The camera automatically shoots multiple images continuously, combines the images, reduces the noise, and records one image. In Multi Frame NR, you can select ISO numbers up to ISO 25600.

The image recorded is one combined image.

Notes

- Press and hold the shutter button until the continuous shooting stops.
- When [Image: Quality] is set to [RAW] or [RAW & JPEG], this function cannot be used.
- The flash, D-Range optimizer, and [Auto HDR] cannot be used.

Compensating for the brightness and contrast automatically (D-Range)

D-RANGE button → Select the desired setting

D-RANGE button

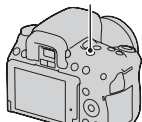

D-R OFF (Off)	Does not use the DRO/Auto HDR functions.
DRO (D-RangeOptimizer)	By dividing the image into small areas, the camera analyses the contrast of light and shadow between the subject and the background, producing the image with the optimal brightness and gradation.
HDR (Auto HDR)	Shoots three images with different exposures, and then overlays correctly exposed image, the bright areas of an under exposed image and the dark areas of an over exposed image to create an image with rich gradation. Two images are recorded: an image with the correct exposure and an overlaid image.

Correcting the brightness of the image (D-Range Optimizer)

1 D-RANGE button → **DRO (D-RangeOptimizer)**

2 Select an optimal level with ◀/▶ on the controller.

DRO AUTO (Auto)	Corrects the brightness automatically.
DRO (Level)*	Optimizes the gradations of a recorded image in each area of the image. Select the optimal level between Lv1 (weak) and Lv5 (strong).

* Lv_ displayed with **DRO** is the step currently selected.



Notes

- The setting is fixed to [Off] when [Sunset], [Night View], [Night Portrait], or [Handheld Twilight] is selected in Scene Selection. The setting is fixed to [Auto] when other modes are selected in Scene Selection.
- When shooting with the D-Range optimizer, the image may be noisy. Select the proper level by checking the recorded image, especially when you enhance the effect.

Compensating automatically with rich gradation (Auto High Dynamic Range)

1 D-RANGE button → (Auto HDR)

2 Select an optimal level with /▶ on the controller.

 (Auto Exposure Diff.)	Corrects the exposure difference automatically.
 (Exposure Difference Level)*	Sets the exposure difference, based on the contrast of the subject. Select the optimal level between 1.0Ev (weak) and 6.0Ev (strong). For example: When 2.0Ev is selected, three images are overlaid: an image with -1.0Ev, an image with the correct exposure, and an image with +1.0Ev.

* _Ev displayed with  is the step currently selected.

Shooting technique

- Since the shutter is released three times for one shot, be careful about the following:
 - Use this function when the subject is motionless or does not blink.
 - Do not recompose.
 - When you photograph people, we recommend that you use the Live View mode.

Notes

- When [Image: Quality] is set to [RAW] or [RAW & JPEG], this function cannot be used.

- When the exposure mode is set to AUTO, Sweep Shooting, or Scene Selection, you cannot select [Auto HDR].
- You cannot select [Auto HDR] during Smile Shutter. If you turn on the Smile Shutter function with [Auto HDR] selected, the camera will temporarily use with the DRO setting.
- You cannot start the next shoot until the capture process is completed after you shoot.
- You may not obtain a desired effect depending on the luminance difference of a subject and the shooting conditions.
- When the flash is used, this function has little effect.
- When the contrast of the scene is low or when camera shake or subject blur is occurred, you may not obtain good HDR images. If the camera has detected a problem,  is indicated on the recorded image to inform you of this situation. Shoot again, as necessary, paying attention to the contrast or blur.

Image processing

Selecting your desired image processing (Creative Style)

In addition to the desired image processing, you can adjust the exposure (shutter speed and aperture) as you like with [Creative Style], unlike Scene Selection where the camera adjusts the exposure.

1 Fn button → **[Std.]** (Creative Style) → **Select the desired setting**

2 When you want to adjust **☉ (Contrast)**, **⊗ (Saturation)**, or **⌂ (Sharpness)**, **select the desired item with** **◀/▶** **on the controller, then adjust the value with** **▲/▼**.

[Std.] (Standard)	For shooting various scenes with rich gradation and beautiful colors.
[Vivid] (Vivid)	The saturation and contrast are heightened for shooting striking images of colorful scenes and subjects such as flowers, spring greenery, blue sky, or ocean views.
[Port.] (Portrait)	For shooting the skin color in a soft tone, ideally suited to shooting portraits.
[Land.] (Landscape)	The saturation, contrast, and sharpness are heightened for shooting vivid and crisp scenery. Distant landscapes also stand out more.
[Sunset] (Sunset)	For shooting the beautiful red of the setting sun.
[B/W] (Black & White)	For shooting images in black and white monotone.

☉ (Contrast), 🌈 (Saturation), and 📏 (Sharpness) can be adjusted for each Creative Style item.

☉ (Contrast)	The higher the value selected, the more the difference of light and shadow is accentuated, thus making an impact on an image.
🌈 (Saturation)	The higher the value selected, the more vivid the color. When a lower value is selected, the color of the image is restrained and subdued.
📏 (Sharpness)	Adjusts the sharpness. The higher the value selected, the more the contours are accentuated, and the lower the value selected, the more the contours are softened.

Notes

- When the exposure mode is set to AUTO or Scene Selection, [Creative Style] is fixed to [Standard] and you cannot select other settings.
- When [Black & White] is selected, you cannot adjust the saturation.

Changing the range of color reproduction (Color Space)

The way colors are represented with combinations of numbers or the range of color reproduction is called “color space.” You can change the color space, depending on your purpose.

MENU button → 📷 **3** → **[Color Space]** → **Select the desired setting**





sRGB	This is the standard color space of the digital camera. Use sRGB in normal shooting, such as when you intend to print out the images without any modification.
AdobeRGB	This has a wide range of color reproduction. When a large part of the subject is vivid green or red, Adobe RGB is effective. <ul style="list-style-type: none"> • The file name of the image starts with “_DSC.”

Notes

- Adobe RGB is for applications or printers that support color management and DCF2.0 option color space. Using some applications or printers that do not support them may result in or print images that do not faithfully reproduce the color.
- When displaying images that were recorded with Adobe RGB on the camera or non-Adobe RGB-compliant devices, the images are displayed with low saturation.

Adjusting the color tones (White balance)

The color tone of the subject changes depending on the characteristics of the light source. The table below shows how the color tone changes based on various light sources, compared with a subject that appears white under the sunlight.

Weather/lighting	Daylight	Cloudy	Fluorescent	Incandescent
				
Characteristics of light	White	Bluish	Green-tinged	Reddish

White balance is a feature that adjusts the color tone to approximate what you see. Use this feature when the color tone of the image did not come out as you expected, or when you want to change the color tone on purpose for photographic expression.

Notes

- When the exposure mode is set to AUTO or Scene Selection, [White Balance] is fixed to [Auto WB] and you cannot select other modes.
- If the only light source available is a mercury lamp or a sodium lamp, the camera will not be able to acquire the accurate white balance because of the characteristics of the light source. Use the flash in such cases.

Adjusting the white balance to suit a specific light source (Auto/Preset white balance)

Fn button → AWB (White Balance) → Select the desired setting

- When [AWB] is not selected, you can fine tune the color tone with ◀/▶. Adjusting it toward + turns the image reddish and adjusting it toward – turns the image bluish.

AWB (Auto WB)	The camera automatically detects a light source and adjusts the color tones.
☀ (Daylight)	If you select an option to suit a specific light source, the color tones are adjusted for the light source (preset white balance).
🏠 (Shade)	
☁ (Cloudy)	
💡 (Incandescent)	
💡 (Fluorescent)	
WB (Flash)	

Shooting techniques

- Use the white balance bracket function if you cannot get the desired color in the selected option (page 122).
- When you select [5500K] (Color Temp.) or [0] (Color Filter), you can adjust the value to the desired value (below).
- When you select [Custom], you can register your setting (page 116).

Setting the color temperature and a filter effect (Color Temperature/Color Filter)

Fn button → AWB (White Balance) → [5500K] (Color Temp.) or [0] (Color Filter)

- To set the color temperature, select the value with ◀/▶.
- To set the color filter, select the compensation direction with ◀/▶.

Note

- Since color meters are designed for film cameras, the values differ under fluorescent/sodium lamp/mercury lamps. We recommend that you use the custom white balance or do a test shooting.

5500K*1 (Color Temp.)	Sets the white balance by the color temperature. The higher the number, the more reddish the image and the lower the number, the more bluish the image.
0*2 (Color Filter)	Achieves the effect of CC (Color Compensation) filters for photography. Based on using the set color temperature as the standard, the color can be compensated to G (Green) or M (Magenta).

*1 The value is the color temperature value currently selected.

*2 The value is the color filter value currently selected.

Registering the color tones (Custom white balance)

In a scene where the ambient light consists of multiple types of light source, use of custom white balance is recommended in order to accurately reproduce the whiteness.

1 Fn button → AWB (White Balance) →  (Custom)

2 Select [ SET] with ◀/▶ on the controller, then press the center of the controller.

3 Hold the camera so that the white area fully covers the AF area located in the center, and then press the shutter button down.

The shutter clicks and the calibrated values (ColorTemperature and Color filter) are displayed.

4 Press the center of the controller.

The monitor returns to the recording information display with the memorized custom white balance setting retained.

- The custom white balance setting registered in this operation is effective until a new setting is registered.
-

Note

- The message “Custom WB error” indicates that the value is beyond the expected range. (When the flash is used on a subject in close proximity or a subject with a bright color is in the frame.) If you register this value, the  indicator turns yellow on the recording information display on the LCD monitor. You can shoot at this point, but it is recommended that you set the white balance again to get a more correct white balance value.

To call the custom white balance setting

Fn button → AWB (White Balance) →  (Custom)

Note

- If the flash is used when the shutter button is pressed, a custom white balance is registered with the flash light taken into account. Take pictures with the flash in later shootings.

/ **Selecting the drive mode**

This camera has seven drive modes, such as single-shot advanced, and continuous advanced. Use them to suit your purpose.

Shooting single shot

This mode is for normal shooting.



 /  **button** →  **(Single-shot Adv.)**

Note

- When the exposure mode is set to [Sports Action] in Scene Selection, you cannot shoot single shot.

Shooting continuously

The camera records the images continuously at the following speeds*.

	 Hi	 Lo
Live View mode	–	Maximum 3 images per second
Viewfinder mode	Maximum 5 images per second	Maximum 3 images per second
Focus check Live View	Maximum 5 images per second	–

* Our measurement conditions. The speed of continuous shooting is slower, depending on shooting conditions.

1  /  **button** →  **(Continuous adv.)** → **Select the desired speed**

2 Adjust the focus and shoot the subject.

- When you press and hold the shutter button, the recording continues.
-



The maximum number of continuous shots

The number of continuous shooting images obtainable has an upper limit.

	DSLR-A580	DSLR-A560
Fine	44 images	27 images
Standard	45 images	47 images
RAW & JPEG	20 images	7 images
RAW	22 images	7 images

To shoot continuously at higher speeds

The camera shoots continuously at a maximum of seven images per second. The exposure and focus are set at the first shot.

 button →  (**Speed Priority Cont.**)

Notes

- You cannot shoot images continuously when “0” flashes in the viewfinder. Wait until the indicator disappears.
- You cannot shoot continuously when using Scene Selection modes other than [Sports Action].
- When [Face Detection] is set to [On], the speed of continuous shooting may be slower.

Using the self-timer

The 10-second self-timer is convenient when the photographer appears in a photo and the 2-second self-timer is convenient to reduce the camera shake because the mirror is raised first.

1 button → (**Self-timer**) → **Select the desired setting**

- The number after  is the number of seconds that is currently selected.

2 **Adjust the focus and shoot the subject.**

- When the self-timer is activated, audio signals and the self-timer lamp indicate the condition. The self-timer lamp flashes quickly and the audio signal sounds quickly right before the shooting.

To cancel the self-timer

Press the  /  button.

Notes

- When you shoot images using the viewfinder, use the eyepiece cover (page 34).
- Do not aim the lens at the sun during the 2-second self-timer. The heat of the sun burns the shutter curtain and this results in shutter curtain damage.

Shooting images with the exposure shifted (Exposure bracket)



Base exposure



- direction



+ direction

Bracket shooting allows you to shoot several images, each with different degrees of exposure. Specify the value of deviation (steps) from the base exposure, and the camera shoots three images while automatically shifting the exposure. Press and hold the shutter button until the shooting stops. When the flash is fired, flash bracket shooting is used to shift the amount of flash light. To shoot, press the shutter button shot by shot.

1  /  button → **BRK C (Bracket: Cont.)** → **Select the desired bracket step**

2 Adjust the focus and shoot the subject.





The base exposure is set at the first shot in the bracket.

- Press and hold the shutter button until recording stops. In flash bracket shooting, press the shutter button three times.
-

Notes

- When the mode dial is set to M, the exposure is shifted by adjusting the shutter speed.
- When you adjust the exposure, the exposure is shifted based on the compensated value.
- The bracket cannot be used when the exposure mode is set to AUTO or Scene Selection.

The EV scale in bracket shooting

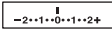
	Ambient light* bracket 0.3 steps, three shots Exposure compensation 0	Flash bracket 0.7 steps, three shots Flash compensation -1.0
LCD monitor (Live View mode)		
LCD monitor (Viewfinder mode/Standard Display)	 Shown in the top row.	 Shown in the bottom row.
Viewfinder		

* Ambient light: Any light other than the flash light that shines on the scene for an extended period of time, such as natural light, a light bulb, or a fluorescent light.

- In bracket shooting, the same number of indices as the number of recordable images is displayed on the EV scale. However, in flash bracket shooting, the indices are not displayed in the viewfinder.
- When the bracket shooting starts, the indices that indicate already recorded images start to disappear one by one.

Shooting with white balance shifted (WB bracket)

Based on the selected white balance, and the color temperature/color filter, three images are recorded with the white balance shifted.

1 button → **BRKWB (WB bracket)** → **Select the desired setting**

- When Lo is selected, it is shifted by 10 mired*, and when Hi is selected, it is shifted by 20 mired.

2 **Adjust the focus and shoot the subject.**

* Mired: a unit to indicate the color conversion quality in color temperature filters.

Shooting with the Wireless Remote Commander

You can shoot using the SHUTTER and 2SEC (the shutter is released after 2 seconds) buttons on the RMT-DSLR1 Wireless Remote Commander (sold separately). Also, refer to the operating instructions supplied with the Wireless Remote Commander.

1 button → (Remote Cdr.)

2 **Focus on the subject, point the transmitter of the Wireless Remote Commander to the remote sensor, and shoot the image.**

Note

- When you shoot images using the viewfinder, use the eyepiece cover (page 34).

Playing back images

The last recorded image is displayed on the LCD monitor.

1 Press the  button.

DISP button

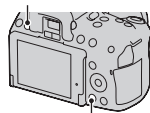

 button

2 Select an image with   on the controller.

To return to the shooting mode

Press the  button again.

To switch the recording data display

Press the DISP button.

Each time you press the DISP button, the screen changes as follows.

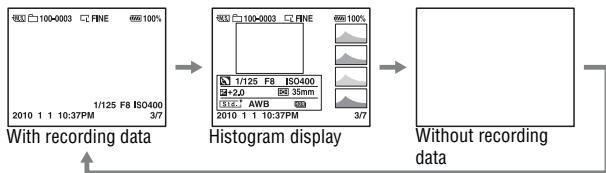

To select the folder to be played back

MENU button →  **2** → [Select Folder] → Select the desired folder

To select the orientation when playing back an image recorded in the portrait position

MENU button →  **2** → [Playback Display] → Select the desired setting

Note

- When you play back the image on a TV or a computer, the image will be displayed in the portrait position even if [Manual Rotate] is selected.

To scroll panoramic images

Select a panoramic image, then press the center of the controller. Pressing it again pauses the playback.

3D Sweep Panorama images cannot be scrolled. Scrolling playback is not available for images that were recorded with [3D Pan.: Image Size] set to [16:9].

Playing back movies

1 MENU button →  1 → [Still/Movie Select] → [Movie]

2 Select the desired movie with ◀/▶ on the controller, then press the center of the controller.

During movie playback	Controller/control dial operation
To pause/resume	●
To fast-forward	▶
To fast-rewind	◀
To slow-forward	Rotate the control dial to the right during pause
To slow-reverse	Rotate the control dial to the left during pause
To adjust sound volume	▲/▼

To adjust the volume

MENU button →  1 → [Volume Settings] → Select the desired value

To select the date of movies to be played back

Movies are stored by date.

MENU button →  **2** → **[Select Date]** → **Select the desired date**

Note

- Movies recorded with other devices may not be played back on this camera.

Rotating an image

1 Display the image you want to rotate, then press the  button.

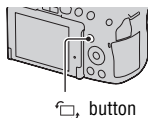

2 Press the center of the controller.

The image is rotated counter-clockwise. When you want to do another rotation, repeat step 2.

- Once you rotate the image, the image is played back in the rotated position, even if you turn off the power.

To return to the normal playback screen

Press the  button.

Notes

- You cannot rotate movies.
- When you copy rotated images to a computer, “PMB” contained on the CD-ROM (supplied) can display the rotated images correctly. However, the images may not be rotated depending on the software.

Enlarging images

A still image can be enlarged for closer examination. This is convenient to check the focus condition of a recorded image.

1 Display the image you want to enlarge, then press the **+** button.

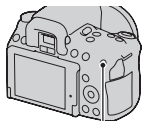

+ button

2 Zoom the image in or out with the **+** button or **-** button.

- Rotating the control dial switches the image at the same display magnification. When you shoot multiple images with the same composition, you can compare their focus conditions.

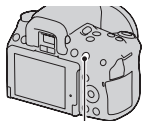

- button

3 Select the portion you want to enlarge with **▲/▼/◀/▶** on the controller.

To cancel the enlarged playback

Press the **▶** button so that the image returns to the normal size.

Scaling range

The scaling range is as follows.

Image size	Scaling range	
	DSLR-A580	DSLR-A560
L	Approx. $\times 1.1 - \times 11.8$	Approx. $\times 1.1 - \times 11.8$
M	Approx. $\times 1.1 - \times 8.8$	Approx. $\times 1.1 - \times 8.0$
S	Approx. $\times 1.1 - \times 6.0$	Approx. $\times 1.1 - \times 5.5$

Switching to the display of the image list

1 Press the button.

The screen changes to the image index screen.

 button



2 Press the DISP button repeatedly to select the desired screen format.

- The screen changes in the following order: 9 images → 4 images

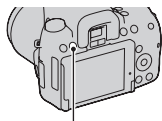





DISP button

To return to the single-image screen

Press the  button or the center of the controller when you select the desired image.

To turn to the movie index screen

To display movies on the image index screen, select  (movie) on the tab with /// on the controller, then press the center of the controller.





Still image/movie switching tab

Playing back images automatically (Slide show)

MENU button → 1 → [Slide Show] → [Enter]

Plays back recorded images in order (Slide show). The slide show automatically stops after all the images have been played back.

- You can view the previous/next image with / on the controller.
- You cannot pause the slide show.

To end in the middle of the slide show

Press the center of the controller.

To choose the interval between the images in slide show

MENU button →  **1** → **[Slide Show]** → **[Interval]** → **Select the desired number of seconds**

To play back repeatedly

MENU button →  **1** → **[Slide Show]** → **[Repeat]** → **[On]**

To play back movies

You cannot play back still images and movies in the same slide show. Switch to a movie playback with [Still/Movie Select], then select the movie type.

MENU button →  **1** → **[Slide Show]** → **[Movie Type]** → **Select the desired movie type**

To play back 3D-images only

If you connect the camera to a 3D-compatible TV using an HDMI cable (sold separately), you can play back 3D-images recorded with the 3D Sweep Panorama mode. For details on 3D-shooting, see page 194. Also refer to the operating instructions supplied with the TV.

MENU button →  **1** → **[Slide Show]** → **[Image Type]** → **[Display 3D Only]**

Checking the information of recorded images

Each time you press the DISP button, the information display changes (page 123).

Basic information display

Still image

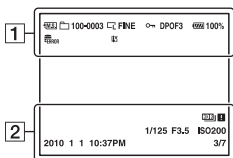



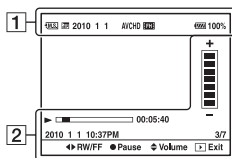

Movie



1

Display	Indication
	Memory card (27)
	Still image/Movie
100-0003	Folder - file number (165)
2010 1 1	Recording date
 	Image size of still images (140)/Aspect ratio of still images (142)/Image size of Sweep Shooting (141)
RAW RAW+J FINE STD	Image quality of still images (142)
	Protect (133)

Display	Indication
	DPOF set (171)
	Remaining battery warning (23)
100%	Remaining battery (23)
	Database file full (188)/ Database file error (188)
	Overheating warning (188)
AVCHD MP4	Movie file format (82)
	Image size of movies (141)

Display	Indication
2010 1 1 10:37AM	Date of recording
	Auto HDR image warning (110)
1/125	Shutter speed (75)
F3.5	Aperture (72)
ISO200	ISO sensitivity (108)
3/7	File number/total number of images
	Playback
	Playback bar
00:05:40	Counter
	Volume

Histogram display

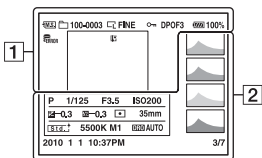

1

Display	Indication
	Memory card (27)
	Still image
100-0003	Folder - file number (165)
	Image size of still images (140)/Aspect ratio of still images (142)/Image size of Sweep Shooting (141)
RAW RAW+J FINE STD	Image quality of still images (142)
	Protect (133)
DPOF3	DPOF set (171)
	Remaining battery warning (23)
	Remaining battery (23)
	Database file full (188)/Database file error (188)
	Overheating warning (188)

2

Display	Indication
	Histogram* (104)
	Exposure mode (61 – 80)
1/125	Shutter speed (75)
F3.5	Aperture (72)
ISO200	ISO sensitivity (108)
-0.3	Exposure compensation (103)
-0.3	Flash compensation (105)
	Metering mode (107)
35mm	Focal length (176)
	Creative Style (112)
AWB +1 5500K M1	White balance (Auto, Preset, Color temperature, Color filter, Custom) (114)
D-R OFF 	D-Range Optimizer (109)/Auto HDR/Auto HDR image warning (110)

Display	Indication
2010 1 1 10:37AM	Date of recording
3/7	File number/total number of images

* When the image has a high-key or low-key portion, that portion is flashed on the histogram display (Luminance limit warning).

Protecting images (Protect)

You can protect images against accidental erasure.

Protecting selected images/canceling the protection of the selected images

1 MENU button →  1 → [Protect] → [Multiple Img.]

2 Select the image you want to protect with ◀/▶ on the controller, then press the center of the controller.

A  mark appears on the selected image.

- To cancel a selection, press the center again.

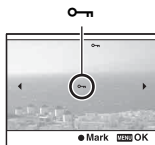

3 To protect other images, repeat step 2.

4 Press the MENU button.

5 Select [Enter] with ▲, then press the center of the controller.

To cancel the protection of all the images or movies

You can cancel the protection of all the images in the folder currently selected or of all the movies with the same date.

MENU button →  1 → [Protect] → [Cancel All Images] or [Cancel All Movies]

Deleting images (Delete)

Once you have deleted an image, you cannot restore it. Check whether to delete the image or not beforehand.

Note

- Protected images cannot be deleted.

Deleting the image that is currently displayed

- 1 Display the image you want to delete and press the  button.

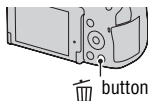

- 2 Select [Delete] with **▲** on the controller, then press the center of the controller.

Deleting the selected images

- 1 MENU button →  1 → [Delete] → [Multiple Img.]

- 2 Select the images you want to delete with the controller, then press the center of the controller.

A  mark appears on the selected image.

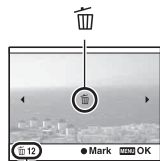

Total number

- 3 To delete other images, repeat step 2.

- 4 Press the MENU button.

5 Select [Delete] with ▲, then press the center of the controller.

Deleting all the images in the folder

Deletes all still images in the folder. This appears during still image playback only.

1 MENU button →  1 → [Delete] → [All in Folder]

2 Select [Delete] with ▲ on the controller, then press the center of the controller.

Deleting all the movies with the same date

Deletes all movies of that date. This appears during movie playback only.

1 MENU button →  1 → [Delete] → [All in Date Rng.]

2 Select [Delete] with ▲ on the controller, then press the center of the controller.

Viewing images on a TV screen

To view images recorded on the camera on a TV set, an HDMI cable (sold separately) and an HD TV equipped with an HDMI connector are required.

1 Turn off both your camera and the TV, and connect the camera to the TV.

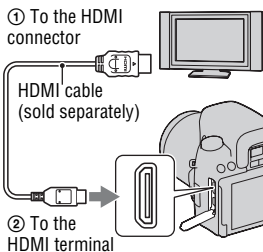

2 Turn on the TV and switch the input.

- See also the operating instructions supplied with the TV.

3 Turn on the camera.

Images shot with the camera appear on the TV screen.

Select the desired image with ◀/▶ on the controller.

- The LCD monitor on the camera does not turn on.

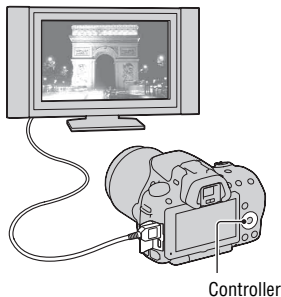

Notes

- Use an HDMI cable with the HDMI logo.
- Use an HDMI mini connector on one end (for the camera), and a connector suitable for connection to your TV on the other end.
- Some devices may not work properly.

- Do not connect the output connector of the device with the HDMI terminal on the camera. This may cause a malfunction.

On “PhotoTV HD”

This camera is compatible with the “PhotoTV HD” standard.

By connecting Sony’s PhotoTV HD-compatible devices using an HDMI cable, a whole new world of photos can be enjoyed in breathtaking Full HD quality.

“PhotoTV HD” allows for a highly-detailed, photo-like expression of subtle textures and colors.

To view 3D-images with a 3D-compatible TV

When an image recorded with the 3D Sweep Panorama mode is being played back, press ▼ on the controller to play back the image with a 3D effect on the TV screen.

To view 3D-images only

You can only play back images recorded with the 3D Sweep Panorama mode.

MENU button →  **1** → [3D Viewing]

Using “BRAVIA” Sync

By connecting the camera to a TV that supports “BRAVIA” Sync using an HDMI cable, you can operate the camera with the TV Remote Control.

1 Connect a TV that supports “BRAVIA” Sync to the camera (page 136).

The input is automatically switched and the image shot with the camera appears on the TV screen.

2 Press the SYNC MENU button on the TV Remote Control.

3 Operate with the buttons on the TV Remote Control.

The items for Sync Menu

Slide Show	Plays back images automatically (page 127).
1 Image Display	Returns to the single-image screen.
Still/Movie Select	Selects still images or movies to be played back.
Image Index	Switches to the image index screen.
3D Viewing	Plays back 3D-images when connected to a 3D-compatible TV.
Select Folder	Selects the folder of images to be played back.
Select Date	Selects the date of movies to be played back.
Delete	Deletes images.

Notes

- The operations available are restricted when the camera is connected to a TV using an HDMI cable.
- Only TVs that support “BRAVIA” Sync can provide these operations. The SYNC Menu operations differ depending on the TV connected. For details, refer to the operating instructions supplied with the TV.
- If the camera performs unnecessary operations in response to the TV Remote Control when the camera is connected to another manufacturer’s TV using an HDMI connection, set [CTRL FOR HDMI] in the  Setup menu to [Off].

To use your camera abroad

When you view images on a TV screen, the camera and TV must use the same TV color system.

NTSC system (1080 60i)

Bahama Islands, Bolivia, Canada, Central America, Chile, Colombia, Ecuador, Jamaica, Japan, Korea, Mexico, Peru, Surinam, Taiwan, the Philippines, the U.S.A., Venezuela, etc.

PAL system (1080 50i)

Australia, Austria, Belgium, China, Croatia, Czech Republic, Denmark, Finland, Germany, Holland, Hong Kong, Hungary, Indonesia, Italy, Kuwait, Malaysia, New Zealand, Norway, Poland, Portugal, Rumania, Singapore, Slovak Republic, Spain, Sweden, Switzerland, Thailand, Turkey, United Kingdom, Viet Nam, etc.

PAL-M system (1080 50i)

Brazil

PAL-N system (1080 50i)

Argentina, Paraguay, Uruguay

SECAM system (1080 50i)

Bulgaria, France, Greece, Guiana, Iran, Iraq, Monaco, Russia, Ukraine, etc.

Setting image size and image quality

Image: Size

MENU button →  **1** → **[Image: Size]** → **Select the desired size**

[Image: Aspect Ratio]: [3:2]

DSLR-A580

Image size		Usage guidelines
L:16M	4912 × 3264 pixels	For prints up to A3+ size
M:8.4M	3568 × 2368 pixels	For prints up to A4 size
S:4.0M	2448 × 1624 pixels	For prints L/2L size

DSLR-A560

Image size		Usage guidelines
L:14M	4592 × 3056 pixels	For prints up to A3+ size
M:7.4M	3344 × 2224 pixels	For prints up to A4 size
S:3.5M	2288 × 1520 pixels	For prints L/2L size

[Image: Aspect Ratio]: [16:9]

DSLR-A580

Image size		Usage guidelines
L:14M	4912 × 2760 pixels	For viewing on a high-definition TV
M:7.1M	3568 × 2000 pixels	
S:3.4M	2448 × 1376 pixels	

DSLR-A560

Image size		Usage guidelines
L:12M	4592 × 2576 pixels	For viewing on a high-definition TV
M:6.3M	3344 × 1872 pixels	
S:2.9M	2288 × 1280 pixels	

Note



- When you select a RAW image with [Image: Quality], the image size of the RAW image corresponds to L. This size is not displayed on the screen.

Setting the size of panoramic images



You can set the image size of panoramic images. The image size varies depending on the setting of the shooting direction (page 68).

MENU button →  **2** → **[Panorama: Size]** or **[3D Pan.: Image Size]** → **Select the desired size**

[Panorama: Size]

 STD (Standard)	Vertical: 3872 × 2160 Horizontal: 8192 × 1856
 WIDE (Wide)	Vertical: 5536 × 2160 Horizontal: 12416 × 1856

[3D Pan.: Image Size]

 16:9 (16:9)	Horizontal: 1920 × 1080
 STD (Standard)	Horizontal: 4912 × 1080
 WIDE (Wide)	Horizontal: 7152 × 1080

Movie: Size



The larger the image size, the higher the image quality.

MENU button →  **1** → **[Movie: Size]** → **Select the desired size**

[AVCHD] mode

 FH (1920 × 1080)	17 Mbps: Records with the highest image quality for viewing on a high-definition TV.
---	--

[MP4] mode

 1080 (1440 × 1080)	12 Mbps: Records with high image quality for viewing on a high-definition TV.
 VGA (VGA) (640 × 480)	3 Mbps: Records in the suitable size for WEB uploads.

Note

- A telephoto image results except when the [VGA] image size is selected for movies (DSLR-A560 only).

Image: Aspect Ratio

MENU button →  **1** → **[Image: Aspect Ratio]** → **Select the desired ratio**

3:2	A normal ratio.
16:9	An HDTV ratio.

Note

- This item cannot be set when the exposure mode is set to Sweep Shooting.

Image: Quality

MENU button →  **1** → **[Image: Quality]** → **Select the desired setting**

RAW (RAW)	File format: RAW (Records using the RAW compression format.) This format does not perform any digital processing on the images. Select this format to process images on a computer for professional purposes. <ul style="list-style-type: none">• The image size is fixed to the maximum size. The image size is not displayed on the screen.
RAW+J (RAW & JPEG)	File format: RAW (Records using the RAW compression format.) + JPEG A RAW image and a JPEG image are created at the same time. This is suitable when you need two image files, a JPEG for viewing, and a RAW for editing. <ul style="list-style-type: none">• The image quality is fixed to [Fine] and the image size is fixed to [L].
FINE (Fine)	File format: JPEG
STD (Standard)	The image is compressed in the JPEG format when recorded. Since the compression rate of STD (Standard) is higher than that of FINE (Fine), the file size of STD is smaller than that of FINE . This will allow more files to be recorded on one memory card, but the image quality will be lower.

Notes

- This item cannot be set when the exposure mode is set to Sweep Shooting.
- For details on the number of images that can be taken when the image quality is changed, see page 35.

About RAW images

You need the “Image Data Converter SR” software included on the CD-ROM (supplied) in order to open a RAW image recorded on this camera. With this software, a RAW image can be opened and converted to a common format, such as JPEG or TIFF, and its white balance, color saturation, contrast, etc., can be readjusted.

- The RAW format image cannot be printed using a DPOF (print) designated printer.
- You cannot set [Auto HDR] on RAW format images.

Setting the method for recording on a memory card

Selecting the method for assigning file numbers to images

MENU button →  **1** → **[File Number]** → **Select the desired setting**

Series	The camera does not reset numbers and assigns numbers to files in sequence until the number reaches “9999.”
Reset	The camera resets numbers in the following cases and assigns numbers to files from “0001.” When the recording folder contains a file, a number one higher than the largest number is assigned. <ul style="list-style-type: none">– When the folder format is changed.– When all the images in the folder are deleted.– When the memory card is replaced.– When the memory card is formatted.

Selecting the folder name format

The recorded still images are stored in automatically-created folders in the DCIM folder of the memory card.

MENU button →  **1** → **[Folder Name]** → **Select the desired setting**

Standard Form	The folder name format is as follows: folder number + MSDCF. Example: 100MSDCF
Date Form	The folder name format is as follows: folder number + Y (the last digit)/MM/DD. Example: 10000405 (Folder name: 100, date: 2010/04/05)

Note

- The movie folder form is fixed as “folder number + ANV01.”

Creating a new folder

You can create a folder in a memory card for recording images. A new folder is created with a number incremented one higher than the largest number currently used, and the folder becomes the current recording folder. A folder for still images and a folder for movies are created at the same time.

MENU button →  **1** → **[New Folder]**

Notes

- When you insert a memory card that was used with other equipment into the camera and shoot images, a new folder may be automatically created.
- Up to 4 000 images can be stored in a folder. When the folder capacity is exceeded, a new folder is created automatically.

Selecting the recording folder

When a standard form folder is selected and there are two or more folders, you can select the recording folder to be used to record images.

MENU button →  **1** → **[Select REC Folder]** → **Select the desired folder**

Notes

- You cannot select the folder when you select the setting [Date Form].
- Movie (MP4) files are stored in the folder that has the same folder number as the folder you selected for still images.

Formatting the memory card

Note that formatting irrevocably erases all data on a memory card, including protected images.

MENU button →  **1** → **[Format]** → **[Enter]**

Notes

- During the format, the access lamp lights up. Do not eject the memory card while the lamp is lit.
- Format the memory card using the camera. If you format it on a computer, the memory card may not be usable with the camera, depending on the format type used.

- Formatting may take several minutes depending on the memory card.

Recovering image database

When inconsistencies are found in the image database file of movies, caused by processing movies on computers, etc., movies on the memory card will not be played back in this form. If this happens, the camera repairs the file.

MENU button →  **1** → **[Recover Image DB]** → **[Enter]**

Note

- Use a sufficiently charged battery. Low battery power during repairing can cause damage to data.

Checking the remaining space of the card

Displays the remaining recording time of movies and the number of recordable still images on the memory card.





MENU button →  **1** → **[Display Card Space]**

Setting the upload function for an Eye-Fi card



Sets whether or not you use the upload function when using an Eye-Fi card (commercially available). This item appears when an Eye-Fi card is inserted in the camera.

MENU button →  **2** → **[Upload Settings]** → **Select the desired setting**

The status indicators in communication

	Standby. No images are to be sent.
	Upload standby.
	Connecting.
	Uploading.
	Error

Notes

- Before using an Eye-Fi card, set up the wireless LAN access point and forwarding destination. For details, refer to the operating manual supplied with the Eye-Fi card.
- Eye-Fi cards are sold in the U.S.A, Canada, Japan, and some countries in the EU (as of May in 2010).
- For more information, please contact the manufacturer or vendor directly.
- Eye-Fi cards can be used only in the countries/regions where they were purchased. Use Eye-Fi cards in accordance with the law of the countries/regions where you purchased the card.
- Eye-Fi cards include a wireless LAN function. Do not insert any Eye-Fi cards in the camera when it is prohibited to do so, such as on an airplane. If there is an Eye-Fi card inserted in the camera, set [Upload Settings] to [Off].  OFF is displayed on the screen when [Upload Settings] is set to [Off].
- When you use a brand-new Eye-Fi card for the first time, copy the install file of Eye-Fi manager recorded on the card to your computer before formatting the card.
- Use an Eye-Fi card after updating the firmware to the latest version. For details, refer to the manual that comes with the Eye-Fi card.
- The power save function of the camera does not work while it is uploading images.
- If  (error) is displayed, remove the memory card and reinsert it, or turn off then turn on the power again. If  appears again, the Eye-Fi card may be damaged.
- Wi-Fi network communication may be influenced by other communication devices. If the communication status is poor, move closer to the access point of the Wi-Fi network.
- For details on the file types that can be uploaded, refer to the operating instructions supplied with the Eye-Fi card.
- This product does not support the Eye-Fi “Endless Memory Mode.” Make sure that Eye-Fi cards that you insert into this product have “Endless Memory Mode” turned off.

Changing the noise reduction setting

Disabling the noise reduction during long exposure shootings

When you set the shutter speed to a second or longer (Long exposure shooting), noise reduction is turned on for the same duration that the shutter is open.

This is to reduce the grainy noise typical in a long exposure. When noise reduction is in progress, a message appears and you cannot take another picture. Select [On] to prioritize the image quality. Select [Off] to prioritize the timing of shooting.

MENU button →  **3** → [Long Exposure NR] → [Off]

Notes

- When the exposure mode is set to Sweep Shooting, or continuous shooting, continuous bracketing, [Hand-held Twilight] in Scene Selection, or ISO is set to [Multi Frame Noise Reduct.], noise reduction is not performed even when it is set to [On].
- When the exposure mode is set to AUTO or Scene Selection, you cannot turn off noise reduction.

Setting the noise reduction at high ISO sensitivity settings

The camera reduces the noise that becomes more noticeable when the camera sensitivity is high.

Select [Auto] to prioritize the image quality. Select [Weak] to prioritize the timing of shooting.

MENU button →  **3** → [High ISO NR] → **Select the desired setting**

Notes

- [Weak] is selected automatically for continuous shooting or continuous bracketing images, even when you set it to [Auto].
- When the exposure mode is set to AUTO, Sweep Shooting, or Scene Selection, you cannot select [Weak].
- Noise reduction is not performed on RAW images.

Changing the function of the buttons

Changing the operation of the AEL button

The function of the AEL button can be selected from the following two functions:

- Holding the locked exposure value by pressing the AEL button while the button is held down ([Hold]).
- Holding the locked exposure value by pressing the AEL button until the button is pressed again ([Toggle]).

MENU button →  **1** → **[AEL]** → **Select the desired setting**

Notes

- While the exposure value is locked,  appears on the LCD monitor and in the viewfinder. Be careful not to reset the setting.
- The [Hold] and [Toggle] settings affect the manual shift (page 78) in the manual exposure mode.
- When [Toggle] is selected, be sure to press the AEL button again to release the lock.

Changing the function of the AEL button

The function of the AEL button in focus check Live View mode can be selected between [Focus Magnifier] (default setting) and [AEL].

MENU button →  **1** → **[Func. of AEL button]** → **Select the desired setting**

Changing the function of a focus hold button to the preview function

If you use a lens equipped with a focus hold button, you can change the function of the button to preview a shot.

MENU button →  **1** → **[Focus Hold Button]** → **[D.O.F.Preview]**

Changing other settings

Setting the sound on/off

Selects the sound produced when the shutter is locked, during self-timer countdown, etc.

MENU button →  **2** → [Audio signals] → **Select the desired setting**

Removing the Help Guide from the screen

You can turn off the Help Guide that is displayed when you operate the camera. This is convenient when you want to perform the next operation quickly.

MENU button →  **1** → [Help Guide Display] → [Off]

Setting the time to turn the camera to the power save mode

You can set different time intervals for the camera to switch to power save mode (Power Save) for the Live View (LV) and viewfinder modes (OVF). Pressing the shutter button halfway down returns the camera to the shooting mode.

MENU button →  **1** [Power Save (LV)] or [Power Save (OVF)]
→ **Select the desired time**

Note

- Regardless of the setting here, the camera turns to power save mode after 30 minutes when the camera is connected to a TV or the drive mode is set to [Remote Cdr.].

Releasing the shutter when no lens is attached

You can release the shutter when no lens is attached. Select this when you attach the camera on an astronomical telescope, etc.

MENU button →  **1** → [Release w/oLens] → [Enable]

Note

- Correct metering cannot be achieved when you use lenses that do not provide a lens contact, such as the lens of an astronomical telescope. In such cases, adjust the exposure manually by checking it on the recorded image.

Selecting the language

MENU button →  **1** → [ **Language**] → **Select the language**

Setting the demonstration playback of a movie

You can set the camera to start the demonstration playback of a movie if you do not operate the camera for about one minute.

MENU button →  **2** → [**Demo Mode**] → [**On**]

Setting the LCD monitor

Setting the brightness of the LCD monitor

The brightness of the LCD monitor is automatically adjusted to the surrounding lighting conditions using the light sensor (page 15).

You can set the brightness of the LCD monitor manually.

MENU button →  **1** → **[LCD Brightness]** → **Select the desired setting**

Notes

- When it is set to [Auto], do not cover the light sensor with your hand and so on.
- When using the camera with the AC-PW10AM AC Adaptor (sold separately), the brightness of LCD monitor is always set to the brightest setting even if you select [Auto].

Setting the displayed time of the image right after shooting (Auto review)

You can check the recorded image on the screen right after the shooting. You can change the displayed time.

MENU button →  **2** → **[Auto Review]** → **Select the desired setting**

Note

- In auto review, the image will not be displayed in the vertical position even if [Playback Display] is set to [Auto Rotate] (page 123).

Keeping the LCD monitor tuned on while looking into the viewfinder

When the LIVE VIEW/OVF switch is set to “OVF,” looking into the viewfinder turns off the LCD monitor.

In the default setting, while looking into the viewfinder, the LCD monitor is turned off to prevent the battery pack from wearing down.

If you want to turn on the LCD monitor while looking into the viewfinder, select [Off].

MENU button → **⚙ 1** → **[Auto off w/ VF]** → **[Off]**

Setting the grid line

The grid line is an auxiliary line for shooting composition. You can set the grid line to on/off or select the type of grid line. The available range of movie recording is also displayed.

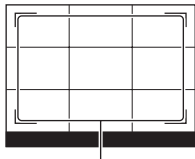

Available range of movie recording

MENU button → **⚙ 2** → **[Grid Line]** → **Select the desired setting**

Note

- The grid line is displayed only when the camera is in the auto review (page 152) or focus check Live View mode.

Confirming the version of the camera

Displays the version of your camera. Confirm the version when a firmware update is released.

MENU button →  **2** → **[Version]**

Note

- An update can be performed only when the battery level is 50% or more. We recommend that you use a sufficient battery or the AC-PW10AM AC Adaptor (sold separately).

Resetting to the default

You can reset the main functions of the camera.

MENU button → **2** → **[Reset Default]** → **[Enter]**

The items to be reset are as follows.

Items	Reset to
Exposure compensation (103)	±0.0
Recording information display (42)	Graphic Display
Playback display (123)	Single-image screen (with recording information)
Drive mode (118)	Single-shot Adv.
Flash Mode (98)	Fill-flash (differs based on whether the built-in flash is open or not)
Autofocus Mode (88)	AF-A
AF area (89)	Wide
Face Detection (95)	On
Smile Shutter (96)	Off
ISO (108)	AUTO
Metering Mode (107)	Multi segment
Flash Compensation (105)	±0.0
White Balance (114)	AWB (Auto white balance)
Color Temp./Color Filter (115)	5500K, Color Filter 0
Custom white balance (116)	5500K
DRO/Auto HDR (109)	D-Range Optimizer: Auto
Creative Style (112)	Standard
Scene Selection (63)	Portrait
Sweep Shooting (66)	Sweep Panorama

Recording menu

Items	Reset to
Image: Size (140)	L: 16M (DSLR-A580)/ L: 14M (DSLR-A560)
Image: Aspect Ratio (142)	3:2
Image: Quality (142)	Fine

Items	Reset to
Movie: Size (141)	1920 × 1080
Movie: File Format (82)	AVCHD
Movie: Audio Rec. (83)	On
SteadyShot (59)	On
Panorama: Size (141)	Standard
Panorama: Direction (68)	Right
3D Pan.: Image Size (141)	Standard
3D Pan.: Direction (69)	Right
Flash control (106)	ADI flash
AF Illuminator (100)	Auto
AF method (91)	Contrast AF
Color Space (113)	sRGB
Long Exposure NR (148)	On
High ISO NR (148)	Auto

Custom menu

Items	Reset to
Eye-Start AF (41)	Off
Func. of AEL button (149)	Focus Magnifier
AEL (149)	Hold
Focus Hold Button (149)	Focus Hold
Red Eye Reduction (100)	Off
Release w/oLens (150)	Disable
Auto off w/ VF (153)	On
Grid Line (153)	Off
Histogram (104)	Off
Auto Review (152)	Off

Playback menu

Items	Reset to
Slide Show – Repeat (127)	Off
Slide Show – Interval (127)	3 sec
Slide Show – Image Type (127)	All

Items	Reset to
Specify Printing – Date Imprint (172)	Off
Volume Settings (124)	2
Playback Display (123)	Auto Rotate

Memory Card Tool menu

Items	Reset to
File Number (144)	Series
Folder Name (144)	Standard Form

Setup menu

Items	Reset to
LCD Brightness (152)	Auto
Power Save (LV) (150)	1 Min
Power Save (OVF) (150)	10 Sec
CTRL FOR HDMI (137)	On
Help Guide Display (150)	On
USB Connection (164)	Mass Storage
Upload Settings (146)	On
Audio signals (150)	On
Demo Mode (151)	Off

Using with your computer

Following applications are contained on the CD-ROM (supplied) to allow more versatile use of images shot with your camera.

- Sony Image Data Suite
 - “Image Data Converter SR”
 - “Image Data Lightbox SR”
- “PMB” (Picture Motion Browser)

Note

- “PMB” is not compatible with Macintosh computers.

Recommended computer environment (Windows)

The following computer environment is recommended when using the supplied software and importing images via a USB connection.

OS (pre-installed)	Microsoft Windows XP ^{*1} SP3/Windows Vista ^{*2} SP2/ Windows 7
“PMB”	CPU: Intel Pentium III 800 MHz or faster (For playing/editing the High Definition movies: Intel Core Duo 1.66 GHz or faster/Intel Core 2 Duo 1.66 GHz or faster) Memory: 512 MB or more (For playing/editing the High Definition movies: 1 GB or more) Hard Disk: Disk space required for installation-approximately 500 MB Display: Screen resolution-1024 × 768 dots or more
“Image Data Converter SR Ver.3” “Image Data Lightbox SR”	CPU/Memory: Pentium 4 or faster/1 GB or more Display: 1024 × 768 dots or more

*1 64-bit editions and Starter (Edition) are not supported. Windows Image Mastering API (IMAPI) Ver.2.0 or later is required to use the function for creating discs.

*2 Starter (Edition) is not supported.

Recommended computer environment (Macintosh)

The following computer environment is recommended when using the supplied software and importing images via a USB connection.

OS (pre-installed)	USB Connection: Mac OS X (v10.3, 10.4, 10.5, 10.6) “Image Data Converter SR Ver.3”/“Image Data Lightbox SR”: Mac OS X (v10.4, 10.5, 10.6 (Snow Leopard))
“Image Data Converter SR Ver.3” “Image Data Lightbox SR”	CPU: Power PC G4/G5 series (1.0 GHz or faster is recommended)/Intel Core Solo/Core Duo/Core 2 Duo or faster Memory: 1 GB or more is recommended. Display: 1024 × 768 dots or more

Notes

- Operation is not assured in an environment based on an upgrade of the operating systems described above or in a multi-boot environment.
- If you connect two or more USB devices to a single computer at the same time, some devices, including the camera, may not operate, depending on the types of USB devices you are using.
- Connecting the camera using a USB interface that is compatible with Hi-Speed USB (USB 2.0 compliant) allows advanced transfer (high speed transfer), as the camera is compatible with Hi-Speed USB (USB 2.0 compliant).
- When your computer resumes activity from suspend or sleep mode, communication between the camera and your computer may not recover at the same time.

Using the software

Installing the software (Windows)

Log on as Administrator.

1 Turn on your computer, and insert the CD-ROM (supplied) into the CD-ROM drive.

The installation menu screen appears.

- If it does not appear, double-click [Computer] (For Windows XP: [My Computer]) →  (SONYPMB) → [Install.exe].
 - If the AutoPlay screen appears, select “Run Install.exe” and follow the instructions that appear on the screen to proceed with the installation.
-

2 Click [Install].

Make sure that both “Sony Image Data Suite” and “PMB” are checked and follow the instructions on the screen.

- Connect the camera to the computer during the procedure following the instructions on the screen (page 164).
 - When the restarting confirmation message appears, restart the computer following the instructions on the screen.
 - DirectX may be installed depending on the system environment of your computer.
-

3 Remove the CD-ROM after the installation is complete.

The following software is installed and shortcut icons appear on the desktop.

“Image Data Converter SR”

“Image Data Lightbox SR”

“PMB”

“PMB Launcher”

“PMB Help”

Notes

- If “PMB” has already been installed on the computer, and the version number of the previously installed “PMB” is lower than that of the “PMB” on the CD-ROM (supplied), install “PMB” also from the CD-ROM (supplied).

- If “PMB” has already been installed on the computer, and the version of the previously installed “PMB” is higher than that of the “PMB” on the CD-ROM (supplied), installation is not required. The usable functions are activated when the camera is connected to the computer using the USB cable.
- If a version of “PMB” under 5.0.00 has been installed on your computer, you may be unable to use some functions of those “PMB” when installing the “PMB” from the supplied CD-ROM. Also, “PMB Launcher” is installed from the supplied CD-ROM and you can start “PMB” or other software by using the “PMB Launcher.” Double-click the “PMB Launcher” short-cut icon on the computer screen to start “PMB Launcher.”

Installing the software (Macintosh)

Log on as Administrator.

1 Turn on your Macintosh computer, and insert the CD-ROM (supplied) into the CD-ROM drive.

2 Double-click the CD-ROM icon.

3 Copy the [IDS_INST.pkg] file in the [MAC] folder to the hard disk icon.

4 Double-click the [IDS_INST.pkg] file in the copy-to folder.

Follow the instructions on the screen to complete the installation.

Using “Image Data Converter SR”

With “Image Data Converter SR” you can do the following, etc.:

- To edit images recorded in RAW format with various corrections, such as tone curve, and sharpness.
- To adjust images with white balance, exposure, and creative style, etc.
- To save the images displayed and edited on a computer.
- You can either save the image as RAW format or save it in the general file format.

To use “Image Data Converter SR,” refer to Help.

Click [Start] → [All Programs] → [Sony Image Data Suite] → [Help] → [Image Data Converter SR Ver.3].

“Image Data Converter SR” support page (English only)

<http://www.sony.co.jp/ids-se/>

Using “Image Data Lightbox SR”

With “Image Data Lightbox SR” you can do the following, etc.:

- To display and compare RAW/JPEG images recorded with this camera.
- To rate the images on a scale of five.
- To set color labels and so on.
- To display an image with “Image Data Converter SR” and make adjustments to it.

To use “Image Data Lightbox SR,” refer to Help.

Click [Start] → [All Programs] → [Sony Image Data Suite] → [Help] → [Image Data Lightbox SR].

“Image Data Lightbox SR” support page (English only)

<http://www.sony.co.jp/ids-se/>

Using “PMB”

With “PMB” you can do the following, etc.:

- To set images shot with the camera and display them on the computer.
- To organize images on the computer on a calendar by shooting date to view them.
- To retouch (red-eye reduction, etc.), print, and send still images as e-mail attachments, change the shooting date.
- To print or save still images with the date.
- To create Blu-ray discs, AVCHD format discs or DVD discs from AVCHD format movies imported to a computer. (An internet connection environment is required when a Blu-ray disc/DVD disc is created for the first time.)

Note

- “PMB” is not compatible with Macintosh computers.

To use “PMB,” refer to “PMB Help.”

Double-click the shortcut of  (PMB Help) on the desktop. Or, click [Start] → [All Programs] → [PMB] → [PMB Help].

“PMB” support page (English only)

<http://www.sony.co.jp/pmb-se/>

Connecting the camera to the computer

1 Insert a sufficiently charged battery pack into the camera, or connect the camera to a wall outlet (wall socket) using the AC-PW10AM AC Adaptor (sold separately).

2 Turn on the computer, then press the  (Playback) button.

3 Check that [USB Connection] in  1 is set to [Mass Storage].

4 Connect the camera to your computer.

- When a USB connection is established for the first time, your computer automatically runs a program to recognize the camera. Wait for a while.

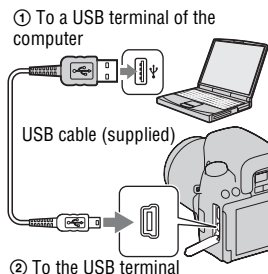

Importing images to the computer (Windows)

“PMB” allows you to easily import images.

For details on “PMB” functions, see the “PMB Help.”

Importing images to the computer without using “PMB”

When the AutoPlay Wizard appears after making a USB connection between the camera and a computer, click [Open folder to view files] → [OK] → [DCIM] or [MP_ROOT] → copy the desired images to the computer.

File name

Folder	The type of file	File name
DCIM folder	JPEG file	DSC0□□□□.JPG
	JPEG file (Adobe RGB)	_DSC□□□□.JPG
	RAW file	DSC0□□□□.ARW
	RAW file (Adobe RGB)	_DSC□□□□.ARW
MP_ROOT folder	MP4 file (1440 × 1080)	MAH0□□□□.MP4
	MP4 file (VGA)	MAQ0□□□□.MP4

- (file number) stands for any number within the range of 0001 to 9999.
- When [Image: Quality] is set to [RAW & JPEG], the numerical portions of the name of a RAW data file and its corresponding JPEG file are the same.

Notes

- For operations such as importing AVCHD movies to the computer, use “PMB.”
- When the camera is connected to the computer, if you operate AVCHD format movies or folders from the connected computer, images may be damaged or cannot be played. Do not delete or copy AVCHD format movies on the memory card from the computer. Sony is not held liable for consequences resulting from such operations via the computer.

Importing images to the computer (Macintosh)

1 Connect the camera to your Macintosh computer first. Double-click the newly recognized icon on the desktop → the folder where the images you want to import are stored.

2 Drag and drop the image files to the hard disk icon.

The image files are copied to the hard disk.

3 Double-click the hard disk icon → the desired image file in the folder containing the copied files.

The image is displayed.

Note

- Use “iMovie” bundled with a Macintosh computer to import or operate AVCHD format movies.

Deleting the USB connection

Perform the procedures from step 1 to 3 below before:

- Disconnecting the USB cable.
- Removing the memory card.
- Turning off the camera.

1 Double-click the disconnect icon on the taskbar.

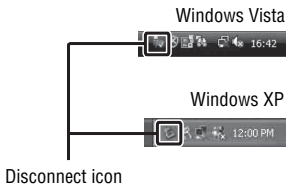

2 Click (USB Mass Storage Device) → [Stop].

3 Confirm the device on the confirmation window, then click [OK].

Note

- Drag and drop the icon of the memory card or the drive icon to the “Trash” icon beforehand when you use a Macintosh computer, and the camera is disconnected from the computer.

Creating a movie disc



You can create a disc from AVCHD format movies recorded on the camera.

Selecting the method for creating a disc

Select the method that best suits your disc player.

See “PMB Help” for details on creating a disc using “PMB.”

To import movies, see page 164.

Player	Method	Disc type
Blu-ray disc playback devices (Blu-ray disc player, PlayStation®3, etc.)	Create a Blu-ray disc of movies and photos imported to a computer using “PMB.”	Blu-ray 
AVCHD format playback devices (Sony Blu-ray disc player, PlayStation®3, etc.)	Create an AVCHD format disc of movies and photos imported to a computer using “PMB.”	AVCHD 
	Creating an AVCHD format disc with a DVD writer/recorder other than DVDirect Express.	
Ordinary DVD playback devices (DVD player, DVD playable computer, etc.)	Create a standard definition image quality (STD) disc of movies and photos imported to a computer using “PMB.”	STD 



Notes

- If you use a Sony DVDirect (DVD Writer), you can transfer data by inserting a memory card into the memory card slot of the DVD writer, or connecting your camera to the DVD writer with a USB cable.
- When you use Sony DVDirect (DVD writer), make sure that the version of DVD writer’s firmware is the latest.

For details, refer to the following URL:

<http://sony.storagesupport.com/>

Characteristics of each type of disc

A Blu-ray disc enables you to record high definition image quality (HD) movies of a longer duration than DVD discs.	
High definition image quality (HD) movie can be recorded on DVD media, such as DVD-R discs, and a high definition image quality (HD) disc is created. <ul style="list-style-type: none">You can play a high definition image quality (HD) disc on AVCHD format playback devices, such as a Sony Blu-ray disc player and a PlayStation®3. You cannot play the disc on ordinary DVD players.	
Standard definition image quality (STD) movie converted from high definition image quality (HD) movie can be recorded on DVD media, such as DVD-R discs, and a standard image quality (STD) disc is created.	

Discs you can use with “PMB”

You can use 12 cm discs of following type with “PMB.” For Blu-ray disc, see page 169.

Disc type	Features
DVD-R/DVD+R/DVD+R DL	Unrewritable
DVD-RW/DVD+RW	Rewritable

- Always maintain your PlayStation®3 to use the latest version of the PlayStation®3 system software.
- The PlayStation®3 may not be available in some countries/regions.

Creating an AVCHD format disc

You can create a high definition image quality (HD) AVCHD format disc from AVCHD format movies imported to a computer using the supplied software “PMB.”

1 Select the AVCHD format movies you want to write on “PMB.”

2 Click  (Create Discs) to select [Create AVCHD Format Discs (HD)].

The screen used for creating a disc appears.

- For details, see “PMB Help.”

Notes

- Install “PMB” beforehand.
- Still images and MP4 movie files cannot be recorded on the AVCHD format disc.
- It may take a long time to create a disc.

Playing AVCHD format disc on a computer

You can play back AVCHD format discs using “Player for AVCHD” that is installed together with “PMB.”

To start the software, click on [Start] → [All Programs] → [PMB] → [PMB Launcher] → [View] → [Player for AVCHD].

For detailed operations, see the Help for “Player for AVCHD.”

Note

- Movies may not be played smoothly depending on the computer environment.

Creating a Blu-ray disc

You can create a Blu-ray disc with AVCHD movies previously imported to a computer. Your computer must support the creation of Blu-ray discs. BD-R (non-rewritable) and BD-RE (rewritable) media can be used to create Blu-ray discs. You cannot add contents to either type of disc once it has been created.

Click [BD Add-on Software] on the installation screen of “PMB,” and install this plug-in according to the on-screen instructions.

Connect your computer to the Internet when you install [BD Add-on Software].

See “PMB Help” for details.

Creating a standard definition image quality (STD) disc

You can create a standard definition image quality (STD) disc from AVCHD format movies imported to a computer using supplied software “PMB.”

1 Select the AVCHD format movies you want to write on “PMB.”

2 Click (Create Discs) to select [Create DVD-Video Format Discs (STD)].

The screen used for creating a disc appears.

- For details, see “PMB Help.”

Notes

- Install “PMB” beforehand.
- MP4 movie files cannot be recorded on a disc.
- It will take a longer time to create a disc because AVCHD format movies are converted to standard definition image quality (STD) movies.
- An Internet connection environment is required when creating a DVD-Video (STD) disc for the first time.

Specifying DPOF

Using the camera, you can specify the still images and the number of images to print before you print images at a shop or with your printer. Follow the procedure below.

DPOF specifications are left with images after printing. It is recommended that you unspecify them after printing.

Specifying /unspecifying DPOF on selected images

1 MENU button →  1 → [Specify Printing] → [DPOF Setup] → [Multiple Img.]

2 Select the image with ◀/▶ on the controller.

3 Select the number of sheets with the center of the controller.

- To unspecify DPOF, set the number to “0.”
-

4 Press the MENU button.

5 Select [Enter] with ▲, then press the center of the controller.

Notes

- You cannot specify DPOF on RAW data files.
- You can specify any number up to 9.

Dating images

You can date images when printing them. The position of the date (inside or outside the image, character size, etc.) depends on your printer.

MENU button →  **1** → **[Specify Printing]** → **[Date Imprint]** → **[On]**

Note

- This function may not be provided, depending on the printer.

Specifications

Camera

[System]

Camera Type Interchangeable Lens
Digital Camera

Lens A-mount lens

[Image sensor]

Image format
DSLR-A580
23.5 mm×15.6 mm (APS-C format) “Exmor” CMOS image sensor
DSLR-A560
23.4 mm×15.6 mm (APS-C format) “Exmor” CMOS image sensor

Total pixel number of image sensor
DSLR-A580
Approx. 16 700 000 pixels
DSLR-A560
Approx. 14 600 000 pixels

Effective pixel number of camera
DSLR-A580
Approx. 16 200 000 pixels
DSLR-A560
Approx. 14 200 000 pixels

[SteadyShot]

System Image sensor-shift mechanism

Effect Approx. 2.5 EV to 4 EV in shutter speed (depending on shooting conditions and the attached lens)

[Anti-Dust]

System Charge protection coating on Low-Pass Filter and

image sensor-shift mechanism

[Auto focus system]

System TTL phase-detection system (Contrast AF method is selectable in focus check Live View mode)

Metering points
15 points (3 points cross type) (11 points in viewfinder mode)

Sensitivity Range
-1 EV to 18 EV (at ISO 100 equivalent)

AF illuminator
Approx. 1 m to 5 m
(3.3 feet to 16.4 feet)

[Live View]

Type Pentamirror tilt mechanism

Image format Exclusive image sensor for Live View

Frame coverage
Approx. 90%

[Viewfinder]

Type Fixed eye-level pentach-mirror

Frame coverage
Approx. 95%

Magnification
0.80 × with 50 mm lens at infinity, -1 m⁻¹ (diopter)

Eye Point Approximately 19 mm from the eyepiece, 15 mm from the eyepiece frame at -1 m⁻¹

Diopter Adjustment
-2.5 m⁻¹ to +1.0 m⁻¹

[Focus check Live View]

Image format
Image sensor for shooting

Frame coverage
Approx. 100%

[LCD monitor]

LCD panel 7.5 cm (3.0 type) TFT
drive

Total number of dots
921 600 (640 × 3 (RGB) ×
480) dots

[Exposure control]

Metering Cell

Live View
Exclusive image sensor for
Live View

Viewfinder
40-segment honeycomb-
pattern SPC

Focus check Live View
“Exmor” CMOS sensor

Metering method

**Live View/Focus check
Live View**
1200-zone evaluative
metering

Viewfinder
TTL shutter-open metering

Metering Range

Live View
1 EV to 17 EV on all
metering modes (ISO 100
equivalent with F1.4 lens)

Viewfinder
2 EV to 20 EV (4 EV to
20 EV on spot metering
mode) (ISO 100 equivalent
with F1.4 lens)

**Focus check Live View
DSLR-A580**
-2 EV to 17 EV on all
metering modes (ISO 100

equivalent with F1.4 lens)
DSLR-A560
-2 EV to 16 EV on all
metering modes (ISO 100
equivalent with F1.4 lens)

ISO sensitivity (Recommended
exposure index)
AUTO, ISO 100 to 12800

Exposure compensation
±2.0 EV (1/3 EV step)

[Shutter]

Type Electronically-controlled,
vertical-traverse, focal-
plane type

Speed range 1/4000 second to 30
seconds, bulb, (1/3 EV
step)

Flash sync speed
1/160 second

[Built-In-Flash]

Flash guide number
GN 12 (in meters at ISO
100)

Recycling time
Approx. 4 seconds

Flash coverage
Covering 18 mm lens
(focal length that the lens
indicates)

Flash compensation
±2.0 EV (1/3 EV step)

[Recording format]

File format JPEG (DCF Ver. 2.0, Exif Ver. 2.3, MPF Baseline) compliant, DPOF compatible

Movie (AVCHD format)
AVCHD Ver. 1.0 compliant
Video: MPEG-4 AVC/H.264
Audio: Dolby Digital 2ch, equipped with Dolby Digital Stereo Creator

- Manufactured under license from Dolby Laboratories.

Movie (MP4 format)
Video: MPEG-4 AVC/H.264
Audio: MPEG-4 AAC-LC 2ch

[Recording media]

“Memory Stick PRO Duo” media, SD card

[Input/output terminals]

USB miniB

HDMI HDMI type C minijack

MIC Terminal
Ø 3.5 mm Stereo minijack

REMOTE Terminal

[Power, general]

Used battery pack
Rechargeable battery pack
NP-FM500H

[Others]

Exif Print Compatible

PRINT Image Matching III
Compatible

Dimensions Approx. 137 mm × 104 mm × 84 mm (5 1/2 inches × 4 1/8 inches × 3 3/8 inches) (W/H/D, excluding protrusions)

Mass Approx. 679 g (1 lb 7.9 oz) (with battery and “Memory Stick PRO Duo” media)
Approx. 599 g (1 lb 5.1 oz) (body only)

Operating temperature
0°C to 40°C (32°F to 104°F)

USB communication
Hi-Speed USB (USB 2.0 compliant)

BC-VM10 Battery charger

Input rating 100 V - 240 V AC, 50/60 Hz, 9 W

Output rating
8.4 V DC, 0.75 A

Operating temperature range
0°C to 40°C (32°F to 104°F)

Storage temperature range
-20°C to +60°C (-4°F to +140°F)

Maximum dimensions
Approx. 70 mm × 25 mm × 95 mm (2 7/8 inches × 1 inches × 3 3/4 inches) (W/H/D)

Mass Approx. 90 g (3.2 oz)

Rechargeable battery pack NP-FM500H

Used battery

Lithium-ion battery

Maximum voltage

DC 8.4 V

Nominal voltage

DC 7.2 V

Maximum charge voltage

DC 8.4 V

Maximum charge current

2.0 A

Capacity

Typical 11.8 Wh (1 650 mAh)

Minimum 11.5 Wh (1 600 mAh)

Maximum dimensions

Approx. 38.2 mm ×
20.5 mm × 55.6 mm
(1 9/16 inches × 13/16
inches × 2 1/4 inches) (W/
H/D)

Mass

Approx. 78 g (2.8 oz)

Design and specifications are subject to change without notice.

On focal length

The picture angle of this camera is narrower than that of a 35 mm-format film camera. You can find the approximate equivalent of the focal length of a 35 mm-format film camera, and shoot with the same picture angle, by increasing the focal length of your lens by half.

For example, by using a 50 mm lens, you can get the approximate equivalent of a 75 mm lens of a 35 mm-format film camera.

On image data compatibility

- This camera conforms with DCF (Design rule for Camera File system) universal standard established by JEITA (Japan Electronics and Information Technology Industries Association).
- Playback of images recorded with your camera on other equipment and playback of images recorded or edited with other equipment on your camera are not guaranteed.

Trademarks

- **α** is a trademark of Sony Corporation.
- “Memory Stick,” , “Memory Stick PRO,” **MEMORY STICK PRO**, “Memory Stick Duo,” **MEMORY STICK DUO**, “Memory Stick PRO Duo,” **MEMORY STICK PRO DUO**, “Memory Stick PRO-HG Duo,” **MEMORY STICK PRO-HG DUO**, “Memory Stick Micro,” “MagicGate,” and **MAGICGATE** are trademarks of Sony Corporation.
- “InfoLITHIUM” is a trademark of Sony Corporation.
- “PhotoTV HD” is a trademark of Sony Corporation.
- “AVCHD” and “AVCHD” logotype are trademarks of Panasonic Corporation and Sony Corporation.
- “Blu-ray Disc” and the logo are trademarks.
- Dolby and the double-D symbol are trademarks of Dolby Laboratories.
- Microsoft, Windows, DirectX, and Windows Vista are either registered trademarks or trademarks of Microsoft Corporation in the United States and/or other countries.
- HDMI, the HDMI logo and High-Definition Multimedia Interface are trademarks or registered trademarks of HDMI Licensing LLC.
- Macintosh and Mac OS are trademarks or registered trademarks of Apple Inc.
- PowerPC is a registered trademark of IBM Corporation in the United States.
- Intel, Intel Core, MMX, and Pentium are trademarks or registered trademarks of Intel Corporation.
- SDXC, SDHC Logo are trademarks of SD-3C, LLC.
- Eye-Fi is a trademark of Eye-Fi Inc.
- MultiMediaCard is a trademark of MultiMediaCard Association.
- “PlayStation” is a registered trademark of Sony Computer Entertainment Inc.
- Adobe is a registered trademark or a trademark of Adobe Systems Incorporated in the United States and/or other countries.
- In addition, system and product names used in this manual are, in general, trademarks or registered trademarks of their respective developers or manufacturers. However, the TM or ® marks are not used in all cases in this manual.



Troubleshooting

If you experience trouble with your camera, try the following solutions. Check the items on pages 178 to 186. Consult your Sony dealer or local authorized Sony service facility.

❶ Check the following items.

❷ Remove the battery pack, and insert the battery pack again after about one minute, and turn on the power.

❸ Reset the settings (page 155).

❹ Consult your Sony dealer or local authorized Sony service facility.

Battery pack and power

The battery pack cannot be installed.

- As you insert the battery pack, use the tip of the battery pack to push the lock lever (page 22).
- You can use an NP-FM500H battery pack only. Make sure that the battery is NP-FM500H.

The remaining battery indicator is incorrect, or sufficient remaining battery indicator is displayed but the power runs out too quickly.

- This phenomenon occurs when you use the camera in an extremely hot or cold location (page 190).
- The battery pack is discharged. Install a charged battery pack (page 18).
- The battery pack is dead (page 24). Replace it with a new one.

Cannot turn on the camera.

- Install the battery pack correctly (page 22).
- The battery pack is discharged. Install a charged battery pack (page 18).
- The battery pack is dead (page 24). Replace it with a new one.

The power turns off suddenly.

- If you do not operate the camera for given period of time, the camera turns to power saving mode and nearly shuts down. To cancel the power save, operate the camera, such as pressing the shutter button halfway down (page 150).

The CHARGE lamp flashes when charging the battery pack.

- You can use an NP-FM500H battery pack only. Make sure that the battery is NP-FM500H.
- If you charge a battery pack that has not been used for a long time, the CHARGE lamp may flash.
- The CHARGE lamp flashes in two ways, fast (about 0.15-second intervals) and slow (about 1.5-second intervals). If it is flashing fast, remove the battery pack and reattach the same battery pack securely. If the CHARGE lamp flashes fast again, it suggests that there is something wrong with the battery pack. Slow flashing indicates that charging is suspended because the ambient temperature is outside the suitable range for charging the battery pack. Charging will resume and the CHARGE lamp will be lit when the ambient temperature returns to within the suitable temperature. Charge the battery pack under the suitable temperatures between 10°C and 30°C (50°F and 86°F).

Shooting images

Nothing is displayed on the LCD monitor in viewfinder mode when the power is turned on.

- If you do not operate the camera for given period of time, the camera turns to power saving mode and nearly shuts down. To cancel the power save, operate the camera, such as pressing the shutter button halfway down (page 150).

The image is not clear in the viewfinder.

- Adjust the diopter scale properly using the diopter-adjustment dial (page 40).

No images in the viewfinder.

- The LIVE VIEW/OVF switch is set to “LIVE VIEW.” Set it to “OVF” (page 40).

The screen of the viewfinder is dark.

- The battery pack is discharged. Install a charged battery pack (page 18).

A red light is reflected on the right side in the viewfinder

- When you press the shutter button halfway down to focus on a dark subject, AF areas may be lit in red automatically. In such a case, a red light is reflected on the right side in the viewfinder. This is not a malfunction.

The shutter does not release.

- You are using a memory card with a write-protect switch, and the switch is set to the LOCK position. Set the switch to the recording position.
- Check the free capacity of the memory card (page 35).
- You cannot record images while charging the built-in flash (page 98).
- The shutter cannot be released when the subject is out of focus.
- The lens is not attached properly. Attach the lens properly (page 25).
- When the camera is attached to another device, such as an astronomical telescope, set [Release w/oLens] to [Enable] (page 150).
- The subject may require special focusing (page 86). Use the focus-lock or manual focus function (pages 87, 90).

Recording takes a long time.

- The noise reduction function is turned on (page 148). This is not a malfunction.
- You are shooting in RAW mode (page 142). Since the RAW data file is large, the RAW mode shooting may take time.
- The Auto HDR is processing an image (page 109).

The same image is shot several times.

- The drive mode is set to [Continuous adv.] or [Bracket: Cont.]. Set it to [Single-shot Adv.] (page 118).

The image is out of focus.

- The subject is too close. Check the minimum focal distance of the lens.
- You are shooting in manual focus mode, set the focus mode switch to AF (autofocus) (page 85).
- When the focus mode switch is equipped with the lens, set it to AF.
- Ambient light is insufficient.

Eye-Start AF does not work.

- Set [Eye-Start AF] to [On] (page 41).
- Press the shutter button halfway down.

The flash does not work.

- The flash mode is set to [Autoflash]. If you want to make sure the flash fires without fail, set the flash mode to [Fill-flash] (page 98).

The flash takes too long to recharge.

- The flash has been fired in succession in a short period. When the flash has been fired in succession, the recharging process may take longer than usual to avoid overheating of the camera.

A picture taken with the flash is too dark.

- If the subject is beyond the flash range (the distance that the flash can reach), the pictures will be dark because the flash light does not reach the subject. If the ISO is changed, the flash range also changes with it (page 100).

The date and time are recorded incorrectly.

- Set the correct date and time (page 31).
- The area selected with [Area Setting] is different from the actual area. Set up [Area Setting] again (page 31).

The aperture value and/or shutter speed flashes when you press the shutter button halfway down.

- Since the subject is too bright or too dark, it is beyond the available range of the camera. Adjust the setting again.

The image is whitish (Flare).**Blurring of light appears on the image (Ghosting).**

- The picture was taken under a strong light source, and excessive light has entered the lens. Attach a lens hood (sold separately).

The corners of the picture are too dark.

- If any filter or hood is used, take it off and try shooting again. Depending on the thickness of the filter and improper attachment of the hood, the filter or the hood may partially appear in the image. The optical properties of some

lenses may cause the periphery of the image to appear too dark (insufficient light).

The eyes of the subject come out red.

- Activate the red eye reduction function (page 100).
- Get close to the subject, and shoot the subject within the flash range using the flash (page 100).

Dots appear and remain on the LCD monitor.

- This is not a malfunction. These dots are not recorded (page 7).
- You may reduce the effect of these issues using the “Pixel mapping” function.
 - ① Set the LIVE VIEW/OVF switch to “LIVE VIEW.”
 - ② Attach the lens cap.
 - ③ MENU button →  2 → [Pixel mapping] → [OK]

The image is blurred.

- The picture was taken in a dark location without the flash, resulting in camera shake. The use of a tripod or the flash is recommended (pages 60, 98).

The EV scale ◀ ▶ is flashing on the LCD monitor or in the viewfinder.

- The subject is too bright or too dark for the metering range of the camera.

The color of an image recorded in Live View mode is strange.

- In Live View mode, carefully check the image displayed on the LCD monitor before shooting. The camera may not be able to recognize the color of the image right after switching to the Live View mode. In such cases, the expected result may not be obtained.

Viewing images

Your camera cannot play back images.

- The folder/file name has been changed on your computer (page 164).
- When an image file has been processed by a computer or when the image file was recorded using a model other than that of your camera, playback on your camera is not guaranteed.
- Use “PMB” to play images stored on a PC with this camera.
- The camera is in USB mode. Delete the USB connection (page 166).

Deleting/Editing images

Your camera cannot delete an image.

- Cancel the protection (page 133).

You have deleted an image by mistake.

- Once you have deleted an image, you cannot restore it. We recommend that you protect images that you do not want to delete (page 133).

You cannot mark a DPOF mark.

- You cannot mark DPOF marks on RAW images.

Computers

You do not know if the OS of your computer is compatible with the camera.

- Check “Using with your computer” (page 158).

Your computer does not recognize your camera.

- Check that the camera is turned on.
- When the battery level is low, install the charged battery pack (page 18), or use the AC Adaptor (sold separately).
- Use the USB cable (supplied) (page 164).
- Disconnect the USB cable, and connect it again firmly.
- Set [USB Connection] to [Mass Storage] (page 164).
- Disconnect all equipment other than the camera, the keyboard and the mouse from the USB jacks of your computer.
- Connect the camera directly to your computer without passing through a USB hub or other device (page 164).

You cannot copy images.

- Make the USB connection by properly connecting the camera with your computer (page 164).
- Follow the designated copy procedure for your OS (page 164).
- When you shoot images with a memory card formatted by a computer, you may not be able to copy the images to a computer. Shoot using a memory card formatted by your camera (page 145).

The image cannot be played back on a computer.

- If you are using “PMB,” refer to the “PMB Help.”
- Consult the computer or software manufacturer.

After making a USB connection, “PMB” does not start automatically.

- Make the USB connection after the computer is turned on (page 164).

Memory card

Cannot insert a memory card.

- Insertion direction of the memory card is wrong. Insert it in the correct direction (page 27).

Cannot record on a memory card.

- The memory card is full. Delete unnecessary images (page 134).
- An unusable memory card is inserted (page 28).

You have formatted a memory card by mistake.

- All the data on the memory card are deleted by formatting. You cannot restore it.

Printing

Cannot print images.

- RAW images cannot be printed. To print RAW images first, convert them to JPEG images using “Image Data Converter SR” on the supplied CD-ROM.

The color of the image is strange.

- When you print the images recorded in Adobe RGB mode using sRGB printers that are not compatible with Adobe RGB (DCF2.0/Exif2.21), the images are printed at a lower intensity level (page 113).

Images are printed with both edges cut off.

- Depending on your printer, the left, right, top, and bottom edges of the image may be cut off. Especially when you print an image shot with the aspect ratio set to [16:9], the lateral end of the image may be cut off.

- When printing images using your own printer, cancel the trimming or borderless settings. Consult the printer manufacturer as to whether the printer provides these functions or not.
- When having images printed at a digital print shop, ask the shop whether they can print the images without cutting off both edges.

Cannot print images with the date.

- Using “PMB,” you can print images with date (page 162).
- This camera does not have a feature for superimposing dates on images. However, because the images shot with the camera include information on the recording date, you can print images with the date superimposed if the printer or the software can recognize Exif information. For compatibility with Exif information, consult the manufacturer of the printer or the software.
- When you print images at a shop, images can be printed with the date if you ask them to do so.

Others

The lens gets fogged.

- Moisture condensation has occurred. Turn off the camera and leave it for about an hour before using it (page 190).

The message “Set Area/Date/Time.” appears when you turn on the camera.

- The camera has been left unused for sometime with a low battery or no battery pack. Charge the battery pack and set the date again (pages 31, 190). If the date setting is lost every time the battery pack is charged, consult your Sony dealer or local authorized Sony service facility.

The number of recordable images does not decrease or decreases two at a time.

- This is because the compression rate and the image size after compression change depending on the image when you shoot a JPEG image (page 142).

The setting is reset without the resetting operation.

- The battery pack was removed when the power switch was set to ON. When removing the battery pack, make sure the camera is turned off and the access lamp is not lit (pages 15, 22).

The camera does not work properly.

- Turn off the camera. Remove the battery pack and insert it again. If the camera is hot, remove the battery pack, and allow it to cool down before trying this corrective procedure.
- If an AC Adaptor (sold separately) is used, disconnect the power plug. Connect the power plug and turn on the camera again. If the camera does not work after doing these solutions, consult your Sony dealer or local authorized Sony service facility.

The five bars of the SteadyShot scale located on the lower-right corner flashes.

- The SteadyShot function does not work. You can continue to shoot but the SteadyShot function will not work. Turn the camera off and on. If the SteadyShot scale continues to flash, consult your Sony dealer or local authorized Sony service facility.

“-E-” is indicated on the screen.

- Remove the memory card, and insert it again. If this procedure does not turn off the indication, format the memory card.

Warning messages

If the following messages appear, follow the instructions below.

Incompatible battery. Use correct model.

- An incompatible battery pack is being used.

Set Area/Date/Time.

- Set the area and date, time. If you have not used the camera for a long time, charge the internal rechargeable battery (pages 31, 190).

Power insufficient.

- You tried to perform [Cleaning Mode] when the battery level is insufficient. Charge the battery pack or use the AC Adaptor (sold separately).

Unable to use “Memory Stick.” Format?

Unable to use SD memory card. Format?

- The memory card was formatted on a computer and the file format was modified. Select [Enter], then format the memory card. You can use the memory card again, however, all previous data in the memory card is erased. It may take a some time to complete the format.

If the message still appears, change the memory card.

Memory Card Error

- An incompatible memory card is inserted or the format has failed.

Unable to read “Memory Stick” properly. Reinsert “Memory Stick.”

Unable to read SD memory card properly. Reinsert SD memory card.

- The inserted memory card cannot be used in your camera.
- The memory card is damaged.
- The terminal section of the memory card is dirty.

“Memory Stick” locked. SD memory card locked.

- You are using a memory card with a write-protect switch, and the switch is set to the LOCK position. Set the switch to the recording position.

The “Memory Stick” may not be capable of recording and playing normally.

- The inserted memory card cannot be used with the camera.

Processing...

- When Long exposure noise reduction will be done for the same amount of time that the shutter was open. You cannot do any further shooting during this reduction.

Unable to display.

- Images recorded with other cameras or images modified with a computer may not be able to be displayed.

Check the lens attachment. If the lens is not supported, you can permit use of the lens in the custom menu.

- The lens is not attached properly, or the lens is not attached.
- When attaching the camera to an astronomical telescope or something similar, set [Release w/oLens] to [Enable].

Contains no still images. Contains no movies.

- There is no image in the memory card.

Image protected.

- You tried to delete protected images.

Unable to print.

- You tried to mark RAW images with a DPOF mark.

Camera overheating. Allow it to cool.

- The camera has become hot because you have been shooting continuously.
Turn the power off. Cool the camera and wait until the camera is ready to shoot again.



- Because you have been recording for a long time, the temperature inside the camera has increased to an unacceptable level. Stop recording.

Recording is unavailable in this movie format.

- Set [Movie: File Format] to [MP4].



- The number of images exceeds that for which date management in a database file by the camera is possible.



- Unable to register to the database file. Import all the images to a computer using “PMB” and recover the memory card.

**Camera Error
System Error**

- Turn the power off, remove the battery pack, then re-insert it. If the message appears frequently, consult your Sony dealer or local authorized Sony service facility.

**Image Database File error.
Reboot.**

- There is something wrong occurred in the Image Database File. Execute [Recover Image DB] (page 146).

**Image Database File error.
Recover?**

- You cannot record or play back AVCHD format movies because the Image Database File is damaged. Follow the on-screen instructions to recover data.

**Unable to magnify.
Unable to rotate image.**

- Images recorded with other cameras may not be enlarged or rotated.

No images changed

- You attempted to specified DPOF without specifying images.

Cannot create more folders.

- The folder with a name beginning with “999” exists on the memory card. You cannot create any folders if this is the case.

Precautions

Do not use/store the camera in the following places

- In an extremely hot, dry or humid place
In places such as in a car parked in the sun, the camera body may become deformed and this may cause a malfunction.
- Storing under direct sunlight or near a heater
The camera body may become discolored or deformed, and this may cause a malfunction.
- In a location subject to rocking vibration
- Near strong magnetic place
- In sandy or dusty places
Be careful not to let sand or dust get into the camera. This may cause the camera to malfunction, and in some cases this malfunction cannot be repaired.

On storing

Be sure to attach the lens cap or body cap when not using the camera. When attaching the body cap, remove all the dust from the cap before placing it on the camera. When you purchase the DT 18 – 55 mm F3.5 – 5.6 SAM Lens Kit, purchase the Rear Lens Cap ALC-R55 also.

On operating temperatures

Your camera is designed for use under the temperatures between 0°C and 40°C (32°F and 104°F). Shooting in extremely cold or hot places that exceed this range is not recommended.

On moisture condensation

If the camera is brought directly from a cold to a warm location, moisture may condense inside or outside the camera. This moisture condensation may cause a malfunction of the camera.

How to prevent moisture condensation

When bringing the camera from a cold place to a warm place, seal the camera in a plastic bag and allow it to adapt to conditions at the new location over about an hour.

If moisture condensation occurs

Turn off the camera and wait about an hour for the moisture to evaporate. Note that if you attempt to shoot with moisture remaining inside the lens, you will be unable to record clear images.

On the internal rechargeable battery

This camera has an internal rechargeable battery for maintaining the date and time and other settings regardless of whether the power is on or off, or the battery pack is charged or discharged.

This rechargeable battery is continually charged as long as you are using the camera. However, if you use the camera for only short periods, it discharges gradually, and if you do not use the camera at all for about 3 months it becomes completely discharged. In this case, be sure to charge this rechargeable battery before using the camera.

However, even if this rechargeable battery is not charged, you can still use the camera as long as you do not record the date and time. If the camera resets the settings to the defaults each time you charge the battery, the internal rechargeable battery may be dead. Consult your Sony dealer or local authorized Sony service facility.

Charging method of the internal rechargeable battery

Insert a charged battery pack in the camera, or connect the camera to a wall outlet (wall socket) using the AC Adaptor (sold separately), and leave the camera for 24 hours or more with the power off.

On memory cards

Do not attach a label, etc. on a memory card or a card adaptor. This may cause a malfunction.

Notes on recording/playback

- When you use a memory card with this camera for the first time, it is recommended to format the card using the camera for stable performance of the memory card

before shooting. Note that formatting permanently erases all data on the memory card, and is unrecoverable. Save precious data on a computer, etc.

- If you repeatedly record/delete images, fragmentation of data may occur on the memory card. Movies may not be able to be saved or recorded. In such a case, save your images to a computer or other storage location, then format the memory card (page 145).
- Before you record one-time events, make a trial recording to make sure that the camera is working correctly.
- This camera is neither dust-proof, nor splash-proof, nor water-proof.
- Do not look at the sun or a strong light through a removed lens or the viewfinder. This may cause irrecoverable damage to your eyes. Or it may cause a malfunction of your camera.
- Do not use the camera near a location that generates strong radio waves or emits radiation. The camera may not be able to record or play back properly.
- Using the camera in sandy or dusty locations may cause malfunctions.
- If moisture condensation occurs, remove it before using the camera (page 190).
- Do not shake or strike the camera. In addition to malfunctions and an inability to record images, this may render the memory card unusable, or cause image data breakdown, damage or loss.

- Clean the flash surface before use.
The heat of flash emission may cause dirt on the flash surface to become discolored or to stick to the flash surface, resulting in insufficient light emission.
- Keep the camera, supplied accessories, etc., out of the reach of children. A memory card, etc., may be swallowed. If such a problem occurs, consult a doctor immediately.

AVCHD format

The AVCHD format is a high definition digital video camera format used to record a high definition (HD) signal of either the 1080i specification*¹ or the 720p specification*² using efficient data compression coding technology. The MPEG-4 AVC/H.264 format is adopted to compress video data, and the Dolby Digital or Linear PCM system is used to compress audio data.

The MPEG-4 AVC/H.264 format is capable of compressing images at higher efficiency than that of the conventional image compressing format. The MPEG-4 AVC/H.264 format enables a high definition video signal shot on a digital video camera recorder to be recorded on 8 cm DVD discs, hard disk drive, flash memory, memory card, etc.

Recording and playback on your camera

Based on the AVCHD format, your camera records with the high definition image quality (HD) mentioned below.

Video signal*³:

1080 60i-compatible device

MPEG-4 AVC/H.264 1920 ×
1080/60i

1080 50i-compatible device

MPEG-4 AVC/H.264 1920 ×
1080/50i

Audio signal: Dolby Digital 2ch

Recording media: Memory card

*1 1080i specification

A high definition specification which utilizes 1,080 effective scanning lines and the interlace system.

*2 720p specification

A high definition specification which utilizes 720 effective scanning lines and the progressive system.

*3 Data recorded in AVCHD format other than the above mentioned cannot be played on your camera.

3D-shootings

Notes on recording

- [3D Panorama] is not suitable when shooting:
 - Subjects are moving.
 - Subjects are too close to the camera.
 - Subjects with a repeating pattern such as tiles, and subjects with little contrast such as sky, sandy beach, or lawn.
- [3D Panorama] recording may be discontinued in the following situations:
 - You pan or tilt the camera too fast or too slow.
 - There is too much camera shake.
- If you cannot pan or tilt the camera across the entire subject within the given time, a black area occurs in the composed image. If this happens, move the camera fast to record a full panoramic image.
- Since several images are stitched together, the stitched part will not be recorded smoothly.
- Under low light conditions, images may be blurred.
- Under lights that flicker such as fluorescent light, images may not be recorded properly.
- When the whole angle of 3D panoramic shooting and the angle in which you fixed the focus and exposure with AE/AF lock are extremely different in brightness, color and focus, the shooting will not be successful. If this happens,

change the lock angle and shoot again.

- The available shooting direction is horizontal only.
- For details on the procedure used for shooting 3D-images, see page 69.

Note on playback of 3D-images

When you play back 3D-images on the LCD monitor of the camera or on a non-3D-compatible TV, the images are played back without the 3D effect.

Notes on 3D-image files

- A JPEG file and an MPO are combined to create a 3D-image. If you erase one of these files from the computer, the 3D-image may not be played back properly.
- For details on the procedure used for viewing 3D-images, see pages 128 and 137.

Index

Numerics

3D..... 69, 194

A

Adobe RGB..... 113

AE Lock..... 102

AEL button..... 149

AF area..... 89

AF illuminator..... 100

Ambient light..... 121

Amount of exposure..... 70

Anti-dust function..... 38

Aperture..... 70, 72

Aperture priority..... 72

Aperture value..... 72

Area Setting..... 32

Aspect ratio..... 142

Audio signals..... 150

Auto HDR..... 110

Auto review..... 152

Autoflash..... 98

Autofocus..... 85

Autofocus mode..... 88

AVCHD..... 193

B

Battery pack..... 18

Bracket..... 120

“BRAVIA” Sync..... 137

BULB shooting..... 79

C

Center weighted..... 107

Charging battery pack..... 18

Cleaning mode..... 38

Color filter..... 115

Color Space..... 113

Color temperature..... 115

Compression ratio..... 142

Continuous AF..... 88

Continuous bracket..... 120

Continuous shooting..... 118

Contrast..... 112

Contrast AF..... 91

Control dial..... 73

Controller..... 49

Creative Style..... 112

CTRL FOR HDMI..... 137

Custom white balance..... 116

D

Date imprint..... 172

Date/Time setup..... 31

DC IN terminal..... 17

Delete..... 134

Demo Mode..... 151

Depth of field..... 70

Digital level gauge..... 93

Diopeter-adjustment..... 40

Disc creation..... 167

DPOF setup..... 171

D-Range Optimizer109
Drive mode118

E

Enlarged image126
EV scale78, 103, 121
Exposure70
Exposure compensation103
Exposure mode70
Eye-Fi146
Eyepiece sensors41
Eye-Start AF41

F

Face Detection95
File Number144
Fill-flash98
Flash bracket120
Flash compensation105
Flash control106
Flash mode98
Flash Off61, 98
Flexible Spot89
Fn button49
Focal length176
Focus85
FOCUS CHECK LV91
Focus indicator86
Focus Magnifier93
Focus mode88
Focus-lock87
Folder Name144
Format145

G

Grid line 153

H

Hand-held Twilight 63
Help Guide disp. 150
High ISO NR 148
High-speed sync 99
Histogram 104

I

Image Index 127
Image quality 142
Image size 140
ISO sensitivity 108

J

JPEG 142

L

Landscape 63
Language 151
LCD brightness 152
LCD monitor 42, 129
Lens 25
Live View 7
Long exp.NR 148

M

Macro 63
Manual exposure 77
Manual focus 90
Manual shift 78

Memory card.....	27
“Memory Stick PRO Duo”	27
Menu	52
Metering mode.....	107
Moisture condensation.....	190
Movie Audio Rec.....	83
Movie File Format	82
Multi Frame Noise Reduct.....	108
Multi segment	107

N

New Folder	145
Night Portrait	63
Night View.....	63
Noise reduction	148
Number of recordable images	35, 36

P

Phase-detect AF.....	91
PlaybackDisplay	123
PMB	162
PMB Launcher.....	161
Portrait	63
Power Save	150
Preset white balance.....	114
Pressing halfway down	62
Preview	74
Print.....	171
Program auto.....	71
Protect	133

Q

Quality.....	142
--------------	-----

R

RAW	142
Rear sync.....	98
Recording movies	81
Recover Image DB.....	146
Red eye reduc.....	100
Reducing camera shake.....	58
Remote Commander	17, 122
Reset.....	155
Rotate	125

S

Saturation	112
Scene Selection	63
Select Folder	123
Select REC Folder.....	145
Self-timer	119
Set the clock.....	31
Sharpness	112
Shooting	61
Shoulder strap	33
Shutter speed.....	70, 75
Shutter speed priority.....	75
Single-shot AF	88
Slide show	127
Slow sync.....	98
Smile Shutter.....	96
Specifications	173
Sports Action.....	63

Spot.....	107
SteadyShot function.....	59
Sunset	63
Sweep Panorama	66, 141
Sweep Shooting	66

U

USB connection.....	164
---------------------	-----

V

Version	154
Viewing image.....	123
Viewing images on a TV screen	136

W

White balance	114
White balance bracket	122
Wireless flash	101
Wireless Remote Commander	122

Notes on the License

“C Library”, “Expat”, “zlib”, “dtoa”, “pcre”, and “libjpeg” software are provided in the camera. We provide this software based on license agreements with their owners of copyright. Based on requests by the owners of copyright of these software applications, we have an obligation to inform you of the following. Please read the following sections. Read “license1.pdf” in the “License” folder on the CD-ROM. You will find licenses (in English) of “C Library”, “Expat”, “zlib”, “dtoa”, “pcre” and “libjpeg” software.

THIS PRODUCT IS LICENSED UNDER THE AVC PATENT PORTFOLIO LICENSE FOR THE PERSONAL AND NON-COMMERCIAL USE OF A CONSUMER TO

- (i) ENCODE VIDEO IN COMPLIANCE WITH THE AVC STANDARD (“AVC VIDEO”) AND/OR
- (ii) DECODE AVC VIDEO THAT WAS ENCODED BY A CONSUMER ENGAGED IN A PERSONAL AND NON-COMMERCIAL ACTIVITY AND/OR WAS OBTAINED FROM A VIDEO PROVIDER LICENSED TO PROVIDE AVC VIDEO.

NO LICENSE IS GRANTED OR SHALL BE IMPLIED FOR ANY OTHER USE.

ADDITIONAL INFORMATION MAY BE OBTAINED FROM MPEG LA, L.L.C.

SEE

[HTTP://WWW.MPEGLA.COM](http://WWW.MPEGLA.COM)

On GNU GPL/LGPL applied software

The software that is eligible for the following GNU General Public License (hereinafter referred to as “GPL”) or GNU Lesser General Public License (hereinafter referred to as “LGPL”) are included in the camera.

This informs you that you have a right to have access to, modify, and redistribute source code for these software programs under the conditions of the supplied GPL/LGPL.

Source code is provided on the web. Use the following URL to download it.

<http://www.sony.net/Products/Linux/>
We would prefer you do not contact us about the contents of source code.

Read “license2.pdf” in the “License” folder on the CD-ROM. You will find licenses (in English) of “GPL”, and “LGPL” software.

To view the PDF, Adobe Reader is needed. If it is not installed on your computer, you can download it from the Adobe Systems web page: <http://www.adobe.com/>